

PROJECT: 36727.3.12

**STATE OF NORTH CAROLINA
DIVISION OF HIGHWAYS**

JOHNSTON COUNTY

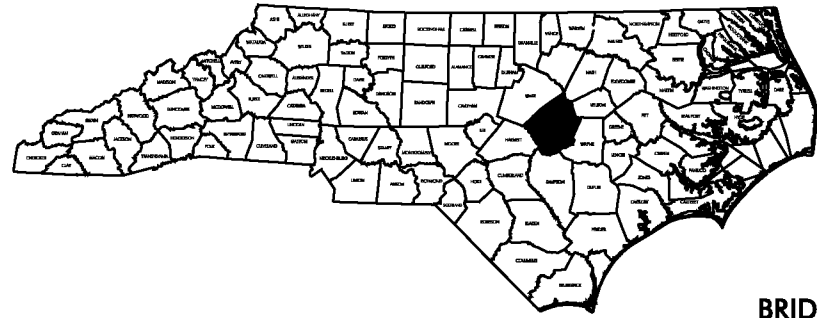

LOCATION: US 70 BUS, US701, SR1007, SR 1162,
SR 2137 AND SR 2339
TYPE OF WORK: CLEANING & PAINTING OF
BRIDGE #62, #66, #67, #105, #109, AND #112 IN JOHNSTON COUNTY.

STATE	STATE PROJECT REFERENCE NO.	SHEET NO.	TOTAL SHEETS
N.C.	36727.3.12	1	
STATE PROJECT NO.	S.A.P. ROAD NO.	DESCRIPTION	
36727.11		PE	
36727.3.12		CONSTR	

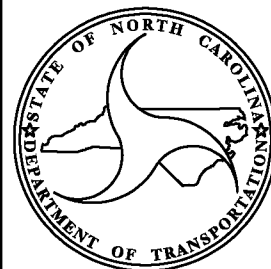
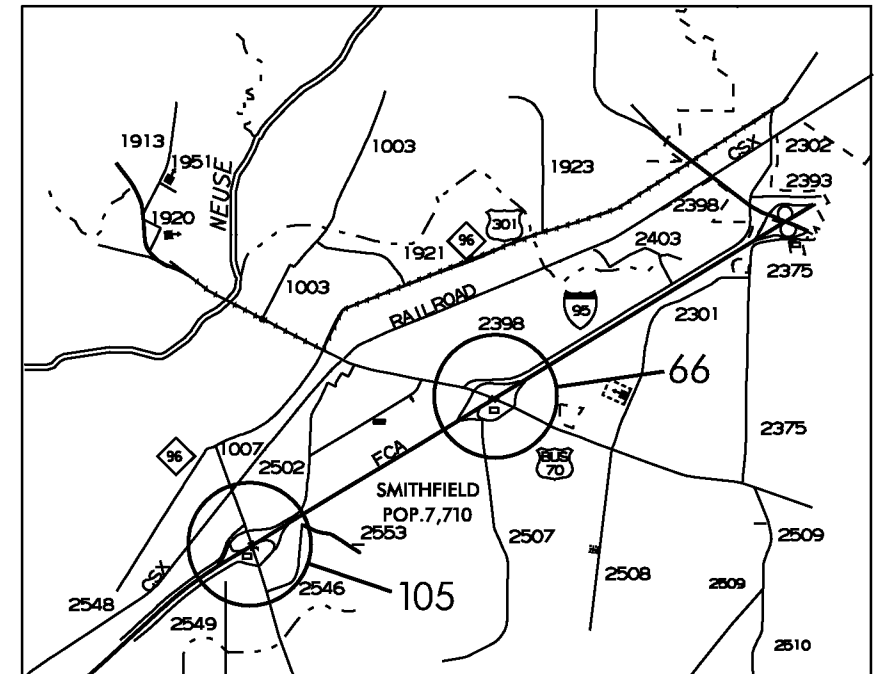
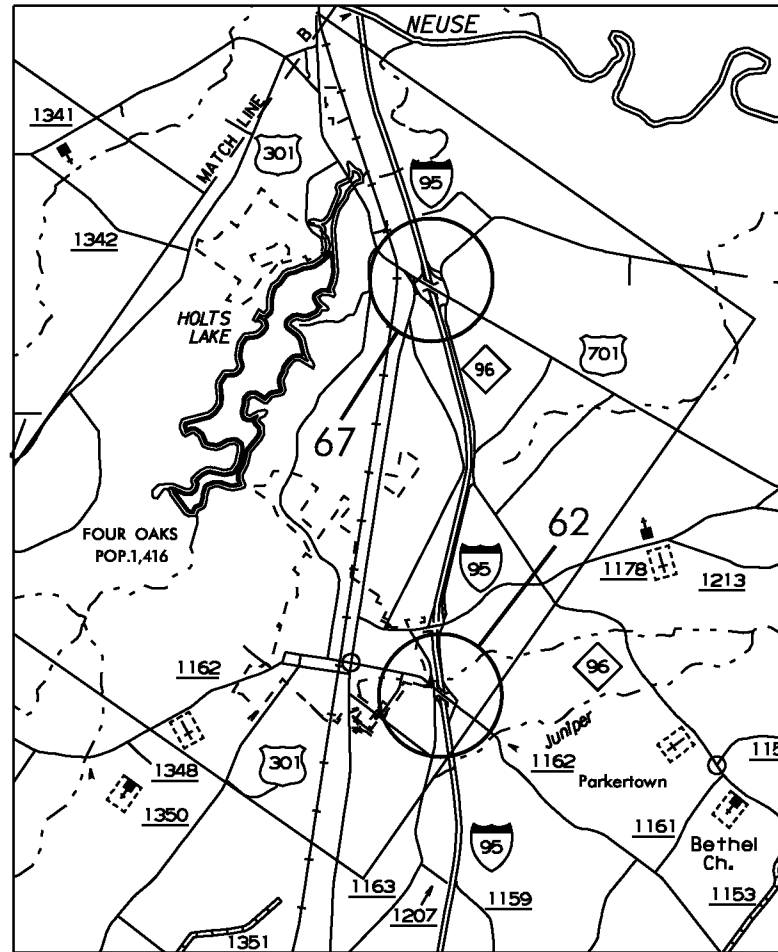
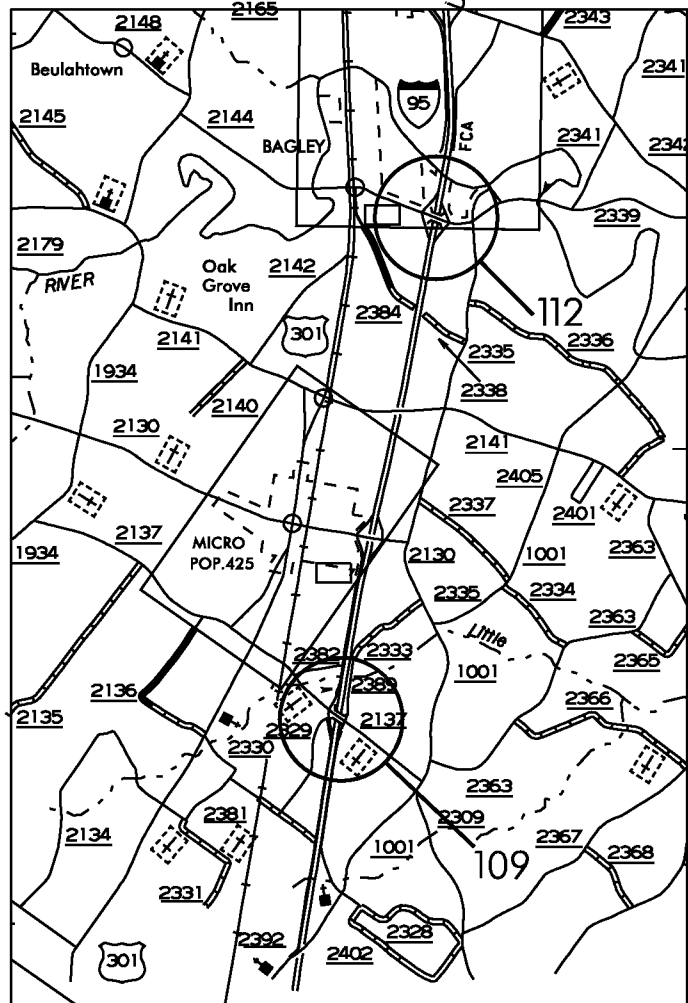

PROJECT LENGTH

LENGTH ROADWAY TIP PROJECT = 0.000 MILES

TOTAL LENGTH TIP PROJECT = 0.000 MILES

Prepared in the Office of:
BRIDGE MANAGEMENT UNIT
NORTH CAROLINA DEPARTMENT OF TRANSPORTATION

2006 STANDARD SPECIFICATIONS

LETTING DATE:
JULY 28, 2009

DAN HOLDERMAN, PE
STATE BRIDGE
MANAGEMENT ENGINEER

MIKE SUMMERS
BRIDGE MANAGEMENT
PROJECT MANAGER

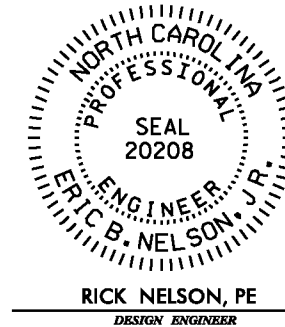

DATE PLOTTED

PLAN FOR PROPOSED TRAFFIC CONTROL, MARKING & DELINEATION

JOHNSTON COUNTY Painting of 6 bridges over I-95

ROADWAY STANDARD DRAWINGS

THE FOLLOWING ROADWAY STANDARDS AS APPEAR IN "ROADWAY STANDARD DRAWINGS" - PROJECT SERVICES UNIT-N.C. DEPARTMENT OF TRANSPORTATION-RALEIGH, N.C., DATED JULY 2006 ARE APPLICABLE TO THIS PROJECT AND BY REFERENCE HEREBY ARE CONSIDERED A PART OF THESE PLANS:

STD. NO.	TITLE
1101.11	TRAFFIC CONTROL DESIGN TABLES
1110.02	PORTABLE WORK ZONE SIGNS
1115.01	FLASHING ARROW PANELS
1130.01	DRUM
1145.01	BARRICADES
1165.01	TRUCK MOUNTED IMPACT ATTENUATOR

SHEET NO.	TITLE
TCP-1	LIST OF APPLICABLE ROADWAY STANDARD DRAWINGS, LEGEND, INDEX OF SHEETS, AND PHASING
TCP-2	GENERAL NOTES
TCP-3	LANE CLOSURES ALONG I-95
TCP-4	RIGHT LANE CLOSURES THROUGH ENTRANCE RAMP
TCP-5	RIGHT LANE CLOSURES THROUGH EXIT RAMP
TCP-6	RIGHT LANE CLOSURES THROUGH EXIT RAMP
TCP-7	SHOULDER CLOSURES
TCP-8	SIGN DETAIL

PHASING

- STEP 1. PERFORM PAINTING OPERATIONS AS SHOWN IN THE CONTRACT AND CONSTRUCTION PLANS. PERFORM WORK IN ACCORDANCE WITH THE "NCDOT STANDARD SPECIFICATIONS FOR ROADS AND STRUCTURES- JULY 2006" AND THE FOLLOWING TCP SHEETS AS REQUIRED.
- FOR BRIDGE NO. 62, USE TCP-3, TCP-4
FOR BRIDGE NO. 67, USE TCP-3, TCP-5, TCP-6
FOR BRIDGE NO. 105, USE TCP-3, TCP-6
FOR BRIDGE NO. 66, USE TCP-3, TCP-4, TCP-5
FOR BRIDGE NO. 109 AND 112, USE TCP-3, TCP-5
- USE TCP-7 AS NEEDED FOR SHOULDER CLOSURES.
- STEP 2. UPON COMPLETION OF THE PROJECT, REMOVE ALL TRAFFIC CONTROL DEVICES.

LEGEND



- GENERAL**
- DIRECTION OF TRAFFIC FLOW
 - NORTH ARROW
 - PROPOSED PVMT. EXIST. PVMT.
 - WORK AREA
 - REMOVAL OF EXISTING PAVEMENT
- TRAFFIC CONTROL DEVICES**
- TYPE I BARRICADE
 - TYPE II BARRICADE
 - TYPE III BARRICADE
 - CONE
 - DRUM SKINNY DRUM
 - FLASHING ARROW PANEL (TYPE C)
 - STATIONARY SIGN
 - PORTABLE SIGN
 - STATIONARY OR PORTABLE SIGN
 - CRASH CUSHION
 - CHANGEABLE MESSAGE SIGN
 - TRUCK MOUNTED IMPACT ATTENUATOR (TMIA)
 - POLICE
 - FLAGGER
- PAVEMENT MARKINGS**
- CRYSTAL/CRYSTAL PAVEMENT MARKER
 - YELLOW/YELLOW PAVEMENT MARKER
 - CRYSTAL/RED PAVEMENT MARKER
 - PAVEMENT MARKING SYMBOLS

PROJECT: WBS 36727.3.12

I:\1072008\117000725\Transportation\design\i-95 bridge package\i-95 bridge package_tcp_psh0.dgn
BWatson

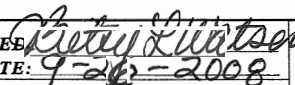

Stantec
Stantec Consulting Services Inc.
Suite 300, 801 Jones Franklin Road
Raleigh, NC
27606
Tel. 919.851.6866
Fax. 919.851.7024
www.stantec.com

APPROVED:  DATE: 9-26-2008	PLAN PREPARED BY:  Stantec Consulting Services Inc. Suite 300, 801 Jones Franklin Road Raleigh, NC 27606
SEAL 	BETSY L. WATSON, PE TRAFFIC CONTROL ENGINEER GEORGE KARAGEORGE TRAFFIC CONTROL DESIGNER

GENERAL NOTES

CHANGES MAY BE REQUIRED WHEN PHYSICAL DIMENSIONS IN THE DETAIL DRAWINGS, STANDARD DETAILS AND ROADWAY DETAILS ARE NOT ATTAINABLE TO MEET FIELD CONDITIONS, OR RESULT IN DUPLICATE, OR UNDESIRE OVERLAPPING OF DEVICES. MODIFICATION MAY INCLUDE: MOVING, SUPPLEMENTING, COVERING OR REMOVAL OF DEVICES, AS DIRECTED BY THE ENGINEER.

THE FOLLOWING GENERAL NOTES APPLY AT ALL TIMES FOR THE DURATION OF THE CONSTRUCTION PROJECT, EXCEPT WHEN OTHERWISE NOTED IN THE PLAN, OR DIRECTED BY THE ENGINEER.

TIME RESTRICTIONS

A) DO NOT CLOSE OR NARROW TRAVEL LANES AS FOLLOWS:

ROAD NAME	DAY AND TIME RESTRICTIONS
I-95	12:00 PM (NOON) FRIDAY THROUGH 11:59 PM SUNDAY

B) DO NOT CLOSE OR NARROW TRAVEL LANES DURING HOLIDAYS AND SPECIAL EVENTS AS FOLLOWS:

ROAD NAME	HOLIDAY
I-95	<ol style="list-style-type: none"> FOR ANY UNEXPECTED OCCURRENCE THAT CREATES UNUSUALLY HIGH TRAFFIC VOLUMES, AS DIRECTED BY THE ENGINEER. FOR NEW YEAR'S, BETWEEN THE HOURS OF 6:30 AM DECEMBER 31st TO 7:00 PM JANUARY 2ND. IF NEW YEAR'S DAY IS ON A FRIDAY, SATURDAY, SUNDAY, OR MONDAY THEN UNTIL 7:00 PM THE FOLLOWING TUESDAY. FOR EASTER, BETWEEN THE HOURS OF 6:30 AM THURSDAY AND 7:00 PM TUESDAY. FOR MEMORIAL DAY, BETWEEN THE HOURS OF 6:30 AM FRIDAY AND 7:00 PM WEDNESDAY. FOR INDEPENDENCE DAY, BETWEEN THE HOURS OF 6:30 AM THE FRIDAY BEFORE THE WEEK OF INDEPENDENCE DAY AND 7:00 PM THE FOLLOWING MONDAY AFTER THE WEEK OF INDEPENDENCE DAY. FOR LABOR DAY, BETWEEN THE HOURS OF 6:30 AM FRIDAY AND 7:00 PM WEDNESDAY. FOR THANKSGIVING DAY, BETWEEN THE HOURS OF 6:30 AM TUESDAY AND 7:00 PM MONDAY. FOR CHRISTMAS, BETWEEN THE HOURS OF 6:30 AM THE FRIDAY BEFORE THE WEEK OF CHRISTMAS DAY AND 7:00 PM THE FOLLOWING TUESDAY AFTER THE WEEK OF CHRISTMAS.

C) DO NOT STOP TRAFFIC OR CLOSE ROADS AS FOLLOWS:

ROAD NAME	DAY AND TIME RESTRICTIONS
I-95	ANY TIME

D) DO NOT CONDUCT ANY HAULING OPERATIONS AGAINST THE FLOW OF TRAFFIC OF AN OPEN TRAVELWAY UNLESS THE HAULING OPERATION IS PROTECTED BY BARRIER OR GUARDRAIL OR AS DIRECTED BY THE ENGINEER.

LANE AND SHOULDER CLOSURE REQUIREMENTS

- E) REMOVE LANE CLOSURE DEVICES FROM THE LANE WHEN WORK IS NOT BEING PERFORMED BEHIND THE LANE CLOSURE OR WHEN A LANE CLOSURE IS NO LONGER NEEDED, OR AS DIRECTED BY THE ENGINEER.
- F) WHEN PERSONNEL AND/OR EQUIPMENT ARE WORKING WITHIN 15 FT OF AN AN OPEN TRAVEL LANE, CLOSE THE NEAREST OPEN SHOULDER USING ROADWAY STANDARD DRAWING NO. 1101.04 UNLESS THE WORK AREA IS PROTECTED BY BARRIER OR GUARDRAIL OR A LANE CLOSURE IS INSTALLED.
- G) WHEN PERSONNEL AND/OR EQUIPMENT ARE WORKING ON THE SHOULDER ADJACENT TO AN UNDIVIDED FACILITY AND WITHIN 5 FT OF AN OPEN TRAVEL LANE, CLOSE THE NEAREST OPEN TRAVEL LANE USING ROADWAY STANDARD DRAWING NO. 1101.02 UNLESS THE WORK AREA IS PROTECTED BY BARRIER OR GUARDRAIL.

WHEN PERSONNEL AND/OR EQUIPMENT ARE WORKING ON THE SHOULDER ADJACENT TO A DIVIDED FACILITY AND WITHIN 10 FT OF AN OPEN TRAVEL LANE, CLOSE THE NEAREST OPEN TRAVEL LANE USING ROADWAY STANDARD DRAWING NO. 1101.02 UNLESS THE WORK AREA IS PROTECTED BY BARRIER OR GUARDRAIL.
- H) WHEN PERSONNEL AND/OR EQUIPMENT ARE WORKING WITHIN A LANE OF TRAVEL OF AN UNDIVIDED OR DIVIDED FACILITY, CLOSE THE LANE ACCORDING TO THE TRAFFIC CONTROL PLANS, ROADWAY STANDARD DRAWINGS OR AS DIRECTED BY THE ENGINEER. CONDUCT THE WORK SO THAT ALL PERSONNEL AND/OR EQUIPMENT REMAIN WITHIN THE CLOSED TRAVEL LANE.
- I) DO NOT WORK SIMULTANEOUSLY WITHIN 15 FT ON BOTH SIDES OF AN OPEN TRAVELWAY RAMP OR LOOP WITHIN THE SAME LOCATION UNLESS PROTECTED WITH GUARDRAIL OR BARRIER.
- J) PROVIDE A MINIMUM OF ONE MILE BETWEEN LANE CLOSURES, MEASURED FROM THE END OF ONE CLOSURE TO THE FIRST SIGN OF THE NEXT LANE CLOSURE.

TRAFFIC PATTERN ALTERATIONS

- K) NOTIFY THE ENGINEER TWENTY ONE (21) CALENDAR DAYS PRIOR TO ANY TRAFFIC PATTERN ALTERATION.

SIGNING

- L) ENSURE ALL NECESSARY SIGNING IS IN PLACE PRIOR TO ALTERING ANY TRAFFIC PATTERN.

TRAFFIC CONTROL DEVICES

- M) SPACE CHANNELIZING DEVICES IN WORK AREAS NO GREATER THAN TWICE THE POSTED SPEED LIMIT (MPH), EXCEPT 10 FT ON-CENTER IN RADIUS, AND 3 FT OFF THE EDGE OF AN OPEN TRAVELWAY, WHEN LANE CLOSURES ARE NOT IN EFFECT.
- N) PLACE ADDITIONAL SETS OF THREE DRUMS PERPENDICULAR TO THE EDGE OF TRAVELWAY ON 500 FT CENTERS WHEN UNOPENED LANES ARE CLOSED TO TRAFFIC.

MISCELLANEOUS

- O) POLICE MAY BE USED TO MAINTAIN TRAFFIC THROUGH THE WORK AREA AND/OR INTERSECTIONS, AS DIRECTED BY THE ENGINEER.
- P) COORDINATE WITH THE ENGINEER TO UTILIZE OVERHEAD DYNAMIC MESSAGE SIGNS, IF AVAILABLE, FOR ADVANCE WARNING TO MOTORIST OF: "ROAD WORK AHEAD AT MP XXX", "LEFT/ RIGHT LANE CLOSED AHEAD AT MP XXX".
- Q) INSTALL CHANGEABLE MESSAGE SIGNS IN ADVANCE OF THE PORTABLE WORK ZONE AS SHOWN ON THE TCP SHEETS OR AS DIRECTED BY THE ENGINEER.
- R) RETURN TRAFFIC TO ITS EXISTING TRAFFIC PATTERN AT THE END OF EACH WORK PERIOD.
- S) DO NOT PERFORM WORK FROM THE ROADWAY ON TOP OF THE STRUCTURE.
- T) UPON COMPLETION OF THE WORK AT EACH BRIDGE LOCATION, REMOVE ALL TRAFFIC CONTROL DEVICES.

I:\07\2008\bridge package\1-95 Bridge Package\TCP_psh02.dgn
 or:\action\del\1-95 Bridge Package\1-95 Bridge Package\TCP_psh02.dgn



Stantec Consulting Services Inc.
 Suite 300, 801 Jones Franklin Road
 Raleigh, NC
 27606
 Tel. 919.851.6000
 Fax. 919.851.1002
 www.stantec.com

SEAL				<h2>GENERAL NOTES</h2>	
SIGNATURE	DATE				
SCALE:	NONE			REVISIONS	
DATE:	SEP 2008				
DWG. BY:	BLW				
DESIGN BY:	BLW				
REVIEWED BY:	BLW				

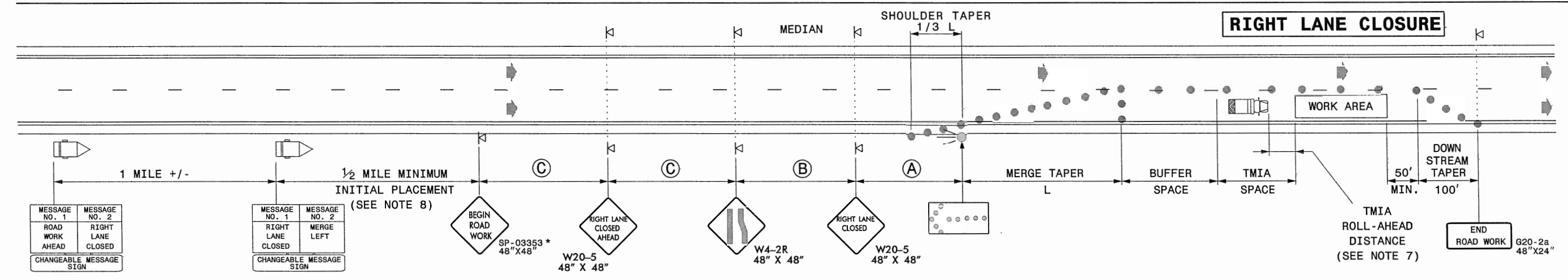
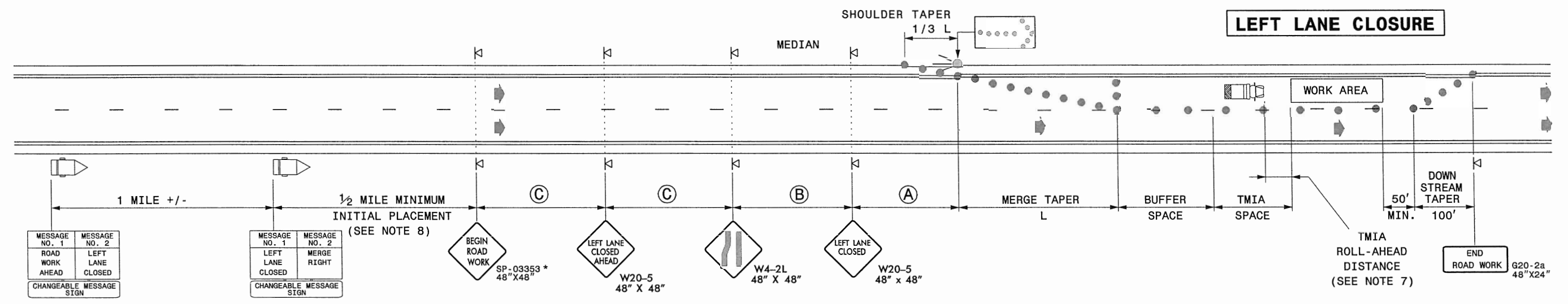

GENERAL NOTES

- 1- USE THIS DRAWING FOR LANE CLOSURES ALONG I-95 ASSOCIATED WITH ALL SIX BRIDGE LOCATIONS.
 - 2- PLACE ARROW PANELS ON THE SHOULDER (PAVED OR UNPAVED). PLACE ARROW PANELS WITHIN THE TAPER IF SHOULDERS DO NOT EXIST. MEET THE REQUIREMENTS FOR STOPPING SIGHT DISTANCE AT THE ARROW PANEL LOCATION. IF NEEDED, EXTEND LANE CLOSURES AT THE BUFFER SPACE, SUCH THAT STOPPING SIGHT DISTANCE TO THE ARROW PANEL IS MET. (SEE STD. 1101.11 SHEET 2)
 - 3- PLACE DRUMS IN TAPERS AT THE MAXIMUM SPACING EQUAL IN FEET TO THE POSTED SPEED LIMIT. PLACE DRUMS ALONG THE BUFFER SPACE AND WORK AREA AT THE MAXIMUM SPACING EQUAL IN FEET TO 2 TIMES THE POSTED SPEED LIMIT.
 - 4- REFER TO STD. 1101.11 SHEETS 1 & 4, FOR "L" DISTANCE AND SIGN SPACING.
 - 5- REFER TO SHEETS TCP-4, 5, AND 6 FOR TREATMENT OF LANE CLOSURES THROUGH INTERCHANGES.
 - 6- INSTALL LANE CLOSURES WITH THE TRAFFIC FLOW, BEGINNING WITH DEVICES ON THE UPSTREAM SIDE OF TRAFFIC. REMOVE LANE CLOSURES AGAINST THE TRAFFIC FLOW, BEGINNING WITH DEVICES ON THE DOWNSTREAM SIDE OF TRAFFIC.
 - 7- TMIA'S ARE REQUIRED ONLY WHEN A BUFFER SPACE CANNOT BE ATTAINED, OR WHEN DIRECTED BY THE ENGINEER OR THE PLANS. WHEN USED, POSITION THE TMIA TO MAINTAIN A ROLL-AHEAD DISTANCE AS RECOMMENDED BY THE MANUFACTURER.
 - 8- PLACE CHANGEABLE MESSAGE SIGN (CMS) ON THE OUTSIDE OF THE TRAVELWAY AS DIRECTED BY THE ENGINEER. PLACE CMS APPROXIMATELY 1/2 MILE IN ADVANCE OF THE W20-5 SIGNS. IF TRAFFIC BACKS UP TO WHERE THE CMS IS INITIALLY PLACED, RELOCATE CMS 1/2 MILE FROM ANTICIPATED BACKUP. CONTINUE TO MONITOR TRAFFIC AND MOVE CMS APPROXIMATELY 1/2 MILE IN CONJUNCTION WITH ANTICIPATED BACKUP.
- * SEE SHEET TCP-8 FOR SIGN DETAIL.

LEGEND

	FLASHING ARROW PANEL (TYPE C)
	TRUCK MOUNTED IMPACT ATTENUATOR(TMIA)
	CHANGEABLE MESSAGE SIGN (CMS)
	DRUM
	PORTABLE SIGN
	DIRECTION OF TRAFFIC FLOW

Stantec
 Stantec Consulting Services Inc.
 Suite 300, 801 Jones Franklin Road
 Raleigh, NC
 27606
 Tel. 919.851.6866
 Fax. 919.851.7024
 www.stantec.com

SEAL

Patsy M. Johnson
 09-26-08

SIGNATURE _____ DATE _____

TEMPORARY LANE CLOSURES ON I-95

SCALE: NONE		REVISIONS
DATE: SEP 2008		
DWG. BY: BLW		
DESIGN BY: BLW		
REVIEWED BY: BLW		

CADD FILE: I-95 Bridge Package TCP psh03.dgn

I:\07\2008\I-95 Bridge Package\I-95 Bridge Package.TCP.psh03.dgn
 or-tation\desig\I-95 Bridge Package\I-95 Bridge Package.TCP.psh03.dgn

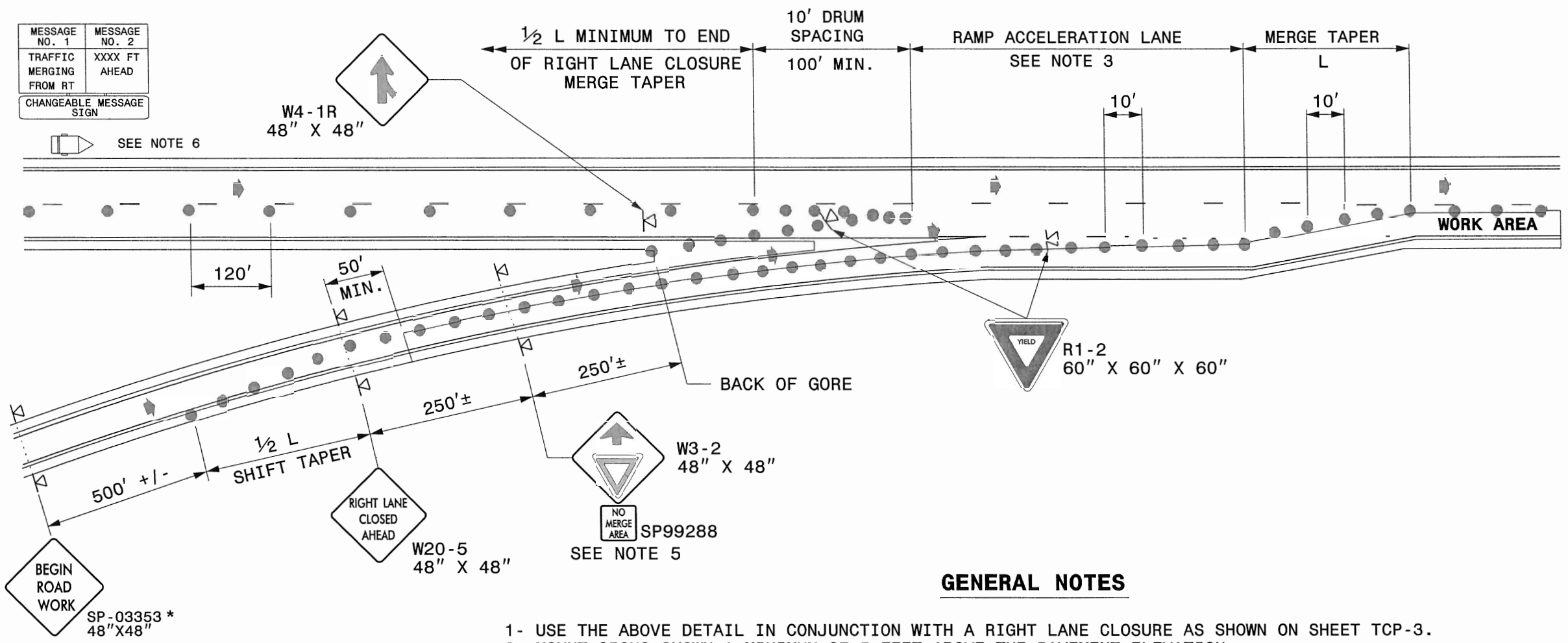

GENERAL NOTES

- 1- USE THE ABOVE DETAIL IN CONJUNCTION WITH A RIGHT LANE CLOSURE AS SHOWN ON SHEET TCP-3.
- 2- MOUNT SIGNS SHOWN A MINIMUM OF 5 FEET ABOVE THE PAVEMENT ELEVATION.
- 3- IF EXISTING ACCELERATION DISTANCE OR A MINIMUM OF 400' ACCELERATION DISTANCE CANNOT BE PROVIDED, CONTACT THE WORK ZONE TRAFFIC CONTROL UNIT FOR FURTHER GUIDANCE.
- 4- CLOSE THE RIGHT LANE SUFFICIENTLY IN ADVANCE TO STABILIZE MOTOR VEHICLE TRAFFIC FLOW BEFORE THE MERGE AS SHOWN ON SHEET TCP-3.
- 5- INSTALL SP99288 BELOW THE YIELD AHEAD SIGN (AS SHOWN) TO ALERT MOTORISTS THAT THE ACCELERATION DISTANCE HAS BEEN REDUCED.
- 6- COORDINATE WITH THE ENGINEER FOR LOCATION OF CMS.
- 7- USE THE ABOVE DETAIL ALONG I-95 FOR THE FOLLOWING SITUATIONS:

BRIDGE NO. 62, SB ON-RAMP FROM KEEN ROAD
BRIDGE NO. 66, NB ENTRANCE LOOP

* SEE SHEET TCP-8 FOR SIGN DETAIL.

LEGEND	
	CHANGEABLE MESSAGE SIGN (CMS)
	DRUM
	PORTABLE SIGN
	DIRECTION OF TRAFFIC FLOW

Stantec Consulting Services Inc.
Suite 300, 801 Jones Franklin Road
Raleigh, NC 27606
Tel. 919.851.5866
Fax 919.851.7024
www.stantec.com

SEAL <i>Betsy L. Watson</i> SIGNATURE	DATE 9-26-08	RIGHT LANE CLOSURES THROUGH ENTRANCE RAMP	
		SCALE: NONE	REVISIONS
		DATE: SEP 2008	
		DWG. BY: BLW	
DESIGN BY: BLW			
REVIEWED BY: BLW			

I:\10\2008\bridge package\1-95 Bridge Package\TCP_psh04.dgn

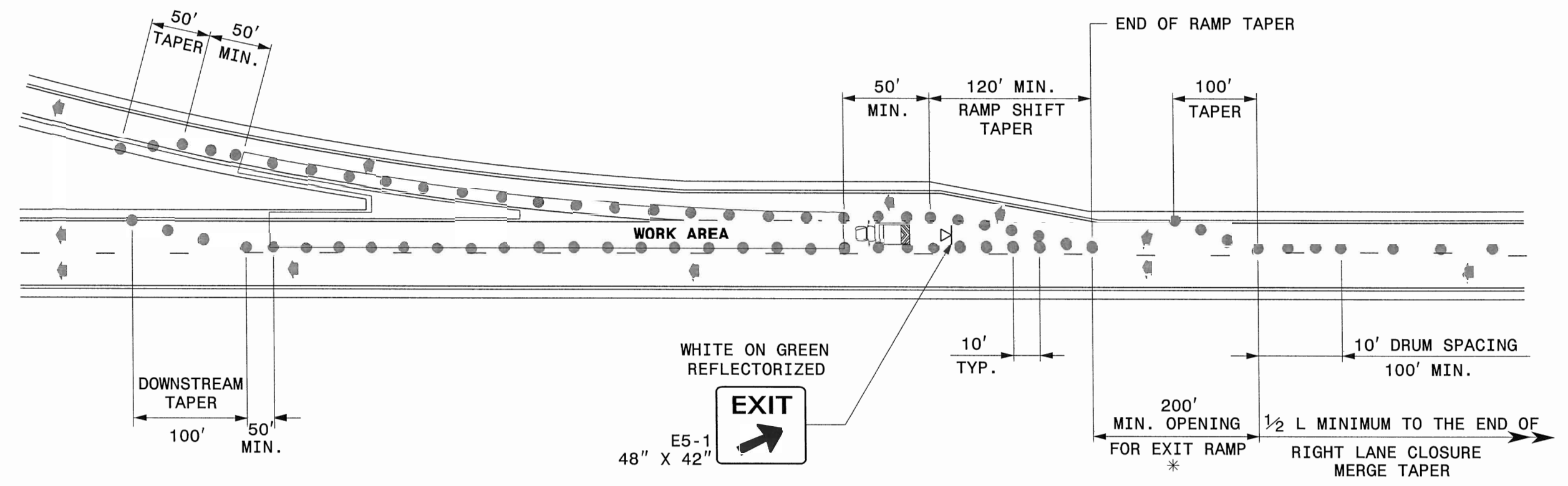

GENERAL NOTES

- 1-USE THE ABOVE DETAILS IN CONJUNCTION WITH A RIGHT LANE CLOSURE AS SHOWN ON SHEET TCP-3.
- 2-MOUNT EXIT SIGNS A MINIMUM OF 7 FEET ABOVE THE PAVEMENT ELEVATION.
- 3-USE THE ABOVE DETAIL FOR LANE CLOSURES ALONG I-95 FOR THE FOLLOWING SITUATIONS:
 BRIDGE NO. 67: NB OFF-RAMP
 BRIDGE NO. 66, 109, AND 112: NB AND SB OFF-RAMPS

LEGEND

- TRUCK MOUNTED IMPACT ATTENUATOR
- DRUM
- PORTABLE SIGN
- DIRECTION OF TRAFFIC FLOW

*** NOTE:**

USE EXISTING RAMP OPENING LENGTH WHERE POSSIBLE. USE NO LESS THAN 1/2 ORIGINAL LENGTH.

IF 1/2 ORIGINAL LENGTH CANNOT BE OBTAINED, CONTACT THE WORK ZONE TRAFFIC CONTROL UNIT FOR FURTHER GUIDANCE.

Stantec Consulting Services Inc.
 Suite 300, 801 Jones Franklin Road
 Raleigh, NC 27606
 Tel. 919.851.6866
 Fax. 919.851.7024
 www.stantec.com

SEAL 	RIGHT LANE CLOSURES THROUGH EXIT RAMPS							
	SCALE: NONE DATE: SEP 2008 DWG. BY: BLW DESIGN BY: BLW REVIEWED BY: BLW	REVISIONS <table border="1"> <tr><td> </td><td> </td></tr> <tr><td> </td><td> </td></tr> <tr><td> </td><td> </td></tr> </table>						
SIGNATURE: <i>Patsy L. Watson</i> DATE: 9-26-08								

I:\072008\bridge package\1-95 Bridge Package-TCP-psa05.dgn

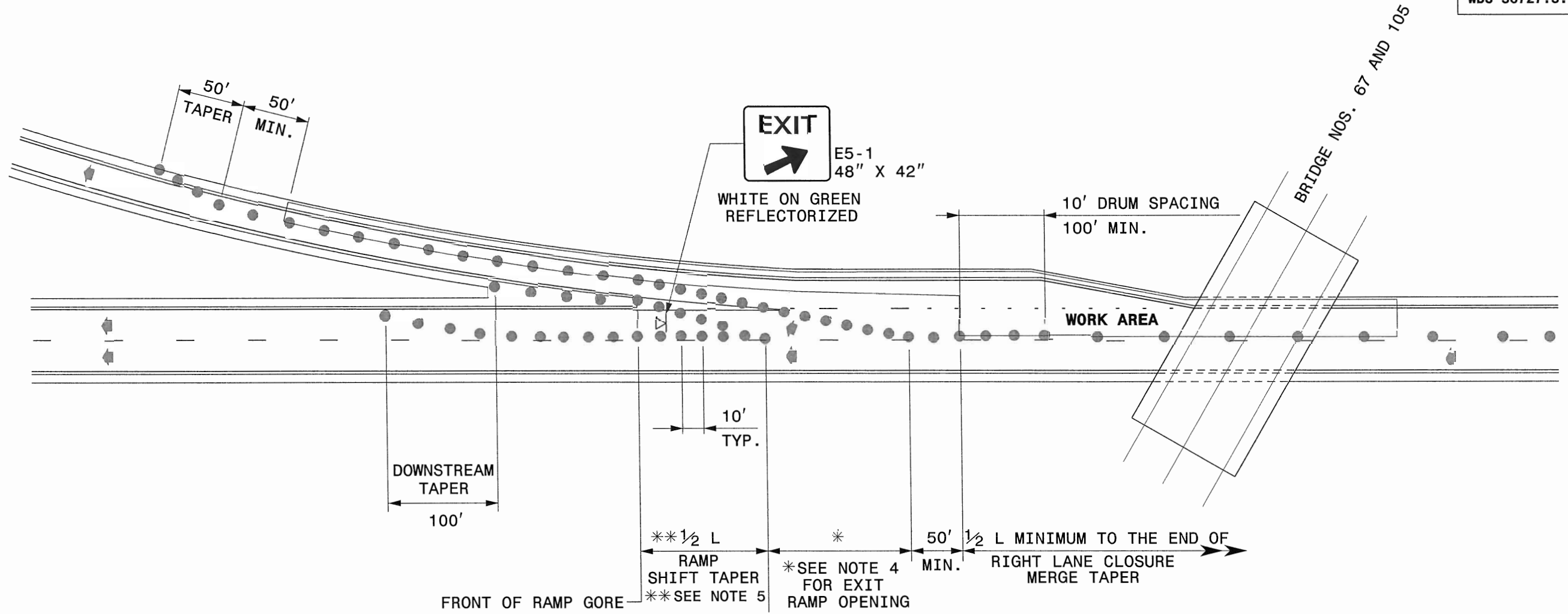

GENERAL NOTES

- 1-USE THE ABOVE DETAILS IN CONJUNCTION WITH A RIGHT LANE CLOSURE AS SHOWN ON SHEET TCP-3.
- 2-MOUNT EXIT SIGNS A MINIMUM OF 7 FEET ABOVE THE PAVEMENT ELEVATION.
- 3-USE THE ABOVE DETAIL FOR LANE CLOSURES ALONG I-95 FOR THE FOLLOWING SITUATIONS:

BRIDGE NO. 67: SB EXIT LOOP
 BRIDGE NO. 105: NB AND SB EXIT LOOPS

- * 4- USE EXISTING RAMP OPENING LENGTH WHERE POSSIBLE. USE NO LESS THAN 1/2 ORIGINAL LENGTH. IF 1/2 ORIGINAL LENGTH CANNOT BE OBTAINED, CONTACT THE WORK ZONE TRAFFIC CONTROL UNIT FOR FURTHER GUIDANCE.
- ** 5- IF 1/2L CANNOT BE OBTAINED FOR THE RAMP SHIFT TAPER, CONTACT THE WORK ZONE TRAFFIC CONTROL UNIT FOR FURTHER GUIDANCE.

LEGEND	
	TRUCK MOUNTED IMPACT ATTENUATOR
	DRUM
	PORTABLE SIGN
	DIRECTION OF TRAFFIC FLOW



Stantec Consulting Services Inc.
 Suite 300, 801 Jones Franklin Road
 Raleigh, NC 27606
 Tel. 919.851.6866
 Fax. 919.851.7024
 www.stantec.com

SEAL <i>Betsy L. Watson</i> 9-26-08 SIGNATURE	DATE	SCALE: NONE	RIGHT LANE CLOSURES THROUGH EXIT RAMPS REVISIONS
	DATE: SEP 2008	DWG. BY: BLW	
	DESIGN BY: BLW	REVIEWED BY: BLW	
	DATE	REVIEWED BY: BLW	

I:\107208\bridge package\I-95 Bridge Package_TCP_psh06.dgn
 or-tation\des\107208\bridge package\I-95 Bridge Package_TCP_psh06.dgn

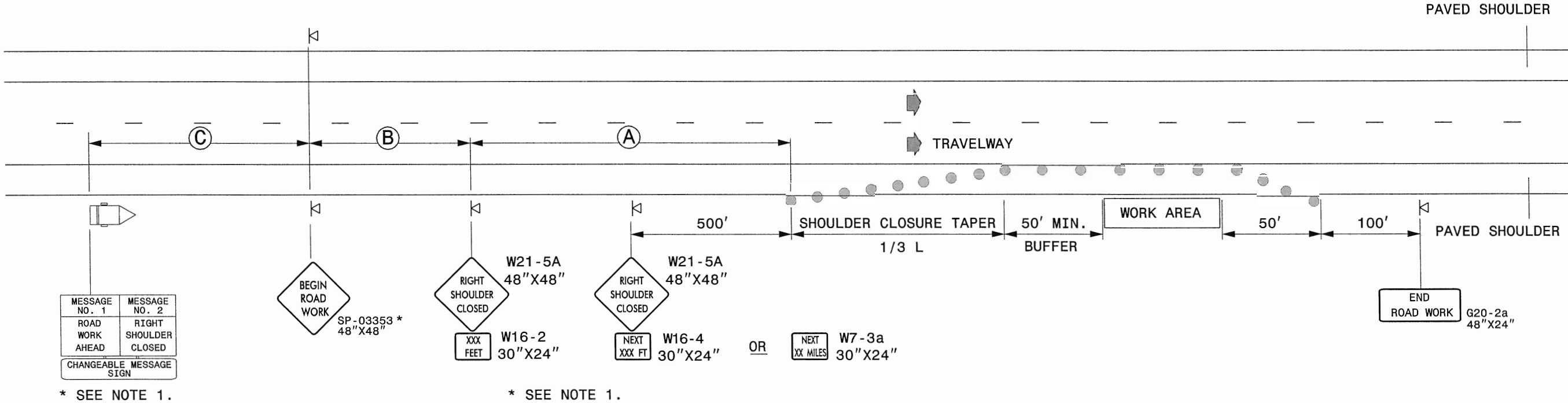

GENERAL NOTES

- 1- PLACE SHOULDER CLOSURE SIGNS ON THE SAME SIDE AS THE SHOULDER THAT IS CLOSED. FOR CLOSURES ON THE MEDIAN SIDE OF THE ROADWAY, SUBSTITUTE THE WORD "LEFT" FOR THE WORD "RIGHT" IN THE CHANGEABLE MESSAGE SIGN AND ON SIGNS W21-5A.
 - 2- PLACE DRUMS IN THE SHOULDER TAPER AT THE MAXIMUM SPACING EQUAL IN FEET TO THE POSTED SPEED LIMIT. THE MAXIMUM SPACING OF DRUMS ALONG THE WORK AREA IS EQUAL IN FEET TO 2 TIMES THE POSTED SPEED LIMIT.
 - 3- REFER TO STD. 1101.11 SHEETS 1, 3, & 4, FOR "L" DISTANCE, AND SIGN SPACING.
 - 4- DO NOT CLOSE THE SHOULDERS ON THE RIGHT SIDE AND MEDIAN SIDE OF THE ROADWAY AT THE SAME TIME.
 - 5- USE THIS DETAIL AS NEEDED FOR SHOULDER CLOSURES ALONG I-95, FOR ALL SIX BRIDGE LOCATIONS.
- * SEE SHEET TCP-8 FOR SIGN DETAIL.

LEGEND	
	DRUM
	STATIONARY OR PORTABLE SIGN
	DIRECTION OF TRAFFIC FLOW

Stantec Consulting Services Inc.
Suite 300, 801 Jones Franklin Road
Raleigh, NC 27606
Tel. 919.851.6866
Fax. 919.851.7024
www.stantec.com

	TEMPORARY SHOULDER CLOSURES ALONG I-95	
	SCALE: NONE	REVISIONS
	DATE: SEP 2008	
	DWG. BY: BLW	
DESIGN BY: BLW		
REVIEWED BY: BLW		
SIGNATURE: <i>Betsy L. Wilson</i>	DATE: 9-26-08	

I:\10\2008\or-lection\design\1-95 bridge package\1-95 Bridge Package\TCP_psh07.dgn

SP 03353

SIGN NUMBER: SP-03353 TYPE: A QUANTITY: 1 SIGN WIDTH: 4'-0" HEIGHT: 4'-0" TOTAL AREA: 16.0 Sq.Ft. BORDER TYPE: FLUSH RECESS: 0.59" WIDTH: 0.75" RADII: 1.38" NO. Z BARS: N/A LENGTH: N/A	BACKG COLOR: Fluorescent Orange COPY COLOR: Black <table border="1"> <tr> <th>SYMBOL</th> <th>X</th> <th>Y</th> <th>WID</th> <th>HT</th> </tr> <tr><td> </td><td> </td><td> </td><td> </td><td> </td></tr> <tr><td> </td><td> </td><td> </td><td> </td><td> </td></tr> <tr><td> </td><td> </td><td> </td><td> </td><td> </td></tr> <tr><td> </td><td> </td><td> </td><td> </td><td> </td></tr> <tr><td> </td><td> </td><td> </td><td> </td><td> </td></tr> <tr><td> </td><td> </td><td> </td><td> </td><td> </td></tr> <tr><td> </td><td> </td><td> </td><td> </td><td> </td></tr> <tr><td> </td><td> </td><td> </td><td> </td><td> </td></tr> <tr><td> </td><td> </td><td> </td><td> </td><td> </td></tr> <tr><td> </td><td> </td><td> </td><td> </td><td> </td></tr> </table> MAT'L:	SYMBOL	X	Y	WID	HT																																																			DESIGNER: J. DOWNEY CHECKED BY: CHECKED PROJECT ID: ALL PROJECTS DIV: DIV STD #: W20-1 DATE: Aug 20, 2003
SYMBOL	X	Y	WID	HT																																																					

USE NOTES: 2, 4
 1. Legend and border shall be direct applied Type VII reflective sheeting.
 2. Legend and border shall be direct applied non-reflective sheeting.
 3. Shields shall be Type VII reflective sheeting on 0.032" (0.8mm) aluminum and demountable.
 4. Background shall be Type VII reflective sheeting.
 5. Background shall be Type I reflective sheeting.
 6. Center arrow(s) vertically on sign.
 7. Bottom panel shall be yellow Type III sheeting. Legend shall be direct applied black non-reflective sheeting. Yellow panel is:

LETTER POSITIONS

Letter spacings are to start of next letter

	B	E	G	I	N														Series/Size
																			Text Length
	22.4	5.3	4.6	5.4	2.5	3.8	22.4												C7
																			21.6
																			C7
	23.4	5	5.2	5.6	3.8	23.4													19.6
																			C7
	22.6	6.4	5.6	5.2	4	22.6													21.2

Spacing Factor is 1 unless specified otherwise

I:\10\2008\bridge package\1-95 Bridge Package\TCP_pst\08.dgn
 11/10/2008 11:28:08 AM
 B. Watson



SEAL

Betsy L. Watson
 9-26-08

SIGNATURE DATE

SPECIAL SIGN DETAIL

SCALE:	NONE		REVISIONS
DATE:	SEP 2008		
DWG. BY:	BLW		
DESIGN BY:	BLW		
REVIEWED BY:	-BLW		

CADD FILE: I:\10\2008\bridge package\TCP_pst\08.dgn