

STATE OF NORTH CAROLINA  
DEPARTMENT OF TRANSPORTATION  
RALEIGH, N.C.

C204648

CONTRACT AND  
CONTRACT BONDS

FOR CONTRACT NO. C204648

WBS 45861.3.1 STBG-0111(025)

T.I.P NO. U-5942

COUNTY OF PASQUOTANK  
THIS IS THE SIGNAL CONTRACT  
ROUTE NUMBER \_\_\_\_\_ LENGTH 20.000 MILES  
LOCATION ELIZABETH CITY SIGNAL SYSTEM.

CONTRACTOR ALS OF NORTH CAROLINA LLC  
ADDRESS 502 KLUMAC RD  
SALISBURY, NC 28144

BIDS OPENED JUNE 15, 2021  
CONTRACT EXECUTION 7/13/2021

STATE OF NORTH CAROLINA  
DEPARTMENT OF TRANSPORTATION  
RALEIGH, N.C.

PROPOSAL

DATE AND TIME OF BID OPENING: **JUNE 15, 2021 AT 2:00 PM**

CONTRACT ID C204648

WBS 45861.3.1

FEDERAL-AID NO. STBG-0111(025)

COUNTY PASQUOTANK

T.I.P. NO. U-5942

MILES 20.000

ROUTE NO.

LOCATION ELIZABETH CITY SIGNAL SYSTEM.

TYPE OF WORK SIGNALS.

**NOTICE:**

ALL BIDDERS SHALL COMPLY WITH ALL APPLICABLE LAWS REGULATING THE PRACTICE OF GENERAL CONTRACTING AS CONTAINED IN CHAPTER 87 OF THE GENERAL STATUTES OF NORTH CAROLINA WHICH REQUIRES THE BIDDER TO BE LICENSED BY THE N.C. LICENSING BOARD FOR CONTRACTORS WHEN BIDDING ON ANY NON-FEDERAL AID PROJECT WHERE THE BID IS \$30,000 OR MORE, EXCEPT FOR CERTAIN SPECIALTY WORK AS DETERMINED BY THE LICENSING BOARD. BIDDERS SHALL ALSO COMPLY WITH ALL OTHER APPLICABLE LAWS REGULATING THE PRACTICES OF ELECTRICAL, PLUMBING, HEATING AND AIR CONDITIONING AND REFRIGERATION CONTRACTING AS CONTAINED IN CHAPTER 87 OF THE GENERAL STATUTES OF NORTH CAROLINA. NOTWITHSTANDING THESE LIMITATIONS ON BIDDING, THE BIDDER WHO IS AWARDED ANY FEDERAL - AID FUNDED PROJECT SHALL COMPLY WITH CHAPTER 87 OF THE GENERAL STATUTES OF NORTH CAROLINA FOR LICENSING REQUIREMENTS WITHIN 60 CALENDAR DAYS OF BID OPENING.

**BIDS WILL BE RECEIVED AS SHOWN BELOW:**

**THIS IS A SIGNAL PROPOSAL**

**5% BID BOND OR BID DEPOSIT REQUIRED**

---

**PROPOSAL FOR THE CONSTRUCTION OF  
CONTRACT No. C204648 IN PASQUOTANK COUNTY, NORTH CAROLINA**

Date \_\_\_\_\_ 20 \_\_\_\_\_

**DEPARTMENT OF TRANSPORTATION,  
RALEIGH, NORTH CAROLINA**

The Bidder has carefully examined the location of the proposed work to be known as Contract No. **C204648** has carefully examined the plans and specifications, which are acknowledged to be part of the proposal, the special provisions, the proposal, the form of contract, and the forms of contract payment bond and contract performance bond; and thoroughly understands the stipulations, requirements and provisions. The undersigned bidder agrees to bound upon his execution of the bid and subsequent award to him by the Board of Transportation in accordance with this proposal to provide the necessary contract payment bond and contract performance bond within fourteen days after the written notice of award is received by him. The undersigned Bidder further agrees to provide all necessary machinery, tools, labor, and other means of construction; and to do all the work and to furnish all materials, except as otherwise noted, necessary to perform and complete the said contract in accordance with *the 2018 Standard Specifications for Roads and Structures* by the dates(s) specified in the Project Special Provisions and in accordance with the requirements of the Engineer, and at the unit or lump sum prices, as the case may be, for the various items given on the sheets contained herein.

The Bidder shall provide and furnish all the materials, machinery, implements, appliances and tools, and perform the work and required labor to construct and complete State Highway Contract No. **C204648** in **Pasquotank County**, for the unit or lump sum prices, as the case may be, bid by the Bidder in his bid and according to the proposal, plans, and specifications prepared by said Department, which proposal, plans, and specifications show the details covering this project, and hereby become a part of this contract.

The published volume entitled *North Carolina Department of Transportation, Raleigh, Standard Specifications for Roads and Structures, January 2018* with all amendments and supplements thereto, is by reference incorporated into and made a part of this contract; that, except as herein modified, all the construction and work included in this contract is to be done in accordance with the specifications contained in said volume, and amendments and supplements thereto, under the direction of the Engineer.

If the proposal is accepted and the award is made, the contract is valid only when signed either by the Contract Officer or such other person as may be designated by the Secretary to sign for the Department of Transportation. The conditions and provisions herein cannot be changed except over the signature of the said Contract Officer.

The quantities shown in the itemized proposal for the project are considered to be approximate only and are given as the basis for comparison of bids. The Department of Transportation may increase or decrease the quantity of any item or portion of the work as may be deemed necessary or expedient.

An increase or decrease in the quantity of an item will not be regarded as sufficient ground for an increase or decrease in the unit prices, nor in the time allowed for the completion of the work, except as provided for the contract.

Accompanying this bid is a bid bond secured by a corporate surety, or certified check payable to the order of the Department of Transportation, for five percent of the total bid price, which deposit is to be forfeited as liquidated damages in case this bid is accepted and the Bidder shall fail to provide the required payment and performance bonds with the Department of Transportation, under the condition of this proposal, within 14 calendar days after the written notice of award is received by him, as provided in the *Standard Specifications*; otherwise said deposit will be returned to the Bidder.



*State Contract Officer*

DocuSigned by:

*Ronald E. Davenport, Jr.*

F81B6038A47A442...

5/13/2021

**TABLE OF CONTENTS**

**COVER SHEET**  
**PROPOSAL SHEET**

**PROJECT SPECIAL PROVISIONS**

CONTRACT TIME AND LIQUIDATED DAMAGES: ..... G-1  
INTERMEDIATE CONTRACT TIME NUMBER 1 AND LIQUIDATED DAMAGES: ..... G-1  
INTERMEDIATE CONTRACT TIME NUMBER 2 AND LIQUIDATED DAMAGES: ..... G-2  
CONSTRUCTION MORATORIUM: ..... G-3  
MAJOR CONTRACT ITEMS: ..... G-3  
SPECIALTY ITEMS: ..... G-3  
SCHEDULE OF ESTIMATED COMPLETION PROGRESS: ..... G-3  
DISADVANTAGED BUSINESS ENTERPRISE: ..... G-4  
CERTIFICATION FOR FEDERAL-AID CONTRACTS: ..... G-17  
CONTRACTOR'S LICENSE REQUIREMENTS: ..... G-18  
RESTRICTIONS ON ITS EQUIPMENT AND SERVICES: ..... G-18  
USE OF UNMANNED AIRCRAFT SYSTEM (UAS): ..... G-18  
EQUIPMENT IDLING GUIDELINES: ..... G-19  
U.S. DEPARTMENT OF TRANSPORTATION HOTLINE: ..... G-19  
CARGO PREFERENCE ACT: ..... G-20  
ELECTRONIC BIDDING: ..... G-20

ROADWAY ..... R-1

**STANDARD SPECIAL PROVISIONS**

AVAILABILITY FUNDS – TERMINATION OF CONTRACTS ..... SSP-1  
ERRATA ..... SSP-2  
PLANT AND PEST QUARANTINES ..... SSP-3  
TITLE VI AND NONDISCRIMINATION ..... SSP-4  
MINORITY AND FEMALE EMPLOYMENT REQUIREMENTS ..... SSP-12  
REQUIRED CONTRACT PROVISIONS FEDERAL-AID CONST. CONTRACTS ..... SSP-15  
ON-THE-JOB TRAINING ..... SSP-24  
MINIMUM WAGES ..... SSP-27

**UNIT PROJECT SPECIAL PROVISIONS**

ITS ..... ITS-1

**PERMITS** ..... P-1

**PROPOSAL ITEM SHEET**

ITEM SHEET(S) (TAN SHEETS)

**PROJECT SPECIAL PROVISIONS****GENERAL****CONTRACT TIME AND LIQUIDATED DAMAGES:**

(7-20-99) (Rev. 12-18-07)

108

SP1 G04

The date of availability for this contract is **July 26, 2021**, except that work in jurisdictional waters and wetlands shall not begin until a meeting between the DOT, Regulatory Agencies, and the Contractor is held as stipulated in the permits contained elsewhere in this proposal. This delay in availability has been considered in determining the contract time for this project.

The completion date for this contract is **December 5, 2022**.

Except where otherwise provided by the contract, observation periods required by the contract will not be a part of the work to be completed by the completion date and/or intermediate contract times stated in the contract. The acceptable completion of the observation periods that extend beyond the final completion date shall be a part of the work covered by the performance and payment bonds.

The liquidated damages for this contract are **One Thousand One Hundred Dollars (\$ 1,100.00)** per calendar day.

**INTERMEDIATE CONTRACT TIME NUMBER 1 AND LIQUIDATED DAMAGES:**

(2-20-07)

108

SP1 G14 A

The Contractor shall complete the required work of installing, maintaining, and removing the traffic control devices for lane closures and restoring traffic to the existing traffic pattern. The Contractor shall not close or narrow a lane of traffic on **US 17, US 17 BUS, and NC 344** during the following time restrictions:

**DAY AND TIME RESTRICTIONS**

**Monday through Friday**  
**6:00 AM to 9:00 AM**  
**4:00 PM to 6:00 PM**

In addition, the Contractor shall not close or narrow a lane of traffic **US 17, US 17 BUS, and NC 344**, detain and/or alter the traffic flow on or during holidays, holiday weekends, special events, or any other time when traffic is unusually heavy, including the following schedules:

**HOLIDAY AND HOLIDAY WEEKEND LANE CLOSURE RESTRICTIONS**

1. For **unexpected occurrence** that creates unusually high traffic volumes, as directed by the Engineer.
2. For **New Year's Day**, between the hours of **6:00 AM** December 31<sup>st</sup> and **6:00 PM** January 2<sup>nd</sup>. If New Year's Day is on a Friday, Saturday, Sunday or Monday, then until **6:00 PM** the following Tuesday.

3. For **Easter**, between the hours of **6:00 AM** Thursday and **6:00 PM** Monday.
4. For **Memorial Day**, between the hours of **6:00 AM** Friday and **6:00 PM** Tuesday.
5. For **Independence Day**, between the hours of **6:00 AM** the day before Independence Day and **6:00 PM** the day after Independence Day.

If **Independence Day** is on a Friday, Saturday, Sunday or Monday, then between the hours of **6:00 AM** the Thursday before Independence Day and **6:00 PM** the Tuesday after Independence Day.

6. For **Labor Day**, between the hours of **6:00 AM** Friday and **6:00 PM** Tuesday.
7. For **Thanksgiving**, between the hours of **6:00 AM** Tuesday and **6:00 PM** Monday.
8. For **Christmas**, between the hours of **6:00 AM** the Friday before the week of Christmas Day and **6:00 PM** the following Tuesday after the week of Christmas Day.

Holidays and holiday weekends shall include New Year's, Easter, Memorial Day, Independence Day, Labor Day, Thanksgiving, and Christmas. The Contractor shall schedule his work so that lane closures will not be required during these periods, unless otherwise directed by the Engineer.

The time of availability for this intermediate contract work shall be the time the Contractor begins to install all traffic control devices for lane closures according to the time restrictions listed herein.

The completion time for this intermediate contract work shall be the time the Contractor is required to complete the removal of all traffic control devices for lane closures according to the time restrictions stated above and place traffic in the existing traffic pattern.

The liquidated damages are **Two Hundred Fifty Dollars (\$250.00)** per **fifteen (15)** minute time period.

#### **INTERMEDIATE CONTRACT TIME NUMBER 2 AND LIQUIDATED DAMAGES:**

(2-20-07) (Rev. 10-15-13)

108

SP1 G14 E

The Contractor shall complete the required work of installing, maintaining and removing the traffic control devices for road closures and restoring traffic to the existing traffic pattern. The Contractor shall not close **US 17, US 17 BUS, and/or NC 344** during the following time restrictions:

#### **DAY AND TIME RESTRICTIONS**

**Monday through Friday**  
**6:00 AM to 9:00 AM**  
**4:00 PM to 6:00 PM**

The maximum allowable time for installing cable across the road is **twenty (20)** minutes for **US 17, US 17 BUS, and/or NC 344**. The Contractor shall reopen the travel lanes to traffic until any resulting traffic queue is depleted.

The time of availability for this intermediate contract time will be the time the Contractor begins to install traffic control devices required for the road closures according to the time restrictions stated herein.

The completion time for this intermediate contract time will be the time the Contractor is required to complete the removal of traffic control devices required for the road closures according to the time restrictions stated herein and restore traffic to the existing traffic pattern.

The liquidated damages are **Five Hundred Dollars (\$ 500.00)** per **twenty (20)** minute time period.

**CONSTRUCTION MORATORIUM:**

(7-15-14)

SP1 G18B

No in-water work will be allowed from **February 15** through **June 30** of any year.

**MAJOR CONTRACT ITEMS:**

(2-19-02)

104

SP1 G28

The following listed items are the major contract items for this contract (see Article 104-5 of the *2018 Standard Specifications*):

<b>Line #</b>	<b>Description</b>
33 —	Directional Drill (2,2")
44 —	Communications Cable (48- Fiber)
63 —	Controller w/Cabinet w/Aux File (2070LX, 332)

**SPECIALTY ITEMS:**

(7-1-95)(Rev. 1-17-12)

108-6

SP1 G37

Items listed below will be the specialty items for this contract (see Article 108-6 of the *2018 Standard Specifications*).

<b>Line #</b>	<b>Description</b>
17-19, 23	Long-Life Pavement Markings

**SCHEDULE OF ESTIMATED COMPLETION PROGRESS:**

(7-15-08) (Rev. 5-13-19)

108-2

SP1 G58

The Contractor's attention is directed to the Standard Special Provision entitled *Availability of Funds Termination of Contracts* included elsewhere in this proposal. The Department of Transportation's schedule of estimated completion progress for this project as required by that Standard Special Provision is as follows:

<b><u>Fiscal Year</u></b>	<b><u>Progress (% of Dollar Value)</u></b>
2022	(7/01/21 - 6/30/22) <b>79%</b> of Total Amount Bid
2023	(7/01/22 - 6/30/23) <b>21%</b> of Total Amount Bid

The Contractor shall also furnish his own progress schedule in accordance with Article 108-2 of the *2018 Standard Specifications*. Any acceleration of the progress as shown by the Contractor's progress schedule over the progress as shown above shall be subject to the approval of the Engineer.

**DISADVANTAGED BUSINESS ENTERPRISE:**

(10-16-07)(Rev. 12-17-19)

102-15(J)

SP1 G61

**Description**

The purpose of this Special Provision is to carry out the U.S. Department of Transportation's policy of ensuring nondiscrimination in the award and administration of contracts financed in whole or in part with Federal funds. This provision is guided by 49 CFR Part 26.

**Definitions**

*Additional DBE Subcontractors* - Any DBE submitted at the time of bid that will not be used to meet the DBE goal. No submittal of a Letter of Intent is required.

*Committed DBE Subcontractor* - Any DBE submitted at the time of bid that is being used to meet the DBE goal by submission of a Letter of Intent. Or any DBE used as a replacement for a previously committed DBE firm.

*Contract Goal Requirement* - The approved DBE participation at time of award, but not greater than the advertised contract goal.

*DBE Goal* - A portion of the total contract, expressed as a percentage, that is to be performed by committed DBE subcontractor(s).

*Disadvantaged Business Enterprise (DBE)* - A firm certified as a Disadvantaged Business Enterprise through the North Carolina Unified Certification Program.

*Goal Confirmation Letter* - Written documentation from the Department to the bidder confirming the Contractor's approved, committed DBE participation along with a listing of the committed DBE firms.

*Manufacturer* - A firm that operates or maintains a factory or establishment that produces on the premises, the materials or supplies obtained by the Contractor.

*Regular Dealer* - A firm that owns, operates, or maintains a store, warehouse, or other establishment in which the materials or supplies required for the performance of the contract are bought, kept in stock, and regularly sold to the public in the usual course of business. A regular dealer engages in, as its principal business and in its own name, the purchase and sale or lease of the products in question. A regular dealer in such bulk items as steel, cement, gravel, stone, and petroleum products need not keep such products in stock, if it owns and operates distribution equipment for the products. Brokers and packagers are not regarded as manufacturers or regular dealers within the meaning of this section.



*Replacement / Substitution* – A full or partial reduction in the amount of work subcontracted to a committed (or an approved substitute) DBE firm.

*North Carolina Unified Certification Program (NCUCP)* - A program that provides comprehensive services and information to applicants for DBE certification, such that an applicant is required to apply only once for a DBE certification that will be honored by all recipients of USDOT funds in the state and not limited to the Department of Transportation only. The Certification Program is in accordance with 49 CFR Part 26.

*United States Department of Transportation (USDOT)* - Federal agency responsible for issuing regulations (49 CFR Part 26) and official guidance for the DBE program.

### **Forms and Websites Referenced in this Provision**

*DBE Payment Tracking System* - On-line system in which the Contractor enters the payments made to DBE subcontractors who have performed work on the project.  
<https://apps.dot.state.nc.us/Vendor/PaymentTracking/>

*DBE-IS Subcontractor Payment Information* - Form for reporting the payments made to all DBE firms working on the project. This form is for paper bid projects only.  
<https://connect.ncdot.gov/business/Turnpike/Documents/Form%20DBE-IS%20Subcontractor%20Payment%20Information.pdf>

*RF-1 DBE Replacement Request Form* - Form for replacing a committed DBE.  
<http://connect.ncdot.gov/projects/construction/Construction%20Forms/DBE%20MBE%20WBE%20Replacement%20Request%20Form.pdf>

*SAF Subcontract Approval Form* - Form required for approval to sublet the contract.  
<http://connect.ncdot.gov/projects/construction/Construction%20Forms/Subcontract%20Approval%20Form%20Rev.%202012.zip>

*JC-1 Joint Check Notification Form* - Form and procedures for joint check notification. The form acts as a written joint check agreement among the parties providing full and prompt disclosure of the expected use of joint checks.  
<http://connect.ncdot.gov/projects/construction/Construction%20Forms/Joint%20Check%20Notification%20Form.pdf>

*Letter of Intent* - Form signed by the Contractor and the DBE subcontractor, manufacturer or regular dealer that affirms that a portion of said contract is going to be performed by the signed DBE for the estimated amount (based on quantities and unit prices) listed at the time of bid.  
<http://connect.ncdot.gov/letting/LetCentral/Letter%20of%20Intent%20to%20Perform%20as%20a%20Subcontractor.pdf>

*Listing of DBE Subcontractors Form* - Form for entering DBE subcontractors on a project that will meet this DBE goal. This form is for paper bids only.  
[http://connect.ncdot.gov/municipalities/Bid%20Proposals%20for%20LGA%20Content/08%20DBE%20Subcontractors%20\(Federal\).docx](http://connect.ncdot.gov/municipalities/Bid%20Proposals%20for%20LGA%20Content/08%20DBE%20Subcontractors%20(Federal).docx)

*Subcontractor Quote Comparison Sheet* - Spreadsheet for showing all subcontractor quotes in the work areas where DBEs quoted on the project. This sheet is submitted with good faith effort packages.

<http://connect.ncdot.gov/business/SmallBusiness/Documents/DBE%20Subcontractor%20Quote%20Comparison%20Example.xls>

### **DBE Goal**

The following DBE goal for participation by Disadvantaged Business Enterprises is established for this contract:

Disadvantaged Business Enterprises **0.0** %

- (A) *If the DBE goal is more than zero*, the Contractor shall exercise all necessary and reasonable steps to ensure that DBEs participate in at least the percent of the contract as set forth above as the DBE goal.
- (B) *If the DBE goal is zero*, the Contractor shall make an effort to recruit and use DBEs during the performance of the contract. Any DBE participation obtained shall be reported to the Department.

### **Directory of Transportation Firms (Directory)**

Real-time information is available about firms doing business with the Department and firms that are certified through NCUCP in the Directory of Transportation Firms. Only firms identified in the Directory as DBE certified shall be used to meet the DBE goal. The Directory can be found at the following link. [https:// www.ebs.nc.gov/VendorDirectory/default.html](https://www.ebs.nc.gov/VendorDirectory/default.html)

The listing of an individual firm in the directory shall not be construed as an endorsement of the firm's capability to perform certain work.

### **Listing of DBE Subcontractors**

At the time of bid, bidders shall submit all DBE participation that they anticipate to use during the life of the contract. Only those identified to meet the DBE goal will be considered committed, even though the listing shall include both committed DBE subcontractors and additional DBE subcontractors. Additional DBE subcontractor participation submitted at the time of bid will be used toward the Department's overall race-neutral goal. Only those firms with current DBE certification at the time of bid opening will be acceptable for listing in the bidder's submittal of DBE participation. The Contractor shall indicate the following required information:

- (A) Electronic Bids

Bidders shall submit a listing of DBE participation in the appropriate section of the electronic submittal file.

- (1) Submit the names and addresses of DBE firms identified to participate in the contract. If the bidder uses the updated listing of DBE firms shown in the electronic

submittal file, the bidder may use the dropdown menu to access the name and address of the DBE firm.

- (2) Submit the contract line numbers of work to be performed by each DBE firm. When no figures or firms are entered, the bidder will be considered to have no DBE participation.
- (3) The bidder shall be responsible for ensuring that the DBE is certified at the time of bid by checking the Directory of Transportation Firms. If the firm is not certified at the time of the bid-letting, that DBE's participation will not count towards achieving the DBE goal.

(B) Paper Bids

- (1) *If the DBE goal is more than zero,*
  - (a) Bidders, at the time the bid proposal is submitted, shall submit a listing of DBE participation, including the names and addresses on *Listing of DBE Subcontractors* contained elsewhere in the contract documents in order for the bid to be considered responsive. Bidders shall indicate the total dollar value of the DBE participation for the contract.
  - (b) If bidders have no DBE participation, they shall indicate this on the *Listing of DBE Subcontractors* by entering the word "None" or the number "0." This form shall be completed in its entirety. **Blank forms will not be deemed to represent zero participation.** Bids submitted that do not have DBE participation indicated on the appropriate form will not be read publicly during the opening of bids. The Department will not consider these bids for award and the proposal will be rejected.
  - (c) The bidder shall be responsible for ensuring that the DBE is certified at the time of bid by checking the Directory of Transportation Firms. If the firm is not certified at the time of the bid-letting, that DBE's participation will not count towards achieving the corresponding goal.
- (2) *If the DBE goal is zero,* entries on the *Listing of DBE Subcontractors* are not required for the zero goal, however any DBE participation that is achieved during the project shall be reported in accordance with requirements contained elsewhere in the special provision.

**DBE Prime Contractor**

When a certified DBE firm bids on a contract that contains a DBE goal, the DBE firm is responsible for meeting the goal or making good faith efforts to meet the goal, just like any other bidder. In most cases, a DBE bidder on a contract will meet the DBE goal by virtue of the work it performs on the contract with its own forces. However, all the work that is performed by the DBE bidder and any other DBE subcontractors will count toward the DBE goal. The DBE bidder

shall list itself along with any DBE subcontractors, if any, in order to receive credit toward the DBE goal.

For example, if the DBE goal is 45% and the DBE bidder will only perform 40% of the contract work, the prime will list itself at 40%, and the additional 5% shall be obtained through additional DBE participation with DBE subcontractors or documented through a good faith effort.

DBE prime contractors shall also follow Sections A and B listed under *Listing of DBE Subcontractor* just as a non-DBE bidder would.

### **Written Documentation – Letter of Intent**

The bidder shall submit written documentation for each DBE that will be used to meet the DBE goal of the contract, indicating the bidder's commitment to use the DBE in the contract. This documentation shall be submitted on the Department's form titled *Letter of Intent*.

The documentation shall be received in the office of the State Contractor Utilization Engineer or at DBE@ncdot.gov no later than 10:00 a.m. of the sixth calendar day following opening of bids, unless the sixth day falls on an official state holiday. In that situation, it is due in the office of the State Contractor Utilization Engineer no later than 10:00 a.m. on the next official state business day.

If the bidder fails to submit the Letter of Intent from each committed DBE to be used toward the DBE goal, or if the form is incomplete (i.e. both signatures are not present), the DBE participation will not count toward meeting the DBE goal. If the lack of this participation drops the commitment below the DBE goal, the Contractor shall submit evidence of good faith efforts, completed in its entirety, to the State Contractor Utilization Engineer or DBE@ncdot.gov no later than 10:00 a.m. on the eighth calendar day following opening of bids, unless the eighth day falls on an official state holiday. In that situation, it is due in the office of the State Contractor Utilization Engineer no later than 10:00 a.m. on the next official state business day.

### **Submission of Good Faith Effort**

If the bidder fails to meet or exceed the DBE goal, the apparent lowest responsive bidder shall submit to the Department documentation of adequate good faith efforts made to reach the DBE goal.

A hard copy and an electronic copy of this information shall be received in the office of the State Contractor Utilization Engineer or at DBE@ncdot.gov no later than 10:00 a.m. on the sixth calendar day following opening of bids unless the sixth day falls on an official state holiday. In that situation, it is due in the office of the State Contractor Utilization Engineer no later than 10:00 a.m. on the next official state business day. If the contractor cannot send the information electronically, then one complete set and 5 copies of this information shall be received under the same time constraints above.

Note: Where the information submitted includes repetitious solicitation letters, it will be acceptable to submit a representative letter along with a distribution list of the firms that were solicited. Documentation of DBE quotations shall be a part of the good faith effort submittal. This

documentation may include written subcontractor quotations, telephone log notations of verbal quotations, or other types of quotation documentation.

### **Consideration of Good Faith Effort for Projects with DBE Goals More Than Zero**

Adequate good faith efforts mean that the bidder took all necessary and reasonable steps to achieve the goal which, by their scope, intensity, and appropriateness, could reasonably be expected to obtain sufficient DBE participation. Adequate good faith efforts also mean that the bidder actively and aggressively sought DBE participation. Mere *pro forma* efforts are not considered good faith efforts.

The Department will consider the quality, quantity, and intensity of the different kinds of efforts a bidder has made. Listed below are examples of the types of actions a bidder will take in making a good faith effort to meet the goal and are not intended to be exclusive or exhaustive, nor is it intended to be a mandatory checklist.

- (A) Soliciting through all reasonable and available means (e.g. attendance at pre-bid meetings, advertising, written notices, use of verifiable electronic means through the use of the NCDOT Directory of Transportation Firms) the interest of all certified DBEs who have the capability to perform the work of the contract. The bidder must solicit this interest within at least 10 days prior to bid opening to allow the DBEs to respond to the solicitation. Solicitation shall provide the opportunity to DBEs within the Division and surrounding Divisions where the project is located. The bidder must determine with certainty if the DBEs are interested by taking appropriate steps to follow up initial solicitations.
- (B) Selecting portions of the work to be performed by DBEs in order to increase the likelihood that the DBE goals will be achieved.
  - (1) Where appropriate, break out contract work items into economically feasible units to facilitate DBE participation, even when the prime contractor might otherwise prefer to perform these work items with its own forces.
  - (2) Negotiate with subcontractors to assume part of the responsibility to meet the contract DBE goal when the work to be sublet includes potential for DBE participation (2<sup>nd</sup> and 3<sup>rd</sup> tier subcontractors).
- (C) Providing interested DBEs with adequate information about the plans, specifications, and requirements of the contract in a timely manner to assist them in responding to a solicitation.
- (D) (1) Negotiating in good faith with interested DBEs. It is the bidder's responsibility to make a portion of the work available to DBE subcontractors and suppliers and to select those portions of the work or material needs consistent with the available DBE subcontractors and suppliers, to facilitate DBE participation. Evidence of such negotiation includes the names, addresses, and telephone numbers of DBEs that were considered; a description of the information provided regarding the plans and specifications for the work selected for subcontracting; and evidence as to why additional agreements could not be reached for DBEs to perform the work.

- (2) A bidder using good business judgment would consider a number of factors in negotiating with subcontractors, including DBE subcontractors, and would take a firm's price and capabilities as well as contract goals into consideration. However, the fact that there may be some additional costs involved in finding and using DBEs is not in itself sufficient reason for a bidder's failure to meet the contract DBE goal, as long as such costs are reasonable. Also, the ability or desire of a prime contractor to perform the work of a contract with its own organization does not relieve the bidder of the responsibility to make good faith efforts. Bidding contractors are not, however, required to accept higher quotes from DBEs if the price difference is excessive or unreasonable.
- (E) Not rejecting DBEs as being unqualified without sound reasons based on a thorough investigation of their capabilities. The bidder's standing within its industry, membership in specific groups, organizations, or associates and political or social affiliations (for example, union vs. non-union employee status) are not legitimate causes for the rejection or non-solicitation of bids in the bidder's efforts to meet the project goal.
- (F) Making efforts to assist interested DBEs in obtaining bonding, lines of credit, or insurance as required by the recipient or bidder.
- (G) Making efforts to assist interested DBEs in obtaining necessary equipment, supplies, materials, or related assistance or services.
- (H) Effectively using the services of available minority/women community organizations; minority/women contractors' groups; Federal, State, and local minority/women business assistance offices; and other organizations as allowed on a case-by-case basis to provide assistance in the recruitment and placement of DBEs. Contact within 7 days from the bid opening the Business Opportunity and Work Force Development Unit at BOWD@ncdot.gov to give notification of the bidder's inability to get DBE quotes.
- (I) Any other evidence that the bidder submits which shows that the bidder has made reasonable good faith efforts to meet the DBE goal.

In addition, the Department may take into account the following:

- (1) Whether the bidder's documentation reflects a clear and realistic plan for achieving the DBE goal.
- (2) The bidders' past performance in meeting the DBE goals.
- (3) The performance of other bidders in meeting the DBE goal. For example, when the apparent successful bidder fails to meet the DBE goal, but others meet it, you may reasonably raise the question of whether, with additional reasonable efforts the apparent successful bidder could have met the goal. If the apparent successful bidder fails to meet the DBE goal, but meets or exceeds the average DBE participation obtained by other bidders, the Department may view this,

in conjunction with other factors, as evidence of the apparent successful bidder having made a good faith effort.

If the Department does not award the contract to the apparent lowest responsive bidder, the Department reserves the right to award the contract to the next lowest responsive bidder that can satisfy to the Department that the DBE goal can be met or that an adequate good faith effort has been made to meet the DBE goal.

### **Non-Good Faith Appeal**

The State Prequalification Engineer will notify the contractor verbally and in writing of non-good faith. A contractor may appeal a determination of non-good faith made by the Goal Compliance Committee. If a contractor wishes to appeal the determination made by the Committee, they shall provide written notification to the State Prequalification Engineer or at DBE@ncdot.gov. The appeal shall be made within 2 business days of notification of the determination of non-good faith.

### **Counting DBE Participation Toward Meeting DBE Goal**

#### **(A) Participation**

The total dollar value of the participation by a committed DBE will be counted toward the contract goal requirement. The total dollar value of participation by a committed DBE will be based upon the value of work actually performed by the DBE and the actual payments to DBE firms by the Contractor.

#### **(B) Joint Checks**

Prior notification of joint check use shall be required when counting DBE participation for services or purchases that involves the use of a joint check. Notification shall be through submission of Form JC-1 (*Joint Check Notification Form*) and the use of joint checks shall be in accordance with the Department's Joint Check Procedures.

#### **(C) Subcontracts (Non-Trucking)**

A DBE may enter into subcontracts. Work that a DBE subcontracts to another DBE firm may be counted toward the contract goal requirement. Work that a DBE subcontracts to a non-DBE firm does not count toward the contract goal requirement. If a DBE contractor or subcontractor subcontracts a significantly greater portion of the work of the contract than would be expected on the basis of standard industry practices, it shall be presumed that the DBE is not performing a commercially useful function. The DBE may present evidence to rebut this presumption to the Department. The Department's decision on the rebuttal of this presumption is subject to review by the Federal Highway Administration but is not administratively appealable to USDOT.

#### **(D) Joint Venture**

When a DBE performs as a participant in a joint venture, the Contractor may count toward its contract goal requirement a portion of the total value of participation with the DBE in

the joint venture, that portion of the total dollar value being a distinct clearly defined portion of work that the DBE performs with its forces.

(E) Suppliers

A contractor may count toward its DBE requirement 60 percent of its expenditures for materials and supplies required to complete the contract and obtained from a DBE regular dealer and 100 percent of such expenditures from a DBE manufacturer.

(F) Manufacturers and Regular Dealers

A contractor may count toward its DBE requirement the following expenditures to DBE firms that are not manufacturers or regular dealers:

- (1) The fees or commissions charged by a DBE firm for providing a *bona fide* service, such as professional, technical, consultant, or managerial services, or for providing bonds or insurance specifically required for the performance of a DOT-assisted contract, provided the fees or commissions are determined to be reasonable and not excessive as compared with fees and commissions customarily allowed for similar services.
- (2) With respect to materials or supplies purchased from a DBE, which is neither a manufacturer nor a regular dealer, count the entire amount of fees or commissions charged for assistance in the procurement of the materials and supplies, or fees or transportation charges for the delivery of materials or supplies required on a job site (but not the cost of the materials and supplies themselves), provided the fees are determined to be reasonable and not excessive as compared with fees customarily allowed for similar services.

### **Commercially Useful Function**

(A) DBE Utilization

The Contractor may count toward its contract goal requirement only expenditures to DBEs that perform a commercially useful function in the work of a contract. A DBE performs a commercially useful function when it is responsible for execution of the work of the contract and is carrying out its responsibilities by actually performing, managing, and supervising the work involved. To perform a commercially useful function, the DBE shall also be responsible with respect to materials and supplies used on the contract, for negotiating price, determining quality and quantity, ordering the material and installing (where applicable) and paying for the material itself. To determine whether a DBE is performing a commercially useful function, the Department will evaluate the amount of work subcontracted, industry practices, whether the amount the firm is to be paid under the contract is commensurate with the work it is actually performing and the DBE credit claimed for its performance of the work, and any other relevant factors.



**(B) DBE Utilization in Trucking**

The following factors will be used to determine if a DBE trucking firm is performing a commercially useful function:

- (1) The DBE shall be responsible for the management and supervision of the entire trucking operation for which it is responsible on a particular contract, and there shall not be a contrived arrangement for the purpose of meeting DBE goals.
- (2) The DBE shall itself own and operate at least one fully licensed, insured, and operational truck used on the contract.
- (3) The DBE receives credit for the total value of the transportation services it provides on the contract using trucks it owns, insures, and operates using drivers it employs.
- (4) The DBE may subcontract the work to another DBE firm, including an owner-operator who is certified as a DBE. The DBE who subcontracts work to another DBE receives credit for the total value of the transportation services the subcontracted DBE provides on the contract.
- (5) The DBE may also subcontract the work to a non-DBE firm, including from an owner-operator. The DBE who subcontracts the work to a non-DBE is entitled to credit for the total value of transportation services provided by the non-DBE subcontractor not to exceed the value of transportation services provided by DBE-owned trucks on the contract. Additional participation by non-DBE subcontractors receives credit only for the fee or commission it receives as a result of the subcontract arrangement. The value of services performed under subcontract agreements between the DBE and the Contractor will not count towards the DBE contract requirement.
- (6) A DBE may lease truck(s) from an established equipment leasing business open to the general public. The lease must indicate that the DBE has exclusive use of and control over the truck. This requirement does not preclude the leased truck from working for others during the term of the lease with the consent of the DBE, so long as the lease gives the DBE absolute priority for use of the leased truck. This type of lease may count toward the DBE's credit as long as the driver is under the DBE's payroll.
- (7) Subcontracted/leased trucks shall display clearly on the dashboard the name of the DBE that they are subcontracted/leased to and their own company name if it is not identified on the truck itself. Magnetic door signs are not permitted.

**DBE Replacement**

When a Contractor has relied on a commitment to a DBE subcontractor (or an approved substitute DBE subcontractor) to meet all or part of a contract goal requirement, the contractor shall not terminate the DBE subcontractor for convenience. This includes, but is not limited to, instances in which the Contractor seeks to perform the work of the terminated subcontractor with another

DBE subcontractor, a non-DBE subcontractor, or with the Contractor's own forces or those of an affiliate.

The Contractor must give notice in writing both by certified mail and email to the DBE subcontractor, with a copy to the Engineer of its intent to request to terminate and/or substitute, and the reason for the request. The Contractor must give the DBE subcontractor five (5) business days to respond to the Contractor's Notice of Intent to Request Termination and/or Substitution. If the DBE subcontractor objects to the intended termination/substitution, the DBE, within five (5) business days must advise the Contractor and the Department of the reasons why the action should not be approved. The five-day notice period shall begin on the next business day after written notice is provided to the DBE subcontractor.

A committed DBE subcontractor may only be terminated after receiving the Department's written approval based upon a finding of good cause for the proposed termination and/or substitution. For purposes of this section, good cause shall include the following circumstances:

- (a) The listed DBE subcontractor fails or refuses to execute a written contract;
- (b) The listed DBE subcontractor fails or refuses to perform the work of its subcontract in a way consistent with normal industry standards. Provided, however, that good cause does not exist if the failure or refusal of the DBE subcontractor to perform its work on the subcontract results from the bad faith or discriminatory action of the prime contractor;
- (c) The listed DBE subcontractor fails or refuses to meet the prime contractor's reasonable, nondiscriminatory bond requirements;
- (d) The listed DBE subcontractor becomes bankrupt, insolvent, or exhibits credit unworthiness;
- (e) The listed DBE subcontractor is ineligible to work on public works projects because of suspension and debarment proceedings pursuant to 2 CFR Parts 180, 215 and 1,200 or applicable state law;
- (f) The listed DBE subcontractor is not a responsible contractor;
- (g) The listed DBE voluntarily withdraws from the project and provides written notice of withdrawal;
- (h) The listed DBE is ineligible to receive DBE credit for the type of work required;
- (i) A DBE owner dies or becomes disabled with the result that the listed DBE contractor is unable to complete its work on the contract;
- (j) Other documented good cause that compels the termination of the DBE subcontractor. Provided, that good cause does not exist if the prime contractor seeks to terminate a DBE it relied upon to obtain the contract so that the prime contractor can self-perform the work for which the DBE contractor was engaged or so that the prime contractor can substitute another DBE or non-DBE contractor after contract award.

The Contractor shall comply with the following for replacement of a committed DBE:

(A) Performance Related Replacement

When a committed DBE is terminated for good cause as stated above, an additional DBE that was submitted at the time of bid may be used to fulfill the DBE commitment. A good faith effort will only be required for removing a committed DBE if there were no additional

DBEs submitted at the time of bid to cover the same amount of work as the DBE that was terminated.

If a replacement DBE is not found that can perform at least the same amount of work as the terminated DBE, the Contractor shall submit a good faith effort documenting the steps taken. Such documentation shall include, but not be limited to, the following:

- (1) Copies of written notification to DBEs that their interest is solicited in contracting the work defaulted by the previous DBE or in subcontracting other items of work in the contract.
  - (2) Efforts to negotiate with DBEs for specific subbids including, at a minimum:
    - (a) The names, addresses, and telephone numbers of DBEs who were contacted.
    - (b) A description of the information provided to DBEs regarding the plans and specifications for portions of the work to be performed.
  - (3) A list of reasons why DBE quotes were not accepted.
  - (4) Efforts made to assist the DBEs contacted, if needed, in obtaining bonding or insurance required by the Contractor.
- (B) Decertification Replacement
- (1) When a committed DBE is decertified by the Department after the SAF (*Subcontract Approval Form*) has been received by the Department, the Department will not require the Contractor to solicit replacement DBE participation equal to the remaining work to be performed by the decertified firm. The participation equal to the remaining work performed by the decertified firm will count toward the contract goal requirement.
  - (2) When a committed DBE is decertified prior to the Department receiving the SAF (*Subcontract Approval Form*) for the named DBE firm, the Contractor shall take all necessary and reasonable steps to replace the DBE subcontractor with another DBE subcontractor to perform at least the same amount of work to meet the DBE goal requirement. If a DBE firm is not found to do the same amount of work, a good faith effort must be submitted to NCDOT (see A herein for required documentation).

All requests for replacement of a committed DBE firm shall be submitted to the Engineer for approval on Form RF-1 (*DBE Replacement Request*). If the Contractor fails to follow this procedure, the Contractor may be disqualified from further bidding for a period of up to 6 months.

### **Changes in the Work**

When the Engineer makes changes that result in the reduction or elimination of work to be performed by a committed DBE, the Contractor will not be required to seek additional

participation. When the Engineer makes changes that result in additional work to be performed by a DBE based upon the Contractor's commitment, the DBE shall participate in additional work to the same extent as the DBE participated in the original contract work.

When the Engineer makes changes that result in extra work, which has more than a minimal impact on the contract amount, the Contractor shall seek additional participation by DBEs unless otherwise approved by the Engineer.

When the Engineer makes changes that result in an alteration of plans or details of construction, and a portion or all of the work had been expected to be performed by a committed DBE, the Contractor shall seek participation by DBEs unless otherwise approved by the Engineer.

When the Contractor requests changes in the work that result in the reduction or elimination of work that the Contractor committed to be performed by a DBE, the Contractor shall seek additional participation by DBEs equal to the reduced DBE participation caused by the changes.

### **Reports and Documentation**

A SAF (*Subcontract Approval Form*) shall be submitted for all work which is to be performed by a DBE subcontractor. The Department reserves the right to require copies of actual subcontract agreements involving DBE subcontractors.

When using transportation services to meet the contract commitment, the Contractor shall submit a proposed trucking plan in addition to the SAF. The plan shall be submitted prior to beginning construction on the project. The plan shall include the names of all trucking firms proposed for use, their certification type(s), the number of trucks owned by the firm, as well as the individual truck identification numbers, and the line item(s) being performed.

Within 30 calendar days of entering into an agreement with a DBE for materials, supplies or services, not otherwise documented by the SAF as specified above, the Contractor shall furnish the Engineer a copy of the agreement. The documentation shall also indicate the percentage (60% or 100%) of expenditures claimed for DBE credit.

### **Reporting Disadvantaged Business Enterprise Participation**

The Contractor shall provide the Engineer with an accounting of payments made to all DBE firms, including material suppliers and contractors at all levels (prime, subcontractor, or second tier subcontractor). This accounting shall be furnished to the Engineer for any given month by the end of the following month. Failure to submit this information accordingly may result in the following action:

- (A) Withholding of money due in the next partial pay estimate; or
- (B) Removal of an approved contractor from the prequalified bidders' list or the removal of other entities from the approved subcontractors list.

While each contractor (prime, subcontractor, 2nd tier subcontractor) is responsible for accurate accounting of payments to DBEs, it shall be the prime contractor's responsibility to report all monthly and final payment information in the correct reporting manner.

Failure on the part of the Contractor to submit the required information in the time frame specified may result in the disqualification of that contractor and any affiliate companies from further bidding until the required information is submitted.

Failure on the part of any subcontractor to submit the required information in the time frame specified may result in the disqualification of that contractor and any affiliate companies from being approved for work on future DOT projects until the required information is submitted.

Contractors reporting transportation services provided by non-DBE lessees shall evaluate the value of services provided during the month of the reporting period only.

At any time, the Engineer can request written verification of subcontractor payments.

The Contractor shall report the accounting of payments through the Department's DBE Payment Tracking System.

### **Failure to Meet Contract Requirements**

Failure to meet contract requirements in accordance with Subarticle 102-15(J) of the *2018 Standard Specifications* may be cause to disqualify the Contractor.

### **CERTIFICATION FOR FEDERAL-AID CONTRACTS:**

(3-21-90)

SP1 G85

The prospective participant certifies, by signing and submitting this bid or proposal, to the best of his or her knowledge and belief, that:

- (A) No Federal appropriated funds have been paid or will be paid, by or on behalf of the undersigned, to any person for influencing or attempting to influence an officer or employee of any Federal agency, a Member of Congress, an officer or employee of Congress, or an employee of a Member of Congress in connection with the awarding of any Federal contract, the making of any Federal grant, the making of any Federal loan, the entering into of any cooperative agreement, and the extension, continuation, renewal, amendment, or modification of any Federal contract, grant, loan, or cooperative agreement.
- (B) If any funds other than Federal appropriated funds have been paid or will be paid to any person for influencing or attempting to influence an officer or employee of any Federal agency, a Member of Congress, an officer or employee of Congress, or an employee of a Member of Congress in connection with this Federal contract, grant, loan, or cooperative agreement, the undersigned shall complete and submit Standard Form-LLL, *Disclosure Form to Report Lobbying*, in accordance with its instructions.

This certification is a material representation of fact upon which reliance was placed when this transaction was made or entered into. Submission of this certification is a prerequisite for making or entering into this transaction imposed by *Section 1352, Title 31, U.S. Code*. Any person who

fails to file the required certification shall be subject to a civil penalty of not less than \$10,000 and not more than \$100,000 for each such failure.

The prospective participant also agrees by submitting his or her bid or proposal that he or she shall require that the language of this certification be included in all lower tier subcontracts, which exceed \$100,000 and that all such subrecipients shall certify and disclose accordingly.

**CONTRACTOR'S LICENSE REQUIREMENTS:**

(7-1-95)

102-14

SP1 G88

If the successful bidder does not hold the proper license to perform any plumbing, heating, air conditioning, or electrical work in this contract, he will be required to sublet such work to a contractor properly licensed in accordance with *Article 2 of Chapter 87 of the General Statutes* (licensing of heating, plumbing, and air conditioning contractors) and *Article 4 of Chapter 87 of the General Statutes* (licensing of electrical contractors).

**RESTRICTIONS ON ITS EQUIPMENT AND SERVICES:**

(11-17-20)

SP01 G090

All telecommunications, video or other ITS equipment or services installed or utilized on this project must be in conformance with UNIFORM ADMINISTRATIVE REQUIREMENTS, COST PRINCIPLES, AND AUDIT REQUIREMENTS FOR FEDERAL AWARDS **2 CFR, § 200.216** **Prohibition on certain telecommunications and video surveillance services or equipment.**

**USE OF UNMANNED AIRCRAFT SYSTEM (UAS):**

(8-20-19)

SP1 G092

The Contractor shall adhere to all Federal, State and Local regulations and guidelines for the use of Unmanned Aircraft Systems (UAS). This includes but is not limited to US 14 CFR Part 107 *Small UAS Rule*, NC GS 15A-300.2 *Regulation of launch and recovery sites*, NC GS 63-95 *Training required for the operation of unmanned aircraft systems*, NC GS 63-96 *Permit required for commercial operation of unmanned aircraft system*, and NCDOT UAS Policy. The required operator certifications include possessing a current Federal Aviation Administration (FAA) Remote Pilot Certificate, a NC UAS Operator Permit as well as operating a UAS registered with the FAA.

Prior to beginning operations, the Contractor shall complete the NCDOT UAS – Flight Operation Approval Form and submit it to the Engineer for approval. All UAS operations shall be approved by the Engineer prior to beginning the operations.

All contractors or subcontractors operating UAS shall have UAS specific general liability insurance to cover all operations under this contract.

The use of UAS is at the Contractor's discretion. No measurement or payment will be made for the use of UAS. In the event that the Department directs the Contractor to utilize UAS, payment will be in accordance with Article 104-7 Extra Work.

**EQUIPMENT IDLING GUIDELINES:**

(1-19-21)

107

SP1 G096

Exercise reduced fuel consumption and reduced equipment emissions during the construction of all work associated with this contract. Employees engaged in the construction of this project should turn off vehicles when stopped for more than thirty (30) minutes and off-highway equipment should idle no longer than fifteen (15) consecutive minutes.

These guidelines for turning off vehicles and equipment when idling do not apply to:

1. Idling when queuing.
2. Idling to verify the vehicle is in safe operating condition.
3. Idling for testing, servicing, repairing or diagnostic purposes.
4. Idling necessary to accomplish work for which the vehicle was designed (such as operating a crane, mixing concrete, etc.).
5. Idling required to bring the machine system to operating temperature.
6. Emergency vehicles, utility company, construction, and maintenance vehicles where the engines must run to perform needed work.
7. Idling to ensure safe operation of the vehicle.
8. Idling when the propulsion engine is providing auxiliary power for other than heating or air conditioning. (such as hydraulic systems for pavers)
9. When specific traffic, safety, or emergency situations arise.
10. If the ambient temperature is less than 32 degrees Fahrenheit. Limited idling to provide for the safety of vehicle occupants (e.g. to run the heater).
11. If the ambient temperature is greater than 90 degrees Fahrenheit. Limited idling to provide for the safety of vehicle occupants of off-highway equipment (e.g. to run the air conditioning) no more than 30 minutes.
12. Diesel powered vehicles may idle for up to 30 minutes to minimize restart problems.

Any vehicle, truck, or equipment in which the primary source of fuel is natural gas or electricity is exempt from the idling limitations set forth in this special provision.

**U.S. DEPARTMENT OF TRANSPORTATION HOTLINE:**

(11-22-94)

108-5

SP1 G100

To report bid rigging activities call: **1-800-424-9071**

The U.S. Department of Transportation (DOT) operates the above toll-free hotline Monday through Friday, 8:00 a.m. to 5:00 p.m. eastern time. Anyone with knowledge of possible bid rigging, bidder collusion, or other fraudulent activities should use the hotline to report such activities.

The hotline is part of the DOT's continuing effort to identify and investigate highway construction contract fraud and abuse is operated under the direction of the DOT Inspector General. All information will be treated confidentially and caller anonymity will be respected.

**CARGO PREFERENCE ACT:**

(2-16-16)

Privately owned United States-flag commercial vessels transporting cargoes are subject to the Cargo Preference Act (CPA) of 1954 requirements and regulations found in 46 CFR 381.7. Contractors are directed to clause (b) of 46 CFR 381.7 as follows:

(b) Contractor and Subcontractor Clauses. "Use of United States-flag vessels: The contractor agrees-

" (1) To utilize privately owned United States-flag commercial vessels to ship at least 50 percent of the gross tonnage (computed separately for dry bulk carriers, dry cargo liners, and tankers) involved, whenever shipping any equipment, material, or commodities pursuant to this contract, to the extent such vessels are available at fair and reasonable rates for United States-flag commercial vessels.

(2) To furnish within 20 days following the date of loading for shipments originating within the United States or within 30 working days following the date of loading for shipments originating outside the United States a legible copy of a rated, 'on-board' commercial ocean bill-of-lading in English for each shipment of cargo described in paragraph (b) (1) of this section to both the Contracting Officer (through the prime contractor in the case of subcontractor bills-of-lading) and to the Division of National Cargo, Office of Market Development, Maritime Administration, Washington, DC 20590.

(3) To insert the substance of the provisions of this clause in all subcontracts issued pursuant to this contract."

**ELECTRONIC BIDDING:**

(2-19-19)

101, 102, 103

SP1 G140

Revise the *2018 Standard Specifications* as follows:

**Page 1-4, Article 101-3, DEFINITIONS, BID (OR PROPOSAL) *Electronic Bid*, line 1,** replace "Bid Express®" with "the approved electronic bidding provider".

**Page 1-15, Subarticle 102-8(B), Electronic Bids, lines 39-40,** replace "to Bid Express®" with "via the approved electronic bidding provider".

**Page 1-15, Subarticle 102-8(B)(1), Electronic Bids, line 41,** delete "from Bid Express®"

**Page 1-17, Subarticle 102-9(C)(2), Electronic Bids, line 21,** replace "Bid Express® miscellaneous folder within the .ebs" with "electronic submittal".

**Page 1-29, Subarticle 103-4(C)(2), Electronic Bids, line 32,** replace ".ebs miscellaneous data file of Expedite" with "electronic submittal file"



**PROJECT SPECIAL PROVISIONS****ROADWAY****SUPPLEMENTAL SURVEYING:**

(4-20-21)

801

SP8 R03

Revise the *2018 Standard Specifications* as follows:

**Page 8-7, Article 801-3 MEASUREMENT AND PAYMENT**, lines 10-11, replace with the following:

*Supplemental Surveying Office Calculations* will be paid at the stated price of \$85.00 per hour. *Supplemental Field Surveying* will be paid at the stated price of \$145.00 per hour. The

**FOUNDATIONS AND ANCHOR ROD ASSEMBLIES FOR METAL POLES:**

(1-17-12) (Rev. 1-16-18)

9, 14, 17

SP9 R05

**Description**

Foundations for metal poles include foundations for signals, cameras, overhead and dynamic message signs (DMS) and high mount and light standards supported by metal poles or upright trusses. Foundations consist of footings with pedestals and drilled piers with or without grade beams or wings. Anchor rod assemblies consist of anchor rods (also called anchor bolts) with nuts and washers on the exposed ends of rods and nuts and a plate or washers on the other ends of rods embedded in the foundation.

Construct concrete foundations with the required resistances and dimensions and install anchor rod assemblies in accordance with the contract and accepted submittals. Construct drilled piers consisting of cast-in-place reinforced concrete cylindrical sections in excavated holes. Provide temporary casings or polymer slurry as needed to stabilize drilled pier excavations. Use a prequalified Drilled Pier Contractor to construct drilled piers for metal poles. Define “excavation” and “hole” as a drilled pier excavation and “pier” as a drilled pier.

This provision does not apply to foundations for signal pedestals; see Section 1743 of the *2018 Standard Specifications* and 2018 Roadway Standard Drawing No. 1743.01.

**Materials**

Refer to the *2018 Standard Specifications*.

<b>Item</b>	<b>Section</b>
Conduit	1091-3
Grout, Type 2	1003
Polymer Slurry	411-2(B)(2)
Portland Cement Concrete	1000
Reinforcing Steel	1070
Rollers and Chairs	411-2(C)
Temporary Casings	411-2(A)

Provide Type 3 material certifications in accordance with Article 106-3 of the *2018 Standard Specifications* for conduit, rollers, chairs and anchor rod assemblies. Store steel materials on blocking at least 12" above the ground and protect it at all times from damage; and when placing in the work make sure it is free from dirt, dust, loose mill scale, loose rust, paint, oil or other foreign materials. Load, transport, unload and store foundation and anchor rod assembly materials so materials are kept clean and free of damage. Bent, damaged or defective materials will be rejected.

Use conduit type in accordance with the contract. Use Class A concrete for footings and pedestals, Class Drilled Pier concrete for drilled piers and Class AA concrete for grade beams and wings including portions of drilled piers above bottom of wings elevations. Corrugated temporary casings may be accepted at the discretion of the Engineer. A list of approved polymer slurry products is available from:

[connect.ncdot.gov/resources/Geological/Pages/Products.aspx](http://connect.ncdot.gov/resources/Geological/Pages/Products.aspx)

Provide anchor rod assemblies in accordance with the contract consisting of the following:

- (A) Straight anchor rods,
- (B) Heavy hex top and leveling nuts and flat washers on exposed ends of rods, and
- (C) Nuts and either flat plates or washers on the other ends of anchor rods embedded in foundations.

Do not use lock washers. Use steel anchor rods, nuts and washers that meet ASTM F1554 for Grade 55 rods and Grade A nuts. Use steel plates and washers embedded in concrete with a thickness of at least 1/4". Galvanize anchor rods and exposed nuts and washers in accordance with Article 1076-4 of the *2018 Standard Specifications*. It is not necessary to galvanize nuts, plates and washers embedded in concrete.

### **Construction Methods**

Install the required size and number of conduits in foundations in accordance with the plans and accepted submittals. Construct top of piers, footings, pedestals, grade beams and wings flat, level and within 1" of elevations shown in the plans or approved by the Engineer. Provide an Ordinary Surface finish in accordance with Subarticle 825-6(B) of the *2018 Standard Specifications* for portions of foundations exposed above finished grade. Do not remove anchor bolt templates or pedestal or grade beam forms or erect metal poles or upright trusses onto foundations until concrete attains a compressive strength of at least 3,000 psi.

- (A) Drilled Piers

Before starting drilled pier construction, hold a predrill meeting to discuss the installation, monitoring and inspection of the drilled piers. Schedule this meeting after the Drilled Pier Contractor has mobilized to the site. The Resident or Division Traffic Engineer, Contractor and Drilled Pier Contractor Superintendent will attend this predrill meeting.

Do not excavate holes, install piles or allow equipment wheel loads or vibrations within 20 ft of completed piers until 16 hours after Drilled Pier concrete reaches initial set.

Check for correct drilled pier alignment and location before beginning drilling. Check plumbness of holes frequently during drilling.

Construct drilled piers with the minimum required diameters shown in the plans. Install piers with tip elevations no higher than shown in the plans or approved by the Engineer.

Excavate holes with equipment of the sizes required to construct drilled piers. Depending on the subsurface conditions encountered, drilling through rock and boulders may be required. Do not use blasting for drilled pier excavations.

Contain and dispose of drilling spoils and waste concrete as directed and in accordance with Section 802 of the *2018 Standard Specifications*. Drilling spoils consist of all materials and fluids removed from excavations.

If unstable, caving or sloughing materials are anticipated or encountered, stabilize holes with temporary casings and/or polymer slurry. Do not use telescoping temporary casings. If it becomes necessary to replace a temporary casing during drilling, backfill the excavation, insert a larger casing around the casing to be replaced or stabilize the excavation with polymer slurry before removing the temporary casing.

If temporary casings become stuck or the Contractor proposes leaving casings in place, temporary casings should be installed against undisturbed material. Unless otherwise approved, do not leave temporary casings in place for mast arm poles and cantilever signs. The Engineer will determine if casings may remain in place. If the Contractor proposes leaving temporary casings in place, do not begin drilling until a casing installation method is approved.

Use polymer slurry and additives to stabilize holes in accordance with the slurry manufacturer's recommendations. Provide mixing water and equipment suitable for polymer slurry. Maintain the required slurry properties at all times except for sand content.

Define a "sample set" as slurry samples collected from mid-height and within 2 ft of the bottom of holes. Take sample sets from excavations to test polymer slurry immediately after filling holes with slurry, at least every 4 hours thereafter and immediately before placing concrete. Do not place Drilled Pier concrete until both slurry samples from an excavation meet the required polymer slurry properties. If any slurry test results do not meet the requirements, the Engineer may suspend drilling until both samples from a sample set meet the required polymer slurry properties.

Remove soft and loose material from bottom of holes using augers to the satisfaction of the Engineer. Assemble rebar cages and place cages and Drilled Pier concrete in accordance with Subarticle 411-4(E) of the *2018 Standard Specifications* except for the following:

- (1) Inspections for tip resistance and bottom cleanliness are not required,
- (2) Temporary casings may remain in place if approved, and

- (3) Concrete placement may be paused near the top of pier elevations for anchor rod assembly installation and conduit placement or
- (4) If applicable, concrete placement may be stopped at bottom of grade beam or wings elevations for grade beam or wing construction.

If wet placement of concrete is anticipated or encountered, do not place Drilled Pier concrete until a concrete placement procedure is approved. If applicable, temporary casings and fluids may be removed when concrete placement is paused or stopped in accordance with the exceptions above provided holes are stable. Remove contaminated concrete from exposed Drilled Pier concrete after removing casings and fluids. If holes are unstable, do not remove temporary casings until a procedure for placing anchor rod assemblies and conduit or constructing grade beams or wings is approved.

Use collars to extend drilled piers above finished grade. Remove collars after Drilled Pier concrete sets and round top edges of piers.

If drilled piers are questionable, pile integrity testing (PIT) and further investigation may be required in accordance with Article 411-5 of the *2018 Standard Specifications*. A drilled pier will be considered defective in accordance with Subarticle 411-5(D) of the *2018 Standard Specifications* and drilled pier acceptance is based in part on the criteria in Article 411-6 of the *2018 Standard Specifications* except for the top of pier tolerances in Subarticle 411-6(C) of the *2018 Standard Specifications*.

If a drilled pier is under further investigation, do not grout core holes, backfill around the pier or perform any work on the drilled pier until the Engineer accepts the pier. If the drilled pier is accepted, dewater and grout core holes and backfill around the pier with approved material to finished grade. If the Engineer determines a pier is unacceptable, remediation is required in accordance with Article 411-6 of the *2018 Standard Specifications*. No extension of completion date or time will be allowed for remediation of unacceptable drilled piers or post repair testing.

Permanently embed a plate in or mark top of piers with the pier diameter and depth, size and number of vertical reinforcing bars and the minimum compressive strength of the concrete mix at 28 days.

(B) Footings, Pedestals, Grade Beams and Wings

Excavate as necessary for footings, grade beams and wings in accordance with the plans, accepted submittals and Section 410 of the *2018 Standard Specifications*. If unstable, caving or sloughing materials are anticipated or encountered, shore foundation excavations as needed with an approved method. Notify the Engineer when foundation excavation is complete. Do not place concrete or reinforcing steel until excavation dimensions and foundation material are approved.

Construct cast-in-place reinforced concrete footings, pedestals, grade beams and wings with the dimensions shown in the plans and in accordance with Section 825 of the *2018 Standard Specifications*. Use forms to construct portions of pedestals and grade beams protruding above finished grade. Provide a chamfer with a 3/4" horizontal width

for pedestal and grade beam edges exposed above finished grade. Place concrete against undisturbed soil or backfill and fill in accordance with Article 410-8 of the *2018 Standard Specifications*. Proper compaction around footings and wings is critical for foundations to resist uplift and torsion forces.

(C) Anchor Rod Assemblies

Size anchor rods for design and the required projection above top of foundations. Determine required anchor rod projections from nut, washer and base plate thicknesses, the protrusion of 3 to 5 anchor rod threads above top nuts after tightening and the distance of one nut thickness between top of foundations and bottom of leveling nuts.

Protect anchor rod threads from damage during storage and installation of anchor rod assemblies. Before placing anchor rods in foundations, turn nuts onto and off rods past leveling nut locations. Turn nuts with the effort of one workman using an ordinary wrench without a cheater bar. Report any thread damage to the Engineer that requires extra effort to turn nuts.

Arrange anchor rods symmetrically about center of base plate locations as shown in the plans. Set anchor rod elevations based on required projections above top of foundations. Securely brace and hold rods in the correct position, orientation and alignment with a steel template. Do not weld to reinforcing steel, temporary casings or anchor rods.

Install top and leveling (bottom) nuts, washers and the base plate for each anchor rod assembly in accordance with the following procedure:

- (1) Turn leveling nuts onto anchor rods to a distance of one nut thickness between the top of foundation and bottom of leveling nuts. Place washers over anchor rods on top of leveling nuts.
- (2) Determine if nuts are level using a flat rigid template on top of washers. If necessary, lower leveling nuts to level the template in all directions or if applicable, lower nuts to tilt the template so the metal pole or upright truss will lean as shown in the plans. If leveling nuts and washers are not in full contact with the template, replace washers with galvanized beveled washers.
- (3) Verify the distance between the foundation and leveling nuts is no more than one nut thickness.
- (4) Place base plate with metal pole or upright truss over anchor rods on top of washers. High mount luminaires may be attached before erecting metal poles but do not attach cables, mast arms or trusses to metal poles or upright trusses at this time.
- (5) Place washers over anchor rods on top of base plate. Lubricate top nut bearing surfaces and exposed anchor rod threads above washers with beeswax, paraffin or other approved lubricant.
- (6) Turn top nuts onto anchor rods. If nuts are not in full contact with washers or washers are not in full contact with the base plate, replace washers with galvanized beveled washers.
- (7) Tighten top nuts to snug-tight with the full effort of one workman using a 12" wrench. Do not tighten any nut all at once. Turn top nuts in increments. Follow a star pattern cycling through each nut at least twice.

- (8) Repeat (7) for leveling nuts.
- (9) Replace washers above and below the base plate with galvanized beveled washers if the slope of any base plate face exceeds 1:20 (5%), any washer is not in firm contact with the base plate or any nut is not in firm contact with a washer. If any washers are replaced, repeat (7) and (8).
- (10) With top and leveling nuts snug-tight, mark each top nut on a corner at the intersection of 2 flats and a corresponding reference mark on the base plate. Mark top nuts and base plate with ink or paint that is not water-soluble. Use the turn-of-nut method for pretensioning. Do not pretension any nut all at once. Turn top nuts in increments for a total turn that meets the following nut rotation requirements:

<b>NUT ROTATION REQUIREMENTS (Turn-of-Nut Pretensioning Method)</b>	
<b>Anchor Rod Diameter, inch</b>	<b>Requirement</b>
$\leq 1 \frac{1}{2}$	1/3 turn (2 flats)
$> 1 \frac{1}{2}$	1/6 turn (1 flat)

Follow a star pattern cycling through each top nut at least twice.

- (11) Ensure nuts, washers and base plate are in firm contact with each other for each anchor rod. Cables, mast arms and trusses may now be attached to metal poles and upright trusses.
- (12) Between 4 and 14 days after pretensioning top nuts, use a torque wrench calibrated within the last 12 months to check nuts in the presence of the Engineer. Completely erect mast arm poles and cantilever signs and attach any hardware before checking top nuts for these structures. Check that top nuts meet the following torque requirements:

<b>TORQUE REQUIREMENTS</b>	
<b>Anchor Rod Diameter, inch</b>	<b>Requirement, ft-lb</b>
7/8	180
1	270
1 1/8	380
1 1/4	420
$\geq 1 \frac{1}{2}$	600

If necessary, retighten top nuts in the presence of the Engineer with a calibrated torque wrench to within  $\pm 10$  ft-lb of the required torque. Do not overtighten top nuts.

- (13) Do not grout under base plate.

### Measurement and Payment

Foundations and anchor rod assemblies for metal poles and upright trusses will be measured and paid for elsewhere in the contract.

No payment will be made for temporary casings that remain in drilled pier excavations. No payment will be made for PIT. No payment will be made for further investigation of defective piers. Further investigation of piers that are not defective will be paid as extra work in accordance with Article 104-7 of the *2018 Standard Specifications*. No payment will be made for remediation of unacceptable drilled piers or post repair testing.

**PORTLAND CEMENT CONCRETE PRODUCTION AND DELIVERY:**

(9-15-20)

1000, 1014, 1024

SP10 R01

Revise the 2018 Standard Specifications as follows:

Page 10-6, Table 1000-1, REQUIREMENTS FOR CONCRETE, replace with the following:

<b>TABLE 1000-1 REQUIREMENTS FOR CONCRETE</b>											
<b>Class of Concrete</b>	<b>Min. Compressive Strength at 28 days</b>	<b>Maximum Water-Cement Ratio</b>				<b>Consistency Maximum Slump</b>		<b>Cement Content</b>			
		<b>Air-Entrained Concrete</b>		<b>Non-Air- Entrained Concrete</b>		<b>Vibrated</b>	<b>Non- Vibrated</b>	<b>Vibrated</b>		<b>Non-Vibrated</b>	
		<b>Rounded Aggregate</b>	<b>Angular Aggregate</b>	<b>Rounded Aggregate</b>	<b>Angular Aggregate</b>			<b>Min.</b>	<b>Max.</b>	<b>Min.</b>	<b>Max.</b>
		<i>Units</i>	<i>psi</i>					<i>inch</i>	<i>inch</i>	<i>lb/cy</i>	<i>lb/cy</i>
AA	4500	0.381	0.426	---	---	3.5 <sup>A</sup>	---	639	715	---	---
AA Slip Form	4500	0.381	0.426	---	---	1.5	---	639	715	---	---
Drilled Pier	4500	---	---	0.450	0.450	---	5 - 7 dry  7 - 9 wet	---	---	640	800
A	3000	0.488	0.532	0.550	0.594	3.5 <sup>A</sup>	4.0	564	---	602	---
B	2500	0.488	0.567	0.559	0.630	1.5 machine placed  2.5 <sup>A</sup> hand placed	4.0	508	---	545	---
Sand Light- weight	4500	---	0.420	---	---	4.0 <sup>A</sup>	---	715	---	---	---
Latex Modified	3000 (at 7 days)	0.400	0.400	---	---	6.0	---	658	---	---	---
Flowable Fill excavatable	150 max. (at 56 days)	as needed	as needed	as needed	as needed	---	Flowable	---	---	40	100
Flowable Fill non- excavatable	125	as needed	as needed	as needed	as needed	---	Flowable	---	---	100	as needed
Pavement	4500 Design, field	0.559	0.559	---	---	1.5 slip form	---	526	---	---	---
	650 flexural, design only					3.0 hand placed					

Precast	See Table 1077-1	as needed	as needed	---	---	6.0	as needed	as needed	as needed	as needed	as needed
Prestressed	per contract	See Table 1078-1	See Table 1078-1	---	---	8.0	---	564	as needed	---	---

- A. The slump may be increased to 6 inches, provided the increase in slump is achieved by adding a chemical admixture conforming to Section 1024-3. In no case shall the water-cement ratio on the approved design be exceeded. Concrete exhibiting segregation and/or excessive bleeding will be rejected. Utilizing an Admixture to modify slump does not relinquish the contractor’s responsibility to ensure the final product quality and overall configuration meets design specifications. Caution should be taken when placing these modified mixes on steep grades to prevent unintended changes to the set slope.

**THERMOPLASTIC PAVEMENT MARKING MATERIAL – COLOR TESTING:**

3-19-19

1087

SP10 R05

Revise the *2018 Standard Specifications* as follows:

**Pages 10-183 and 10-184, Subarticle 1087-7(D)(1)(b) Yellow**, lines 9-11, delete and replace with the following:

Obtain Color Values Y,x,y per ASTM E1349 using C/2° illuminant/observer. Results shall be Y ≥ 45%, and x,y shall fall within PR#1 chart chromaticity limits.

**MATERIALS FOR PORTLAND CEMENT CONCRETE:**

(9-15-20)

1000, 1024

SP10 R24

Revise the *2018 Standard Specifications* as follows:

**Page 10-52, Article 1024-4, WATER, lines 3-6**, delete and replace with the following:  
 Test water from wells at all locations. Test public water supplies from all out of state locations and in the following counties: Beaufort, Bertie, Brunswick, Camden, Carteret, Chowan, Craven, Currituck, Dare, Gates, Hyde, New Hanover, Onslow, Pamlico, Pasquotank, Pender, Perquimans, Tyrell and Washington unless the Engineer waives the testing requirements.

**Page 10-52, Table 1024-2, PHYSICAL PROPERTIES OF WATER**, replace with the following:

Property	Requirement	Test Method
Compression Strength, minimum percent of control at 3 and 7 days	90%	ASTM C1602
Time of set, deviation from control	From 1:00 hr. earlier to 1:30 hr. later	ASTM C1602
pH	4.5 to 8.5	ASTM D1293 *
Chloride Ion Content, Max.	250 ppm	ASTM D512 *



Total Solids Content (Residue), Max.	1,000 ppm	SM 2540B *
Resistivity, Min.	0.500 kohm-cm	ASTM D1125 *

\*Denotes an alternate method is acceptable. Test method used shall be referenced in the test report.

**EXTRUDED THERMOPLASTIC PAVEMENT MARKING THICKNESS:**

3-19-19

1205

SP12 R05

Revise the *2018 Standard Specifications* as follows:

**Page 12-6, Subarticle 1205-4(A)(1) General, lines 5-8,** delete the second sentence and replace with the following:

Use application equipment that provides multiple width settings ranging from 4 inches to 12 inches and multiple thickness settings to achieve a minimum pavement marking thickness of 0.090 inch above the surface of the pavement.

**Page 12-7, Table 1205-3, THICKNESS REQUIREMENTS FOR THERMOPLASTIC,** replace with the following:

<b>TABLE 1205-3 MINIMUM THICKNESS REQUIREMENTS FOR THERMOPLASTIC</b>	
<b>Thickness</b>	<b>Location</b>
240 mils	In-lane and shoulder-transverse pavement markings (rumble strips). May be placed in 2 passes.
90 mils	Center lines, skip lines, transverse bands, mini-skip lines, characters, bike lane symbols, crosswalk lines, edge lines, gore lines, diagonals, and arrow symbols

**STANDARD SPECIAL PROVISION**  
**AVAILABILITY OF FUNDS – TERMINATION OF CONTRACTS**

(5-20-08)

Z-2

*General Statute 143C-6-11. (h) Highway Appropriation* is hereby incorporated verbatim in this contract as follows:

(h) Amounts Encumbered. – Transportation project appropriations may be encumbered in the amount of allotments made to the Department of Transportation by the Director for the estimated payments for transportation project contract work to be performed in the appropriation fiscal year. The allotments shall be multiyear allotments and shall be based on estimated revenues and shall be subject to the maximum contract authority contained in *General Statute 143C-6-11(c)*. Payment for transportation project work performed pursuant to contract in any fiscal year other than the current fiscal year is subject to appropriations by the General Assembly. Transportation project contracts shall contain a schedule of estimated completion progress, and any acceleration of this progress shall be subject to the approval of the Department of Transportation provided funds are available. The State reserves the right to terminate or suspend any transportation project contract, and any transportation project contract shall be so terminated or suspended if funds will not be available for payment of the work to be performed during that fiscal year pursuant to the contract. In the event of termination of any contract, the contractor shall be given a written notice of termination at least 60 days before completion of scheduled work for which funds are available. In the event of termination, the contractor shall be paid for the work already performed in accordance with the contract specifications.

Payment will be made on any contract terminated pursuant to the special provision in accordance with Subarticle 108-13(D) of the *2018 Standard Specifications*.

**STANDARD SPECIAL PROVISION****ERRATA**

(10-16-18) (Rev.2-16-21)

Z-4

Revise the *2018 Standard Specifications* as follows:

**Division 6**

**Page 6-7, Article 609-1 DESCRIPTION, line 29,** replace article number “609-10” with “609-9”.

**Division 7**

**Page 7-27, Article 725-1 MEASUREMENT AND PAYMENT, line 4,** replace article number “725-1” with “724-4”.

**Page 7-28, Article 725-1 MEASUREMENT AND PAYMENT, line 10,** replace article number “725-1” with “725-3”.

**Division 10**

**Page 10-78, Article 1056-4 GEOTEXTILES, TABLE 1056-1, Permittivity, Type 2,** replace “Table 6<sup>D</sup>” with “Table 7<sup>D</sup>” and **Permittivity, Type 3<sup>B</sup>,** replace “Table 7<sup>D</sup>” with “Table 8<sup>D</sup>”.

**Page 10-121, Article 1076-7, REPAIR OF GALVANIZING, line 8,** replace article number “1080-9” with “1080-7”.

**Page 10-162, Article 1080-50 PAINT FOR VERTICAL MARKERS, line 1,** replace article number “1080-50” with “1080-10”.

**Page 10-162, Article 1080-61 EPOXY RESIN FOR REINFORCING STEEL, line 5,** replace article number “1080-61” with “1080-11”.

**Page 10-162, Article 1080-72 ABRASIVE MATERIALS FOR BLAST CLEANING STEEL, line 22,** replace article number “1080-72” with “1080-12”.

**Page 10-163, Article 1080-83 FIELD PERFORMANCE AND SERVICES, line 25,** replace article number “1080-83” with “1080-13”.

**Division 17**

**Page 17-15, Article 1715-4 MEASUREMENT AND PAYMENT, lines 42-44,** replace the second sentence with the following:

An example is an installation of a single 1.25 inch HDPE conduit would be paid as:

Directional Drill (1)(1.25”) Linear Foot

**STANDARD SPECIAL PROVISION****PLANT AND PEST QUARANTINES****(Imported Fire Ant, Gypsy Moth, Witchweed, Emerald Ash Borer, Guava Root Knot Nematode, And Other Noxious Weeds)**

(3-18-03) (Rev. 5-21-19)

Z-04a

**Within Quarantined Area**

This project may be within a county regulated for plant and/or pests. If the project or any part of the Contractor's operations is located within a quarantined area, thoroughly clean all equipment prior to moving out of the quarantined area. Comply with federal/state regulations by obtaining a certificate or limited permit for any regulated article moving from the quarantined area.

**Originating in a Quarantined County**

Obtain a certificate or limited permit issued by the N.C. Department of Agriculture/United States Department of Agriculture. Have the certificate or limited permit accompany the article when it arrives at the project site.

**Contact**

Contact the N.C. Department of Agriculture/United States Department of Agriculture at 1-800-206-9333, 919-707-3730, or <https://www.ncagr.gov/plantindustry/Plant/quaran/table2.htm> to determine those specific project sites located in the quarantined area or for any regulated article used on this project originating in a quarantined county.

**Regulated Articles Include**

1. Soil, sand, gravel, compost, peat, humus, muck, and decomposed manure, separately or with other articles. This includes movement of articles listed above that may be associated with cut/waste, ditch pulling, and shoulder cutting.
2. Plants with roots including grass sod.
3. Plant crowns and roots.
4. Bulbs, corms, rhizomes, and tubers of ornamental plants.
5. Hay, straw, fodder, and plant litter of any kind.
6. Clearing and grubbing debris.
7. Used agricultural cultivating and harvesting equipment.
8. Used earth-moving equipment.
9. Any other products, articles, or means of conveyance, of any character, if determined by an inspector to present a hazard of spreading imported fire ant, gypsy moth, witchweed, emerald ash borer, guava root knot nematode, or other noxious weeds.

**STANDARD SPECIAL PROVISION****TITLE VI AND NONDISCRIMINATION:**

(6-28-77)(Rev 6/19/2018)

Z-6

Revise the *2018 Standard Specifications* as follows:

Replace Article 103-4(B) with the following:

The North Carolina Department of Transportation is committed to carrying out the U.S. Department of Transportation's policy of ensuring nondiscrimination in the award and administration of contracts.

The provisions of this section related to United States Department of Transportation (US DOT) Order 1050.2A, Title 49 Code of Federal Regulations (CFR) part 21, 23 United States Code (U.S.C.) 140 and 23 CFR part 200 (or 49 CFR 303, 49 U.S.C. 5332 or 49 U.S.C. 47123) are applicable to all North Carolina Department of Transportation (NCDOT) contracts and to all related subcontracts, material supply, engineering, architectural and other service contracts, regardless of dollar amount. Any Federal provision that is specifically required not specifically set forth is hereby incorporated by reference.

(1) **Title VI Assurances (USDOT Order 1050.2A, Appendix A)**

During the performance of this contract, the contractor, for itself, its assignees, and successors in interest (hereinafter referred to as the "contractor") agrees as follows:

(a) **Compliance with Regulations**

The contractor (hereinafter includes consultants) shall comply with the Acts and the Regulations relative to Nondiscrimination in Federally-assisted programs of the U.S. Department of Transportation, Federal Highway Administration (FHWA), as they may be amended from time to time, which are herein incorporated by reference and made a part of this contract.

(b) **Nondiscrimination**

The contractor, with regard to the work performed by it during the contract, shall not discriminate on the grounds of race, color, or national origin in the selection and retention of subcontractors, including procurements of materials and leases of equipment. The contractor shall not participate directly or indirectly in the discrimination prohibited by the Acts and the Regulations, including employment practices when the contract covers any activity, project, or program set forth in Appendix B of 49 CFR Part 21.

(c) **Solicitations for Subcontractors, Including Procurements of Materials and Equipment**

In all solicitations, either by competitive bidding, or negotiation made by the contractor for work to be performed under a subcontract, including procurements of materials, or leases of equipment, each potential subcontractor or supplier shall be notified by the contractor of the contractor's obligations under this contract and the Acts and the Regulations relative to Nondiscrimination on the grounds of race, color, or national origin.

(d) **Information and Reports**

The contractor shall provide all information and reports required by the Acts, the Regulations, and directives issued pursuant thereto and shall permit access to its books, records, accounts, other sources of information, and its facilities as may be determined by the Recipient or the FHWA to be pertinent to ascertain compliance with such Acts,

Regulations, and instructions. Where any information required of a contractor is in the exclusive possession of another who fails or refuses to furnish the information, the contractor shall so certify to the Recipient or the FHWA, as appropriate, and shall set forth what efforts it has made to obtain the information.

(e) Sanctions for Noncompliance:

In the event of a contractor's noncompliance with the Non-discrimination provisions of this contract, the Recipient will impose such contract sanctions as it and/or the FHWA may determine to be appropriate, including, but not limited to:

- (i) Withholding payments to the contractor under the contract until the contractor complies; and/or
- (ii) Cancelling, terminating, or suspending a contract, in whole or in part.

(f) Incorporation of Provisions

The contractor shall include the provisions of paragraphs (a) through (f) in every subcontract, including procurements of materials and leases of equipment, unless exempt by the Acts, the Regulations and directives issued pursuant thereto. The contractor shall take action with respect to any subcontract or procurement as the Recipient or the FHWA may direct as a means of enforcing such provisions including sanctions for noncompliance. Provided, that if the contractor becomes involved in, or is threatened with litigation by a subcontractor, or supplier because of such direction, the contractor may request the Recipient to enter into any litigation to protect the interests of the Recipient. In addition, the contractor may request the United States to enter into the litigation to protect the interests of the United States.

(2) **Title VI Nondiscrimination Program (23 CFR 200.5(p))**

The North Carolina Department of Transportation (NCDOT) has assured the USDOT that, as a condition to receiving federal financial assistance, NCDOT will comply with Title VI of the Civil Rights Act of 1964 and all requirements imposed by Title 49 CFR part 21 and related nondiscrimination authorities to ensure that no person shall, on the ground of race, color, national origin, limited English proficiency, sex, age, or disability (including religion/creed or income-level, where applicable), be excluded from participation in, be denied the benefits of, or be subjected to discrimination under any programs, activities, or services conducted or funded by NCDOT. Contractors and other organizations under contract or agreement with NCDOT must also comply with Title VI and related authorities, therefore:

(a) During the performance of this contract or agreement, contractors (e.g., subcontractors, consultants, vendors, prime contractors) are responsible for complying with NCDOT's Title VI Program. Contractors are not required to prepare or submit Title VI Programs. To comply with this section, the prime contractor shall:

1. Post NCDOT's Notice of Nondiscrimination and the Contractor's own Equal Employment Opportunity (EEO) Policy in conspicuous locations accessible to all employees, applicants and subcontractors on the jobsite.
2. Physically incorporate the required Title VI clauses into all subcontracts on federally-assisted and state-funded NCDOT projects, and ensure inclusion by subcontractors into all lower-tier subcontracts.
3. Required Solicitation Language. The Contractor shall include the following notification in all solicitations for bids and requests for work or material, regardless of funding source:

“The North Carolina Department of Transportation, in accordance with the provisions of Title VI of the Civil Rights Act of 1964 (78 Stat. 252, 42 U.S.C. §§

2000d to 2000d-4) and the Regulations, hereby notifies all bidders that it will affirmatively ensure that any contract entered into pursuant to this advertisement, disadvantaged business enterprises will be afforded full and fair opportunity to submit bids in response to this invitation and will not be discriminated against on the grounds of race, color, or national origin in consideration for an award. In accordance with other related nondiscrimination authorities, bidders and contractors will also not be discriminated against on the grounds of sex, age, disability, low-income level, creed/religion, or limited English proficiency in consideration for an award.”

4. Physically incorporate the FHWA-1273, in its entirety, into all subcontracts and subsequent lower tier subcontracts on Federal-aid highway construction contracts only.
  5. Provide language assistance services (i.e., written translation and oral interpretation), free of charge, to LEP employees and applicants. Contact NCDOT OCR for further assistance, if needed.
  6. For assistance with these Title VI requirements, contact the NCDOT Title VI Nondiscrimination Program at 1-800-522-0453.
- (b) Subrecipients (e.g. cities, counties, LGAs, planning organizations) may be required to prepare and submit a Title VI Plan to NCDOT, including Title VI Assurances and/or agreements. Subrecipients must also ensure compliance by their contractors and subrecipients with Title VI. (23 CFR 200.9(b)(7))
- (c) If reviewed or investigated by NCDOT, the contractor or subrecipient agrees to take affirmative action to correct any deficiencies found within a reasonable time period, not to exceed 90 calendar days, unless additional time is granted by NCDOT. (23 CFR 200.9(b)(15))
- (d) The Contractor is responsible for notifying subcontractors of NCDOT’s External Discrimination Complaints Process.
1. Applicability  
Title VI and related laws protect participants and beneficiaries (e.g., members of the public and contractors) from discrimination by NCDOT employees, subrecipients and contractors, regardless of funding source.
  2. Eligibility  
Any person—or class of persons—who believes he/she has been subjected to discrimination based on race, color, national origin, Limited English Proficiency (LEP), sex, age, or disability (and religion in the context of employment, aviation, or transit) may file a written complaint. The law also prohibits intimidation or retaliation of any sort.
  3. Time Limits and Filing Options  
Complaints may be filed by the affected individual(s) or a representative and must be filed no later than 180 calendar days after the following:
    - (i) The date of the alleged act of discrimination; or
    - (ii) The date when the person(s) became aware of the alleged discrimination; or
    - (iii) Where there has been a continuing course of conduct, the date on which that conduct was discontinued or the latest instance of the conduct.Title VI and related discrimination complaints may be submitted to the following entities:

- North Carolina Department of Transportation, Office of Civil Rights, Title VI Program, 1511 Mail Service Center, Raleigh, NC 27699-1511; toll free 1-800-522-0453
  - Federal Highway Administration, North Carolina Division Office, 310 New Bern Avenue, Suite 410, Raleigh, NC 27601, 919-747-7010
  - US Department of Transportation, Departmental Office of Civil Rights, External Civil Rights Programs Division, 1200 New Jersey Avenue, SE, Washington, DC 20590; 202-366-4070
4. Format for Complaints  
Complaints must be in writing and signed by the complainant(s) or a representative, and include the complainant's name, address, and telephone number. Complaints received by fax or e-mail will be acknowledged and processed. Allegations received by telephone will be reduced to writing and provided to the complainant for confirmation or revision before processing. Complaints will be accepted in other languages, including Braille.
5. Discrimination Complaint Form  
Contact NCDOT Civil Rights to receive a full copy of the Discrimination Complaint Form and procedures.
6. Complaint Basis  
Allegations must be based on issues involving race, color, national origin (LEP), sex, age, disability, or religion (in the context of employment, aviation or transit). "Basis" refers to the complainant's membership in a protected group category.

**TABLE 103-1  
COMPLAINT BASIS**

Protected Categories	Definition	Examples	Applicable Nondiscrimination Authorities
Race and Ethnicity	An individual belonging to one of the accepted racial groups; or the perception, based usually on physical characteristics that a person is a member of a racial group	Black/African American, Hispanic/Latino, Asian, American Indian/Alaska Native, Native Hawaiian/Pacific Islander, White	Title VI of the Civil Rights Act of 1964; 49 CFR Part 21; 23 CFR 200; 49 U.S.C. 5332(b); 49 U.S.C. 47123. ( <i>Executive Order 13166</i> )
Color	Color of skin, including shade of skin within a racial group	Black, White, brown, yellow, etc.	
National Origin ( <i>Limited English Proficiency</i> )	Place of birth. Citizenship is not a factor. ( <i>Discrimination based on language or a person's accent is also covered</i> )	Mexican, Cuban, Japanese, Vietnamese, Chinese	
Sex	Gender. The sex of an individual. <i>Note: Sex under this program does not include sexual orientation.</i>	Women and Men	1973 Federal-Aid Highway Act; 49 U.S.C. 5332(b); 49 U.S.C. 47123.
Age	Persons of any age	21-year-old person	Age Discrimination Act of 1975 49 U.S.C. 5332(b); 49 U.S.C. 47123.
Disability	Physical or mental impairment, permanent or temporary, or perceived.	Blind, alcoholic, para-amputee, epileptic, diabetic, arthritic	Section 504 of the Rehabilitation Act of 1973; Americans with Disabilities Act of 1990



<p>Religion (in the context of employment) <i>(Religion/ Creed in all aspects of any aviation or transit-related construction)</i></p>	<p>An individual belonging to a religious group; or the perception, based on distinguishable characteristics that a person is a member of a religious group. In practice, actions taken as a result of the moral and ethical beliefs as to what is right and wrong, which are sincerely held with the strength of traditional religious views. <b>Note:</b> Does not have to be associated with a recognized religious group or church; if an individual sincerely holds to the belief, it is a protected religious practice.</p>	<p>Muslim, Christian, Sikh, Hindu, etc.</p>	<p>Title VII of the Civil Rights Act of 1964; 23 CFR 230; FHWA-1273 Required Contract Provisions. <i>(49 U.S.C. 5332(b); 49 U.S.C. 47123)</i></p>
--	---	---	---

### (3) Pertinent Nondiscrimination Authorities

During the performance of this contract, the contractor, for itself, its assignees, and successors in interest agrees to comply with the following non-discrimination statutes and authorities, including, but not limited to:

- (a) Title VI of the Civil Rights Act of 1964 (42 U.S.C. § 2000d et seq., 78 stat. 252), (prohibits discrimination on the basis of race, color, national origin); and 49 CFR Part 21.
- (b) The Uniform Relocation Assistance and Real Property Acquisition Policies Act of 1970, (42 U.S.C. § 4601), (prohibits unfair treatment of persons displaced or whose property has been acquired because of Federal or Federal-aid programs and projects);
- (c) Federal-Aid Highway Act of 1973, (23 U.S.C. § 324 et seq.), (prohibits discrimination on the basis of sex);
- (d) Section 504 of the Rehabilitation Act of 1973, (29 U.S.C. § 794 et seq.), as amended, (prohibits discrimination on the basis of disability) and 49 CFR Part 27;
- (e) The Age Discrimination Act of 1975, as amended, (42 U.S.C. § 6101 et seq.), (prohibits discrimination on the basis of age);
- (f) Airport and Airway Improvement Act of 1982, (49 USC § 471, Section 47123), as amended, (prohibits discrimination based on race, creed, color, national origin, or sex);
- (g) The Civil Rights Restoration Act of 1987, (PL 100-209), (Broadened the scope, coverage and applicability of Title VI of the Civil Rights Act of 1964, The Age Discrimination Act of 1975 and Section 504 of the Rehabilitation Act of 1973, by expanding the definition of the terms "programs or activities" to include all of the programs or activities of the Federal-aid recipients, sub-recipients and contractors, whether such programs or activities are Federally funded or not);
- (h) Titles II and III of the Americans with Disabilities Act, which prohibit discrimination on the basis of disability in the operation of public entities, public and private transportation systems, places of public accommodation, and certain testing entities (42 U.S.C. §§ 12131-12189) as implemented by Department of Transportation regulations at 49 C.F.R. parts 37 and 38;
- (i) The Federal Aviation Administration's Nondiscrimination statute (49 U.S.C. § 47123) (prohibits discrimination on the basis of race, color, national origin, and sex);
- (j) Executive Order 12898, Federal Actions to Address Environmental Justice in Minority Populations and Low-Income Populations, which ensures Nondiscrimination against minority populations by discouraging programs, policies, and activities with

- disproportionately high and adverse human health or environmental effects on minority and low-income populations;
- (k) Executive Order 13166, Improving Access to Services for Persons with Limited English Proficiency, and resulting agency guidance, national origin discrimination includes discrimination because of Limited English proficiency (LEP). To ensure compliance with Title VI, you must take reasonable steps to ensure that LEP persons have meaningful access to your programs (70 Fed. Reg. at 74087 to 74100);
  - (l) Title IX of the Education Amendments of 1972, as amended, which prohibits you from discriminating because of sex in education programs or activities (20 U.S.C. 1681 et seq).
  - (m) Title VII of the Civil Rights Act of 1964 (42 U.S.C. § 2000e et seq., Pub. L. 88-352), (prohibits employment discrimination on the basis of race, color, religion, sex, or national origin).
- (4) **Additional Title VI Assurances**

*\*\*The following Title VI Assurances (Appendices B, C and D) shall apply, as applicable*

- (a) Clauses for Deeds Transferring United States Property (1050.2A, Appendix B)  
The following clauses will be included in deeds effecting or recording the transfer of real property, structures, or improvements thereon, or granting interest therein from the United States pursuant to the provisions of Assurance 4.

NOW, THEREFORE, the U.S. Department of Transportation as authorized by law and upon the condition that the North Carolina Department of Transportation (NCDOT) will accept title to the lands and maintain the project constructed thereon in accordance with the North Carolina General Assembly, the Regulations for the Administration of the Federal-Aid Highway Program, and the policies and procedures prescribed by the Federal Highway Administration of the U.S. Department of Transportation in accordance and in compliance with all requirements imposed by Title 49, Code of Federal Regulations, U.S. Department of Transportation, Subtitle A, Office of the Secretary, Part 21, Nondiscrimination in Federally-assisted programs of the U.S. Department of Transportation pertaining to and effectuating the provisions of Title VI of the Civil Rights Act of 1964 (78 Stat. 252; 42 U.S.C. § 2000d to 2000d-4), does hereby remise, release, quitclaim and convey unto the NCDOT all the right, title and interest of the U.S. Department of Transportation in and to said lands described in Exhibit A attached hereto and made a part hereof.

(HABENDUM CLAUSE)

TO HAVE AND TO HOLD said lands and interests therein unto the North Carolina Department of Transportation (NCDOT) and its successors forever, subject, however, to the covenants, conditions, restrictions and reservations herein contained as follows, which will remain in effect for the period during which the real property or structures are used for a purpose for which Federal financial assistance is extended or for another purpose involving the provision of similar services or benefits and will be binding on the NCDOT, its successors and assigns.

The NCDOT, in consideration of the conveyance of said lands and interests in lands, does hereby covenant and agree as a covenant running with the land for itself, its successors and assigns, that (1) no person will on the grounds of race, color, or national origin, be excluded from participation in, be denied the benefits of, or be otherwise subjected to discrimination with regard to any facility located wholly or in part on, over, or under such lands hereby conveyed [,] [and]\* (2) that the NCDOT will use the lands and interests in lands and interests in lands so conveyed, in compliance with all requirements imposed by or pursuant to Title 49, Code of Federal Regulations, U.S. Department of Transportation, Subtitle A, Office of the Secretary, Part 21, Non-discrimination in Federally-assisted programs of the U.S. Department of Transportation, Effectuation of Title VI of the Civil Rights Act of 1964, and as said Regulations and Acts may be amended [, and (3) that in the event of breach of any of the above-mentioned nondiscrimination conditions, the Department will have a right to enter or re-enter said lands and facilities on said land, and that above described land and facilities will thereon revert to and vest in and become the absolute property of the U.S. Department of Transportation and its assigns as such interest existed prior to this instruction].\*

(\*Reverter clause and related language to be used only when it is determined that such a clause is necessary in order to make clear the purpose of Title VI.)

(b) Clauses for Transfer of Real Property Acquired or Improved Under the Activity, Facility, or Program (1050.2A, Appendix C)

The following clauses will be included in deeds, licenses, leases, permits, or similar instruments entered into by the North Carolina Department of Transportation (NCDOT) pursuant to the provisions of Assurance 7(a):

1. The (grantee, lessee, permittee, etc. as appropriate) for himself/herself, his/her heirs, personal representatives, successors in interest, and assigns, as a part of the consideration hereof, does hereby covenant and agree [in the case of deeds and leases add "as a covenant running with the land"] that:
  - (i.) In the event facilities are constructed, maintained, or otherwise operated on the property described in this (deed, license, lease, permit, etc.) for a purpose for which a U.S. Department of Transportation activity, facility, or program is extended or for another purpose involving the provision of similar services or benefits, the (grantee, licensee, lessee, permittee, etc.) will maintain and operate such facilities and services in compliance with all requirements imposed by the Acts and Regulations (as may be amended) such that no person on the grounds of race, color, or national origin, will be excluded from participation in, denied the benefits of, or be otherwise subjected to discrimination in the use of said facilities.
2. With respect to licenses, leases, permits, etc., in the event of breach of any of the above Nondiscrimination covenants, the NCDOT will have the right to terminate the (lease, license, permit, etc.) and to enter, re-enter, and repossess said lands and facilities thereon, and hold the same as if the (lease, license, permit, etc.) had never been made or issued. \*
3. With respect to a deed, in the event of breach of any of the above Nondiscrimination covenants, the NCDOT will have the right to enter or re-enter the lands and facilities thereon, and the above described lands and facilities will there upon revert to and vest in and become the absolute property of the NCDOT and its assigns. \*

- (\*Reverter clause and related language to be used only when it is determined that such a clause is necessary to make clear the purpose of Title VI.)
- (c) Clauses for Construction/Use/Access to Real Property Acquired Under the Activity, Facility or Program (1050.2A, Appendix D)

The following clauses will be included in deeds, licenses, permits, or similar instruments/ agreements entered into by the North Carolina Department of Transportation (NCDOT) pursuant to the provisions of Assurance 7(b):

1. The (grantee, licensee, permittee, etc., as appropriate) for himself/herself, his/her heirs, personal representatives, successors in interest, and assigns, as a part of the consideration hereof, does hereby covenant and agree (in the case of deeds and leases add, "as a covenant running with the land") that (1) no person on the ground of race, color, or national origin, will be excluded from participation in, denied the benefits of, or be otherwise subjected to discrimination in the use of said facilities, (2) that in the construction of any improvements on, over, or under such land, and the furnishing of services thereon, no person on the ground of race, color, or national origin, will be excluded from participation in, denied the benefits of, or otherwise be subjected to discrimination, (3) that the (grantee, licensee, lessee, permittee, etc.) will use the premises in compliance with all other requirements imposed by or pursuant to the Acts and Regulations, as amended, set forth in this Assurance.
2. With respect to (licenses, leases, permits, etc.), in the event of breach of any of the above Non-discrimination covenants, the NCDOT will have the right to terminate the (license, permit, etc., as appropriate) and to enter or re-enter and repossess said land and the facilities thereon, and hold the same as if said (license, permit, etc., as appropriate) had never been made or issued. \*
3. With respect to deeds, in the event of breach of any of the above Nondiscrimination covenants, the NCDOT will there upon revert to and vest in and become the absolute property of the NCDOT and its assigns. \*

(\*Reverter clause and related language to be used only when it is determined that such a clause is necessary to make clear the purpose of Title VI.)

**STANDARD SPECIAL PROVISION****MINORITY AND FEMALE EMPLOYMENT REQUIREMENTS**

Z-7

**NOTICE OF REQUIREMENTS FOR AFFIRMATIVE ACTION TO ENSURE EQUAL EMPLOYMENT OPPORTUNITY (*EXECUTIVE NUMBER 11246*)**

1. The goals and timetables for minority and female participation, expressed in percentage terms for the Contractor's aggregate workforce in each trade on all construction work in the covered area, see as shown on the attached sheet entitled "Employment Goals for Minority and Female participation".

These goals are applicable to all the Contractor's construction work (whether or not it is Federal or federally assisted) performed in the covered area. If the Contractor performs construction work in a geographical area located outside of the covered area, it shall apply the goals established for such geographical area where the work is actually performed. With regard to this second area, the Contractor also is subject to the goals for both its federally involved and nonfederally involved construction.

The Contractor's compliance with the Executive Order and the regulations in *41 CFR Part 60-4* shall be based on its implementation of the Equal Opportunity Clause, specific affirmative action obligations required by the specifications set forth in *41 CFR 60-4.3(a)*, and its effort to meet the goals. The hours of minority and female employment and training must be substantially uniform throughout the length of the contract, and in each trade and the Contractor shall make a good faith effort to employ minorities and women evenly on each of its projects. The transfer of minority or female employees or trainees from Contractor to Contractor or from project to project for the sole purpose of meeting the Contractor's goals shall be a violation of the contract, the executive Order and the regulations in *41 CFR Part 60-4*. Compliance with the goals will be measured against the total work hours performed.

2. As used in this Notice and in the contract resulting from this solicitation, the "covered area" is the county or counties shown on the cover sheet of the proposal form and contract.

**EMPLOYMENT GOALS FOR MINORITY  
AND FEMALE PARTICIPATION**

Economic Areas

**Area 023 29.7%**

Bertie County  
Camden County  
Chowan County  
Gates County  
Hertford County  
Pasquotank County  
Perquimans County

**Area 024 31.7%**

Beaufort County  
Carteret County  
Craven County  
Dare County  
Edgecombe County  
Green County  
Halifax County  
Hyde County  
Jones County  
Lenoir County  
Martin County  
Nash County  
Northampton County  
Pamlico County  
Pitt County  
Tyrrell County  
Washington County  
Wayne County  
Wilson County

**Area 025 23.5%**

Columbus County  
Duplin County  
Onslow County  
Pender County

**Area 026 33.5%**

Bladen County  
Hoke County  
Richmond County  
Robeson County  
Sampson County  
Scotland County

**Area 027 24.7%**

Chatham County  
Franklin County  
Granville County  
Harnett County  
Johnston County  
Lee County  
Person County  
Vance County  
Warren County

**Area 028 15.5%**

Alleghany County  
Ashe County  
Caswell County  
Davie County  
Montgomery County  
Moore County  
Rockingham County  
Surry County  
Watauga County  
Wilkes County

**Area 029 15.7%**

Alexander County  
Anson County  
Burke County  
Cabarrus County  
Caldwell County  
Catawba County  
Cleveland County  
Iredell County  
Lincoln County  
Polk County  
Rowan County  
Rutherford County  
Stanly County

**Area 0480 8.5%**

Buncombe County  
Madison County

**Area 030 6.3%**

Avery County  
Cherokee County  
Clay County  
Graham County  
Haywood County  
Henderson County  
Jackson County  
McDowell County  
Macon County  
Mitchell County  
Swain County  
Transylvania County  
Yancey County

**SMSA Areas**

**Area 5720 26.6%**

Currituck County

**Area 9200 20.7%**

Brunswick County

New Hanover County

**Area 2560 24.2%**

Cumberland County

**Area 6640 22.8%**

Durham County

Orange County

Wake County

**Area 1300 16.2%**

Alamance County

**Area 3120 16.4%**

Davidson County

Forsyth County

Guilford County

Randolph County

Stokes County

Yadkin County

**Area 1520 18.3%**

Gaston County

Mecklenburg County

Union County

---

**Goals for Female**

**Participation in Each Trade**

(Statewide) 6.9%

**STANDARD SPECIAL PROVISION****REQUIRED CONTRACT PROVISIONS FEDERAL - AID  
CONSTRUCTION CONTRACTS**

FHWA - 1273 Electronic Version - May 1, 2012

Z-8

- I. General
- II. Nondiscrimination
- III. Nonsegregated Facilities
- IV. Davis-Bacon and Related Act Provisions
- V. Contract Work Hours and Safety Standards Act Provisions
- VI. Subletting or Assigning the Contract
- VII. Safety: Accident Prevention
- VIII. False Statements Concerning Highway Projects
- IX. Implementation of Clean Air Act and Federal Water Pollution Control Act
- X. Compliance with Governmentwide Suspension and Debarment Requirements
- XI. Certification Regarding Use of Contract Funds for Lobbying

**ATTACHMENTS**

- A. Employment and Materials Preference for Appalachian Development Highway System or Appalachian Local Access Road Contracts (included in Appalachian contracts only)

**I. GENERAL**

1. Form FHWA-1273 must be physically incorporated in each construction contract funded under Title 23 (excluding emergency contracts solely intended for debris removal). The contractor (or subcontractor) must insert this form in each subcontract and further require its inclusion in all lower tier subcontracts (excluding purchase orders, rental agreements and other agreements for supplies or services).

The applicable requirements of Form FHWA-1273 are incorporated by reference for work done under any purchase order, rental agreement or agreement for other services. The prime contractor shall be responsible for compliance by any subcontractor, lower-tier subcontractor or service provider.

Form FHWA-1273 must be included in all Federal-aid design-build contracts, in all subcontracts and in lower tier subcontracts (excluding subcontracts for design services, purchase orders, rental agreements and other agreements for supplies or services). The design-builder shall be responsible for compliance by any subcontractor, lower-tier subcontractor or service provider.

Contracting agencies may reference Form FHWA-1273 in bid proposal or request for proposal documents, however, the Form FHWA-1273 must be physically incorporated (not referenced) in all contracts, subcontracts and lower-tier subcontracts (excluding purchase orders, rental agreements and other agreements for supplies or services related to a construction contract).

2. Subject to the applicability criteria noted in the following sections, these contract provisions shall apply to all work performed on the contract by the contractor's own organization and with the assistance of workers under the contractor's immediate superintendence and to all work performed on the contract by piecework, station work, or by subcontract.
3. A breach of any of the stipulations contained in these Required Contract Provisions may be sufficient grounds for withholding of progress payments, withholding of final payment, termination of the contract, suspension / debarment or any other action determined to be appropriate by the contracting agency and FHWA.
4. Selection of Labor: During the performance of this contract, the contractor shall not use convict labor for any purpose within the limits of a construction project on a Federal-aid highway unless it is labor performed by convicts who are on parole, supervised release, or probation. The term Federal-aid highway does not include roadways functionally classified as local roads or rural minor collectors.

**II. NONDISCRIMINATION**

The provisions of this section related to 23 CFR Part 230 are applicable to all Federal-aid construction contracts and to all related construction subcontracts of \$10,000 or more. The provisions of 23 CFR Part 230 are not applicable to material supply, engineering, or architectural service contracts.

In addition, the contractor and all subcontractors must comply with the following policies: Executive Order 11246, 41 CFR 60, 29 CFR 1625-1627, Title 23 USC Section 140, the Rehabilitation Act of 1973, as amended (29 USC 794), Title VI of the Civil Rights Act of 1964, as amended, and related regulations including 49 CFR Parts 21, 26 and 27; and 23 CFR Parts 200, 230, and 633.

The contractor and all subcontractors must comply with: the requirements of the Equal Opportunity Clause in 41 CFR 60-1.4(b) and, for all construction contracts exceeding \$10,000, the Standard Federal Equal Employment Opportunity Construction Contract Specifications in 41 CFR 60-4.3.

Note: The U.S. Department of Labor has exclusive authority to determine compliance with Executive Order 11246 and the policies of the Secretary of Labor including 41 CFR 60, and 29 CFR 1625-1627. The contracting agency and the FHWA have the authority and the responsibility to ensure compliance with Title 23 USC Section 140, the Rehabilitation Act of 1973, as amended (29 USC 794), and Title VI of the Civil Rights Act of 1964, as amended, and related regulations including 49 CFR Parts 21, 26 and 27; and 23 CFR Parts 200, 230, and 633.

The following provision is adopted from 23 CFR 230, Appendix A, with appropriate revisions to conform to the U.S. Department of Labor (US DOL) and FHWA requirements.

1. **Equal Employment Opportunity:** Equal employment opportunity (EEO) requirements not to discriminate and to take affirmative action to assure equal opportunity as set forth under laws, executive orders, rules, regulations (28 CFR 35, 29 CFR 1630, 29 CFR 1625-1627, 41 CFR 60 and 49 CFR 27) and orders of the Secretary of Labor as modified by the provisions prescribed herein, and imposed pursuant to 23 U.S.C. 140 shall constitute the EEO and specific affirmative action standards for the contractor's project activities under this contract. The provisions of the Americans with Disabilities Act of 1990 (42 U.S.C. 12101 et seq.) set forth under 28 CFR 35 and 29 CFR 1630 are incorporated by reference in this contract. In the execution of this contract, the contractor agrees to comply with the following minimum specific requirement activities of EEO:
  - a. The contractor will work with the contracting agency and the Federal Government to ensure that it has made every good faith effort to provide equal opportunity with respect to all of its terms and conditions of employment and in their review of activities under the contract.



- b. The contractor will accept as its operating policy the following statement:  
"It is the policy of this Company to assure that applicants are employed, and that employees are treated during employment, without regard to their race, religion, sex, color, national origin, age or disability. Such action shall include: employment, upgrading, demotion, or transfer; recruitment or recruitment advertising; layoff or termination; rates of pay or other forms of compensation; and selection for training, including apprenticeship, pre-apprenticeship, and/or on-the-job training."
2. **EEO Officer:** The contractor will designate and make known to the contracting officers an EEO Officer who will have the responsibility for and must be capable of effectively administering and promoting an active EEO program and who must be assigned adequate authority and responsibility to do so.
3. **Dissemination of Policy:** All members of the contractor's staff who are authorized to hire, supervise, promote, and discharge employees, or who recommend such action, or who are substantially involved in such action, will be made fully cognizant of, and will implement, the contractor's EEO policy and contractual responsibilities to provide EEO in each grade and classification of employment. To ensure that the above agreement will be met, the following actions will be taken as a minimum:
  - a. Periodic meetings of supervisory and personnel office employees will be conducted before the start of work and then not less often than once every six months, at which time the contractor's EEO policy and its implementation will be reviewed and explained. The meetings will be conducted by the EEO Officer.
  - b. All new supervisory or personnel office employees will be given a thorough indoctrination by the EEO Officer, covering all major aspects of the contractor's EEO obligations within thirty days following their reporting for duty with the contractor.
  - c. All personnel who are engaged in direct recruitment for the project will be instructed by the EEO Officer in the contractor's procedures for locating and hiring minorities and women.
  - d. Notices and posters setting forth the contractor's EEO policy will be placed in areas readily accessible to employees, applicants for employment and potential employees.
  - e. The contractor's EEO policy and the procedures to implement such policy will be brought to the attention of employees by means of meetings, employee handbooks, or other appropriate means.
4. **Recruitment:** When advertising for employees, the contractor will include in all advertisements for employees the notation: "An Equal Opportunity Employer." All such advertisements will be placed in publications having a large circulation among minorities and women in the area from which the project work force would normally be derived.
  - a. The contractor will, unless precluded by a valid bargaining agreement, conduct systematic and direct recruitment through public and private employee referral sources likely to yield qualified minorities and women. To meet this requirement, the contractor will identify sources of potential minority group employees, and establish with such identified sources procedures whereby minority and women applicants may be referred to the contractor for employment consideration.
  - b. In the event the contractor has a valid bargaining agreement providing for exclusive hiring hall referrals, the contractor is expected to observe the provisions of that agreement to the extent that the system meets the contractor's compliance with EEO contract provisions. Where implementation of such an agreement has the effect of discriminating against minorities or women, or obligates the contractor to do the same, such implementation violates Federal nondiscrimination provisions.
  - c. The contractor will encourage its present employees to refer minorities and women as applicants for employment. Information and procedures with regard to referring such applicants will be discussed with employees.
5. **Personnel Actions:** Wages, working conditions, and employee benefits shall be established and administered, and personnel actions of every type, including hiring, upgrading, promotion, transfer, demotion, layoff, and termination, shall be taken without regard to race, color, religion, sex, national origin, age or disability. The following procedures shall be followed:
  - a. The contractor will conduct periodic inspections of project sites to insure that working conditions and employee facilities do not indicate discriminatory treatment of project site personnel.
  - b. The contractor will periodically evaluate the spread of wages paid within each classification to determine any evidence of discriminatory wage practices.
  - c. The contractor will periodically review selected personnel actions in depth to determine whether there is evidence of discrimination. Where evidence is found, the contractor will promptly take corrective action. If the review indicates that the discrimination may extend beyond the actions reviewed, such corrective action shall include all affected persons.
  - d. The contractor will promptly investigate all complaints of alleged discrimination made to the contractor in connection with its obligations under this contract, will attempt to resolve such complaints, and will take appropriate corrective action within a reasonable time. If the investigation indicates that the discrimination may affect persons other than the complainant, such corrective action shall include such other persons. Upon completion of each investigation, the contractor will inform every complainant of all of their avenues of appeal.
6. **Training and Promotion:**
  - a. The contractor will assist in locating, qualifying, and increasing the skills of minorities and women who are applicants for employment or current employees. Such efforts should be aimed at developing full journey level status employees in the type of trade or job classification involved.
  - b. Consistent with the contractor's work force requirements and as permissible under Federal and State regulations, the contractor shall make full use of training programs, i.e., apprenticeship, and on-the-job training programs for the geographical area of contract performance. In the event a special provision for training is provided under this contract, this subparagraph will be superseded as indicated in the special provision. The contracting agency may reserve training positions for persons who receive welfare assistance in accordance with 23 U.S.C. 140(a).
  - c. The contractor will advise employees and applicants for employment of available training programs and entrance requirements for each.
  - d. The contractor will periodically review the training and promotion potential of employees who are minorities and women and will encourage eligible employees to apply for such training and promotion.
7. **Unions:** If the contractor relies in whole or in part upon unions as a source of employees, the contractor will use good faith efforts to obtain the cooperation of such unions to increase opportunities for minorities and women. Actions by the contractor, either directly or through a contractor's association acting as agent, will include the procedures set forth below:
  - a. The contractor will use good faith efforts to develop, in cooperation with the unions, joint training programs aimed toward qualifying more minorities and women for membership in the unions and increasing the skills of minorities and women so that they may qualify for higher paying employment.
  - b. The contractor will use good faith efforts to incorporate an EEO clause into each union agreement to the end that such union will be contractually bound to refer applicants without regard to their race, color, religion, sex, national origin, age or disability.
  - c. The contractor is to obtain information as to the referral practices and policies of the labor union except that to the extent such information is within the exclusive possession of the labor union and such labor union refuses to furnish such information to the contractor, the contractor shall so certify to the contracting agency and shall set forth what efforts have been made to obtain such information.

- d. In the event the union is unable to provide the contractor with a reasonable flow of referrals within the time limit set forth in the collective bargaining agreement, the contractor will, through independent recruitment efforts, fill the employment vacancies without regard to race, color, religion, sex, national origin, age or disability; making full efforts to obtain qualified and/or qualifiable minorities and women. The failure of a union to provide sufficient referrals (even though it is obligated to provide exclusive referrals under the terms of a collective bargaining agreement) does not relieve the contractor from the requirements of this paragraph. In the event the union referral practice prevents the contractor from meeting the obligations pursuant to Executive Order 11246, as amended, and these special provisions, such contractor shall immediately notify the contracting agency.
8. **Reasonable Accommodation for Applicants / Employees with Disabilities:** The contractor must be familiar with the requirements for and comply with the Americans with Disabilities Act and all rules and regulations established there under. Employers must provide reasonable accommodation in all employment activities unless to do so would cause an undue hardship.
9. **Selection of Subcontractors, Procurement of Materials and Leasing of Equipment:** The contractor shall not discriminate on the grounds of race, color, religion, sex, national origin, age or disability in the selection and retention of subcontractors, including procurement of materials and leases of equipment. The contractor shall take all necessary and reasonable steps to ensure nondiscrimination in the administration of this contract.
- a. The contractor shall notify all potential subcontractors and suppliers and lessors of their EEO obligations under this contract.
- b. The contractor will use good faith efforts to ensure subcontractor compliance with their EEO obligations.
10. **Assurance Required by 49 CFR 26.13(b):**
- a. The requirements of 49 CFR Part 26 and the State DOT's U.S. DOT-approved DBE program are incorporated by reference.
- b. The contractor or subcontractor shall not discriminate on the basis of race, color, national origin, or sex in the performance of this contract. The contractor shall carry out applicable requirements of 49 CFR Part 26 in the award and administration of DOT-assisted contracts. Failure by the contractor to carry out these requirements is a material breach of this contract, which may result in the termination of this contract or such other remedy as the contracting agency deems appropriate.
11. **Records and Reports:** The contractor shall keep such records as necessary to document compliance with the EEO requirements. Such records shall be retained for a period of three years following the date of the final payment to the contractor for all contract work and shall be available at reasonable times and places for inspection by authorized representatives of the contracting agency and the FHWA.
- a. The records kept by the contractor shall document the following:
- (1) The number and work hours of minority and non-minority group members and women employed in each work classification on the project;
- (2) The progress and efforts being made in cooperation with unions, when applicable, to increase employment opportunities for minorities and women; and
- (3) The progress and efforts being made in locating, hiring, training, qualifying, and upgrading minorities and women;
- b. The contractors and subcontractors will submit an annual report to the contracting agency each July for the duration of the project, indicating the number of minority, women, and non-minority group employees currently engaged in each work classification required by the contract work. This information is to be reported on Form FHWA-1391. The staffing data should represent the project work force on board in all or any part of the last payroll period preceding the end of July. If on-the-job training is being required by special provision, the contractor will be required to collect and report training data. The employment data should reflect the work force on board during all or any part of the last payroll period preceding the end of July.

### III. NONSEGREGATED FACILITIES

This provision is applicable to all Federal-aid construction contracts and to all related construction subcontracts of \$10,000 or more.

The contractor must ensure that facilities provided for employees are provided in such a manner that segregation on the basis of race, color, religion, sex, or national origin cannot result. The contractor may neither require such segregated use by written or oral policies nor tolerate such use by employee custom. The contractor's obligation extends further to ensure that its employees are not assigned to perform their services at any location, under the contractor's control, where the facilities are segregated. The term "facilities" includes waiting rooms, work areas, restaurants and other eating areas, time clocks, restrooms, washrooms, locker rooms, and other storage or dressing areas, parking lots, drinking fountains, recreation or entertainment areas, transportation, and housing provided for employees. The contractor shall provide separate or single-user restrooms and necessary dressing or sleeping areas to assure privacy between sexes.

### IV. DAVIS-BACON AND RELATED ACT PROVISIONS

This section is applicable to all Federal-aid construction projects exceeding \$2,000 and to all related subcontracts and lower-tier subcontracts (regardless of subcontract size). The requirements apply to all projects located within the right-of-way of a roadway that is functionally classified as Federal-aid highway. This excludes roadways functionally classified as local roads or rural minor collectors, which are exempt. Contracting agencies may elect to apply these requirements to other projects.

The following provisions are from the U.S. Department of Labor regulations in 29 CFR 5.5 "Contract provisions and related matters" with minor revisions to conform to the FHWA-1273 format and FHWA program requirements.

#### 1. Minimum wages

- a. All laborers and mechanics employed or working upon the site of the work, will be paid unconditionally and not less often than once a week, and without subsequent deduction or rebate on any account (except such payroll deductions as are permitted by regulations issued by the Secretary of Labor under the Copeland Act (29 CFR part 3)), the full amount of wages and bona fide fringe benefits (or cash equivalents thereof) due at time of payment computed at rates not less than those contained in the wage determination of the Secretary of Labor which is attached hereto and made a part hereof, regardless of any contractual relationship which may be alleged to exist between the contractor and such laborers and mechanics.

Contributions made or costs reasonably anticipated for bona fide fringe benefits under section 1(b)(2) of the Davis-Bacon Act on behalf of laborers or mechanics are considered wages paid to such laborers or mechanics, subject to the provisions of paragraph 1.d. of this section; also, regular contributions made or costs incurred for more than a weekly period (but not less often than quarterly) under plans, funds, or programs which cover the particular weekly period, are deemed to be constructively made or incurred during such weekly period. Such laborers and mechanics shall be paid the appropriate wage rate and fringe benefits on the wage determination for the classification of work actually performed, without regard to skill, except as provided in 29 CFR 5.5(a)(4). Laborers or mechanics performing work in more than one classification may be compensated at the rate specified for each classification for the time actually worked therein: Provided, That the employer's payroll records accurately set forth the time spent in each classification in which work is performed. The wage determination (including any additional classification and wage rates conformed under paragraph 1.b. of this section) and the Davis-Bacon poster (WH-1321) shall be posted at all times by the contractor and its subcontractors at the site of the work in a prominent and accessible place where it can be easily seen by the workers.

- b. (1) The contracting officer shall require that any class of laborers or mechanics, including helpers, which is not listed in the wage determination and which is to be employed under the contract shall be classified in conformance with the wage determination. The contracting officer shall approve an additional classification and wage rate and fringe benefits therefore only when the following criteria have been met:
  - (i) The work to be performed by the classification requested is not performed by a classification in the wage determination; and
  - (ii) The classification is utilized in the area by the construction industry; and
  - (iii) The proposed wage rate, including any bona fide fringe benefits, bears a reasonable relationship to the wage rates contained in the wage determination.
- (2) If the contractor and the laborers and mechanics to be employed in the classification (if known), or their representatives, and the contracting officer agree on the classification and wage rate (including the amount designated for fringe benefits where appropriate), a report of the action taken shall be sent by the contracting officer to the Administrator of the Wage and Hour Division, Employment Standards Administration, U.S. Department of Labor, Washington, DC 20210. The Administrator, or an authorized representative, will approve, modify, or disapprove every additional classification action within 30 days of receipt and so advise the contracting officer or will notify the contracting officer within the 30-day period that additional time is necessary.
- (3) In the event the contractor, the laborers or mechanics to be employed in the classification or their representatives, and the contracting officer do not agree on the proposed classification and wage rate (including the amount designated for fringe benefits, where appropriate), the contracting officer shall refer the questions, including the views of all interested parties and the recommendation of the contracting officer, to the Wage and Hour Administrator for determination. The Wage and Hour Administrator, or an authorized representative, will issue a determination within 30 days of receipt and so advise the contracting officer or will notify the contracting officer within the 30-day period that additional time is necessary.
- (4) The wage rate (including fringe benefits where appropriate) determined pursuant to paragraphs 1.b.(2) or 1.b.(3) of this section, shall be paid to all workers performing work in the classification under this contract from the first day on which work is performed in the classification.
- c. Whenever the minimum wage rate prescribed in the contract for a class of laborers or mechanics includes a fringe benefit which is not expressed as an hourly rate, the contractor shall either pay the benefit as stated in the wage determination or shall pay another bona fide fringe benefit or an hourly cash equivalent thereof.
- d. If the contractor does not make payments to a trustee or other third person, the contractor may consider as part of the wages of any laborer or mechanic the amount of any costs reasonably anticipated in providing bona fide fringe benefits under a plan or program. Provided, That the Secretary of Labor has found, upon the written request of the contractor, that the applicable standards of the Davis-Bacon Act have been met. The Secretary of Labor may require the contractor to set aside in a separate account assets for the meeting of obligations under the plan or program.
2. **Withholding.** The contracting agency shall upon its own action or upon written request of an authorized representative of the Department of Labor, withhold or cause to be withheld from the contractor under this contract, or any other Federal contract with the same prime contractor, or any other federally-assisted contract subject to Davis-Bacon prevailing wage requirements, which is held by the same prime contractor, so much of the accrued payments or advances as may be considered necessary to pay laborers and mechanics, including apprentices, trainees, and helpers, employed by the contractor or any subcontractor the full amount of wages required by the contract. In the event of failure to pay any laborer or mechanic, including any apprentice, trainee, or helper, employed or working on the site of the work, all or part of the wages required by the contract, the contracting agency may, after written notice to the contractor, take such action as may be necessary to cause the suspension of any further payment, advance, or guarantee of funds until such violations have ceased.
3. **Payrolls and basic records**
  - a. Payrolls and basic records relating thereto shall be maintained by the contractor during the course of the work and preserved for a period of three years thereafter for all laborers and mechanics working at the site of the work. Such records shall contain the name, address, and social security number of each such worker, his or her correct classification, hourly rates of wages paid (including rates of contributions or costs anticipated for bona fide fringe benefits or cash equivalents thereof of the types described in section 1(b)(2)(B) of the Davis-Bacon Act), daily and weekly number of hours worked, deductions made and actual wages paid. Whenever the Secretary of Labor has found under 29 CFR 5.5(a)(1)(iv) that the wages of any laborer or mechanic include the amount of any costs reasonably anticipated in providing benefits under a plan or program described in section 1(b)(2)(B) of the Davis-Bacon Act, the contractor shall maintain records which show that the commitment to provide such benefits is enforceable, that the plan or program is financially responsible, and that the plan or program has been communicated in writing to the laborers or mechanics affected, and records which show the costs anticipated or the actual cost incurred in providing such benefits. Contractors employing apprentices or trainees under approved programs shall maintain written evidence of the registration of apprenticeship programs and certification of trainee programs, the registration of the apprentices and trainees, and the ratios and wage rates prescribed in the applicable programs.
  - b. (1) The contractor shall submit weekly for each week in which any contract work is performed a copy of all payrolls to the contracting agency. The payrolls submitted shall set out accurately and completely all of the information required to be maintained under 29 CFR 5.5(a)(3)(i), except that full social security numbers and home addresses shall not be included on weekly transmittals. Instead the payrolls shall only need to include an individually identifying number for each employee ( e.g. , the last four digits of the employee's social security number). The required weekly payroll information may be submitted in any form desired. Optional Form WH-347 is available for this purpose from the Wage and Hour Division Web site at <http://www.dol.gov/esa/whd/forms/wh347instr.htm> or its successor site. The prime contractor is responsible for the submission of copies of payrolls by all subcontractors. Contractors and subcontractors shall maintain the full social security number and current address of each covered worker, and shall provide them upon request to the contracting agency for transmission to the State DOT, the FHWA or the Wage and Hour Division of the Department of Labor for purposes of an investigation or audit of compliance with prevailing wage requirements. It is not a violation of this section for a prime contractor to require a subcontractor to provide addresses and social security numbers to the prime contractor for its own records, without weekly submission to the contracting agency.
  - (2) Each payroll submitted shall be accompanied by a "Statement of Compliance," signed by the contractor or subcontractor or his or her agent who pays or supervises the payment of the persons employed under the contract and shall certify the following:
    - (i) That the payroll for the payroll period contains the information required to be provided under §5.5 (a)(3)(ii) of Regulations, 29 CFR part 5, the appropriate information is being maintained under §5.5 (a)(3)(i) of Regulations, 29 CFR part 5, and that such information is correct and complete;
    - (ii) That each laborer or mechanic (including each helper, apprentice, and trainee) employed on the contract during the payroll period has been paid the full weekly wages earned, without rebate, either directly or indirectly, and that no deductions have been made either directly or indirectly from the full wages earned, other than permissible deductions as set forth in Regulations, 29 CFR part 3;
    - (iii) That each laborer or mechanic has been paid not less than the applicable wage rates and fringe benefits or cash equivalents for the classification of work performed, as specified in the applicable wage determination incorporated into the contract.

- (3) The weekly submission of a properly executed certification set forth on the reverse side of Optional Form WH-347 shall satisfy the requirement for submission of the "Statement of Compliance" required by paragraph 3.b.(2) of this section.
  - (4) The falsification of any of the above certifications may subject the contractor or subcontractor to civil or criminal prosecution under section 1001 of title 18 and section 231 of title 31 of the United States Code.
  - c. The contractor or subcontractor shall make the records required under paragraph 3.a. of this section available for inspection, copying, or transcription by authorized representatives of the contracting agency, the State DOT, the FHWA, or the Department of Labor, and shall permit such representatives to interview employees during working hours on the job. If the contractor or subcontractor fails to submit the required records or to make them available, the FHWA may, after written notice to the contractor, the contracting agency or the State DOT, take such action as may be necessary to cause the suspension of any further payment, advance, or guarantee of funds. Furthermore, failure to submit the required records upon request or to make such records available may be grounds for debarment action pursuant to 29 CFR 5.12.
- 4. Apprentices and trainees**
- a. Apprentices (programs of the USDOL). Apprentices will be permitted to work at less than the predetermined rate for the work they performed when they are employed pursuant to and individually registered in a bona fide apprenticeship program registered with the U.S. Department of Labor, Employment and Training Administration, Office of Apprenticeship Training, Employer and Labor Services, or with a State Apprenticeship Agency recognized by the Office, or if a person is employed in his or her first 90 days of probationary employment as an apprentice in such an apprenticeship program, who is not individually registered in the program, but who has been certified by the Office of Apprenticeship Training, Employer and Labor Services or a State Apprenticeship Agency (where appropriate) to be eligible for probationary employment as an apprentice.

The allowable ratio of apprentices to journeymen on the job site in any craft classification shall not be greater than the ratio permitted to the contractor as to the entire work force under the registered program. Any worker listed on a payroll at an apprentice wage rate, who is not registered or otherwise employed as stated above, shall be paid not less than the applicable wage rate on the wage determination for the classification of work actually performed. In addition, any apprentice performing work on the job site in excess of the ratio permitted under the registered program shall be paid not less than the applicable wage rate on the wage determination for the work actually performed. Where a contractor is performing construction on a project in a locality other than that in which its program is registered, the ratios and wage rates (expressed in percentages of the journeyman's hourly rate) specified in the contractor's or subcontractor's registered program shall be observed.

Every apprentice must be paid at not less than the rate specified in the registered program for the apprentice's level of progress, expressed as a percentage of the journeymen hourly rate specified in the applicable wage determination. Apprentices shall be paid fringe benefits in accordance with the provisions of the apprenticeship program. If the apprenticeship program does not specify fringe benefits, apprentices must be paid the full amount of fringe benefits listed on the wage determination for the applicable classification. If the Administrator determines that a different practice prevails for the applicable apprentice classification, fringes shall be paid in accordance with that determination.

In the event the Office of Apprenticeship Training, Employer and Labor Services, or a State Apprenticeship Agency recognized by the Office, withdraws approval of an apprenticeship program, the contractor will no longer be permitted to utilize apprentices at less than the applicable predetermined rate for the work performed until an acceptable program is approved.
  - b. Trainees (programs of the USDOL). Except as provided in 29 CFR 5.16, trainees will not be permitted to work at less than the predetermined rate for the work performed unless they are employed pursuant to and individually registered in a program which has received prior approval, evidenced by formal certification by the U.S. Department of Labor, Employment and Training Administration.

The ratio of trainees to journeymen on the job site shall not be greater than permitted under the plan approved by the Employment and Training Administration.

Every trainee must be paid at not less than the rate specified in the approved program for the trainee's level of progress, expressed as a percentage of the journeyman hourly rate specified in the applicable wage determination. Trainees shall be paid fringe benefits in accordance with the provisions of the trainee program. If the trainee program does not mention fringe benefits, trainees shall be paid the full amount of fringe benefits listed on the wage determination unless the Administrator of the Wage and Hour Division determines that there is an apprenticeship program associated with the corresponding journeyman wage rate on the wage determination which provides for less than full fringe benefits for apprentices. Any employee listed on the payroll at a trainee rate who is not registered and participating in a training plan approved by the Employment and Training Administration shall be paid not less than the applicable wage rate on the wage determination for the classification of work actually performed. In addition, any trainee performing work on the job site in excess of the ratio permitted under the registered program shall be paid not less than the applicable wage rate on the wage determination for the work actually performed.

In the event the Employment and Training Administration withdraws approval of a training program, the contractor will no longer be permitted to utilize trainees at less than the applicable predetermined rate for the work performed until an acceptable program is approved.
  - c. Equal employment opportunity. The utilization of apprentices, trainees and journeymen under this part shall be in conformity with the equal employment opportunity requirements of Executive Order 11246, as amended, and 29 CFR part 30.
  - d. Apprentices and Trainees (programs of the U.S. DOT). Apprentices and trainees working under apprenticeship and skill training programs which have been certified by the Secretary of Transportation as promoting EEO in connection with Federal-aid highway construction programs are not subject to the requirements of paragraph 4 of this Section IV. The straight time hourly wage rates for apprentices and trainees under such programs will be established by the particular programs. The ratio of apprentices and trainees to journeymen shall not be greater than permitted by the terms of the particular program.
- 5. Compliance with Copeland Act requirements.** The contractor shall comply with the requirements of 29 CFR part 3, which are incorporated by reference in this contract.
- 6. Subcontracts.** The contractor or subcontractor shall insert Form FHWA-1273 in any subcontracts and also require the subcontractors to include Form FHWA-1273 in any lower tier subcontracts. The prime contractor shall be responsible for the compliance by any subcontractor or lower tier subcontractor with all the contract clauses in 29 CFR 5.5.
- 7. Contract termination:** debarment. A breach of the contract clauses in 29 CFR 5.5 may be grounds for termination of the contract, and for debarment as a contractor and a subcontractor as provided in 29 CFR 5.12.
- 8. Compliance with Davis-Bacon and Related Act requirements.** All rulings and interpretations of the Davis-Bacon and Related Acts contained in 29 CFR parts 1, 3, and 5 are herein incorporated by reference in this contract.
- 9. Disputes concerning labor standards.** Disputes arising out of the labor standards provisions of this contract shall not be subject to the general disputes clause of this contract. Such disputes shall be resolved in accordance with the procedures of the Department of Labor set forth in 29 CFR parts 5, 6, and 7. Disputes within the meaning of this clause include disputes between the contractor (or any of its subcontractors) and the contracting agency, the U.S. Department of Labor, or the employees or their representatives.
- 10. Certification of eligibility.**
- a. By entering into this contract, the contractor certifies that neither it (nor he or she) nor any person or firm who has an interest in the contractor's firm is a person or firm ineligible to be awarded Government contracts by virtue of section 3(a) of the Davis-Bacon Act or 29 CFR 5.12(a)(1).

- b. No part of this contract shall be subcontracted to any person or firm ineligible for award of a Government contract by virtue of section 3(a) of the Davis-Bacon Act or 29 CFR 5.12(a)(1).
- c. The penalty for making false statements is prescribed in the U.S. Criminal Code, 18 U.S.C. 1001.

#### V. CONTRACT WORK HOURS AND SAFETY STANDARDS ACT

The following clauses apply to any Federal-aid construction contract in an amount in excess of \$100,000 and subject to the overtime provisions of the Contract Work Hours and Safety Standards Act. These clauses shall be inserted in addition to the clauses required by 29 CFR 5.5(a) or 29 CFR 4.6. As used in this paragraph, the terms laborers and mechanics include watchmen and guards.

1. **Overtime requirements.** No contractor or subcontractor contracting for any part of the contract work which may require or involve the employment of laborers or mechanics shall require or permit any such laborer or mechanic in any workweek in which he or she is employed on such work to work in excess of forty hours in such workweek unless such laborer or mechanic receives compensation at a rate not less than one and one-half times the basic rate of pay for all hours worked in excess of forty hours in such workweek.
2. **Violation; liability for unpaid wages; liquidated damages.** In the event of any violation of the clause set forth in paragraph (1.) of this section, the contractor and any subcontractor responsible therefor shall be liable for the unpaid wages. In addition, such contractor and subcontractor shall be liable to the United States (in the case of work done under contract for the District of Columbia or a territory, to such District or to such territory), for liquidated damages. Such liquidated damages shall be computed with respect to each individual laborer or mechanic, including watchmen and guards, employed in violation of the clause set forth in paragraph (1.) of this section, in the sum of \$10 for each calendar day on which such individual was required or permitted to work in excess of the standard workweek of forty hours without payment of the overtime wages required by the clause set forth in paragraph (1.) of this section.
3. **Withholding for unpaid wages and liquidated damages.** The FHWA or the contacting agency shall upon its own action or upon written request of an authorized representative of the Department of Labor withhold or cause to be withheld, from any moneys payable on account of work performed by the contractor or subcontractor under any such contract or any other Federal contract with the same prime contractor, or any other federally-assisted contract subject to the Contract Work Hours and Safety Standards Act, which is held by the same prime contractor, such sums as may be determined to be necessary to satisfy any liabilities of such contractor or subcontractor for unpaid wages and liquidated damages as provided in the clause set forth in paragraph (2.) of this section.
4. **Subcontracts.** The contractor or subcontractor shall insert in any subcontracts the clauses set forth in paragraph (1.) through (4.) of this section and also a clause requiring the subcontractors to include these clauses in any lower tier subcontracts. The prime contractor shall be responsible for compliance by any subcontractor or lower tier subcontractor with the clauses set forth in paragraphs (1.) through (4.) of this section.

#### VI. SUBLETTING OR ASSIGNING THE CONTRACT

This provision is applicable to all Federal-aid construction contracts on the National Highway System.

1. The contractor shall perform with its own organization contract work amounting to not less than 30 percent (or a greater percentage if specified elsewhere in the contract) of the total original contract price, excluding any specialty items designated by the contracting agency. Specialty items may be performed by subcontract and the amount of any such specialty items performed may be deducted from the total original contract price before computing the amount of work required to be performed by the contractor's own organization (23 CFR 635.116).
  - a. The term "perform work with its own organization" refers to workers employed or leased by the prime contractor, and equipment owned or rented by the prime contractor, with or without operators. Such term does not include employees or equipment of a subcontractor or lower tier subcontractor, agents of the prime contractor, or any other assignees. The term may include payments for the costs of hiring leased employees

from an employee leasing firm meeting all relevant Federal and State regulatory requirements. Leased employees may only be included in this term if the prime contractor meets all of the following conditions:

- (1) the prime contractor maintains control over the supervision of the day-to-day activities of the leased employees;
  - (2) the prime contractor remains responsible for the quality of the work of the leased employees;
  - (3) the prime contractor retains all power to accept or exclude individual employees from work on the project; and
  - (4) the prime contractor remains ultimately responsible for the payment of predetermined minimum wages, the submission of payrolls, statements of compliance and all other Federal regulatory requirements.
- b. "Specialty Items" shall be construed to be limited to work that requires highly specialized knowledge, abilities, or equipment not ordinarily available in the type of contracting organizations qualified and expected to bid or propose on the contract as a whole and in general are to be limited to minor components of the overall contract.
2. The contract amount upon which the requirements set forth in paragraph (1) of Section VI is computed includes the cost of material and manufactured products which are to be purchased or produced by the contractor under the contract provisions.
  3. The contractor shall furnish (a) a competent superintendent or supervisor who is employed by the firm, has full authority to direct performance of the work in accordance with the contract requirements, and is in charge of all construction operations (regardless of who performs the work) and (b) such other of its own organizational resources (supervision, management, and engineering services) as the contracting officer determines is necessary to assure the performance of the contract.
  4. No portion of the contract shall be sublet, assigned or otherwise disposed of except with the written consent of the contracting officer, or authorized representative, and such consent when given shall not be construed to relieve the contractor of any responsibility for the fulfillment of the contract. Written consent will be given only after the contracting agency has assured that each subcontract is evidenced in writing and that it contains all pertinent provisions and requirements of the prime contract.
  5. The 30% self-performance requirement of paragraph (1) is not applicable to design-build contracts; however, contracting agencies may establish their own self-performance requirements.

#### VII. SAFETY: ACCIDENT PREVENTION

This provision is applicable to all Federal-aid construction contracts and to all related subcontracts.

1. In the performance of this contract the contractor shall comply with all applicable Federal, State, and local laws governing safety, health, and sanitation (23 CFR 635). The contractor shall provide all safeguards, safety devices and protective equipment and take any other needed actions as it determines, or as the contracting officer may determine, to be reasonably necessary to protect the life and health of employees on the job and the safety of the public and to protect property in connection with the performance of the work covered by the contract.
2. It is a condition of this contract, and shall be made a condition of each subcontract, which the contractor enters into pursuant to this contract, that the contractor and any subcontractor shall not permit any employee, in performance of the contract, to work in surroundings or under conditions which are unsanitary, hazardous or dangerous to his/her health or safety, as determined under construction safety and health standards (29 CFR 1926) promulgated by the Secretary of Labor, in accordance with Section 107 of the Contract Work Hours and Safety Standards Act (40 U.S.C. 3704).
3. Pursuant to 29 CFR 1926.3, it is a condition of this contract that the Secretary of Labor or authorized representative thereof, shall have right of entry to any site of contract performance to inspect or investigate the matter of compliance with the construction safety and health standards and to carry out the duties of the Secretary under Section 107 of the Contract Work Hours and Safety Standards Act (40 U.S.C.3704).

#### VIII. FALSE STATEMENTS CONCERNING HIGHWAY PROJECTS

This provision is applicable to all Federal-aid construction contracts and to all related subcontracts.

In order to assure high quality and durable construction in conformity with approved plans and specifications and a high degree of reliability on statements and representations made by engineers, contractors, suppliers, and workers on Federal-aid highway projects, it is essential that all persons concerned with the project perform their functions as carefully, thoroughly, and honestly as possible. Willful falsification, distortion, or misrepresentation with respect to any facts related to the project is a violation of Federal law. To prevent any misunderstanding regarding the seriousness of these and similar acts, Form FHWA-1022 shall be posted on each Federal-aid highway project (23 CFR 635) in one or more places where it is readily available to all persons concerned with the project:

18 U.S.C. 1020 reads as follows:

"Whoever, being an officer, agent, or employee of the United States, or of any State or Territory, or whoever, whether a person, association, firm, or corporation, knowingly makes any false statement, false representation, or false report as to the character, quality, quantity, or cost of the material used or to be used, or the quantity or quality of the work performed or to be performed, or the cost thereof in connection with the submission of plans, maps, specifications, contracts, or costs of construction on any highway or related project submitted for approval to the Secretary of Transportation; or

Whoever knowingly makes any false statement, false representation, false report or false claim with respect to the character, quality, quantity, or cost of any work performed or to be performed, or materials furnished or to be furnished, in connection with the construction of any highway or related project approved by the Secretary of Transportation; or

Whoever knowingly makes any false statement or false representation as to material fact in any statement, certificate, or report submitted pursuant to provisions of the Federal-aid Roads Act approved July 1, 1916, (39 Stat. 355), as amended and supplemented;

Shall be fined under this title or imprisoned not more than 5 years or both."

#### IX. IMPLEMENTATION OF CLEAN AIR ACT AND FEDERAL WATER POLLUTION CONTROL ACT

This provision is applicable to all Federal-aid construction contracts and to all related subcontracts.

By submission of this bid/proposal or the execution of this contract, or subcontract, as appropriate, the bidder, proposer, Federal-aid construction contractor, or subcontractor, as appropriate, will be deemed to have stipulated as follows:

1. That any person who is or will be utilized in the performance of this contract is not prohibited from receiving an award due to a violation of Section 508 of the Clean Water Act or Section 306 of the Clean Air Act.
2. That the contractor agrees to include or cause to be included the requirements of paragraph (1) of this Section X in every subcontract, and further agrees to take such action as the contracting agency may direct as a means of enforcing such requirements.

#### X. CERTIFICATION REGARDING DEBARMENT, SUSPENSION, INELIGIBILITY AND VOLUNTARY EXCLUSION

This provision is applicable to all Federal-aid construction contracts, design-build contracts, subcontracts, lower-tier subcontracts, purchase orders, lease agreements, consultant contracts or any other covered transaction requiring FHWA approval or that is estimated to cost \$25,000 or more – as defined in 2 CFR Parts 180 and 1200.

**1. Instructions for Certification – First Tier Participants:**

- a. By signing and submitting this proposal, the prospective first tier participant is providing the certification set out below.
- b. The inability of a person to provide the certification set out below will not necessarily result in denial of participation in this covered transaction. The prospective first tier participant shall submit an explanation of why it cannot provide the certification set out below. The certification or explanation will be considered in connection with the department or agency's determination whether to enter into this transaction. However, failure of the prospective first tier participant to furnish a certification or an explanation shall disqualify such a person from participation in this transaction.
- c. The certification in this clause is a material representation of fact upon which reliance was placed when the contracting agency determined to enter into this transaction. If it is later determined that the prospective participant knowingly rendered an erroneous certification, in addition to other remedies available to the Federal Government, the contracting agency may terminate this transaction for cause of default.
- d. The prospective first tier participant shall provide immediate written notice to the contracting agency to whom this proposal is submitted if any time the prospective first tier participant learns that its certification was erroneous when submitted or has become erroneous by reason of changed circumstances.
- e. The terms "covered transaction," "debarred," "suspended," "ineligible," "participant," "person," "principal," and "voluntarily excluded," as used in this clause, are defined in 2 CFR Parts 180 and 1200. "First Tier Covered Transactions" refers to any covered transaction between a grantee or subgrantee of Federal funds and a participant (such as the prime or general contract). "Lower Tier Covered Transactions" refers to any covered transaction under a First Tier Covered Transaction (such as subcontracts). "First Tier Participant" refers to the participant who has entered into a covered transaction with a grantee or subgrantee of Federal funds (such as the prime or general contractor). "Lower Tier Participant" refers any participant who has entered into a covered transaction with a First Tier Participant or other Lower Tier Participants (such as subcontractors and suppliers).
- f. The prospective first tier participant agrees by submitting this proposal that, should the proposed covered transaction be entered into, it shall not knowingly enter into any lower tier covered transaction with a person who is debarred, suspended, declared ineligible, or voluntarily excluded from participation in this covered transaction, unless authorized by the department or agency entering into this transaction.
- g. The prospective first tier participant further agrees by submitting this proposal that it will include the clause titled "Certification Regarding Debarment, Suspension, Ineligibility and Voluntary Exclusion-Lower Tier Covered Transactions," provided by the department or contracting agency, entering into this covered transaction, without modification, in all lower tier covered transactions and in all solicitations for lower tier covered transactions exceeding the \$25,000 threshold.
- h. A participant in a covered transaction may rely upon a certification of a prospective participant in a lower tier covered transaction that is not debarred, suspended, ineligible, or voluntarily excluded from the covered transaction, unless it knows that the certification is erroneous. A participant is responsible for ensuring that its principals are not suspended, debarred, or otherwise ineligible to participate in covered transactions. To verify the eligibility of its principals, as well as the eligibility of any lower tier prospective participants, each participant may, but is not required to, check the Excluded Parties List System website (<https://www.epls.gov/>), which is compiled by the General Services Administration.
- i. Nothing contained in the foregoing shall be construed to require the establishment of a system of records in order to render in good faith the certification required by this clause. The knowledge and information of the prospective participant is not required to exceed that which is normally possessed by a prudent person in the ordinary course of business dealings.
- j. Except for transactions authorized under paragraph (f) of these instructions, if a participant in a covered transaction knowingly enters into a lower tier covered transaction with a person who is suspended, debarred, ineligible, or voluntarily excluded from participation in this transaction, in addition to other remedies available to the Federal Government, the department or agency may terminate this transaction for cause or default.

\* \* \* \* \*

**2. Certification Regarding Debarment, Suspension, Ineligibility and Voluntary Exclusion – First Tier Participants:**

- a. The prospective first tier participant certifies to the best of its knowledge and belief, that it and its principals:
  - (1) Are not presently debarred, suspended, proposed for debarment, declared ineligible, or voluntarily excluded from participating in covered transactions by any Federal department or agency;
  - (2) Have not within a three-year period preceding this proposal been convicted of or had a civil judgment rendered against them for commission of fraud or a criminal offense in connection with obtaining, attempting to obtain, or performing a public (Federal, State or local) transaction or contract under a public transaction; violation of Federal or State antitrust statutes or commission of embezzlement, theft, forgery, bribery, falsification or destruction of records, making false statements, or receiving stolen property;
  - (3) Are not presently indicted for or otherwise criminally or civilly charged by a governmental entity (Federal, State or local) with commission of any of the offenses enumerated in paragraph (a)(2) of this certification; and
  - (4) Have not within a three-year period preceding this application/proposal had one or more public transactions (Federal, State or local) terminated for cause or default.
- b. Where the prospective participant is unable to certify to any of the statements in this certification, such prospective participant shall attach an explanation to this proposal.

**2. Instructions for Certification - Lower Tier Participants:**

(Applicable to all subcontracts, purchase orders and other lower tier transactions requiring prior FHWA approval or estimated to cost \$25,000 or more - 2 CFR Parts 180 and 1200)

- a. By signing and submitting this proposal, the prospective lower tier is providing the certification set out below.
- b. The certification in this clause is a material representation of fact upon which reliance was placed when this transaction was entered into. If it is later determined that the prospective lower tier participant knowingly rendered an erroneous certification, in addition to other remedies available to the Federal Government, the department, or agency with which this transaction originated may pursue available remedies, including suspension and/or debarment.
- c. The prospective lower tier participant shall provide immediate written notice to the person to which this proposal is submitted if at any time the prospective lower tier participant learns that its certification was erroneous by reason of changed circumstances.
- d. The terms "covered transaction," "debarred," "suspended," "ineligible," "participant," "person," "principal," and "voluntarily excluded," as used in this clause, are defined in 2 CFR Parts 180 and 1200. You may contact the person to which this proposal is submitted for assistance in obtaining a copy of those regulations. "First Tier Covered Transactions" refers to any covered transaction between a grantee or subgrantee of

Federal funds and a participant (such as the prime or general contract). "Lower Tier Covered Transactions" refers to any covered transaction under a First Tier Covered Transaction (such as subcontracts). "First Tier Participant" refers to the participant who has entered into a covered transaction with a grantee or subgrantee of Federal funds (such as the prime or general contractor). "Lower Tier Participant" refers to any participant who has entered into a covered transaction with a First Tier Participant or other Lower Tier Participants (such as subcontractors and suppliers).

- e. The prospective lower tier participant agrees by submitting this proposal that, should the proposed covered transaction be entered into, it shall not knowingly enter into any lower tier covered transaction with a person who is debarred, suspended, declared ineligible, or voluntarily excluded from participation in this covered transaction, unless authorized by the department or agency with which this transaction originated.
- f. The prospective lower tier participant further agrees by submitting this proposal that it will include this clause titled "Certification Regarding Debarment, Suspension, Ineligibility and Voluntary Exclusion-Lower Tier Covered Transaction," without modification, in all lower tier covered transactions and in all solicitations for lower tier covered transactions exceeding the \$25,000 threshold.
- g. A participant in a covered transaction may rely upon a certification of a prospective participant in a lower tier covered transaction that is not debarred, suspended, ineligible, or voluntarily excluded from the covered transaction, unless it knows that the certification is erroneous. A participant is responsible for ensuring that its principals are not suspended, debarred, or otherwise ineligible to participate in covered transactions. To verify the eligibility of its principals, as well as the eligibility of any lower tier prospective participants, each participant may, but is not required to, check the Excluded Parties List System website (<https://www.epls.gov/>), which is compiled by the General Services Administration.
- h. Nothing contained in the foregoing shall be construed to require establishment of a system of records in order to render in good faith the certification required by this clause. The knowledge and information of participant is not required to exceed that which is normally possessed by a prudent person in the ordinary course of business dealings.
- i. Except for transactions authorized under paragraph e of these instructions, if a participant in a covered transaction knowingly enters into a lower tier covered transaction with a person who is suspended, debarred, ineligible, or voluntarily excluded from participation in this transaction, in addition to other remedies available to the Federal Government, the department or agency with which this transaction originated may pursue available remedies, including suspension and/or debarment.

\* \* \* \* \*

**Certification Regarding Debarment, Suspension, Ineligibility and Voluntary Exclusion--Lower Tier Participants:**

1. The prospective lower tier participant certifies, by submission of this proposal, that neither it nor its principals is presently debarred, suspended, proposed for debarment, declared ineligible, or voluntarily excluded from participating in covered transactions by any Federal department or agency.
2. Where the prospective lower tier participant is unable to certify to any of the statements in this certification, such prospective participant shall attach an explanation to this proposal.

\* \* \* \* \*

**XI. CERTIFICATION REGARDING USE OF CONTRACT FUNDS FOR LOBBYING**

This provision is applicable to all Federal-aid construction contracts and to all related subcontracts which exceed \$100,000 (49 CFR 20).

1. The prospective participant certifies, by signing and submitting this bid or proposal, to the best of his or her knowledge and belief, that:
  - a. No Federal appropriated funds have been paid or will be paid, by or on behalf of the undersigned, to any person for influencing or attempting to influence an officer or employee of any Federal agency, a Member of Congress, an officer or employee of Congress, or an employee of a Member of Congress in connection with the awarding of any Federal contract, the making of any Federal grant, the making of any Federal loan, the entering into of any cooperative agreement, and the extension, continuation, renewal, amendment, or modification of any Federal contract, grant, loan, or cooperative agreement.
  - b. If any funds other than Federal appropriated funds have been paid or will be paid to any person for influencing or attempting to influence an officer or employee of any Federal agency, a Member of Congress, an officer or employee of Congress, or an employee of a Member of Congress in connection with this Federal contract, grant, loan, or cooperative agreement, the undersigned shall complete and submit Standard Form-LLL, "Disclosure Form to Report Lobbying," in accordance with its instructions.
2. This certification is a material representation of fact upon which reliance was placed when this transaction was made or entered into. Submission of this certification is a prerequisite for making or entering into this transaction imposed by 31 U.S.C. 1352. Any person who fails to file the required certification shall be subject to a civil penalty of not less than \$10,000 and not more than \$100,000 for each such failure.
3. The prospective participant also agrees by submitting its bid or proposal that the participant shall require that the language of this certification be included in all lower tier subcontracts, which exceed \$100,000 and that all such recipients shall certify and disclose accordingly.



**STANDARD SPECIAL PROVISION****ON-THE-JOB TRAINING**

(10-16-07) (Rev. 4-21-15)

Z-10

**Description**

The North Carolina Department of Transportation will administer a custom version of the Federal On-the-Job Training (OJT) Program, commonly referred to as the Alternate OJT Program. All contractors (existing and newcomers) will be automatically placed in the Alternate Program. Standard OJT requirements typically associated with individual projects will no longer be applied at the project level. Instead, these requirements will be applicable on an annual basis for each contractor administered by the OJT Program Manager.

On the Job Training shall meet the requirements of 23 CFR 230.107 (b), 23 USC – Section 140, this provision and the On-the-Job Training Program Manual.

The Alternate OJT Program will allow a contractor to train employees on Federal, State and privately funded projects located in North Carolina. However, priority shall be given to training employees on NCDOT Federal-Aid funded projects.

**Minorities and Women**

Developing, training and upgrading of minorities and women toward journeyman level status is a primary objective of this special training provision. Accordingly, the Contractor shall make every effort to enroll minority and women as trainees to the extent that such persons are available within a reasonable area of recruitment. This training commitment is not intended, and shall not be used, to discriminate against any applicant for training, whether a member of a minority group or not.

**Assigning Training Goals**

The Department, through the OJT Program Manager, will assign training goals for a calendar year based on the contractors' past three years' activity and the contractors' anticipated upcoming year's activity with the Department. At the beginning of each year, all contractors eligible will be contacted by the Department to determine the number of trainees that will be assigned for the upcoming calendar year. At that time the Contractor shall enter into an agreement with the Department to provide a self-imposed on-the-job training program for the calendar year. This agreement will include a specific number of annual training goals agreed to by both parties. The number of training assignments may range from 1 to 15 per contractor per calendar year. The Contractor shall sign an agreement to fulfill their annual goal for the year.\

**Training Classifications**

The Contractor shall provide on-the-job training aimed at developing full journeyman level workers in the construction craft/operator positions. Preference shall be given to providing training in the following skilled work classifications:

Equipment Operators	Office Engineers
Truck Drivers	Estimators
Carpenters	Iron / Reinforcing Steel Workers
Concrete Finishers	Mechanics
Pipe Layers	Welders

The Department has established common training classifications and their respective training requirements that may be used by the contractors. However, the classifications established are not all-inclusive. Where the training is oriented toward construction applications, training will be allowed in lower-level management positions such as office engineers and estimators. Contractors shall submit new classifications for specific job functions that their employees are performing. The Department will review and recommend for acceptance to FHWA the new classifications proposed by contractors, if applicable. New classifications shall meet the following requirements:

Proposed training classifications are reasonable and realistic based on the job skill classification needs, and

The number of training hours specified in the training classification is consistent with common practices and provides enough time for the trainee to obtain journeyman level status.

The Contractor may allow trainees to be trained by a subcontractor provided that the Contractor retains primary responsibility for meeting the training and this provision is made applicable to the subcontract. However, only the Contractor will receive credit towards the annual goal for the trainee.

Where feasible, 25 percent of apprentices or trainees in each occupation shall be in their first year of apprenticeship or training. The number of trainees shall be distributed among the work classifications on the basis of the contractor's needs and the availability of journeymen in the various classifications within a reasonable area of recruitment.

No employee shall be employed as a trainee in any classification in which they have successfully completed a training course leading to journeyman level status or in which they have been employed as a journeyman.

**Records and Reports**

The Contractor shall maintain enrollment, monthly and completion reports documenting company compliance under these contract documents. These documents and any other information as requested shall be submitted to the OJT Program Manager.

Upon completion and graduation of the program, the Contractor shall provide each trainee with a certification Certificate showing the type and length of training satisfactorily completed.

**Trainee Interviews**

All trainees enrolled in the program will receive an initial and Trainee/Post graduate interview conducted by the OJT program staff.

**Trainee Wages**

Contractors shall compensate trainees on a graduating pay scale based upon a percentage of the prevailing minimum journeyman wages (Davis-Bacon Act). Minimum pay shall be as follows:

60 percent	of the journeyman wage for the first half of the training period
75 percent	of the journeyman wage for the third quarter of the training period
90 percent	of the journeyman wage for the last quarter of the training period

In no instance shall a trainee be paid less than the local minimum wage. The Contractor shall adhere to the minimum hourly wage rate that will satisfy both the NC Department of Labor (NCDOL) and the Department.

**Achieving or Failing to Meet Training Goals**

The Contractor will be credited for each trainee employed by him on the contract work who is currently enrolled or becomes enrolled in an approved program and who receives training for at least 50 percent of the specific program requirement. Trainees will be allowed to be transferred between projects if required by the Contractor's scheduled workload to meet training goals.

If a contractor fails to attain their training assignments for the calendar year, they may be taken off the NCDOT's Bidders List.

**Measurement and Payment**

No compensation will be made for providing required training in accordance with these contract documents.

**STANDARD SPECIAL PROVISION**  
**MINIMUM WAGES**  
**GENERAL DECISION NC20210091 01/01/2021 NC91**

Z-091

Date: January 1, 2021

General Decision Number: NC20210091 01/01/2021 NC91

Superseded General Decision Numbers: NC20200091

State: North Carolina

Construction Type: HIGHWAY

**COUNTIES:**

Beaufort	Granville	Pasquotank
Bertie	Halifax	Perquimans
Bladen	Harnett	Robeson
Camden	Hertford	Sampson
Carteret	Hyde	Scotland
Chowan	Jones	Tyrrell
Columbus	Lenoir	Vance
Craven	Martin	Warren
Dare	Northampton	Washington
Duplin	Pamlico	Wilson
Gates		

HIGHWAY CONSTRUCTION PROJECTS (excluding tunnels, building structures in rest area projects & railroad construction; bascule, suspension & spandrel arch bridges designed for commercial navigation, bridges involving marine construction; and other major bridges).

Note: Under Executive Order (EO) 13658, an hourly minimum wage of \$10.95 for calendar year 2021 applies to all contracts subject to the Davis-Bacon Act for which the contract is awarded (and any solicitation was issued) on or after January 1, 2015. If this contract is covered by the EO, the contractor must pay all workers in any classification listed on this wage determination at least \$10.95 per hour (or the applicable wage rate listed on this wage determination, if it is higher) for all hours spent performing on the contract for calendar year 2021. If this contract is covered by the EO and a classification considered necessary for performance of work on the contract does not appear on this wage determination, the contractor must pay workers in that classification at least the wage rate determined through the conformance process set forth in 29 CFR.5.5(a)(1)(ii) (or the EO minimum wage rate, if it is higher than the conformed wage rate). The EO minimum wage rate will be adjusted annually. Please note that this EO applies to the above-mentioned types of contracts entered into by the federal government that are subject to the Davis-Bacon Act itself, but it does not apply to contracts subject only to the Davis-Bacon Related Acts, including those set forth at 29 CFR 5.1(a)(2) – (60). Additional information on contractor requirements and worker protections under the EO is available at [www.dol.gov/whd/govcontracts](http://www.dol.gov/whd/govcontracts).

Modification Number  
0

Publication Date  
01/01/2021

SUNC2014-006 11/17/2014

	Rates	Fringes
BLASTER	21.85	
CARPENTER	13.72	
CEMENT MASON/CONCRETE FINISHER	14.26	
ELECTRICIAN		
Electrician	18.69	2.66
Telecommunications Technician	14.72	1.67
IRONWORKER	16.32	
LABORER		
Asphalt Raker and Spreader	12.42	
Asphalt Screed/Jackman	13.48	
Carpenter Tender	10.85	
Cement Mason/Concrete Finisher Tender	11.35	
Common or General	10.12	
Guardrail/Fence Installer	13.39	
Pipelayer	13.31	
Traffic Signal/Lighting Installer	16.88	
PAINTER		
Bridge	19.62	
POWER EQUIPMENT OPERATORS		
Asphalt Broom Tractor	13.28	
Bulldozer Fine	18.46	
Bulldozer Rough	14.09	
Concrete Grinder/Groover	24.66	
Crane Boom Trucks	17.25	
Crane Other	21.48	
Crane Rough/All-Terrain	19.00	
Drill Operator Rock	15.43	1.61
Drill Operator Structure	19.12	
Excavator Fine	17.61	
Excavator Rough	12.99	
Grader/Blade Fine	16.73	
Grader/Blade Rough	15.28	
Loader 2 Cubic Yards or Less	10.28	
Loader Greater Than 2 Cubic Yards	13.58	
Material Transfer Vehicle (Shuttle Buggy)	17.39	
Mechanic	18.63	
Milling Machine	14.38	
Off-Road Hauler/Water Tanker	9.30	
Oiler/Greaser	13.45	
Pavement Marking Equipment	11.87	
Paver Asphalt	15.53	
Roller Asphalt Breakdown	12.13	
Roller Asphalt Finish	13.65	
Roller Other	10.48	
Scraper Finish	13.98	
Scraper Rough	10.17	
Slip Form Machine	19.29	
Tack Truck/Distributor Operator	14.56	
TRUCK DRIVER		
GVWR of 26,000 Lbs or Less	10.35	
GVWR of 26,001 Lbs or Greater	12.04	

Welders – Receive rate prescribed for craft performing operation to which welding is incidental.

Note: Executive Order (EO) 13706, Establishing Paid Sick Leave for Federal Contractors applies to all contracts subject to the Davis-Bacon Act for which the contract is awarded (and any solicitation was issued) on or after January 1, 2017. If this contract is covered by the EO, the contractor must provide employees with 1 hour of paid sick leave for every 30 hours they work, up to 56 hours of paid sick leave each year. Employees must be permitted to use paid sick leave for their own illness, injury or other health-related needs, including preventive care; to assist a family member (or person who is like family to the employee) who is ill, injured, or has other health-related needs, including preventive care; or for reasons resulting from, or to assist a family member (or person who is like family to the employee) who is a victim of, domestic violence, sexual assault, or stalking. Additional information on contractor requirements and worker protections under the EO is available at [www.dol.gov/whd/govcontracts](http://www.dol.gov/whd/govcontracts).

Unlisted classifications needed for work not included within the scope of the classifications listed may be added after award only as provided in the labor standards contract clauses (29 CFR 5.5(a)(1)(ii)).

The body of each wage determination lists the classification and wage rates that have been found to be prevailing for the cited type(s) of construction in the area covered by the wage determination. The classifications are listed in alphabetical order of "identifiers" that indicate whether the particular rate is a union rate (current union negotiated rate for local), a survey rate (weighted average rate) or a union average rate (weighted union average rate).

#### Union Rate Identifiers

A four letter classification abbreviation identifier enclosed in dotted lines beginning with characters other than "SU" or "UAVG" denotes that the union classification and rate were prevailing for that classification in the survey. Example: PLUM0198-005 07/01/2014. PLUM is an abbreviation identifier of the union which prevailed in the survey for this classification, which in this example would be Plumbers. 0198 indicates the local union number or district council number where applicable, i.e., Plumbers Local 0198. The next number, 005 in the example, is an internal number used in processing the wage determination. 07/01/2014 is the effective date of the most current negotiated rate, which in this example is July 1, 2014.

Union prevailing wage rates are updated to reflect all rate changes in the collective bargaining agreement (CBA) governing this classification and rate.

#### Survey Rate Identifiers

Classifications listed under the "SU" identifier indicate that no one rate prevailed for this classification in the survey and the published rate is derived by computing a weighted average rate based on all the rates reported in the survey for that classification. As this weighted average rate includes all rates reported in the survey, it may include both union and non-union rates. Example: SULA2012-007 5/13/2014. SU indicates the rates are survey rates based on a weighted average calculation of rates and are not majority rates. LA indicates the State of Louisiana. 2012 is the year of survey on which these classifications and rates are based. The next number, 007 in the example, is an internal number used in producing the wage determination. 5/13/2014 indicates the survey completion date for the classifications and rates under that identifier.

Survey wage rates are not updated and remain in effect until a new survey is conducted.

#### Union Average Rate Identifiers

Classification(s) listed under the UAVG identifier indicate that no single majority rate prevailed for those classifications; however, 100% of the data reported for the classifications was union data. EXAMPLE: UAVG-OH-0010 08/29/2014. UAVG indicates that the rate is a weighted union average rate. OH indicates the state. The next number, 0010 in the example, is an internal number used in producing the wage determination. 08/29/2014 indicates the survey completion date for the classifications and rates under that identifier.

A UAVG rate will be updated once a year, usually in January of each year, to reflect a weighted average of the current negotiated/CBA rate of the union locals from which the rate is based.

#### WAGE DETERMINATION APPEALS PROCESS

1.) Has there been an initial decision in the matter? This can be:

- \* an existing published wage determination
- \* a survey underlying a wage determination
- \* a Wage and Hour Division letter setting forth a position on a wage determination matter
- \* a conformance (additional classification and rate) ruling

On survey related matters, initial contact, including requests for summaries of surveys, should be with the Wage and Hour Regional Office for the area in which the survey was conducted because those Regional Offices have responsibility for the Davis-Bacon survey program. If the response from this initial contact is not satisfactory, then the process described in 2.) and 3.) should be followed.

With regard to any other matter not yet ripe for the formal process described here, initial contact should be with the Branch of Construction Wage Determinations. Write to:

Branch of Construction Wage Determinations  
Wage and Hour Division  
U. S. Department of Labor  
200 Constitution Avenue, N.W.  
Washington, D.C. 20210

2.) If the answer to the question in 1.) is yes, then an interested party (those affected by the action) can request review and reconsideration from the Wage and Hour Administrator (See 29 CFR Part 1.8 and 29 CFR Part 7). Write to:

Wage and Hour Administrator  
U.S. Department of Labor  
200 Constitution Avenue, N.W.  
Washington, D.C. 20210

The request should be accompanied by a full statement of the interested party's position and by any information (wage payment data, project description, area practice material, etc.) that the requestor considers relevant to the issue.

3.) If the decision of the Administrator is not favorable, an interested party may appeal directly to the Administrative Review Board (formerly the Wage Appeals Board). Write to:

Administrative Review Board  
U.S. Department of Labor  
200 Constitution Avenue, N.W.  
Washington, D.C. 20210

- 4.) All decisions by the Administrative Review Board are final.

END OF GENERAL DECISION



**PROJECT SPECIAL PROVISIONS**  
**Elizabeth City Computerized Signal System**

**N.C. Project No. U-5942 (WBS # 45861.3.1)**  
**F.A. Project No. STBG-0111(025)**

*Based On*  
**NCDOT ITS and Signals Project Special Provisions**  
*(Version 18.1)*

*Prepared by: LMM/JPG*

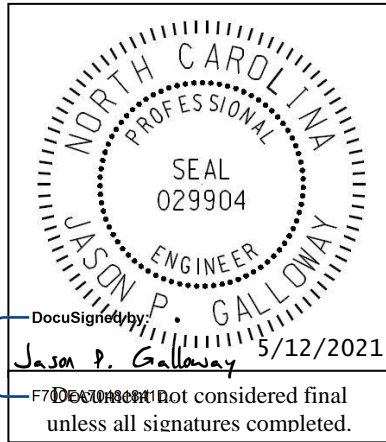

**Contents**

**1. GENERAL REQUIREMENTS.....15**

1.1. DESCRIPTION.....15

    A. Summary of Work.....15

    B. Specifications and Special Provisions .....16

    C. Coordination of Plans, Specifications, and Special Provisions .....16

1.2. MATERIALS .....17

    A. Qualified Products .....17

    B. Submittal Requirements.....17

    C. Observation Period.....18

    D. Warranties .....18

    E. Firmware Licensing and Upgrades .....18

    F. Wire and Cable .....19

    G. Painting .....19

    H. Performance of Warranty Repair and Maintenance.....19

1.3. CONSTRUCTION METHODS .....20

    A. General.....20

    B. Work within Historic Districts.....20

    C. Regulations and Codes.....21

    D. Utility Services.....22

    E. Maintenance and Repair of Material.....22

    F. Inspections .....23

    G. Removal of Existing Equipment and Material.....23

    H. Railroad Preemption .....24

    I. Vehicle Preemption Systems .....24

    J. Timing of Signals.....24

    K. Wire and Cable .....25

    L. Electrical Services and Grounding.....25

    M. Electrical Bonding .....26

    N. Traffic Signal Activation .....26

    O. Requirements for Cables Crossing Railroads .....26

- 1.4. CONSTRUCTION STAGING/MIGRATION .....30
  - A. Introduction.....30
  - B. General Requirements.....30
  - C. Time-Based Coordination During Construction.....32
  - D. Staging Concept.....32
- 1.5. MEASUREMENT AND PAYMENT .....34
- 2. MOBILIZATION .....35**
  - 2.1. DESCRIPTION .....35
  - 2.2. MEASUREMENT AND PAYMENT .....35
- 3. TEMPORARY TRAFFIC CONTROL .....36**
  - 3.1. DESCRIPTION .....36
  - 3.2. GENERAL REQUIREMENTS.....36
    - A. Maintenance of Traffic .....36
    - B. Temporary Lane Closures.....36
    - C. Temporary Road Closures .....37
    - D. Traffic Control Supervision .....37
    - E. Vehicular Access .....37
    - F. Pedestrian Access.....37
    - G. Alternate to Transportation Management Plan .....38
    - H. Temporary Traffic Control Plan not fully Covered in the Contract .....38
  - 3.3. MATERIALS .....38
    - A. Work Zone Traffic Control Devices .....38
    - B. Work Zone Signs .....39
    - C. Flashing Arrow Boards.....39
    - D. Portable Changeable Message Signs .....39
    - E. Drums.....40
    - F. Cones.....40
    - G. Barricades .....40
    - H. Flaggers.....40
    - I. Truck Mounted Attenuators.....40
    - J. Skinny Drums .....41
    - K. Audible Warning Devices.....41
    - L. Temporary Curb Ramps.....41
  - 3.4. CONSTRUCTION METHODS .....41
    - A. Work Zone Traffic Control Devices .....41
    - B. Work Zone Signs .....41
    - C. Flashing Arrow Boards.....42
    - D. Portable Changeable Message Signs .....42
    - E. Drums.....43
    - F. Cones.....43
    - G. Barricades .....43
    - H. Flaggers.....44
    - I. Truck Mounted Attenuator .....44
    - J. Skinny Drums .....44
    - K. Pedestrian Channelizing Devices.....45

- L. Law Enforcement.....45
- M. Pedestrian Safety.....45
- 3.5. MAINTENANCE AND INSPECTION .....45
  - A. Work Zone Traffic Control Devices .....45
- 3.6. FAILURE TO MAINTAIN TRAFFIC CONTROL .....46
- 3.7. MEASUREMENT AND PAYMENT .....46
- 4. PAVEMENT MARKINGS .....50**
  - 4.1. DESCRIPTION .....50
  - 4.2. MATERIALS .....50
    - A. General.....50
    - B. Material Qualification.....50
    - C. Performance .....50
  - 4.3. CONSTRUCTION METHODS .....50
    - A. General.....50
    - B. Testing Procedures.....50
    - C. Application Equipment .....50
    - D. Weather Limitations and Seasonal Limitations for All Markings .....51
    - E. Time Limitations for Replacement .....51
    - F. Premarking/Interim/Temporary Markings.....51
    - G. Surface Preparation and Curing Compound Removal.....52
    - H. Application of Pavement Markings .....52
    - I. Pavement Markings Observation Period .....54
    - J. Removal of Pavement Markings.....54
    - K. Pavement Marking Installer Qualifications .....55
  - 4.4. THERMOPLASTIC (ALKYD/MALEIC) .....55
    - A. Application Equipment .....55
    - B. Weather Limitations and Seasonal Limitations .....56
    - C. Application.....56
    - D. Thermoplastic Marking Observation Period.....57
  - 4.5. MAINTENANCE.....57
  - 4.6. MEASUREMENT AND PAYMENT .....58
- 5. SIGNAL HEADS .....60**
  - 5.1. DESCRIPTION .....60
  - 5.2. MATERIALS .....60
    - A. General.....60
    - B. Vehicle Signal Heads:.....62
    - C. Pedestrian Signal Heads:.....65
    - D. Signal Cable:.....67
  - 5.3. CONSTRUCTION METHODS .....67
    - A. General.....67
    - B. Vehicle Signal Heads .....67
    - C. Pedestrian Signal Heads.....69
    - D. Louvers .....69
  - 5.4. MEASUREMENT AND PAYMENT .....69

**6. MESSENGER CABLE.....71**

6.1. DESCRIPTION .....71

6.2. MATERIALS .....71

    A. General.....71

    B. Messenger Cable.....71

    C. Pole Line Hardware .....71

6.3. CONSTRUCTION METHODS .....72

    A. General.....72

    B. Messenger Cable for Signal Heads or Loop Lead-In Cable .....73

    C. Messenger Cable for Communications Cable.....73

    D. Messenger Cable for Multiple Cables.....73

6.4. MEASUREMENT AND PAYMENT .....73

**7. UNDERGROUND CONDUIT.....75**

7.1. DESCRIPTION .....75

7.2. MATERIALS .....75

    A. General.....75

    B. Conduit Bodies, Boxes and Fittings .....75

    C. Conduit Types.....75

    D. Conduit Plugs, Pull Line, and Tracer Wire.....77

    E. Mechanical Couplings for HDPE Conduit .....78

    F. Duct and Conduit Sealer .....78

7.3. CONSTRUCTION METHODS .....78

    A. General.....78

    B. Trenching .....82

    C. Plowing (HDPE Conduit Only) .....84

    D. Directional Drilling.....84

    E. Maximum Length of Directional Drill.....86

7.4. MEASUREMENT AND PAYMENT .....87

**8. JUNCTION BOXES .....89**

8.1. DESCRIPTION .....89

8.2. MATERIALS .....89

    A. General.....89

    B. Polymer Concrete (PC) Junction Boxes .....89

    C. Junction Box Sizes.....90

8.3. CONSTRUCTION METHODS .....90

    A. General.....90

    B. GPS Coordinates.....91

8.4. MEASUREMENT AND PAYMENT .....91

**9. WOOD POLES .....93**

9.1. DESCRIPTION .....93

9.2. MATERIALS .....93

    A. General.....93

    B. Wood Poles for Signals.....93

    C. Wood Poles for Signals with CCTVs .....93

D.	Span Transfers .....	94
9.3.	CONSTRUCTION METHODS .....	94
A.	General .....	94
B.	Pole Grounding System .....	95
C.	Span Transfers .....	95
9.4.	MEASUREMENT AND PAYMENT .....	96
<b>10.</b>	<b>GUY ASSEMBLIES .....</b>	<b>97</b>
10.1.	DESCRIPTION .....	97
10.2.	MATERIALS .....	97
10.3.	CONSTRUCTION METHODS .....	97
A.	General .....	97
B.	Guy Assemblies for Signal Heads or Loop Lead-in Cable .....	97
C.	Guy Assemblies for Communications Cable .....	98
10.4.	MEASUREMENT AND PAYMENT .....	98
<b>11.</b>	<b>RISER ASSEMBLIES .....</b>	<b>100</b>
11.1.	DESCRIPTION .....	100
11.2.	MATERIALS .....	100
11.3.	CONSTRUCTION METHODS .....	101
11.4.	MEASUREMENT AND PAYMENT .....	102
<b>12.</b>	<b>INDUCTIVE DETECTION LOOPS .....</b>	<b>104</b>
12.1.	DESCRIPTION .....	104
12.2.	MATERIALS .....	104
A.	Loop Sealant .....	104
B.	Loop Wire .....	104
C.	Conduit .....	105
12.3.	CONSTRUCTION METHODS .....	105
12.4.	MEASUREMENT AND PAYMENT .....	106
<b>13.</b>	<b>LEAD-IN CABLE .....</b>	<b>107</b>
13.1.	DESCRIPTION .....	107
13.2.	MATERIALS .....	107
13.3.	CONSTRUCTION METHODS .....	107
13.4.	MEASUREMENT AND PAYMENT .....	108
<b>14.</b>	<b>FIBER-OPTIC CABLE .....</b>	<b>109</b>
14.1.	DESCRIPTION .....	109
14.2.	MATERIALS .....	109
A.	General .....	109
B.	SMFO Communications Cable .....	109
C.	Drop Cable .....	110
D.	Communications Cable Identification Markers .....	110
E.	Fiber-Optic Cable Storage Guides .....	111
F.	Aerial Cable Protectors .....	111
14.3.	CONSTRUCTION METHODS .....	112
A.	General .....	112

B.	Aerial Installation.....	112
C.	Underground Installation .....	113
D.	Indoor Installation.....	114
E.	Installation of Drop Cable.....	114
F.	Aerial Cable Protector.....	115
14.4.	MEASUREMENT AND PAYMENT .....	115
<b>15.</b>	<b>FIBER-OPTIC SPLICE CENTERS.....</b>	<b>117</b>
15.1.	DESCRIPTION .....	117
15.2.	MATERIALS .....	117
A.	Interconnect Center.....	117
B.	Splice Enclosure.....	117
15.3.	CONSTRUCTION METHODS.....	118
A.	General (Workmanship Identification Information).....	118
B.	Workmanship.....	118
C.	Termination and Splicing within Interconnect Centers .....	118
D.	Interconnect Centers in Controller Cabinets.....	119
E.	Termination and Splicing within Splice Enclosure .....	119
F.	Testing.....	119
15.4.	MEASUREMENT AND PAYMENT .....	120
<b>16.</b>	<b>DELINEATOR MARKERS .....</b>	<b>121</b>
16.1.	DESCRIPTION .....	121
16.2.	MATERIALS .....	121
A.	Delineator Markers .....	121
16.3.	CONSTRUCTION METHODS .....	122
A.	Delineator Markers in Historic Districts.....	122
B.	Delineator Markers .....	122
16.4.	MEASUREMENT AND PAYMENT .....	122
<b>17.</b>	<b>JUNCTION BOX MARKERS .....</b>	<b>123</b>
17.1.	DESCRIPTION .....	123
17.2.	MATERIALS .....	123
A.	Junction Box Markers.....	123
17.3.	CONSTRUCTION METHODS .....	124
A.	Junction Box Markers.....	124
17.4.	MEASUREMENT AND PAYMENT .....	124
<b>18.</b>	<b>REMOVE EXISTING COMMUNICATIONS CABLE .....</b>	<b>125</b>
18.1.	DESCRIPTION .....	125
18.2.	MATERIALS .....	125
18.3.	CONSTRUCTION METHODS .....	125
A.	General.....	125
B.	Removal of Aerial Communications Cable .....	125
C.	Removal of Underground Communications Cable.....	125
18.4.	MEASUREMENT AND PAYMENT .....	126

<b>19. CABLE TRANSFERS</b> .....	<b>128</b>
19.1. DESCRIPTION .....	128
19.2. MATERIAL .....	128
19.3. CONSTRUCTION METHODS .....	128
19.4. MEASUREMENT AND PAYMENT .....	128
<b>20. PEDESTALS</b> .....	<b>129</b>
20.1. DESCRIPTION .....	129
20.2. MATERIALS .....	129
A. General .....	129
B. Pedestal Shaft.....	129
C. Transformer Bases .....	130
D. Anchor Bolts .....	131
E. Pedestal Cap.....	132
F. Pole Flange Base for 4 ½ Inches Pipe.....	132
G. Breakaway Anchors .....	132
H. Foundation .....	132
I. Screw-In Helical Foundation Anchor Assembly .....	133
20.3. CONSTRUCTION METHODS .....	133
A. Type I Pedestrian Pushbutton Post .....	133
B. Type II and III Pedestals .....	134
C. Screw-In Helical Foundation Anchor Assembly: .....	134
20.4. MEASUREMENT AND PAYMENT .....	134
<b>21. SIGNS INSTALLED FOR SIGNALS</b> .....	<b>136</b>
21.1. DESCRIPTION .....	136
21.2. MATERIALS .....	136
21.3. CONSTRUCTION METHODS .....	136
21.4. MEASUREMENT AND PAYMENT .....	136
<b>22. SIGNAL CABINET FOUNDATIONS</b> .....	<b>137</b>
22.1. DESCRIPTION .....	137
22.2. MATERIALS .....	137
22.3. CONSTRUCTION METHODS .....	137
22.4. MEASUREMENT AND PAYMENT .....	139
<b>23. MODIFY CABINET FOUNDATIONS</b> .....	<b>140</b>
23.1. DESCRIPTION .....	140
23.2. MATERIALS .....	140
23.3. CONSTRUCTION METHODS .....	140
A. General.....	140
B. Install Conduit Entrance into Existing Foundation.....	140
C. Modify Foundation .....	140
D. Ground Surface Restoration.....	141
23.4. MEASUREMENT AND PAYMENT .....	141
<b>24. CONTROLLERS WITH CABINETS</b> .....	<b>143</b>
24.1. DESCRIPTION .....	143

24.2. MATERIALS - GENERAL.....143

24.3. MATERIALS – TYPE 2070LX CONTROLLERS .....143

24.4. MATERIALS – GENERAL CABINETS.....143

24.5. MATERIALS – TYPE 170E CABINETS .....144

    A. Type 170 E Cabinets General .....144

    B. Type 170 E Cabinet Electrical Requirements .....144

    C. Type 170 E Cabinet Physical Requirements.....151

    D. Model 2018 Enhanced Conflict Monitor: .....153

    E. Preemption and Sign Control Box .....163

24.6. MATERIALS – TYPE 170 DETECTOR SENSOR UNITS .....166

24.7. CONSTRUCTION METHODS .....166

    A. General.....166

    B. Electrical Service and Grounding .....167

    C. Edge Switch .....167

    D. Workshop.....167

    E. GPS Coordinates.....168

24.8. MEASUREMENT AND PAYMENT .....168

**25. RELOCATE EXISTING CABINET EQUIPMENT.....170**

    25.1. DESCRIPTION .....170

    25.2. CONSTRUCTION METHODS .....170

    25.3. MEASUREMENT AND PAYMENT .....170

**26. CABINET BASE ADAPTER/BASE EXTENDER.....171**

    26.1. DESCRIPTION .....171

    26.2. MATERIALS .....171

    26.3. CONSTRUCTION METHODS .....171

        A. General.....171

    26.4. MEASUREMENT AND PAYMENT .....171

**27. ELECTRICAL SERVICE .....172**

    27.1. DESCRIPTION .....172

    27.2. MATERIALS .....172

        A. Electrical Service .....172

        B. Grounding Electrodes .....173

        C. Grounding System .....174

    27.3. CONSTRUCTION METHODS .....174

        A. General.....174

        B. New Electrical Service for Traffic Signal.....175

        C. Modify Existing Electrical Service.....175

        D. Grounding of Electrical Services .....176

    27.4. MEASUREMENT AND PAYMENT .....177

**28. TRAFFIC SIGNAL SUPPORTS .....179**

    28.1. METAL TRAFFIC SIGNAL SUPPORTS – ALL POLES .....179

        A. General:.....179

        B. Materials: .....181

        C. Construction Methods:.....182



28.2. METAL POLE UPRIGHTS (VERTICAL MEMBERS).....	182
A.    Materials: .....	182
28.3. DRILLED PIER FOUNDATIONS FOR METAL TRAFFIC SIGNAL POLES .....	184
A.    Description: .....	185
B.    Soil Test and Foundation Determination: .....	185
C.    Drilled Pier Construction: .....	187
28.4. POLE NUMBERING SYSTEM .....	188
A.    New Poles .....	188
B.    Reused Poles .....	188
28.5. MEASUREMENT AND PAYMENT .....	188
<b>30. PROTECTIVE COATING FOR METAL POLES.....</b>	<b>189</b>
30.1. DESCRIPTION .....	189
30.2. MATERIALS .....	189
30.3. COATING SHOP APPROVAL .....	189
30.4. POWDER COATING .....	190
A.    Galvanizing .....	190
B.    Surface Preparation .....	190
C.    Powder Coating Application and Curing.....	191
D.    Quality Control .....	191
E.    Storage, Shipping, and Handling .....	191
F.    Repair of Powder Coated Material .....	191
30.5. ACRYLIC PRIMER AND TOP COAT PAINT SYSTEM 4 (MODIFIED) .....	192
A.    Description .....	192
B.    Surface Preparation.....	192
C.    Materials .....	192
D.    Painting .....	192
E.    Curing .....	193
F.    Inspection .....	193
G.    Handling.....	193
H.    Repair of Damaged Coating.....	193
30.6. MEASUREMENT AND PAYMENT .....	194
<b>31. ETHERNET CABLE.....</b>	<b>195</b>
31.1. DESCRIPTION .....	195
31.2. MATERIALS .....	195
A.    Ethernet Cable.....	195
B.    Cable Management .....	196
C.    Connectors .....	197
D.    Ethernet Patch Cable:.....	197
E.    Environmental Requirements.....	197
31.3. CONSTRUCTION METHODS .....	198
A.    General .....	198
B.    Aerial Installation.....	198
C.    Messenger Cable Installation .....	198
D.    Underground Installation .....	198
E.    Above-Ceiling Installation.....	199

F. Ethernet Patch Cords.....199

31.4. MEASUREMENT AND PAYMENT .....199

**32. CCTV FIELD EQUIPMENT .....200**

32.1. DESCRIPTION .....200

32.2. MATERIALS .....200

A. General.....200

B. Standards.....201

C. Camera Assembly .....201

D. Camera Mounting Bracket.....203

E. Video Encoder .....204

F. Surge Suppression.....204

G. Grounding .....205

H. Ethernet Cable.....205

32.3. CONSTRUCTION METHODS .....205

A. Electrical and Mechanical Requirements.....205

B. Shared CCTV/Traffic Signal Cabinet.....205

C. Grounding .....205

D. Category 6 Cable.....205

E. Surge Protection.....205

F. CCTV Camera Attachments .....206

G. CCTV Device Database .....206

32.4. MEASUREMENT AND PAYMENT .....206

**33. CCTV SOFTWARE AND INTEGRATION.....207**

33.1. DESCRIPTION .....207

33.2. MATERIALS .....207

33.3. CONSTRUCTION METHODS .....207

33.4. MEASUREMENT AND PAYMENT .....207

**34. SIGNAL SYSTEM SOFTWARE.....208**

34.1. DESCRIPTION .....208

34.2. GENERAL REQUIREMENTS.....208

A. Signal System Software .....208

B. Functional Requirements .....210

C. Local Controller Firmware .....224

D. System Support Software and Devices .....225

34.3. INSTALLATION AND INTEGRATION.....225

A. General.....225

B. Distributed Processing Signal System Software.....225

C. Local Controller Firmware .....226

D. System Support Software and Devices .....226

34.4. TESTING .....226

A. General.....226

B. System Demonstration .....227

34.5. MEASUREMENT AND PAYMENT .....227

**35. COMPUTER HARDWARE AND PERIPHERALS.....229**

35.1. DESCRIPTION ..... 229

    A. ITS Servers..... 229

    B. Laptop Computers..... 229

    C. KVM Switch ..... 229

    D. UPS – Signal System Supervisor’s Laptop..... 229

35.2. MATERIALS ..... 230

    A. ITS Servers..... 230

    B. Laptop Computers..... 232

    C. Workstation Monitors ..... 233

    D. Docking Station ..... 233

    E. KVM Switch ..... 233

    F. UPS - Workstation ..... 234

35.3. CONSTRUCTION REQUIREMENTS ..... 235

    A. General ..... 235

    B. ITS Servers..... 236

    C. Laptop Computers..... 236

    D. KVM Switch ..... 236

    E. UPS - Workstation ..... 237

35.4. DOCUMENTATION ..... 237

35.5. WARRANTY ..... 237

35.6. MEASUREMENT AND PAYMENT ..... 237

**36. COMMUNICATIONS HARDWARE ..... 239**

36.1. DESCRIPTION ..... 239

    A. Ethernet Core Switch ..... 239

    B. Ethernet Edge Switch..... 239

    C. Firewall ..... 239

    D. Network Management Software ..... 239

    E. Uninterruptible Power Supply (UPS) – Communications Rack..... 239

36.2. MATERIALS ..... 240

    A. General ..... 240

    B. Ethernet Core Switch ..... 240

    C. Ethernet Edge Switch..... 245

    D. Firewall ..... 249

    E. Uninterruptible Power Supply (UPS) – Communications Rack..... 251

36.3. CONSTRUCTION METHODS ..... 253

    A. General ..... 253

    B. Ethernet Switches..... 253

    C. Firewall ..... 254

    D. Network Management Software ..... 255

    E. Uninterruptible Power Supply (UPS) in Communications Rack..... 255

36.4. MEASUREMENT AND PAYMENT ..... 255

**37. DIGITAL VIDEO EQUIPMENT ..... 257**

37.1. DESCRIPTION ..... 257

37.2. MATERIALS ..... 257

A.	Digital Video Monitors .....	257
B.	Digital Video Monitor Mounting System .....	258
C.	PTZ Joysticks .....	258
37.3.	CONSTRUCTION METHODS .....	258
A.	General .....	258
B.	Video Server .....	258
C.	Digital Video Monitors .....	259
D.	PTZ Joysticks .....	259
37.4.	MEASUREMENT AND PAYMENT .....	259
<b>38.</b>	<b>COMMUNICATIONS RACKS .....</b>	<b>260</b>
38.1.	DESCRIPTION .....	260
38.2.	MATERIALS .....	260
38.3.	CONSTRUCTION METHODS .....	260
38.4.	MEASUREMENT AND PAYMENT .....	260
<b>39.</b>	<b>BUILDING MODIFICATIONS AND FIBER-OPTIC CABLE TERMINATION.....</b>	<b>261</b>
39.1.	DESCRIPTION .....	261
39.2.	MATERIALS .....	261
A.	General .....	261
B.	Fiber-Optic Splicing and Termination .....	261
C.	Traffic Management Center (TMC) Building Modifications .....	262
39.3.	CONSTRUCTION METHODS .....	262
A.	General .....	262
B.	Traffic Management Center (TMC).....	263
39.4.	MEASUREMENT AND PAYMENT .....	263
<b>40.</b>	<b>SUBMITTAL DATA AND DOCUMENTATION.....</b>	<b>265</b>
40.1.	DESCRIPTION .....	265
40.2.	SUBMITTALS .....	265
A.	General .....	265
B.	Project Construction Schedule .....	265
C.	Qualified Products .....	266
D.	System Design Report.....	266
E.	Fiber-optic Splicing Drawings .....	266
F.	Submittal Requirements.....	266
40.3.	DOCUMENTATION .....	268
A.	General .....	268
B.	Plan of Record Documentation .....	268
C.	Manuals .....	269
D.	Wiring Diagrams .....	270
E.	Splice Diagrams .....	270
40.4.	MEASUREMENT AND PAYMENT .....	270
<b>41.</b>	<b>SYSTEM SUPPORT AND TEST EQUIPMENT .....</b>	<b>271</b>
41.1.	DESCRIPTION .....	271
41.2.	MATERIALS .....	271
A.	General .....	271

B.	Conflict Monitor Tester with Notebook Computer .....	271
C.	2070 Controller Tester .....	271
D.	Test Controllers with Cabinets.....	271
41.3.	MEASUREMENT AND PAYMENT .....	272
<b>42.</b>	<b>TRAINING .....</b>	<b>274</b>
42.1.	DESCRIPTION .....	274
42.2.	MATERIALS .....	274
A.	General .....	274
B.	Ethernet Communications and Networking.....	276
C.	CCTV Field Equipment .....	278
D.	Digital Video Equipment .....	278
E.	Signal System Software .....	279
F.	CCTV and Video Wall Software .....	279
G.	Maintenance Management System Software.....	280
H.	2070LX Controllers, Conflict Monitors, Cabinets and Controller Firmware.....	280
I.	UPS .....	282
42.3.	MEASUREMENT AND PAYMENT .....	282
<b>43.</b>	<b>TESTING AND ACCEPTANCE .....</b>	<b>283</b>
43.1.	GENERAL .....	283
43.2.	INSTALLED SITE TESTS .....	283
A.	Fiber-Optic Cable.....	284
B.	Ethernet Communications System.....	284
C.	Traffic Signal Controllers and Conflict Monitors.....	285
D.	Communications System Support Equipment .....	285
E.	CCTV Field Equipment .....	285
F.	Central Digital Video Equipment .....	286
G.	UPS in Communications Rack.....	286
43.3.	SYSTEM TESTING.....	287
A.	General .....	287
B.	CCTV Subsystem.....	287
C.	Traffic Signal Subsystem .....	288
D.	System Operational Test .....	289
43.4.	OBSERVATION PERIOD.....	290
A.	General .....	290
B.	CCTV Subsystem.....	291
C.	Traffic Signal Subsystem .....	291
43.5.	MEASUREMENT AND PAYMENT .....	291
43.6.	FINAL ACCEPTANCE .....	291

This page left blank intentionally.

## 1. GENERAL REQUIREMENTS

### 1.1.DESCRPTION

#### A. Summary of Work

The purpose of this project is to construct a new computerized traffic signal system in Elizabeth City, North Carolina. Work will be primarily comprised of a new fiber-optic communications system, field equipment upgrades, the replacement of multiple independent arterial closed-loop traffic signal systems with a new, centrally managed distributed processing traffic control system, creation of a new NCDOT Traffic Management Center (TMC) at the local District office in Elizabeth City, and the upgrade and expansion of the existing video monitoring system. This project includes:

- Signal upgrades at selected locations and replacement of existing controllers and cabinets with new Model 2070LX controllers housed in Model 332 cabinets for 44 signalized intersections;
- Replacement of multiple independent single-mode fiber-optic serial communications systems with a new Ethernet-based, fault-tolerant, single-mode fiber-optic communications comprised of approximately 18 roadway miles of fiber-optic cable (including reuse of approximately 1500 feet installed by others under NCDOT Project U-4438);
- Upgrading and expanding the existing video monitoring system by integrating one existing digital CCTV camera with 20 new digital Internet Protocol (IP) camera locations (21 total locations), and replacing the existing central video equipment/software and database; and
- Replacing the existing closed-loop signal system software with new distributed processing software and new computer workstations and servers.

All of the existing 2070 controllers and cabinets are to be replaced with Model 2070LX controllers in Type 332 with Auxiliary files under this project.

In addition to signals in multiple existing closed-loop systems, there are several existing standalone (i.e., isolated) signals with 2070 controllers and cabinets that will be brought into the expanded signal system by extending new fiber-optic communications cable to these intersections and replacing the existing equipment with new Model 2070LX controllers, Ethernet edge switches and controller cabinets.

New fiber-optic communications cable will be installed primarily by overlashing to the existing fiber-optic communications cable but also by lashing to new messenger cable, installing in existing underground conduit/duct systems, and installing in new underground conduit/duct systems. To migrate from the existing to the new communications system while minimizing disruptions to signal system operations, the existing fiber-optic communications system will be progressively decommissioned as the new Ethernet-based fiber-optic communications system is built-out and brought online.

Provide a complete, fully functional, and fully integrated traffic signal system, video surveillance system, and Ethernet communications system. Perform the following major tasks under this contract, as shown in the Plans (the list that follows is not meant to be all-inclusive):

- Furnish and install a new Ethernet-based fiber-optic communications system for the traffic signal system comprised of fiber-optic cable, fiber-optic drop cables, and fiber-optic splice centers (i.e., splice enclosures, interconnect centers, etc.), Ethernet switches and related electronics;
- Furnish and install underground conduit/duct, junction boxes, risers with heat shrink tubing, risers with weatherheads, messenger cable, fiber-optic cable storage guides, wood poles, and pole guy assemblies with guy guards;
- Furnish and install managed Ethernet core switch and Ethernet edge switches;
- Furnish and install new traffic signal controllers and cabinets with ancillary equipment, extending existing field wiring as necessary;
- Modify existing cabinet foundations and install new cabinet foundations;
- Upgrade existing traffic signal displays;
- Furnish and install pedestrian signals at 4 locations;
- Remove existing control equipment and cabinets;
- Remove existing fiber-optic communications cable, including associated risers, and junction boxes, where designated in the Plans;
- Furnish and install detector loops, junction boxes, and lead-in cables;
- Furnish and install signal cable;
- Furnish and install CCTV camera assemblies;
- Install 50' wood CCTV poles at designated locations;
- Modify existing electrical services and install new electrical services and associated grounding;
- Fully integrate all components into a fully-functioning Ethernet-based, fiber-optic communications network;
- Fully integrate all traffic signal controllers, system detectors, software, computers and servers into a fully functioning distributed processing traffic control system; and
- Fully integrate all CCTV cameras, video components and software into a fully functioning video monitoring system. Connection to Statwide Traffic Operations Center (STOC)

### **B. Specifications and Special Provisions**

Conform to these Project Special Provisions and the North Carolina Department of Transportation (NCDOT) *Standard Specifications for Roads and Structures*, dated January 2018, hereinafter referred to as the “*Standard Specifications*.” Conform to the Codes and Regulations described in Section 1700 of the *Standard Specifications*.

Within these Project Special Provisions, the “Department” refers to the North Carolina Department of Transportation.

### **C. Coordination of Plans, Specifications, and Special Provisions**

The *Standard Specifications*, the Plans and these Project Special Provisions are essential parts of the contract, and a requirement occurring in one is as binding as though occurring in all. They are complementary and provide and describe the complete contract. In case of a discrepancy or conflict, the following will apply in ascending order:

- Calculated dimensions shall govern over scaled dimensions;



- Supplemental Specifications shall govern over *Standard Specifications*;
- Plans shall govern over Supplemental Specifications, *Standard Specifications* and *Roadway Standard Drawings*;
- Project Special Provisions shall govern over Standard Special Provisions, Plans, *Standard Specifications*, Supplemental Specifications and *Roadway Standard Drawings*.

In the event of a contradiction within the Project Special Provisions as to the measurement and payment of any pay item, the text of the respective Measurement and Payment subsection for the pay item in question shall govern.

The Contractor shall not take advantage of any apparent error or omission in the contract. In the event such errors or omissions are discovered, the Engineer will make such corrections and interpretations as may be determined necessary for the fulfillment of the intent of the contract.

## **1.2.MATERIALS**

### **A. Qualified Products**

Furnish new equipment, materials, and hardware unless otherwise required. Inscribe manufacturer's name, model number, serial number, and any additional information needed for proper identification on each piece of equipment housed in a case or housing.

2018 ITS and Signals Qualified Products List (QPL) is available on the North Carolina Department of Transportation's website at the following address:

<https://connect.ncdot.gov/resources/safety/Pages/ITS-and-Signals-Qualified-Products.aspx>

Certain signal and communications equipment, material, and hardware shall be pre-approved on the QPL by the date of installation. Equipment, material, and hardware not pre-approved when required will not be allowed for use on the project. Consult the QPL website to obtain pre-approval procedures.

### **B. Submittal Requirements**

Furnish a Type 3 material certification in accordance with Article 106-3 of the *Standard Specifications*. When requested by the Department, provide additional certifications from independent testing laboratories and sufficient data to verify item meets applicable specifications. Ensure additional certification states the testing laboratory is independent of the material manufacturer and neither the laboratory nor the manufacturer has a vested interest in the other.

Identify all proprietary parts in Contractor-furnished material. The Department reserves the right to reject material that uses proprietary components not commercially available through electronic or electrical supply houses.

For Contractor-furnished material listed on the QPL, furnish submittals in the format defined by the QPL.

For Contractor-furnished material not on the QPL, furnish three copies of the equipment list including three copies of catalog cuts. Identify proposed material on catalog cuts by a reproducible means (highlighter pen does not transfer to copies). Ensure material lists contain material description, brand name, manufacturer's address and telephone number, stock number, size, identifying trademark or symbol, and other appropriate ratings.

Do not fabricate or order material until receipt of the Engineer's approval.

In addition, refer to the following sections of these Project Special Provisions:

- "Submittal Data and Documentation".

### **C. Observation Period**

Prior to final acceptance, all Contractor-furnished equipment and software shall successfully complete a 60-day Observation Period.

The 60-day Observation Section Period is considered to be part of the work included in the total contract time and must be completed prior to final acceptance of the project.

Final acceptance will occur following the successful completion of the 60-day Observation Period and after all documentation requirements have been fully satisfied.

In addition, refer to the following sections of these Project Special Provisions:

- "Testing and Acceptance".

### **D. Warranties**

Unless otherwise required herein, provide manufacturer's warranties on Contractor-furnished equipment for material and workmanship that are customarily issued by the equipment manufacturer and that are at least one year in length from the date of final acceptance of the project by the Department. Include unconditional coverage for all parts and labor necessary or incidental to repair of defective equipment or workmanship and malfunctions that arise during warranty period.

For light emitting diode (LED) traffic signal modules, provide a written warranty against defects in materials and workmanship for a period of 60 months after installation of the modules. During the warranty period, the manufacturer must provide replacement modules within 45 days of receipt of modules that have failed at no cost to the Department.

Ensure all Contractor-furnished equipment, including pieces and components of equipment, hardware, firmware, software, middleware, internal components, and subroutines which perform any date or time data recognition function, calculation, or sequencing will support a four digit year format for a period of at least 50 years and will support user-definable parameters for setting the start and end dates for daylight savings time.

Upon receipt of the Department's written final acceptance of project, transfer manufacturer's warranties with proper validation by the manufacturer to the Department. Provide warranties in te name of North Carolina Department of Transportation.

### **E. Firmware Licensing and Upgrades**

**Provide the Department with a license to duplicate all programmable devices in equipment for maintenance and software upgrades.** Provide binary or hexadecimal format files for each device that may be programmed by the Department. Ensure files are provided on PC compatible compact disks or other approved media.

Ensure software/firmware performance upgrades that occur during the contract period up through final acceptance of the project are furnished to the Department at no additional cost.

Make software/firmware upgrades that are developed to correct operating characteristics available to the Department at no additional cost until the warranty period expires.

Provide licensed copies of all software/firmware to the Department for any programmable devices furnished by the Contractor and installed under this project for which licensed software has not already been provided by the Department. The Department shall have the right to install any and all software/firmware for maintenance and support on all hardware provided under this contract. This shall include but not be limited to all servers for the Signal System, CCTV System, LAN System, traffic signal controllers and network. Provide software/firmware for maintenance and support of workstations, laptop computers, system support software, utility software, traffic signal controllers, and CCTV systems and controllers, and all other programmable devices.

#### **F. Wire and Cable**

Furnish wire and cable on reels. When requested by the Department, furnish samples of wire and cable to the Department at no additional cost.

#### **G. Painting**

Where painting of signal heads, signal poles, and pedestals is required, apply paint at the factory. No field painting will be allowed except when paint has been scratched or marred. In such cases, apply two field coats of the same color and grade enamel as the original paint to the scratched or marred portions. For the aforementioned unfinished components that require field painting, prepare the surface to receive the paint in accordance with the coating manufacturer's instructions, including application of primer.

#### **H. Performance of Warranty Repair and Maintenance**

Provide authorization to the Traffic Electronics Center of the North Carolina Department of Transportation (NCDOT) to perform all warranty repairs after project acceptance. The decision to perform warranty work at the Traffic Electronics Center by NCDOT electronics technicians or to have warranty work performed by the vendor shall be at the discretion of the Department. Provide any training required by the manufacturer to authorize the Traffic Electronics Center to perform warranty work and ensure manufacturer will furnish parts to the Traffic Electronics Center for all warranty repairs at no cost to the Department. In addition, ensure the manufacturer agrees to provide prompt technical support to the NCDOT electronics technicians for a period of one year after the end of the warranty period at no cost to the Department. Defective parts replaced under warranty by the Traffic Electronics Center will be returned to the vendor at the vendor's request. Provide schematics, part lists, and other documentation to perform bench repair to the Traffic Electronics Center within 2 weeks upon request. The Department agrees not to divulge any proprietary information in the schematics, part lists and other documentation upon request from the vendor. After project acceptance and at the request of the Department, the manufacturer shall perform warranty repairs to equipment which fails during the warranty period at no cost to the Department including freight costs to ship repaired equipment back to the Traffic Electronics Center. Ensure all equipment is repaired and returned to the Traffic Electronics Center within 21 calendar days of receipt by the manufacturer.

### 1.3.CONSTRUCTION METHODS

#### A. General

**Before beginning signal work, verify all existing signal equipment is in satisfactory working order. Report all defective signal equipment to the Engineer so as not to be held responsible for defects.**

Identify and label all field wiring (e.g., signal conductors, pushbutton wires, loop detector lead-ins, etc.) in existing controller cabinets prior to disconnecting any field wiring.

Do not remove and replace more than one controller and cabinet per day unless otherwise approved by the Engineer. Once controller and cabinet replacement has begun at a given location, complete the removal and replacement work at that location before beginning removal and replacement of a controller and cabinet at another location.

Locate existing conduit, cable runs, inductive detection loops, lead-in, junction boxes, and detection equipment before installing or using equipment that can damage or interfere with such facilities. The locations of existing inductive detection loops shown on the Plans are approximate.

**Locate all underground utilities before beginning drilling, digging, and trenching operations. Contractor shall contact NC 811 and provide ticket No. to Engineer upon request.**

Immediately cease work and notify the Engineer and affected owners if damage to existing utilities, cables, or equipment occurs. Make all required repairs and replacements at no additional cost to the Department.

#### B. Work within Historic Districts

Several signalized intersections, proposed CCTV cameras and several fiber-optic communications cable routes lie within or adjacent to historic districts. The Department has coordinated with the agencies that have jurisdiction over these historic districts and has received the permits and certificates for the work called for in the Plans in these historic districts. Do not deviate from the work called for in the Plans within a historic district without the prior approval of the Engineer and the agency/agencies that have jurisdiction over the historic district. Where construction work must deviate from the Plans, notify the Engineer in advance so that the Department can request/apply for the appropriate approvals for such changes prior to the Contractor performing work at that location.

Avoid damaging or removing sidewalks and curbs within designated historic districts whenever possible.

Where removal and replacement of concrete sidewalk is unavoidable, removal and replacement shall be in accordance with the "Signal Cabinet Foundations" section of these Project Special Provisions.

Where removal and replacement of sidewalk constructed of materials other than concrete is unavoidable, replace the sidewalk with in-kind materials that match the finish, appearance and color of the adjacent existing sidewalk as close as technically feasible as determined by the Engineer. If the sidewalk is constructed of materials such as brick, stone or pavers, carefully remove and subsequently reinstall the bricks, stones or pavers using methods approved by the

Engineer. If bricks, stones or pavers are broken, contact the Engineer for appropriateness of replacement materials. Take photographs and make sketches to record the pattern of the existing materials prior to removal. Replace any bricks, stones or pavers damaged due to construction on this project with approved in-kind, matching materials.

Repair and replacement of existing sidewalk will be measured and paid for in accordance with the "Signal Cabinet Foundations" section of these Project Special Provisions.

**Complete all repairs with in-kind materials to all sidewalks removed for construction and reopen the repaired and restored sidewalk to pedestrian traffic within five consecutive calendar days following initial removal.** If the Contractor fails to repair and reopen a sidewalk in accordance with these Project Special Provisions within the time frame specified, the Department reserves the right to make the necessary repairs, and all expenses incurred by the Department in making the repairs and restoring the sidewalk will be deducted from payment due the Contractor, plus **\$500 liquidated damage per occasion, per day, or any portion thereof,** until corrected.

Do not trim, remove or damage tree limbs within historic districts. Hand-lashing of aerial cables to messenger cable may be required in some areas due to overhanging and protruding tree limbs along the cable route.

### **C. Regulations and Codes**

Furnish material and workmanship conforming to the *National Electric Code* (NEC), *National Electric Safety Code* (NESC), Underwriters Laboratories (UL), or other listing agencies approved by the North Carolina Department of Insurance, and all local safety codes in effect on the date of advertisement. Comply with Article 4, Chapter 87 of the *North Carolina General Statutes* (Licensing of Electrical Contractors). Comply with all regulations and codes imposed by the owner of the affected utility poles. Comply with the Plans, all previously referenced specifications, and all applicable local ordinances and regulations before and during all stages of the electrical work.

When required by the local ordinances and governmental agencies, upon completion of the work, the Contractor shall coordinate with the authorized governmental electrical inspector for the area to have all systems inspected and approved in writing by that authorized governmental electrical inspector. Furnish written certification of the authorized inspector's approval to the Engineer. Inspection by the authorized governmental electrical inspector does not eliminate nor take the place of the inspections by the Engineer. Upon the Engineer's receipt of written certification and the Contractor's written request for a final inspection of the installations, the Engineer will perform a final inspection.

Where required, conform to ITE, AASHTO, and ASTM standards in effect on the date of advertisement.

Notify the Engineer, local traffic enforcement agency, local utility company, and affected railroad companies seven business days before operational shutdowns to coordinate connection or disconnection to an existing utility or system, unless otherwise instructed herein.

Install meter bases and service disconnects as required by the NESC, NEC, local utility companies, and local ordinances. Install standoffs only when required and approved by the local utility companies. Where a standoff must be used, obtain the local utility company's approval prior to installing the standoff.

#### D. Utility Services

Coordinate all work to ensure electrical power of proper voltage, phase, frequency, and ampacity is available to complete the work. Use electrical service cables with THWN insulation.

When electrical, telephone, and telecommunication service is not furnished by the Department and is required, contact the utility company and make application to ensure all work can be completed. Obtain authorization for service in the Department's name and make application for service in the Department's name along with the associated NCDOT Asset Inventory Number shown in the contract. Notify the Engineer immediately if this number is not shown in the contract.

The Department will be responsible for direct payment of monthly utility company usage charges. The Contractor will be responsible for all expenses associated with utility installation costs, hookups, etc.

Coordinate all work involving electrical service with the appropriate electric utility company. Coordinate with the utility company to ascertain the feasibility of installing electrical service at each location before performing any work. Obtain all required local permits before beginning work.

#### E. Maintenance and Repair of Material

Ensure that an IMSA certified, or equivalent, Level II traffic qualified signal technician is standing by to provide emergency maintenance services whenever work is being performed on traffic signal controller cabinets and traffic signal controller cabinet foundations. Standby status is defined as being able to arrive, fully equipped, at the work site within 30 minutes ready to provide maintenance services.

Furnish the Engineer with the name, office telephone number, cellular (mobile) telephone number, and pager number of the supervisory employee who will be responsible for maintenance and repair of equipment during all hours.

Maintain and repair all Contractor-furnished and installed signal and communications related equipment within the project construction limits until completion of the Observation Period and receipt of written notification of final acceptance of the project. This requirement for maintaining and repairing said equipment shall remain in effect in the event of severe weather (see NOAA National Severe Storms Laboratory website <http://www.nssl.noaa.gov/primer/>) or a natural disaster, including but not limited to floods, winter weather, lightning, damaging winds, hail, tornado, tropical storm or hurricane. Items reused (that are unmodified), such as signal heads, signal cable, local detector loops and lead-in cable, will be maintained by others.

Make entries into the maintenance diaries housed inside each traffic signal controller cabinet upon each visit to the controller cabinet. Maintain these diaries through final acceptance of the project.

**For all failures, malfunctions, damages to equipment, or errors in workmanship affecting signal operation, begin necessary repairs within 4 hours of notification. Complete repairs within 8 hours of notification.** Comply with Section 150 of the *Standard Specifications* for maintenance of traffic flow. The inability to contact the supervisory employee or prearranged alternate will not extend repair time requirements.

Remove and replace all signal and communications related equipment that fails. The Department will furnish the Contractor replacement equipment for Department-furnished equipment that fails.

Except for damages and malfunctions caused by the Contractor's work activities, the Contractor will not be held responsible for pre-existing conditions reported to the Engineer before starting traffic signal work at the specific intersection. The Contractor will assume responsibility for all maintenance and emergency services necessary once traffic signal work has begun at the specific intersection and for all damages and malfunctions caused either directly or indirectly by the Contractor's work activities.

Perform maintenance (testing) on all traffic signal conflict monitors every 12 months for the life of the project beginning with the initial test and every 12 months thereafter. Provide initial test date via the manufacturer's certification or via testing prior to installation of the conflict monitor at an intersection. Use ATSI Incorporated Model PCMT-8000 Conflict Monitor Tester or an Engineer approved equivalent. Use a signal conflict monitor tester that is capable of interfacing with an Intel®-based notebook computer for input/output. The tester shall test signal conflict monitor displays, timing and voltage functions, and input/output combinations of either true or false conflicts. All outputs shall be in plain English. It shall be possible to generate a hard copy printout or to store the results to a file on computer disc. A "No Faults Detected" indication shall be displayed as appropriate.

Ensure that the signal conflict monitor tester is maintained and calibrated per the manufacturer's recommendation. Provide to the Engineer a copy of the manufacturer's certification that the signal conflict monitor tester is in proper working order before testing any traffic signal conflict monitors. Perform test on each traffic signal conflict monitor per the manufacturer's recommendation. For each traffic signal conflict monitor tested, provide two (2) dated copies of the traffic signal conflict monitor test results: one copy for the Engineer and one copy placed in the traffic signal controller cabinet.

In the event the Contractor fails to perform in accordance with the Plans and Project Special Provisions within the time frame specified, the Department reserves the right to perform maintenance and emergency service necessary to ensure continuous traffic signal operation. Further, all expenses incurred by the Department in implementing this option will be deducted from payment due the Contractor, plus **\$2,500 liquidated damages per occasion, per day, or any portion thereof**, until corrected.

#### **F. Inspections**

The Department may access the Contractor's equipment to perform railroad, signal, and preventative maintenance inspections or conflict monitor certification as necessary. The Contractor shall be present for these inspections.

#### **G. Removal of Existing Equipment and Material**

Remove all Department-owned signal, CCTV and communications related equipment and material that will not be used. Signal, CCTV and communications equipment and materials to be removed under this project include, but are not limited to: signal controllers and cabinets and the equipment housed therein; signal and lead-in cables; poles; cabinet foundations; junction boxes; messenger cable; communications cable; and guy assemblies.

Assume ownership of removed poles (including stub poles), messenger cable, junction boxes, interconnect cable, communications cable, and supporting hardware, unless otherwise specified. Return all other equipment and material between 8 a.m. and 12 p.m., Monday through Thursday, to the Traffic Services Office within the Division responsible for administration of the project. Contact the Division 1 Signal Department at (252) 482-1850 in advance of each delivery to schedule a mutually agreed up day and time for delivery of removed materials and equipment.

Label all returned equipment and material to indicate the location from which it was removed. Replace or repair all material lost or damaged during its removal and transit. The Department will deduct the cost of Department-owned equipment damaged by the Contractor from money due to the Contractor.

### **H. Railroad Preemption**

Where railroad preemption is required, coordinate all work with the railroad. Do not place signals into operation until signal and railroad company equipment has been interconnected with required railroad-highway crossing devices and railroad preemption is working properly. Ensure preemption sequences begin immediately after activation of train detection. Contact and coordinate with the railroad company to schedule interconnection of the signal to the railroad controller cabinet. Install lead-in cable from the signal controller cabinet to a railroad company furnished and installed lockable junction box. Interconnection will be made by the railroad company. Provide fail-safe operation such that removal of voltage from the railroad side of the isolation relay will initiate the railroad preemption sequence.

Conduct a railroad-highway interconnection preemption inspection for each intersection prior to placing new signal equipment into steady operation. The inspection shall be performed with all appropriate Division and Railroad personnel in attendance. The signal shall pass all requirements of the preemption inspection before it can be accepted under the project by the Engineer. The railroad preemption inspection form is available on the NCDOT ITS & Signals Unit website:

<https://connect.ncdot.gov/resources/safety/Pages/ITS-and-Signals.aspx>

The Contractor, along with other appropriate personnel, shall conduct additional preemption inspections annually as long as the signal is in operation under the Contractor's jurisdiction until the signal is accepted by the Engineer.

### **I. Vehicle Preemption Systems**

Where required, implement and install vehicle preemption systems. Coordinate vehicle preemption work with the proper operating authority. Contact the proper operating authority and schedule installation of preemption equipment.

### **J. Timing of Signals**

The Contractor shall utilize experienced signal timing personnel to revise existing timings and to implement new timing values.

Modify proposed phasing and timing of existing controllers to accommodate all changes which result from installation of new equipment under this project. As directed, make modifications to existing coordination to account for changes in signal phasing. Convert and reinstall all existing time-based coordination, i.e. time-of-day plans, to function and operate in newly installed 2070LX equipment. Coordinate timing work with Department staff for



converting the existing offset references to new offset references. The Contractor will be responsible for installing the revised offset references once developed through coordination with and with approval of Department staff.

Submit requests for intersection timing parameters and data to the Engineer at least three weeks (15 business days) prior to needing them. The Department will provide existing intersection and system timing parameters (cycle, split and offset) and available custom graphics. Department-supplied intersection and system timing parameters, databases and timing plans will be provided in MS Excel format electronically as portable document format (PDF) files only.

The Contractor shall be responsible for converting Department-furnished timing data to ASC/3-2070™-formatted data and for loading all timing data into the controllers and conflict monitors. Submit the converted data files for review and approval by the Department at least two weeks (10 business days) prior to scheduled implementation. The Department will supply the signal timing parameters (cycle, split and offset) and available custom graphics for any signal requiring phasing changes.

The Department reserves the right to make, or have the Contractor make, field timing adjustments and modifications to coordination and offsets to account for changes in signal phasing and equipment operations necessary for pattern optimization and to eliminate identifiable, potential hazards to the motoring public. The Engineer will notify the Contractor of timing changes made or supply the Contractor with revised timing plans if the Department requires the Contractor to implement the timing changes.

#### **K. Wire and Cable**

For installation in a conduit system, lubricate cable and wires before installing in conduit. Use lubricant that will not physically or chemically harm cable jacket, wire insulation, and conduit.

Terminate all electrical wire and cable at recessed-screw or barrier type terminal blocks. Unless specifically allowed, connect no more than two conductors to the same terminal screw.

Only splice lead-in cables in junction boxes using UL®-approved, underground splice connectors or in condulets using heat shrink tubing. Make all attempts to terminate lead-in cable under recessed-screw or barrier type terminal blocks inside the signal cabinet. When necessary, and with the approval of the Engineer, lead-in cables may be spliced in the base extender/base adapter or inside signal cabinet with heat shrink tubing.

Splice all other electrical wire and cable (i.e., signal cable, etc.) inside signal cabinets at nickel-plated brass, recessed-screw, barrier-type terminal blocks. Do not splice any electrical wire or cable other than lead-in cables in junction boxes or condulets.

Maintain color coding of wires through each splice.

Protect ends of wire and cable from water and moisture.

Place permanent labels on all wires and cables to clearly identify each one. Use an indelible black ink marker or approved labeling devices to write on the permanent labels when required.

#### **L. Electrical Services and Grounding**

Where electrical services do not include an external electrical service disconnect, modify or replace the electrical service to add an electrical service disconnect and a new grounding

electrode system. Comply with the “Electrical Service” section of these Project Special Provisions.

Provide a grounding electrode system at all new electrical services. In addition to NEC requirements, test grounding electrode resistance for a maximum of 20 ohms. Furnish and install additional ground rods to grounding electrode system as necessary to meet test requirements.

Modify existing electrical services, as necessary, to meet the grounding requirements of the NEC, these Project Special Provisions, *Roadway Standard Drawings*, and the Plans. Remove any ground rods in the cabinet foundation and install a new grounding electrode system. Cut off abandoned ground rods in the cabinet foundation flush with the foundation surface. Where a grounding electrode system is connected to the electrical service in accordance with the NEC, test grounding electrode resistance for a maximum of 20 ohms. Grounding electrode resistance test must be verified or witnessed by the Engineer or the Engineer’s designated representative. Furnish and install additional ground rods to grounding electrode system as necessary to meet the Project Special Provisions, *Roadway Standard Drawings*, and test requirements. Refer to the “Electrical Service” section of these Project Special Provisions for additional requirements pertaining to grounding of electrical services.

Follow test equipment’s procedures for measuring grounding electrode resistance. When using clamp-type ground resistance meters, readings of less than 1 ohm typically indicate a ground loop. Rework bonding and grounding circuits as necessary to remove ground loop circuits and retest. If a ground loop cannot be identified and removed to allow the proper use of a clamp-type ground resistance meter, use the three-point test method.

Submit a completed Inductive Loop & Grounding Test Form available on the Department’s website. The form is located on the Department’s website at:

<https://connect.ncdot.gov/resources/safety/Pages/ITS-and-Signals.aspx>

Provide a length of marker tape 12 inches below finished grade directly over grounding electrodes and conductors.

### **M. Electrical Bonding**

Using an approved termination means, connect a number 14 AWG minimum 19-strand copper conductor (Type THWN) with green insulation to serve as an equipment grounding conductor to metal poles, vehicular and pedestrian signal pedestals, and other metallic components which are not otherwise bonded, through means approved by the Engineer. Use messenger cable on wood poles and metal strain poles to provide effective ground fault current path to ground.

### **N. Traffic Signal Activation**

Do not place signal in steady (stop-and-go) mode until inspected and authorized by the Engineer.

### **O. Requirements for Cables Crossing Railroads**

Copies of all executed railroad agreements and related correspondence may be obtained from the Engineer upon request.

## 1. Railroad Crossings

Application has been made with Chesapeake & Albemarle Railroad (CA) herein called the Railroad Company, for the encroachment agreements necessary under this Contract. Do not commence cable routings over or under railroad-owned facilities until notification and coordination with Engineer and the appropriate Railroad Company has occurred. Install fiber-optic communications cable as shown on the Plans. All work associated with the crossing is to conform to the Railroad Company's specifications.

For work within CA rights of way, comply with latest approved edition of General Specifications for Sub-grade and Above Grade Utility Crossings of Railroad's Right-of-Way.

For Directional Drilling of Conduit, provide a Frac-out Mitigation Plan as required.

Requirements are available on the website: [https://www.gwrr.com/real-estate/utility\\_occupancies](https://www.gwrr.com/real-estate/utility_occupancies).

Cable crossings include the following locations:

Plan Sheet	Location	Railroad Company
CRP-016	At-Grade Crossing across US 17-158 (Hughes Boulevard) / Crossing # 465 365S	CA
CRP-054	At-Grade Crossing across NC 344 (Halstead Boulevard Extension) / Crossing # 921 650Y	CA

## 2. Insurance Requirements

If required by the railroad, pay for railroad personnel to be present when work is performed.

In addition to any other forms of insurance or bonds required under the terms of the Contract and the *Standard Specifications*, take out and keep in force from the commencement of all construction on railroad right-of-way until the final inspection and acceptance of the project by the Engineer, insurance of the following kinds and amount. It is understood that the amounts specified are minimum amounts and that larger amounts may be carried if so desired. Any insurance taken out due to these requirements shall be subject to the approval of the Engineer, and the Railroad Companies as to form and amount. Furnish satisfactory policies prior to beginning of the work on railroad right-of-way.

Refer to the following web links for more specific insurance requirements and requirements for working on the rights-of-way of each railroad company. In the event of a conflict between the requirements of one or more railroad companies and the requirements contained in the Plans or these Project Special Provisions, the requirements of the railroad company shall govern.

Chesapeake & Albemarle Railroad:

[https://www.gwrr.com/real\\_estate/insurance\\_requirements](https://www.gwrr.com/real_estate/insurance_requirements)

### **Commercial General Liability Insurance**

Furnish evidence to the Engineer of Contractor's commercial General Liability Insurance coverage with a combined single limit of not less than \$2,000,000 for each occurrence and \$6,000,000 aggregate for operations performed on the railroad right-of-way. The Contractor's policy shall name the railroad company(ies) as an additional insured. If any part of the work is sublet, similar insurance in the same amounts and evidence thereof as required of the Prime Contractor shall be provided by or on behalf of the Subcontractor to cover Subcontractor's operations on the railroad right-of-way.

Keep such insurance in force until final inspection of the project, or that portion or portions within the railroad right-of-way, by the Engineer or, in the case of Subcontractors, until the Contractor furnishes a letter to the Engineer stating that the Subcontractor has completed his/her subcontracted work within the railroad right-of-way to Contractor's satisfaction, and that the Contractor will accomplish any additional work necessary on the railroad right-of-way with the Contractor's own forces.

### **Termination of Insurance and Policies to be Submitted**

Any insurance policies given hereunder shall cover all Contractor-performed work the Contractor in connection with the work in the introductory paragraph within railroad right-of-way, but shall not be liable for accidents occurring after acceptance of the completed project by the Department. Such policies shall contain a clause requiring 30 days written notice be given to the Engineer and to the appropriate Railroad Company, prior to cancellation or change.

Submit to the Engineer the original and one copy of the Commercial General Liability Policy, one certified duplicate copy of all other policies, and certificates of insurance in an original and two copies as required by these Project Special Provisions.

No extra allowance will be made for the insurance required hereunder. The entire cost shall be included in the contract unit price bids for other pay items.

The named insured under the commercial General Liability Insurance Policy is the respective Railroad Company, and the designation of the job site description of work is as follows: All construction on the Chesapeake & Albemarle Railroad right-of-way on NCDOT Project No. U-5942 in Pasquotank County, North Carolina.

### **3. Flagging Protection or Watchman Service**

Provide 72 hours advance notice to Chesapeake & Albemarle Railroad in order that flagging service can be arranged and provided. Do not undertake any work within the Chesapeake & Albemarle Railroad right-of-way until the flagman is at the job site.

### **4. Delays Caused by Operations of Others**

Neither the Department nor the Railroad Company assumes any responsibility for any work performed by others in connection with the construction of the project, and the Contractor shall have no claim whatsoever against the Department or the Railroad Company for any inconvenience, delay, or additional cost incurred by the Contractor on account of such operations by others.

**5. Time Extensions**

No time extensions related to railroad encroachments will be allowed until the related work becomes the controlling factor relative to overall project completion.

**6. Cooperation with Others**

Cooperate with others participating in the construction of the project to the end that all work may be carried on to the best advantage.

**7. Authority of Railroad Engineer**

The authorized representative of the Railroad Company, hereinafter referred to as the Railroad Engineer, will have the final authority in all matters affecting the safe maintenance of railroad traffic of his company.

**8. Interference with Railroad Operations**

Arrange and conduct work so that there will be no interference with railroad operations, including train, signal, telephone and telegraphic services, or damage to the property of the Railroad Company or to the poles, wire, and other facilities of tenants on the rights-of-way of the Railroad Company. Wherever work is liable to affect the operations or safety of trains, first submit the method of doing such work to the Railroad Engineer for approval. However, such approval will not relieve the Contractor from liability.

Should conditions arising from or in connection with the work, require that immediate and unusual provisions be made to protect train operations and property of the Railroad Company, it shall be a part of the required services by the Contractor to make such provisions and if, in the judgment of the Railroad Engineer such provisions are insufficient, the Railroad Engineer or the Department may, at the expense of the Contractor, require or provide such provisions as may be deemed necessary.

**9. Storage of Materials**

Do not store materials and equipment where they will interfere with railroad operations, nor on the rights-of-way of the Railroad Company without first having obtained permission from the Railroad Engineer. Such permission will be with the understanding that the Railroad Company will not be liable for damage to such material and equipment from any cause, and that the Railroad Engineer may move or require the Contractor to move, at the Contractor's expense, such material and equipment.

**10. Completion and Acceptance of Work**

Upon completion of the work, remove from within the limits of the railroad right-of-way all machinery, equipment, surplus materials, or rubbish and leave said rights-of-way in a neat and orderly condition. Acceptance of the work will be contingent upon final inspection by the Department and by the Railroad Company (if required by the Railroad Company) to determine if the work was completed satisfactorily in a manner acceptable to the Department and the Railroad Company.

## 1.4.CONSTRUCTION STAGING/MIGRATION

### A. Introduction

This section addresses the general flow of construction in regards to communications throughout the life of the project. It is essential that the Contractor make every effort to minimize communications downtime to the traffic signals.

Follow the outline of construction described below. Update the construction schedule monthly. Submit a detailed field migration plan (including details of controller cabinet change-outs) and schedule to the Department for review and approval at least two weeks prior to the onset of work, and no later than 60 days after Notice to Proceed. Update the migration plan monthly and submit it at least five business days prior to each monthly construction meeting. Include details of controller cabinet change-outs, listing every intersection, existing and future control zone, and existing and future communication zone, and a schedule of the migration. Obtain approval from the Engineer in advance for any deviations from this sequence. Include information explaining how the following situations will be handled:

1. Existing pole-mount cabinet converted to base-mount,
2. Existing cabinet foundation retained,
3. Base-mount cabinet on new foundation,
4. Installation and splicing of fiber-optic drop cables,
5. Installation of drop cables into risers with existing fiber-optic cable,
6. Reel-to-reel splice locations,
7. Transitioning the Department's existing Translink32 closed-loop systems with on-street masters over to the new signal system software, changing out the controllers and switching from the existing serial fiber-optic to a new Ethernet-based fiber-optic communications network,
8. Removal of existing fiber-optic communications cable, where Plans or Engineer require, once a controller cabinet has been changed out;
9. Removal of existing fiber-optic communications cable followed by installation of new fiber-optic communications cable in an existing underground conduit or existing riser where there is no spare conduit/riser to facilitate installation of new cable before removing the existing cable; and
10. How to coordinate with others at the time new cabinets are set to make the necessary signal changes at the TMC to get the controller online.

Submit a System Design Report to the Engineer for Department review and approval prior to beginning any migration from the existing signal system and communications system to the new signal system and new Ethernet communications system. Submit the System Design Report in both hard copy and electronic form. Refer to "Submittal Data and Documentation" section of these Project Special Provisions for additional requirements.

### B. General Requirements

Perform as much of the necessary "make ready" work as possible within a proposed Ethernet communications ring to be migrated before proceeding to the steps that follow. Make ready work includes: new underground conduits, new junction boxes, intercepted and rerouted conduits at new and existing junction boxes, fiber-optic cable overhead and in new conduit, cabinet foundation modifications, electrical service, electrical service modifications, etc.

Complete the work of migrating all the signals in one Ethernet communications ring before moving to the next ring. Exceptions to the requirements in this section must be approved by the Engineer. Complete the intersection migrations in a communications ring within the number of workdays equal to no more than the number of signalized intersections in the communications ring. **Liquidated damages** for failure to complete intersection migrations and restore system communications to all intersections in the communications ring within the specified time are **\$1,500 per 24-hour period or any portion thereof.**

Interrupt communications, replace cabinets and controllers, and migrate signals from the existing closed-loop system communications to the new Ethernet communications network, per ring, as follows:

**1. Replace controllers and cabinets**

Notify the NCDOT Signal Supervisor at (252) 482-1850 at least two weeks prior to the commencement of work on a particular existing communications network to ensure that time-base coordination will be operating and effective in all of the intersection controllers within the network during the time of communications interruption. See subsection on “Time-Based Coordination During Construction” below.

**(1)** Prior to installing each new cabinet and controller:

- i. Configure and install the Ethernet edge switch in the cabinet. Configure the Ethernet edge switches for the permanent IP addresses, VLANs, and other configuration data before their field installation
- ii. Program or otherwise verify that time-based coordination is properly programmed. See “Backup Intersection Operation” subsection in the “Signal System Software” section of these Project Special Provisions for further details.

**(2)** With the Engineer’s approval, take existing controller off-line and run network with time-based coordination. Replace with new controller and cabinet while maintaining ability to reconnect to the existing communications system.

**(3)** Within a timeframe approved by the Engineer in advance, complete replacement of controller and cabinet and reconnect controller to the existing communications system.

**(4)** Prior to the end of any work day, ensure that existing closed-loop system communications is reestablished and working correctly.

**(5)** Replace all controller and cabinets within the one Ring that is being migrated.

**2. Establish Communications**

As fiber-optic cable installation, splicing and testing is completed for an entire Ring, connect the Ethernet edge switches to establish communication to the Ethernet core switch.

Test communications to each Ethernet edge switch in that ring as per the requirements of “Testing and Acceptance” section of these Project Special Provisions.

### 3. Integrate into New Central System

Upon successful testing, integrate the communications ring and all devices connected to that ring into the new central system software under Ethernet communications. Migrate the existing and proposed cameras as the adjacent traffic signals are migrated to new system

Install system timing and graphics as per the requirements of the previous subsection "Timing of Signals."

Disconnect and remove existing communications cable where designated in the Plans.

### C. Time-Based Coordination During Construction

It is the intent of these Project Special Provisions to minimize the length of time signals are offline from either the existing or new communication system, thereby limiting the duration of the use of time-based coordination. **Do not take any existing controller off-line from signal system communications and implement time-base coordination without prior approval of the Engineer.**

Place in time-base coordination only those signals within an existing closed-loop that are actively being migrated to the Ethernet communications system. Ensure that the time-based coordination plans from existing controllers are transferred to the replacement controllers at those same locations.

Verify time-base coordination in 2070LX controllers that upon installation will not be immediately connected to communicate with the new signal system over the new Ethernet fiber-optic cable network.

**Verify the time reference on each controller at least once per week** (by synchronizing with a National Standard Time source) while time-based coordination is in use and make any corrections necessary to maintain proper coordination. In the event coordinated timing plan changes are needed, the Contractor shall implement them at the direction of the Engineer.

Record the time and date of each visit, the activity performed and name of person who visited the cabinet and performed the clock maintenance activity. Maintain a record of clock maintenance activity in a single document and furnish to the Engineer for review upon request. Failure to visit each intersection that is not online to check and update clocks will result in **liquidated damages of \$1,500 per visit not performed.**

Once all signal migration within a ring is complete, establish or otherwise verify that time-based coordination is properly programmed on all existing controllers in the ring.

### D. Staging Concept

The approach to maintaining and maximizing communications to all signals and CCTV cameras throughout the construction process requires that the new fiber-optic communications infrastructure be constructed while the existing communications infrastructure remains in place and operational. This will allow the intersections, even those in close proximity to one another, to function on the existing communications system until such time as they are migrated to the new Ethernet fiber-optic communications system.

Construction of the signal system upgrade and expansion and migration from the existing to the new system is envisioned to occur in the following general stages:



**1. Stage 1****A. Step 1**

Begin construction of the fiber-optic communications backbone/trunk line

The Department has joint-use permits for the proposed new attachments of aerial fiber-optic communications cable. Joint-use permits issued by the utility pole owners expire 120 days from the date of issuance. The Contractor shall commence installation of messenger cables and guy assemblies at the outset of construction and work continuously and expeditiously to complete this work prior to the joint-use permit expiration date. In the event that this work cannot be completed within 120 days, notify the Engineer 20 calendar days in advance to allow the Department to request an extension of the permit.

Concurrently, begin construction of field infrastructure (i.e., messenger cable, risers, underground conduits, junction boxes, foundation modifications, CCTV poles/cameras/cabinets, fiber-optic communications cable).

Concurrently, begin “make-ready” work at the TMC. Modify the existing communication rack in the server room. Begin installation of Ethernet core switch, server(s), monitors, workstations, and all necessary equipment at the new TMC. Configure the Ethernet core switch for the permanent IP addresses, VLANs, and other configuration data before its installation.

Coordinate the installation of trunk cables into the TMC with the field infrastructure.

**B. Step 2**

Complete the fiber optic trunk line/backbone and as much as the “make-ready” work for installation of communications as possible.

Construct and splice drop cables to local intersections while maintaining the existing communications. The original traffic signal system was largely constructed with drop and repeat transceivers and fiber-optic cable that daisy-chained through the each traffic signal controller cabinet. At many locations, the new drop cable can be installed into the cabinet while maintaining the existing communications cable either by using a new riser or conduit entrance installed per the Plans or by installing the drop cable in the existing conduit or riser alongside the existing cables. Where the drop cable cannot be installed while the existing cables remain inside the existing conduit or riser, initially coil and store the new drop cable on the pole or span above the occupied riser or in a junction box adjacent to the cabinet. Subsequently remove the existing cable(s) and pull the new drop cable into the cabinet during controller and cabinet change-out.

Complete “make-ready “ work at the TMC. Complete installation of Ethernet core switch, server(s), monitors, workstations, and all necessary equipment at the new TMC. Install the network management software. Configure the central software applications.

## C. Step 3

Setup a workshop to configure and test local equipment. The test facility shall utilize the same models of equipment to test the network configuration as is being installed on the project.

Begin building the device database. Convert the signal timing data and build the system and intersection graphics.

**2. Stage 2**

Once the communications cable plant in Stage 1 and TMC “make-ready” work is completed and successfully tested, begin the process of transferring communications from the old fiber-optic network to the new fiber-optic network. See the preceding subsection 1.4(B) “General Requirements” for further details.

Group the work by the existing closed-loop communications systems, allowing intersection migration to take place in discrete segments. The boundaries of the existing closed-loop systems may be obtained from the Department through the Engineer upon request. In addition to grouping work by existing closed-loop communications systems, further organize work by proposed communications ring.

Migrate one ring at a time until all existing communications is replaced with the new communications network.

Integrate all isolated controller and cabinets into the new network, one ring at a time.

**3. Stage 3**

System testing and acceptance.

**1.5.MEASUREMENT AND PAYMENT**

There will be no direct payment for work covered in this section. Payment at the contract unit prices for the various items in the contract will be full compensation for all work covered by this section. Include the incidental costs for furnishing and/or installing materials and equipment expressly required under the contract for successful completion of the contract, but whose measurement and payment is not specifically stated under any of the contract pay items, into the unit cost(s) for the various items in the contract.

## 2. MOBILIZATION

### 2.1. DESCRIPTION

This work consists of preparatory work and operations to mobilize personnel, materials and equipment to the project site.

### 2.2. MEASUREMENT AND PAYMENT

*Mobilization* will be paid as contract lump sum price.

Partial payments for *Mobilization* will be made with the first and second partial pay estimates paid on the contract and will be made at the rate of 50% lump sum price on each of these partial pay estimates, provided the amount bid for *Mobilization* does not exceed 5% of the total amount bid for the contract. Where the amount bid for *Mobilization* exceeds 5% of the total amount bid for the contract, 2.5% percent of the total amount bid will be paid on each of the first two partial pay estimates. That portion exceeding 5% will be paid on the last partial pay estimate.

Such price and payment includes, but is not limited to, the movement of personnel, equipment, supplies, and incidentals to the project site, for the establishment of offices, buildings, and other facilities necessary for work on the project; the removal and disbandment of those personnel, equipment, supplies, incidentals, or other facilities that were established for the prosecution of work on the project; and for all other work and operations that shall be performed for costs incurred before beginning work on the various items on the project site.

Payment will be made under:

<b>Pay Item</b>	<b>Pay Unit</b>
Mobilization	Lump Sum

### 3. TEMPORARY TRAFFIC CONTROL

#### 3.1.DESCRPTION

Furnish, install, maintain, relocate, and remove temporary traffic control devices in accordance with these Project Special Provisions, the Transportation Management Plan, the MUTCD, and Roadway Standard Drawings to maintain and control vehicular and pedestrian traffic in a safe and efficient manner during signal system construction. All temporary traffic control devices furnished by the Contractor shall remain the property of the Contractor, unless otherwise specified in the contract.

Furnish, install, and maintain all ADA compliant pedestrian traffic control devices for existing sidewalks that are disrupted, closed, or relocated by planned work activities.

The ADA compliant pedestrian traffic control devices used to either close, redirect, divert or detour pedestrian traffic are Pedestrian Channelizing Devices, Audible Warning Devices and Temporary Curb Ramps.

#### 3.2.GENERAL REQUIREMENTS

##### A. Maintenance of Traffic

The Contractor will be required to maintain traffic, both vehicular and pedestrian, within the limits of the project, including roadways that cross or intersect the project, unless otherwise provided for in the contract or approved by the Engineer. The Contractor shall conduct his work in a safe manner that will create a minimum amount of inconvenience to traffic, both vehicular and pedestrian.

Maintain vehicular and pedestrian traffic through work zones in accordance with these Project Special Provisions, the MUTCD, and *Roadway Standard Drawings*, 23 CFR 630 Subparts J and K and the Transportation Management Plan (TMP).

Mark all hazards with signs, barricades, drums or other warning devices until the hazard is eliminated.

##### B. Temporary Lane Closures

###### 1. General

Operate all equipment and personnel within the designated work area during lane closures. Do not impede or stop traffic for the purpose of performing construction related work on the traffic side of the lane closure, except when called for in the Transportation Management Plan.

Install lane closures with the traffic flow, beginning with devices on the upstream side of traffic. Remove lane closures against the traffic flow, beginning with devices on the downstream side of traffic.

Vehicles used to install or remove lane closures shall have warning lights as described in Article 1101-5 of the *Standard Specifications*.

###### 2. Intersections

When construction proceeds through an intersection, provide flagger(s) and all other necessary Traffic Control as required by the Plans to direct the traffic through the intersection. When an intersection is signalized, have authorized personnel place the signal

in flash mode and provide law enforcement or other adequate traffic control measure to direct traffic through the intersection prior to beginning work in the intersection.

When it is necessary to close a lane of traffic for construction on the departure (downstream) side of an intersection, implement the lane closure on the approach (upstream) side of the intersection. Close the appropriate lane of dual turn lanes that would otherwise turn into the lane that is closed on the departure side of the intersection.

### **C. Temporary Road Closures**

#### **1. Traffic Pattern Alterations**

Notify the Engineer 30 calendar days before altering the existing traffic pattern, unless otherwise stated in the TMP.

Plan all traffic pattern alterations and meet with the Engineer to discuss the implementation strategy before altering traffic. The Engineer will notify the proper authorities and other affected parties as necessary.

#### **2. Traffic Stoppage**

Limit the stoppage of traffic to times specified in the Plans. Provide enough time between consecutive stoppages to allow the traffic queue to dissipate.

### **D. Traffic Control Supervision**

Provide the service of at least one qualified work zone supervisor. The work zone supervisor shall have the overall responsibility for the proper implementation of the traffic management plans and ensure all employees working inside the NCDOT right-of-way have received the proper training appropriate to the job decisions each individual is required to make.

The work zone supervisor is not required to be on site at all times but shall be available to address concerns of the Engineer. The name and contract information of the work zone supervisor shall be provided to the Engineer prior to or at the preconstruction conference.

Qualification of work zone supervisors shall be done by an NCDOT approved training agency or other approved training provider. For a complete listing of these, see the Work Zone Traffic Control's webpage: <https://connect.ncdot.gov/projects/WZTC/Pages/Training.aspx>

Coordinate with and cooperate with traffic control supervisors of adjacent or overlapping construction projects to insure safe and adequate traffic control is maintained throughout the projects at all times including periods of construction inactivity in accordance with Article 105-7 of the *Standard Specifications*.

### **E. Vehicular Access**

Maintain continuous and safe vehicular access, including but not limited to, all residences, businesses, schools, police and fire stations, hydrants, other emergency services, hospitals and mailboxes. Conduct operations in such a manner as to limit the inconvenience to property owners.

### **F. Pedestrian Access**

Maintain continuous and safe pedestrian access, including but not limited to, all residences, businesses, schools and mailboxes. Conduct operations in such a manner as to limit the inconvenience to pedestrians.

Protect open excavations within or adjacent to areas subject to pedestrian traffic from pedestrian intrusion by surrounding the excavation/hazard with orange plastic mesh construction fencing (also referred to as safety fence, tree protection barricade, warning fence, etc.) or other method approved by the Engineer. Do not use tape, flagging, rope or plastic chain strung between barricades, cones or stakes.

When existing pedestrian facilities are disrupted, closed or relocated, provide temporary facilities that are detectable and include accessibility features consistent with the features present in the existing pedestrian facility. The work zone supervisor is responsible for the implementation of the TMP, and installation and maintenance of the pedestrian devices. The work zone shall be inspected weekly or as directed by the Engineer. When pedestrian movement through or around a work site is necessary, provide a separate usable footpath. If the previous pedestrian facility was accessible to pedestrians with disabilities, provide a footpath during temporary traffic control that is accessible. Do not have any abrupt changes in grade or terrain that could cause a tripping hazard or could be a barrier to wheelchair use. Provide channelizing devices that are detectable to pedestrians who have visual disabilities. Provide temporary pedestrian facilities that are made of concrete, asphalt or other suitable material as approved by the Engineer at all locations where the existing sidewalks have been removed for construction operations.

Do not sever or move pedestrian facilities for non-construction activities such as parking for vehicles and equipment. Separate pedestrian movements from both work site activity and vehicular traffic.

When pedestrian detours are necessary, ensure that all required detour signing and delineation, including work done by others, are in place before placing pedestrians onto the detour.

### **G. Alternate to Transportation Management Plan**

If desired, submit an alternate TMP a minimum of 30 calendar days in advance of the anticipated implementation to allow for adequate review time. Do not implement alternate plans for traffic control until approved in writing and properly sealed. No adjustment in compensation or extension of the completion date(s) will be allowed due to the review time of the alternate. If an alternate TMP is implemented, the Contractor shall be responsible for any unanticipated changes to subsequent Steps.

### **H. Temporary Traffic Control Plan not fully Covered in the Contract**

When the TTC does not cover a particular work function, notify the Engineer to allow for the development or modification of a sealed set of the Temporary Traffic Control Plans.

## **3.3.MATERIALS**

### **A. Work Zone Traffic Control Devices**

Refer to Division 10 of the *Standard Specifications*.

Use temporary traffic control devices that comply with 23 CFR 630 Subpart K. Provide a Type 7 material certifications in accordance with Article 106-3 of the *Standard Specifications* at least 72 hours before use for all used temporary traffic control devices.

Provide temporary traffic control devices that are listed on the NCDOT Approved Product List.

The ADA compliant pedestrian traffic control devices involved in the closing or redirecting of pedestrians as designated on the Transportation Management Plan (TMP) shall be manufactured and assembled in accordance with the requirements of the Americans with Disabilities Act (ADA) and be on the NCDOT approved products list.

### **B. Work Zone Signs**

Refer to Division 10 of the *Standard Specifications*:

<b>Item</b>	<b>Section</b>
Barricade Mounted Signs	1089-3
Work Zone Signs	1089-1
Work Zone Sign Supports	1089-2

Portable work zone signs shall be roll up or approved composite substrates. Use portable work zone signs only with portable work zone sign stands specifically designed for one another.

Provide portable work zone sign stands, portable signs and sheeting that meet NCHRP 350 for Category II traffic control devices and are listed on the NCDOT Approved Products List.

Provide portable work zone signs and stands that are crash tested together as a system by the manufacturer. Poor performance of portable work zone signs or portable work zone sign stands at any site, whether or not related to a specific contract, will be grounds for non-acceptance of a product on any project under contract.

### **C. Flashing Arrow Boards**

Refer to Division 10 of the *Standard Specifications*:

<b>Item</b>	<b>Section</b>
Flashing Arrow Boards	1089-6

Use arrow boards that are on the NCDOT Approved Product List.

Poor performance of arrow boards at any site, whether or not related to a specific contract, will be grounds for non-acceptance of a product on any project under contract.

### **D. Portable Changeable Message Signs**

Refer to Division 10 of the *Standard Specifications*:

<b>Item</b>	<b>Section</b>
Portable Changeable Message Signs	1089-7

Use portable changeable message signs that are on the NCDOT Approved Products List.

Poor performance of portable changeable message signs at any site, whether or not related to a specific contract, will be grounds for non-acceptance of a product on any project under contract.

**E. Drums**

Refer to Division 10 of the *Standard Specifications*:

<b>Item</b>	<b>Section</b>
Drums	1089-5

Provide drums that are on the NCDOT Approved Products List.

**F. Cones**

Refer to Division 10 of the *Standard Specifications*:

<b>Item</b>	<b>Section</b>
Cones	1089-4

Provide cones that are on the NCDOT Approved Products List.

**G. Barricades**

Refer to Division 10 of the *Standard Specifications*:

<b>Item</b>	<b>Section</b>
Barricades	1089-3

Provide barricades that meet NCHRP 350 for Category II traffic control devices and listed on the NCDOT Approved Products List.

**H. Flaggers**

Refer to Division 10 of the *Standard Specifications*:

<b>Item</b>	<b>Section</b>
Flaggers	1089-10

Refer to *Roadway Standard Drawings*.

**I. Truck Mounted Attenuators**

Refer to Division 10 of the *Standard Specifications*:

<b>Item</b>	<b>Section</b>
Truck Mounted Impact Attenuators	1089-9

Use chassis mounted or trailer mounted TMAs that meet NCHRP 350 Test Level II or III for transportation management devices and are listed on the NCDOT Approved Products List.

Historical performance of the temporary crash cushion will help determine the future use of the material by the Department, even if the TMA has been approved. Poor performance of TMA at any site, whether or not related to a specific contract, will be grounds for non-acceptance of a product on any project under contract.



**J. Skinny Drums**

Refer to Division 10 of the *Standard Specifications*:

<b>Item</b>	<b>Section</b>
Skinny Drums	1089-5

Provide skinny drums that are on the NCDOT Approved Products List.

**K. Audible Warning Devices**

Audible Warning Devices shall be manufactured to include a locator tone activated by a motion sensor and have the ability to program a message for a duration of at least 1 minute. The motion sensor shall have the ability to detect pedestrians a minimum of 10' away. The voice module may be automatic or it may be push button activated. If push button activated, it shall be at the appropriate height to meet the ADA regulations.

**L. Temporary Curb Ramps**

Temporary Curb Ramps shall be manufactured and assembled to meet all of the requirements for persons with walking disabilities, including wheelchair confinement, according to the ADA regulations and Roadway Standard Drawing 848.05. All detectable warning features are to be included with these installations.

**3.4.CONSTRUCTION METHODS****A. Work Zone Traffic Control Devices**

Ensure all traffic control devices inspected and approved before using them on the project. Install temporary traffic control devices before construction operations begin and during the proper phase of construction. Maintain and relocate temporary traffic control devices during the time they are in use. Keep these devices in place as long as they are needed and immediately remove thereafter. When operations are performed in stages, install only those devices that apply to the present conditions.

**B. Work Zone Signs****1. Work Zone Signs (Barricade Mounted)**

Mount approved composite or roll-up signs to barricade rails so that the signs do not cover more than 50% of the top two rails or 33% of the total area of the three rails. Mount signs at least 1 foot from the ground to the bottom of the sign.

**2. Work Zone Signs (Portable)**

Install the portable work zone sign and sign stand to stand plumb within 10° left and right, within 20° front and back and be capable of standing erect in windy conditions.

Install roll-up or approved composite signs at least 1 foot from the bottom of the sign to the edge of pavement elevation on two-lane two-way roadways and at least 5 feet from the bottom of the sign to the edge of pavement elevation on multi-lane roadways.

Clean the sign face prior to use.

When not in use for periods longer than 30 minutes, lay the portable work zone sign flat on the ground and collapse the sign stand and lay it flat on the ground.

**C. Flashing Arrow Boards**

Use arrow boards that have the capability to display mode selections.

Do not use straight-line caution or chevron displays.

Mount flashing arrow boards on trucks, trailers, or other mobile units.

Expedite repairs due to failure, malfunction or damage to an arrow board. Furnish another arrow board approved by the Engineer during the repair time. Repair or replace arrow boards immediately; otherwise, suspend all construction activities requiring the use of the sign until the sign is restored to operation.

Perform all maintenance operations recommended by the manufacturer of the arrow board.

**D. Portable Changeable Message Signs**

Mount all portable changeable message signs on a trailer or truck so as to support the message board in a level position and in accordance with the Plans. Align and sight the portable changeable message sign to provide optimal driver visibility. Messages on a portable changeable message sign shall consist of no more than 2 phases, and a phase shall consist of no more than 3 lines of text. Each phase shall be capable of being understood by itself, regardless of the order in which it is read. Messages shall be centered and uppercase within each line of the legend. If more than one portable changeable message sign is simultaneously legible to road users, then only one of the signs shall display a sequential message at any given time. As guidance, the display time for each phase shall be at least 2 seconds, and the sum of the display times for both of the phases shall be no more than 8 seconds. Sign operator will adjust the display rate so the 2 phase message can be understood by the motorist approaching the sign at the posted speed limit. Relocate the units for the various stages of construction as shown in the Plans or as needed to adequately inform the motorists.

Provide an experienced operator for the portable changeable message sign during periods of operation to ensure that the messages displayed on the sign panel are in accordance with the Plans and Article 1089-7(D) of the *Standard Specifications*. Periodically change the controller password to deter unauthorized programming. Using two levels of password security is recommended such that operators at one level may only change message sequences displayed using preprogrammed sequences and operators at a higher level may create and store messages or message sequences.

Ensure that the message sign is illuminated properly to meet the existing light conditions, and that all adjustments for operation of the sign are made as needed to properly guide motorists.

Expedite repairs due to failure, malfunction, or damage to a portable changeable message sign. Furnish another portable changeable message during the repair time. Repair and/or replace portable changeable message sign immediately; otherwise, suspend all construction activities requiring the use of the sign until the sign is restored to operation.

Perform all maintenance operations recommended by the manufacturer of the sign. Periodically clean or replace the sign face panels and associated solar panels.

### **E. Drums**

Use the same type of reflective sheeting on all drums installed at any one time during the life of the project. Spacing of these devices is equal in feet to the speed limit in the taper and twice the speed limit in the tangent sections

Use a ballasting method in accordance with the manufacturer's specification. When using a tire ballasting method, use approved manufacturer's tires and place the tires flush with the ground.

Immediately replace and dispose of any drum, ballast or reflective sheeting that are torn, crushed, discolored or otherwise damaged.

### **F. Cones**

Use reflective adhesive sheeting on all cones used between dusk and dawn. Use the same type of reflective sheeting on all cone collars installed at any one time during the life of the project. Do not use cones in the upstream taper of lane or shoulder closures for multilane roadways and use for no longer than 3 consecutive days.

Use ballasting methods in accordance with manufacturer's specification. Cones may be used on all facilities for daytime and nighttime work with speed limits at or below 55 mph. If used at night, the cones shall have adhesive reflective sheeting and shall meet the height requirements in the *Roadway Standard Drawings*.

Cones may be used instead of drums, where allowed in the TMP plans or by the Engineer, on facilities with speed limits above 55 mph, if both the work is performed during daylight conditions and the devices are removed after each work period. Drums shall be used in the tapers.

The maximum spacing for cones on multi-lane roadways is equal in feet to the posted speed limit.

Immediately replace and dispose of any cone that is torn, crushed, discolored or otherwise damaged.

### **G. Barricades**

Install Type III barricades of sufficient length to close the entire roadway. Reposition the devices as necessary to completely close the roadway to traffic at the end of the workday.

Use sandbags or other approved ballasting methods to prevent overturning of barricades by the wind. If needed, place sandbags or other acceptable ballasting on the feet of the frame. Do not ballast barricades with objects such as rocks or chunks of concrete.

Do not anchor barricades to any pavement surfaces unless such anchoring method has passed the crash test requirement of NCHRP 350 for work zone category II devices.

Point the striped diagonals on the barricade rails in the direction of traffic flow.

Periodically inspect barricades and ballast. Replace any ballast as needed, including sandbags that have loose sand outside the bag.

**H. Flaggers**

Provide the service of properly equipped and qualified flaggers (see *Roadway Standard Drawings*) at locations and times for such period as necessary for the control and protection of vehicular and pedestrian traffic. All flaggers shall be qualified by an NCDOT approved training agency in the set-up and techniques of safely and competently performing a flagging operation. For a complete listing of approved training agencies, see the Work Zone Traffic Control's webpage.

Prior to beginning work on the project, a Qualification Statement that all flaggers used on the project have been properly trained through an NCDOT approved training resource shall be provided to the Engineer.

Use flagging methods that comply with the guidelines in the MUTCD.

**I. Truck Mounted Attenuator**

Before use, furnish the Engineer detailed brochures, specifications, and other manufacturer's data that completely describes the performance criteria, installation, and instructions for the TMA.

Use TMAs that meet the crash test requirements of *Standard Specifications* Subarticle 1089-9(A).

Do not park TMAs against rigid objects (i.e. bridge piers or portable concrete barrier) except as a temporary safety measure and in no case for longer than 72 hours. Install the TMA on a truck that is fully operational, in good running order, and in accordance with the manufacturer's specifications.

Use the appropriate lighting and delineation on the truck and TMAs as shown in the *Roadway Standard Drawings*.

Use the appropriate lighting and delineation on the truck and TMAs as shown in the *Roadway Standard Drawings*. TMA trailer lighting systems shall be activated in the flash mode while deployed.

Repair or replace within 24 hours any attenuator that becomes crushed or otherwise damaged so that it will perform its intended purpose. Suspend all construction activities until the attenuator is repaired or replaced. Provide safe control of traffic until the attenuator has been repaired by using approved methods.

**J. Skinny Drums**

Use the same type of reflective sheeting (Type III High Intensity Prismatic or greater) on all skinny drums installed at any one time during the life of the project. Use ballasting methods in accordance with the manufacturer's specification.

Immediately replace and dispose of any skinny drum, ballast or reflective sheeting that are torn, crushed, discolored or otherwise damaged.

Skinny drums may be used instead of cones on all facilities with speed limits of 55 mph and below. Spacing of these devices is equal in feet to the speed limit in the taper and twice the speed limit or every other skip in the tangent sections.

Skinny drums may be used instead of cones and drums where allowed in the TMP or by the Engineer on facilities with speed limits above 55 mph, if all the following apply:

- 1) The work is performed during daylight conditions,
- 2) The devices are removed after each work period and
- 3) Drums are used in the tapers.

Do not use skinny drums on control-of-access facilities for night work operations or allow to remain in place overnight. Do not use skinny drums for tapers on multilane or control-of-access roadways with speed limits above 55 mph.

Do not intermix with drums or cones unless directed by the Engineer or the TMP.

### **K. Pedestrian Channelizing Devices**

Pedestrian Channelizing Devices shall be manufactured and assembled to be connected as to eliminate any gaps that allow pedestrians to stray from the channelizing path. Any Pedestrian Channelizing Devices used to close or block a sidewalk shall have a "SIDEWALK CLOSED" sign affixed to it and any audible warning devices, if designated on the TMP.

### **L. Law Enforcement**

Use off duty uniformed Law Enforcement Officers and marked Law Enforcement vehicles equipped with blue lights mounted on top of the vehicle, and Law Enforcement vehicle emblems to direct or control traffic as required by the Plans or by the Engineer.

Law Enforcement vehicles shall not be parked within the buffer space.

Use a law enforcement officer(s) when an existing traffic signal must be taken out of operation in order to remove and replace the existing cabinet and controller. Use a law enforcement officer(s) when a traffic signal must be deactivated while constructing a conduit entrance into an existing cabinet foundation (subject to the Engineer's prior approval), while overlaying an existing cabinet foundation with a new preformed foundation and while removing and replacing an existing foundation with a new preformed foundation in the same location.

### **M. Pedestrian Safety**

Install measures for separating pedestrian traffic from the work area and from adjacent vehicular traffic where pedestrian paths are evident or sidewalks are present. Use protective barricades, warning and guidance devices and signs to provide a safe, well-defined passageway for pedestrians. When a sidewalk must be closed temporarily to perform construction work, refer to Chapter 6D, "Pedestrian and Worker Safety," and Typical Applications 28 and 29 (TA-28 and TA-29) of the 2009 Edition of the *Manual on Uniform Traffic Control Devices* (MUTCD 2009) for appropriate pedestrian traffic control measures. The MUTCD 2009 is available online at the following web address: <http://mutcd.fhwa.dot.gov>

## **3.5.MAINTENANCE AND INSPECTION**

### **A. Work Zone Traffic Control Devices**

Submit a proposed traffic control device maintenance schedule and checklist for approval prior to construction. Perform continuous maintenance and scheduled inspections of traffic control devices. Review and maintain all traffic handling measures to ensure that adequate provisions are in place for the safety of the public and workers.

Maintenance activities include cleaning, repair or replacement, and prompt disposal of temporary traffic control devices that are damaged, torn, crushed, discolored, displaced or deteriorated beyond effectiveness.

Replace work zone traffic control devices deemed unacceptable according to the guidelines set forth in the American Traffic Safety Service Association's (ATSSA) Quality Guidelines for Work Zone Traffic Control Devices.

If there are traffic control devices in use, perform inspection on a daily basis.

If the name and telephone number of the agency, Contractor or supplier is shown on the non-retroreflective surface of all channelizing devices, use letters and numbers that are a non-reflective color and not over 2 inches in height.

### **3.6.FAILURE TO MAINTAIN TRAFFIC CONTROL**

Failure to maintain temporary traffic control measures and traffic control devices in accordance with this Project Special Provision may result in formal notification of noncompliance. Implement remedial action immediately for imminent danger situations as directed. Implement remedial action within 48 hours after notification of a safety issue that is not an imminent danger situation. See Articles 107-21 and 108-7 of the *Standard Specifications*.

Failure to comply may result in having the work performed with available forces and equipment. In cases of willful disregard for the safety of the public, the Engineer may proceed immediately to implement the measures necessary to provide the appropriate level of traffic control to ensure that the safety of all concerned parties is maintained.

### **3.7.MEASUREMENT AND PAYMENT**

Nominal dimensions will be used to compute sign panel areas.

*Work zone signs (barricade mounted)* will be measured and paid for as the actual number of square feet satisfactorily installed on barricades and accepted by the Engineer. Payment will be made for the initial installation only. Relocation of signs will be considered incidental to the measurement of the quantity of signs.

*Work zone signs (portable)* will be measured and paid for as the actual number of square feet satisfactorily installed and accepted by the Engineer. Payment will be made for the initial installation only. Relocation of signs will be considered incidental to the measurement of the quantity of signs.

No direct payment will be made for portable work zone sign stands. All portable work zone sign stands will be incidental to the work of providing work zone signs.

*Flashing arrow board* will be measured and paid for as the maximum number of boards that have been satisfactorily placed and accepted by the Engineer in use at any one time during the life of the project as required by the contract. Flashing arrow boards installed on truck mounted attenuators (TMAs) will not be paid for separately as they are incidental to the cost of the TMA. Relocation, repair, replacement and maintenance of arrow boards is considered incidental to the work of this section of the Project Special Provisions.

*Portable changeable message sign (Short term)* will be measured and paid for as the actual number of days the portable changeable message signa (short term) is used on a project for a

specific work operation, removed from the project after the specific operation is complete and remains in use on the project no longer than 30 days.

Relocation, replacement, repair and maintenance of portable changeable message signs is considered incidental to the work of this section of the Project Special Provisions.

*Drums* will be measured and paid for as the maximum number of drums acceptably placed and in use at any one time during the life of the project. Relocation, replacement, repair or disposal of drums, ballasts or reflective sheeting will be incidental to the work of this section of the Project Special Provisions.

*Cones* will be measured and paid for as the maximum number of cones acceptably placed and in use at any one time during the life of the project. Relocation, replacement, repair, maintenance or disposal of cones will be incidental to the work of this section of the Project Special Provisions.

*Barricades (Type III)* will be measured and paid for as the maximum number of linear feet of barricades acceptably placed and in use at any one time during the life of the project. Measurement will be made of the total length of each barricade along one rail. Relocation, replacement, repair, maintenance or disposal of barricade will be incidental to the work of this section of the Project Special Provisions.

*Flagger (Day)* will be measured and paid for as a half day or full day. To constitute a full day, the flagger must work 4 consecutive hours during a shift. Any shift less than four consecutive hours will be paid as a half day. On any calendar day that more than one flagger is used, the quantity to be paid on that calendar day will be the maximum number of flaggers used at one time in that calendar day. Flagging conducted for the convenience of the Contractor's operations is not compensated. The Department will pay for flaggers, including those used at Y-lines that are used in conjunction with a lane closure. Flaggers used for operations not involving a lane closure will be incidental to that operation and no payment will be made. Flaggers used for hauling operations, where the only need for a lane closure is due to the hauling operation, will be incidental to that operation and no payment will be made. Any flagger used for less than one hour will be incidental to that operation.

*TMA* will be measured and paid for as the maximum number of TMAs acceptably placed and in use at any one time during the life of the project for all operations other than Moving and Mobile operations. TMAs will be incidental to all moving and mobile operations. In the case of emergency situations, TMAs will not be paid for when payment has already been made for a stationary unit. Relocation of TMAs will be incidental to the measurement of the quantities of TMAs and no separate payment will be made.

*Skinny drum* will be measured and paid for as the maximum number of skinny drums satisfactorily placed, accepted by the Engineer and in use at any one time during the life of the project. Relocation, replacement, repair, disposal and maintenance of skinny drums will be considered incidental to the work of this section of the Project Special Provisions.

*Audible Warning Devices* will be measured and paid for as the maximum number of audible warning devices satisfactorily placed, accepted by the Engineer and in use at any one time during the life of the project. The unit prices include any costs associated with installation, maintenance and removal of the devices from the project.

*Temporary Curb Ramps* will be measured and paid for as the maximum number of audible warning devices satisfactorily placed, accepted by the Engineer and in use at any one time during the life of the project. Payment for Temporary Curb Ramps includes all necessary detectable warning features. The unit prices include any costs associated with installation, maintenance and removal of the devices from the project.

*Pedestrian Channelizing Devices* will be measured and paid for as the maximum number of linear feet of pedestrian channelizing devices satisfactorily placed and accepted by the Engineer and in use at any one time during the life of the project. The unit prices include any costs associated with installation, maintenance and removal of the devices from the project.

*Law enforcement* will be measured and paid for as the actual number of hours that each Law Enforcement Officer provides during the life of the project as approved by the Engineer and subject to the following conditions:

- Measurement and payment will not exceed 4 hours per police officer provided to direct traffic at a given signalized intersection during the removal and replacement of a controller cabinet.
- Measurement and payment will not exceed 2 hours per police officer provided to direct traffic at a given signalized intersection while constructing a new conduit entrance into an existing cabinet foundation, overlaying an existing cabinet foundation with a new preformed foundation or replacing an existing foundation with a new preformed foundation in the same location.

There will be no direct payment for marked law enforcement vehicles as they are considered incidental to the pay item.

No measurement will be made of orange plastic mesh construction fencing or other approved methods of protecting open excavations/hazards from pedestrian intrusion as such measures will be considered incidental to the excavation work. No measurement will be made of temporary pedestrian footpaths required to maintain pedestrian movement around removed sections of sidewalk as such measures will be considered incidental to the excavation work and the replacement of the removed section of sidewalk.

If the Contractor fails to maintain acceptable traffic control measures or temporary traffic control devices and the Engineer implements measures necessary to provide the appropriate level of traffic control, the actual cost of performing said work will be deducted from the monies due the Contractor on the contract.

Payment will be made under:

<b>Pay Item</b>	<b>Pay Unit</b>
Work Zones Signs (Barricade Mounted)	Square Foot
Work Zones Signs (Portable)	Square Foot
Flashing Arrow Board	Each
Portable Changeable Message Sign (Short Term)	Days
Drums	Each



**U-5942**

**ITS-49**

**Pasquotank County**

Cones	Each
Barricades (Type III)	Linear Foot
Flagger	Day
TMA	Each
Skinny Drum	Each
Pedestrian Channelizing Devices	Linear Foot
Audible Warning Devices	Each
Temporary Curb Ramps	Each
Law Enforcement	Hour

#### 4. PAVEMENT MARKINGS

##### 4.1.DESCRPTION

Furnish, install, and remove pavement markings in accordance with the traffic signal plans.

##### 4.2.MATERIALS

###### A. General

Refer to Division 10 of the *Standard Specifications*:

Item	Section
Pavement Markings	1087

###### B. Material Qualification

Use pavement markings which are on the Department's Approved Products or are traffic qualified by the Signing and Delineation Unit..

###### C. Performance

Poor performance of pavement marking materials at any site, whether or not related to a specific contract may be grounds for non-acceptance of a product on any project under contract.

##### 4.3.CONSTRUCTION METHODS

###### A. General

Refer to and fully comply with Section 1205 of the *Standard Specifications*.

Do not use handliners or any other non-truck mounted pavement marking machine to install pavement markings for long line applications of any one line longer than 1000 feet.

###### B. Testing Procedures

All pavement marking materials and placement will be tested by the Department. Install pavement markings in order to meet the retroreflectivity requirements as measured by a Department approved 30 m mobile or handheld retroreflectometer.

###### C. Application Equipment

###### (1) General for all Application Equipment

Use pavement marking application equipment such that all parts that come in contact with pavement marking material are constructed for easy accessibility during cleaning and maintenance.

Keep the marking guns of the application device in full view of the operators at all times. Use applicators that are mobile and maneuverable to the extent that straight lines can be followed and all standard curves can be made in true arcs.

###### (2) Glass Bead and Highly Reflective Media Dispensing Equipment

Apply glass beads and highly reflective media to the surface of pavement long line markings using an automatic high pressurized bead and media dispenser or a pressurized mechanical feed, attached to the marking equipment. Hand liner type equipment is exempt from this requirement. Locate the bead and media applicator at

the proper distance behind the application of pavement marking material to provide the proper amount of retroreflectivity. Equip the bead and media applicator with an automatic cut-off control synchronized with the cut-off control of the marking material.

Spread the beads and reflective media uniformly over the entire surface of the pavement marking material such that they are partially embedded in the pavement marking. A 60% bead and media embedment depth provides optimum retroreflectivity.

#### **D. Weather Limitations and Seasonal Limitations for All Markings**

Do not place pavement markings when moisture tests conducted on the pavement show signs of moisture presence on the pavement or when it is anticipated that damage caused by moisture may occur during the installation and drying periods.

#### **E. Time Limitations for Replacement**

<b>TIME LIMIT FOR REPLACEMENT</b>		
<b>Facility Type</b>	<b>Marking Type</b>	<b>Replacement Deadline</b>
Full-control-of-access multi-lane roadway (4 or more total lanes) and ramps, including Interstates	All markings	By the end of each workday's operation if the lane is opened to traffic
Multi-lane roadways (3 or more lanes) and ramps	Center Line, Lane Line, Railroad symbols, Stop bars and school symbols	By the end of each workday's operation if the lane is opened to traffic (temporary paint with beads may be used)
	Edge Lines, gore lines and all other symbols	By the end of the 3rd calendar after obliteration
Two-lane, two-way roadways	All centerline markings, railroad, Stop bars and school symbols	By the end of the 5th calendar day after obliteration
	Edge Lines and all other symbols	By the end of the 15th calendar day after obliteration

A multilane facility is defined as any roadway having more than two lanes to include a two-lane / two-way roadway with a center two-way left turn lane.

#### **F. Premarking/Interim/Temporary Markings**

Premarking (or layout markings) are small paint spots used by striping contractors to establish locations of pavement markings. Premark each installation of the final pavement marking materials before application on new pavement and when required to replace existing pavement marking, except when existing markings are visible. Get the premarking inspected and approved by the Engineer before placing the pavement marking materials.

Interim paint is a thin layer of pavement marking paint applied at the striping contractor's option to maintain traffic, instead of durable pavement markings. Apply interim paint to comply with time limitations for placement if final pavement markings cannot be placed. Interim markings shall be no more than 1/4" less than the specified line width of the existing markings. Place temporary paint markings for detours, lane shifts, milled surfaces and lifts of asphalt other than the final pavement surface.

Review and record the existing pavement markings before resurfacing and reestablish the new pavement markings using the record of existing markings in conjunction with the *Roadway Standard Drawings*, unless otherwise directed. Submit the record of existing pavement markings 7 calendar days before the obliteration of any pavement markings.

### **G. Surface Preparation and Curing Compound Removal**

Prepare the pavement to accept pavement markings to insure maximum possible adhesion. Clean, seal and remove curing compound as necessary to insure that the markings adhere to the pavement. Obtain approval for all surface preparation methods before implementing.

Pavements shall be free of grease, oil, mud, dust, dirt, grass, loose gravel, winter surface treatments and other deleterious material, prior to applying pavement markings.

Prepare the pavement surface, including removal of curing compound, at least 2 inches wider than the pavement markings to be placed, such that, an additional 1 inch of prepared area is on all sides of the pavement markings after they are applied.

Remove all curing compound and surface laitance on Portland cement concrete pavements where long-life pavement markings will be placed. Perform curing compound removal by high-pressure water blasting methods or grinding methods. Ensure that the surface is free of all residue, laitance and debris before applying the pavement marking. When surface preparation and curing compound removal operations are completed, blow the pavement surface clean by compressed air immediately before installing the pavement markings.

If required, apply a primer sealer to pavement surfaces before applying pavement marking material as recommended by the manufacturer. Apply primer sealer in a continuous film at least 2 inches wider than the pavement markings in such a way as to not cause any noticeable change in the appearance of the pavement markings.

Conduct all pavement surface preparation including curing compound removal in such a manner that the pavement or joint material is not damaged or left in a condition that will mislead or misdirect the motorist. Repair any damage caused to the pavement, or joint materials caused by surface preparation or the removal of curing compound by acceptable methods and at no additional cost to the Department.

Where pavement surface preparation results in obscuring existing pavement markings of a lane occupied by traffic, immediately remove the residue, including dust, by approved methods.

### **H. Application of Pavement Markings**

- General for all types of Pavement Markings

Install pavement marking material that has a uniform thickness, a smooth surfaced cross section throughout its entire length, width and length not less than the

dimensions specified in the traffic signal plans and that does not exceed the dimension by more than ½ inch.

Do not apply pavement marking materials over a longitudinal joint. Mask all bridge joints for removal of surface laitance, existing markings and application of new markings as directed by the Engineer. This work will be incidental to the installation of pavement markings.

Install pavement marking lines that are straight or have uniform curvature and conform with the tangents, curves, and transitions as specified in the traffic signal plans.

Produce finished lines that have well defined edges and are free of horizontal fluctuations. Do not exceed ½ inch in lateral deviation from the proposed location alignment at any point. Any greater deviations may be cause for requiring the material to be removed and replaced at no additional cost.

Apply all longitudinal pavement marking lines 8 inches or less in width with one pass of the pavement marking equipment. Pavement marking lines greater than 8 inches in width and pavement marking symbols may be applied with multiple passes of the pavement marking equipment.

Install all pavement marking lines, stop bars, characters, and symbols that require multiple passes of the application equipment such that there are no gaps separating the application passes.

Install characters and symbols so that they conform to the sizes and shapes shown in the traffic signal plans.

Protect the pavement markings until they are track free. Repair any markings tracked by a vehicle by acceptable methods.

Remove all pavement marking materials spilled on the road surface by acceptable methods.

Use yellow, white, and black pavement markings, without glass beads and reflective media that visually match the color chips that correspond to the Federal Test Standard Number 595a for the following colors. Use markings that when subjected to accelerated weathering as described in U.S. Federal Specification No. TT-P-115F are within the tolerance limits of the color chips listed below:

White:     Color 17886  
Yellow:    Color 13538  
Black:     Color 37038

- **Highly Reflective Median Application**

“Drop-on” is the method where glass beads and highly reflective media are dispensed by a pressurized mechanical feed or high pressure means onto the pavement marking as it is applied to the pavement. Drop-on bead and media dispensing for symbols, stop bars, and characters may be accomplished by gravitational methods.

**I. Pavement Markings Observation Period**

This pavement markings observation period shall be a separate entity than the signal system observation period defined in these Project Special Provisions.

Maintain responsibility for debonding and color of the pavement markings during a 12 month observation period beginning upon the satisfactory completion and acceptance by the Engineer of all pavement marking work required in the traffic signal plans. Guarantee the markings under the payment and performance bond in accordance with Article 105-17 of the *Standard Specifications*.

During the 12-month pavement marking (PM) observation period, provide pavement marking material that shows no signs of failure due to blistering, chipping, bleeding, discoloration, smearing or spreading under heat or poor adhesion to the pavement materials. Pavement markings that bonded during application and were approved, but debond due to snowplowing will not be considered a failed marking. Replace, at no additional expense to the Department, any pavement markings that do not perform satisfactorily under traffic during the 12-month PM observation period.

**J. Removal of Pavement Markings**

This work includes the removal of all types of pavement marking lines, symbols, and characters including removal for long life marking preparation. This work does not include removal of removable tape pavement markings.

Remove pavement marking lines, characters, and symbols by acceptable methods to the Engineer that will not materially or structurally damage the surface or the texture of the pavement. Leave the pavement surface in a condition that will not mislead or misdirect the motorist.

Where existing pavement markings are to be removed and replaced by other pavement markings, do not begin removal until adequate provisions have been made to complete the installation of the replacement markings. Remove pavement markings such that the surface is in proper condition for adequate bonding of the new markings. Promptly remove any material deposited on the pavement as a result of removing pavement markings as the work progresses by acceptable methods. Provide the equipment necessary to control dust and the accumulation of debris resulting from the removal process. The removal equipment shall provide dust control and the capture of the removed material shall be done utilizing a separate vacuum equipped vehicle or other approved system. Perform the recovery process within the same operation as the removal. Do not let traffic use the lane where the removal is taking place until the recovery system is finished. Should the recovery system fail, cease removal operations until the recovery system is properly operating. The Contractor is responsible for all cleanup and proper disposal of all removed debris from the project site.

When using a grinding method for pavement removal, the equipment shall have multiple heads working in tandem or have a removal head with operator dialed controls to result in a planed surface and provide adequate preparation of the surface to accept the new marking material.

Do not use high pressure water blasting on asphalt.

Application of polyurea over existing pavement marking materials will require at least 95% of the existing pavement marking material to be removed; however, if one 15 mil application of paint was placed on asphalt pavement is less than 6 months old, do not remove the existing paint pavement markings.

Thermoplastic may be installed over existing thermoplastic on asphalt. Application over existing pavement marking materials other than thermoplastic will require the existing pavement marking material to be removed so that a minimum of 85% of the existing pavement marking surface is removed. Before applying thermoplastic pavement markings over the existing thermoplastic pavement markings, remove at least 25% of the oxidized existing thermoplastic. However, if one 15 mil application of paint was placed on asphalt is less than 6 months old, do not remove the existing paint pavement markings.

Use black color #37038 in paint or tape, as determined by Contractor, to cover any remaining conflicting pavement marking after removal from asphalt pavement surfaces. Do not use black paint or tape on concrete pavement surfaces. The black paint will not have a defined shape or edges with a width not exceeding double of the existing lines.

#### **K. Pavement Marking Installer Qualifications**

Ensure at least one member of every pavement marking crew certified through the NCDOT Pavement Marking Technician Certification Process. Keep the certification current throughout the life of the project. A certified crewmember shall be present anytime this work is being performed. The certified crewmember is not required to be the same person throughout the life of the contract.

#### **4.4.THERMOPLASTIC (ALKYD/MALEIC)**

##### **A. Application Equipment**

###### **(1) General**

Use application equipment constructed to assure continuous uniformity in the thickness and width of the thermoplastic pavement marking. Use application equipment that provides multiple width settings ranging from 4 inches to 12 inches and multiple thickness settings to achieve a minimum pavement marking thickness of 0.090 inch above the surface of the pavement. Special thickness equipment may be required for in lane or shoulder transverse rumble strip pavement markings.

Do not use spray thermoplastic unless approved by NCDOT's Signing and Delineation Unit.

###### **(2) Premelting Kettle:**

Use equipment to install hot thermoplastic pavement marking material that includes an oil-jacketed or air-jacketed premelt kettle for uniform heating and melting of the thermoplastic material. Use a kettle that is equipped with an automatic thermostat control device to provide positive temperature control and continuous mixing and agitation of the thermoplastic material. Do not premelt thermoplastic material in handliner type equipment.

###### **(3) Applicator Storage Kettle**

Equip long line pavement marking vehicles with an automatic thermostat control device to maintain the thermoplastic material at the application temperature and provide continuous mixing and agitation of the thermoplastic material during installation. Construct the equipment so that all mixing and conveying parts, up to and including the application apparatus, maintains the thermoplastic pavement marking material at the specified installation temperature and which has a capacity of a minimum of 1500 lbs. of molten thermoplastic pavement marking material. Hand transfer is not allowed.

Handliner type application vehicles may contain the premelting and applicator storage functions in the same kettle. Agitation and mixing can be done manually. Drag box type and bucket type application is not allowed.

Use premelting and applicator storage kettles that meet the requirements of the National Board of Fire Underwriters, the National Fire Protection Association, and State and local authorities.

### **B. Weather Limitations and Seasonal Limitations**

Do not apply thermoplastic pavement markings on existing or new pavements unless the ambient air temperature and the temperature of the pavement is 50°F or higher.

Do not apply thermoplastic pavement markings between December 15 and the following March 16.

Exception to the above: When traffic is maintained on a portion of roadway and thermoplastic pavement marking will not be placed within 30 calendar days due to seasonal limitations, place pavement marking paint and beads in accordance with Subarticle 1205-8(C) of the *Standard Specifications*.

### **C. Application**

Use only thermoplastic markings that are of the hot, machine applied type. Apply alkyd/maleic thermoplastic pavement markings by extrusion methods only. Extrusion may be accomplished using either conventional extrusion equipment or ribbon gun extrusion devices.

The stem portion of straight arrows shall be applied in a single pass and the stem portion of turn arrows is to be applied in no more than 2 passes of the application equipment. Arrowheads may be applied by multiple passes of the application equipment, not to exceed 3 passes.

Apply drop-on beads and/or highly reflective media uniformly to the surface of the molten thermoplastic material so that the beads are partially embedded and at a rate recommended by the manufacturer to obtain the minimum reflectance values. Produce in place markings with the minimum retroreflective values shown in the table below, as obtained with a Department approved 30 m mobile or handheld retroreflectometer. Retroreflective measurements will be taken within 30 days after final placement of the pavement marking.



MINIMUM REFLECTOMETER REQUIREMENTS FOR THERMOPLASTIC		
Item	Color	Reflectivity
Standard Glass Beads	White	375 mcd/lux/m <sup>2</sup>
	Yellow	250 mcd/lux/m <sup>2</sup>
Highly Reflective Media	White	800 mcd/lux/m <sup>2</sup>
	Yellow	600 mcd/lux/m <sup>2</sup>

Ensure that the marking is uniformly retroreflective upon cooling and has the ability to resist deformation caused by traffic throughout its entire length.

A thin layer of interim pavement marking paint at the proper width may be placed before installing the thermoplastic markings. If this option is chosen, when not specified in the Plans or by the Engineer, direct payment for the paint will not be made. Cover any such thin layer of pavement marking paint with thermoplastic pavement marking within 30 calendar days of placement. Apply the thin layer of pavement marking paint and beads at the rate necessary to produce a dry film thickness of 5 to 8 mils. Apply drop-on glass beads at a rate of 1 to 3 lbs/ gal of paint.

Provide drainage openings at intervals of 250 feet in edge lines placed on the inside of curves and in edge lines on the low side of tangents. Provide openings that are no more than 12 inches and at least 6 inches in length.

Produce a cross sectional thickness of the thermoplastic markings above the surface of the pavement in accordance with the table below.

THICKNESS REQUIREMENT FOR THERMOPLASTIC	
Thickness	Location
240 mils	In-lane and shoulder-transverse pavement markings (rumble strips) may be placed in 2 passes.
90 mils	Center lines, skip lines, transverse bands, mini-skip lines, characters, bike lane symbols, crosswalk lines, edge lines, gore lines, diagonals and arrow symbols.

#### D. Thermoplastic Marking Observation Period

In addition to the requirements of “Pavement Markings Observation Period” subsection above, maintain responsibility for minimum retroreflective values for a 30-day period beginning upon the Engineer’s acceptance of all markings on the Project. Guarantee retroreflective values of the markings during the 30-day period under the payment and performance bond in accordance with Article 105-17 of the *Standard Specifications*.

#### 4.5.MAINTENANCE

Replace pavement markings that prematurely deteriorate, fail to adhere to the pavement, lack reflectorization, or are otherwise unsatisfactory, during the life of the project or during the 12-month pavement markings observation period as determined by the Engineer.

Upon notification from the Engineer, winterize the project by placing an initial or additional application of paint pavement marking lines in accordance with Article 1205-8 of the *Standard Specifications*.

#### 4.6.MEASUREMENT AND PAYMENT

*Thermoplastic pavement marking lines* (\_\_\_\_", \_\_\_\_ mils) will be measured and paid as the actual number of linear feet of pavement marking lines satisfactorily placed and accepted by the Engineer. The quantity of solid lines will be the summation of the linear feet of solid line measured end-to-end of the line. The quantity of skip or broken lines will be the summation of the linear feet derived by multiplying the nominal length of a line by the number of markings satisfactorily placed.

*Thermoplastic pavement marking symbols* (\_\_\_\_mils) will be measured and paid as the actual number of pavement marking symbols satisfactorily placed and accepted by the Engineer.

*Removal of pavement marking lines* (\_\_\_\_") will be measured and paid as the actual number of linear feet of pavement marking lines satisfactorily removed and accepted by the Engineer. The quantity of solid lines will be the summation of the linear feet of solid line measured end-to-end of the line. The quantity of skip or broken lines will be the summation of the linear feet derived by multiplying the nominal length of a line by the number of marking lines satisfactorily removed. No payment will be made for the removal of removable pavement marking tape.

*Removal of pavement marking Symbols & Characters* will be measured and paid as the actual number of pavement marking symbols and characters satisfactorily removed and accepted by the Engineer.

Payment at the contract unit price for the various items in the contract will be full compensation for all the items covered by this section. No direct payment will be made for: the work involved in applying the lines, including surface preparation; reapplication of molten pavement marking crossed by a vehicle; removal of all pavement marking materials spilled on the roadway surface; and repair of markings tracked by a vehicle.

Premarking will be incidental to other items in the contract. Unless directed by the Engineer, there will be no direct payment for interim paint. No direct payment will be made for black paint or tape.

The Contractor may choose to use heated-in-place thermoplastic symbols, characters and transverse lines instead of molten thermoplastics pavement markings at no additional cost to the Department.

Replacement of pavement markings that prematurely deteriorated, failed to adhere to the pavement, lacked reflectorization or were otherwise unsatisfactory during the life of the project or during the 12-month pavement markings observation period as determined by the Engineer will be at no cost to the Department.

Payment will be made under:

<b>Pay Item</b>	<b>Pay Unit</b>
Thermoplastic Pavement Marking Lines (4", 90 mils)	Linear Foot
Thermoplastic Pavement Marking Lines (24", 90 mils)	Linear Foot

**U-5942**

**ITS-59**

**Pasquotank County**

Thermoplastic Pavement Marking Symbols (90 mils)  
Removal of Pavement Marking Lines (4")  
Removal of Pavement Marking Lines (24")  
Removal of Pavement Marking Symbols & Characters

Each  
Linear Foot  
Linear Foot  
Each

## 5. SIGNAL HEADS

### 5.1.DESCRPTION

Furnish and install vehicle and pedestrian LED signal heads, visors, interconnecting brackets, wire entrance fittings, mounting assemblies, signal cable, lashing wire, pedestrian pushbuttons (and associated lead-in cable), pedestrian signal signs, grounding systems, and all necessary hardware.

### 5.2.MATERIALS

#### A. General

Except for Piezo-based pushbuttons, furnish material, equipment and hardware under this section that is pre-approved on the ITS and Signals QPL.

Fabricate vehicle signal head housings and end caps from die-cast aluminum. Fabricate 16-inch pedestrian signal head housings and end caps from die-cast aluminum. Provide visor mounting screws, door latches, and hinge pins fabricated from stainless steel. Provide interior screws, fasteners, and metal parts fabricated from stainless steel.

Fabricate tunnel and traditional visors from sheet aluminum.

Paint all surfaces inside and outside of signal housings and doors. Paint outside surfaces of tunnel and traditional visors, wire outlet bodies, wire entrance fitting brackets and end caps when supplied as components of messenger cable mounting assemblies, pole and pedestal mounting assemblies, and pedestrian pushbutton housings. Have electrostatically-applied, fused-polyester paint a minimum of 2.5 to 3.5 mils thick. Do not apply paint to the latching hardware, rigid vehicle signal head mounting brackets for mast-arm attachments, messenger cable hanger components or balance adjuster components.

Paint the signal housing, visors, push button housings, and items listed above black (Federal Standard 595C, Color Chip Number 17038) when:

- The pedestrian or vehicle signal head will be mounted on metal poles or mastarms that currently have a black finish.
- The existing pedestrian and vehicle signals at the intersection where the new signals will be installed are painted black.

For signals at all other locations, paint the signal housings highway yellow (Federal Standard 595C, Color Chip Number 13538).

Have the interior surfaces of tunnel and traditional visors painted an alkyd urea black synthetic baking enamel with a minimum gloss reflectance and meeting the requirements of MIL-E-10169, "Enamel Heat Resisting, Instrument Black."

Where required, provide polycarbonate signal heads and visors that comply with the provisions pertaining to the aluminum signal heads listed on the QPL with the following exceptions:

Fabricate signal head housings, end caps, and visors from virgin polycarbonate material. Provide UV stabilized polycarbonate plastic with a minimum thickness of  $0.1 \pm 0.01$  inches that is black in color. Ensure the color is incorporated into the plastic material before molding the signal head housings and end caps. Ensure the plastic formulation provides the

following physical properties in the assembly (tests may be performed on separately molded specimens):

Test	Required	Method
Specific Gravity	1.17 minimum	ASTM D 792
Flammability	Self-extinguishing	ASTM D 635
Tensile Strength, yield, PSI	8500 minimum	ASTM D 638
Izod impact strength, ft-lb/in [notched, 1/8 inch]	12 minimum	ASTM D 256

For pole mounting, provide side of pole mounting assemblies with framework and all other hardware necessary to make complete, watertight connections of the signal heads to the poles and pedestals. Fabricate the mounting assemblies and frames from aluminum with all necessary hardware, screws, washers, etc. to be stainless steel. Provide mounting fittings that match the positive locking device on the signal head with the serrations integrally cast into the brackets. Provide upper and lower pole plates that have a 1 ¼-inch vertical conduit entrance hubs with the hubs capped on the lower plate and 1 ½-inch horizontal hubs. Ensure that the assemblies provide rigid attachments to poles and pedestals so as to allow no twisting or swaying of the signal heads. Ensure that all raceways are free of sharp edges and protrusions, and can accommodate a minimum of ten Number 14 AWG conductors. Furnish pole-mounting assemblies that are the same color as the housing of the pedestrian or vehicle signal head that will be attached to them (e.g., furnish black assemblies for black signal heads and yellow assemblies for yellow signal heads.) Comply with the painting requirements for signal heads listed above.

For pedestal mounting, provide a post-top slipfitter mounting assembly that matches the positive locking device on the signal head with serrations integrally cast into the slipfitter. Provide stainless steel hardware, screws, washers, etc. Provide a minimum of six 3/8 X 3/4-inch long square head bolts for attachment to pedestal. Provide a center post for multi-way slipfitters. Furnish post-top slipfitter mounting assemblies that are the same color as the housing of the pedestrian or vehicle signal head that will be attached to them (e.g., furnish black assemblies for black signal heads and yellow assemblies for yellow signal heads) or which have a natural aluminum finish. Comply with the painting requirements for signal heads listed above.

For light emitting diode (LED) traffic signal modules, provide the following requirements for inclusion on the Department's Qualified Products List for traffic signal equipment.

1. Sample submittal,
2. Third-party independent laboratory testing results for each submitted module with evidence of testing and conformance with all of the Design Qualification Testing specified in section 6.4 of each of the following Institute of Transportation Engineers (ITE) specifications:
  - Vehicle Traffic Control Signal Heads – Light Emitting Diode (LED) Circular Signal Supplement
  - Vehicle Traffic Control Signal Heads – Light Emitting Diode (LED) Vehicle Arrow Traffic Signal Supplement
  - Pedestrian Traffic Control Signal Indications –Light Emitting Diode (LED) Signal Modules.

(Note: The Department currently recognizes two approved independent testing laboratories. They are Intertek ETL Semko and Light Metrics, Incorporated with Garwood Laboratories. Independent laboratory tests from other laboratories may be considered as part of the QPL submittal at the discretion of the Department,

3. Evidence of conformance with the requirements of these specifications,
4. A manufacturer's warranty statement in accordance with the required warranty, and
5. Submittal of manufacturer's design and production documentation for the model, including but not limited to, electrical schematics, electronic component values, proprietary part numbers, bill of materials, and production electrical and photometric test parameters.
6. Evidence of approval of the product to bear the Intertek ETL Verified product label for LED traffic signal modules.

In addition to meeting the performance requirements for the minimum period of 60 months, provide a written warranty against defects in materials and workmanship for the modules for a period of 60 months after installation of the modules. During the warranty period, the manufacturer must provide new replacement modules within 45 days of receipt of modules that have failed at no cost to the State. Repaired or refurbished modules may not be used to fulfill the manufacturer's warranty obligations. Provide manufacturer's warranty documentation to the Department during evaluation of product for inclusion on Qualified Products List (QPL).

#### **B. Vehicle Signal Heads:**

Comply with the ITE standard "Vehicle Traffic Control Signal Heads". Provide housings with provisions for attaching backplates.

Provide visors that are 10 inches in length for 12-inch vehicle signal heads.

Provide a termination block with one empty terminal for field wiring for each indication plus one empty terminal for the neutral conductor. Have all signal sections wired to the termination block. Provide barriers between the terminals that have terminal screws with a minimum Number 8 thread size and that will accommodate and secure spade lugs sized for a Number 10 terminal screw.

Mount termination blocks in the yellow signal head sections on all in-line vehicle signal heads. Mount the termination block in the red section on five-section vehicle signal heads.

Furnish vehicle signal head interconnecting brackets. Provide one-piece aluminum brackets less than 4.5 inches in height and with no threaded pipe connections. Provide hand holes on the bottom of the brackets to aid in installing wires to the signal heads. Lower brackets that carry no wires and are used only for connecting the bottom signal sections together may be flat in construction.

For messenger cable mounting, provide messenger cable hangers, wire outlet bodies, balance adjusters, bottom caps, wire entrance fitting brackets, and all other hardware necessary to make complete, watertight connections of the vehicle signal heads to the messenger cable. Fabricate messenger cable hanger components, wire outlet bodies and balance adjuster components from stainless steel or malleable iron galvanized in accordance with ASTM A153 (Class A) or ASTM A123. Provide serrated rings made of aluminum. Provide messenger cable hangers with U-bolt

clamps. Fabricate washers, screws, hex-head bolts and associated nuts, clevis pins, cotter pins, U-bolt clamps and nuts from stainless steel.

For mast-arm mounting, provide rigid vehicle signal head mounting brackets and all other hardware necessary to make complete, watertight connections of the vehicle signal heads to the mast arms and to provide a means for vertically adjusting the vehicle signal heads to proper alignment. Fabricate the mounting assemblies from aluminum, and provide serrated rings made of aluminum. Provide stainless steel cable attachment assemblies to secure the brackets to the mast arms. Ensure all fastening hardware and fasteners are fabricated from stainless steel.

Provide LED vehicular traffic signal modules (hereafter referred to as modules) that consist of an assembly that uses LEDs as the light source in lieu of an incandescent lamp for use in traffic signal sections. Use LEDs that are aluminum indium gallium phosphorus (AlInGaP) technology for red and yellow indications and indium gallium nitride (InGaN) for green indications. Install the ultra bright type LEDs that are rated for 100,000 hours of continuous operation from -40°F to +165°F. Design modules to have a minimum useful life of 60 months and to meet all parameters of this specification during this period of useful life.

For the modules, provide spade terminals crimped to the lead wires and sized for a #10 screw connection to the existing terminal block in a standard signal head. Do not provide other types of crimped terminals with a spade adapter.

Ensure the power supply is integral to the module assembly. On the back of the module, permanently mark the date of manufacture (month & year) or some other method of identifying date of manufacture.

Tint the red, yellow and green lenses to correspond with the wavelength (chromaticity) of the LED. Transparent tinting films are unacceptable. Provide a lens that is integral to the unit with a smooth outer surface.

#### **1. LED Circular Signal Modules:**

Provide modules in the following configurations: 12-inch circular sections, and 8-inch circular sections. All makes and models of LED modules purchased for use on the State Highway System shall appear on the current NCDOT Traffic Signal Qualified Products List (QPL).

Provide the manufacturer's model number and the product number (assigned by the Department) for each module that appears on the 2018 or most recent Qualified Products List. In addition, provide manufacturer's certification in accordance with Article 106-3 of the *Standard Specifications*, that each module meets or exceeds the ITE "Vehicle Traffic Control Signal Heads – Light Emitting Diode (LED) Circular Signal Supplement" dated June 27, 2005 (hereafter referred to as VTCSH Circular Supplement) and other requirements stated in this specification.

Provide modules that meet the following requirements when tested under the procedures outlined in the VTCSH Circular Supplement:

Module Type	Max. Wattage at 165° F	Nominal Wattage at 77° F
12-inch red circular	17	11
8-inch red circular	13	8

12-inch green circular	15	15
8-inch green circular	12	12

For yellow circular signal modules, provide modules tested under the procedures outlined in the VTCSH Circular Supplement to insure power required at 77° F is 22 Watts or less for the 12-inch circular module and 13 Watts or less for the 8-inch circular module.

Note: Use a wattmeter having an accuracy of  $\pm 1\%$  to measure the nominal wattage and maximum wattage of a circular traffic signal module. Power may also be derived from voltage, current and power factor measurements.

## 2. LED Arrow Signal Modules

Provide 12-inch omnidirectional arrow signal modules. All makes and models of LED modules purchased for use on the State Highway System shall appear on the current NCDOT Traffic Signal Qualified Products List (QPL).

Provide the manufacturer's model number and the product number (assigned by the Department) for each module that appears on the 2018 or most recent Qualified Products List. In addition, provide manufacturer's certification in accordance with Article 106-3 of the *Standard Specifications*, that each module meets or exceeds the requirements for 12-inch omnidirectional modules specified in the ITE "Vehicle Traffic Control Signal Heads – Light Emitting Diode (LED) Vehicle Arrow Traffic Signal Supplement" dated July 1, 2007 (hereafter referred to as VTCSH Arrow Supplement) and other requirements stated in this specification.

Provide modules that meet the following requirements when tested under the procedures outlined in the VTCSH Arrow Supplement:

Module Type	Max. Wattage at 165° F	Nominal Wattage at 77° F
12-inch red arrow	12	9
12-inch green arrow	11	11

For yellow arrow signal modules, provide modules tested under the procedures outlined in the VTCSH Arrow Supplement to insure power required at 77° F is 12 Watts or less.

Note: Use a wattmeter having an accuracy of  $\pm 1\%$  to measure the nominal wattage and maximum wattage of an arrow traffic signal module. Power may also be derived from voltage, current and power factor measurements.

## 3. LED U-Turn Arrow Signal Modules:

Provide modules in the following configurations: 12-inch left u-turn arrow signal modules and 12-inch right u-turn arrow signal modules.

Modules are not required to be listed on the ITS and Signals Qualified Products List. Provide manufacturer's certification in accordance with Article 106-3 of the *Standard Specifications*, that each module meets or exceeds the ITE "Vehicle Traffic Control Signal Heads – Light Emitting Diode (LED) Circular Signal Supplement" dated June 27, 2005 (hereafter referred to as VTCSH Circular Supplement) and other requirements stated in this specification.

Provide modules that have minimum maintained luminous intensity values that are not less than 16% of the values calculated using the method described in section 4.1 of the VTCSH Circular Supplement.



Provide modules that meet the following requirements when tested under the procedures outlined in the VTCSH Circular Supplement:

Module Type	Max. Wattage at 165° F	Nominal Wattage at 77° F
12-inch red u-turn arrow	17	11
12-inch green u-turn arrow	15	15

For yellow u-turn arrow signal modules, provide modules tested under the procedures outlined in the VTCSH Circular Supplement to ensure power required at 77° F is 22 Watts or less.

Note: Use a wattmeter having an accuracy of  $\pm 1\%$  to measure the nominal wattage and maximum wattage of a circular traffic signal module. Power may also be derived from voltage, current and power factor measurements.

### C. Pedestrian Signal Heads:

Provide pedestrian signal heads with international symbols that meet the MUTCD. Do not provide letter indications.

Comply with the ITE standard for “Pedestrian Traffic Control Signal Indications” and the following sections of the ITE standard for “Vehicle Traffic Control Signal Heads” in effect on the date of advertisement:

- Section 3.00 - “Physical and Mechanical Requirements”
- Section 4.01 - “Housing, Door, and Visor: General”
- Section 4.04 - “Housing, Door, and Visor: Materials and Fabrication”
- Section 7.00 - “Exterior Finish”

Provide a double-row termination block with three empty terminals and number 10 screws for field wiring. Provide barriers between the terminals that accommodate a spade lug sized for number 10 terminal screws. Mount the termination block in the hand section. Wire all signal sections to the terminal block.

Provide 16-inch pedestrian signal heads with traditional three-sided, rectangular visors, 6 inches long.

Provide 2-inch diameter pedestrian push-buttons with weather-tight housings fabricated from die-cast aluminum and threading in compliance with the NEC for rigid metal conduit. Provide a weep hole in the housing bottom and ensure that the unit is vandal resistant.

Provide push-button housings that are suitable for mounting on flat or curved surfaces and that will accept 1/2-inch conduit installed in the top.

Provide a pushbutton with a solid state Piezo-based switch and audible and visual feedback. A push button control module shall be installed in the cabinet to allow audible and visual feedback to the pedestrians.

Provide standard R10-3 signs with mounting hardware that comply with the MUTCD in effect on the date of advertisement. Provide R10-3E signs for countdown pedestrian heads and R10-3B for non-countdown pedestrian heads.

Design the LED pedestrian traffic signal modules (hereafter referred to as modules) for installation into standard pedestrian traffic signal sections that do not contain the incandescent signal section reflector, lens, eggcrate visor, gasket, or socket. Provide modules that consist of an assembly that uses LEDs as the light source in lieu of an incandescent lamp. Use LEDs that are of the latest aluminum indium gallium phosphorus (AlInGaP) technology for the Portland Orange hand and countdown displays. Use LEDs that are of the latest indium gallium nitride (InGaN) technology for the Lunar White walking man displays. Install the ultra-bright type LEDs that are rated for 100,000 hours of continuous operation from -40°F to +165°F. Design modules to have a minimum useful life of 60 months and to meet all parameters of this specification during this period of useful life.

Design all modules to operate using a standard 3 - wire field installation. Provide spade terminals crimped to the lead wires and sized for a #10 screw connection to the existing terminal block in a standard pedestrian signal housing. Do not provide other types of crimped terminals with a spade adapter.

Ensure the power supply is integral to the module assembly. On the back of the module, permanently mark the date of manufacture (month & year) or some other method of identifying date of manufacture.

Provide modules which have the solid hand/walking man overlay on the left and the countdown on the right. All makes and models of LED modules purchased for use on the State Highway System shall appear on the current NCDOT Traffic Signal Qualified Products List (QPL).

Provide the manufacturer's model number and the product number (assigned by the Department) for each module that appears on the 2018 or most recent Qualified Products List. In addition, provide manufacturer's certification in accordance with Article 106-3 of the *Standard Specifications*, that each module meets or exceeds the ITE "Pedestrian Traffic Control Signal Indicators - Light Emitting Diode (LED) Signal Modules" dated August 04, 2010 (hereafter referred to as PTCSI Pedestrian Standard) and other requirements stated in this specification.

Provide modules that meet the following requirements when tested under the procedures outlined in the PTCSI Pedestrian Standard:

Module Type	Max. Wattage at 165° F	Nominal Wattage at 77° F
Hand Indication	16	13
Walking Man Indication	12	9
Countdown Indication	16	13

Note: Use a wattmeter having an accuracy of  $\pm 1\%$  to measure the nominal wattage and maximum wattage of a circular traffic signal module. Power may also be derived from voltage, current and power factor measurements.

Provide module lens that is hard coated or otherwise made to comply with the material exposure and weathering effects requirements of the Society of Automotive Engineers (SAE) J576. Ensure all exposed components of the module are suitable for prolonged exposure to the environment, without appreciable degradation that would interfere with function or appearance.

Ensure the countdown display continuously monitors the traffic controller to automatically learn the pedestrian phase time and update for subsequent changes to the pedestrian phase time.

Ensure the countdown display begins normal operation upon the completion of the preemption sequence and no more than one pedestrian clearance cycle.

#### **D. Signal Cable:**

Furnish 16-4 and 16-7 signal cable that complies with IMSA specification 20-1 except provide the following conductor insulation colors:

- For 16-4 cable: white, yellow, red, and green
- For 16-7 cable: white, yellow, red, green, yellow with black stripe tracer, red with black stripe tracer, and green with black stripe tracer. Apply continuous stripe tracer on conductor insulation with a longitudinal or spiral pattern.

Provide a ripcord to allow the cable jacket to be opened without using a cutter. IMSA specification 19-1 will not be acceptable. Provide a cable jacket labeled with the IMSA specification number and provide conductors constructed of stranded copper.

### **5.3.CONSTRUCTION METHODS**

#### **A. General**

Bag new pedestrian and vehicle signal heads with burlap bags or bags made of non-ripping material specifically designed for covering signal heads until signal heads are placed in operation. Do not use trash bags of any type.

When new signal heads are placed into operation, immediately bag and remove signals heads that are not to be reused.

Adjust each signal head vertically and horizontally so that light output will be of maximum effectiveness for traffic and pedestrians. Do not tilt signal heads forward.

Reposition signal heads as required for various construction phases.

Label all LED sections with the date of installation.

#### **B. Vehicle Signal Heads**

Install vehicle signal heads such that the top of the signal housing located over any portion of a highway that can be used by motor vehicles is no more than 25.6 feet above the pavement.

Install vehicle signal heads such that the maximum mounting height to the top of the signal housing is as shown in below if the location is between 40 feet and 53 feet from the stop line.

**Maximum Mounting Height of Signal Heads  
Located Between 40 Feet and 53 Feet from Stop Line**

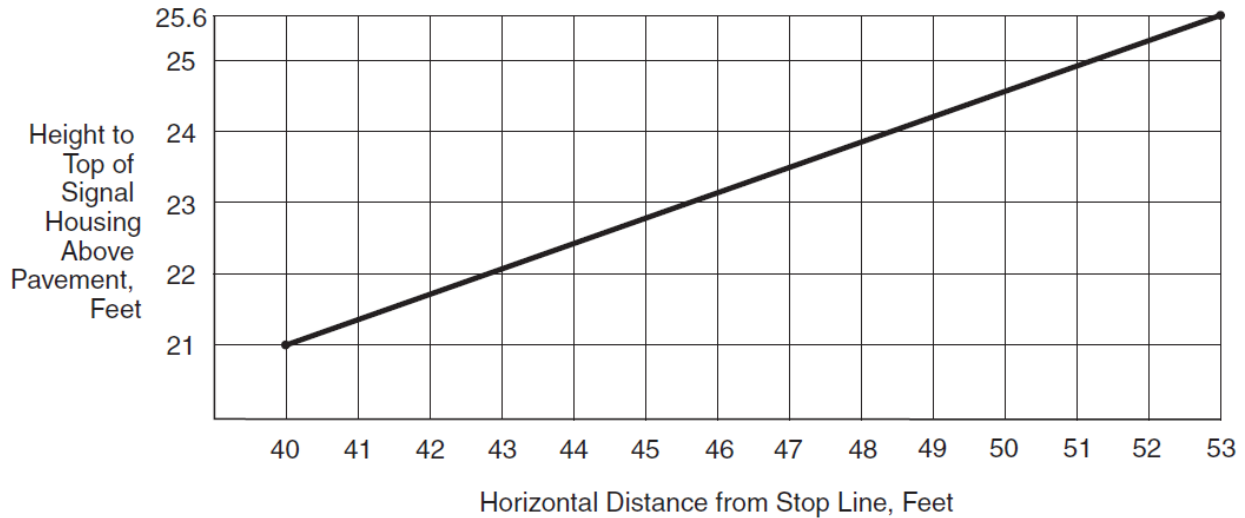

**Graph of maximum mounting height of signal heads.**

Install vehicle signal heads such that the bottom of the signal housing and any related attachments to the signal head located over any portion of a highway that can be used by motor vehicles is at least 16.5 feet (preferably at least 18 feet) above the pavement directly below the signal head.

- 1) Install vehicle signal heads such that the bottom of the signal housing (including brackets) of a signal head that is vertically arranged and not located over a roadway is as follows:
  - (a) A minimum of 8 feet and a maximum of 19 feet above the sidewalk or, if there is no sidewalk, above the pavement grade at the center of the roadway.
  - (b) A minimum of 8 feet and a maximum of 19 feet above the median island grade of a center median island if located on the near side of the intersection.
- 2) Install vehicle signal heads such that the bottom of the signal housing (including brackets) of a signal head that is horizontally arranged and not located over a roadway is as follows:
  - (a) A minimum of 8 feet and a maximum of 22 feet above the sidewalk or, if there is no sidewalk, above the pavement grade at the center of the roadway.
  - (b) A minimum of 8 feet and a maximum of 22 feet above the median island grade of a center median island if located on the near side of the intersection.

Where vehicle signal heads are installed on messenger cable, install mounting hardware consisting of messenger cable hanger, balance adjuster, bottom cap, wire entrance fitting bracket, and insulating bushings.

Where vehicle signal heads are installed on mast arms, install mounting hardware consisting of rigid vehicle signal head mounting brackets.

Install signal cable in continuous lengths between signal controller cabinets and signal heads. Route signal cable to minimize the length of cable installed and the number of cables and conductors in each run. Pull 36 inches of additional signal cable into controller cabinets.

Wrap signal cable to messenger cable with at least 4 turns of wrapping tape spaced at intervals less than 15 inches or lash signal cable to messenger cable with one 360-degree spiral of lashing wire per 12 inches.

Make electrical connections inside each signal head, signal controller cabinet, and termination compartment in metal poles. Do not splice cable at any other point between signal heads and controller cabinet.

Coil sufficient signal cable beside each vehicle signal head to accommodate head shifts during various construction phases. For final signal head locations, coil 36 inches on each side of signal head if signal cable comes from both directions. If signal cable terminates at the signal head, coil 36 inches of signal cable on the same side as the cable run.

### **C. Pedestrian Signal Heads**

Install signs with mounting hardware immediately above pedestrian pushbuttons.

Mount the pushbutton or accessible pedestrian signal (APS) at a minimum height of 3.5 feet but no higher than 4.0 feet above the adjacent pedestrian travelway.

Connect each pushbutton with a separate run of lead-in cable between the pushbutton and the termination panel in the controller cabinet. Bond pushbutton housing and all metal components to cabinet ground using lead-in cable ground.

Mount pedestrian signal heads so that the bottom of the signal housing, including brackets, is not less than 7 feet or more than 10 feet above sidewalk level. Position and adjust the heads to provide maximum visibility at the beginning of the controlled crosswalk. Ensure pedestrian signal heads and vehicular signal heads mounted on the same support are physically separated from each other.

### **D. Louvers**

Attach the louvers to the visors using stainless steel hardware. Position the signal head to give the viewing angle as shown in the plans.

## **5.4.MEASUREMENT AND PAYMENT**

*Vehicle signal head* (\_\_\_\_\_) and *pedestrian signal head* (\_\_\_\_\_) will be measured and paid for as the actual number of signal heads of each type of material (aluminum or polycarbonate), size, and number of sections furnished, installed, and accepted.

*Signal cable* will be measured and paid for as actual linear feet of signal cable furnished, installed, and accepted. Measurement will be point to point with no allowance for sag. Twenty-five feet will be allowed for vertical segments up or down poles.

*Lead-in Cable* will be measured and paid in accordance with "Lead-In Cable" section of these Project Special Provisions.

No measurement will be made of visors, wire entrance fittings, interconnecting brackets, mounting assemblies, painting of signal heads and visors, pedestrian pushbuttons, pedestrian signal signs and signal head shifts as these will be considered incidental to furnishing and installing vehicle and pedestrian signal heads. No measurement will be made for drip loops,

coiled sections, aluminum wrapping tape or lashing wire as these will be considered incidental to furnishing and installing signal cable.

½” risers with weatherheads for pedestrian pushbuttons will be measured and paid in accordance with the “Riser Assemblies” section of these Project Special Provision. Where the Plans call for installing a new pedestrian pushbutton with a new ½” riser with weatherhead, no measurement will be made of the pedestrian pushbutton as it will be considered incidental to furnishing and installing the ½” riser with weatherhead.

Payment will be made under:

<b>Pay Item</b>	<b>Pay Unit</b>
Vehicle Signal Head (12”, 3 Section)	Each
Vehicle Signal Head (12”, 4 Section)	Each
Vehicle Signal Head (12”, 5 Section)	Each
Pedestrian Signal Head (16”, 1 Section w/Countdown)	Each
Signal Cable	Linear Foot

## 6. MESSENGER CABLE

### 6.1.DESCRPTION

Furnish and install messenger cable (span wire) with cable clamps, machine bolts, eyebolts, 3-bolt clamps, J-hooks, eye nuts, split-bolt connectors, metal pole clamps, stainless steel bands, and all necessary hardware.

### 6.2.MATERIALS

#### A. General

Material, equipment, and hardware furnished under this section shall be pre-approved on the ITS & Signals QPL.

#### B. Messenger Cable

Comply with ASTM A475 for extra high strength grade wire strand, Class A zinc coating. Fabricate messenger cable from seven steel wires twisted into a single concentric strand.

#### C. Pole Line Hardware

Provide universal grade strandvises used for extra high strength steel messenger cable.

Provide other pole line hardware constructed of hot-dipped galvanized steel conforming to ASTM A153.

Provide machine bolts, eyebolts, and thimble eye bolts with minimum tensile strength of 12,400 lbs. Provide hot-dipped galvanized nuts, 3 inch x 3 inch curved square washers and thimbleyelets.

Provide suspension clamp fabricated from hot-dipped galvanized steel with minimum length of 5 ¾ inches. Ensure clamp has a groove rated for the messenger cable size it is intended to secure. Provide J-hook fabricated from 3/8 inch thick hot-dipped galvanized steel flat or oval stock with sufficient hook radius to cradle 11/16 inch diameter cable. Provide two ½ inch diameter hot-dipped galvanized bolts and nuts to tighten the clamp around the messenger cable. Provide one 5/8 inch diameter hot-dipped galvanized bolt of sufficient length to attach J-hook and clamp to the wood pole with a 3 inch x 3 inch curved square washer and double nuts.

Provide 3-bolt clamp fabricated from hot-dipped galvanized steel with minimum length of 5-3/4 inches. Ensure clamp has 2 parallel grooves rated for the messenger cable size it is intended to secure. Provide three 5/8 inch diameter hot-dipped galvanized bolts and nuts to tighten the clamp around the messenger cable.

Provide parallel groove clamp consisting of high strength, high conductivity non-copper bearing aluminum alloy clamp halves with interlocking fingers to prevent mismatch. Ensure clamp halves have molded grooves to secure #8-1/0 AWG stranded copper wires. Provide clamps with grooves prefilled with antioxidant joint compound. Provide 3/8 inch hex head, square shank, galvanized steel bolt with galvanized steel lock washer and nut.

Provide ½ inch and ¾ inch wide, 0.030 inch thick Type 316 stainless steel straps with Type 316 stainless steel buckles.

Provide either 0.05 inch x 0.30 inch aluminum wrapping tape or 0.06 inch diameter Type 316 stainless steel lashing wire for lashing cables to messenger cable. Ensure aluminum wrapping

tape is 1350 alloy, O-temper, with 12,800 psi tensile strength. Use 0.045 inch diameter Type 316 stainless steel lashing wire to lash fiber-optic communications cable to messenger cable.

Provide hot-dipped galvanized steel clamp with groove sized for ¼ inch to 3/8 inch messenger cable for securing lashing wire(s) to messenger cables at ends of each spiraled run. Ensure clamp hardware is hot-dipped galvanized steel.

Provide galvanized metal pole clamps and stainless steel banding hardware for attaching pole line hardware (e.g., strandvises, three-bolt clamps, etc.) to metal signal poles.

In addition, refer to the following subsections of these Project Special Provisions:

- the “Grounding Electrodes” subsection of the “Electrical Service” section.

### **6.3.CONSTRUCTION METHODS**

#### **A. General**

Install guy assemblies before installing messenger cable.

Use 3/8-inch messenger cable for spans supporting vehicle signal heads, and/or signs.

Use 1/4-inch messenger cable for spans supporting only cables unless otherwise specified.

For messenger cable crossing over railroad tracks, provide a minimum of 27 feet of vertical clearance, unless otherwise specified.

For permanent installations, install messenger cable in continuous lengths with no splices except where an insulator is required. With prior approval, existing messenger for temporary installations may be extended instead of installing new messenger cable.

Tension messenger cable to eliminate appreciable sag and to match sag of surrounding utilities. Otherwise, allow 3% to 4% sag of the span length between poles.

For mid-run spans using wood poles, attach messenger cable to the pole with a 3-bolt cable clamp with J-hook consisting of 5/8 inch diameter machine bolts, J-hooks, washers and square nuts to attach messenger cable to wood poles. Provide machine bolts that are 3 inches longer than the pole diameter. For mid-run spans using metal or other Department-approved poles, attach messenger cable to the pole with a 3-bolt clamp with J-hook secured to the metal pole via a pole band clamp. Refer to *Metal Pole Standard Drawing Sheets* in effect on the date of advertisement.

When terminating spans at wood poles, connect messenger cable to a dead-end strandvise attached to the pole via a 5/8 inch diameter shoulder eye bolt or 5/8 inch diameter shoulder angle bolt with 5/8 inch eye nut as shown in *Roadway Standard Drawing No. 1720.01*. When terminating spans at metal or other Department-approved poles, connect messenger cable to a dead-end strandvise attached to the pole via a pole attachment clamp. Refer to *Metal Pole Standard Drawing Sheets* as shown in the previous paragraph. Do not install more than one messenger cable and strandvise assembly to a single metal or other Department-approved pole attachment clamp. During installation, ensure that messenger cable is centered and directly aligned at the pole clamp’s attachment point such that the cable does not exert forces on the sides of the clamp’s attachment point.

Do not drill holes in metal poles to attach messenger cable. Do not attach messenger cable to metal poles that are owned by anyone other than the Department without prior approval of the



Engineer and the pole owner. Where such attachments are approved, use attachment methods and hardware approved by the pole owner.

Maintain electrical continuity at all splices.

On joint use poles at signal equipment installations (i.e., Controller Cabinets, etc.), do not use existing utility company grounds. Install a new, separate grounding system for the signal and ITS equipment that complies with the requirement of the “Electrical Service” section of these Project Special Provisions. Bond grounding in compliance with NEC.

Install all wire and cable with necessary hardware including, but not limited to shoulder eyebolts, washers, nuts, thimbleyelets, three-bolt clamps, J-hooks, split bolt connectors, grounding clamps, and lashing material.

#### **B. Messenger Cable for Signal Heads or Loop Lead-In Cable**

For messenger cable attached to joint use poles, install a new pole grounding system that complies with the requirement of the “Wood Poles” section of these Project Special Provisions for bonding messenger cable. If a pole ground exists on a joint use pole, bond new pole grounding system to existing pole ground using number 6 AWG minimum solid bare copper grounding wire terminated with split bolt connectors or parallel groove clamps at each end. If existing poles do not have a pole grounding system, install a new pole grounding system that complies with the requirement of the “Wood Poles” section of these Project Special Provisions.

#### **C. Messenger Cable for Communications Cable**

For messenger cable attached to joint use poles, bond messenger cable to existing pole ground at each end and at intervals not to exceed 1300 feet. Install bond using #6 AWG minimum solid bare copper grounding wire terminated with split bolt connectors or parallel groove clamp at each end. If existing poles do not have a pole grounding system, install a new pole grounding system that complies with the requirement of the “Wood Poles” section of these Project Special Provisions.

#### **D. Messenger Cable for Multiple Cables**

On multiple messenger cable arrangements, connect all messenger cable ends with #6 AWG minimum solid bare copper wire and bond with split bolt connectors or parallel groove clamp and terminate to pole ground.

### **6.4.MEASUREMENT AND PAYMENT**

*Messenger cable* (\_\_\_\_\_) will be measured and paid for as actual horizontal linear feet of messenger cable furnished, installed, and accepted. Measurement will be point to point with no allowance for sag.

No measurement will be made of cable clamps, machine bolts, eye bolts, 3-bolt assemblies, J-hooks, eye nuts, split bolt connectors, metal pole clamps, and stainless steel banding hardware as these will be considered incidental to furnishing and installing messenger cable. Bonding to an existing pole grounding system will be considered incidental to furnishing and installing messenger cable.

*Pole grounding system* will be measured and paid for in accordance with the “Wood Poles” section of these Project Special Provisions.

U-5942

ITS-74

Pasquotank County

Payment will be made under:

**Pay Item**

Messenger Cable (1/4")

Messenger Cable (3/8")

**Pay Unit**

Linear Foot

Linear Foot

## 7. UNDERGROUND CONDUIT

### 7.1.DESCRPTION

Furnish and install conduit for underground installation with tracer wire, miscellaneous fittings, all necessary hardware, marker tape, backfill, graded stone, paving materials, and seeding and mulching.

### 7.2.MATERIALS

#### A. General

Furnish material, equipment, and hardware under this section that is pre-approved on the ITS and Signals QPL.

Refer to Divisions 5 and 10 of the *Standard Specifications*:

Item	Section(s)
Backfill	1018-2
Graded Stone	545-2 & 545-3

#### B. Conduit Bodies, Boxes and Fittings

Use conduit bodies, boxes, and fittings that meet UL Standard 514A or 514B for electrical and communications installations.

#### C. Conduit Types

##### (1) Rigid Metallic Conduit

Provide rigid hot dipped galvanized steel conduit that meets UL Standard 6 with rigid full weight sherardized or galvanized threaded fittings.

##### (2) PVC Conduit

Provide non-metallic conduit and duct including associated couplings, approved for below ground use with or without concrete encasement in accordance with UL Standard 651A. Provide Schedule 40 conduit unless otherwise specified.

##### (3) Solid Wall HDPE Conduit

Use HDPE conduit that conforms to UL Standard 651A. Provide conduit meeting the requirements of the table below with minimum wall thickness ratios corresponding to EPEC-40 (Schedule 40), EPEC-80 (Schedule 80) or EPEC-B (SDR 13.5) as listed in UL Standard 651A.

<b>HDPE CONDUIT SIZE</b>	
<b>Conduit Trade Size</b>	<b>Furnish</b>
1"	EPEC-40
1-1/4"	EPEC-40
1-1/2"	EPEC-B (SDR 13.5)
2"	EPEC-B (SDR 13.5)
2-1/2"	EPEC-B (SDR 13.5)
3"	EPEC-B (SDR 13.5)
4"	EPEC-B (SDR 13.5)
5"	EPEC-80
6"	EPEC-80

Ensure the PE resin compounds used in manufacturing the conduit meet or exceed the cell classification PE 334420C (black with 2% minimum carbon black) or PE 334420E (colored conduit with UV inhibitors) in ASTM D3350 and the table below.

<b>RESIN PROPERTIES</b>		
<b>Property</b>	<b>Requirement</b>	<b>Test Method</b>
Density	0.940 - 0.947g/cm <sup>3</sup>	ASTM D1505 ASTM D792 ASTM D4883
Melt Index (condition 190/2.16 is acceptable)	< 0.4 grams/10 minutes	ASTM D1238
Flexural Modulus	80,000 psi, min.	ASTM D790
Tensile Strength	Tensile Strength 3,000 psi, min.	ASTM D638
Elongation	Elongation 400%, min.	ASTM D638
Slow Crack Growth Resistance	An ESCR as per condition B, 10% IGEPAL requirement of F <sub>10</sub> >96 hrs is allowable	ASTM D1693
Hydrostatic Design Basis	"0" for Non-Pressure Rated Pipe	ASTM D2837
UV Resistance (Outdoor Conduit Only)	Stabilize with at least 2% by weight carbon black or colored with UV Inhibitor	ASTM D4218

Furnish conduits in the colors for the applications shown in the table below. For conduits manufactured with stripes, ensure the stripes are uniformly located around

the conduit with 120 degrees of separation. Do not use “Solid Yellow” or “Black with Yellow Stripes” conduit.

CONDUIT COLORS		
Conduit Contents	Preferred Solid Color	Alternate
Signal Cable	Black	None
Loop Lead-in Cable	White	Black with White Stripes
Communications Cable (Copper, Fiber-Optic, Coaxial)	Orange	Black with Orange Stripes
Electrical Power Cable	Red	Black with Red Stripes

Ensure the HDPE conduit is resistant to benzene, calcium chloride, ethyl alcohol, fuel oil, gasoline, lubricating oil, potassium chloride, sodium chloride, sodium nitrate and transformer oil and is protected against degradation due to oxidation and general corrosion.

Furnish factory lubricated, low friction, conduit with a coefficient of friction of 0.10 or less in accordance with Telcordia GR-356. Ensure the supplied conduit is identified and certified as meeting, UL Standard 651A. Ensure the conduit is marked at least with the following information on 5 feet or less intervals:

- 1) Material: HDPE
- 2) Trade Size: i.e., 2 inches
- 3) Conduit Type: SDR 13.5 or EPEC-B
- 4) Manufacturer’s name or trademark
- 5) Manufacturer’s production code to identify manufacturing date, facility, etc.
- 6) NRTL symbol or listing number

Furnish coilable conduit that is supplied on reels in continuous lengths for transportation and storage outside. Ensure that the process of installing the coilable conduit on the reel does not alter the properties or performance of the conduit for its intended purpose.

#### **D. Conduit Plugs, Pull Line, and Tracer Wire**

Furnish conduit plugs that provide a watertight barrier when installed in conduit. Furnish conduit plugs sized in accordance with conduit. Ensure conduit plug provides a means to secure a pull line to the end of the plug. Provide removable and reusable duct plugs. Conduit plugs are not required to be listed electrical devices.

For all spare conduits, furnish woven polyester pull tape with a minimum rate tensile strength of 2,500 lb. Pull lines are not required to be listed electrical devices.

Provide green insulated number 14 AWG, THWN, stranded copper wire to serve as tracer wire.

Furnish non-detectable underground marker tape with the wording “WARNING – Fiber-Optic Cable” in all trenches containing one or more conduits that will house fiber-optic communications cable.

#### **E. Mechanical Couplings for HDPE Conduit**

Provide mechanical couplings that are both watertight and airtight for joining two segments of HDPE conduit of like diameter. Provide couplings designed to accommodate pneumatic methods of cable installation. Provide couplings suitable for burial underground and which meet the following requirements:

- The coupling shall not fail by leakage when subjected to sustained internal pressure testing as noted in ASTM F 2176.
- The coupling shall not fail by leakage when subjected to sustained external pressure testing as noted in ASTM F 2176.
- The coupling assemblies tested shall be able to comply with the tensile loading requirements as specified in ASTM F 2176.
- As specified in ASTM F 2176, the coupling shall not fail when conditioned at low temperature conditions of 10° F and tested by an impact with a force of 20 ft-lb using Type “B” as described in Test Method ASTM D 2444.

#### **F. Duct and Conduit Sealer**

Use duct and conduit sealer or mastic which is a putty-like compound and:

- Is permanently non-hardening, non-oxidizing, and non-corrosive to metals, rubber, plastic, lacquer and paints;
- Is readily workable for thumbing into openings and forming into seals around wires inside conduits and openings around conduits;
- Has a service temperature range of minus 30°F to 200°F;
- Is clean, non-poisonous and non-injurious to human skin;
- Seals against water, dust and air and shall adhere to wood, glass, plastics, metal, rubber and painted surfaces; and
- Is non-conductive.

### **7.3.CONSTRUCTION METHODS**

#### **A. General**

Except where the Plans call for a specific installation method or where the Engineer directs otherwise, underground conduit may be installed by either trenching, directional drilling or plowing at the option of the Contractor but will be measured and paid for as “underground conduit,” regardless of installation method (see “Measurement and Payment” subsection).

Refer to Section 1 of these Project Special Provisions for additional requirements concerning work within and adjacent to historic districts.

Ensure conduit is free of moisture and debris before pulling cables.

Where cable is not immediately installed or conduit is for future use (spare), seal the ends of the conduit with a conduit plug immediately following installation of the conduit. Secure a pull

line to the conduit plug in such a manner that it will not interfere with installation of the conduit plug and provides a watertight seal.

Extend ends of conduit 2 inches to 4 inches above concrete surfaces and 4 inches above crushed stone bases. For metallic conduit, install metallic bushings and bond conduits.

All conduits installed in a common trench or bore must be the same size and all conduits in a continuous longitudinal run must be the same size. Do not intermix different size conduits in the same run.

Install a minimum of two conduits (i.e., at least one for fiber-optic cable plus one dedicated spare) for all underground routes unless the Plans show otherwise.

Install junction boxes in underground conduit runs as shown on the Plans. Do not exceed 150 feet between junction boxes in any underground conduit route that conveys traffic signal or lead-in cable and 1,500 feet between junction boxes in any underground conduit route that conveys communications cable without the prior approval the Engineer.

### **1. Conduit Entering Junction Boxes**

Terminate conduits installed for communications cables (fiber-optics, Ethernet and coaxial) in oversized or special-sized junction boxes as shown on the Plans. Do not install other conduits in these junction boxes unless otherwise specified.

Terminate conduits installed for signal wiring, including loop lead-in cable, in standard size junction boxes unless otherwise specified.

For all conduits entering junction boxes, seal spare conduits with approved conduit plugs. Seal conduits containing fiber-optic communications cable, Ethernet cable, signal cable and lead-in cable with duct and conduit sealer.

### **2. Existing Underground conduit segment/junction box unviable for use:**

At locations where an existing conduit segment has been identified for reuse but is damaged and unviable for use, the Contractor, with the approval of the Engineer, shall abandon the existing conduit in place and install a new conduit segment close by. If the conduit segment enters a junction box also identified for reuse that is also unviable, remove the existing junction box and fill with a subgrade material and install a new junction box to terminate the new conduit segment entering and exiting the junction box.

### **3. Tracer Wire**

Install tracer wire in all conduits containing fiber-optic cable or ethernet cable, unless otherwise indicated on the Plans or the Engineer directs otherwise. Pull tracer wire simultaneously in continuous length with the fiber-optic cable and/or ethernet cable. Where multiple pulls of fiber-optic cable are required and conduit is placed in the same trench, only one tracer wire is required. Where multiple pulls of fiber-optic cable are required and conduits may separate into individual trenches, install a tracer wire in each conduit run. Splice tracer wire only in cabinets and junction boxes using waterproof butt splice connectors. Coil and store 10 feet of spare tracer wire in junction boxes. Label all tracer wires entering a signal cabinet. For a given tracer wire run between two controller cabinets, bond the tracer wire to the equipment ground inside the controller cabinet at one end of run only; do not bond both ends of the tracer wire in a continuous run to cabinet grounds at each end of the run. Establish a consistent convention for

which end the tracer wire will be bonded along a give roadway or corridor. For example, bond the end of the tracer wire closest/to (in the direction of) the TMC.

#### 4. Ground Surface Restoration

Upon completion of conduit installation and backfilling of all trenches and other excavations, restore the disturbed ground to its original condition as determined and approved by the Engineer. For paved areas, replace removed or damaged pavement with in kind materials, matching the elevation, color, texture/finish and general appearance of the surrounding pavement. Refer to Section 1 of these Project Special Provisions for additional requirements concerning sidewalks and curbs in historic districts. For unpaved areas, backfill excavations with removed material, tamp the backfilled material and rake smooth the top 1½ inches. Finish unpaved areas flush with surrounding natural ground and to match the original contour of the ground. Seed with same type of grass as surrounding area and mulch the newly seeded area. If unpaved area was not grassed, replace the original ground cover in kind as directed by the Engineer.

The kinds of seed and fertilizer, and the rates of application of seed, fertilizer, and limestone, shall be as stated below. During periods of overlapping dates, the kind of seed to be used shall be determined. All rates are in pounds per acre.

#### All Roadway Areas

##### March 1 – August 31

50#	Tall Fescue
10#	Centipede
25#	Bermudagrass (hulled)
500#	Fertilizer
4000#	Limestone

##### September 1 – February 28

50#	Tall Fescue
10#	Centipede
35#	Bermudagrass (hulled)
500#	Fertilizer
4000#	Limestone

Note: 50# of Bahiagrass may be substituted for either Centipede or Bermudagrass only upon Engineer's request.



## Approved Tall Fescue Cultivars

06 Dust	Escalade	Justice	Serengeti
2 <sup>nd</sup> Millennium	Essential	Kalahari	Shelby
3 <sup>rd</sup> Millennium	Everygreen 2	Kitty Hawk 2000	Sheridan
Apache III	Falcon IV	Legitimate	Signia
Avenger	Falcon NG	Lexington	Silver Hawk
Barlexas	Falcon V	LSD	Sliverstar
Barlexas II	Faith	Magellan	Shenandoah Elite
Bar Fa	Fat Cat	Matador	Sidewinder
Barrera	Festnova	Millennium SRP	Skyline
Barrington	Fidelisty	Monet	Solara
Barrobusto	Finelawn Elite	Mustang 4	Southern Choice II
Barvado	Finelawn Express	Ninja 2	Speedway
Biltmore	Finesse II	Ol' Glory	Spyder LS
Bingo	Firebird	Olympic Gold	Sunset Gold
Bizem	Firecracker LS	Padre	Taccoa
Blackwatch	Firenza	Patagonia	Tanzania
BladeRunner II	Five Point	Pedigree	Trio
Bonsai	Focus	Picasso	Tahoe II
Braveheart	Forte	Piedmont	Talladega
Bravo	Garrison	Plantation	Tarheel
Bullseye	Gazelle II	Proseeds 5301	Terrano
Cannavaro	Gold Medallion	Prospect	Titan ltd
Catalyst	Grande 3	Pure Gold	Titanium LS
Cayenne	Greenbrooks	Quest	Tracer
Cessane Rx	Greenkeeper	Raptor II	Traverse SRP
Chipper	Gremlin	Rebel Exeda	Tulsa Time
Cochise IV	Greystone	Rebel Sentry	Turbo
Constitution	Guardian 21	Rebel IV	Turbo RZ
Corgi	Guardian 41	Regiment II	Tuxedo RZ
Corona	Hemi	Regererate	Ultimate
Cooyote	Honky Tonk	Rendition	Venture
Darlington	Hot Rod	Rhambler 2 SRP	Umbrella
Davinci	Huneter	Rembrandt	Van Gogh
Desire	Inferno	Reunion	Watchdog
Dominion	Innovator	Riverside	Wolfpack II
Dynamic	Integrity	RNP	Xtremegreen
Dynasty	Jaguar 3	Rocket	
Endeavor	Jamboree	Scorpion	

On cut and fill slopes 2:1 or steeper Centipede shall be applied at the rate of 5 pounds per acre and add 20# of Sericca Lespedeza from January 1 – December 31.

Fertilizer shall be 10-20-20 analysis. A different analysis of fertilizer may be used provided the 1-2-2 ratio is maintained and the rate of application adjusted to provide the same amount of plant food as a 10-20-20 analysis and as directed.

Complete repairs to and restoration of all ground (paved and unpaved) disturbed by construction within five consecutive calendar days following initial removal. If the Contractor fails to repair and restore the ground in accordance with these Project Special Provisions within the time frame specified, the Department reserves the right to make the necessary repairs, and all expenses incurred by the Department in making the repairs and restoring the ground will be deducted from payment due the Contractor, plus **\$500 liquidated damages per occasion, per day, or any portion** thereof, until corrected.

#### **5. Plan of Record Drawings**

Upon completion of the conduit system for communications, furnish the Engineer with a plan of record drawing detailing both the horizontal and vertical (i.e. depth) locations of the conduit system.

#### **B. Trenching**

##### **1. General**

Install PVC, HDPE, or rigid metallic conduit for all underground runs as specified in the Plans. Install rigid metallic conduit for all trenched underground runs located inside railroad right-of-way, unless otherwise specified. Clean existing underground conduit to be incorporated into a new system by drawing a mandrel through the conduit followed by a swab. Clear obstructions or blockages in an existing underground conduit designated for reuse by using compressed air, water jetting, rod and mandrel or other method as approved by the Engineer. Once obstruction/blockage has been cleared, perform aforementioned cleaning procedure to clean out any remaining materials which may cause cable abrasions. Bond all metallic conduit.

If more than one conduit is required between the same points, install conduit in one common trench.

Install non-detectable marker tape longitudinally in the trench 12 inches below the unpaved ground surface or below the underside of the paved surface.

Install longitudinal runs of conduit a minimum of 1 foot from back of curb or 6 feet from edge of pavement in the absence of curb. If ditches are present, install conduit a minimum of 4 feet from the bottom of the ditch line.

Maintain a minimum trench depth of 30 inches (or 12 inches in areas blocked by rock or impenetrable obstructions) below finished grade or 6 inches below roadway sub-base, whichever is deeper. Upon completion, restore surface to like-original condition within seven consecutive calendar days of occurrence of damage. Remove all rock and debris from backfill material. Remove excess material from site and compact area according to Article 300-7 of the *Standard Specifications*. Backfill with excavated material and compact to 95% of original density.

Backfill trench at locations along the trench path where non-movable objects, such as rocks and boulders, cannot be avoided. The purpose of the backfill is to provide a gradual change in elevation of the trench, so that excessive bending and stress will not be transferred to conduits once underground conduit system is installed.

After installation of conduits and upon completion of tamping and backfilling, perform a mandrel test on each conduit to ensure no conduit has been damaged. Furnish a non-metallic mandrel having a diameter of approximately 50% of the inside diameter of the conduit in which it is to be pulled through. If damage has occurred, replace the entire length of conduit. Ensure pull line is re-installed.

Use HDPE conduit in trenched areas unless otherwise specified in the Plans. Use 2-inch PVC or rigid galvanized conduit between junction boxes adjacent to the controller cabinet and the 2-inch conduit stub-outs from the cabinet foundation.

Comply with the *NCDOT Policies and Procedures for Accommodating Utilities on Highway Rights-of-Way* in effect on the date of advertisement.

## 2. Unpaved Trenching

Install conduit in unpaved areas for all cable including permanent traffic signal installations. Rake smooth the top 1-1/2 inches and seed with same type of grass as surrounding area. Finish unpaved areas flush with the surrounding natural ground. Restore damaged grassed areas. Seed and mulch, using methods and material approved by the Engineer, within five consecutive calendar days following initial damage to grassed areas, unless the Engineer approves otherwise due to weather and soil conditions. If the Contractor fails to repair the grassed areas in accordance with these Project Special Provisions within the time frame specified, the Department reserves the right to make the necessary repairs, and all expenses incurred by the Department in making the repairs and restoring the grassed area will be deducted from payment due the Contractor, plus **\$500 liquidated damages per occasion, per day, or any portion thereof**, until corrected.

Adapt operations to variations in weather or soil conditions as necessary for the successful establishment and growth of the grasses. When the Engineer determines that weather and soil conditions are unfavorable, including but not limited to extremely wet or frozen soil, do not distribute any limestone or fertilizer and do not sow any seed. During seasons of the year when temperatures are not conducive to germination and growth of the type of grass seed to be planted, seed and mulch the disturbed areas with temporary seeding that will germinate and grow under the prevailing temperatures until such time that permanent seeding can be established, as approved and directed by the Engineer.

As directed by the Engineer, apply additional seed or completely reseed areas which have been previously seeded and mulched but which have been damaged, have failed to successfully establish a stand of vegetation or have an unsatisfactory cover of vegetation. Perform supplemental and repair seeding promptly at all locations and times as directed by the Engineer.

## 3. Paved Trenching

On concrete surfaces, replace the entire joint of concrete and match the original concrete as to color and finish unless otherwise specified. On all other surfaces, neatly cut and replace the width of trench with like material. Refer to Section 1 of these Project Special Provisions for additional requirements concerning sidewalks and curbs in historic districts. Place graded stone material to temporarily maintain pedestrian traffic where repairs cannot be performed immediately.

Finish paved areas with materials matching damaged areas. For conduit installed under roadways, cut neatly and replace the width of paved area damaged by trenching. For conduit

installed under sidewalks and walkways, remove entire section of slab from joint to joint and replace. Place graded stone material to temporarily maintain traffic where repairs cannot be performed immediately. Comply with Article 545-4 of the *Standard Specifications*.

Complete repairs to all paved areas removed for construction within five consecutive calendar days following initial removal. If the Contractor fails to repair the paved area in accordance with these Project Special Provisions within the time frame specified, the Department reserves the right to make the necessary repairs, and all expenses incurred by the Department in making the repairs and restoring the paved area will be deducted from payment due the Contractor, plus **\$500 liquidated damages per occasion, per day, or any portion thereof**, until corrected.

### **C. Plowing (HDPE Conduit Only)**

Direct plow HDPE ducts simultaneously using chute plow method. Direct plow ducts at a minimum depth so the top of the highest duct is 30 inches deep unless otherwise approved.

Provide sufficient personnel to feed chute, operate prime mover and equipment carrying reels (if separate equipment is used), observe chute feeding, observe plowing, and observe reel payout. Use chute with adequate dimensions to allow for passage of duct without damage. During plow operation, continuously check chute opening and path to be sure there are no obstructions and monitor payout reels to be sure reels are turning at a steady rate.

### **D. Directional Drilling**

#### **1. Pre-Approvals and Minimum Depth Requirements**

Obtain approval before beginning drilling operations.

At all points where HDPE conduit will traverse under roadways, driveways, sidewalks, or Controlled Access Areas including entrance/exit ramps, maintain a minimum depth of 4 feet or 8 times the back reamer's diameter, whichever is deeper. For an installation that runs parallel to a controlled access area or entrance/exit ramps maintain a minimum depth of 30 inches below finished grade. Maintain a minimum clearance of 30 inches below finished grade when crossing ditch lines.

For the following structures, the minimum clearance requirements are:

<b>MINIMUM CLEARANCE REQUIREMENTS FOR STRUCTURES</b>	
<b>Man-made Structure</b>	<b>Minimum Clearance Requirement</b>
Bridge foundation	5 ft horizontal & 4 ft vertical (clearances greater than minimum horizontal should continue to use the 4V:5H ratio, i.e., 10 ft horizontal should be no deeper than 8 ft)
Drainage pipes 60" or less	1 ft above or below [while maintaining a minimum depth of 30" below grade]
Drainage pipes greater than 60"	1 ft above or 4 ft below [while maintaining a minimum depth of 30" below grade]
Box Culverts	1 ft above or 4 ft below [while maintaining a minimum depth of 30" below grade]
Slope protection	2 ft below
Slope protection foundation footing	5 ft below

Guarantee the drill rig operator and digital walkover locating system operator are factory-trained to operate the make and model of equipment provided and have at least one-year experience operating the make and model of drill rig. Submit documentation of the operators' training and experience for review at least two weeks before start of directional drilling operations.

Provide a means of collecting and containing drilling fluid/slurry that returns to the surface such as a slurry pit. Provide measures to prevent drilling fluids from entering drainage ditches, storm sewer systems or bodies of water (streams, rivers, ponds and lakes). Prevent drilling fluid/slurry from accumulating on or flowing onto pedestrian walkways, driveways, and streets. Disposal on public or railroad right-of-way or railroad drainage ditches/facilities is prohibited. Immediately remove all drilling fluids/slurry that are accidentally spilled.

Provide all drilling equipment, tooling, personnel and techniques necessary to complete the installation of the underground conduit through directional drilling for all soil conditions encountered, all drilling depths specified and all drilling lengths specified in these Project Special Provisions and as shown in the Plans.

## **2. Directional Drill Operations**

Provide grounding for the drill rig in accordance with the manufacturer's recommendations. Place excavated material near the top of the working pit and dispose of properly. Backfill pits and trenches to facilitate drilling operations immediately after drilling is completed.

No geotechnical investigations have been performed at the sites of proposed directional drill operations for this project. Prior to performing the directional drilling operation, field investigate the site of the proposed directional drill conduit, including but not limited to walking the bore path and talking to adjacent property owners, to ascertain the soil conditions that may be encountered and to review the site's topography. Ensure that the equipment, tooling, personnel expertise and techniques used at each site are sufficient to complete the directional drill operation

successfully, regardless of soil conditions encountered. At all times, have alternate drill heads available in case the soil conditions do not match expected conditions.

Use drill head suitable for type of material being drilled and sized no more than 2 inches larger than the outer diameter of the conduit. Pressure grout with an approved bentonite/polymer slurry mixture to fill all voids. Do not jet alone or wet bore with water.

During drilling operation, locate drill head every 10 feet along drill path and before traversing underground utilities or structures. Use digital walkover locating system to track drill head during directional drilling operation. Ensure locating system is capable of determining pitch, roll, heading, depth, and horizontal position of the drill head at any point.

Once drill head has reached final location, remove head, and install back reamer of appropriate size (no more than 2 inches larger than outer diameter of conduits to simultaneously facilitate back reaming of drill hole and installation of conduit. Use back reamer that is sized larger than actual conduits to ensure conduits are not adversely subjected to deviations caused by the original drill operation and are as straight as practical in their final position.

The intent of these Project Special Provisions is to limit the diameter of the actual drill shaft/hole so that it is no more than 2 inches larger than the conduit outer diameter.

Once installation of conduit has started, continue installation without interruption so as to prevent conduit from becoming firmly set. Apply bentonite/polymer slurry mixture during conduit installation.

Upon completion of conduit installation, perform a mandrel test on conduit system to ensure conduit has not been damaged. Furnish non-metallic mandrel with a diameter of approximately 50% of the inside diameter of the conduit in which it is to be pulled through. If damage has occurred, replace the entire length of conduit and ensure that pull line is re-installed.

### **3. Drilling Fluids**

Use lubrication for subsequent removal of material and immediate installation of the conduit. The use of water and other fluids in connection with directional drilling operations will be permitted only to the extent necessary to lubricate cuttings. Do not jet alone or wet bore with water. Use drilling fluid/slurry consisting of at least 10% high-grade bentonite/polymer slurry to consolidate excavated material and seal drill hole walls.

Transport waste drilling fluid/slurry from site and dispose of in a method that complies with local, state and federal laws and regulations. Disposal on public or railroad right-of-ways or within public or railroad drainage ditches/facilities is prohibited. Disposal in streams, rivers, ponds, lakes and wetlands is also prohibited.

### **4. Conduit Splicing**

With prior approval, install a junction box at locations where splicing or coupling of conduit is necessary. Otherwise, splicing or joining of HDPE conduit is prohibited.

### **E. Maximum Length of Directional Drill**

The length of a directional drill shall not exceed 1,500 feet measured horizontally along the route of the directionally drilled conduit(s), unless otherwise approved by the Engineer. For routes longer than 1,500 feet, begin a successive directional drill where the first directional drill

reaches 1,500 feet and install an oversized heavy-duty junction box where the two directional drilled conduit runs meet. The spacing of junction boxes in a directionally drilled route shall not exceed 1,500 feet.

#### **7.4.MEASUREMENT AND PAYMENT**

*Tracer wire* will be measured along the horizontal linear feet of tracer wire furnished, installed, and accepted. Measurement will be along the approximate centerline of the conduit system. Payment will be made in linear feet. No payment will be made for excess tracer wire in junction boxes and/or cabinets.

*Underground conduit (qty)(size)* will be measured in horizontal linear feet of underground conduit installation of each type furnished, installed, and accepted, without regard to the installation method. Measurement will be along the approximate centerline of the conduit system. Payment will be in linear feet.

No measurement will be made of 1" underground conduit that conveys electrical service wire between a service riser and a disconnect/meter and between a disconnect and a signal cabinet as such work will be considered incidental to furnishing and installing a new electrical service, or modifying an existing electrical service. (See "Electrical Service" section of these Project Special Provisions).

*Directional drill (qty)(size)* will be measured in horizontal linear feet of directional drill for underground conduit installation furnished, installed, and accepted. Measurement will be along the approximate centerline of the conduit system. Payment will be made in linear feet. When directional drilling is used where the Plans call for "Underground Conduit", directional drilling will be measured and paid for as Underground Conduit. There will be no additional compensation for field-investigating site conditions nor for providing any specialized equipment, tooling, personnel or techniques necessary to complete the installation of the underground conduit through directional drilling for the soil conditions encountered, including but not limited to rock, or for deep or long bores. There will be no additional requirements for any special measures required to protect bodies of water such as rivers, streams, ponds and lakes when drilling beneath as required by local, state and federal rules and regulations.

No measurement will be made of vertical segments, non-metallic conduit, metallic conduit, conduit sealing material (i.e. moldable duct seal), pull lines, duct plugs, marker tape, and miscellaneous fittings, as these will be considered incidental to conduit installation.

No measurement will be made of clearing existing blockages and obstructions from existing conduits nor for cleaning existing conduits prior to installation of new communications cable inside the existing conduits as such work will be considered incidental to furnishing and installing the communications cable.

No measurement will be made of restoration of paved roadways/driveways and unpaved ground surfaces with like materials, including but not limited to backfill, graded stone, paved materials, seeding and mulching, as this work will be considered incidental to conduit installation. The Department will make no payment for a given underground conduit run until all repairs to paved and unpaved surfaces damaged/disturbed during the installation of the underground conduit have been completed and accepted.

Repair and replacement of existing sidewalk will be measured and paid for in accordance with the "Signal Cabinet Foundations" section of these Project Special Provisions.

No measurement will be made of horizontal segments between the base of a riser and an adjacent junction box or base-mounted cabinet foundation that are 10 feet or less in length measured from the center of the riser to the center of the junction box or from the center of the riser to the center of the vertical sweep through the cabinet foundation as these will be considered incidental to riser installation.

No measurement will be made of conduit segments between adjacent traffic signal system junction boxes that are 10 feet or less in length measured from center of junction box to center of junction box as these will be considered incidental to furnishing and installing the junction boxes.

Conduit will be paid for per linear foot based on quantity and size of conduits. As examples, an installation of a single 2" HDPE conduit would be paid as:

Directional Drill (1)(2") Linear Foot

No measurement or payment will be made for furnishing and installing and subsequently removing graded stone material for temporary maintenance of traffic where a portion of existing pavement has been removed as such work will be considered incidental to furnishing and installing underground conduit.

Payment will be made under:

<b>Pay Item</b>	<b>Pay Unit</b>
Tracer Wire	Linear Foot
Underground Conduit (1)(1")	Linear Foot
Underground Conduit (1)(2")	Linear Foot
Underground Conduit (2)(2")	Linear Foot
Underground Conduit (3)(2")	Linear Foot
Directional Drill (1)(2")	Linear Foot
Directional Drill (2)(2")	Linear Foot



## 8. JUNCTION BOXES

### 8.1.DESCRPTION

Furnish and install junction boxes (pull boxes) with covers, washed stone, grounding systems, and all necessary hardware.

### 8.2.MATERIALS

#### A. General

Provide electrical junction boxes with covers of the type and size indicated by the contract or the Plans for the termination of conduits, for splicing loop wires to loop lead-in cables and for splicing and storing fiber-optic communications cable. .

Except for special-sized junction boxes, material, equipment, and hardware furnished under this section shall be pre-approved on the ITS and Signals QPL.

Refer to Division 10 of the *Standard Specifications*:

Item	Section(s)
#57 or #67 Washed Stone	1005

#### B. Polymer Concrete (PC) Junction Boxes

Provide polymer concrete (PC) boxes which have bolted covers and have open bottoms. Provide vertical extensions of 6 inches to 12 inches as required by the project provisions.

Use polymer concrete material made of an aggregate consisting of sand and gravel bound together with a polymer and reinforced with glass strands to fabricate box and cover components which are exposed to sunlight. Other thermoplastic materials may be used for components which are not normally exposed to sunlight.

Provide certification that the polymer concrete boxes and covers meet Tier 15 requirements of ANSI/SCTE 77. Provide certification that testing methods are compliant with ANSI/SCTE 77.

Provide junction box covers with the required logos on the cover as follows (see NCDOT *Roadway Standard Drawing* No. 1716.01 for additional details):

- For standard size junction boxes that contain traffic signal cable and loop lead-in cable, provide covers with the standard *TRAFFIC SIGNAL* logo;
- For standard size junction boxes that house electrical service conductors, provide covers with the standard *ELECTRIC* logo; and
- For oversized and special-sized junction boxes, provide covers with the following standard logo/imprint: *NCDOT* (line 1) *FIBER* (line 2) *OPTIC* (line 3).

Provide at least two (2) size 3/8 inch diameter hex head stainless steel cover bolts to match inserts in the box. Provide pull slot(s) with stainless steel pin(s). Polymer concrete junction boxes are not required to be listed electrical devices.

### C. Junction Box Sizes

Provide junction boxes and covers of the following sizes as called for in the Plans:

Junction Box Size	Minimum Inside Dimensions
Standard Size	16"(l) x 10"(w) x 10"(d)
Oversized	28"(l) x 15"(w) x 22"(d)
Special-Sized	36"(l) x 24"(w) x 24"(d)

## 8.3.CONSTRUCTION METHODS

### A. General

Install junction boxes flush with finished grade. Backfill beneath and around the junction box using #67 washed stone as shown in NCDOT *Roadway Standard Drawing* No. 1716.01. Do not install sealant compound between junction boxes and covers.

Upon completion of junction box installation and backfilling of all excavations, restore the disturbed ground to its original condition as determined and approved by the Engineer. For paved areas, replace removed or damaged pavement with in kind materials, matching the elevation, color, texture/finish and general appearance of the surrounding pavement. Refer to Section 1 of these Project Special Provisions for additional requirements concerning sidewalks and curbs in historic districts. For unpaved areas, backfill excavations with removed material, tamp the backfilled material and rake smooth the top 1½ inches. Finish unpaved areas flush with surrounding natural ground and to match the original contour of the ground. Seed with same type of grass as surrounding area and mulch the newly seeded area. If unpaved area was not grassed, replace the original ground cover in kind as directed by the Engineer.

**Complete restoration of all ground disturbed during junction box installation within five consecutive calendar days following initial removal and excavation.** If the Contractor fails to repair and restore the disturbed ground in accordance with these Project Special Provisions within the time frame specified, the Department reserves the right to make the necessary repairs, and all expenses incurred by the Department in making the repairs and restoring the ground will be deducted from payment due the Contractor, plus **\$500 liquidated damage per occasion, per day, or any portion thereof**, until corrected.

Install standard size junction boxes as shown in the Plans and where underground splicing of electrical cables is necessary. Install standard size junction boxes within 3 feet of pole or pole foundation where transitioning from below ground to a riser assembly. Install standard size junction boxes within 5 ft of each end of each lateral run of conduit for electrical cables. When lateral runs for electrical cables are greater than 150 feet, install additional junction boxes to ensure distances between junction boxes does not exceed 150 feet.

Install oversized junction boxes as shown in the Plans in underground fiber-optic communications cable runs where the conduit run transitions from directionally drilled conduit to trenched conduit and where transitioning from below ground to a riser assembly. Install

oversized junction boxes in underground fiber-optic communications cable runs at maximum intervals of 1,500 feet, or where shown in the Plans, whichever is less.

Install special-sized junction boxes at all underground splice enclosure locations in underground fiber-optic communications cable runs as shown in the Plans.

### B. GPS Coordinates

Provide real world coordinates for all junction boxes and signal cabinets installed or used under this project. Provide the coordinates in feet units using the North Carolina State Plane coordinate system (1983 North American Datum also known as NAD '83). Furnish coordinates that do not deviate more than 1.7 feet in the horizontal plane and 3.3 feet in the vertical plane. Global positioning system (GPS) equipment able to obtain the coordinate data within these tolerances may be used. Submit cut sheets on the GPS unit proposed to collect the data for approval by the Engineer.

Provide both digital copies and hard copies of all information regarding the location (including to but not limited to manufacturer, model number, and NCDOT inventory number) in the Microsoft® spreadsheet provided by the Department, using the format shown in example below. In addition to Excel format, provide a digital copy of the location information as an ESRI Shapefile (.SHP file format).

NCDOT Inv #	Name	Location	Latitude	Longitude	Manufacturer	Model #
05-0134	Signal Cabinet	US 70 at Raynor Rd./ Auburn-Knightdale	-78.5500	35.6873	McCain	Type-332
05-0134	Junction Box # 1 (Phase 2 Side)	US 70 at Raynor Rd./ Auburn-Knightdale	-78.5516	35.6879	Quazite	PG1118BA12(Box) PG118HA00(Cover)
05-0134	Junction Box # 2 (Phase 2 Side)	US 70 at Raynor Rd./ Auburn-Knightdale	-78.5506	35.6876	Quazite	PG1118BA12(Box) PG118HA00(Cover)
05-0134	Junction Box # 3 (Near Cabinet)	US 70 at Raynor Rd./ Auburn-Knightdale	-78.5501	35.6873	Quazite	PG1118BA12(Box) PG118HA00(Cover)
05-0134	Junction Box # 4 (Phase 6 Side)	US 70 at Raynor Rd./ Auburn-Knightdale	-78.5486	35.6873	Quazite	PG1118BA12(Box) PG118HA00(Cover)
05-0134	Junction Box # 5 (Phase 6 Side)	US 70 at Raynor Rd./ Auburn-Knightdale	-78.5493	35.6876	Quazite	PG1118BA12(Box) PG118HA00(Cover)
05-0134	Junction Box # 6 (Phase 4 Side)	US 70 at Raynor Rd./ Auburn-Knightdale	-78.5503	35.6879	Quazite	PG1118BA12(Box) PG118HA00(Cover)

### 8.4. MEASUREMENT AND PAYMENT

*Junction box* ( \_\_\_\_\_ ) will be measured and paid in actual number of junction boxes of each size and type furnished, installed, and accepted.

No measurement will be made of covers, graded stone, removal of existing junction boxes and grounding systems as these will be considered incidental to furnishing and installing junction boxes.

No measurement will be made of restoration of paved roadways/driveways and unpaved ground surfaces with like materials, including but not limited to backfill, washed stone, paved materials, seeding and mulching, as this work will be considered incidental to junction box installation. The Department will make no payment for a given junction box until all repairs to paved and unpaved surfaces damaged/disturbed during the installation of the junction box have been completed and accepted.

Repair and replacement of existing sidewalk will be measured and paid for in accordance with the "Signal Cabinet Foundations" section of these Project Special Provisions.

No measurement will be made of collecting and recording GPS coordinates for junction boxes and compiling this data in the prescribed Microsoft® spreadsheet as such work will be considered incidental to furnishing and installing junction boxes.

Payment will be made under:

<b>Pay Item</b>	<b>Pay Unit</b>
Junction Box (Standard Size)	Each
Junction Box (Over-Sized, Heavy Duty)	Each
Junction Box (Special-Sized)	Each

## 9. WOOD POLES

### 9.1.DESCRPTION

Furnish and install wood poles and all necessary hardware.

Furnish and install pole grounding systems consisting of #6 AWG solid bare copper wire, messenger bonding clamps, hot-dipped galvanized wire staples, ground rods, and irreversible compression couplers.

### 9.2.MATERIALS

#### A. General

Refer to Division 10 of the *Standard Specifications*:

Item	Section(s)
Inspection Requirements	1082
Structural Timber and Lumber	1082

Material, equipment, and hardware furnished under this section shall be pre-approved on the ITS and Signals QPL for wood poles available on the Department's website.

Furnish treated timber poles that meet the requirements of ANSI O5.1, except the timber shall be treated Southern Pine or treated Douglas Fir.

Treat poles in accordance with AWWA Standard U1 and T1, except require retention of preservative as below.

Give all poles a preservative treatment of either pentachlorophenol, or chromated copper arsenate. The same type of preservative shall be used throughout the entire length of the project.

Minimum retention for poles treated with pentachlorophenol will be 0.45 lb. by assay of dry chemical per cubic foot of wood. Minimum retention for poles treated with chromated copper arsenate will be 0.6 lb. by assay of dry chemical per cubic foot of wood.

In addition, refer to the following subsections of these Project Special Provisions:

- the "Wire and Cable" subsection of the "General Requirements" section, and
- the "Grounding Electrodes" subsection of the "Electrical Service" section.

#### B. Wood Poles for Signals

Furnish Class 3 or better wood poles that have a minimum length of 40 feet and are of a sufficient length to maintain the minimum required clearances above roadway and obstacles for replacement of existing signal poles that will not accommodate CCTV cameras.

#### C. Wood Poles for Signals with CCTVs

Furnish Class 3 or better wood poles that have a minimum length of 50 feet and are of a sufficient length to maintain the minimum required clearances above roadway and obstacles for replacement of existing signal poles that will also accommodate CCTV cameras. Furnish Class 3 or better wood poles to mount CCTV cameras that are of sufficient length to permit the CCTV camera to be mounted at the mounting height specified in the Plans. To provide for CCTV camera mounting heights of up to 35 feet above the ground at the base of the pole, furnish CCTV wood poles that are at least 50 feet in length. The Contractor shall visit the site of the proposed

CCTV poles to confirm the length of pole required to attain the specified mounting prior to ordering the CCTV poles.

#### D. Span Transfers

When a Span Transfer is indicated in the “Summary of Work By Intersection” in the Plans, supply new eyebolts, nuts, washers and other necessary pole attachment hardware as required for a new installation. Reuse existing strandwise to attach to the new pole hardware.

### 9.3.CONSTRUCTION METHODS

#### A. General

Install poles at locations shown on the Plans. Except where the Plans specify an exact location (i.e., show offsets and dimensions from known points, or indicate directly adjacent to existing pole), place the pole at an offset from the edge of travel way that is consistent with other fixed objects and utility poles along that side of the road, but in no case closer than 1.5 feet from the face of curb. Within intersection radii, install poles a minimum of 7 feet behind face of curb or 10 feet from the edge of travel way where there is no curb. If the Plans do not specify an exact locations, the pole is not within the intersection radius and there are no other poles along the side of the road where the pole is to be installed, locate the pole as far as practical from the edge of the roadway, using the setback distances in the following table as a guide:

Speed Limit	Desirable Minimum Setback Distance	
	from face of curb in curb & gutter section	from edge of travel way in shoulder section (no curb)
≤ 25 mph	8 feet	10 feet
30-35 mph	10 feet	12 feet
40 mph	12 feet	16 feet
45 mph	16 feet	18 feet
50 mph	20 feet	22 feet
55 mph	22 feet	24 feet
≥ 60 mph	n/a	30 feet

Measure the setback distance from the face of curb or edge of travel lane to the face of the pole.

Field conditions and site specific constraints may require the pole to be located at setback distances less than those listed above, subject to the approval of the Engineer.

**Mark final pole locations and receive approval from the Engineer before installing poles.**

Ensure poles are of sufficient length to maintain the minimum required clearances above the roadway, obstructions, and affected railroad tracks.

Drill or auger a hole for placement of pole and to allow for compacting. Set poles for signals and aerial cable routes at the manufacturer's recommended depth or at a depth equal to 10% of the pole length plus 2 feet, whichever is greater, but in no case less than of 5 feet deep. Set CCTV wood poles at a minimum depth of 10 feet. Ensure the pole is within 2 degrees of vertical when fully loaded.

Backfill hole with pole installed and tamp backfill in 6 inch lifts with a mechanical tamp until compacted density is at least 95% of original density.

**B. Pole Grounding System**

Install the CCTV pole grounding system as shown in the Plans.

For all other new Department-owned poles, install a grounding system consisting of #6 AWG solid bare copper wire that is mechanically crimped using an irreversible compression tool with die to a single ground rod installed at the base of the pole or to the electrical service grounding electrode system located within 10 feet of the pole. Install ground wire so as to minimize damage from vandalism and environmental exposures. Install ground wire up pole to a point adjacent to the uppermost span. Use hot-dipped galvanized wire staples to secure ground wire to pole, spacing the staples along the ground wire as follows:

- 4 inches apart from ground level to 8 feet above ground level;
- 24 inches apart from 8 feet above ground level to point adjacent to uppermost span.

**C. Span Transfers**

**1. General**

Do not extend existing messenger cable. Do not splice existing lead-in cable or signal cable to be able to transfer span. If the existing messenger cannot be transferred without the extension of the messenger cable or the splicing of the other signal or communication cables, advise the Engineer immediately to determine a course of action.

**2. Replacement Poles**

At locations shown in the Plans, existing wood signal poles are to be removed and replaced with wood poles for signals (with or without a new CCTV) in the same location. The location of the replacement pole is intended to be directly adjacent to the existing signal pole, in a direction that will facilitate the relocation of the existing spans/messenger cables and any other communication cable(s) if a joint use pole.

After installing the replacement pole, the Contractor shall re-attach all existing cables and guys in at appropriate heights to meet all requirements of the plans and be in compliance with these Project Special Provisions and the *Standard Specifications*. See "Span Transfer" subsection for additional information.

The Contractor shall also remove all cables and vertical risers associated with the existing pole unless they are to be relocated to the replacement pole.

### 3. Existing Poles

To meet the preferred design height of 18' on existing wood poles, Span Transfers may be indicated to adjust the height of an existing messenger cable to increase the clearance distance from the roadway and other obstacles. Reattach all messengers and guys at the appropriate heights to meet all requirements of the plans and be in compliance with these Project Special Provisions and the *Standard Specifications*.

#### 9.4.MEASUREMENT AND PAYMENT

*Wood pole for Signals* will be measured and paid for as the actual number of wood poles for signals furnished, installed, and accepted, regardless of length.

*Wood pole for Signals with CCTV* will be measured and paid for as the actual number of wood poles for signals with CCTVs furnished, installed, and accepted.

Pole grounding systems for **new** poles are considered incidental to furnishing and installing the wood pole. No measurement will be made for furnishing and installing ground rods, #6 AWG solid bare copper wire, messenger bonding clamps, hot-dipped galvanized wire staples, and irreversible compression couplers as part of pole grounding systems as such work will be considered incidental to furnishing and installing the wood poles.

*Pole grounding system* will be measured and paid for as the actual number of pole grounding systems, installed on **existing** poles, furnished, installed, and accepted. No measurement will be made for furnishing and installing #6 AWG solid bare copper wire, messenger bonding clamps, hot-dipped galvanized wire staples, and irreversible compression couplers as part of pole grounding systems as such work will be considered incidental to furnishing and installing the pole grounding system.

*Span Transfers* will be measured and paid as the actual number of existing messenger cable attachments that are removed, relocated and accepted. No separate pay item will be made for labor, equipment, or materials required while disconnecting and reattaching cables and wires or for any temporary relocations made before acceptance. Removal and disposal of any items not re-used will be considered incidental to this pay item. Any cables damaged during the work required for this item shall be replaced at no cost to the Department.

Payment will be made under:

<b>Pay Item</b>	<b>Pay Unit</b>
Wood Pole for Signals	Each
Wood Pole for Signals with CCTV	Each
Pole Grounding System	Each
Span Transfer	Each



## 10. GUY ASSEMBLIES

### 10.1. DESCRIPTION

Furnish and install guy assemblies with all necessary hardware.

### 10.2. MATERIALS

Material, equipment, and hardware furnished under this section shall be pre-approved on the ITS and Signals QPL.

Furnish guy assemblies with anchor assemblies, guy cable, and guy cable guard.

Provide anchor assemblies with all miscellaneous hardware consisting of either expanding anchor with rod and triple-eye attachment, screw anchor with extension rod and triple-eye attachment, or expanding rock anchor with triple-eye attachment. Ensure anchor assembly size is adequate for site conditions. Provide rods constructed of hot-dipped galvanized steel sized according to the soil bearing conditions in the area. Provide triple-eye guy attachments constructed of hot-dipped galvanized steel. Anchor assemblies with double-strand eyes may be used instead of those with the triple-eye feature when only one guy cable is to be attached. Ensure anchor assemblies are 7 feet minimum in length.

For type of anchor assembly furnished, ensure the following:

1) Expanding Anchor

Provide steel construction with protective paint or heat shrink of 6 mil plastic to protect metal during shipping and storage.

2) Screw Anchor

Provide hot-dipped galvanized steel construction.

3) Expanding Rock Anchors

Provide malleable iron and rust-resisting paint construction.

Provide 3-bolt clamp to match messenger cable size.

Provide full round guy cable guards that are 8 feet in length and constructed of ultraviolet (UV) stabilized, high impact, bright yellow, high density polyethylene (HDPE).

Provide guy cables consisting of messenger cable of the same size as the largest sized messenger cable to be guyed. Comply with the "Materials" subsection of the "Messenger Cable" section of these Project Special Provisions.

Refer to the "Pole Line Hardware" subsection of the "Messenger Cable" section of these Project Special Provisions.

### 10.3. CONSTRUCTION METHODS

#### A. General

Comply with *Roadway Standard Drawing* (RSD) No. 1721.01 when constructing guy assemblies.

#### B. Guy Assemblies for Signal Heads or Loop Lead-in Cable

Install guy assemblies with guy cable, guy guards, anchors, three-bolt clamps and associated fittings. Use two-bolt attachment method where there is adequate room on the pole to comply

with the NESC. Attach guy assembly and guy cable to two separate bolts with one bolt for span and one bolt for guy cable.

Where adequate spacing is not available and a violation of the NESC would occur with the two-bolt attachment method, use approved one-bolt attachment method for attaching messenger cable and guy assembly.

Bond guy assembly to existing pole ground and to the messenger cable using parallel groove clamp or equivalent. If existing NCDOT poles do not have a grounding system, install a grounding system in accordance with the "Wood Poles" section of the *Standard Specifications*.

Do not use guy anchors as grounding electrodes.

Do not attach to existing guy assemblies unless specifically approved by owner.

When proposed guy assembly replaces an existing guy assembly, remove the existing guy assembly, including guy anchor if not reused for the new guy assembly.

### **C. Guy Assemblies for Communications Cable**

When installing messenger cable for supporting only communications cable, use approved one-bolt attachment method for attaching messenger cable and guy assembly.

Bond guy assembly to existing pole ground and to the messenger cable using parallel groove clamp or equivalent. If existing NCDOT poles do not have a grounding system, install a grounding system in accordance with the "Wood Poles" section of these Project Special Provisions.

Do not use guy anchors as grounding electrodes. Do not attach to existing guy assemblies unless specifically approved by owner.

When proposed guy assembly replaces an existing guy assembly, remove the existing guy assembly, including guy anchor if not reused for the new guy assembly.

### **10.4. MEASUREMENT AND PAYMENT**

*Guy assembly* will be measured and paid as the actual number of direct down guy (i.e., standard guy) assemblies furnished, installed, and accepted.

*Guy assembly* (\_\_\_\_) will be measured and paid as the actual number of guy assemblies of each type (aerial or sidewalk) furnished, installed, and accepted.

No measurement will be made of guy cable, guy guards, anchors, clamps, grounding systems, strandvises, 2" galvanized pipe, pole plates, other fittings, or the removal of existing guy assemblies as these will be considered incidental to furnishing and installing guy assemblies.

**U-5942**

**ITS-99**

**Pasquotank County**

Payment will be made under:

<b>Pay Item</b>	<b>Pay Unit</b>
Guy Assembly	Each
Guy Assembly (Aerial)	Each
Guy Assembly (Sidewalk)	Each

## 11. RISER ASSEMBLIES

### 11.1. DESCRIPTION

Furnish and install riser assemblies with clamp-on, aluminum weatherheads, heat shrink tubing, temporary pipe caps, PVC adapters, galvanized pole attachment fittings, stainless steel banding hardware, grounding and all necessary hardware.

### 11.2. MATERIALS

Refer to the following subsections of these Project Special Provisions:

- the “Wire and Cable” subsection of the “General Requirements” section,
- the “Pole Line Hardware” subsection of the “Messenger Cable” section, and
- the “Grounding Electrodes” subsection of the “Electrical Service” section.

Furnish material, equipment, and hardware furnished under this section that is pre-approved on the ITS and Signals QPL.

Provide conduit for risers that is rigid hot dipped galvanized steel conduit that meets UL Standard 6 with rigid full weight sherardized or galvanized threaded fittings.

Provide Schedule 40 PVC female adapter to connect an underground run of PVC conduit to the threaded end of a rigid metallic. Provide PVC female adapters that have the same nominal diameter as the underground conduit. The interior surface of one end of the PVC female adapter shall be compatibly threaded to connect it to the threaded end of the rigid metallic riser without the aid of additional fittings, hardware or adhesives. The opposite end of the adapter shall be non-threaded to permit a slip fit, glued connection to the underground PVC conduit.

Furnish appropriately sized clamp-on aluminum weatherheads for electrical control and power cables.

Furnish heat shrink tubing for the installation of fiber-optic in a new riser. Ensure the heat shrink tubing is made of modified polyolefin and includes a hot-melt adhesive. Provide tubing that has a length of at least 5 inches before heating. Ensure the heat shrink tubing will provide a watertight fit around individual cables and outer wall of the riser after heat is applied in accordance with the manufacturer’s instructions.

Furnish heat shrink tubing kits for the installation of fiber-optic cable to an existing riser with existing cables. Ensure the heat shrink material is made of modified polyolefin and is supplied in a flat sheet design. Ensure the kit contains an apparatus to secure both ends of the flat sheet together to form a tube shaped cylinder. Ensure the securing apparatus is flexible to the point that it will allow the heat shrink material to conform to the shape and dimensions of the riser and cables once heat is applied and will not separate during the heating process. Provide heat shrink tubing kits with a hot-melt adhesive. Provide the flat sheet heat shrink material that has a minimum length of 5 inches prior to heating. Ensure the heat shrink tubing kit provides a watertight fit around individual cables and outer wall of the riser after heat is applied in accordance with the manufacturer’s instructions.

Furnish all new 2” risers that will house fiber-optic communications cable with temporary pipe caps to seal the top of the riser and prevent rain from falling into riser until fiber-optic cable can be installed in the riser and heat-shrink tubing applied to the top of the riser. Provide riser

caps constructed from heat-stabilized vinyl that fit snugly over the end of the end of the riser and that will not be easily dislodged by wind following installation. Furnish caps designed to remain in place through physical contact friction and that do not use adhesives or screws to remain securely in place. Provide caps sized to fit over each diameter (i.e., 2") of rigid galvanized conduit used for fiber-optic communications cable risers on this project.

### 11.3. CONSTRUCTION METHODS

Install risers with required weatherheads or heat shrink tubing on poles using pole attachment fittings. Maintain a 10" minimum and 18" maximum offset from signal messenger to the top riser for all risers. On utility-owned poles, maintain a 40" offset from the electrical utility's power conductors to top of riser and riser attachment fittings.

When installing risers that will house fiber-optic communications cable, immediately install a temporary pipe cap on the top of the riser to prevent rain from entering the riser until fiber-optic cable and heat-shrink tubing can be installed at a later time. Do not install risers if temporary caps cannot be installed at same time as risers. Do not install a communications cable riser and leave it uncapped/unsealed.

Use approved heat shrink tubing retrofit kits when installing new fiber-optic into existing risers that contain existing fiber-optic cables.

Install heat shrink tubing retrofit kits in existing risers as specified.

Use separate 1/2-inch riser with weatherhead for pedestrian pushbutton.

Use separate 1-inch riser with weatherhead for the following:

- Pedestrian signals;
- Electrical service; and
- CAT6 routed between the controller cabinet to a CCTV.

Use separate 2-inch risers with weatherheads for signal cables (bundled) and for lead-in cables. Install condulets on all risers for lead-in cable, railroad preempt interconnection cables and signal pedestals.

Use a separate 2 inch riser with heat shrink tubing for fiber-optic communications cable. Install risers with heat shrink tubing so that cable can be installed without violating the minimum bending radius of the fiber optic cable. Install fiber-optic cable so it does not share a riser with any other cable type unless specifically called out in the Plans.

Install heat shrink tubing in accordance with manufacturer's recommendations. Provide tubing a minimum of 5 inches in length with a minimum of 2.5 inches extended over cables and 2.5 inches extended over risers after heat has been applied. Use nylon filler rods with UV protection or equivalent and sealing spacer clips to separate cables where multiple cables enter a riser. Ensure sealing spacer clips have a heat activated sealing compound with the sealing compound fully encapsulating the space between cables. Ensure heat shrink tubing provides a watertight fit around individual cables and outer walls of risers. Do not use cut sections of cable or any other devices in lieu of filler rods. Use aluminum tape around cables to prevent damage from sealing chemicals. Use a heat source that will provide even heat distribution around tubing. Ensure no damage occurs to any cables. Do not use a heat source with an open flame.

Remove existing weatherheads, sealing bushings, heat shrink tubing and riser caps and install heat shrink tubing kits or heat shrink tubing retrofit kits on existing risers according to the installation procedures above.

Transition from rigid galvanized steel risers to underground PVC conduits below ground using an approved rigid galvanized steel sweeping elbow with PVC female adapter, unless the Plans call for an above-ground transition. Apply Teflon thread tape to the threads of rigid galvanized steel sweeping elbow before screwing the PVC adapter onto the threaded end of the elbow. Connect the threaded female end of the PVC adapter to the threaded male end of the rigid galvanized steel sweeping elbow without the use of additional fittings, hardware or adhesives. Connect the opposite, non-threaded end of the adapter to the underground PVC conduit using a slip fit, glued connection.

Bond all new risers, a minimum of 10 feet above grade, to the pole ground using a #6 AWG minimum solid bare copper wire and an approved pipe clamp, a split-bolt connector or parallel groove clamp.

If a pole ground exists on a joint-use pole, bond new riser to the existing pole ground using #6 AWG minimum solid bare copper wire terminated with split-bolt connectors or parallel groove clamp.

If the existing pole does not have a grounding system, install new pole grounding system in accordance with the "Wood Poles" section of these Project Special Provisions.

#### **11.4. MEASUREMENT AND PAYMENT**

\_\_\_ " Riser with \_\_\_\_\_ will be measured and paid as the actual number of risers of each type and size furnished, installed, and accepted.

No measurement will be made of weatherheads, heat shrink tubing, temporary pipe caps, bushings, conduit outlet bodies such as condulets, elbows, conduit fittings, PVC female adapters, conduit nipples, conduit locknuts and sealing locknuts, pole attachment fittings, and zinc-rich touch-up paint as these will be considered incidental to furnishing and installing risers. No measurement will be made of temporarily removing from and subsequently reinstalling existing cables in a riser and cutting off and removing the above-ground portion of an existing PVC riser to replace it with a new rigid metal riser as such work will be considered incidental to installing the new riser.

No measurement will be made for horizontal sections of underground conduit that connect the riser to stub-outs in an adjacent cabinet foundation or to an adjacent junction box and that measure 10 feet or less in horizontal length from the center of the riser to the center of junction box or from the center of the riser to the center of the vertical sweep through the controller cabinet foundation. Such conduit will be considered incidental to furnishing and installing the riser assembly.

No measurement will be made for bonding new or existing risers to an existing pole grounding system. Bonding new risers will be considered incidental to furnishing and installing riser. Bonding existing risers will be incidental to installing fiber optic cable through the riser.

*Pole grounding system* will be measured and paid for in accordance with the "Wood Poles" section of these Project Special Provisions.

No measurement will be made of risers with weatherheads furnished and installed as part of new electrical services as they will be considered incidental to furnishing and installing new electrical services (see “Electrical Service” section of these Project Special Provisions).

*Heat shrink tubing kit* will be measured and paid for as the actual number of heat shrink tubing kits furnished, installed, and accepted.

No measurement will be made of removing existing weatherheads, sealing bushings, heat shrink tubing and riser caps from existing risers as such removals will be considered incidental to furnishing and installing heat shrink tubing retrofit kits.

Payment will be made under:

<b>Pay Item</b>	<b>Pay Unit</b>
1/2" Riser with Weatherhead	Each
1" Riser with Weatherhead	Each
2" Riser with Weatherhead	Each
2" Riser with Heat Shrink Tubing	Each
Heat Shrink Tubing Kit	Each

## 12. INDUCTIVE DETECTION LOOPS

### 12.1. DESCRIPTION

Furnish and install inductive detection loops with loop slot sealant, loop wire, conduit with fittings, and all necessary hardware.

### 12.2. MATERIALS

Furnish material, equipment, and hardware furnished under this section that is pre-approved on the ITS and Signals QPL.

#### A. Loop Sealant

Provide the Engineer with a Type 3 material certifications and material safety data sheets (MSDS) for the sealant in accordance with Article 106-3 of the *Standard Specifications*.

Provide loop slot sealant that completely encapsulates loop wire when installed according to manufacturer's instructions. Provide loop sealant that does not generate temperatures greater than 220° F. Ensure sealant bonds with asphalt and concrete pavement saw slots so sealant and encapsulated loop wire do not come out of slot. Ensure sealant is self-leveling, but with sufficient viscosity to prevent exit from saw slot when installed along a 10% grade.

Provide sealant that protects loop wire by preventing the entrance of dirt, water, rocks, sticks, and other debris into saw slot, and is resistant to traffic, water, gasoline, chemical and chemical fumes, mild alkalis, oils, and mild acids. Ensure sealant will not be affected by water and sealant does not chemically interact with pavement and loop wire insulation.

Ensure loop sealant has sufficient flexibility to permit expected pavement expansion and contraction due to weather and to permit pavement movement due to traffic without cracking for a temperature range of -40 to 160° F.

Provide sealant with a usable life of at least ten minutes once mixed, when the ambient temperature is 75° F. Ensure sealant dries to tack-free state in less than 2 hours, and does not flow within or out of saw slot after exposed surface has become tack free. Tack free time will be determined by testing with a cotton ball until no sealant adheres to cotton ball and no cotton adheres to sealant.

Ensure two-part sealant cures within 48 hours to attain 95% of published properties for the cured material.

Ensure one part sealant cures within 30 days to attain 95% of published properties for the cured material.

#### B. Loop Wire

Provide loop wire composed of 19-strand conductor insulated by a cross-linked polyethylene compound. Ensure insulated conductors are completely encased in tubes of low density polyethylene compound. Print manufacturer's name, manufacture year, and any applicable part number on encasing tube at intervals of 2 feet or less.

Provide #14 AWG copper conductors fabricated from 19 strands that comply with ASTM B3 before insulating. Ensure stranded conductors use either concentric or bunch stranding, and comply with circular mil area and physical requirements of ASTM B8 or ASTM B174 for bunch stranding.



Provide insulating compound that is cross-linked thermosetting black polyethylene in accordance with ASTM D 2655. Ensure insulation is applied concentrically about conductor. Provide insulation thickness not less than 0.026 inch at any point and minimum average thickness of 0.030 inch as measured by UL Standard 62.

Ensure insulation of finished conductor will withstand application of a 60 Hertz or 3,000 Hertz, 7,500 volt (RMS) essentially sinusoidal spark test potential as specified in UL Standard 83.

Provide insulated conductors that are factory-installed in protective encasing tube that complies with the following:

- Encasing tube fabricated of polyethylene compound conforming to ASTM D1248 for Type I, Class C, Grade E5.
- Minimum inside diameter of 0.150 inch
- Wall thickness of 0.040 inch  $\pm$  0.010 inch
- Outside diameter of 0.240 inch  $\pm$  0.010" inch

### **C. Conduit**

Comply with the "Underground Conduit" section of these Project Special Provisions for conduit.

#### **12.3. CONSTRUCTION METHODS**

All work performed in this section shall be done in the presence of the Engineer.

Notify Engineer one week before installing inductive detection loops.

Coordinate sawcutting and loop placement with pavement markings. For new construction or for resurfacing, install inductive detection loops before placing final layer of surface course. On unmarked pavement, pre-mark locations of stop lines and lane lines before locating inductive detection loops.

Before sawcutting, pre-mark inductive detection loop locations and receive approval. Sawcut pavement at approved pre-marked locations. Do not allow vehicles to travel over unsealed loop slots.

Install conduit with bushings from edge of pavement to junction box. Ensure conduit maintains a minimum of 30 inches of cover from edge of pavement structure to the junction box. Do not sawcut through curb. See additional requirements for work in historic districts in Section 1 of these Project Special Provisions.

Remove all loose material and wash saw slots with a high-pressure method using an air and water mixture. Dry saw slots with compressed air. Clear saw slots of jagged edges and protrusions. Seat loop conductor at bottom of saw slot without damaging loop wire.

Before sealing loop conductors, test that impedance from the loop wire to ground is at least 100 megohms. For each location with inductive loops, submit a completed Inductive Detection Loop & Grounding Test Results form and place copy in controller cabinet. Ensure all loops are included on form. The form is located on the Department's website at <https://connect.ncdot.gov/resources/safety/Pages/ITS-and-Signals.aspx>.

Embed loop conductors in saw slot with loop sealant. Seal saw slot and dispose of excess sealant in an environmentally safe manner.

Between where loop conductor pairs leave the saw cut in pavement and enter a junction box, twist loop conductor pairs a minimum of 5 turns per foot. Permanently label each twisted pair in the junction box with nylon cable tie using indelible ink. Indicate loop number and loop polarity on the tie.

**12.4. MEASUREMENT AND PAYMENT**

*Inductive loop sawcut* will be measured and paid as the actual linear feet of inductive loop sawcut furnished, installed, and accepted.

No measurement will be made of loop slot sealant, loop wire, conduit, and conduit fittings as these will be considered incidental to furnishing and installing inductive detection loops.

Payment will be made under:

**Pay Item**

**Pay Unit**

Inductive Loop Sawcut

Linear Foot

### 13. LEAD-IN CABLE

#### 13.1. DESCRIPTION

Furnish and install lead-in cable with all necessary hardware to be used in conjunction with, but not limited to, inductive detection loops, pedestrian pushbutton assemblies, APS assemblies or railroad circuitry.

#### 13.2. MATERIALS

Furnish material, equipment, and hardware furnished under this section that is pre-approved on the ITS and Signals QPL.

Furnish lead-in cable with two conductors of #14 AWG fabricated from stranded tinned copper that complies with IMSA Specification 50-2 except as follows:

- Ensure conductor is twisted with a maximum lay of 2.0 inches, resulting in a minimum of six turns per foot.
- Provide a ripcord to allow cable jacket to be opened without using a cutter.

Provide length markings in a contrasting color showing sequential feet and within 1% of actual cable length. Ensure character height of the markings is approximately 0.10 inch.

Refer to the "Pole Line Hardware" subsection of the "Messenger Cable" section of these Project Special Provisions.

#### 13.3. CONSTRUCTION METHODS

For underground runs, install lead-in cable in 2-inch non-metallic conduit. For aerial installation, wrap lead-in cable to messenger cable with at least four turns of wrapping tape spaced at intervals less than 15 inches or lash lead-in cable to messenger cable with one 360° spiral of lashing wire per 12 inches.

Where railroad preemption is required, install lead-in cable from signal controller cabinet to railroad company furnished and installed lockable junction box.

Except where the extension of lead-in cables is required inside a new cabinet to connect existing lead-in cable to appropriate terminal blocks, splicing of lead-in cable will be allowed only for runs in excess of 750 feet. Splice lead-in cable in junction boxes, in condulets on poles, or controller cabinets.

Test each complete loop system from the controller cabinet by using a megger to verify that impedance from the loop system to the ground is at least 50 megohms. After successful completion of megger test, test loop system resistance using an electronic ohmmeter to verify loop system resistance is less than 0.00885 ohms per foot.

Where the Plans call for using existing upstream detection loops on an approach to a signalized intersection for both local intersection and system detection (i.e., shared local/system loops), field verify that each such loop is wired to a separate lead-in cable all the way back to the controller cabinet. If proposed shared loops are wired to a common lead-in cable, install new lead-in cables necessary to rewire each loop to a separate lead-in cable. Notify the Engineer of findings from field investigations and obtain Engineer's approval prior to installing any new lead-in cables and rewiring proposed share local/system loops.

**13.4. MEASUREMENT AND PAYMENT**

*Lead-in cable* (\_\_\_\_) will be measured and paid as the actual linear feet of lead-in cable furnished, installed, and accepted, except for extensions of lead-in cable inside new controller cabinets. Measurement will be made by calculating the difference in length markings located on outer jacket from start of run to end of run for each run. Terminate all cables before determining length of cable run. Short extension of lead-in cable inside new controller cabinets will be considered incidental to installation of the new cabinet.

If markings are not visible, measurement will be point to point with no allowance for sag. Twenty-five feet will be allowed for vertical segments up or down poles.

Payment will be made under:

<b>Pay Item</b>	<b>Pay Unit</b>
Lead-in Cable (14-2)	Linear Foot

## 14. FIBER-OPTIC CABLE

### 14.1. DESCRIPTION

Furnish and install single mode fiber-optic (SMFO) communications cable and drop cable assemblies, fiber-optic cable storage guides (snow shoes), communications cable identification markers, junction box markers, lashing wire, and all necessary hardware.

### 14.2. MATERIALS

#### A. General

Refer to the "Pole Line Hardware" subsection of the "Messenger Cable" section of these Project Special Provisions for lashing wire, wrapping tape and hardware used for installation of aerial fiber-optic cable.

#### B. SMFO Communications Cable

Furnish single-mode fiber-optic communications cable that is pre-approved on the Department's QPL. Furnish fiber-optic cable that is all-dielectric.

Furnish single-mode fiber-optic cable manufactured into a loose buffer tube design installed around a central strength member where the cable complies with RUS CFR 1755.900 and ICEA 640 requirements. Ensure the manufacturer is ISO 9001 and TL9000 registered and that the manufacturer's cable is RUS listed. The operating temperature range of the cable shall be -40°F to +158°F.

Furnish individual fibers manufactured from silica and dopant materials with each fiber having a color coated finish that is compatible with local injection detection (LID) devices. Distinguish each fiber from others by color coding that meets EIA/TIA-598. Furnish single mode fiber that does not exceed attenuation ratings of 0.25 dB/km at 1550 nm and 0.35 dB/km at 1310 nm and complies with ITU G.652D and IEC 60793-2-50 Type B.1.3 industry standards for low water peak, single mode fiber. Provide fibers that are useable and with a surface, sufficiently free of imperfections and inclusions to meet optical, mechanical and environmental requirements.

Ensure the core central strength member is a dielectric glass reinforced rod and that the completed cable assembly has a maximum pulling rating of 600 lbf during installation (short term) and 180 lbf long term installed.

Construct buffer tubes (nominal size of 2.5 mm) manufactured from a polypropylene copolymer material to provide good kink resistance and allows the buffer tube to maintain flexibility in cold temperature over the expected lifetime of the cable. Ensure that buffer tubes contain no more than 12 fiber per buffer tube unless specified otherwise, and that all buffer tubes are filled with water blocking gel or water swellable material. Construct the cable such that the buffer tubes are stranded around the central strength member in a reverse oscillating arrangement to allow for mid-span entry. Distinguish each buffer tube from others by color coding that meets EIA/TIA-598. Use filler tubes to maintain a circular cross-section of the cable. Ensure the filler tubes are the same nominal size as the buffer tubes of 2.5 mm. Apply binders (water swellable yarn, kevlar, etc.) with sufficient tension to secure buffer tubes and filler tubes to the central member without crushing the buffer tubes. Ensure that binding material is non-hygroscopic, non-wicking and dielectric with low shrinkage. Ensure the binders are of a high tensile strength that is helically stranded evenly around cable core.

Ensure the cable core is protected from the ingress of moisture by a water swellable material or that is filled with a water blocking compound that is non-conductive. Ensure the water swellable material (when activated) or the water blocking compound is free from dirt and foreign matter and is removable with conventional nontoxic solvents. Furnish at least one ripcord to aid in the process of removing the outer jacket. Furnish the outer jacket constructed of a medium-density polyethylene material to provide reduced friction and enhanced durability. Ensure the polyethylene material contains carbon black to provide UV protection and does not promote the growth of fungus. Ensure the cable jacket is free of slits, holes or blisters and the nominal outer jacket thickness is  $\geq 0.050$ ".

Ensure the completed cable assembly contains identifications markings printed along the outside cover of the jacket every 2 feet. Ensure the character height of the markings is approximately 0.10 inch. Provide length markings in sequential feet and within one percent of actual cable length.

Mark each cable with the following:

- (1) Sequential length marks in feet as specified
- (2) The name of the manufacturer
- (3) "OPTICAL CABLE"
- (4) Month/year of manufacture
- (5) Number(s) of and type(s) of fibers
- (6) Cable ID Number for product traceability

### **C. Drop Cable**

Provide drop cable meeting the material requirements list in "SMFO Communications Cable" subsection above with the exceptions herein to provide communications links between splice enclosures and the Ethernet edge switches through interconnect centers mounted in controller cabinets. Furnish drop cables containing a minimum of twelve individual fibers. Ensure drop cable has the same operating characteristics as the SMFO cable it is to be coupled with.

On one end of the cable, furnish LC connectors for termination of all drop cable fibers on connector panel mounted inside a signal cabinet. Field install pigtailed and connectors. For field installed connectors, provide cabinet-mounted interconnect centers that are pre-equipped with factory-preassembled connector panels, SMFO pigtailed with LC connectors and splice trays; then fusion splice all drop cable fibers to the SMFO pigtailed.

No connectors are required for drop cables running from one splice enclosure directly to another splice enclosure.

Ensure attenuation loss for complete drop cable does not exceed a mean value of 1.5 dB.

### **D. Communications Cable Identification Markers**

Furnish yellow communications cable identification markers that are resistant to fading when exposed to UV sources and changes in weather. Use markers designed to coil around fiber-optic cable that do not slide or move along the surface of the cable once installed. Ensure exposure to UV light and weather does not affect the markers natural coiling effect or deteriorate

performance. Provide communications cable wraps that permit writing with an indelible marking pen.

Furnish cable identification markers with the following text for signal system communications cables:

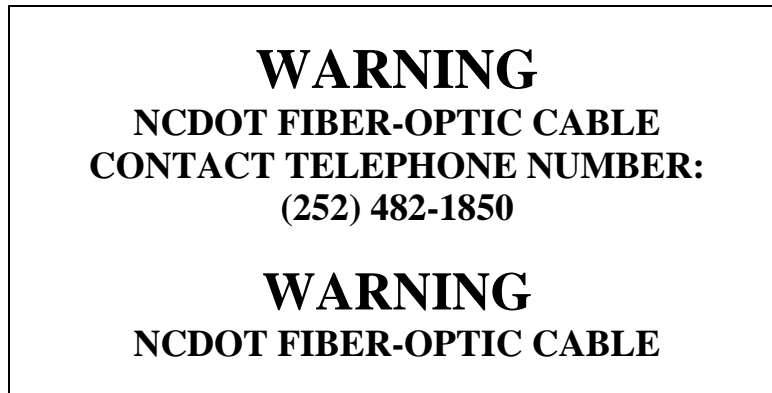

*Overall Marker Dimensions: 7(l) x 4 (w) inches*

*Lettering Height: 3/8 inch for "WARNING"; 1/4 inch for all other lettering*

*Colors: Black text on yellow background*

Submit a sample of proposed communications cable identification marker to the Engineer for approval before installation.

#### **E. Fiber-Optic Cable Storage Guides**

Furnish fiber-optic cable storage guides (snowshoes) that are pre-approved on the ITS and Signals QPL.

Furnish fiber-optic storage guides (snowshoes) that are non-conductive and resistant to fading when exposed to UV sources and changes in weather. Ensure snowshoes have a captive design such that fiber-optic cable will be supported when installed in the rack and the minimum bending radius will not be violated. Provide stainless steel attachment hardware for securing snowshoes to messenger cable and black UV resistant tie-wraps for securing fiber-optic cable to snowshoe. Ensure snowshoes are stackable so that multiple cable configurations are possible.

#### **F. Aerial Cable Protectors**

Furnish aerial cable protectors designed to protect aerial fiber-optic communications cable from damage caused by tree limb abrasion. Provide cable protectors that are designed to fit over the cable as a wrap-around protective sleeve, that have a round shape and are fabricated with cable tie slots spaced approximately 12 inches apart along the entire length. Size the cable protectors to fit properly over cable(s) lashed to messenger cable in accordance with the manufacturer's guidelines. Provide cable protectors that are constructed of rugged, durable dielectric material such as high density PVC that is black in color, formulated for outdoor use and has special additives to prevent degradation from ultraviolet light. Provide aerial cable protectors that are designed for a service life of at least 10 years.

### 14.3. CONSTRUCTION METHODS

#### A. General

Provide cable manufacturer's attenuation and Optical Time Domain Reflectometer (OTDR) testing data for each reel of cable upon request.

Install SMFO communications cable, snow shoes, communications cable identification markers, lashing wire, and all necessary hardware.

Comply with manufacturer's recommendations. Install communications cable on signal poles, utility poles, messenger cable, and in conduits as required to bring the fiber-optic cable into and, if necessary, out of each splice enclosure.

Take all precautions necessary to ensure cable is not damaged during storage, handling, and installation. Do not violate minimum bending radius of 20 times the cable diameter or manufacturer's recommendation, whichever is greater. Do not step on cable nor run over cable with vehicles or equipment. Do not pull cable over or around obstructions, or along the ground.

Determine lengths of cable necessary to reach from termination-point to termination-point. Install cable in continuous lengths between approved splicing facilities. Additionally, provide a sufficient amount of slack cable to allow for an additional 30 feet of cable to be present after removal of outer sheath for termination. Store the 30 feet of spare cable inside the cabinet. Measure slack cable by extending cable straight out of cabinet door. No splicing is permitted at any field cabinets other than splicing drop cable fibers to SMFO pigtailed in cabinet-mounted interconnect centers inside traffic signal controller cabinets.

Keep cable ends sealed at all times during installation to prevent effectively the ingress of moisture. Use approved heat shrink cable end cap. Do not use tape to seal cable ends.

Before installing cable, provide three copies of cable manufacturer's recommended and maximum pulling tension. Do not exceed manufacturer's recommended pulling tension. Use pulling grips containing a breakaway rotating swivel. Coil cable in a figure-8 configuration whenever cable is unreeled for subsequent pulling.

Install fiber-optic cable in separate 2 inch risers with heat shrink tubing or conduits. Do not share risers or conduits containing fiber-optic cable with other non-fiber-optic cable unless the Plans specify otherwise or the Engineer directs or approves otherwise.

Seal all conduits containing fiber-optic communications cable in junction boxes and cabinet bases with duct and conduit sealer. Comply with the requirements for duct and conduit sealer in the "Underground Conduit" section of these Project Special Provisions.

#### B. Aerial Installation

Install one communications cable identification marker on the signal system communications cable within 36 inches of the attachment point on each pole and at locations where more than one cable originates or terminates. At splice enclosures, install a communications cable marker on one of the cables where it enters or exits the splice enclosure and ensure that the marker is installed so that it visible (but not necessarily readable) from the ground below. At fiber-optic cable storage guides (i.e., snow shoes), install a communications cable marker at each end, 6 inches or less from the inner edge of each snow shoe, to identify the cable being stored.

Double lash fiber-optic cable to messenger cable with one 360° spiral per foot.



Machine lashing of any cable is not permitted along any messenger cable span to which a traffic signal or overhead sign is or will be attached. Either reuse existing 0.05" x 0.30" aluminum wrapping tape or furnish and install new aluminum wrapping tape.

Use pole attachment hardware and roller guides with safety clips to install aerial run cable.

Maintain tension during the pulling process for aerial run cable by using an approved mechanical clutch (dynamometer) device with breakaway swivel so as not to exceed 80% of the maximum allowable pulling tension specified by the cable's manufacturer if cable is pulled by mechanical means. Do not allow cable to contact the ground or other obstructions between poles during installation.

Use a cable suspension clamp when attaching cable tangent to a pole. Select and place cable blocks and corner blocks so as not to exceed the cable's minimum bending radius. Do not pull cable across J-hooks.

Store 100 feet of each fiber-optic cable on all cable runs that are continuous without splices as shown in the Plans. Obtain approval for spare cable storage locations. Store spare fiber-optic cable on fiber-optic cable storage guides (snow shoes) that are separate from any storage guides being used to store any other communications cable. Locate spare cable storage in the middle of spans between termination points. Do not store spare fiber-optic cable over the roadway or driveways.

### **C. Underground Installation**

Install fiber-optic cable underground in conduit using cable pulling lubricants recommended by the fiber-optic cable manufacturer. Where more than one fiber-optic cable is being installed in a multiple conduit underground run, ensure that at least one conduit remains empty for future use by installing more than one cable in a conduit as needed, unless directed otherwise by the Engineer.

Obtain approval of cable pulling lubricant and method of pulling before installing underground fiber-optic cable.

Maintain tension during the pulling process by using an approved mechanical clutch (dynamometer) device with breakaway swivel so as not to exceed 80% of the maximum allowable pulling tension specified by the cable's manufacturer if cable is pulled by mechanical means. Do not use a motorized vehicle to generate pulling forces.

Keep tension on cable reel and pulling line at start of each pull. Do not release tension if pulling operation is halted. Restart pulling operation by gradually increasing tension until cable is in motion.

For pulling cable through junction boxes, feed cable by manually rotating the reel. Do not pull cable through intermediate junction boxes, handholds, or openings in conduit unless otherwise approved.

Inside all junction boxes, install communications cable identification markers on each communications cable entering the junction box.

In a junction box where no splice enclosure is required, store 30 feet of each fiber-optic cable on all cable runs as shown in the Plans.

**In a junction box where a splice enclosure is required but not immediately installed, store sufficient cable to have 50' of each fiber-optic cable intended to enter the splice enclosure as shown in the Plans.**

If a blockage is encountered when attempting to install a communications cable inside an existing conduit in accordance with the Plans, use compressed air, water jetting, rod and mandrel or other Engineer-approved method to clear the obstruction or blockage in the existing underground conduit. Once obstruction/blockage has been substantially cleared, draw a mandrel through the conduit followed by a swab to clean out any remaining materials which may cause cable abrasions. Use a mandrel constructed of aluminum or stainless steel that is at least 6 inches in length and has an outer diameter that is approximately 1/2 inch less than the inside diameter of the conduit being cleared.

Subject to the Engineer's approval, the existing communications cable being removed may be used as a pull line to install the new fiber-optic communications cable and accompanying tracer wire in its place in existing underground conduits.

**D. Indoor Installation**

Install the fiber-optic cable in Electric Metal Tubing (EMT) risers and conduits between the building entrance and the termination point inside the building using cable pulling lubricants recommended by the fiber-optic cable manufacturer. Obtain approval of cable pulling lubricant and method of pulling before installing the fiber-optic cable.

Use a breakaway swivel so as not to exceed 80% of the maximum allowable pulling tension specified by the cable's manufacturer if cable is pulled by mechanical means. Keep tension on cable reel and pulling line at start of each pull. Do not release tension if pulling operation is halted. Restart pulling operation by gradually increasing tension until cable is in motion.

For pulling cable through junction boxes and cabinets, feed cable by manually rotating the reel. Do not pull cable through cabinets, junction boxes, handholds, or openings in conduit unless otherwise approved. Inside all junction boxes and cabinets, install communications cable identification markers on each communications cable entering the junction box.

Store 30 feet of each fiber-optic cable inside the enclosed communications racks inside the TMC after terminating the cables in the rack-mounted splice centers housed therein.

**E. Installation of Drop Cable**

Verify the length of drop cable needed, including slack, to reach from termination point to termination point.

At aerial splice enclosures, install the aerial splice enclosure and corresponding cable storage guide 50 feet apart and store between the splice enclosure and corresponding cable storage guide 50 feet of slack cable for each cable entering and exiting the splice enclosure.

At below ground splice enclosures, coil 50 feet of slack cable for each cable entering and exiting the splice enclosure in the junction box where enclosure is located. Coil and store any drop cable in excess of what is needed for storage in the manhole or junction box in the base of the signal cabinet. Where fiber-optic cables are installed but not immediately spliced, store 50 feet of drop cable and 100 feet of fiber-optic trunk cable (50' for each cable entering and exiting the splice enclosure) inside the manhole or junction box to facilitate subsequent splicing in the

splice enclosure. Cap and seal ends of cables that have yet to be spliced or terminated with a waterproof heat-shrink cap/seal as approved by the Engineer.

At the signal cabinet end of drop cable, terminate fibers as shown on the Splice Plans by fusion splicing them to factory-assembled SMFO pigtailed with LC connectors and connecting the pigtailed to the connector panel in the rack-mounted interconnect center. Label all connectors, pigtailed and the connector panel. At the aerial or underground splice location, cap off all unused fibers and label to correspond with the connector panel. After termination, coil and store in the base of the signal cabinet 30 feet of drop cable plus any additional drop cable in excess of what is needed for overhead or underground storage.

Where the Plans call for a fiber-optic drop cable to be installed in an existing riser, remove all existing cables from the riser and remove the existing weatherhead, sealing bushing or heat shrink tubing. Install the new fiber-optic drop cable in the existing riser and install new heat shrink tubing at the top of the existing riser using a heat shrink tubing retrofit kit. If the riser contains existing fiber-optic communications cable, carefully remove the fiber-optic cable from the riser so as not to violate its minimum bending radius or otherwise damage the cable. Temporarily coil and store the existing fiber-optic cable overhead in a manner approved by the Engineer until the new drop cable can be spliced into the existing cable in an aerial splice enclosure. Once splicing has been completed, furnish and install fiber-optic cable storage guides and permanently store all remaining spare cable.

Using an OTDR, test the end-to-end connectivity of the drop cable from patch panel installed inside the signal or CCTV cabinet to the adjacent managed Ethernet switches. Comply with the OTDR testing and reporting requirements of the "Fiber-Optic Splice Centers" section of these Project Special Provisions when testing drop cable.

#### **F. Aerial Cable Protector**

Where shown in Plans and as directed by the Engineer, at locations where aerial fiber-optic communications cables are subject to damage by tree limb abrasion, install cable protectors over the fiber-optic cable that are of sufficient length to protect the cable from the potential threat as directed by the Engineer. Do not install aerial cable protectors at any locations without the prior approval of the Engineer. Do not install cable protectors for lengths of application that are shorter or longer than approved/directed by the Engineer.

#### **14.4. MEASUREMENT AND PAYMENT**

*Communications cable* (\_\_\_\_-fiber) will be measured and paid as the actual linear feet of fiber-optic cable of each fiber count furnished, installed, and accepted according to the following conditions: 70% of the payment will be made upon acceptance of the installed cable and the remaining 30% of the payment will be made following splicing, testing and final acceptance (including completion of the 60-day Observation Period). Measurement will be made by calculating the difference in length markings located on outer jacket from start of run to end of run for each run. Terminate all fibers before determining length of cable run.

*Drop cable* will be measured and paid as the actual linear feet of fiber-optic drop cable furnished, installed, and accepted. Measurement will be made by calculating the difference in length markings located on outer jacket from start of run to end of run for each run. Terminate fibers before determining length of cable run.

*Aerial cable protector* will be measured and paid as the actual linear feet of aerial cable protector furnished, installed, and accepted. No measurement and payment will be made of any aerial cable protector installed without the prior approval of the Engineer or for cable protector installed at locations or for lengths of application other than approved or directed by the Engineer.

No measurement will be made for terminating, splicing, and testing fiber-optic cable, communications cable identification markers, fiber-optic cable storage guides, lashing wire, SMFO jumpers and pigtails, and conduit seals/sealing putty, as these will be considered incidental to the installation of fiber-optic cable and drop cables.

No measurement will be made of removing existing cables from existing risers as such removals will be considered incidental to furnishing and installing the fiber-optic cables and drop cables.

When replacing fiber-optic cable or drop cables, no measurement will be made of removing cables from existing conduits as such removals will be considered incidental to furnishing and installing the fiber-optic cables and drop cables.

No measurement will be made of clearing a blockage or obstruction from an existing conduit necessary to install a communications cable in an existing underground conduit as such work will be considered incidental to installation of the communications cable.

No measurement will be for installing a pull tape inside of and sealing the ends of an existing conduit that will be retained for future use after removing an existing communications cable from that conduit as such work will be considered incidental to installation of new fiber-optic communications cable.

No measurement will be made of removing existing weatherheads, sealing bushings, heat shrink tubing and riser caps to install new fiber-optic drop cables in existing risers as such removals will be considered incidental to furnishing and installing heat shrink tubing retrofit kits. Heat shrink tubing retrofit kits will be measured and paid for in accordance with the "Riser Assemblies" section of these Project Special Provisions.

Payment will be made under:

<b>Pay Item</b>	<b>Pay Unit</b>
Communications Cable (12-Fiber)	Linear Foot
Communications Cable (48-Fiber)	Linear Foot
Drop Cable	Linear Foot
Aerial Cable Protector	Linear Foot

## 15. FIBER-OPTIC SPLICE CENTERS

### 15.1. DESCRIPTION

Furnish and install fiber-optic interconnect centers, fiber-optic splice enclosures, and all necessary hardware.

### 15.2. MATERIALS

Furnish material, equipment, and hardware furnished under this section that is pre-approved on the ITS and Signals QPL.

#### A. Interconnect Center

Furnish compact, modular interconnect centers designed to mount inside signal cabinets. Design and size interconnect centers to accommodate all fibers entering cabinets. Provide interconnect centers for controller cabinets that are one rack unit (RU) high.

Provide splice trays that hold, protect, organize optical fibers, and secure fibers inside splice tray. Design and size the splice trays to be dielectric, to accommodate all fibers entering splice tray, and to provide sufficient space to prevent microbending of optical fibers. Provide connector panels with LC-type connectors.

Furnish SMFO pigtails with each interconnect center. Provide pigtails that are a maximum of 6 feet in length with factory-assembled LC connectors on one end. Ensure SMFO pigtails meet the operating characteristics of the SMFO cable with which it is to be coupled.

For connecting Ethernet edge switches to the interconnect center patch panels, furnish SMFO jumpers that are a minimum of 3 feet in length with factory-assembled LC connectors on one end (i.e., the interconnect center end) and, on the other end, factory-assembled connectors of the same type provided on the Ethernet edge switch. Ensure SMFO jumpers meet the operating characteristics of the SMFO cable with which it is to be coupled.

#### B. Splice Enclosure

Furnish splice enclosures that are re-enterable using a mechanical dome-to-base seal with a flash test valve, and are impervious to the entry of foreign material (water, dust, etc.). Ensure enclosures are manufactured in such a manner to be suitable for aerial, pedestal, buried, junction box, and manhole installation.

Provide enclosures with a minimum of one oversized oval port that will accept two cables and with a minimum of four round ports (for single cables) that will accommodate all cables entering enclosure. Ensure the splice enclosures are provided with correct number of ports for the splices in these Plans. Provide heat shrink cable shields with enclosure to ensure weather-tight seal where each cable enters enclosure.

Within enclosures, provide enough hinged mountable splice trays to store the number of splices required, plus the capacity to house six additional splices. Provide a fiber containment basket for storage of loose buffer tubes expressed (i.e., uncut and unspliced) through the enclosure. Ensure enclosures allow sufficient space to prevent microbending of buffer tubes when coiled.

Provide splice trays that hold, protect, organize optical fibers, and secure fibers inside splice tray. Provide splice trays that are dielectric.

### 15.3. CONSTRUCTION METHODS

#### A. General (Workmanship Identification Information)

Include on the cover of each splice tray in a legible format the following workmanship identification information:

- Splice location reference # or identification information (e.g., 01-xxxx tray 1 of 3, 01-xxxx tray 2 of 3, etc.);
- Date the splice was made;
- Company name of individual performing the splicing;
- Name of individual performing the splicing.

#### B. Workmanship

Upon cutting the cable and removing the outer jacketing material down to the individual buffer tubes, secure the central strength member to the enclosure so that no tensile force is applied to the fibers. Secure the individual buffer tubes to the splice trays by a method recommended by the manufacturer. Determine the length of each buffer tube needed to ensure that the buffer tube can be looped a minimum of two times around the inside of the splice tray. Upon determining the length of buffer tube needed, remove the buffer tube to expose the individual fibers for fusion splicing. Adjust individual fiber lengths as necessary to ensure that once the fusion splicing process is completed the finished splices will align with the “splice block organizer” supplied within the splice tray. Ensure the splice block organizer has individual fusion splice space holders for each fiber splice.

While prepping the individual fibers for splicing, install the heat shrink protective tube over the fiber and then perform the splicing operations, following the manufacturer’s instructions. Verify that the newly formed splice does not exceed 0.05 dB of attenuation. If the attenuation is more than 0.05 dB, then remake the splice until it meets the 0.05 dB or less requirement. Finish the splicing operation by sliding the heat shrink tube over the splice and applying heat to activate the heat shrink tubing. Secure the finished splice in the splice block organizer. Ensure each splice is properly secured in a space holder in the splice block organizer. Multiple splices secured to the same space holder are unacceptable.

Ensure all buffer tubes are contained within splice trays so that no bare fibers are outside of the tray. Do not damage the fibers or violate the minimum bend radius of the fiber.

Prior to installing the cover over the splice tray and placing it in its final resting location, take a MANDATORY digital photograph of the splice tray that shows the final workmanship. Ensure that the photograph shows the “Workmanship Identification Information” as well as the workmanship associated with installing and terminating the fiber. Ensure that the photograph is clear, in-focus and information captured is legible. Include digital copies of each photograph on a compact disc as part of the OTDR Test Results submittal.

#### C. Termination and Splicing within Interconnect Centers

Terminate and fusion splice all fibers as shown in the Plans.

Label all fiber-optic connectors, whether on jumpers, connector panels, or other equipment, to prevent improper connection. Obtain approval of fiber-optic connector labeling method.

For all fibers designated for termination to a connector panel within an interconnect center, fusion splice the fibers to pigtails.

For all fibers designated to pass through interconnect center, neatly coil and express the fibers without cutting. For all buffer tubes designated to pass through interconnect center, neatly coil excess tubing inside interconnect center.

#### **D. Interconnect Centers in Controller Cabinets**

Install interconnect centers with connector panels, splice trays, storage for slack cable or fibers, mounting and strain relief hardware, and all necessary hardware. Mount the interconnect center in the rack inside the controller cabinet at the location indicated in the Plans. Install SMFO jumpers between the appropriate connectors on the interconnect center and the Ethernet edge switch.

#### **E. Termination and Splicing within Splice Enclosure**

Install splice enclosures with splice trays, basket containment assemblies, racking for slack cable or fibers, mounting and strain relief hardware, and all other necessary hardware.

Do not install aerial splice enclosures and storage guides over roadways or driveways.

Fusion splice all fibers including fibers designated to be coupled with fibers from a drop cable assembly. For all fibers designated to pass through splice enclosure, coil and express the fibers without cutting.

For all buffer tubes designated to pass through splice enclosure, neatly coil excess tubing inside basket provided with enclosure.

Label all fiber-optic splices. Obtain approval of fiber-optic connector labeling method.

Install heat shrink cable shields using methods recommended by the manufacturer of the enclosure. Perform a pressurization flash test on enclosure in accordance with manufacturer's recommended procedures at the conclusion of splicing procedure and before final placement of enclosure.

For aerial installations, secure enclosures to messenger cable using manufacturer supplied hardware. Secure SMFO cable and drop cables to snowshoes.

Install enclosures with enough slack cable to allow enclosure to be lowered to ground level and extended into a splicing vehicle.

For underground, manhole and junction box facility installations, place the enclosure along with required spare cables in the facility in a neat and workmanship like manner. Install underground splice enclosures only in special-sized junction boxes unless the Plans indicate otherwise or the Engineer approves otherwise.

#### **F. Testing**

Provide written notification to the Engineer a minimum of 10 working days before beginning the OTDR tests.

After splicing is completed, perform bi-directional OTDR tests on each fiber, including unused fibers. Install a 1,000-foot pre-tested launch cable between the OTDR and fiber-optic cable to be tested and a 1,000-foot pre-tested destination cable on the end of the fiber-optic cable to be tested. Ensure each launch cable has been tested and is compatible with the fiber-optic

cable being installed. Provide the Engineer with test results of the launch cable before use. Retest or replace launch cable at the Engineer's request.

Ensure fusion splice losses do not exceed 0.05 dB and connectors have a loss of 0.5 dB or less. If any fiber exceeds maximum allowable attenuation or if fiber-optic properties of the cable have been impaired, take appropriate actions up to and including replacement of the fiber-optic cable. Corrective action will be at no additional cost to the Department.

Clearly label each OTDR trace identifying a starting and ending point for all fibers being tested. Record the attenuation level of each fiber and clearly indicate OTDR trace results in report format. Furnish two hard copies of each of the OTDR trace results and electronic copies of all trace results along with digital photographs showing workmanship for each splice on a compact disc. Furnish the manufacturer's make, model number and software version of the OTDR used for testing.

Furnish to the Engineer two copies of the software needed to view the OTDR traces electronically.

#### **15.4. MEASUREMENT AND PAYMENT**

*Interconnect center* will be measured and paid as the actual number of fiber-optic interconnect centers furnished, installed, and accepted.

*Splice enclosure* will be measured and paid as the actual number of fiber-optic splice enclosures that are furnished, installed, and accepted, regardless of installation location (i.e., aerial, underground, manhole, or junction box).

No measurement will be made of fusion splices, splice trays, splice protectors, pigtails, jumpers, connector panels, labeling, photographs, testing and corrective actions, repairs and replacements needed due to exceeding the maximum allowable attenuation or other defects, as these will be considered incidental to furnishing and installing fiber-optic interconnect centers and splice enclosures.

No measurement will be made for disconnect fiber-optic drop cables from existing interconnect centers and temporarily storing the existing cable in existing signal cabinets, removal of existing splice centers, including existing interconnect centers and splice enclosures, as such work will be considered incidental to furnishing and installing fiber-optic interconnect centers and splice enclosures.

Payment will be made under:

<b>Pay Item</b>	<b>Pay Unit</b>
Interconnect Center	Each
Splice Enclosure	Each



16. DELINEATOR MARKERS

16.1. DESCRIPTION

Furnish and install delineator markers (tubular marker posts) with all necessary hardware and adhesives to warn of buried fiber-optic communications cable.

16.2. MATERIALS

A. Delineator Markers

Furnish material, equipment, and hardware under this section that is pre-approved on the ITS and Signals QPL.

Furnish tubular delineator markers, that are approximately 6 feet long and constructed of Type III, high-density polyethylene (HDPE) material. Provide delineator assemblies that are ultraviolet stabilized to help prevent components from color fading, warping, absorbing water, and deterioration with prolonged exposure to the elements. Provide delineators designed to self-erect after being knocked down or pushed over. Provide orange delineator posts.

Provide text, including Department contact number, hot stamped in black on a yellow reflective background material that will not fade or deteriorate over time. Provide delineator markers with nominal message height of 15 inches that contain the following text visible from all directions approaching the assembly:

<b>W A R N I N G</b>	<b>F I B E R  O P T I C  C A B L E S</b>
BEFORE EXCAVATING OR IN AN EMERGENCY CALL (252) 482-1850	
NORTH CAROLINA DEPARTMENT OF TRANSPORTATION	

**16.3. CONSTRUCTION METHODS**

**A. Delineator Markers in Historic Districts**

Obtain the Engineer’s approval prior to installing any delineator markers within historic districts. The Engineer may modify the application criteria described herein or delete the requirement for some or all cable markers based upon the requirements of the particular historic district.

**B. Delineator Markers**

Submit sample of proposed delineator markers for approval before installation.

Install delineator markers using a method that firmly and securely anchors delineator marker in the ground to prohibit twisting and easy removal.

Install delineator markers at locations specified on the plans. Do not install delineator markers at locations other than those specified in the Plans without the prior approval of the Engineer.

**16.4. MEASUREMENT AND PAYMENT**

*Delineator marker* will be measured and paid for as the actual number of delineator markers (tubular marker posts) furnished, installed, and accepted.

Payment will be made under:

<b>Pay Item</b>	<b>Pay Unit</b>
Delineator Marker	Each

## 17. JUNCTION BOX MARKERS

### 17.1. DESCRIPTION

Furnish and install junction box markers with all necessary hardware and adhesives to warn of buried fiber-optic communications cable.

### 17.2. MATERIALS

#### A. Junction Box Markers

Furnish durable, non-reflective junction box markers, also known as curb markers, fabricated from UV-resistant, non-metallic materials other than ceramic material, such as polyurethane or high impact polypropylene or other high impact plastic. Provide junction box markers that are designed for outdoor use, that are waterproof, that resist fading, that are temperature stable and that resist chemical and mechanical abrasion. Furnish junction box markers with a quick-setting adhesive designed for use with the junction box markers supplied and designed to permanently adhere junction box markers to Portland cement/concrete, steel, and cast iron as well as other non-porous hard surfaces. Do not provide markers that require intrusive fasteners to secure the marker to the surface. Do not provide adhesives that are not designed for use with the junction markers supplied. Provide junction box markers that do not require special tools such as torches, tamping machines or drills or hardware or special surface preparation for installation. Furnish junction box markers from a manufacturer that has been producing such junction box markers (i.e., curb markers) for a minimum of 10 consecutive years.

Order the junction box marker with the Division's Phone Number printed on the marker, hand written sharpie labeling is not acceptable. Consult with the Engineer to ensure the junction box labels are ordered with the correct Division phone number. Provide junction box markers that contain the text and symbols, text emphasis and text proportions depicted in the example format shown below.:

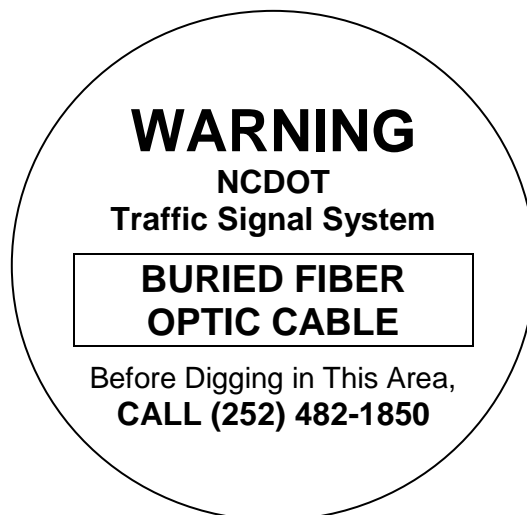

Overall Junction Box Marker Dimensions: 2.5" diameter

Text: Black

Background: Light Gray (to blend with concrete and granite surfaces)

Submit samples of proposed junction marker to the Engineer for approval before installation. In lieu of designing a custom junction box marker, the Contractor may submit for the Engineer’s approval a stock/standard junction box marker format (i.e., off-the-shelf format) from the junction box marker manufacturer that differs from the example format proposed above but that still embodies the content and intent conveyed by the example format.

Have the junction box marker manufacturer provide a list of references along with contract information for at least five different municipal government agencies and/or state departments of transportation that have installed the proposed manufacturer’s markers and can attest to the performance of the manufacturer’s markers over a continuous period of no less than seven years. Submit these references to the Engineer for review in conjunction with submission of the sample.

**17.3. CONSTRUCTION METHODS**

**A. Junction Box Markers**

Apply junction box markers to the surface of the junction box cover/lid on all new and/or existing junction boxes that are to be reused to house the fiber-optic communications cable. Additionally, at locations where a junction box is perpendicular to a raised curb place an additional junction box marker on the curb.

Clean surface to which the junction box marker will be applied. Make sure application surface is dry and free of any loose debris or cracks. Apply adhesive to back side of the junction box marker in accordance with manufacturer’s instructions. Apply additional adhesive when surface is uneven or textured to fill voids and assure secure adhesion. Apply the junction box marker to the application surface and press firmly. Ensure that entire edge around perimeter of marker is sealed to the application surface.

Position the marker in the approximate center of the junction box cover and orient the marker so that its text is parallel to long side of the cover. On curb sections install the marker on the flattest surface of the curb at a point that is is perpendicular to the junction box.

Junction box markers are not required to be placed on flat surfaces of the roadway where there is no curbing, unless required by the Engineer.

**17.4. MEASUREMENT AND PAYMENT**

*Junction Box Marker* will be measured and paid for as the actual number of junction box markers furnished, installed, and accepted.

No measurement will be made of junction box marker adhesive as this will be considered incidental to furnishing and installing the junction box marker.

Payment will be made under:

Junction Box Marker.....Each

## 18. REMOVE EXISTING COMMUNICATIONS CABLE

### 18.1. DESCRIPTION

Remove existing communications cable. Remove existing communications cable and associated risers and in-ground junction boxes as designated in the Plans.

### 18.2. MATERIALS

Furnish rigid galvanized threaded pipe caps or rigid galvanized threaded pipe plugs to seal the ends of vertical conduits after “short risers” underneath pole-mounted cabinets are cutoff near ground level.

Furnish pipe caps or pipe plugs to seal the ends (i.e., tops) of 2” rigid galvanized steel risers from which fiber-optic cable and heat shrink tubing (or sealing bushing) are removed but not reinstalled (i.e., vacated existing fiber-optic cable risers). Provide heat-stabilized vinyl or plastic, non-threaded pipe cap or other Engineer-approved removable seal for top of vacated communications cable risers that are not removed. Refer to the “Risers” section of these Project Special Provisions for additional requirements for such riser caps.

Furnish heavy duty, dielectric, heat-shrink end caps designed to seal off and provide mechanical and mechanical protection to the ends of electrical and telecommunications cables. Provide end caps appropriated sized for the cables that they will be sealing.

### 18.3. CONSTRUCTION METHODS

#### A. General

Do not reuse any removed communications cable, messenger cable, junction boxes, pole attachment hardware or abandoned risers on the project, unless otherwise specified.

Only remove existing communications cable where called out in the Plans and where directed by the Engineer; otherwise, do not remove the existing communications cable.

In the event that any of the removed communications cable, junction boxes or pole attachment hardware is to be returned to the Engineer, it will be so noted in the Plans.

#### B. Removal of Aerial Communications Cable

Removal of existing aerial communications cable includes removal and proper disposal of aerial splice enclosures, messenger cable and mounting hardware, associated guy assemblies, as well as abandoned risers. Communications cable removal also includes removal of existing PVC risers that are vacated when the communications cable is removed. Retain and cap/plug tops of all other existing rigid galvanized steel risers vacated when communications cable is removed, unless the Engineer directs otherwise. Removal of guy assemblies includes the removal of guy anchors if not used by any other guy assembly.

Unless otherwise directed by the Engineer, remove and properly dispose of existing wood poles that are vacated upon removal of the existing communications cable (i.e., where the communications cable was the only attachment to the pole).

#### C. Removal of Underground Communications Cable

Removal of existing underground communications cable includes proper disposal of junction boxes, if required. Where junction boxes have been removed, backfill hole to 95% of surrounding density and finish level with surrounding ground.

When removing existing communications cable from an underground conduit that will be retained for future use, install a pull tape in the vacated underground conduit in conjunction with or immediately following removal of the existing cable. Seal the ends of the vacated conduit with an approved duct plug or duct and conduit sealer following installation of the pull tape.

When the Contractor has made reasonable attempts to remove an existing communications cable but is unable to do so as confirmed by the Engineer, carefully cut the existing cable close to the end of the conduit/duct, leaving just enough cable exposed to apply a heat shrink end cap over the end of the cable. Clean and prepare end of cable in accordance with heat shrink cable end cap manufacturer's instructions. Install a heat shrink cap appropriately sized for the cable being sealed over the end of the cable, then abandon the cable in the existing conduit/duct. Remove and dispose of the severed cable remnant.

At pole-mounted controller cabinets that have an existing short riser that conveys existing communications cable directly into the bottom of the cabinet from an underground conduit run and that short riser will not be retained for installation of a new fiber-optic drop cable, remove the short riser and existing communications cable as follows:

1. Disconnect the communications cable inside the pole-mounted controller cabinet.
2. Disconnect the short riser from the bottom of the cabinet and then cut off the short riser and communications cable flush with the sidewalk below the cabinet or at least 6 inches below ground where there is no sidewalk.
3. Where the short riser free-standing (i.e., offset from and not attached to pole from ground bottom of cabinet) and is within sidewalk below the cabinet, cut-off the short riser below grade (i.e., beneath the sidewalk) and replace the affected slab of sidewalk. Where the freestanding riser is in an unpaved area, cut off the short riser below ground and back fill over the top. If the short riser is attached to the pole (not offset), install a cap or plug the short riser at its current height.

Subject to the Engineer's approval, existing communications cable being removed may be used as a pull line to install the new fiber-optic communications cable in its place in the existing underground conduit. Comply with the installation requirements in the "Fiber-Optic Cable" section of these Project Special Provisions when installing then new fiber-optic cable in existing underground conduit.

#### **18.4. MEASUREMENT AND PAYMENT**

*Remove existing communications cable* will be measured in horizontal linear feet of existing communications cable removed and accepted. Payment will be in linear feet. Sag, vertical segments, and spare segments of communications cable will not be paid for, as these distances will be considered incidental to the removal of existing communications cable.

No additional measurement will be made for multiple communications cables being removed from the same underground conduit or same pole. No payment will be made for communications cable that cannot be removed and is abandoned in place.

No measurement will be made of the removal of messenger cable, pole attachment hardware, cable storage racks, guy assemblies, aerial splice enclosures, wood poles, stub poles, risers (where removal is required by this Project Special Provision or by the Engineer) and in-ground

junction boxes vacated upon removal of the existing communications cable, as these will be considered incidental to the removal of the existing communication cable.

No measurement will be made for installing a pull tape inside of and sealing the ends of an existing conduit that will be retained for future use after removing an existing communications cable from that conduit as such work will be considered incidental to installation of new fiber-optic communications cable.

Payment will be made under:

**Pay Item**

Remove Existing Communications Cable

**Pay Unit**

Linear Foot

## 19. CABLE TRANSFERS

### 19.1. DESCRIPTION

Remove and reinstall existing communications cable for pole relocations.

### 19.2. MATERIAL

Refer to the “Pole Line Hardware” subsection of the “Messenger Cable” section of these Project Special Provisions for all hardware associated with and used for cable transfers.

### 19.3. CONSTRUCTION METHODS

During the project, transfers of existing communications cable from one pole to an adjacent pole or from one attachment point to a new attachment point on the same pole may be required. Perform transfers as directed by the Engineer.

For pole-to-pole transfers, remove existing cable from the pole to be removed and reinstall the cable and any existing attachment hardware on the adjacent pole. Remove all communications hardware from first pole from which the cable was removed.

For attachment-point-to-attachment-point transfers on the same pole, drill a hole in the pole and install a strandvise for dead-end attachment of the cable as called for in the Plans, relocate the messenger cable from the existing 3-bolt clamp to the new strandvise, and remove the existing 3-bolt clamp. Install new guy assembly for dead-end span as shown in the Plans.

Furnish and install any new attachment hardware as required.

### 19.4. MEASUREMENT AND PAYMENT

*Cable transfer* will be measured and paid as the actual number of cable transfers with attachment hardware from one pole to an adjacent pole or from one attachment point to a new attachment point on the same pole furnished, installed, and accepted.

Payment will be made under:

<b>Pay Item</b>	<b>Pay Unit</b>
Cable Transfer	Each



## 20. PEDESTALS

### 20.1. DESCRIPTION

Furnish and install the size and type of support assembly for vehicular or pedestrian signal heads, pedestrian pushbutton, Intelligent Transportation System technologies or other traffic control devices as shown in the plans.

Furnish assembly with foundations, grounding systems, and all necessary hardware as shown in the *Roadway Standard Drawings*. Provide a pedestal assembly that meets *AASHTO Standard Specifications for Structural Supports for Highway Signs, Luminaires and Traffic Signals* in effect on the date of project advertisement. Unless otherwise required by the plans, install signal pedestals and pedestrian pushbutton posts on FHWA-approved breakaway support or anchor system.

Furnish and install screw-in helical foundation as an alternative to the standard reinforced concrete foundation for supporting Type I and Type II Pedestals. Do not use for Type III Pedestals.

### 20.2. MATERIALS

#### A. General

Furnish material, equipment, and hardware under this section that is pre-approved on the ITS and Signals QPL.

Furnish pedestal assemblies with foundations that conform to the latest edition of the *AASHTO Standard Specifications for Structural Supports for Highway Signs, Luminaires, and Traffic Signals* in effect on the date of project advertisement. Refer to *Roadway Standard Drawings* No. 1743 for structural design specifications for each type of pedestal.

In addition, refer to the following subsections of these Project Special Provisions:

- the “Wire and Cable” subsection of the “General Requirements” section, and
- the “Grounding Electrodes” subsection of the “Electrical Service” section.

#### B. Pedestal Shaft

Furnish one piece pedestal shafts fabricated from either aluminum or galvanized steel pipe with a uniform pipe outer diameter of 4.5 inches and of the lengths specified for the type of pedestal shown on *Roadway Standard Drawing* No. 1743.

Pedestals are defined as follows:

- Type I – Pedestrian Pushbutton Post
- Type II – Normal-Duty Pedestal
- Type III – Heavy-Duty Pedestal

For Type I (pedestrian pushbutton pedestals) and Type II (normal-duty pedestals), furnish shafts constructed from schedule 40 extruded aluminum pipe that conforms to Aluminum Association Alloy 6061-T6 with a tensile strength of 30 KSI and a minimum wall thickness of 0.237". Aluminum conduit will not develop the necessary strength required and is not allowed. Thread and deburr in accordance with American National Standard Pipe Threads, NPT (ANSI

B2.1). Finish the exterior with a rough surface texture consisting of a uniform grain pattern that is perpendicular to the axis of the pipe along the full pipe length. Unless otherwise specified, do not use galvanized steel pipe for Type I and Type II pedestal shafts.

For Type III (heavy-duty pedestals), furnish schedule 120 galvanized steel pipe that conforms to ASTM A53. Provide an 11 inches square by 1 inch thick steel base plate with minimum yield strength of 36 ksi that conforms to ASTM A36. Fabricate the base plate with four equally spaced bolt holes on an 11 inches bolt circle. Orient the bolt holes in the corners of the plate. Size the holes to accommodate 1 inch diameter machine bolts. Weld the pedestal shaft to the center of the base plate using a socket connection. Provide circumferential fillet welds at the top and bottom of the base plate. Perform all welding in accordance with the latest AWS Code. Hot-dip galvanize the pedestal shaft and base plate assembly after fabrication in accordance with ASTM A123. Unless otherwise specified, do not use aluminum pipe for Type III pedestal shafts.

### C. Transformer Bases

Furnish transformer bases for each type of pedestal shown on *Roadway Standard Drawings* No. 1743 fabricated from aluminum that meets Aluminum Association Alloy 356 or equivalent, and that are designed to break upon impact in accordance with AASHTO requirements. Submit FHWA certification for each type of transformer base that reflects compliance with NCHRP 350. For use in grounding and bonding, provide a 0.5 inch minimum diameter, coarse thread hole cast into transformer base located inside base and oriented for easy access.

Provide a minimum access opening for all transformer bases of 8 inches x 8 inches with an access door that is attached with a 1/4 inch x 3/4 inch long stainless steel vandal proof screw to secure access door.

For Type I (pedestrian pushbutton pedestals) and Type II (normal-duty pedestals), provide overall base dimensions of 15" (l) x 13 3/4" (w) x 13 3/4" (d) for square bases and 14" (l) x 16 1/2" (w) x 16 1/2" (d) for octagonal bases. Provide a threaded opening at the top of the base to receive a 4" NPT pipe shaft. Include a set screw prep and 3/8 inch-16 x 1 inch stainless steel set screw to secure the pedestal post to the pedestal base. Fabricate the bottom of the transformer base with four equally spaced holes or slots for a 12 inches bolt circle to secure the entire assembly to the concrete foundation.

For Type III (heavy-duty pedestals), provide square bases with overall dimensions of 17" (l) x 13" (w) x 13" (d). Fabricate the top of the transformer base with four equally spaced holes or slots for an 11 inches bolt circle to attach the pedestal shaft. Size the holes or slots to accommodate 1 inch diameter machine bolts. Fabricate the bottom of the transformer base with 4 equally spaced holes or slots for a 12 inches bolt circle to secure the entire assembly to the concrete foundation. Size the holes or slots to accommodate 1 inch diameter anchor bolts. Provide the following mounting hardware for heavy-duty pedestals:

- 1) Four 1 inch diameter by 3 1/2 inches long machine bolts (ASTM F593), with heavy hex nuts (ASTM A563 Grade DH, or A 194 Grade 2H), and thick flat washers, and lock washers (ASTM F436) per pedestal assembly. Galvanize in accordance with ASTM A153.

- 2) Three heavy hex nuts (ASTM A563 Grade DH, or A194 Grade 2H), 2 thick flat washers, and one lock washer (ASTM F436) for each anchor bolt. Galvanize in accordance with ASTM A153.
- 3) Six minimum slotted stainless steel shims of necessary thickness for leveling per pedestal assembly.

#### **D. Anchor Bolts**

For each pedestal, provide four anchor bolts in accordance with ASTM F1554, Grade 55, of the size and length specified in *Roadway Standard Drawings* No. 1743. Provide anchor bolts with coarse threads meeting the bolt/thread criteria specified by AISC. Provide threads for a minimum length of 4 inches on each end of the bolt. All thread anchor rods may be used. Ensure anchor bolts are hot-dipped galvanized in accordance with ASTM A153

For each anchor bolt:

- 1) Provide three heavy hex nuts; one at the top, and two at the bottom (embedded end) of the anchor bolt. Provide hex nuts with coarse threads that match the anchor bolt thread requirements above. Provide hex nuts that meet the requirements of ASTM A563 Grade DH, ASTM A194, Grade 2H or equivalent. Galvanize all heavy hex nuts in accordance with ASTM A153.
- 2) Provide one standard size washer that meets the requirements of ASTM F436 for use between two heavy hex nuts on the embedded end of the anchor bolt. Galvanize in accordance with ASTM A153.
- 3) Provide one extra thick, oversized washer for use over the slotted opening of the pedestal base. Fabricate washer to meet the chemical, physical, and heat treating requirements of ASTM F436. Fabricate the washer to the diameter and thickness needed. Galvanize fabricated washer in accordance with ASTM A153. Heat treat to the same requirements as ASTM F436 (i.e. 26 to 45 HRC).

For a  $\frac{3}{4}$  inch diameter anchor bolt mounted in a  $1\frac{1}{2}$  inch slotted opening, the dimensional requirements for an extra thick oversized washer are as follows:

- (a) The minimum Outside Diameter (OD) required is  $2\frac{3}{4}$  inch.
- (b) The hole Inside Diameter (ID) = Nominal Bolt Diameter +  $\frac{1}{16}$  inch = 0.812 inch.
- (c) The minimum washer thickness required is  $\frac{3}{8}$  inch.

If anchor bolts less than  $\frac{3}{4}$  inch in diameter are proposed for use to anchor pedestal bases, provide a washer calculation to ensure the washer thickness is adequate. To account for any pedestal manufacturing differences, verify the actual slotted opening width of the pedestal base anchoring points, and include in the calculation. Anchor bolts that are less than  $\frac{1}{2}$  inch in diameter may not be used as they are not structurally adequate to support the pedestal and may inhibit the performance of the breakaway base.

The fabrication process for thick washers makes the washer slightly tapered (i.e. the top OD and bottom OD are not the same). Install thick washers with the larger diameter face down against the pedestal base casting.

Do not use standard washers over the slotted opening of the pedestal base. Do not substitute or stack thin washers to achieve the required thickness specified or required.

In addition to the submittal requirements of Section 1098-1(B) of the *Standard Specifications*, provide Mill Certifications, Galvanization Certifications, and Heat Treating Certifications for all anchor bolts, fabricated washers, and structural hardware.

#### **E. Pedestal Cap**

Furnish a 4-1/2 inch outside diameter slip fit domed pedestal top cap for each pedestal assembly designed to fit over the outside of the pedestal shaft. Fabricate the cap from aluminum that meets Aluminum Association Alloy 356. Ensure the cap provides 3 equally spaced stainless steel set screw fasteners to secure the cap to the pedestal shaft.

#### **F. Pole Flange Base for 4 ½ Inches Pipe**

Furnish a flange base with cover for use with Type I (pedestrian pushbutton pedestals) and Type II (normal-duty pedestals) only. Flange bases are non-breakaway supports that are to be used with a breakaway bolt system for AASHTO compliance for breakaway structures. Provide aluminum or steel flange bases with a minimum 7.5 inches diameter bolt circle. Ensure bases are either continuously welded to shafts or threaded to receive shafts. Each base should be designed to accommodate either three or four ½ inch bolts equally spaced on the bolt circle to receive breakaway anchors. Provide NPT threads on the internal opening of the flange base through the full length of the flange base with locking set screws at the top of the base to receive a 4 inch NPT pipe shaft.

Fabricate aluminum flange bases that meet Aluminum Association Alloy 356 requirements for architectural bases. Fabricate steel flange bases that meet ASTM A36.

Do not use flange bases for Type III pedestals.

#### **G. Breakaway Anchors**

Furnish single or double neck omni-directional breakaway anchor bolt coupling systems for use with Type I (pedestrian pushbutton pedestals) and Type II (normal-duty pedestals) only. Use breakaway anchors that are FHWA certified to be compliant with NCHRP Report 350 as an alternative to transformer bases. Use with non-breakaway pole flange bases. Use ½ inch diameter bolts for pushbutton posts and ¾ inch bolts for normal-duty pedestals. Fabricate from steel with a minimum yield strength of 55 KSI. Galvanize in accordance with ASTM A153. Do not use breakaway anchors with Type III pedestals, or in conjunction with breakaway transformer bases.

#### **H. Foundation**

Install pedestal foundations of the type and size shown on *Roadway Standard Drawings* No. 1743.04. Furnish Class A minimum concrete that conforms to Article 1000-4 of the *Standard Specifications*. . Provide reinforcing steel that conforms to the applicable parts of Section 1070 of the *Standard Specifications*.

### I. Screw-In Helical Foundation Anchor Assembly

Furnish and install screw-in helical foundation as an alternative to the standard reinforced concrete foundation specified in the “Pedestals” section of these Project Special Provisions for supporting Type I and Type II Pedestals. Do not use for Type III Pedestals.

#### 1. Type I – Pedestrian Pushbutton Post:

Fabricate pipe assembly consisting of a 4 inch diameter x 56 inch long pipe, single helical blade and square fixed attachment plate. Furnish pipe in accordance with ASTM A-53 ERW Grade B and include a 2 inch x 3 inch cable opening in the pipe at 18 inches below the attachment plate. Furnish steel attachment plate and helical blade in accordance with ASTM A-36. Include four slotted mounting holes in the attachment plate to fit bolt circles ranging from 7 ¾ inches to 14 ¾ inches diameter. Furnish additional ¾ inch keyholes at slotted holes to permit anchor bolt installation and replacement from top surface. Include combination bolt-head retainer and dirt scrapers at the attachment plate underside to allow for a level or flush-mount plate installation with respect to the finished grade. Galvanize pipe assembly components in accordance with AASHTO M 111 or an approved equivalent.

Furnish four ¾ inch 10NC x 3 inch square head anchor bolts to meet the requirements of ASTM 325. Provide four ¾ inch plain flat galvanized washers, four ¾ inch thick galvanized plate washers and four ¾ inch galvanized hex nuts. Galvanize in accordance with AASHTO M 111 or an approved equivalent.

#### 2. Type II – Normal-Duty Pedestal

Fabricate pipe assembly consisting on a 6 inch diameter x 60 inch long, single helical blade, 1 ¼ inch diameter stinger rod and square fixed attachment plate. Furnish pipe in accordance with ASTM A-53 ERW Grade B using schedule 40 wall thickness and include a 2 inch x 3 inch cable opening in the pipe at 18 inches below the attachment plate. Furnish steel attachment plate, helical blade and stinger rod in accordance with ASTM A-36. Include four slotted mounting holes in the attachment plate to fit bolt circles ranging from 10 inches to 15 inches in diameter. Furnish additional 1 ¼ inch keyholes at slotted holes to permit anchor bolt installation and replacement from top surface. Include combination bolt-head retainer and dirt scrapers at the attachment plate underside to allow for a level or flush-mount plate installation with respect to the finished grade. Galvanize pipe assembly components in accordance with AASTO M 111 or an approved equivalent.

Furnish four 1 inch 8NC x 4 inch galvanized Grade 5 square head anchor bolts. Provide four 1 inch plain flat galvanized washers and four 1 inch galvanized hex nuts. Galvanize in accordance with AASHTO M 111 or an approved equivalent.

### 20.3. CONSTRUCTION METHODS

#### A. Type I Pedestrian Pushbutton Post

Install pushbutton post for mounting pedestrian pushbutton or an accessible pedestrian signal (APS) assembly (refer to “Signal Head” section of these Project Special Provisions).

Install underground conduit for pushbutton lead-in cable in the pushbutton post’s foundation.

Attach or anchor pushbutton post to the top of foundation via a breakaway support in a vertical plumb orientation. Ensure post is of sufficient length to accommodate the pushbutton, accessible pedestrian signals and any associated pedestrian informational signing at the mounting heights shown in the plans or *Roadway Standard Drawings*.

### **B. Type II and III Pedestals**

Locate foundations, determine elevation, and submit findings for normal-duty and heavy duty pedestals. Obtain the Engineer's approval of foundation locations and elevations before constructing foundations.

Excavate in accordance with Section 410, Foundation Excavation, of the *Standard Specifications*. If encountered, remove rock or boulders to a depth sufficient to obtain stability necessary to support the structure for design loads. Ensure ground is level before installing foundations.

Construct foundations in accordance with Section 825, Incidental Concrete Construction, of the *Standard Specifications*. Cast concrete for pole foundations against undisturbed soil unless otherwise permitted. Provide forms with chamfer strips that measure one inch along diagonal face at all corners above ground level. Do not install foundations over uncompacted fill or muck.

Install conduit in foundations.

Securely place, position, and align anchor bolts symmetrically about the center of foundation.

Give exposed vertical concrete surfaces a broom finish. Give exposed horizontal surfaces a float finish.

Level tops of concrete foundations. Do not allow tops to exceed 4 inches above adjacent ground surface. Pour and finish foundation to a level that is flush with surrounding sidewalk when possible.

Do not erect pedestals until concrete has attained a minimum compressive strength of 2,500 psi as determined by cylinder breaks.

Refer to *Roadway Standard Drawings* No. 1705 and 1743.

### **C. Screw-In Helical Foundation Anchor Assembly:**

Advance or mechanically screw foundation into soil until top of attachment plate is level with finished grade. Slide the anchor bolt heads through the keyhole openings and under the attachment plate with threads pointing up. Bolt the pedestal base to the foundation attachment plate.

For further construction methods, see manufacturer's installation drawings.

## **20.4. MEASUREMENT AND PAYMENT**

*Type I post with foundation* will be measured and paid as the actual number of pedestrian pushbutton posts furnished, installed, and accepted.

*Type II pedestal with foundation* will be measured and paid as the actual number of normal-duty pedestals with foundations furnished, installed, and accepted.

No measurement will be made for pedestal foundations, pedestal screw-in helical foundations, grounding systems and any peripheral pedestal mounting hardware as these are considered incidental to furnishing and installing pedestals.

Payment will be made under:

<b>Pay Item</b>	<b>Pay Unit</b>
Type I Post with Foundation	Each
Type II Pedestal with Foundation	Each

## 21. SIGNS INSTALLED FOR SIGNALS

### 21.1. DESCRIPTION

Furnish and install signs for signals with approved cable hangers, rigid sign mounting brackets, U-channel posts, and all necessary hardware.

### 21.2. MATERIALS

Refer to Division 10 of the *Standard Specifications*:

Item	Section(s)
Signs and Hardware	1092-1
Retroreflective Sheeting	1092-2

Use Grade C retroreflective sheeting, except for black sheeting. Use non-reflective for black sheeting.

Conform to the message layout, size, and color as required in the *MUTCD*.

For messenger cable mounting, furnish either messenger cable hangers with free-swinging, 360° adjustable sign brackets or 3-bolt clamps as directed. Furnish aluminum, galvanized steel, or stainless steel sign supporting hardware.

For ground mounting, furnish steel, 3 lb., U-channel posts with hardware for ground mounting. Comply with Section 903, Ground Mounted Sign Supports of the *Standard Specifications*.

For mast-arm mounting, furnish rigid aluminum, galvanized steel or stainless steel sign mounting brackets.

### 21.3. CONSTRUCTION METHODS

Install signs with applicable mounting hardware. Comply with sign offsets and mounting heights as shown in the *MUTCD* and *Roadway Standard Drawing*.

For messenger cable mounting, install signs 6 inches minimum from signal heads.

For ground mounting, comply with Section 903-3, Construction Methods for Ground Mounted Supports of the *Standard Specifications*.

For mast arm mounting, install attachment brackets to allow adjustment so signs:

- Are aimed in required direction,
- Are plumb as viewed from respective approaches,
- May be tilted forward or backward as required, and
- May be raised or lowered on mast arm throughout full length of sign.

### 21.4. MEASUREMENT AND PAYMENT

*Sign for signals* will be measured and paid as the actual number of signs for signals, regardless of mounting method, furnished, installed, and accepted.

Payment will be made under:

Pay Item	Pay Unit
Sign for Signals	Each



## 22. SIGNAL CABINET FOUNDATIONS

### 22.1. DESCRIPTION

Furnish and install signal cabinet foundations and all necessary hardware.

Furnish either poured concrete foundations or preformed cabinet pad foundations and all necessary hardware. Obtain approval of foundation type.

### 22.2. MATERIALS

Refer to Division 10 of the *Standard Specifications*:

Item	Section(s)
Portland Cement Concrete	1000-4

Furnish preformed cabinet pad foundation material, equipment, and hardware under this section that is pre-approved on the ITS and Signals QPL.

Provide preformed cabinet pad foundations with 7"(l) x 18"(w) minimum opening for the entrance of conduits. For precast signal cabinet foundations, include steel reinforcement to ensure structural integrity during shipment and placing of item. Include four ¾ inch coil thread inserts for lifting. Comply with Article 1077-16 of the *Standard Specifications*.

Furnish cabinet foundations with chamfered top edges. Provide minimum Class B concrete in accordance with Article 1000-4, "Portland Cement Concrete for Structures and Incidental Construction," of the *Standard Specifications*.

Provide standard cabinet foundations in unpaved areas with a minimum pad area that extends 24" from front and back of cabinet base extenders and adapters, and 3" from sides of cabinet base extenders and adapters. For cabinet foundations installed within brick or concrete sidewalks, omit the 24" from the front and rear of the cabinet and provide a foundation that extends 3" from all four sides of the cabinet base extender as shown on the special detail in the Plans.

Furnish Class B Portland cement concrete and all materials needed for the replacement of cement concrete sidewalks in accordance with Article 848-2 of the *Standard Specifications*, to replace removed or damaged sections of existing sidewalk and restore locations to preconstruction condition.

Furnish replacement sidewalk pavers where required to restore locations to preconstruction condition that are of the same color, texture, shape, dimensions and materials as the damaged or modified items.

Provide replacement materials for other special pavement treatments or landscaping that are the same materials as the damaged or modified items to restore locations to preconstruction condition.

### 22.3. CONSTRUCTION METHODS

Comply with Section 825, "Incidental Concrete Construction – General," of the *Standard Specifications*.

Refer to Section 1 of these Project Special Provisions for requirements concerning construction within historic districts.

When using poured concrete foundations and preformed cabinet pads, use procedures, equipment, and hardware as follows:

- Locate new cabinets so as not to obstruct sight distance of vehicles turning on red or create any ADA violations or pedestrian conflicts.
- Obtain approval for final cabinet foundation locations before pouring concrete base or installing a preformed cabinet base.
- Do not install foundations over uncompacted fill or muck.
- Hand-tamp soil before placing concrete or preformed cabinet base and ensure ground is level.
- Maintain 12 inches minimum from service pole to closest point on foundation unless otherwise approved.
- Use a minimum of four 1/2-inch diameter expanding type anchor bolts to secure cabinet to foundation.
- In unpaved areas, install cabinet foundations a minimum 4 inches above and 4 inches below finished grade. In paved areas, install foundations 1 inch above the paved surface at its highest point and 4 inches below the paved surface at its lowest point.
- Locate external stubbed out conduit at cabinet foundation so conduit is in middle of cabinet. Provide service conduit as the rightmost conduit coming into cabinet. Provide two spare conduits stubbed out; one pointed toward service pole and the other toward direction of lead-in cable. Inscribe identification arrow in foundation indicating direction of spare conduits.
- Ensure that conduits extend 2 inches to 3 inches above finished cabinet foundation.
- Give cabinet foundation a broom finish and chamfered edges.
- Seal space between cabinet base and foundation with permanent, flexible, waterproof sealing material.

If using preformed cabinet pad, use loop sealant to seal the conduit stub-outs within the knock-out. Do not use preformed cabinet pad for cabinet foundations located within or adjacent to historic districts.

Restore the disturbed ground surrounding the new cabinet foundation to its original, preconstruction condition as determined and approved by the Engineer.

- For paved areas, replace removed or damaged pavement with in kind materials, matching the elevation, color, texture/finish and general appearance of the surrounding pavement. Refer to Section 1 of these Project Special Provisions for additional requirements concerning sidewalks and curbs in historic districts. Replace concrete sidewalk in whole slabs from joint to joint and comply with Article 848-3 of the *Standard Specifications*. Replace brick pavers using pavers of the same color, texture, shape, dimensions and materials as the damaged or modified items. Place graded stone material to temporarily maintain pedestrian traffic where repairs cannot be performed immediately. Comply with Article 545-4 of the *Standard Specifications*.

- For unpaved areas, backfill excavations with removed material, tamp the backfilled material and rake smooth the top 1½ inches. Finish unpaved areas flush with surrounding natural ground and to match the original contour of the ground. Seed with same type of grass as surrounding area and mulch the newly seeded area. If unpaved area was not grassed, replace the original ground cover in kind as directed by the Engineer.

**Complete repairs to and restoration of all ground (paved and unpaved) disturbed for construction within five consecutive calendar days following initial removal.** If the Contractor fails to repair and restore the ground in accordance with these Project Special Provisions within the time frame specified, the Department reserves the right to make the necessary repairs, and all expenses incurred by the Department in making the repairs and restoring the ground will be deducted from payment due the Contractor, plus **\$500 liquidated damages per occasion, per day, or any portion thereof**, until corrected.

#### **22.4. MEASUREMENT AND PAYMENT**

*Signal cabinet foundation* will be measured and paid as the actual number furnished, installed, and accepted.

*4" concrete sidewalk* will be measured and paid in square yards, measured along the surface of the completed and accepted work. Such price includes, but is not limited to, excavating and backfilling, sawing the existing sidewalk, furnishing and placing concrete, and constructing and sealing joints.

No measurement will be made of special finishing, staining and tinting of concrete sidewalk to match the appearance of existing sidewalk as such work will be considered incidental to furnishing and installing 4" concrete sidewalk.

*Brick pavers* will be measured and paid as the actual square feet of brick pavers furnished, installed and accepted.

No measurement or payment will be made for restoration of the surrounding unpaved ground surfaces in accordance with these Project Special Provisions as such work will be considered incidental to furnishing and installing signal cabinet foundations.

No measurement or payment will be made for furnishing and installing and subsequently removing graded stone material for temporary maintenance pedestrian traffic where a portion of an existing sidewalk has been removed as such work will be considered incidental to furnishing and installing signal cabinet foundations.

Payment will be made under:

<b>Pay Item</b>	<b>Pay Unit</b>
Signal Cabinet Foundation	Each
4" Concrete Sidewalk	Square Yard
Brick Pavers	Square Foot

## 23. MODIFY CABINET FOUNDATIONS

### 23.1. DESCRIPTION

Where approved by the Engineer, install conduit entrances into existing foundations in accordance with the Plans and Project Special Provisions. Modify existing foundations in accordance with the Plans and Project Special Provisions.

### 23.2. MATERIALS

Comply with the provisions of “Signal Cabinet Foundations” section of these Project Special Provisions.

### 23.3. CONSTRUCTION METHODS

#### A. General

Ensure that an IMSA certified, or equivalent, Level II traffic qualified signal technician is standing by to provide emergency maintenance services whenever work is being performed on traffic signal controller cabinet foundations. Standby status is defined as being able to arrive, fully equipped, at the work site within 30 minutes ready to provide maintenance services.

#### B. Install Conduit Entrance into Existing Foundation

Install new conduit entrances into existing cabinet foundations by core drilling foundations to install additional conduits. New entrances for conduits 1” or less in nominal diameter may be drilled in lieu of core-drilled, subject to the Engineer’s approval.

Maintain a minimum of 3 inches of cover between new conduit and edge of foundation. Maintain minimum clearances of 1 inch from the flange of the base adapter and 2 inches from existing conduits. Avoid damaging existing conduit, conductors, and anchor bolts. Repair all such damages. Where approved by the Engineer, the foundation may be chipped instead of drilled for conduit entrance. When possible, maintain traffic signal operations while drilling is performed.

Bond new metallic conduit to the equipment grounding bus.

After installation of conduit, place grout to seal around conduit, and return the foundation to normal appearance.

#### C. Modify Foundation

Enlarge existing cabinet foundations to accommodate the new cabinet and/or to provide a maintenance technician pad.

Excavate the ground around the existing foundation to a depth sufficient to expose a minimum of 4 inches of the foundation below existing grade.

Rough the sides of the existing foundation from the top to a point 4 inches below grade by means of a chisel or other method approved by the Engineer.

Wash the sides of the foundation with water pressurized at 50 psi and thoroughly dry with compressed air.

Drill holes approximately 12 inches deep on 12-inch centers into the existing foundation. Clean holes with compressed air only prior to applying epoxy and installing dowels. Do not

clean holes with water or any other liquid. Install #4 dowels and epoxy into place. Provide dowels of the following lengths:

Foundation Extension	Length of Dowel
>16"	24"
>6" and ≤16"	17"
=6"	14"

Use concrete to install the maintenance technician pad.

Form the sides of the modified foundation to a minimum depth of 4 inches below grade.

Position forms so that all existing exposed foundation surfaces at or above grade level will be matched.

Apply a coating of approved epoxy bonding agent to all exposed roughened concrete surfaces as recommended by the manufacturer.

As a minimum, enlarge the foundation to the distance specified for new cabinet foundations. Maintenance technician pads should be added to the foundation to provide a minimum work area of 24 inches [length] x 30 inches [width] from both the front and rear doors of the cabinet, unless otherwise directed by the Engineer. Increase the pad enlargement beyond these minimum dimensions to match the width of the existing foundation along the side to which concrete is being added to maintain the rectangular shape of the pad.

Provide a 1-inch chamfer on all new outside edges.

Modify cabinet foundations located within or adjacent to historic districts as shown in the Plans using a concrete mix tinted to match the appearance of the existing concrete foundation being modified.

#### **D. Ground Surface Restoration**

Restore the disturbed ground, both paved and unpaved, surrounding the modified cabinet foundation to its original condition as determined and approved by the Engineer. Comply with all requirements of the "Ground Surface Restoration" subsection of the "Signal Cabinet Foundation" section of these Project Special Provisions.

#### **23.4. MEASUREMENT AND PAYMENT**

*Conduit entrance into existing foundation* will be measured as the actual number of conduit entrances drilled into existing cabinet foundations furnished, installed and accepted. As approved by the Engineer, law enforcement provided for directing traffic while a signal is inoperable during construction of conduit entrance into existing foundation will be measured and paid for separately in accordance with the "Temporary Traffic Control" section of these Project Special Provisions.

*Modify foundation for controller cabinet* will be measured and paid as the actual number of existing cabinet foundations modified and accepted.

No measurement or payment will be made for restoration of the surrounding unpaved ground surfaces in accordance with these Project Special Provisions as such work will be considered

incidental to installation of the conduit entrance into existing foundation or modification of the foundation for controller cabinet.

Payment will be made under:

**Pay Item**

**Pay Unit**

Conduit Entrance into Existing Foundation

Each

Modify Foundation for Controller Cabinet

Each

## 24. CONTROLLERS WITH CABINETS

### 24.1. DESCRIPTION

Furnish and install controllers with cabinets and all necessary hardware. Furnish all foundation mounting hardware, detector sensor cards, one Corbin Number 2 cabinet key, one police panel key, conflict monitors, surge protection, grounding systems, AC/DC isolator cards, auxiliary files and all necessary hardware.

### 24.2. MATERIALS - GENERAL

Furnish material, equipment, and hardware under this section that is pre-approved on the ITS and Signals OPL.

### 24.3. MATERIALS – TYPE 2070LX CONTROLLERS

Furnish model 2070LX controller units that conform to CALTRANS *Transportation Electrical Equipment Specifications* (TEES) (dated March 12, 2009, plus Errata 1 dated January 21, 2010 and Errata 2 dated December 5, 2014) except as required herein.

The Department will provide software at the beginning of the burning-in period. Contractor shall give 5 working days notice before needing software. Program software provided by the Department.

Provide model 2070LX controllers with Linux kernel 2.6.18 or higher and device drivers, composed of the unit chassis and at a minimum the following modules and assemblies:

- MODEL 2070-1C, CPU Module, Single Board, with 8Mb Datakey (blue in color)
- MODEL 2070-2E+, Field I/O Module (FI/O)
  - Note: Configure the Field I/O Module to disable both the External WDT Shunt/Toggle Switch and SP3 (SP3 active indicator is “off”)
- MODEL 2070-3B, Front Panel Module (FP), Display B (8x40)
- MODEL 2070-4A, Power Supply Module, 10 AMP

Provide a Board Support Package (BSP) to the state and to any specified applications software manufacturer when requested by the state to facilitate the porting of application software.

### 24.4. MATERIALS – GENERAL CABINETS

Provide a moisture resistant coating on all circuit boards.

Provide one 20 mm diameter radial lead UL-recognized metal oxide varistor (MOV) between each load switch field terminal and equipment ground. Electrical performance is outlined below.

PROPERTIES OF MOV SURGE PROTECTOR	
Maximum Continuous Applied Voltage at 185° F	150 VAC (RMS) 200 VDC
Maximum Peak 8x20µs Current at 185° F	6500 A
Maximum Energy Rating at 185° F	80 J
Voltage Range 1 mA DC Test at 77° F	212-268 V
Max. Clamping Voltage 8x20µs, 100A at 77° F	395 V
Typical Capacitance (1 MHz) at 77° F	1600 pF

Provide a power line surge protector that is a two-stage device that will allow connection of the radio frequency interference filter between the stages of the device. Ensure that a maximum continuous current is at least 10A at 120V. Ensure that the device can withstand a minimum of 20 peak surge current occurrences at 20,000A for an 8x20 microsecond waveform. Provide a maximum clamp voltage of 395V at 20,000A with a nominal series inductance of 200 $\mu$ h. Ensure that the voltage does not exceed 395V. Provide devices that comply with the following:

Frequency (Hz)	Minimum Insertion Loss (dB)
60	0
10,000	30
50,000	55
100,000	50
500,000	50
2,000,000	60
5,000,000	40
10,000,000	20
20,000,000	25

## 24.5. MATERIALS – TYPE 170E CABINETS

### A. Type 170 E Cabinets General

Conform to the city of Los Angeles' Specification No. 54-053-08, *Traffic Signal Cabinet Assembly Specification* (dated July 2008), except as required herein.

Furnish model 332 base mounted cabinets configured for 8 vehicle phases, 4 pedestrian phases, and 6 overlaps. When overlaps are required, provide auxiliary output files for the overlaps. Do not reassign load switches to accommodate overlaps unless shown on electrical details.

Provide model 200 load switches, model 222 loop detector sensors, model 252 AC isolators, and model 242 DC isolators according to the electrical details. As a minimum, provide one (1) model 2018 conflict monitor, one (1) model 206L power supply unit, two (2) model 204 flashers, one (1) DC isolator (located in slot I14), and four (4) model 430 flash transfer relays (provide seven (7) model 430 flash transfer relays if auxiliary output file is installed) with each cabinet.

### B. Type 170 E Cabinet Electrical Requirements

Provide a cabinet assembly designed to ensure that upon leaving any cabinet switch or conflict monitor initiated flashing operation, the controller starts up in the programmed start up phases and start up interval.

Furnish two sets of non-fading cabinet wiring diagrams and schematics in a paper envelope or container and placed in the cabinet drawer.

All AC+ power is subject to radio frequency signal suppression.

Provide surge suppression in the cabinet for each type of cabinet device. Provide surge protection for the full capacity of the cabinet input file. Provide surge suppression devices that operate properly over a temperature range of -40° F to +185° F. Ensure the surge suppression devices provide both common and differential modes of protection.



Provide a pluggable power line surge protector that is installed on the back of the PDA (power distribution assembly) chassis to filter and absorb power line noise and switching transients. Ensure the device incorporates LEDs for failure indication and provides a dry relay contact closure for the purpose of remote sensing. Ensure the device meets the following specifications:

Peak Surge Current (Single pulse, 8x20 $\mu$ s).....	20,000A
Occurrences (8x20 $\mu$ s waveform).....	10 minimum @ 20,000A
Maximum Clamp Voltage.....	395VAC
Operating Current.....	15 amps
Response Time.....	< 5 nanoseconds

Provide a loop surge suppressor for each set of loop terminals in the cabinet. Ensure the device meets the following specifications:

Peak Surge Current (6 times, 8x20 $\mu$ s)	
(Differential Mode).....	400A
(Common Mode).....	1,000A
Occurrences (8x20 $\mu$ s waveform).....	500 min @ 200A
Maximum Clamp Voltage	
(Differential Mode @400A).....	35V
(Common Mode @1,000A).....	35V
Response Time.....	< 5 nanoseconds
Maximum Capacitance.....	35 pF

Provide a data communications surge suppressor for each communications line entering or leaving the cabinet. Ensure the device meets the following specifications:

Peak Surge Current (Single pulse, 8x20 $\mu$ s).....	10,000A
Occurrences (8x20 $\mu$ s waveform).....	100 min @ 2,000A
Maximum Clamp Voltage.....	Rated for equipment protected
Response Time.....	< 1 nanosecond
Maximum Capacitance.....	1,500 pF
Maximum Series Resistance.....	15 $\Omega$

Provide a DC signal surge suppressor for each DC input channel in the cabinet. Ensure the device meets the following specifications:

Peak Surge Current (Single pulse, 8x20 $\mu$ s).....	10,000A
--	---------

Occurrences (8x20µs waveform).....	100 @ 2,000A
Maximum Clamp Voltage.....	30V
Response Time.....	< 1 nanosecond

Provide a 120 VAC signal surge suppressor for each AC+ interconnect signal input. Ensure the device meets the following specifications:

Peak Surge Current (Single pulse, 8x20µs).....	20,000A
Maximum Clamp Voltage.....	350VAC
Response Time.....	< 200 nanoseconds
Discharge Voltage.....	<200 Volts @ 1,000A
Insulation Resistance.....	≥100 MΩ

Provide conductors for surge protection wiring that are of sufficient size (ampacity) to withstand maximum overcurrents which could occur before protective device thresholds are attained and current flow is interrupted.

If additional surge protected power outlets are needed to accommodate fiber transceivers, modems, etc., install a UL listed, industrial, heavy-duty type power outlet strip with a minimum rating of 15 A / 125 VAC, 60 Hz. Provide a strip that has a minimum of 3 grounded outlets. Ensure the power outlet strip plugs into one of the controller unit receptacles located on the rear of the PDA. Ensure power outlet strip is mounted securely; provide strain relief if necessary.

Provide a door switch in the front and a door switch in the rear of the cabinet that will provide the controller unit with a Door Ajar alarm when either the front or the rear door is open. Ensure the door switches apply DC ground to the Input File when either the front door or the rear door is open.

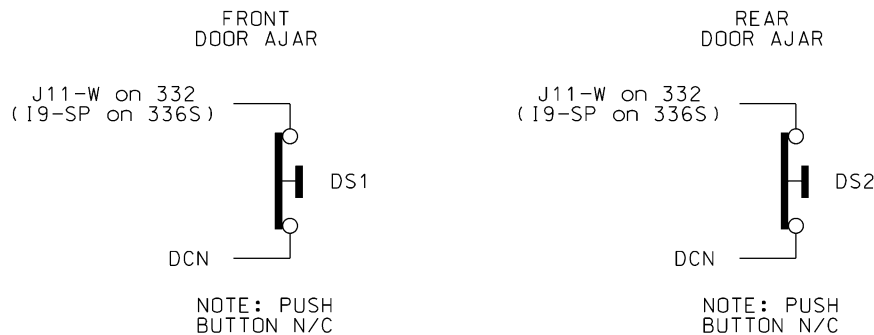

Furnish a fluorescent fixture in the rear across the top of the cabinet and another fluorescent fixture in the front across the top of the cabinet at a minimum. Ensure that the fixtures provide sufficient light to illuminate all terminals, labels, switches, and devices in the cabinet. Conveniently locate the fixtures so as not to interfere with a technician's ability to perform work on any devices or terminals in the cabinet. Provide a protective diffuser to cover exposed bulbs. Install 16 watt T-4 lamps in the fluorescent fixtures. Provide a door switch to provide power to

each fixture when the respective door is open. Wire the fluorescent fixtures to the 15 amp ECB (equipment circuit breaker).

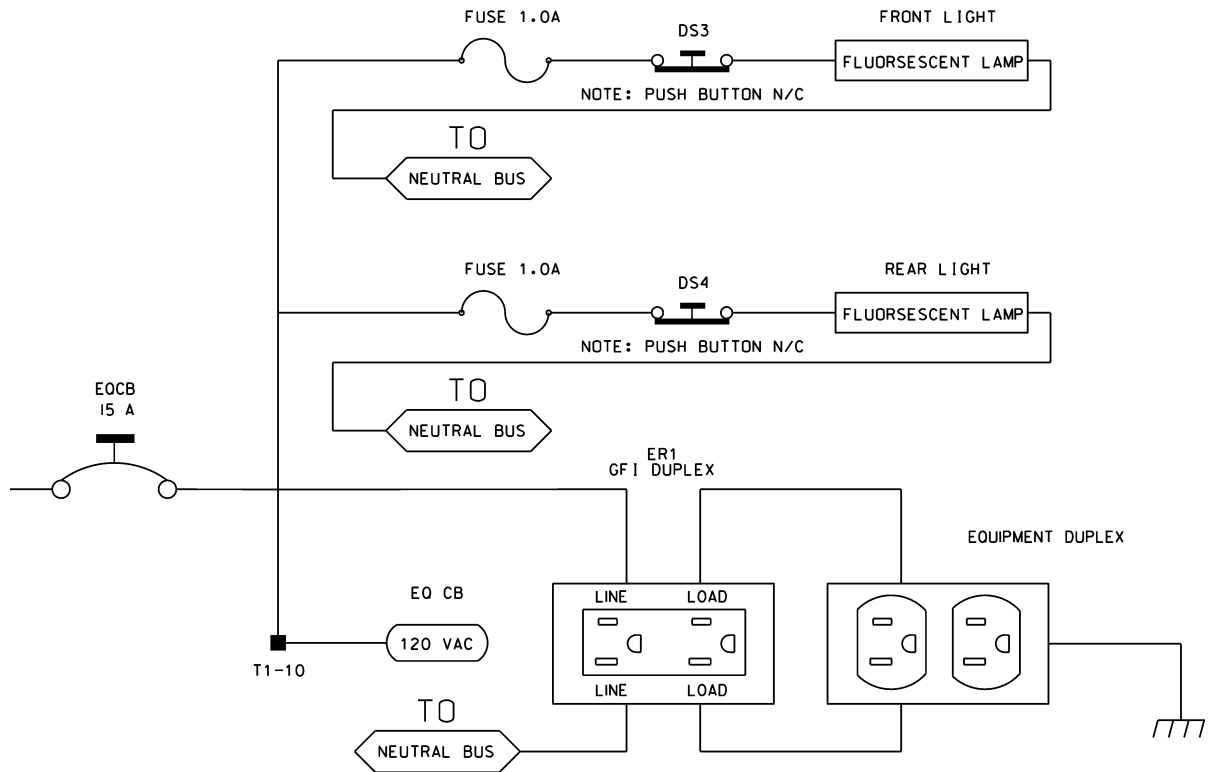

Furnish a police panel with a police panel door. For model 336S cabinets, mount the police panel on the rear door. Ensure that the police panel door permits access to the police panel when the main door is closed. Ensure that no rainwater can enter the cabinet even with the police panel door open. Provide a police panel door hinged on the right side as viewed from the front. Provide a police panel door lock that is keyed to a standard police/fire call box key. In addition to the requirements of LA Specification No. 54-053-08, provide the police panel with a toggle switch connected to switch the intersection operation between normal stop-and-go operation (AUTO) and manual operation (MANUAL). Ensure that manual control can be implemented using inputs and software such that the controller provides full programmed clearance times for the yellow clearance and red clearance for each phase while under manual control.

Provide a 1/4-inch locking phone jack in the police panel for a hand control to manually control the intersection. Provide sufficient room in the police panel for storage of a hand control and cord.

Ensure the 336S cabinet Input File is wired as follows:

336S Cabinet Port-Bit/C-1 Pin Assignment														
Slot #	1	2	3	4	5	6	7	8	9	10	11	12	13	14
C-1 (Spares)	59	60	61	62	63	64	65	66	75	76	77	78	79	80
Port C-1	3-2 56	1-1 39	3-4 58	1-3 41	3-1 55	1-2 40	3-3 57	1-4 42	2-5 51	5-5 71	5-6 72	5-1 67	5-2 68	6-7 81
Port C-1	2-1 47	1-5 43	2-3 49	1-7 45	2-2 48	1-6 44	2-4 50	1-8 46	2-6 52	5-7 73	5-8 74	5-3 69	5-4 70	6-8 82

For model 332 base mounted cabinets, ensure terminals J14-E and J14-K are wired together on the rear of the Input File. Connect TB9-12 (J14 Common) on the Input Panel to T1-2 (AC-) on the rear of the PDA.

Provide detector test switches mounted at the top of the cabinet rack or other convenient location which may be used to place a call on each of eight phases based on the chart below. Provide three positions for each switch: On (place call), Off (normal detector operation), and Momentary On (place momentary call and return to normal detector operation after switch is released). Ensure that the switches are located such that the technician can read the controller display and observe the intersection.

Connect detector test switches for cabinets as follows:

336S Cabinet		332 Cabinet	
Detector Call Switches	Terminals	Detector Call Switches	Terminals
Phase 1	I1-F	Phase 1	I1-W
Phase 2	I2-F	Phase 2	I4-W
Phase 3	I3-F	Phase 3	I5-W
Phase 4	I4-F	Phase 4	I8-W
Phase 5	I5-F	Phase 5	J1-W
Phase 6	I6-F	Phase 6	J4-W
Phase 7	I7-F	Phase 7	J5-W
Phase 8	I8-F	Phase 8	J8-W

Provide the PCB 28/56 connector for the conflict monitor unit (CMU) with 28 independent contacts per side, dual-sided with 0.156 inch contact centers. Provide the PCB 28/56 connector contacts with solder eyelet terminations. Ensure all connections to the PCB 28/56 connector are soldered to the solder eyelet terminations.

Ensure that all cabinets have the CMU connector wired according to the 332 cabinet connector pin assignments (include all wires for auxiliary output file connection). Wire pins 13, 16, R, and U of the CMU connector to a separate 4 pin plug, P1, as shown below. Provide a second plug, P2, which will mate with P1 and is wired to the auxiliary output file as shown below. Provide an additional plug, P3, which will mate with P1 and is wired to the pedestrian yellow circuits as shown below. When no auxiliary output file is installed in the cabinet, provide wires for the green and yellow inputs for channels 11, 12, 17, and 18, the red inputs for channels

17 and 18, and the wires for the P2 plug. Terminate the two-foot wires with ring type lugs, insulated, and bundled for optional use.

PIN	P1		P2		P3	
	FUNCTION	CONN TO	FUNCTION	CONN TO	FUNCTION	CONN TO
1	CH-9G	CMU-13	OLA-GRN	A123	2P-YEL	114
2	CH-9Y	CMU-16	OLA-YEL	A122	4P-YEL	105
3	CH-10G	CMU-R	OLB-GRN	A126	6P-YEL	120
4	CH-10Y	CMU-U	OLB-YEL	A125	8P-YEL	111

Do not provide the P20 terminal assembly (red monitor board) or red interface ribbon cable as specified in the LA Specification No. 54-053-08.

Provide a P20 connector that mates with and is compatible with the red interface connector mounted on the front of the conflict monitor. Ensure that the P20 connector and the red interface connector on the conflict monitor are center polarized to ensure proper connection. Ensure that removal of the P20 connector will cause the conflict monitor to recognize a latching fault condition and place the cabinet into flashing operation.

Wire the P20 connector to the output file and auxiliary output file using 22 AWG stranded wires. Ensure the length of these wires is a minimum of 42 inches. Provide a durable braided sleeve around the wires to organize and protect the wires.

Wire the P20 connector to the traffic signal red displays to provide inputs to the conflict monitor as shown below. Ensure the pedestrian Don't Walk circuits are wired to channels 13 through 16 of the P20 connector. When no auxiliary output file is installed in the cabinet, provide wires for channels 9 through 12 reds. Provide a wire for special function 1. Terminate the unused wires with ring type lugs, insulated, and bundled for optional use.

P20 Connector					
PIN	FUNCTION	CONN TO	PIN	FUNCTION	CONN TO
1	Channel 15 Red	119	2	Channel 16 Red	110
3	Channel 14 Red	104	4	Chassis GND	01-9
5	Channel 13 Red	113	6	N/C	
7	Channel 12 Red	AUX 101	8	Spec Function 1	
9	Channel 10 Red	AUX 124	10	Channel 11 Red	AUX 114
11	Channel 9 Red	AUX 121	12	Channel 8 Red	107
13	Channel 7 Red	122	14	Channel 6 Red	134
15	Channel 5 Red	131	16	Channel 4 Red	101
17	Channel 3 Red	116	18	Channel 2 Red	128
19	Channel 1 Red	125	20	Red Enable	01-14

Ensure the controller unit outputs to the auxiliary output file are pre-wired to the C5 connector. When no auxiliary output file is installed in the cabinet, connect the C5 connector to a storage socket located on the Input Panel or on the rear of the PDA.

Do not wire pin 12 of the load switch sockets.

In addition to the requirements of LA Specification No. 54-053-08, ensure relay K1 on the Power Distribution Assembly (PDA) is a four pole relay and K2 on the PDA is a two pole relay.

Provide a two pole, ganged circuit breaker for the flash bus circuit. Ensure the flash bus circuit breaker is an inverse time circuit breaker rated for 10 amps at 120 VAC with a minimum of 10,000 RMS symmetrical amperes short circuit current rating. Do not provide the auxiliary switch feature on the flash bus circuit breaker. Ensure the ganged flash bus circuit breaker is certified by the circuit breaker manufacturer to provide gang tripping operation.

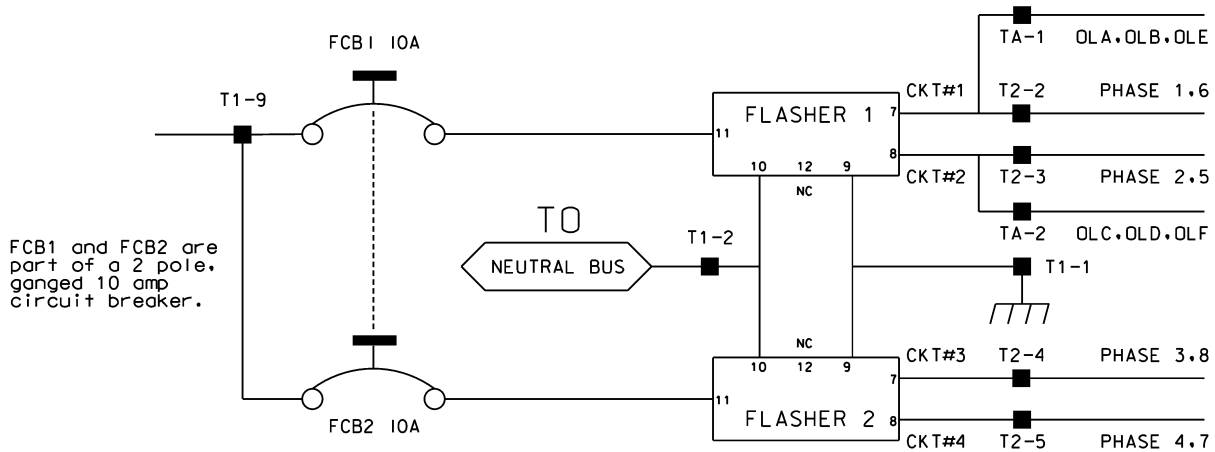

Ensure auxiliary output files are wired as follows:

AUXILIARY OUTPUT FILE TERMINAL BLOCK TA ASSIGNMENTS	
POSITION	FUNCTION
1	Flasher Unit #1, Circuit 1/FTR1 (OLA, OLB)/FTR3 (OLE)
2	Flasher Unit #1, Circuit 2/FTR2 (OLC, OLD)/FTR3 (OLF)
3	Flash Transfer Relay Coils
4	AC -
5	Power Circuit 5
6	Power Circuit 5
7	Equipment Ground Bus
8	NC

Provide four spare load resistors mounted in each cabinet. Ensure each load resistor is rated as shown in the table below. Wire one side of each load resistor to AC-. Connect the other side of each resistor to a separate terminal on a four (4) position terminal block. Mount the load resistors and terminal block either inside the back of Output File No. 1 or on the upper area of the Service Panel.

ACCEPTABLE LOAD RESISTOR VALUES	
VALUE (ohms)	WATTAGE
1.5K – 1.9 K	25W (min)
2.0K – 3.0K	10W (min)

Provide Model 200 load switches, Model 204 flashers, Model 242 DC isolators, Model 252 AC isolators, and Model 206L power supply units that conform to CALTRANS' "Transportation Electrical Equipment Specifications" dated March 12, 2009 with Erratum 1.

### C. Type 170 E Cabinet Physical Requirements

Do not mold, cast, or scribe the name "City of Los Angeles" on the outside of the cabinet door as specified in LA Specification No. 54-053-08. Do not provide a Communications Terminal Panel as specified in LA Specification No. 54-053-08. Do not provide terminal block TBB on the Service Panel. Do not provide Cabinet Verification Test Program software or associated test jigs as specified in LA Specification No. 54-053-08.

Furnish unpainted, natural, aluminum cabinet shells. Ensure that all non-aluminum hardware on the cabinet is stainless steel or a Department approved non-corrosive alternate.

Ensure the lifting eyes, gasket channels, police panel, and all supports welded to the enclosure and doors are fabricated from 0.125 inch minimum thickness aluminum sheet and meet the same standards as the cabinet and doors.

Provide front and rear doors with latching handles that allow padlocking in the closed position. Furnish 0.75 inch minimum diameter stainless steel handles with a minimum 0.5 inch shank. Place the padlocking attachment at 4.0 inches from the handle shank center to clear the lock and key. Provide an additional 4.0 inches minimum gripping length.

Provide Corbin #2 locks on the front and rear doors. Provide one (1) Corbin #2 and one (1) police master key with each cabinet. Ensure main door locks allow removal of keys in the locked position only.

Provide a surge protection panel with 16 loop surge protection devices and designed to allow sufficient free space for wire connection/disconnection and surge protection device replacement. For model 332 cabinets, provide an additional 20 loop surge protection devices. Provide an additional two AC+ interconnect surge devices to protect one slot and eight DC surge protection devices to protect four slots. Provide no protection devices on slot I14.

For pole mounted cabinets, mount surge protection devices for the AC+ interconnect inputs, inductive loop detector inputs, and low voltage DC inputs on a swing down panel assembly fabricated from sturdy aluminum. Attach the swing down panel to the bottom rear cabinet rack assembly using thumb screws. Ensure the swing down panel allows for easy removal of the input file without removing the surge protection panel assembly or its parts. Have the surge protection devices mounted horizontally on the panel and soldered to the feed through terminals of four 14 position terminal blocks with #8 screws mounted on the other side. Ensure the top row of terminals is connected to the upper slots and the bottom row of terminals is connected to the bottom slots. Provide a 15 position copper equipment ground bus attached to the field terminal side (outside) of the swing down panel for termination of loop lead-in shield grounds. Ensure that a Number 4 AWG green wire connects the surge protection panel assembly ground bus to the main cabinet equipment ground.

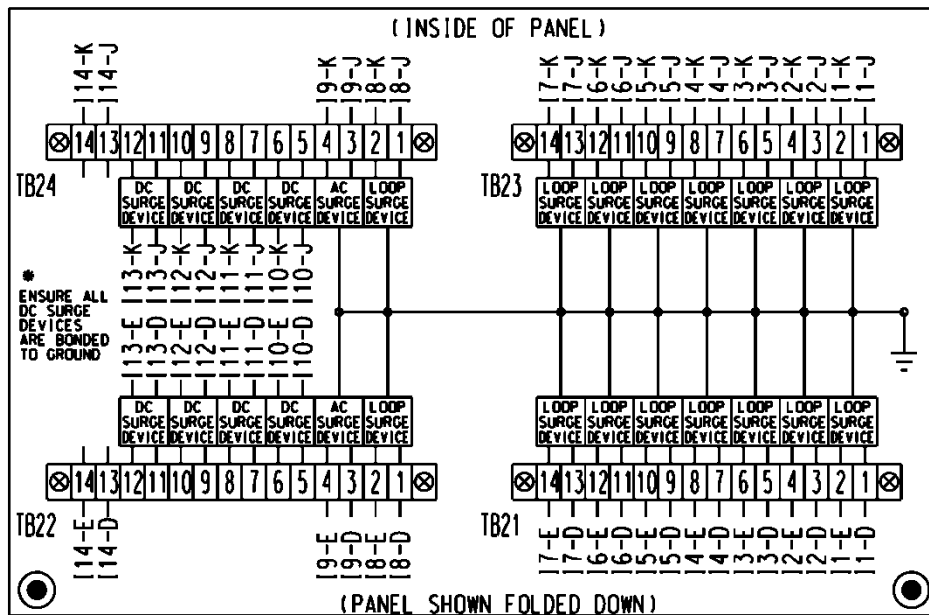
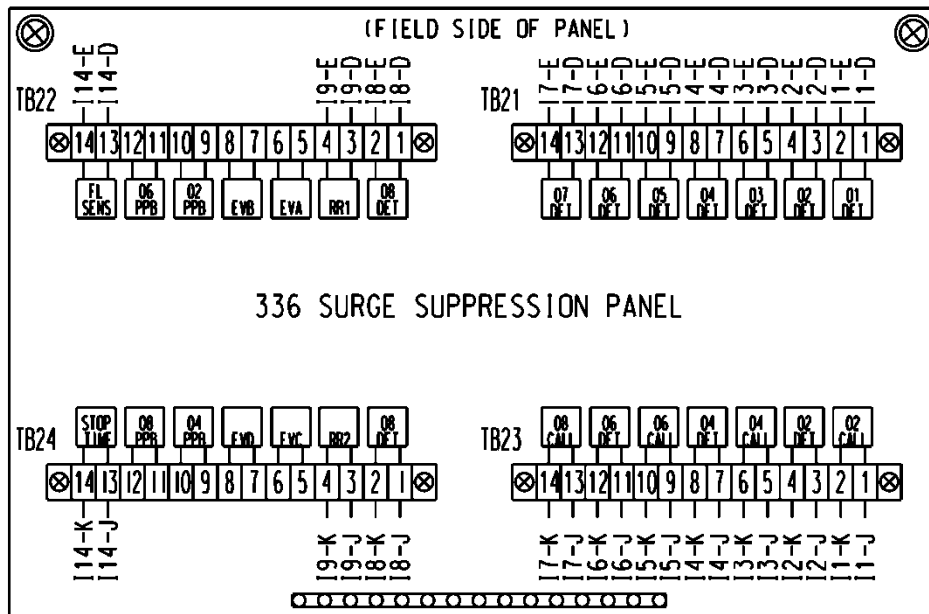

For base mounted cabinets, mount surge protection panels on the left side of the cabinet as viewed from the rear. Attach each panel to the cabinet rack assembly using bolts and make it easily removable. Mount the surge protection devices in vertical rows on each panel and connect the devices to one side of 12 position, double row terminal blocks with #8 screws. For each surge protection panel, terminate all grounds from the surge protection devices on a copper equipment



ground bus attached to the surge protection panel. Wire the terminals to the rear of a standard input file using spade lugs for input file protection.

Provide permanent labels that indicate the slot and the pins connected to each terminal that may be viewed from the rear cabinet door. Label and orient terminals so that each pair of inputs is next to each other. Indicate on the labeling the input file (I or J), the slot number (1-14) and the terminal pins of the input slots (either D & E for upper or J & K for lower).

Provide a minimum 14 x 16 inch pull out, hinged top shelf located immediately below controller mounting section of the cabinet. Ensure the shelf is designed to fully expose the table surface outside the controller at a height approximately even with the bottom of the controller. Ensure the shelf has a storage bin interior which is a minimum of 1 inch deep and approximately the same dimensions as the shelf. Provide an access to the storage area by lifting the hinged top of the shelf. Fabricate the shelf and slide from aluminum or stainless steel and ensure the assembly can support the 2070L controller plus 15 pounds of additional weight. Ensure shelf has a locking mechanism to secure it in the fully extended position and does not inhibit the removal of the 2070L controller or removal of cards inside the controller when fully extended. Provide a locking mechanism that is easily released when the shelf is to be returned to its non-use position directly under the controller.

#### **D. Model 2018 Enhanced Conflict Monitor:**

Furnish Model 2018 Enhanced Conflict Monitors that provide monitoring of 18 channels. Ensure each channel consists of a green, yellow, and red field signal input. Ensure that the conflict monitor meets or exceeds CALTRANS' Transportation Electrical Equipment Specifications dated March 12, 2009, with Erratum 1 (hereafter referred to as CALTRANS' 2009 TEES) for a model 210 monitor unit and other requirements stated in this specification.

Ensure the conflict monitor is provided with an 18 channel conflict programming card. Pin EE and Pin T of the conflict programming card shall be connected together. Pin 16 of the conflict programming card shall be floating. Ensure that the absence of the conflict programming card will cause the conflict monitor to trigger (enter into fault mode), and remain in the triggered state until the programming card is properly inserted and the conflict monitor is reset.

Provide a conflict monitor that incorporates LED indicators into the front panel to dynamically display the status of the monitor under normal conditions and to provide a comprehensive review of field inputs with monitor status under fault conditions. Ensure that the monitor indicates the channels that were active during a conflict condition and the channels that experienced a failure for all other per channel fault conditions detected. Ensure that these indications and the status of each channel are retained until the Conflict Monitor is reset. Furnish LED indicators for the following:

- AC Power (Green LED indicator)
- VDC Failed (Red LED indicator)
- WDT Error (Red LED indicator)
- Conflict (Red LED indicator)
- Red Fail (Red LED indicator)

- Dual Indication (Red LED indicator)
- Yellow/Clearance Failure (Red LED indicator)
- PCA/PC Ajar (Red LED indicator)
- Monitor Fail/Diagnostic Failure (Red LED indicator)
- 54 Channel Status Indicators (1 Red, 1 Yellow, and 1 Green LED indicator for each of the 18 channels)

Provide a switch to set the Red Fail fault timing. Ensure that when the switch is in the ON position the Red Fail fault timing value is set to 1350 +/- 150 ms (2018 mode). Ensure that when the switch is in the OFF position the Red Fail fault timing value is set to 850 +/- 150 ms (210 mode).

Provide a switch to set the Watchdog fault timing. Ensure that when the switch is in the ON position the Watchdog fault timing value is set to 1.0 +/- 0.1 s (2018 mode). Ensure that when the switch is in the OFF position the Watchdog fault timing value is set to 1.5 +/- 0.1 s (210 mode).

Provide a jumper or switch to set the AC line brown-out levels. Ensure that when the jumper is present or the switch is in the ON position the AC line dropout voltage threshold is 98 +/- 2 Vrms, the AC line restore voltage threshold is 103 +/- 2 Vrms, and the AC line brown-out timing value is set to 400 +/- 50ms (2018 mode). Ensure that when the jumper is not present or the switch is in the OFF position the AC line dropout voltage threshold is 92 +/- 2 Vrms, the AC line restore voltage threshold is 98 +/- 2 Vrms, and the AC line brown-out timing value is set to 80 +/- 17 ms (210 mode).

Provide a jumper or switch that will enable and disable the Watchdog Latch function. Ensure that when the jumper is not present or the switch is in the OFF position the Watchdog Latch function is disabled. In this mode of operation, a Watchdog fault will be reset following a power loss, brownout, or power interruption. Ensure that when the jumper is present or the switch is in the ON position the Watchdog Latch function is enabled. In this mode of operation, a Watchdog fault will be retained until a Reset command is issued.

Provide a jumper that will reverse the active polarity for pin #EE (output relay common). Ensure that when the jumper is not present pin #EE (output relay common) will be considered 'Active' at a voltage greater than 70 Vrms and 'Not Active' at a voltage less than 50 Vrms (Caltrans mode). Ensure that when the jumper is present pin #EE (output relay common) will be considered 'Active' at a voltage less than 50 Vrms and 'Not Active' at a voltage greater than 70 Vrms (Failsafe mode).

In addition to the connectors required by CALTRANS' 2009 TEES, provide the conflict monitor with a red interface connector mounted on the front of the monitor. Ensure the connector is a 20 pin, right angle, center polarized, male connector with latching clip locks and polarizing keys. Ensure the right angle solder tails are designed for a 0.062" thick printed circuit board. Keying of the connector shall be between pins 3 and 5, and between 17 and 19. Ensure the connector has two rows of pins with the odd numbered pins on one row and the even pins on the other row. Ensure the connector pin row spacing is 0.10" and pitch is 0.10". Ensure the

mating length of the connector pins is 0.24". Ensure the pins are finished with gold plating 30μ" thick.

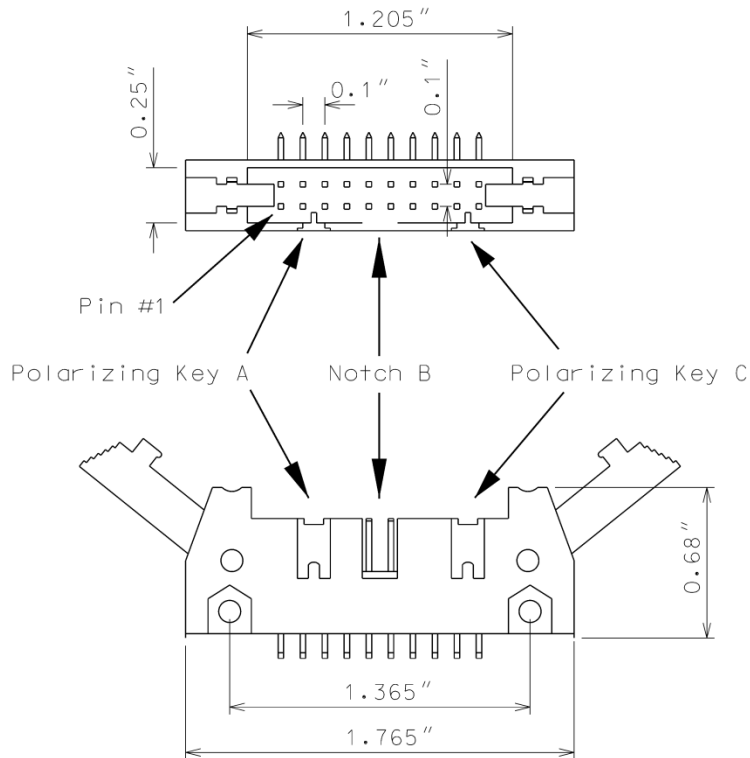

Ensure the red interface connector pins on the monitor have the following functions:

Pin #	Function	Pin #	Function
1	Channel 15 Red	2	Channel 16 Red
3	Channel 14 Red	4	Chassis Ground
5	Channel 13 Red	6	Special Function 2
7	Channel 12 Red	8	Special Function 1
9	Channel 10 Red	10	Channel 11 Red
11	Channel 9 Red	12	Channel 8 Red
13	Channel 7 Red	14	Channel 6 Red
15	Channel 5 Red	16	Channel 4 Red
17	Channel 3 Red	18	Channel 2 Red
19	Channel 1 Red	20	Red Enable

Ensure that removal of the P20 cable connector will cause the conflict monitor to recognize a latching fault condition and place the cabinet into flashing operation.

Provide Special Function 1 and Special Function 2 inputs to the unit which shall disable only Red Fail Monitoring when either input is sensed active. A Special Function input shall be sensed active when the input voltage exceeds 70 Vrms with a minimum duration of 550 ms. A Special Function input shall be sensed not active when the input voltage is less than 50 Vrms or the duration is less than 250 ms. A Special Function input is undefined by these specifications and may or may not be sensed active when the input voltage is between 50 Vrms and 70 Vrms or the duration is between 250 ms and 550 ms.

Ensure the conflict monitor recognizes field signal inputs for each channel that meet the following requirements:

- consider a Red input greater than 70 Vrms and with a duration of at least 500 ms as an “on” condition;
- consider a Red input less than 50 Vrms or with a duration of less than 200 ms as an “off” condition (no valid signal);
- consider a Red input between 50 Vrms and 70 Vrms or with a duration between 200 ms and 500 ms to be undefined by these specifications;
- consider a Green or Yellow input greater than 25 Vrms and with a duration of at least 500 ms as an “on” condition;
- consider a Green or Yellow input less than 15 Vrms or with a duration of less than 200 ms as an “off” condition; and
- consider a Green or Yellow input between 15 Vrms and 25 Vrms or with a duration between 200 ms and 500 ms to be undefined by these specifications.

Provide a conflict monitor that recognizes the faults specified by CALTRANS’ 2009 TEES and the following additional faults. Ensure the conflict monitor will trigger upon detection of a fault and will remain in the triggered (in fault mode) state until the unit is reset at the front panel or through the external remote reset input for the following failures:

1. **Red Monitoring or Absence of Any Indication (Red Failure):** A condition in which no “on” voltage signal is detected on any of the green, yellow, or red inputs to a given monitor channel. If a signal is not detected on at least one input (R, Y, or G) of a conflict monitor channel for a period greater than 1000 ms when used with a 170 controller and 1500 ms when used with a 2070 controller, ensure monitor will trigger and put the intersection into flash. If the absence of any indication condition lasts less than 700 ms when used with a 170 controller and 1200 ms when used with a 2070 controller, ensure conflict monitor will not trigger. Red fail monitoring shall be enabled on a per channel basis by the use of switches located on the conflict monitor. Have red monitoring occur when all of the following input conditions are in effect:

- a) Red Enable input to monitor is active (Red Enable voltages are “on” at greater than 70 Vrms, off at less than 50 Vrms, undefined between 50 and 70 Vrms), and
  - b) Neither Special Function 1 nor Special Function 2 inputs are active.
  - c) Pin #EE (output relay common) is not active
2. **Short/Missing Yellow Indication Fault (Clearance Error):** Yellow indication following a green is missing or shorter than 2.7 seconds (with  $\pm 0.1$ -second accuracy). If a channel fails to detect an “on” signal at the Yellow input for a minimum of 2.7 seconds ( $\pm 0.1$  second) following the detection of an “on” signal at a Green input for that channel, ensure that the monitor triggers and generates a clearance/short yellow error fault indication. Short/missing yellow (clearance) monitoring shall be enabled on a per channel basis by the use of switches located on the conflict monitor. This fault shall not occur when the channel is programmed for Yellow Inhibit, when the Red Enable signal is inactive or pin #EE (output relay common) is active.
  3. **Dual Indications on the Same Channel:** In this condition, more than one indication (R,Y,G) is detected as “on” at the same time on the same channel. If dual indications are detected for a period greater than 500 ms, ensure that the conflict monitor triggers and displays the proper failure indication (Dual Ind fault). If this condition is detected for less than 200 ms, ensure that the monitor does not trigger. G-Y-R dual indication monitoring shall be enabled on a per channel basis by the use of switches located on the conflict monitor. G-Y dual indication monitoring shall be enabled for all channels by use of a switch located on the conflict monitor. This fault shall not occur when the Red Enable signal is inactive or pin #EE (output relay common) is active.
  4. **Configuration Settings Change:** The configuration settings are comprised of (as a minimum) the permissive diode matrix, dual indication switches, yellow disable jumpers, any option switches, any option jumpers, and the Watchdog Enable switch. Ensure the conflict monitor compares the current configuration settings with the previous stored configuration settings on power-up, on reset, and periodically during operation. If any of the configuration settings are changed, ensure that the conflict monitor triggers and causes the program card indicator to flash. Ensure that configuration change faults are only reset by depressing and holding the front panel reset button for a minimum of three seconds. Ensure the external remote reset input does not reset configuration change faults.

Ensure the conflict monitor will trigger and the AC Power indicator will flash at a rate of 2 Hz  $\pm$  20% with a 50% duty cycle when the AC Line voltage falls below the “drop-out” level. Ensure the conflict monitor will resume normal operation when the AC Line voltage returns above the “restore” level. Ensure the AC Power indicator will remain illuminated when the AC voltage returns above the “restore” level. Should an AC Line power interruption occur while the monitor is in the fault mode, then upon restoration of AC Line power, the monitor will remain in the fault mode and the correct fault and channel indicators will be displayed.

Provide a flash interval of at least 6 seconds and at most 10 seconds in duration following a power-up, an AC Line interruption, or a brownout restore. Ensure the conflict monitor will suspend all fault monitoring functions, close the Output relay contacts, and flash the AC indicator at a rate of  $4 \text{ Hz} \pm 20\%$  with a 50% duty cycle during this interval. Ensure the termination of the flash interval after at least 6 seconds if the Watchdog input has made 5 transitions between the True and False state and the AC Line voltage is greater than the “restore” level. If the watchdog input has not made 5 transitions between the True and False state within  $10 \pm 0.5$  seconds, the monitor shall enter a WDT error fault condition.

Ensure the conflict monitor will monitor an intersection with a minimum of four approaches using the four-section Flashing Yellow Arrow (FYA) vehicle traffic signal as outlined by the NCHRP 3-54 research project for protected-permissive left turn signal displays. Ensure the conflict monitor will operate in the FYA mode and FYAc (Compact) mode as specified below to monitor each channel pair for the following fault conditions: Conflict, Flash Rate Detection, Red Fail, Dual Indication, and Clearance. Provide a switch to select between the FYA mode and FYAc mode. Provide a switch to select each FYA phase movement for monitoring.

#### FYA mode

FYA Signal Head	Phase 1	Phase 3	Phase 5	Phase 7
Red Arrow	Channel 9 Red	Channel 10 Red	Channel 11 Red	Channel 12 Red
Yellow Arrow	Channel 9 Yellow	Channel 10 Yellow	Channel 11 Yellow	Channel 12 Yellow
Flashing Yellow Arrow	Channel 9 Green	Channel 10 Green	Channel 11 Green	Channel 12 Green
Green Arrow	Channel 1 Green	Channel 3 Green	Channel 5 Green	Channel 7 Green

#### FYAc mode

FYA Signal Head	Phase 1	Phase 3	Phase 5	Phase 7
Red Arrow	Channel 1 Red	Channel 3 Red	Channel 5 Red	Channel 7 Red
Yellow Arrow	Channel 1 Yellow	Channel 3 Yellow	Channel 5 Yellow	Channel 7 Yellow
Flashing Yellow Arrow	Channel 1 Green	Channel 3 Green	Channel 5 Green	Channel 7 Green
Green Arrow	Channel 9 Green	Channel 9 Yellow	Channel 10 Green	Channel 10 Yellow

If a FYA channel pair is enabled for FYA operation, the conflict monitor will monitor the FYA logical channel pair for the additional following conditions:

1. **Conflict:** Channel conflicts are detected based on the permissive programming jumpers on the program card. This operation remains unchanged from normal operation except for the solid Yellow arrow (FYA clearance) signal.
2. **Yellow Change Interval Conflict:** During the Yellow change interval of the Permissive Turn channel (flashing Yellow arrow) the conflict monitor shall verify that no conflicting channels to the solid Yellow arrow channel (clearance) are active. These conflicting channels shall be determined by the program card compatibility programming of the Permissive Turn channel (flashing Yellow arrow). During the Yellow change interval of the Protected Turn channel (solid Green arrow) the conflict monitor shall verify that no conflicting channels to the solid Yellow arrow channel (clearance) are active as determined by the program card compatibility programming of the Protected Turn channel (solid Green arrow).
3. **Flash Rate Detection:** The conflict monitor unit shall monitor for the absence of a valid flash rate for the Permissive turn channel (flashing Yellow arrow). If the Permissive turn channel (flashing Yellow arrow) is active for a period greater than 1600 milliseconds, ensure the conflict monitor triggers and puts the intersection into flash. If the Permissive turn channel (flashing Yellow arrow) is active for a period less than 1400 milliseconds, ensure the conflict monitor does not trigger. Ensure the conflict monitor will remain in the triggered (in fault mode) state until the unit is reset at the front panel or through the external remote reset input. Provide a jumper or switch that will enable and disable the Flash Rate Detection function. Ensure that when the jumper is not present or the switch is in the OFF position the Flash Rate Detection function is enabled. Ensure that when the jumper is present or the switch is in the ON position the Flash Rate Detection function is disabled.
4. **Red Monitoring or Absence of Any Indication (Red Failure):** The conflict monitor unit shall detect a red failure if there is an absence of voltage on all four of the inputs of a FYA channel pair (RA, YA, FYA, GA).
5. **Dual Indications on the Same Channel:** The conflict monitor unit shall detect a dual indication if two or more inputs of a FYA channel pair (RA, YA, FYA, GA) are “on” at the same time.
6. **Short/Missing Yellow Indication Fault (Clearance Error):** The conflict monitor unit shall monitor the solid Yellow arrow for a clearance fault when terminating both the Protected Turn channel (solid Green arrow) interval and the Permissive Turn channel (flashing Yellow arrow) interval.

Ensure that the conflict monitor will log at least nine of the most recent events detected by the monitor in non-volatile EEPROM memory (or equivalent). For each event, record at a minimum the time, date, type of event, status of each field signal indication with RMS voltage, and specific channels involved with the event. Ensure the conflict monitor will log the following events: monitor reset, configuration, previous fault, and AC line. Furnish the signal sequence log that shows all channel states (Greens, Yellows, and Reds) and the Red Enable State for a

minimum of 2 seconds prior to the current fault trigger point. Ensure the display resolution of the inputs for the signal sequence log is not greater than 50 ms.

For conflict monitors used within an Ethernet communications system, provide a conflict monitor with an Ethernet 10/100 Mbps, RJ-45 port for data communication access to the monitor by a local notebook computer and remotely via a workstation or notebook computer device connected to the signal system local area network. The Ethernet port shall be electrically isolated from the conflict monitor's electronics and shall provide a minimum of 1500 Vrms isolation. Integrate monitor with Ethernet network in cabinet. Provide software to retrieve the time and date from a network server in order to synchronize the on-board times between the conflict monitor and the controller. Furnish and install the following Windows based, graphic user interface software on workstations and notebook computers where the signal system client software is installed: 1) software to view and retrieve all event log information, 2) software that will search and display a list of conflict monitor IP addresses and IDs on the network, and 3) software to change the conflict monitor's network parameters such as IP address and subnet mask.

For non-Ethernet connected monitors, provide a RS-232C/D compliant port (DB-9 female connector) on the front panel of the conflict monitor in order to provide communications from the conflict monitor to the 170/2070 controller or to a Department-furnished laptop computer. Electrically isolate the port interface electronics from all monitor electronics, excluding Chassis Ground. Ensure that the controller can receive all event log information through a controller Asynchronous Communications Interface Adapter (Type 170E) or Async Serial Comm Module (2070). Furnish and connect a serial cable from the conflict monitor's DB-9 connector to Comm Port 1 of the 2070 controller. Ensure conflict monitor communicates with the controller. Provide a Windows based graphic user interface software to communicate directly through the same monitor RS-232C/D compliant port to retrieve and view all event log information to a Department-furnished laptop computer. The RS-232C/D compliant port on the monitor shall allow the monitor to function as a DCE device with pin connections as follows:

<b>Conflict Monitor RS-232C/D (DB-9 Female) Pinout</b>		
<b>Pin Number</b>	<b>Function</b>	<b>I/O</b>
1	DCD	O
2	TX Data	O
3	RX Data	I
4	DTR	I
5	Ground	-
6	DSR	O
7	CTS	I
8	RTS	O
9	NC	-



---

**MONITOR BOARD EDGE CONNECTOR**

---

<b>Pin #</b>	<b>Function (Back Side)</b>	<b>Pin #</b>	<b>Function (Component Side)</b>
1	Channel 2 Green	A	Channel 2 Yellow
2	Channel 13 Green	B	Channel 6 Green
3	Channel 6 Yellow	C	Channel 15 Green
4	Channel 4 Green	D	Channel 4 Yellow
5	Channel 14 Green	E	Channel 8 Green
6	Channel 8 Yellow	F	Channel 16 Green
7	Channel 5 Green	H	Channel 5 Yellow
8	Channel 13 Yellow	J	Channel 1 Green
9	Channel 1 Yellow	K	Channel 15 Yellow
10	Channel 7 Green	L	Channel 7 Yellow
11	Channel 14 Yellow	M	Channel 3 Green
12	Channel 3 Yellow	N	Channel 16 Yellow
13	Channel 9 Green	P	Channel 17 Yellow
14	Channel 17 Green	R	Channel 10 Green
15	Channel 11 Yellow	S	Channel 11 Green
16	Channel 9 Yellow	T	Channel 18 Yellow
17	Channel 18 Green	U	Channel 10 Yellow
--		--	
18	Channel 12 Yellow	V	Channel 12 Green
19	Channel 17 Red	W	Channel 18 Red
20	Chassis Ground	X	Not Assigned
21	AC-	Y	DC Common
22	Watchdog Timer	Z	External Test Reset
23	+24VDC	AA	+24VDC
24	Tied to Pin 25	BB	Stop Time (Output)
25	Tied to Pin 24	CC	Not Assigned
26	Not Assigned	DD	Not Assigned
27	Relay Output, Side #3, N.O.	EE	Relay Output, Side #2, Common
28	Relay Output, Side #1, N.C.	FF	AC+

-- Slotted for keying between Pins 17/U and 18/V

---

**CONFLICT PROGRAM CARD PIN ASSIGNMENTS**

---

<b>Pin #</b>	<b>Function (Back Side)</b>	<b>Pin #</b>	<b>Function (Component Side)</b>
1	Channel 2 Green	A	Channel 1 Green
2	Channel 3 Green	B	Channel 2 Green
3	Channel 4 Green	C	Channel 3 Green
4	Channel 5 Green	D	Channel 4 Green
5	Channel 6 Green	E	Channel 5 Green
6	Channel 7 Green	F	Channel 6 Green
7	Channel 8 Green	H	Channel 7 Green
8	Channel 9 Green	J	Channel 8 Green
9	Channel 10 Green	K	Channel 9 Green
10	Channel 11 Green	L	Channel 10 Green
11	Channel 12 Green	M	Channel 11 Green
12	Channel 13 Green	N	Channel 12 Green
13	Channel 14 Green	P	Channel 13 Green
14	Channel 15 Green	R	Channel 14 Green
15	Channel 16 Green	S	Channel 15 Green
16	N/C	T	PC AJAR
17	Channel 1 Yellow	U	Channel 9 Yellow
18	Channel 2 Yellow	V	Channel 10 Yellow
19	Channel 3 Yellow	W	Channel 11 Yellow
20	Channel 4 Yellow	X	Channel 12 Yellow
21	Channel 5 Yellow	Y	Channel 13 Yellow
22	Channel 6 Yellow	Z	Channel 14 Yellow
23	Channel 7 Yellow	AA	Channel 15 Yellow
24	Channel 8 Yellow	BB	Channel 16 Yellow
--		--	
25	Channel 17 Green	CC	Channel 17 Yellow
26	Channel 18 Green	DD	Channel 18 Yellow
27	Channel 16 Green	EE	PC AJAR (Program Card)
28	Yellow Inhibit Common	FF	Channel 17 Green

-- Slotted for keying between Pins 24/BB and 25/CC

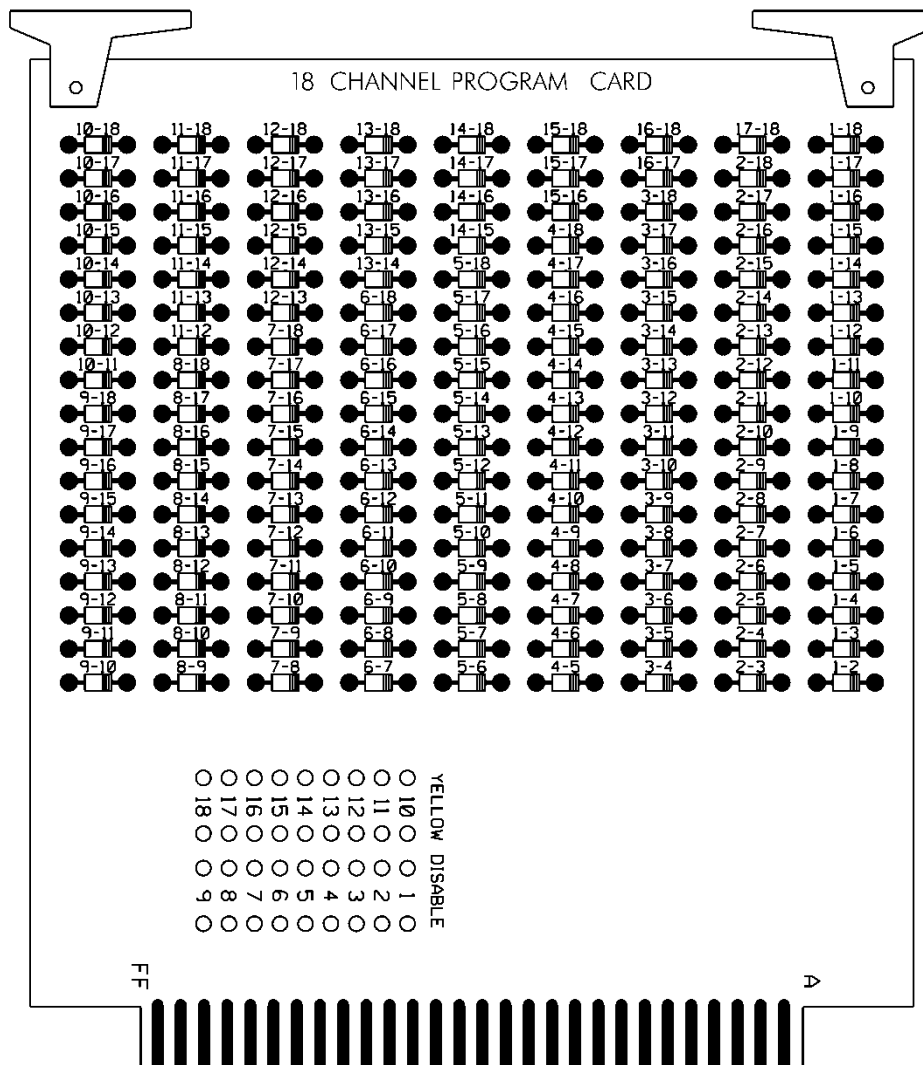

**E. Preemption and Sign Control Box**

Provide preemption and sign control box to operate in a Model 332 cabinet. Provide hardware to mount the box to the cage of the cabinet to ensure the front side is facing the opposite side of the cabinet. Furnish the material of the box from a durable finished metallic or thermoplastic case. Ensure the size of the box is not greater than 7(l) x 5(w) x 5(d) inches. Ensure that no modification is necessary to mount the box on the cabinet cage.

Provide the following components in the preemption and sign control box: relays, fuses, terminal blocks, MOVs, resistor, RC network, lamp, and push button switch.

Provide UL Listed or Recognized relay K1 as a DPDT enclosed relay (120 VAC, 60 Hz coil) with an 8-pin octal-style plug and associated octal base. Provide contact material made of AgCdO with a 10 amp, 240 VAC rating. Ensure the relay has a specified pickup voltage of 102 VAC.

Provide relay SSR1 as a Triac SPST normally open solid state relay that is rated for 120 VAC input and zero-crossing (resistive load) 25 amp @ 120 VAC output. Ensure the relay turns

on at 90 Vrms within 10 ms and turns off at 10 Vrms within 40 ms. Ensure the relay has physical characteristics as shown in the wiring detail in Figure 1. Provide 4 terminal screws with saddle clamps.

Provide fuses F1 and F2 as a UL Listed ¼" x 1-1/4" glass tube rated at 250 volts with a 10kA interrupting rating. Ensure F1 non-delay (fast-acting) and F2 slow-blow (time-delay) fuses have a maximum opening times of 60 minutes and 120 seconds for currents of 135 and 200 percent of the ampere rating, respectively. Ensure F2 slow-blow (time-delay) fuses have a minimum opening times of 12 seconds at 200 percent of the ampere rating. Provide fuse holders that are UL Recognized panel-mounted holders rated 250V, 15 ampere minimum with bayonet-type knobs which accept ¼" x 1-1/4" glass tube fuses.

Provide terminal blocks that are rated for 300V and are made of electrical grade thermoplastic or thermosetting plastic. Ensure each terminal block is of closed back design and has recessed-screw terminals with molded barriers between terminals. Ensure each terminal block is labeled with a block designation. Ensure each terminal is labeled with the function and a number.

Provide 3/4-inch diameter radial lead UL-recognized metal oxide varistors (MOVs) that have electrical performance as outlined below.

PROPERTIES OF MOV SURGE PROTECTOR	
Maximum Continuous Applied Voltage at 185° F	150 VAC (RMS) 200 VDC
Maximum Peak 8x20µs Current at 185° F	6500 A
Maximum Energy Rating at 185° F	80 J
Voltage Range 1 mA DC Test at 77° F	212-268 V
Max. Clamping Voltage 8x20µs, 100A at 77° F	395 V
Typical Capacitance (1 MHz) at 77° F	1600 pF

Provide resistor R1 as a 2K ohm, 12 watt, wirewound resistor with tinned terminals and attaching leads. Ensure the resistor is spaced apart from surrounding wires.

Provide a LED or incandescent lamp that has a voltage rating of 120 VAC with a minimum life rating at 50,000 hours.

Wire the preemption and sign control box as shown in Figure 1.

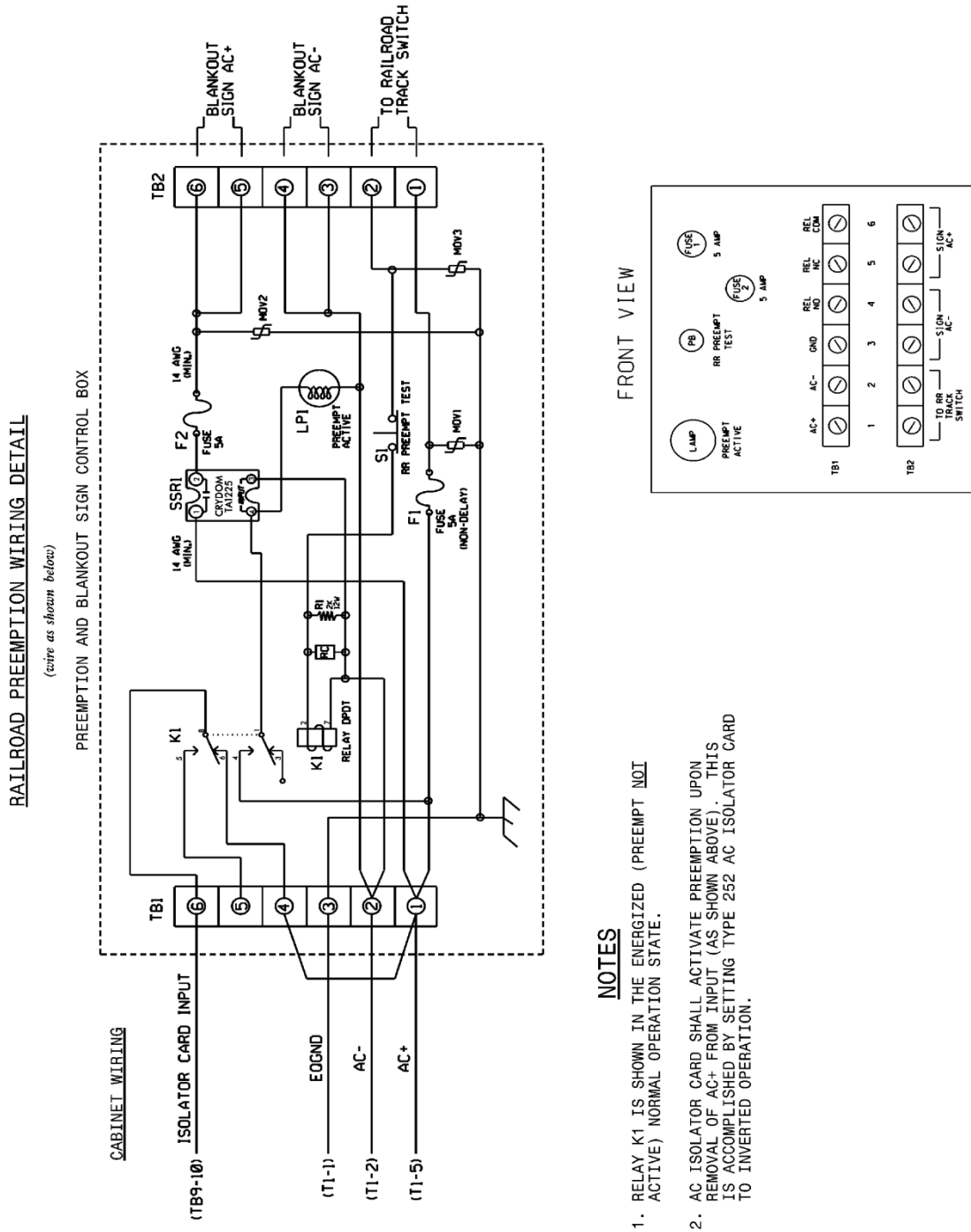

**NOTES**

1. RELAY K1 IS SHOWN IN THE ENERGIZED (PREEMPT NOT ACTIVE) NORMAL OPERATION STATE.
2. AC ISOLATOR CARD SHALL ACTIVATE PREEMPTION UPON REMOVAL OF AC+ FROM INPUT (AS SHOWN ABOVE). THIS IS ACCOMPLISHED BY SETTING TYPE 252 AC ISOLATOR CARD TO INVERTED OPERATION.

Figure 1

## 24.6. MATERIALS – TYPE 170 DETECTOR SENSOR UNITS

Furnish detector sensor units that comply with Chapter 5 Section 1, “General Requirements,” and Chapter 5 Section 2, “Model 222 & 224 Loop Detector Sensor Unit Requirements,” of the CALTRANS “Transportation Electrical Equipment Specifications” dated March 12, 2009 with Erratum 1.

## 24.7. CONSTRUCTION METHODS

### A. General

Identify and label all field wiring (e.g., signal conductors, pushbutton wires, loop detector lead-ins, etc.) in existing controller cabinets prior to disconnecting any field wiring.

Remove existing controllers and cabinets where required. Remove the maintenance diary from the existing cabinet and place it in the new cabinet. Take existing equipment out of service only at the time directed. Provide a law enforcement officer(s) to direct traffic through the signalized intersection while the signal is inoperable. Complete installation the new controller and cabinet and **restore signal operations within 3 hours** of taking the existing controller and cabinet out of service.

Turn to the next clean page (i.e., next page with no entries) in the diary and make an entry on the new page upon installation of the new controller and cabinet to document the date and time of installation. Maintain the maintenance diary and update it upon each subsequent visit to the cabinet **until final acceptance** of the project.

If the existing maintenance diary is found to be in poor condition or nearly full, notify the Engineer to have the Department provide a new diary. Upon receipt of the new maintenance diary, place the new diary inside the cabinet and give the old diary to the Engineer for return to the Department for archiving. Prior to removing the existing maintenance diary, make an entry in the old diary to document the date and time it was removed from the cabinet and turned over to the Engineer. Make the initial entry in the new maintenance diary to document the date and time of installation of the new cabinet and controller and the date the new maintenance diary was placed inside the cabinet. Maintain the maintenance diary and update it upon each subsequent visit to the cabinet until final acceptance of the project.

Locate new cabinets so as not to obstruct sight distance of vehicles turning on red.

Install controllers, cabinets, detector sensor units, and hardware that provide required phasing, color sequence, flash sequence, interconnection, railroad clearance and preemption, and emergency vehicle clearance and preemption.

Where the Plans call for using existing upstream detection loops for both local intersection and system detection (i.e., shared local/system loops), install new lead-ins and additional new detector units as required to break out the loops onto separate lead-ins and channels. Refer to the “Lead-in Cable” section of these Project Special Provisions for additional requirements concerning the proposed shared system/local detection loops.

The signal inventory number shall be placed on the both the front and rear doors of the cabinet in a minimum of 3-inch, vinyl applied characters.

Provide external electrical service disconnect, mounted independent of the cabinet, at all new and existing cabinet locations unless otherwise specified in the Plans.

Do not program controller for late night flashing operation at railroad preemption installations. For all other installations, do not program controller for late night flashing operation unless otherwise directed. Ensure all signal heads for same approach flash concurrently during flashing operation.

Provide serial number and cabinet model number for each new controller and controller cabinet installed.

Program and activate controllers with proposed phasing and timing.

Once all new cables have been installed in and existing cables, where applicable, have been removed from base-mounted cabinets, seal all conduits entering the cabinet base as follows:

- Seal spare conduits with approved conduit plugs.
- Seal conduits containing fiber-optic communications cable with duct and conduit sealer.
- Seal conduits containing signal cable, and loop lead-in wire with duct and conduit sealer.

Seal existing conduits as well as new conduits, regardless of whether cables are being removed from or installed in them. Comply with the requirements for conduit plugs and duct and conduit sealer in the “Underground Conduit” section of these Project Special Provisions.

### **B. Electrical Service and Grounding**

Where electrical services do not include an external electrical service disconnect, modify or replace the electrical service as shown in the Plans to add an electrical service disconnect and a new grounding electrode system.

Furnish and install a grounding electrode system at all new electrical services.

Comply with all requirements of the “Electrical Service” section of these Project Special Provisions.

### **C. Edge Switch**

Install and program the Ethernet edge switches in accordance with the “Communications Hardware” section of these Project Special Provisions.

### **D. Workshop**

Provide enclosed workshop to set up and test new controllers and cabinets before installation. Locate workshop within the Division responsible for project administration. Ensure workshop provides protection from weather and sufficient space to house two test observers, all necessary test equipment and material, controllers and cabinets.

Configure and test each controller and cabinet to match the proposed signal design. Ensure all equipment furnished and installed or modified by the Contractor at each location operates in full compliance with the Plans and Project Special Provisions. Test each controller and cabinet for proper color sequence, flashing operation, phase timings, preemption, coordination, and conflict monitor programming. Ensure that simultaneous conflicting phase outputs will cause the cabinet to revert to flashing operation. For intersections with any type of preemption, submit a completed Preemption Test Procedure Checklist. The checklist is located on the Department’s Website.

Test the cabinet and controller for eight hours minimum. Following this test, and before installation, the Engineer will inspect the equipment in operation. The Engineer may require other tests to ensure proper operation. These tests shall be at no additional cost to the Department.

#### **E. GPS Coordinates**

Refer to the following subsections of these Project Special Provisions:

- the “GPS Coordinates” subsection of the “Junction Boxes” section.

#### **24.8. MEASUREMENT AND PAYMENT**

*Controller with cabinet with aux file (\_\_\_\_\_)* will be measured and paid as the actual number of each type of controllers with cabinets equipped with auxiliary output files of each type and mounting method that are furnished, installed, and accepted, subject to the following conditions: 70% of the payment will be made upon acceptance of the unit; 30% of the payment will be made following final acceptance of the integrated system (including completion of the 60-day observation period). ). The cost of installation of the firmware will be included in the cost of the controller installation.

No measurement will be made of conflict monitors, grounding systems, modems and workshop as these will be considered incidental to furnishing and installing controllers with cabinets and aux files.

No measurement will be made of aluminum plates furnished and installed to fill gaps between the opening of a cabinet base extender and the edge of smaller existing cabinet foundations when required as such work will be considered incidental to furnishing and installing controllers with cabinets.

New and modified electrical services and electrical service grounding systems will be measured and paid for in accordance with the “Electrical Service” section of these Project Special Provisions.

*Detector card (Model 222)* will be measured and paid as the actual number of Model 222 detector cards furnished, installed, and accepted.

Ethernet edge switches will be measured and paid for in accordance with the “Communications Hardware” section of these Project Special Provisions.

Lead-in cable will be measured and paid for in accordance with the “Lead-in Cable” section of these Project Special Provisions.

No measurement or payment will be made of any hardware and fasteners required for mounting controller cabinets to foundations as these items will be considered incidental to installing controllers with cabinets.

No measurement or payment will be made of sealing conduits with duct plugs, duct and conduit sealer (i.e. moldable duct seal) as such work will be considered incidental to furnishing and installing controllers with cabinets.

No measurement will be made of collecting and recording GPS coordinates for controller cabinets and junction boxes, compiling this data in the prescribed Microsoft Excel® spreadsheet



and providing an ESRI Shapefile (.SHP file format) as such work will be considered incidental installing controllers with cabinets and installing controllers.

Payment will be made under:

<b>Pay Item</b>	<b>Pay Unit</b>
Controller with Cabinet with Aux File (2070LX, 332)	Each
Detector Card (Model 222)	Each

## 25. RELOCATE EXISTING CABINET EQUIPMENT

### 25.1. DESCRIPTION

Relocate existing equipment from existing signal cabinets for re-use. Existing equipment may be for wireless detection, vehicle preemption and/or bridge preemption. See notes on signal plans.

### 25.2. CONSTRUCTION METHODS

As directed by the Plans, relocate existing equipment from existing signal cabinets for re-use. Comply with the “Construction Methods” subsection of the “Controllers with Cabinets” section of these Project Special Provisions. Install all relocated equipment per manufacturer’s recommendations.

### 25.3. MEASUREMENT AND PAYMENT

*Relocate existing cabinet equipment* will be measured and paid as the actual number of existing cabinets where equipment, regardless of type, was relocated, integrated and accepted.

Payment will be made under:

<b>Pay Item</b>	<b>Pay Unit</b>
Relocate Existing Cabinet Equipment	Each

**26. CABINET BASE ADAPTER/BASE EXTENDER**

**26.1. DESCRIPTION**

Furnish and install cabinet base extenders with all necessary hardware for Type170 cabinets.

**26.2. MATERIALS**

Fabricate base extenders from the same materials and with the same finish as cabinet housing. Fabricate base adapter and extender in the same manner as controller cabinets, meeting all applicable specifications called for in CALTRANS TEES. Provide base adapters and extenders that have a minimum height of 12". Provide cabinet base adapters that comply with the details shown in the Plans.

Furnish material, equipment and hardware under this section that is pre-approved on the ITS and Signals QPL.

**26.3. CONSTRUCTION METHODS**

**A. General**

Unless otherwise shown in the Plans, install a cabinet base extender at locations requiring a new Model 332 cabinet on an existing/modified or new foundation.

Use permanent, flexible waterproof sealing material to:

- Seal between cabinet base and cabinet base adapter/extender,
- Seal 2-piece cabinet base adapter/extender seams, and
- Seal space between cabinet base adapter/extender and foundation.

**26.4. MEASUREMENT AND PAYMENT**

*Cabinet base extender* will be measured and paid as the actual number furnished, installed, and accepted.

Payment will be made under:

<b>Pay Item</b>	<b>Pay Unit</b>
Cabinet Base Extender	Each

## 27. ELECTRICAL SERVICE

### 27.1. DESCRIPTION

At locations called out in the Plans, install a new electrical service and modify an existing electrical service, including an external disconnect and meter base.

Comply with the National Electrical Code (NEC), the National Electrical Safety Code (NESC), the *Standard Specifications*, these Project Special Provisions, and all local ordinances. Coordinate all work involving electrical service with the appropriate utility company and the Engineer.

### 27.2. MATERIALS

#### A. Electrical Service

Provide material, equipment and hardware under this section that is pre-approved on the 2018 ITS and Signals QPL by the date of equipment installation.

Provide, modify and/or upgrade all materials necessary to form a complete electrical service assembly as shown in the Plans. Furnish new external electrical service disconnects, meter bases, and required grounding. Replace electrical service feeder conductors and conduits between the meter bases, disconnects and the controller cabinets as required.

Provide external electrical service disconnects at all new and existing cabinet locations unless otherwise specified in the Plans. Where electrical services do not include an external electrical service disconnect, modify service to include electrical service disconnect and a new grounding electrode system.

Provide all electrical service disconnects with a space/expansion slots, covered by a knockout or removable blank cover, designed to allow the future installation of at least one additional circuit breaker.

Furnish external electrical service disconnects with a single pole 50 A inverse time circuit breaker with at least 10,000 RMS symmetrical amperes short circuit current rating in a lockable NEMA 3R enclosure.

Obtain the maximum available ground fault current from the utility company. Print this information on durable label and adhere to the dead front of the disconnect. Submit sample label to Engineer for approval.

Ensure service disconnects are listed as meeting UL Standard UL-489 and marked as being suitable for use as service equipment. Fabricate enclosure from galvanized steel. Provide ground bus and neutral bus with a minimum of four terminals with minimum wire capacity range of number 14 through number 4 AWG.

Furnish NEMA Type 3R meter base rated 100A minimum for overhead service and 200A minimum for underground service and that meets the requirements of the local utility. Provide meter base with ampere rating of meter sockets based on sockets being wired with insulated wire rated at least 167°. With each meter base, provide a blank meter socket cover made from UV stabilized polycarbonate or metal and that is either clear or gray in color to prevent access to interior of meter base until meter is installed by the local power company.

Furnish 4 terminal, 600 volt, single phase, 3 wire meter base that complies with the following:

- Line, Load, and Neutral Terminals accept #8 to 2/0 AWG copper/aluminum wire;
- Ringed or Ringless Type, with or without bypass;
- Made of galvanized steel;
- Listed as meeting UL Standard UL-414; and
- Overhead or underground service entrance as specified.

Provide meter bases and disconnect panels or combination panel enclosures and pedestals with electrostatically applied dry powder paint finish with minimum thickness of 2.4 mils and that is light gray in color. All exterior surfaces must be powder coated steel.

Furnish 3-wire stranded #8 AWG copper feeder conductors with THWN rating for supplying power to signal equipment cabinets. Provide conductors with black, white, and green insulation that are intended for power circuits at 600 V or less and comply with the following:

- Listed as meeting UL Standard UL-83
- Meets ASTM B-3 and B-8 or B-787 standards.

Furnish 1" rigid galvanized conduit between the disconnect and the signal cabinets as required. For underground runs greater than 10 feet in length, the Contractor may transition from 1" rigid galvanized conduit to 1" PVC conduit for the remainder of the underground run beyond the initial 10 feet. Furnish Schedule 40 PVC female adapters to connect the PVC conduit to the threaded end of the rigid galvanized conduit. The interior surface of one end of the PVC female adapter shall be compatibly threaded to connect it to the threaded end of the rigid metallic riser without the aid of additional fittings, hardware or adhesives. The opposite end of the adapter shall be non-threaded to permit a slip fit, glued connection to the underground PVC conduit.

Furnish 1" watertight hub (i.e., meter socket hub) for threaded rigid galvanized conduit with meter base.

If meter base and electrical service disconnect are supplied in the same enclosure (i.e., combination panel), ensure assembly is marked as being suitable for use as service equipment. Ensure combination meter and disconnect mounted in a pedestal for underground service is listed as meeting UL Standard UL-231. Otherwise, ensure combination meter and disconnect is listed as meeting UL Standard UL-67.

Provide a grounding electrode system at all new electrical services. Provide underground marker tape above grounding electrodes and buried ground wire. Provide all grounding electrodes and ground wire necessary to ensure that grounding system, whether existing or new, complies with all grounding requirements of these Project Special Provisions.

Where the Plans call for modifying an existing electrical service for a traffic signal, provide circuit breaker, services conductors, and/or grounding materials that are equivalent with materials supplied for new electrical service.

### **B. Grounding Electrodes**

Provide grounding electrodes of the following types as indicated in these Project Special Provisions and on the Plans.

**1. Ground Rods**

Provide 5/8 inch diameter, 10-foot long, copper-clad steel ground rods with 10 mil thick copper cladding.

**2. Sectional Ground Rods**

Provide sectional ground rods comprised of 5/8 inch diameter, 10-foot long, steel ground rods with 10 mil thick copper cladding, with irreversible compression couplers. As an alternative, provide UL listed bronze couplers designed to connect 5/8 inch diameter copper-clad steel rods. Do not use threaded ground rods or threaded couplers. Provide minimum lengths required by the Plans.

**C. Grounding System**

Furnish 5/8"x10' copper clad steel grounding electrodes (ground rods), #4 AWG solid bare copper conductors, and irreversible compression couplers kits for grounding system installations. Comply with the NEC, the *Standard Specifications*, these Project Special Provisions and the Plans.

**27.3. CONSTRUCTION METHODS****A. General**

**When inspections of the electrical service is necessary, the Contractor shall be responsible for coordinating with the utility companies and inspectors to schedule the inspection and all work associated with the electrical inspection.**

All work involving electrical service shall be coordinated with the appropriate electric utility company. Coordinate with the utility company to ascertain the feasibility of installing electrical service at each location before performing any work. Obtain all required local permits before beginning work.

Run feeder conductors separately from all other conductors in a 1-inch rigid galvanized conduit. Do not allow feeder conductors to share conduits with any other conductors or cables. Do not route unfused electrical feeder conductors inside of metal poles. Permanently label conductors at all access points using nylon tags labeled with permanent ink. Ensure each conductor has a unique identifier. Label conductors immediately upon installation. Use component name and labeling scheme approved by the Engineer.

Use rigid galvanized conduit for all underground conduit runs 10 feet or less in length. For underground runs greater than 10 feet in length, the Contractor may transition from 1" rigid galvanized conduit to 1" PVC conduit for the remainder of the run beyond the initial 10 feet using an approved PVC female adapter. Apply thread seal tape to the threads of the rigid galvanized conduit before screwing the PVC adapter onto the threaded male end of the conduit. Connect the threaded female end of the PVC adapter to the threaded end of the rigid galvanized conduit, then connect the not threaded end of the adapter to the PVC conduit using a slip fit, glued connection.

Direct bury pedestals that support combination panel at a minimum embedment depth of 24 inches below grade.

Install a 6" x 6" treated wood post a minimum of 3 feet into the ground and mount the electrical service equipment on the wood post.

Upon completion of electrical service installation and backfilling of all excavations, restore the disturbed ground to its original condition as determined and approved by the Engineer. For paved areas, replace removed or damaged pavement with in kind materials, matching the elevation, color, texture/finish and general appearance of the surrounding pavement in accordance with the "Signal Cabinet Foundation" section of these Project Special Provisions. Refer to Section 1 of these Project Special Provisions for additional requirements concerning sidewalks and curbs in historic districts. For unpaved areas, backfill excavations with removed material, tamp the backfilled material and rake smooth the top 1½ inches. Finish unpaved areas flush with surrounding natural ground and to match the original contour of the ground. Seed with same type of grass as surrounding area and mulch the newly seeded area. If unpaved area was not grassed, replace the original ground cover in kind as directed by the Engineer.

Complete repairs to and restoration of all ground (paved and unpaved) disturbed for construction within five consecutive calendar days following initial removal. If the Contractor fails to repair and restore the ground in accordance with these Project Special Provisions within the time frame specified, the Department reserves the right to make the necessary repairs, and all expenses incurred by the Department in making the repairs and restoring the ground will be deducted from payment due the Contractor, plus **\$500 liquidated damages per occasion**, per day, or any portion thereof, until corrected.

Install meter socket covers on new meter bases to block access to the wiring inside until the meter is attached to the meter base by the power company. Use only approved meter socket covers that comply with these Project Special Provisions; do not use cardboard, paper, plywood, sheet plastic, tape, etc. to cover the meter socket opening. Do not leave a meter socket uncovered.

Provide all necessary stainless steel banding hardware and clamps for securely attaching service disconnects, meter bases, combination panels and service conduits and risers to metal poles.

### **B. New Electrical Service for Traffic Signal**

At locations identified in the Plans, install new electrical service for a traffic signal controller cabinet. Comply with *Roadway Standard Drawing* Nos. 1700.01 and 1700.02 as well as the special detail entitled "Ground Mounted Electrical Service Detail" provided in the Plans.

Install a new electrical service comprised of an external service disconnect as well as a meter base with meter socket cover. After installation of the meter base with meter socket cover, the local power company will remove the meter socket cover and transfer the existing meter or install a new meter and make any necessary connections to the power lines.

For locations that have existing PVC service risers, replace the existing electrical service with a new electrical service that has a rigid galvanized riser, as described above.

### **C. Modify Existing Electrical Service**

At locations shown in the Plans, modify an existing electrical service by one of more of the following methods:

- Replace the existing feeder conductors between the existing meter base and the traffic signal controller cabinet with new feeder conductors.

- Replace existing conduit route and feeder conductors between the existing disconnect and a new traffic signal controller cabinet with new conduit and new feeder cables.
- Replace the existing breaker in the disconnect with a new breaker. Ensure wiring is compliant for use with updated breaker, including wiring between meter base and disconnect.
- Install a new grounding system.

Test the grounding system of the modified electrical service as required to ensure that grounding system complies with the grounding requirements for electrical service in these Project Special Provisions.

#### **D. Grounding of Electrical Services**

In addition to NEC requirements, test grounding electrode resistance for a maximum of 20 ohms. Furnish and install additional ground rods to grounding electrode system as necessary to meet test requirements. Furnish 5/8" x 10' copper clad steel grounding electrode system (ground rods), #4 AWG solid bare copper conductors, and irreversible compression couplers kits for grounding system installations. Comply with NEC, the *Standard Specifications*, these Project Special Provisions and the Plans.

Modify existing electrical services, as necessary, to meet the grounding requirements of the NEC, these Project Special Provisions and the Plans. Remove any ground rods in the cabinet foundation and install a new grounding electrode system. Cut off abandoned ground rods in the cabinet foundation flush with the foundation surface. Where a grounding electrode system is connected to the electrical service in accordance with the NEC, test grounding electrode resistance for a maximum of 20 ohms. Grounding electrode resistance test must be verified or witnessed by the Engineer or the Engineer's designated representative. Furnish and install additional ground rods to grounding electrode system as necessary to meet the requirements of these Project Special Provisions and test requirements.

Follow test equipment's procedures for measuring grounding electrode resistance. When using clamp-type ground resistance meters, readings of less than 1 ohm typically indicate a ground loop. Rework bonding and grounding circuits as necessary to remove ground loop circuits and retest. If a ground loop cannot be identified and removed to allow the proper use of a clamp-type ground resistance meter, use the three-point test method.

Submit a completed Inductive Loop & Grounding Test Form available on the Department's website at:

<https://connect.ncdot.gov/resources/safety/Pages/ITS-and-Signals.aspx>

Install a length of marker tape 12 inches below finished grade directly over grounding electrodes and conductors.

For locations in downtown Elizabeth City where there is insufficient or no available unpaved areas within the existing right-of-way and grounding electrodes, therefore, must be installed beneath existing sidewalk, replace all sidewalk removed to install the grounding electrodes with in-kind materials in accordance with the requirements for the same in the "Ground Surface



Restoration” subsection of the “Signal Cabinet Foundations” section of these Project Special Provisions.

#### **27.4. MEASUREMENT AND PAYMENT**

*New electrical service* will be measured and paid for as the actual number of complete, functional electrical service locations furnished, installed and tested.

No measurement will be made of risers with weatherheads for electrical service as they will be considered incidental to furnishing and installing a new electrical service.

No measurement will be made of short risers (i.e., from disconnect to underground conduit and from underground conduit to bottom of cabinet), meter bases, meter socket covers, service disconnects, additional circuit breakers in new service disconnects where required, underground conduit runs less than 10 feet between service risers and disconnects/meters, conduit for feeder conductors between the service disconnect and the signal cabinet, PVC female adapters, acquisition of service fees, service entrance conductors between top of riser and disconnect of an overhead electrical services assembly, feeder conductors between the disconnect and signal cabinet, ground wire, and any remaining hardware and conduit to connect the electrical service to the cabinet as they will be considered incidental to furnishing and installing new electrical service.

*Modify existing electrical service* will be measured and paid for as the actual number of existing electrical service locations that have been modified, without regards to the type of modification, tested and accepted. Modification can include, but is not limited to, replacing the existing feeder conductors with new conductors between the meter base and the controller cabinet as shown in the Plans, installing new service conductors in new conduit to a new cabinet location, by replacing the breaker and associated wiring if necessary, in the existing disconnect or by installing a new grounding system. No measurement will be made of electrical service feeder conductors and ground wire as such work is considered incidental to modifying an existing electrical service.

No measurement will be made for grounding systems for electrical service as they will be considered incidental to furnish and installing a new electrical service or the modification of electrical service. No separate payment will be made for ground rodes, #4 AWG solid bare copper grounding conductors or irreversible compression couplers kits as they will be considered incidental to furnishing and installing the new or modified electrical service

Restoration (repair and replacement) of sidewalk that is removed to install grounding systems and to install underground conduit between a new electrical service and a signal cabinet will be measured and paid for in accordance with the “Signal Cabinet Foundations” section of these Project Special Provisions.

No measurement will be made of combination panel with pedestal extension and 6” x 6” wood posts installed for mounting new underground electrical services as they will be considered incidental to furnishing and installing the new electrical service.

No measurement will be made of restoration of unpaved ground surfaces with like materials, including but not limited to backfill, graded stone, seeding and mulching, as this work will be considered incidental to installation of a new electrical service.

No payment will be made for new electrical service until all repairs to paved and unpaved surfaces damaged/disturbed during the installation the electrical service have been completed and accepted.

Payment will be made under:

<b>Pay Item</b>	<b>Pay Unit</b>
New Electrical Service	Each
Modify Existing Electrical Service	Each

28. TRAFFIC SIGNAL SUPPORTS

28.1. METAL TRAFFIC SIGNAL SUPPORTS – ALL POLES

A. General:

Furnish and install metal strain poles, grounding systems, and all necessary hardware. The work covered by this special provision includes requirements for the design, fabrication, and installation of both standard and custom/site specifically designed metal traffic signal supports and associated foundations.

Provide metal traffic signal support systems that contain no guy assemblies, struts, or stay braces. Provide designs of completed assemblies with hardware that equals or exceeds AASHTO *Standard Specifications for Structural Supports for Highway Signs, Luminaires and Traffic Signals* 6<sup>th</sup> Edition, 2013 (hereafter called 6<sup>th</sup> Edition AASHTO), including the latest interim specifications. Provide assemblies with a round or near-round (18 sides or more) cross-section, or a multi sided cross section with no less than six sides. The sides may be straight, convex, or concave.

Pole heights shown on signal plans are estimated from available data for bid purposes. Prior to furnishing metal signal poles, use field measurements and adjusted cross-sections to determine whether pole heights are sufficient to obtain required clearances. If pole heights are not sufficient, the Contractor should immediately notify the Engineer of the required revised pole heights.

Ensure that metal signal poles permit cables to be installed inside poles and any required mast arms. For holes in the poles and arms used to accommodate cables, provide full-circumference grommets. Arm flange plate wire access holes should be deburred, non grommeted, and oversized to fit around the 2” diameter grommeted shaft flange plate wire access hole.

After fabrication, have steel poles, and all parts used in the assembly hot-dip galvanized per section 1076. Design structural assemblies with weep holes large enough and properly located to drain molten zinc during the galvanization process. Provide hot-dip galvanizing on structures that meets or exceeds ASTM Standard A-123. Provide galvanizing on hardware that meets or exceeds ASTM Standard A-153. Ensure that threaded material is brushed and retapped as necessary after galvanizing. Perform repair of damaged galvanizing that complies with the following:

Repair of Galvanizing .....Article 1076-7

Standard Drawings for Metal Poles are available that supplement these project special provisions. These drawings are located on the Department’s website:

<https://connect.ncdot.gov/resources/safety/pages/ITS-Design-Resources.aspx>

Comply with article 1098-1B of the 2018 *STANDARD SPECIFICATIONS FOR ROADS & STRUCTURES*, hereinafter referred to as the *Standard Specifications* for submittal requirements. Furnish shop drawings for approval. Provide the copies of detailed shop drawings for each type of structure as summarized below. Ensure that shop drawings include material specifications for each component and identify welds by type and size on the detail drawing only, not in table format. **Do not release structures for fabrication until shop drawings have been approved by NCDOT.** Provide an itemized bill of materials for all structural components and associated connecting hardware on the drawings.

Comply with article 1098-1A of the *Standard Specifications* for Qualified Products List (QPL) submittals. All shop drawings must include project location description, signal inventory number(s) and a project number or work order number on the drawings.

Summary of information required for metal pole review submittal:

Item	Hardcopy Submittal	Electronic Submittal	Comments / Special Instructions
Sealed, Approved Signal Plan/Loading Diagram	1	1	All structure design information needs to reflect the latest approved signal plans
Custom Pole Shop Drawings	4 sets	1 set	Show NCDOT inventory number(s), contractor's name and relevant revision number in the title block. All drawings must have a unique <u>drawing</u> number for each project and identified for multiple pages.
Standard Pole Shop Drawings (from the QPL)	4 sets	1 set	Submit drawings on 11" x 17" format media. Show NCDOT inventory number(s), contractor's name and relevant revision number in the title block. All drawings must have a <u>unique drawing</u> number for each project and identified for multiple pages.
Structure Calculations	1 set	1 set	Not required for Standard QPL Poles
Standard Pole Foundation Drawings	1 set	1 set	Submit drawings on 11" x 17" format media. Submit a completed Standard Foundation Selection form for each pole using foundation table on Metal Pole Drawing M-8.
Custom Foundation Drawings	4 sets	1 set	Submit drawings on 11" x 17" format media. Show NCDOT inventory number(s), contractor's name and relevant revision number in the title block. All drawings must have a <u>unique drawing</u> number for each project and identified for multiple pages.  If QPL Poles are used, include the corresponding QPL pole shop drawings with this submittal.
Foundation Calculations	1	1	<b>Submit copies of LPILE input, output and pile tip deflection graph per Section 11.4 of this specification for each foundation.</b>  Not required for Standard QPL Poles
Soil Boring Logs and Report	1	1	Report should include a location plan and a soil classification report including soil capacity, water level, hammer efficiency, soil bearing pressure, soil density, etc. for each pole.

**NOTE** – All shop drawings and custom foundation design drawings must be sealed by a Professional Engineer licensed in the state of North Carolina. All geotechnical information must

be sealed by either a Professional Engineer or geologist licensed in the state of North Carolina. Include a title block and revision block on the shop drawings and foundation drawings showing the NCDOT inventory number.

**Shop drawings and foundation drawings may be submitted together or separately for approval. However, shop drawings must be approved before foundations can be reviewed.** Foundation designs will be returned without review if the associated shop drawing has not been approved. Boring reports should include the following: Engineer's summary, boring location maps, soil classification per AASHTO Classification System, hammer efficiency, and Metal Pole Standard Foundation Selection Form. Incomplete submittals will be returned without review. The Reviewer has the right to request additional analysis and copies of the calculations to expedite the approval process.

#### **B. Materials:**

Fabricate metal pole and arm shaft from coil or plate steel to meet the requirements of ASTM A 595 Grade A tubes. For structural steel shapes, plates and bars use A572 Gr 50 min or ASTM A709 Gr 50 min. Provide pole and arm shafts that are round in cross section or multisided tubular shapes and have a uniform linear taper of 0.14 in/ft. Construct shafts from one piece of single ply plate or coil so there are no circumferential weld splices. Galvanize in accordance with AASHTO M 111 or an approved equivalent.

Use the submerged arc process or other NCDOT previously approved process suitable for pole shaft and arms to continuously weld pole shafts and arm shafts along their entire length. The longitudinal seam weld will be finished flush to the outside contour of the base metal. Ensure shafts have no circumferential welds except at the lower end joining the shaft to the pole base and arm base. Use full penetration groove welds with backing ring for all tube-to-transverse-plate connections in accordance with 6<sup>th</sup> Edition AASHTO. Provide welding that conforms to Article 1072-18 of the *Standard Specifications*, except that no field welding on any part of the pole will be permitted unless approved by a qualified engineer.

Refer to Metal Pole Standard Drawing Sheets M2 through M5 for fabrication details. Fabricate anchor bases and mast arm connecting plates from plate steel meeting, as a minimum, the requirements of ASTM A572 Gr 50, AASHTO M270 Gr 50, ASTM A709 Gr50, or an approved equivalent. Conform to the applicable bolt pattern and orientation as shown on Metal Pole Standard Drawing Sheet M2.

Ensure all hardware is galvanized steel or stainless steel. The Contractor is responsible for ensuring that the designer/fabricator specifies connecting hardware and/or materials that do not create a dissimilar metal corrosive reaction.

Provide a minimum of four (4) 1-1/2" diameter high strength bolts for connection between arm plate and pole plate. Increase number of bolts to six (6) 1-1/2" diameter high strength bolts when arm lengths are greater than 50'-0" long.

Unless otherwise required by the design, ensure each anchor rod is 2" diameter and 60" length. Provide 10" minimum thread projection at the top of the rod, and 8" minimum at the bottom of the rod. Use anchor rod assembly and drilled pier foundation materials that meet the *Foundations and Anchor Rod Assemblies for Metal Poles* provision.

For each structural bolt and other steel hardware, hot dip galvanizing shall conform to the requirements of AASHTO M 232 (ASTM A 153). Ensure end caps for poles or mast arms are constructed of cast aluminum conforming to Aluminum Alloy 356.0F.

Provide a circular anchor bolt lock plate that will be secured to the anchor bolts at the embedded end with 2 washers and 2 nuts. Provide a base plate template that matches the bolt circle diameter of the anchor bolt lock plate. Construct plates and templates from 1/4" minimum thick steel with a minimum width of 4". Galvanizing is not required for both plates.

Provide 4 heavy hex nuts and 4 flat washers for each anchor bolt. For nuts, use AASHTO M291 grade 2H, DH, or DH3 or equivalent material. For flat washers, use AASHTO M293 or equivalent material.

### **C. Construction Methods:**

Erect signal support poles only after concrete has attained a minimum allowable compressive strength of 3000 psi. Install anchor rod assemblies in accordance with the *Foundations and Anchor Rod Assemblies for Metal Poles* provision.

For further construction methods, see construction methods for Metal Strain Pole.

Connect poles to grounding electrodes and bond them to the electrical service grounding electrodes.

For holes in the poles used to accommodate cables, install grommets before wiring pole or arm. Do not cut or split grommets.

Attach the terminal compartment cover to the pole by a sturdy chain or cable. Ensure the chain or cable is long enough to permit the cover to hang clear of the compartment opening when the cover is removed, and is strong enough to prevent vandalism. Ensure the chain or cable will not interfere with service to the cables in the pole base.

Attach cap to pole with a sturdy chain or cable. Ensure the chain or cable is long enough to permit the cap to hang clear of the opening when the cap is removed.

Perform repair of damaged galvanizing that complies with the *Standard Specifications*, Article 1076-7 "Repair of Galvanizing."

Install galvanized wire mesh around the perimeter of the base plate to cover the gap between the base plate and top of foundation for debris and pest control.

Install a 1/4" thick plate for concrete foundation tag to include: concrete grade, depth, diameter, and reinforcement sizes of the installed foundation.

## **28.2. METAL POLE UPRIGHTS (VERTICAL MEMBERS)**

### **A. Materials:**

- Provide tapered tubular shafts and fabricated of steel conforming to ASTM A-595 Grade A or an approved equivalent.
- Hot-dip galvanize poles in accordance with AASHTO M 111 or an approved equivalent.
- Have shafts that are continuously welded for the entire length by the submerged arc process, and with exposed welds ground or rolled smooth and flush with the base metal.

Provide welding that conforms to Article 1072-18 of the *Standard Specification* except that no field welding on any part of the pole will be permitted.

- Have Shafts with no circumferential welds except at the lower end joining the shaft to the base.
- Have anchor bases for steel poles fabricated from plate steel meeting as a minimum the requirements of ASTM A572 Gr 50, AASHTO M270 Gr 50, ASTM A709 Gr 50, or an approved equivalent.

Provide a grounding lug(s) in the approximate vicinity of the messenger cable clamp for bonding and grounding messenger cable. Lugs must accept #4 or #6 AWG wire to bond messenger cables to the pole in order to provide an effective ground fault circuit path. Refer to Metal Pole Standard Drawing Sheet M6 for construction details.

Have poles permanently stamped above the hand holes with the identification tag details as shown on Metal Pole Standard Drawing Sheet M2.

Provide liquid tight flexible metal conduit (Type LFMC), liquid tight flexible nonmetallic conduit (Type LFNC), high density polyethylene conduit (Type HDPE), or approved equivalent to isolate conductors feeding luminaires.

Fabricate poles from a single piece of steel or aluminum with single line seam weld with no transverse butt welds. Fabrication of two ply pole shafts is unacceptable with the exception of fluted shafts. Provide tapers for all shafts that begin at base and that have diameters which decrease uniformly at the rate of not more than 0.14 inch per foot (11.7 millimeters per meter) of length.

Provide four anchor nuts and four washers for each anchor bolt. Ensure that anchor bolts have required diameters, lengths, and positions, and will develop strengths comparable to their respective poles.

Provide a terminal compartment with cover and screws in each pole that encompasses the hand hole and contains a 12-terminal barrier type terminal block. Provide two terminal screws with a removable shorting bar between them for each termination. Furnish terminal compartment covers attached to the pole by a sturdy chain or cable approved by the Engineer. Ensure that the chain or cable is long enough to permit the cover to hang clear of the compartment opening when the cover is removed, and is strong enough to prevent vandals from being able to disconnect the cover from the pole. Ensure that the chain or cable will not interfere with service to the cables in the pole base.

Install grounding lugs that will accept #4 or #6 AWG wire to electrically bond messenger cables to the pole. Refer to Metal Pole Standard Drawing Sheet M6 for construction details.

For each pole, provide a 1/2 inch minimum thread diameter, coarse thread stud and nut for grounding which will accommodate #6 AWG ground wire. Ensure that the lug is electrically bonded to the pole and is conveniently located inside the pole at the hand hole.

Provide a removable pole cap with stainless steel attachment screws for the top of each pole. Ensure that the cap is cast aluminum conforming to Aluminum Association Alloy 356.0F. Furnish cap attached to the pole with a sturdy chain or cable approved by the Engineer. Ensure that the chain or cable is long enough to permit the cap to hang clear of the pole-top opening when the cap is removed.

When required by the plans, furnish couplings 42 inches above the bottom of the base for mounting of pedestrian pushbuttons. Provide mounting points consisting of 1-1/2 inch internally threaded half-couplings that comply with the NEC and that are mounted within the poles. Ensure that couplings are essentially flush with the outside surfaces of the poles and are installed before any required galvanizing. Provide a threaded plug in each mounting point. Ensure that the surface of the plug is essentially flush with the outer end of the mounting point when installed and has a recessed hole to accommodate a standard wrench.

### 1. STRAIN POLE SHAFTS

Provide 2 messenger cable (span wire) clamps and associated hardware for attachment of messenger cable. Ensure that diameter of the clamp is appropriate to its location on the pole and is appropriately designed to be adjustable from 1'-6" below the top, down to 6'-6" below the top of the pole. Do not attach more than one support cable to a messenger cable clamp.

Provide a minimum of three (3) 2 inch (50 mm) holes equipped with an associated coupling and weatherhead on the messenger cable load side of the pole to accommodate passage of signal cables from inside the pole. Provide galvanized threaded plugs for all unused couplings at pole entrance points. Refer to Metal Pole Standard Drawing Sheet M3 for fabrication details.

Ensure that allowable pole deflection does not exceed that allowed per 6<sup>th</sup> Edition AASHTO. Ensure maximum deflection at the top of the pole does not exceed 2.5 percent of the pole height.

### 28.3. DRILLED PIER FOUNDATIONS FOR METAL TRAFFIC SIGNAL POLES

Analysis procedures and formulas shall be based on AASHTO 6<sup>th</sup> Edition, latest ACI code and the *Drilled Shafts: Construction Procedures and Design Methods* FHWA-NHI-10-016 manual. Design methods based on engineering publications or research papers needs to have prior approval from NCDOT. The Department reserves the right to accept or disapprove any method used for the analysis.

Use a Factor of Safety of 1.33 for torsion and 2.0 for bending for the foundation design.

Foundation design for lateral load shall not exceed 1" lateral deflection at top of foundation.

For lateral analysis, use LPILE Plus V6.0 or later. Inputs, results and corresponding graphs are to be submitted with the design calculations.

Skin Friction is to be calculated using the  $\alpha$ -method for cohesive soils and the  $\beta$ -method for cohesion-less soils (**Broms method will not be accepted**). Detailed descriptions of the " $\alpha$ " and " $\beta$ " methods can be found in *FHWA-NHI-10-016*.

Omit first 2.5ft for cohesive soils when calculating skin friction.

When hammer efficiency is not provided, assume a value of 0.70.

Design all custom foundations to carry the maximum capacity of each metal pole. For standard case strain poles only, if a custom foundation is designed, use the actual shear, axial and moment reactions from the Standard Foundation Selection Table shown on Standard Drawing No. M8.

When poor soil conditions are encountered which could create an excessively large foundation design, consideration may be given to allowing an exemption to the maximum capacity design. The contractor must gain approval from the engineer before reducing a foundation's capacity.



On projects where poor soil is known to be present, it is advisable that the contractor consider getting foundations approved before releasing poles for fabrication.

Have the contractor notify the engineer if the proposed foundation is to be installed on a slope other than 8H: 1V or flatter.

#### **A. Description:**

Furnish and install foundations for NCDOT metal poles with all necessary hardware in accordance with the plans and specifications.

Metal Pole Standards have been developed and implemented by NCDOT for use at signalized intersections in North Carolina. If the plans call for a standard pole, then a standard foundation may be selected from the plans. However, the Contractor is not required to use a standard foundation. If the Contractor chooses to design a non-standard site-specific foundation for a standard pole or if the plans call for a non-standard site-specific pole, design the foundation to conform to the applicable provisions in the NCDOT Metal Pole Standard Drawings and Section B7 (Non-Standard Foundation Design) below. If non-standard site specific foundations are designed for standard QPL approved strain poles, the foundation designer must use the design moment specified by load case on Metal Pole Standard Drawing Sheet M8. Failure to conform to this requirement will be grounds for rejection of the design.

If the Contractor chooses to design a non-standard foundation for a standard pole and the soil test results indicate a standard foundation is feasible for the site, the Contractor will be paid the cost of the standard foundation (drilled pier and wing wall, if applicable). Any additional costs associated with a non-standard site-specific foundation including additional materials, labor and equipment will be considered incidental to the cost of the standard foundation. All costs for the non-standard foundation design will also be considered incidental to the cost of the standard foundation.

#### **B. Soil Test and Foundation Determination:**

##### **1. General:**

Drilled piers are reinforced concrete sections, cast-in-place against in situ, undisturbed material. Drilled piers are of straight shaft type and vertical.

Some standard drilled piers for supporting poles with mast arms may require wing walls to resist torsional rotation. Based upon this provision and the results of the required soil test, a drilled pier length and wing wall requirement may be determined and constructed in accordance with the plans.

For non-standard site-specific poles, the contractor-selected pole fabricator will determine if the addition of wing walls is necessary for the supporting foundations.

##### **2. Soil Test:**

Perform a soil test at each proposed metal pole location. Complete all required fill placement and excavation at each signal pole location to finished grade before drilling each boring. Soil tests performed that are not in compliance with this requirement may be rejected and will not be paid. Drill one boring to a depth of 26 feet within a 25 foot radius of each proposed foundation.

Perform standard penetration tests (SPT) in accordance with ASTM D 1586 at depths of 1, 2.5, 5, 7.5, 10, 15, 20 and 26 feet. Discontinue the boring if one of the following occurs:

- A total of 100 blows have been applied in any 2 consecutive 6-in. intervals.
- A total of 50 blows have been applied with < 3-in. penetration.

Describe each intersection as the “Intersection of (Route or SR #), (Street Name) and (Route or SR #), (Street Name), \_\_\_\_\_ County, Signal Inventory No. \_\_\_\_\_”. Label borings with “B-N, S, E, W, NE, NW, SE or SW” corresponding to the quadrant location within the intersection. Pole numbers should be made available to the Drill Contractor. Include pole numbers in the boring label if they are available. If they are not available, ensure the boring labels can be cross-referenced to corresponding pole numbers. For each boring, submit a legible (hand written or typed) boring log signed and sealed by a licensed Geologist or Professional Engineer registered in North Carolina. Include on each boring the SPT blow counts and N-values at each depth, depth of the boring, hammer efficiency, depth of water table and a general description of the soil types encountered using the AASHTO Classification System.

**3. Standard Foundation Determination:**

Use the following method for determining the Design N-value:

$$N_{AVG} = \frac{(N@1' + N@2.5' + \dots + N@Deepest \text{ Boring Depth})}{\text{Total Number of N-values}}$$

$$Y = (N@1')^2 + (N@2.5')^2 + \dots + (N@Deepest \text{ Boring Depth})^2$$

$$Z = (N@1' + N@2.5' + \dots + N@Deepest \text{ Boring Depth})$$

$$N_{STD \text{ DEV}} = \left[ \frac{(\text{Total Number of N-values} \times Y) - Z^2}{(\text{Total Number of N-values}) \times (\text{Total Number of N-values} - 1)} \right]^{0.5}$$

**Design N-value** equals lesser of the following two conditions:

$$N_{AVG} - (N_{STD \text{ DEV}} \times 0.45)$$

Or

$$\text{Average of First Four N-Values} = \frac{(N@1' + N@2.5' + N@5' + N@7.5')}{4}$$

*Note: If less than 4 N-values are obtained because of criteria listed in Section 2 above, use average of N-values collected for second condition. Do not include the N-value at the deepest boring depth for above calculations if the boring is discontinued at or before the required boring depth because of criteria listed in Section 2 above. Use N-value of zero for weight of hammer or weight of rod. If N-value is greater than 50, reduce N-value to 50 for calculations.*

If standard NCDOT strain poles are shown on the plans and the Contractor chooses to use standard foundations, determine a drilled pier length, “L,” for each signal pole from the Standard Foundations Chart (sheet M 8) based on the Design N-value and the predominant soil type. For each standard pole location, submit a completed “Metal Pole Standard Foundation Selection

Form” signed by the Contractor’s representative. Signature on form is for verification purposes only. Include the Design N-value calculation and resulting drilled pier length, “L,” on each form.

If non-standard site-specific poles are shown on the plans, submit completed boring logs collected in accordance with Section 2 (Soil Test) above along with pole loading diagrams from the plans to the contractor-selected pole fabricator to assist in the pole and foundation design.

If one of the following occurs, the Standard Foundations Chart shown on the plans may not be used and a non-standard foundation may be required. In such case, contact the Engineer.

- The Design N-value is less than 4.
- The drilled pier length, “L”, determined from the Standard Foundations Chart, is greater than the depth of the corresponding boring.

In the case where a standard foundation cannot be used, the Department will be responsible for the additional cost of the non-standard foundation.

Foundation designs are based on level ground around the traffic signal pole. If the slope around the edge of the drilled pier is steeper than 8:1 (H:V) or the proposed foundation will be less than 10 feet from the top of an embankment slope, the Contractor is responsible for providing slope information to the foundation designer and to the Engineer so it can be considered in the design.

The “Metal Pole Standard Foundation Selection Form” may be found at:

<http://www.ncdot.gov/doh/preconstruct/highway/geotech/formdet/misc/MetalPole.pdf>

If assistance is needed, contact the Engineer.

#### **4. Non-Standard Foundation Design:**

Design non-standard foundations based upon site-specific soil test information collected in accordance with Section 2 (Soil Test) above. Design drilled piers for side resistance only in accordance with Section 4.6 of the *AASHTO Standard Specifications for Highway Bridges*. Use the computer software LPILE version-6.0 or later manufactured by Ensoft, Inc. to analyze drilled piers. Use the computer software gINT V8i or later manufactured by Bentley Systems, Inc. with the current NCDOT gINT library and data template to produce SPT boring logs. Provide a drilled pier foundation for each pole with a length and diameter that result in a horizontal lateral movement of less than 1 inch at the top of the pier and a horizontal rotational movement of less than 1 inch at the edge of the pier. Contact the Engineer for pole loading diagrams for standard poles to be used for non-standard foundation designs. Submit any non-standard foundation designs including drawings, calculations, and soil boring logs to the Engineer for review and approval before construction.

#### **C. Drilled Pier Construction:**

Construct drilled pier foundations in accordance with the *Foundations and Anchor Rod Assemblies for Metal Poles* provision.

**28.4. POLE NUMBERING SYSTEM**

**A. New Poles**

Attach an identification tag to each pole shaft and mast arm section as shown on Metal Pole Standard Drawing Sheet M2 “Typical Fabrication Details Common To All Metal Poles”.

**B. Reused Poles**

Do not remove the original identification tag(s) from the pole shaft and/or mast arm sections. Add a new identification tag based on the new location for any reused poles and/or mast arms.

**28.5. MEASUREMENT AND PAYMENT**

Actual number of metal strain signal poles (without regard to height or load capacity) furnished, installed and accepted.

Actual number of soil tests with SPT borings drilled furnished and accepted.

Actual volume of concrete poured in cubic yards of drilled pier foundation furnished, installed and accepted.

Actual number of foundations with wing walls furnished, installed and accepted, excluding foundation length. Refer to method of measurement above for drilled pier foundation.

Actual number of designs for metal strain poles furnished and accepted.

No measurement will be made for foundation designs prepared with metal pole designs, as these will be considered incidental to designing signal support structures.

**Payment will be made under:**

Metal Strain Signal Pole .....	Each
Soil Test .....	Each
Drilled Pier Foundation.....	Cubic Yard

### 30. PROTECTIVE COATING FOR METAL POLES

#### 30.1. DESCRIPTION

Protective coating for metal poles is a supplemental durable color coating that is applied to galvanized steel and aluminum traffic signal structures installed in locations where maintaining an aesthetic appearance is important. Powder Coating is the preferred supplemental protective coating process for coating galvanized steel and aluminum structures. However, for the purposes of this special provision, an Acrylic Primer and top coat paint system is included as an acceptable alternative when protective color coating is required.

Provide protective coating over galvanization for all steel poles including all necessary hardware in accordance with the plans and specifications. Any aluminum components do not need to be galvanized before application of protective coating.

#### 30.2. MATERIALS

With the exception of aluminum components, furnish all metal poles with galvanic protection along with a tough and durable application of protective coating. Aluminum components shall have a durable powder coating application. Galvanization is not required for aluminum components.

Furnish pole caps that have a low gloss powder finish applied over a hot-dipped galvanized surface. Comply with the applicable provisions of Section 442-10 and 442-12 of the *Standard Specifications*.

**Ensure the selected color for protective coating has been verified and approved by the Engineer prior to fabrication.**

#### 30.3. COATING SHOP APPROVAL

Approve the coating shop facility prior to the application of any coating process. Submit all requests, procedures and documents electronically to:

- Mr. Brian Hunter, P.E., Chemical Testing Engineer
  - bhunter@ncdot.gov
- A) Submit a quality control procedure that the company has established to ensure a quality and durable coating. The quality control procedure shall contain at a minimum the following:
- Qualified / Certified personnel to manage the QC Program and to conduct Quality Control tests
  - Qualified / certified coaters
  - Source and type of powder
  - How the powder will be stored
  - Powder application facility (heated or unheated)
  - Surface pre-treatment
  - Surface preparation including profile
  - Application methods
  - Curing conditions (conventional or infrared)
  - Curing Temperature

- Adhesion & Holiday Detection
  - Repair Procedure
  - Storage and protection of coated items
  - Shipping and handling (packing, protection, and wrapping)
- B) Submit a powder certification from the manufacturer
- C) Submit the following to the Chemical Testing Engineer a minimum of four weeks prior to coating application.
1. Two test panels of ASTM A36 steel,  $\frac{1}{4}$  or greater in thickness measuring 8 inches by 11 inches using the proposed color of the final coat; a powder coated over galvanized test panel and a powder coated over un-galvanized test panel.
  2. In addition, provide two (2) samples of the same or comparable material and thickness as production pieces. Ensure production piece replicas do not exceed twelve inches (12") in length and width nor 50 pounds in weight.
  3. Submit all test panels with inspection reports and records according to *Standard Specifications*, Section 442, Section 1072, Section 1076, and Section 1080.
  4. Acceptance of the panels is determined by meeting the requirements of ASTM D-4541 of 800 psi for both galvanized and un-galvanized and production piece test panels.
  5. Send all panels to :  
Materials and Tests Unit  
1801 Blue Ridge Road  
Raleigh, NC 27607  
Attn: Chemical Testing Engineer

#### **30.4. POWDER COATING**

##### **A. Galvanizing**

Galvanize steel products in accordance with Section 1076 of the Standard Specifications. Ensure the fabricator or designated representative(s) that is supplying the components to be galvanized communicates with the galvanizer to indicate that the galvanized pieces will be powder coated to avoid water or chromate quenching.

##### **B. Surface Preparation**

Comply with manufacturer's recommended surface coating specifications, Steel Structure Painting Council (SSPC) specifications and applicable articles of Section 442 (Painting Steel Structures) of the Standard Specifications. Ensure that surface preparations and treatments are performed and meet the requirements of the above referenced specifications.

Some pole components, specifically steel plates  $\frac{3}{4}$  inches or more in thickness, may need blast cleaning prior to structure assembly to remove impurities and non-metallic foreign materials. Mechanically remove all weld flux after structure is assembled

Degrease and prepare steel structure for zinc coating after assembly using full immersion baths and pickling processes in heat controlled caustic and acid solutions. Rinse and clean structure to remove caustic or acid solutions by immersion in a circulating fresh water bath.

Immerse structure in a heat controlled concentrated zinc ammonium chloride flux solution and air dry as a final prep before hot-dip galvanization.

Ensure that the surface preparation is no less than specified by the powder manufacturer's recommendations. Prepare all components to be coated in accordance with SSPC SP-2 (Hand Tool Cleaning) and/or SSPC SP-3 (Power Tool Cleaning). Remove all drainage spikes, high spots, protrusions or other surface defects using hand or power tools. Do not remove the galvanization below the limits set forth in AASHTO M111.

Remove grease, oils, moisture, scale, rust or any other foreign matter prior to powder coating to ensure ideal adhesion and coating performance. Prepare and coat the galvanized surface as soon as possible after the galvanization process.

### **C. Powder Coating Application and Curing**

Prepare galvanized finish for powder coating by brush blasting in accordance with SSPC-SP7. Ensure all threaded components of the structure are protected from damage during blasting process.

Use thermosetting powder resin that meets 5A or 5B classifications of ASTM D3359. Apply powder coating electrostatically. Follow manufacturer's recommended preheating requirements. Ensure the top coat finish is applied uniformly to all surfaces with a dry film thickness of between 3.0 to 5.0 mils. Cure the top coat by heating the structure to manufacturer recommended temperatures at the duration required to ensure complete and uniform bond.

### **D. Quality Control**

Ensure the applicator provides all test reports and documentation and inspects all coated material as outlined in the Standard Specifications, Section 442, Section 1072, Section 1076, and Section 1080. Ensure the quality control inspection is kept separate from the production functions.

### **E. Storage, Shipping, and Handling**

Store all powder coated material inside or as directed by the Engineer.

Protect the product from incurring damage during all shipping, handling, and storing activities. Do not store the product directly on the ground or in areas where water may pool; the Engineer determines the effectiveness of all storage, shipping and handling methods.

### **F. Repair of Powder Coated Material**

Repair all damage to the coating by the original method of application as outlined in the coating facility's repair procedure. Ensure all repair areas meet the original requirements for adhesion as stated in this Project Special Provision.

Photograph, document, and report all damages upon delivery to the project site prior to unloading. Provide documented damage notifications to the Engineer or to their authorized representative so the application firm can be notified. The Engineer has the authority to accept or reject the material as outlined in the Standard Specifications.

Submit to the Engineer a repair procedure for damaged coatings which occur during storage, transporting, handling and or installation. Utilize a liquid paint approved by the Department, compatible with the powder applied product. Ensure all repair areas demonstrate an adhesion rating of 400 psi in accordance with ASTM D-4541. Obtain Engineer's acceptance of the final finish.

**30.5. ACRYLIC PRIMER AND TOP COAT PAINT SYSTEM 4 (MODIFIED)****A. Description**

Follow NCDOT procedures for Powder Coating over Galvanizing. Provide an Acrylic Primer and top coat when a substitute for powder coating is necessary.

Provide supplemental coating for all mast arms with metal signal poles and all necessary hardware for the signalized intersection in accordance with NCDOT Standard specifications – sections 442 and 1080, as contained herein, and as shown on the plans.

Ensure all painting work for new structures, except field touch-up and bolt painting is performed in the shop.

**B. Surface Preparation**

Ensure all surface preparation is not less than that specified by the paint manufacturer's recommendations.

Ensure all components to be coated are prepared in accordance with SSPC SP2 (Hand Tool Cleaning and or SSPC SP-3 (Power Tool Cleaning). Remove all drainage spikes, high spots, protrusions or other surface defects using hand or power tools. Do not remove the galvanization below the limits set forth in AASHTO M111.

Perform abrasive sweep blasting in accordance with ASTM D6386. Refer to this section for a description of the abrasive blast material to be used. Use a material and technique capable of stripping action to remove corrosion products and to provide a rough surface profile while leaving base zinc layers intact.

Blow down all blasted surfaces with clean compressed air to provide a clean, dry surface.

Ensure all surfaces are free of visible zinc oxides or zinc hydroxides.

**C. Materials**

Use an approved/qualified waterborne paint meeting the requirements of NCDOT Standard specification section 1080. Do not apply paint until each batch has been tested by the Department. Provide color as specified in the contract documents.

Ensure all paint used on this contract is produced by the same manufacturer.

**D. Painting**

Apply paint in accordance with the requirements of Section 1080 and Section 442 of the 2010 *Standard Specifications* using System 4 as modified herein.



**System 4 (Modified)  
Acrylic Primer and Top Coats**

Coat	Material	Mils Dry/Wet Film	Mils Dry/Wet Film
		Thickness	Thickness
		Minimum	Maximum
Primer	1080-12 White	3.0 DFT	5.0 DFT
Stripe	1080-12 Brown	4.0 WFT	7.0 WFT
Topcoat	1080-12 Brown	2.0 DFT	4.0 DFT
<b>Total</b>		5.0 DFT	9.0 DFT

Shop paint all galvanized surfaces within 8 hours after surface preparation with the exception of field touch-up and bolt painting.

Mask off and do not paint all data plates and faying surfaces prior to application.

Spray apply all coatings except for the stripe coat. Brush apply the stripe coat to all plate edges, welds, bolt holes and bolts prior to applying the finish coat.

#### **E. Curing**

Store all material in a heated shop for a period no less than 24 hours once top coat has been applied. Continue storing material until requirements of ASTM D-1640 have been met.

#### **F. Inspection**

Provide inspection records showing the initial average thickness of the hot dipped galvanizing as well as the final average DFT measurement.

Ensure all material is of a uniform appearance free of runs, drips, and sags.

#### **G. Handling**

Do not handle, ship, or erect coated members until paint is thoroughly dry.

Protect all shipping and handling either from the coating facility to project site and or storage site to area(s) to construction location from incurring damage to product. Wood blocks and nylon slings are recommended for securing, loading, hoisting or storing members.

#### **H. Repair of Damaged Coating**

Repair damage occurring to the galvanized portion of the coating during shipment or installation in accordance with Articles 1076-6 and 1080-9 of the *Standard Specifications*. Repair damage occurring to the painted portion of the coating during shipment or installation by applying 4.0-7.0 wet mils of topcoat with a brush or roller and feather or taper this to be level with the surrounding areas.

**30.6. MEASUREMENT AND PAYMENT**

Actual number of strain poles with protective coating applied furnished, installed, and accepted.

**Payment will be made under:**

Powder Coat for Strain Pole (\_\_\_\_\_)..... Each

## 31. ETHERNET CABLE

### 31.1. DESCRIPTION

Furnish and install copper Ethernet cable, as shown in the Plans, for interconnecting various hardware in an Ethernet network, located in both the signal cabinets and the TMC. Furnish and install Ethernet patch panels for terminating Ethernet cable in the TMC.

### 31.2. MATERIALS

#### A. Ethernet Cable

Provide shielded Category 6 Ethernet outdoor-rated twisted-pair cable that complies with ANSI/TIA-568-C.2 standards for four-pair shielded twisted copper for Ethernet communications. The cable shall meet all of the mechanical requirements of ANSI/ICEA S-80-576 applicable to four-pair inside wiring cable for plenum or general cabling.

Furnish Ethernet cable meeting the following minimum performance requirements:

- Specified frequency range: 1-250 MHz
- Impedance: 100 ohms
- Return Loss: 19.8 dB
- Attenuation: 32.8 dB @ 250 MHz
- Near End Crosstalk (NEXT): 38.3 dB @ 250 MHz
- Power Sum NEXT: 36.3dB @ 250 MHz
- ELFNEXT: 19.8 dB @ 250 MHz
- Delay Skew: 45 ns
- Return Loss: 18.3 dB @ 250 MHz
- Capacitance: 15 pF/ft.

Furnish Ethernet cable meeting the following physical requirements:

- Jacket: PVC, UV resistant
- Jacket Color: Black
- Insulation: Polyolefin
- Core: Gel-filled or flooded core
- Binder: Clear mylar with 100% coverage
- Shield: Aluminum/mylar-polyester tape with 100% coverage
- Drain Wire: 24 AWG tinned copper
- Conductors: Solid copper
- Conductor Color Codes: White-Blue/Blue, White-Orange/Orange, White-Green/Green, White-Brown/Brown
- Conductor size: 23 AWG

**Copper clad aluminum cable is not allowed.**

For Ethernet cable installed in outdoors on aerial messenger cable and in underground conduits, provide the cable rated for such conditions (i.e., UV-resistant, wet conditions, etc.).

## B. Cable Management

Wire and cable must provide integrated features to enhance cable management. Integrated cable management features shall include:

- Ascending Descending Sequential Foot Markings: The cable shall provide ascending/descending sequential foot markings printed on the cable jacket. The foot markings shall be used to determine the exact length of cable runs and/or determine the amount of cable remaining in/on a box or reel.
- Alphanumeric Cable Labeling Coding System: The cable shall provide alphanumeric cable labeling coding system printed on the cable jacket. The printed coding system shall include the following alphanumeric characters to allow cable identification without the need for separate adhesive-style labels: A, B, C, D, E, 0, 1, 2, 3, 4, 5, 6, 7, 8, 9. The coding system shall allow easy cable labeling using a standard waterproof marker for: identification of devices, device addresses, zone/circuit cable numbers, etc.
- Cable Colors: The cable shall be available with different color stripes and solid jacket colors. The cable coloring may be used with the alphanumeric cable labeling system to further enhance cable identification to maximize field productivity during system installation and/or maintenance and service.
- Integral Rip Cords: Cables 18 AWG and larger shall include an integral rip cord to provide for easier field stripping of the cable jacket.

Utilize pre-lubricated cable treated with a lubricant to increase cable pulling productivity and efficiency and to decrease the risk of cable damage due to excessive pulling strengths. A non-staining lubricant shall be applied to coat the full length of the cable during the manufacturing process. The lubricant shall produce a low coefficient of friction on the cable jacket material that reduces pulling friction by up to 70%. The lubricant shall continue to reduce friction after it has dried; remaining as a slippery film that retains lubricity for months after use. The cable lubricant shall comply with the physical and performance requirements of Telcordia Standard, TR-NWT-002811, and Generic Requirements for Cable Placing Lubricants. The lubricant shall not contain solvents nor have a flash point.

Furnish color coded cables to denote the type of connection between devices. The colors shall be:

- TMC:
  - ITS Servers and firewall - Blue
  - Video Servers and Video Processor Units – Yellow
  - Workstations and UPS – Gray
  - Test Cabinets - Green
- Exterior Cable - Black
- Field Device Cabinets:
  - Traffic Signal Controllers – Blue
  - Conflict Monitors - Red
  - CCTV Cameras – Black
  - Laptop - Gray

### C. Connectors

Provide RJ-45 connectors with gold wire conductors terminated according EIA/TIA-568-A/568-B standards. Provide connectors with eight contacts. Furnish connectors appropriately rated for the cable being installed. Provide cables with factory-installed connectors for interior cables.

### D. Ethernet Patch Cable:

Furnish Fast Ethernet patch cords meeting the following physical requirements:

- Minimum of five (5)-foot length,
- Category 6,
- Factory pre-installed RJ-45 connectors on both ends,
- Molded anti-snag hoods over connectors, and
- Gold plated connectors.

Furnish Ethernet patch cords meeting the following minimum performance requirements:

- TIA/EIA-568-C.2, Additional Transmission Performance Specifications for 4-pair 100  $\Omega$  Category 6 Cabling.
- Specified frequency range: 1-250 MHz
- Impedance: 100 ohms
- Return Loss: 19.8 dB
- Attenuation: 32.8 dB @ 250 MHz
- Near End Crosstalk (NEXT): 38.3 dB @ 250 MHz
- Power Sum NEXT: 36.3dB @ 250 MHz
- ELFNEXT: 19.8 dB @ 250 MHz
- Delay Skew: 45 ns
- Return Loss: 18.3 dB @ 250 MHz
- Capacitance: 15 pF/ft.

**Copper clad aluminum cable is not allowed.**

### E. Environmental Requirements

#### 1. Outdoor Cable

Provide 4-pair twisted copper Ethernet cable and connectors rated for an ambient operating temperature range of -30° to 165° F. The cable shall be shielded, outdoor-rated and have a UV resistant jacket. The void between the insulated copper pairs and the polyethylene outer jacket shall be injected with a water resistant flooding compound.

#### 2. Indoor Cable

Provide 4-pair twisted copper Ethernet cable and connectors rated for an ambient operating temperature range of -30° to 165° F. Furnish factory pre-terminated/pre-connectorized Ethernet cables whenever possible. Provide factory pre-connectorized Ethernet cables for all cables that are less than or equal to 12 feet in length.

### 31.3. CONSTRUCTION METHODS

#### A. General

Install color-coded Category 6 Ethernet cable for CCTVs, on traffic signal and utility poles, and in conduits or on messenger cable to bring the cable between the CCTV assembly and the traffic signal controllers. Use color-coded cable as described in these Project Special Provisions above.

Furnish all tools, equipment, materials, supplies, and hardware necessary to install a fully operational Ethernet cable system as depicted in the Plans. Install the Ethernet cable according to the latest version of the manufacturer's cable installation procedures and the industry-accepted installation standards, codes, and practices, or as directed by the Engineer.

Take all precautions necessary to ensure the Ethernet cable is not damaged during storage and installation. Do not step on the cable nor run over the cable with vehicles or equipment. Do not pull the cable over or around obstructions or along the ground.

Immediately cease work and notify the Engineer and the affected owner should damage to existing cables or equipment occur. Make the required repairs at no additional cost to the Department.

Provide the Engineer with three copies of the Ethernet cable manufacturer's recommended and maximum pulling tensions for each Ethernet cable size before the installation of Ethernet cable.

Install Ethernet cable in continuous lengths with no splices.

Cut cables to length to minimize coils of spare cable. Cut outer jacket and trim conductors per manufacturer's recommendations. Ensure all conductors extend to the end of the channel and make solid electrical contact with the gold connectors. Crimp the RJ-45 connector body to lock conductors in channels.

#### B. Aerial Installation

Use pole attachment hardware and roller guides with safety clips to install the aerial Ethernet cable.

Maintain tension during the pulling process for aerial run Ethernet cable by using a mechanical clutch (dynamometer) device with breakaway swivel approved by the Engineer. Do not exceed 80 percent of the manufacturer's maximum allowable pulling tension. Do not allow the Ethernet cable to contact the ground or other obstructions between the poles during installation. Do not use a motorized vehicle to generate cable-pulling forces.

#### C. Messenger Cable Installation

Double lash the Ethernet cable to the messenger cable where the messenger cable is used solely to support the communications cable.

Wrap the communications cable to the messenger cable using aluminum ribbon wraps where the messenger cable supports other cables (i.e., traffic signal cable, lead-in cable, etc.).

#### D. Underground Installation

Install underground Ethernet cable as shown in the Plans using cable-pulling lubricants approved by the Ethernet cable manufacturer and the Engineer. Obtain the Engineer's approval

of the cable lubricant and method of pulling before the installation of underground Ethernet cable.

Do not exceed 80 percent of the manufacturer's maximum pulling tension when installing underground Ethernet cable.

Use a clutch device (dynamometer) with breakaway swivel so as not to exceed the allowable pulling tension if the cable is pulled by mechanical means. Do not use a motorized vehicle to generate cable-pulling forces.

Keep tension on the cable reel and the pulling line at the start of each pull. Do not release the tension in the cable if the pulling operation is halted. Restart the pulling operation by gradually increasing the tension until the cable is in motion.

Set cable reels up on the same side of the junction box as the conduit section in which the cable is to be installed. Place the reel level and align the reel with the conduit section such that the cable will pass from the top of the reel in a smooth bend into the conduit without twisting. Do not pull the cable from the bottom of the reel. Manually feed the cable by rotating the reel. Do not pull the cable through intermediate junction boxes, pull boxes, handholes, or openings in conduit unless otherwise approved by the Engineer.

Crimp the RJ-45 connector body to lock conductors in channels. Test each connector from end to end.

#### **E. Above-Ceiling Installation**

Install Ethernet cable for the new TMC overlashed to existing CAT5 cable attached to J-hooks as shown in the Plans using the above described pulling methods. The installation of the cable tray in the TMC is included in this project. See the Building Modifications Section of these Project Special Provisions.

#### **F. Ethernet Patch Cords**

Install Ethernet patch cords between Ethernet patch panels and devices and network interface box and devices.

### **31.4. MEASUREMENT AND PAYMENT**

*Ethernet cable* will be measured and paid as the actual linear feet of Ethernet cable furnished, installed, and accepted regardless of the color of the outer jacket. Measurement will be made by calculating the difference in length markings located on outer jacket from start of run to end of run for each run. No measurement will be made of connectors as such work is considered incidental to installing the Ethernet cable.

No measurement will be made for Ethernet patch cables that connect adjacent devices/equipment (e.g., between an Ethernet edge switch and a controller housed in the same cabinet) as they will be considered incidental to furnishing and installing the equipment that they connect.

Payment will be made under:

#### **Pay Item**

Ethernet Cable

#### **Pay Unit**

Linear Foot

## 32. CCTV FIELD EQUIPMENT

### 32.1. DESCRIPTION

Furnish and install CCTV field equipment and local camera control software described in this Section.

Provide a system to protect field devices and electronic equipment from lightning and surge protection using UL<sup>®</sup> listed surge protection devices.

### 32.2. MATERIALS

#### A. General

Provide new CCTV camera assemblies and all wiring as shown in the Plans. Each CCTV camera assembly shall consist of the following:

- NEMA environmental dome enclosure,
- CCTV color digital signal processing camera unit integrated encoder, zoom lens, filter, control circuit, and accessories,
- Motorized pan, tilt, and zoom,
- CCTV Power over Ethernet (PoE) Injector,
- Pole-mount camera attachment hardware,
- Built-in video encoder cable of H.264/MPEG-4 compression for video-over IP transmission,
- All necessary cable, connectors and incidental hardware to make a complete and operable system,
- NEMA Type 4, IP 66 enclosure constructed of aluminum with a clear acrylic dome or approved equal camera unit housing,
- Category 6 Ethernet cable for power supply and Ethernet communications, and
- Ethernet communications cable, and
- Surge protection devices.

Furnish all tools, equipment, materials, supplies and hardware necessary to install a fully operational CCTV camera system as depicted in the Plans and described in these Project Special Provisions.

Provide all hardware and mounting brackets required to mount CCTV camera assemblies to metal and wood poles as required by the Plans. Attach camera mounting brackets to poles using Engineer-approved stainless steel banding hardware and clamps. Submit catalog cuts/manufacturer's literature for banding hardware and clamps to the Engineer for approval.



**B. Standards**

- ANSI,
- ASTM,
- CE, Class B,
- EIA Standards 170, 232, 422, 250C and 485,
- FCC Rules Part 15, Sub-part J,
- FCC Class A,
- FCC, Class B,
- IEEE,
- ICEA,
- IMSA,
- ISO 9001,
- NEC,
- NEMA 4X, IP 66,
- NEMA Type 1,
- NTSC, and
- UL Listed.

Provide UL listed surge protection devices according to the UL 1449, 2nd edition standard that comply with the NEMA requirements as detailed in the NEMA TS 1 (1992) standard.

Provide a means to ground all equipment as called for in the Standard Specifications, these Project Special Provisions, and the Plans.

**C. Camera Assembly**

Furnish new CCTV camera assemblies at locations shown on the Plans. Each assembly consists of one dome CCTV camera that contains, in a single enclosed unit, the following functionality and accessories:

**1. Cameras**

Provide new 1/2.8" progressive scan color day/night cameras. The sensors shall use Complementary Metal-Oxide-Semiconductor (CMOS) technology. The camera must meet the following minimum requirements:

- |                              |  |
|------------------------------|--|
| • Image sensor size:         | 2 megapixels   |
| • Video signal format:       | NTSC compatible resolution, user selectable up to a maximum of 1920 x 1080 (1080p)   |
| • Maximum frames per second: | Up to 25/30 fps (50/60 Hz) in 1080p<br>Up to 50/60 fps (50/60 Hz) in 720p  |
| • White balance:             | Automatic through the lens with manual override,   |
| • Electronic-shutter:        | DIP-switch selectable NTSC electronic shutter with speed range from 1/4 of a second (off) to 1/30,000 of a second (NTSC),              |
| • Overexposure protection:   | Built-in circuitry or a protection device to prevent any damage to the camera when pointed at strong light sources, including the sun, |
| • Gain control:              | Automatic and manual,  |

- Minimum illumination: Color - 0.2 lux at 50IRE, F1.6  
Black/white - 0.02 lux at 50IRE, F1.6  
Color - 0.15 lux at 30IRE, F1.6  
Black/white - 0.01 lux at 30IRE, F1.6
- Input/output Connection: Single 10BASE-T/100BASE-T compatible outdoor-rated Category 6 cable for video and control, and IP66-rated RJ45 connector
- Security: Unlimited in multicast
- Open Application Programming Interface (API): ONVIF Profile S
- Primary supply voltage: 100-240 VAC, 74 watts maximum, and
- Camera power: Power Over Ethernet, maximum of 60 watts with heater and blower at 24 VAC, typical maximum of 16 watts without heater/blower.

## 2. Lens

Provide each camera with a motorized zoom lens with automatic iris control with manual override and neutral density spot filter. Provide lenses that meet the following optical specifications:

- Automatic focus: Automatic with manual override, Electronic Image Stabilizations (EIS)
- Horizontal angle of view: 66.7 degrees to 2.36 degrees,
- Focal length: 4.3 mm to 129 mm, 30x optical zoom and 12x digital zoom,
- Lens aperture: Minimum of F/1.6 to F/4.7,
- Minimum illumination: Color - 0.2 lux at 50IRE, F1.6  
Black/white - 0.02 lux at 50IRE, F1.6  
Color - 0.15 lux at 30IRE, F1.6  
Black/white - 0.01 lux at 30IRE, F1.6
- Preset positioning: Minimum of 128 presets.

The lens must be capable of both automatic and remote manual control iris and focus override operation. The lens must be equipped for remote control of zoom and focus, including automatic movement to any of the preset zoom and focus positions. Provide mechanical or electrical means to protect the motors from overrunning in extreme positions. The operating voltages of the lens must be compatible with the outputs of the camera control.

## 3. Camera Housing

Provide new dome style enclosure for assemblies with a high performance integrated dome system or approved equal. Provide the dome housing with a 1½" NPT threaded cable entry. Equip each camera housing with a mounting assembly for attachment to the CCTV camera pole. The enclosures must be equipped with a strip heater. Provide a sunshield fabricated from corrosion resistant aluminum and finished in a neutral color of weather resistant enamel. The viewing area of the enclosure must be tempered glass.

Provide surge protectors for all ungrounded conductors that will enter the CCTV enclosure as described below. House the surge protectors within the CCTV housing in a manner approved by the Engineer.

A dome-type environmental housing shall have a sustained ambient operating temperature of -50 degrees F to 122 degrees F, with 100 percent non-condensing relative humidity as defined within the NEMA TS-2 (1998) standard. The enclosure shall have a NEMA 4X/IP-66 rating.

#### 4. Pan and Tilt Unit

Equip each new dome style assembly with a pan and tilt unit. The pan and tilt unit must be integral to dome system. The pan and tilt unit must be rated for outdoor operation, provide dynamic braking for instantaneous stopping, prevent drift, and have minimum backlash. The dome must have an auto flip dome rotation to rotate and reposition camera for viewing objects passing below camera. Provide electronic image stabilization. The pan and tilt units must meet or exceed the following specifications:

- Pan: Continuous 360 degrees,
- Tilt: +20 to -90 degrees minimum,
- Presets: Minimum of 128 presets,
- Preset accuracy: 0.1 degree,
- Preset pan speed: 0.1 degrees/second to 200 degrees/second,
- Preset tilt speed: 0.1 degrees/second to 400 degrees/second,
- Privacy zones: Minimum of eight user configurable shapes,
- Input voltage: 24 VDC or 24 VAC, and
- Motors: Two-phase induction type, continuous duty, instantaneous reversing.

#### 5. Power Injector

Furnish a 60-watt POE power injector recommended by the manufacturer for use with the camera. Furnish a power supply injector that is rated for outdoor use, is compatible with the AC electric service source (e.g., traffic signal cabinet), and provides power within the input range of the camera.

#### D. Camera Mounting Bracket

Provide a pole attachment assembly for the CCTV camera unit to mount on wood poles, metal poles, and metal poles with mast arms. The attachment assembly shall use stainless steel banding around the pole approved by the Engineer. Provide black stainless steel banding for attaching the assembly to existing metal poles that have a black finish/coating.

Submit shop drawings of the attachment assembly for review and approval by the Engineer prior to delivery.

Provide the CCTV attachment assembly that allows for the removal and replacement of the CCTV enclosure as well as providing a weatherproof, weather-tight, seal that does not allow moisture to enter the enclosure.

Provide CCTV camera attachment assembly that is able to withstand wind loading at the maximum wind speed and gust factor called for in the interim revision of the 6<sup>th</sup> Edition *AASHTO Specifications for Structural Supports for Highway Signs, Luminaries and Traffic Signals* and can support a minimum camera unit dead load of 45 pounds.

### E. Video Encoder

All video encoders must have the following minimum features:

- Network Interface: Ethernet 10/100Base-T (RJ-45 connector)
- Protocols: IPv4, IPv6, HTTP, HTTPS, SSL, QoS, FTP, SMTP, UPnP, SNMP v2c/v3, DNS, NTP, RTSP, RTP, TCP, UDP, IGMP, DHCP
- Security: SSL, SSH, 802.1x, HTTPS encryption with password controlled browser interface
- Video Streams: 2 simultaneous streams, user configurable
- Compression: H.264 (MPEG-4 Part 10/AVC) baseline, main and high profiles and motion jpeg
- Resolution: Scalable; NTSC-compatible 320x180, 1280x720 to 1920x1080 (HDTV 1080p, 16:9 Aspect Ratio)
- Frame Rate: 1-30 FPS programmable (full motion)
- Bandwidth: 30 kbps – 6 Mbps, configurable depending on resolution
- Edge Storage: SD/SDHC/SDXC slot supporting up to 64GB memory card

Furnish cameras with a built-in digital video Ethernet encoder to allow video-over-IP transmission. The encoder units must be built into the camera housing and require no additional equipment to transmit encoded video over IP networks.

### F. Surge Suppression

All surge protection devices shall have an ambient operating temperature of -40 degrees F to 165 degrees F with 95 percent non-condensing relative humidity. All surge protection devices shall comply with the following standards:

- UL 1449 version 3 for electrical power,
- UL 497B for paired data communications, and

Provide surge protection devices meeting UL 1449A. Provide an Ethernet surge protection device strapped to the outside of the pole near the camera. Provide a camera manufacturer recommended unit suitable for exterior use. Provide an Ethernet surge protection device for the Category 6 cable entering the cabinet.

Provide surge protection for all four pairs of the Ethernet cable. Data voltage shall be 48 VDC. Surge protector will function with a Maximum Continuous Operating Voltage (MCOV) of 64VDC, and will clamp (on 1000VDC, 1mA, 10/1000  $\mu$ s waveform) at 72VDC +/- 5V. The maximum continuous current on data lines under normal conditions will be 1.5 A. The peak surge current that can be passed on any pair of data lines can be no more than 30A. Response time on data lines shall be no more than 1 pico-seconds.

Provide specialized surge protection devices at the supply and load sides of all low voltage connections to the CCTV device and its operating subsystems. Provide specialized surge protection devices at the supply and load sides of all low voltage Ethernet data connections between a CCTV and traffic signal cabinet.

The surge protection shall have an operating voltage to match the characteristics of the CCTV, such as 28 volts of alternating current and less than 5 VDC for data functions. These specialized surge protection units shall be UL listed according to the UL 497B (paired-data

cable) standards. The minimum surge current rating for the surge protection shall be 2,000 amps for data and telecommunications, 2,000 amps for twisted pair video.

### **G. Grounding**

Incorporate a means to bond (i.e., connect) all metal components of the camera and cabinets to the grounding system with a grounding cable that uses a mechanical connection on the equipment side and an irreversible compression connection at the down cable.

Provide a minimum of four grounding electrodes with a minimum length of 10 feet each and listed according to UL requirements as detailed in the *UL 467J* standard. Provide copper clad or solid copper electrodes.

### **H. Ethernet Cable**

Provide Ethernet Cable per the “Ethernet Cable” section of these Project Special Provisions.

## **32.3. CONSTRUCTION METHODS**

### **A. Electrical and Mechanical Requirements**

Ground all equipment as called for in the *Standard Specifications*, these Project Special Provisions, and the Plans.

The air terminal ground wire must not pass through any signal cabinet or enclosure.

Electrically bond each camera and pan/tilt/zoom mechanism and its housing to the CCTV camera attachment assembly using a number 6 AWG braided copper conductor.

### **B. Shared CCTV/Traffic Signal Cabinet**

At locations shown in the Plans, mount the CCTV Ethernet surge protection, CCTV power injector and CCTV cabling in a traffic signal cabinet. Using a Category 6 Ethernet patch cord connect the Ethernet edge switch to the Power Over Ethernet injector. Using a Category 6 Ethernet patch cord connect the Power Over Ethernet injector to the Ethernet surge protection device. Connect the Ethernet surge protection device to the Category 6 Ethernet cable to the camera.

### **C. Grounding**

Ground the CCTV pole and subsystems in accordance with the special details in the Plans.

### **D. Category 6 Cable**

Using a Category 6 Ethernet patch cord connect the Ethernet edge switch to the Power Over Ethernet injector. Using a Category 6 Ethernet patch cord connect the Power Over Ethernet injector to the Ethernet surge protection device. Connect the Ethernet surge protection device to the Category 6 Ethernet cable to the camera.

### **E. Surge Protection**

Connect the specialized surge protection devices between the PoE injector and CCTV camera for all Ethernet communications to the CCTV device and its operating subsystems.

### F. CCTV Camera Attachments

Install the camera attachment assembly to the mounting bracket in a manner that allows for the removal and replacement of the CCTV enclosure as well as providing a weatherproof, weather-tight seal that does not allow moisture to enter the enclosure.

Install CCTV camera attachment assembly that can withstand wind loading at the maximum wind speed and gust factor called for in the *AASHTO Standard Specifications for Structural Supports for Highway Signs, Luminaires and Traffic Signals*, 6th Edition, and can support a minimum camera unit dead load of 45 pounds.

Mount CCTV camera units at a height sufficient to adequately see traffic in all direction and as approved by the Engineer. Mount cameras on poles at the attachment heights shown in the Plans.

Mount CCTV camera on the side of pole that is nearest to the intended field of view, to avoid occlusion of the view by the pole or utility lines. Obtain approval of camera orientation from the Engineer. Comply with the “Wood Poles” section of these Project Special Provisions.

Have the Engineer approve the pole location prior to installing the camera on an existing pole and prior to setting a new pole. At locations shown in the Plans, assemble the camera attachment hardware for the CCTV camera unit and attach to the pole using stainless steel banding approved by the Engineer. Submit shop drawings for review and approval by the Engineer prior to installation.

### G. CCTV Device Database

Coordinate the naming of CCTV devices in the database and for the onscreen labeling of cameras on video monitors with Traffic Signal Supervisor, Madison Phillips, at (252) 482-1850.

## 32.4. MEASUREMENT AND PAYMENT

*CCTV camera assembly* will be measured and paid as the actual number of CCTV camera assemblies furnished, installed, and accepted.

No separate measurement will be made for PoE injector, connectors, CCTV camera attachment assemblies, software, grounding equipment, surge protection devices, other cabling, and conduit, or any other equipment or labor required to install the CCTV assembly and integrate it with the fiber-optic communications equipment as they are considered incidental to furnishing and installing the CCTV camera assembly.

The Ethernet cable between the PoE injector and the CCTV camera will be measured and paid for in accordance with the “Ethernet Cable” section of these Project Special Provisions.

Payment will be made under:

<b>Pay Item</b>	<b>Pay Unit</b>
CCTV Camera Assembly	Each

### 33. CCTV SOFTWARE AND INTEGRATION

#### 33.1. DESCRIPTION

Install VideoPro CCTV system software package on the new video server and configure for the cameras, and video devices provided in this Project.

#### 33.2. MATERIALS

Provide the latest version of Protronix VideoPro software that is necessary to maintain the video sharing requirement with the Statwide Traffic Operations Center (STOC).

#### 33.3. CONSTRUCTION METHODS

Protronix's VideoPro is the statewide video sharing and distribution system that NCDOT utilizes at the Statwide Traffic Operations Center (STOC) for controlling the existing CCTV cameras and video monitors at the TMC. The software utilizes a client-server architecture. Install Protronix CCTV central software and configure at the TMC to display and map the CCTV devices from the network so that the CCTV video can be displayed on the new monitor and display devices in the TMC.

Install VideoPro on the Departments workstation. Edit the device databases for the one existing camera and all new cameras. The existing camera shall remain viewable by the Traffic Signal System Supervisor and STOC on the existing system until the new system is operational and accessible.

Install a VideoPro server in the TMC. Configure the video server for the new wall monitor device, IP cameras, and PTZ joysticks. Configure administrative and user VLANs for the VideoPro servers in the TMC Ethernet core switch to enable video sharing.

Integrate the VideoPro software to allow for:

- Remote users (NCDOT STOC) to view and control all CCTV devices monitors connected to the TMC through the Ethernet network and the CCTV Control GUI furnished as part of this software such that a user in a TMC or STOC can switch, view, and control cameras.
- Department staff to display signal system software graphics on the digital display monitor(s).

#### 33.4. MEASUREMENT AND PAYMENT

*CCTV Software* shall be measured and paid as a lump sum. This shall include furnishing and installing software on video server, and all materials, equipment, labor, tools, storage, shipping, and incidentals necessary to install CCTV software on workstation, complete system integration, and provide a complete operating system.

No separate measurement and payment will be made the Vendor supplied configuration software as such work will be incidental to furnishing and installing the CCTV cameras.

Payment will be made under:

<b>Pay Item</b>	<b>Pay Unit</b>
CCTV Software	Lump Sum

### 34. SIGNAL SYSTEM SOFTWARE

#### 34.1. DESCRIPTION

Furnish and install traffic control system software for the following applications:

- Distributed processing system software for 50 intersection locations
- System support software
- Install the following software as furnished by the Engineer:
- Local controller firmware (latest IP version of NCDOT's ASC/3<sup>®</sup> software package)

**The Contractor shall be responsible for the development of and integration of all system graphics (and associated system devices) described in the following specifications.**

#### 34.2. GENERAL REQUIREMENTS

##### A. Signal System Software

##### 1. General

The overall architecture of the system shall be a client server design based on hybrid centralized/distributed intersection control concepts.

Processing shall be distributed and ASC/3<sup>®</sup> communications protocol shall be used for all intersection controller interfaces. Client workstations shall access networked file servers that perform traffic management, system communications, database management, and system graphics.

The system shall be implemented using standard, commercially available computer hardware required in the "Computer Hardware and Peripherals" section of these Project Special Provisions. Windowing graphical user interfaces (GUI) using object-oriented design and geographically coded database components shall be an integral part of the system design. These elements shall form the basis of all user interactions with the system.

The software shall be portable, as a minimum, across multiple PC hardware platforms and shall be designed to integrate with off-the-shelf PC software. For example, the system shall provide the ability to exchange files with common Geographic Information Systems (GIS), databases, and the latest version of Microsoft<sup>®</sup> Office.

All software and firmware furnished under this project (both for individual field equipment locations and for central software) that maintain internal clocks and utilize those clocks for display of time, reporting of time back to system users, reporting of time on reports and event logs, and/or use of internal time clock to coordinate actions and activities with other software or devices shall be able to adjust to leap-year and current day light savings time dates automatically without user intervention or adjustment.

##### a) Local Area Network Requirements

A 10/100/1000 Base-T Ethernet, local area network (LAN) shall support the distributed client/server architecture. The requirements for the LAN are in "Communications Hardware" section of these Project Special Provisions.

The software shall allow for a minimum of sixteen (16) simultaneous users (including remote users) of the traffic signal system applications software. No degradation in system performance shall occur when sixteen operators use the system simultaneously. Each user, subject to his or



her security level, shall have full access for system control, database entry/examination, malfunction diagnosis, system operation evaluation and measures of effectiveness analysis. Access by any particular user to any particular command shall be allowed or disallowed based upon that user's assigned security level.

b) Software License

Provide a perpetual, irrevocable software license for up to **50** locations to the Department that gives them the right to copy and use the distributed processing software furnished with this project at any facility within the Division. Furnish software that may be used at any other offices in the State of North Carolina that the State, or their authorized agent, may establish for the purpose of traffic signal monitoring and control of the Elizabeth City Signal System.

Furnish software modifications necessary for system operation as per this Project Special Provision to the agency at no additional cost during the warranty period.

For any software functionality that is specifically developed for this project, the software developer shall provide hardcopy and digital copies of the un-compiled source code of the software. This source code must be fully documented and commented, so that an experienced (minimum of three years) programmer/developer in the language(s) that the software is written may interpret, modify, and debug the code. The required software compilers shall be specifically and clearly identified and include the operator system platform, the version number, release number and date, and brand.

For copyrighted commercial off-the-shelf (COTS) software, a copy of the source code (both hardcopy and un-compiled digital commented as described in the preceding paragraph) shall be held in an escrow account by an independent agent agreed to prior to final acceptance of the system by the Department. The version of the source code in the escrow account shall be updated as modifications, fixes, enhancements, and improvements are made to the software and implemented on the software products used by the Department. In the event the provider of COTS software product(s) defaults, discontinues support of the software product(s) furnished under this project, goes out of business, or otherwise is unavailable to support the software product(s), the software source code contained in the escrow account shall immediately become the property of the Department.

Provide any third-party software licenses to the Department for software that may be used. Example: report-configuring, diagnostic, or monitoring software.

c) Operating System

The operating system for all server software provided under this project shall be Microsoft Windows Server® 2016, Microsoft SQL Server 2014 or newer. The operating system software for all workstations and laptops shall be Microsoft Windows® 10 Professional Edition. The release used shall be the latest revision with service packs available as recommended by the supplier of the system software.

The network operating system (NOS) shall be Microsoft Windows Server® 2016 or approved equal and must be compatible with the traffic signal system software.

The NOS shall be compatible and work seamlessly with the traffic signal system software and all other software (video, cellular, productivity, LAN, etc.).

The software shall support the use of Microsoft Active Directory.

d) NTCIP Standards

The software shall use NTCIP Standards 1201 and 1202. The central to field device communications shall utilize NTCIP 1202.

e) Software Updates

Furnish the latest version of software described in this section of the Project Special Provisions at the time of installation. Provide a means to automatically update the system software to all workstations and laptops in the network after new versions are installed on the server. Each time a user logs into the software shall check for newer client updates. The user shall have the option to automatically install or defer to later with no further user action.

## **B. Functional Requirements**

### **1. General**

The signal system software shall not be a prototype or software custom-developed for this project. The software shall have been successfully integrated, tested, and accepted in at least two cities of comparable size (a minimum of 100 intersections). This deployment shall be with 2070LX controllers utilizing the local controller software to be deployed under this project.

The system software shall communicate directly with the local intersection 2070LX controllers installed under this project. The use of remote communication units (RCUs) is not permitted. The signal system software shall interface with the latest IP version of NCDOT's ASC/3<sup>®</sup> local controller software package. The system shall use a client-server design based on hybrid centralized/distributed intersection control.

The Contractor shall demonstrate to the Department that the system software is capable of communicating with 2070LX controllers produced by at least three different manufacturers on at least three channels.

The system shall be designed to operate 24 hours per day, unattended, with operator attention required only periodically. Operator intervention requirements shall be limited to defining system components, modifying system timing, responding to alarms or malfunction indicators, diagnosing component failures, and manually "fine-tuning" new timing plans.

The software shall be capable of providing central monitoring of up to 350 intelligent controllers, note that the project has 44 existing locations. The system design shall accommodate future expansion. The addition of new intersections and detectors, in the field, shall not require additional software or central hardware, except for modems or transceivers and shall require only modification of the control database. The software design shall facilitate the easy, future incorporation of additional control strategy, software logic, and additional system features.

All changes to the system, including adding new controllers, configuring communications, modifying maps and intersection displays, etc., shall be performed through the system graphical user interface and by updating files in the system software folders. The use of initialization files and external editors shall not be required.

A laptop utility program shall provide on-street accessibility to off-line controllers.

### **2. Start-Up and Shut-Down**

The traffic control system shall provide for the initial start-up of the system by initializing all operational and failure arrays within the software. The initialization routines shall be used not

only at the true initial start-up of the system, but whenever it is desired to reinitialize the system without prior status information.

The traffic control system shall accommodate a planned shutdown of the monitoring functions of the traffic control software.

### **3. Power Failure**

Interface system software with the uninterruptible power supply. Upon detection of a loss of power, the system software shall notify the operator.

The traffic control program may suddenly stop execution for various hardware or software reasons. In such event, alarms shall alert the operator as to the problem and circuitry shall ensure against the transmission of erroneous data by the field communications subsystem.

In the event that the operator determines that the operation of the system is improper, he/she shall be able to immediately force all system intersections to an off-line, or a time-base coordination timing plan stored in the local controller (depending on the local day plan) from any system workstation.

### **4. Backup Intersection Operation**

The system shall provide for backup intersection operation in case of failure of the ITS application server, ITS backup application server, ITS communications server or the communication system. This backup shall be accomplished by means of time-base coordination (TBC) provided by the local controller software.

When operating by centrally controlled scheduled events, the local controllers shall automatically implement local TBC, according to the day plan programmed into the controller whenever communication to central is absent.

When operating by centrally controlled manual commands, the local controllers shall continue to run according to those commands regardless of the state of communications.

### **5. Clock Updates**

Upon login, each workstation clock shall be automatically updated by the Microsoft Windows operating system to the current time of the distributed system server clock.

### **6. Remote Access**

The system shall allow full access to the system for a multiple user by means of Ethernet access through a secured firewall, using VPN or other means approved by the Department. The remote user shall be allowed to perform any functions, permitted by Terminal Services, and available to any other user with the same level of security regardless to where the user is physically located.

### **7. Paging**

The system shall be capable of automatically sending alphanumeric messages (SMS – text messaging) to cellular telephones, smart phones and email addresses upon detecting problems with the system or from any device. Malfunctions notifications shall also appear as a pop-up alarm, or similar notification approved by the department, on each workstation logged into the system. An audible alert shall be associated with a pop-up alarm, and configurable by the user.

The visual pop-ups and audible alerts shall be configurable to stay up for a specified time period or to stay up indefinitely until closed by the user. Malfunction notifications shall consist

of at least three (3), user configurable, priority levels, to include low priority, medium priority and high priority alerts. Acknowledgements of incoming malfunction alarms shall be required for all medium and high priority on-screen notifications. Low priority alarm notifications shall not require acknowledgements.

Malfunction alerts shall be sent via text (SMS) or email notifications and shall be configurable by TOD/DOW, allowing recipients to be selected based upon severity or priority of event and to issue text/email messages sent to multiple devices or addresses.

Notifications shall allow a confirmation to assure that the malfunction has been acknowledged. If no acknowledgement is received upon expiration of a user programmable time-out period, subsequent notifications shall be configurable to be sent to alternate devices.

The system shall log all malfunction notifications, retries, and acknowledgements with time and date stamps. The first acknowledgement shall be recorded; all others shall be ignored.

#### **8. Field Communications**

Within the computerized signal system, traffic signal controllers will be integrated with field Ethernet edge switches that are arranged in a multi-drop communications channels capable of supporting a minimum twenty (20) traffic signal controllers on a dedicated communications channel. The software shall operate with a fully redundant communications network. Each controller is connected to the system via a pair of optical fibers and field Ethernet switch. A channel consists of two fibers: one transmitting and the other receiving. The field communications will also include two Ethernet radios operating at 2.4 Ghz.

Each channel with its boundaries and the controllers and CCTV cameras contained within it are depicted on the cable schematic diagram shown in the Plans.

#### **9. Database Preparation**

Complete all data entry necessary to implement the operation of the system software.

The Engineer will furnish intersection timing information and coordination parameters (cycle, split, offset). Any custom intersection displays will also be provided by the Department. Otherwise, default intersection timing data and standard intersection maps will be utilized when configuring intersections onto the system. Program all system detectors shown in the plans. Coordinate with the Department to provide setup, naming/labeling, logging and any features required for the operation of all system detectors.

TOD/DOW plans, alarms and other information for the operation of the signal system shall be entered by the Contractor.

#### **10. System Function Monitoring**

Verification of on-street system operation shall be incorporated in the new signal system. Operation of all controller equipment shall be monitored, with current displays and malfunctions reported in near real-time. Continuous, polled communication shall occur from the local controller to the communication server.

#### **11. Database Backup and Restoration**

The system shall have a simple means of copying the database files from the hard disk to a removable storage device or archive server. All files required to restore the system to operation without the need to manually re-enter data shall be included on removable storage device.

Files containing records of logged events and detector data shall be saved on a RAID array disk storage as described in the “Computer Hardware and Peripherals” section of these Project Special Provisions. The system shall enable an operator to copy all logged events, within a user-specified date range, to the removable storage device or archive server. The system shall enable an operator to copy all selected detector data to the removable storage device.

The software shall provide simple, straightforward means for restoring system operation from the backup database files.

## **12. Graphical User Interface**

An object-oriented, graphical user interface (GUI) shall be provided to control and access all systems displays, reports, and dialogue boxes. The GUI shall provide access to all signal system monitoring and control options from a single screen.

Graphical icons shall be used on the displays to represent system devices. The icons shall provide easy access to traffic control data (signal timing, geometric, etc.), real-time data (intersection, link status, etc.), the database, and graphical image files.

The GUI shall include an intersection/link base map with windowed table reports and management input windows. The GUI shall provide interactive mechanisms to assist in creating, editing, and modifying editable dynamic graphic screens that are linked to system dynamic elements. As a result, all operator actions shall be immediately visible as a change in the system graphic.

The workspace session window shall display a toolbar near one of the window borders. The toolbar shall contain buttons and other controls specific for actions relating to a selected window. Actions supported by and pertaining to an active window shall be invoked through the toolbar, action bars, menu selection, popup menu or controls internal to the window itself.

Menu and dialogue box options that are not appropriate in a particular context or not available to a given user shall be “grayed-out” and unavailable for selection.

Traffic engineering terminology shall be used throughout the programming displays. Display organization and data entry approach shall allow system operators to operate the distributed signal system software without using reference cards or manuals.

The user interface shall include an object library that contains dynamic icon objects for system control and monitoring devices. The basic system shall include, at a minimum, objects for traffic signals (ASC/3®).

The library shall also include an interactive editor for placing these objects within dynamic graphic screens.

The system shall allow the user to link dynamic graphics objects directly to system database elements without low-level code programming, use of initialization files, or program recompilation. The library shall also include dynamic objects allowing the user to define directional roadway links using a simple vector drawing facility. Proper representation of directional status attributes shall be available at all zoomed levels, on the system map.

All information shall be shown simultaneously and continuously displayed until canceled by the operator. Displays shall not affect system operation. All displays shall have a maximum refresh rate of one second.

### 13. System Graphics

These dynamic condition maps shall provide a simple mechanism for system navigation, presentation of status, and selections within the user interface.

Backgrounds for the system-wide graphic shall be capable of containing commercial vector images of geographically accurate maps or scanned images. These images shall be compatible with common GIS packages such as ARC GIS. These images shall be used as the display layers of real-time graphics displays. The graphics for the entire system shall be developed in the ESRI map objects embedded environment, or approved equivalent.

Backgrounds for the control section and intersection displays shall be .bmp or .jpg formats. Resolution or file size shall not be limited.

Zooming, scrolling and automatic control layers of graphic presentations shall be included with the system.

**All graphics for system maps, control section maps, and intersection displays shall be submitted to the Engineer for approval before being integrated with the software.**

#### a) System Map

The ESRI-based system-wide map or approved equivalent shall provide a dynamic display of the entire surveillance area and any layers the agency requires, including but not limited to interstate highways, major arterial roads, railroads, jurisdiction boundaries, and bodies of water. It shall be possible to “zoom in” and “drill down” to any specific area of the map using the pointing device to select one corner of an area to view, and then select the opposite corner of the area to view. (Zoom out capability shall also be provided). The window containing the system-wide map shall be capable of being dynamically sized by a workstation user.

It shall be possible to display intersection icons in different formats, using the menu bar. The system map shall provide a dynamic display of the signal system signalized intersections in the following two modes:

- Intersection phasing
- Intersection plan

The graphic shall also dynamically display the status of the controllers (e.g., coordination, emergency vehicle preemption, railroad preemption, transition, free operation, flashing, failure, intersection phase status). Intersection status and roadway links shall change color dynamically based on user definable color selection.

Intersection phase status (green, yellow and red) shall be displayed in real-time on the intersection phasing icon. The intersection control status shall be displayed as the background color on the intersection plan icon. Intersection plan information shall be displayed as a number on the intersection plan icon.

Link status shall be shown as different (user defined) colors for differing traffic flow conditions.

The system display shall be capable of being dynamically sized by a workstation user. Resizing the window shall not reduce the amount of data displayed on a workstation monitor and the same aspect ratio shall be monitored as before the resizing.

#### b) Control Section Map

Create default subsection maps/zones or areas to provide a display. The default displays will be called control section maps, and shall provide a more detailed display of selected zones or areas of the system. A control section shall be able to be called from the system map display via a double mouse click or from a drop down menu. A minimum of fifteen (15) control section displays shall be capable of being simultaneously displayed while the system map is open and the maximum number intersection display windows are open. The control section map interface shall be an integrated portion of the distributed processing system software and shall not be a stand-alone package.

The control section map shall provide a dynamic display of the signal system, including landmarks, streets, signalized intersections, interstate highways (if applicable), railroads (if applicable), system detectors, system detector actuation. Labels for these items shall also be displayed. All labeling shall be approved by the Engineer. The graphic shall also dynamically display the status of the controllers in the sub-area (e.g., coordination, emergency vehicle preemption, railroad preemption transition, free operation, flashing, failed, intersection phase status). Volume and occupancy levels shall be displayed as color bars on the map. Intersection phase status (green, yellow, and red) shall be displayed in real-time using arrow icons. Link status shall be shown as green for free flow or near free flow conditions. Yellow shall be shown for moderate congestion or transition conditions. Red shall be shown for congested conditions, and flashing red shall be used to indicate severe congestion or major delays. The control section display shall be capable of being dynamically sized by a workstation user. Resizing the window shall not reduce the amount of data displayed on a workstation monitor, and the same aspect ratio shall be monitored as before the resizing. The control section map graphic shall include a user-definable control section map title. North shall either be at the top or right side of the monitor when displaying a control sub-area. Vertical and horizontal scroll bars may be provided if the size of the sub-area is such that it cannot be displayed on a monitor at a scale (as determined by the Engineer) that is adequate for viewing by the operator. Refer to the System Detector Schematic in the Plans for control section boundaries and numbering. There will be a maximum of 30 control section Map displays. Submit a sample of a control section display or map for review by the Engineer.

#### c) Intersection Display

The intersection graphic shall display both static and dynamic information. The static information shall include the intersection name, geometrics of the intersection (including a graphic display of the number of lanes and their associated use), adjacent land use, the location of the controller, and a layout of the intersection with the intersections signal locations and number of heads. The dynamic information to be displayed shall include:

- All vehicle signal indications for each active phase, and up to sixteen (16) overlaps with red, yellow, and green indicators
- All pedestrian signal indications, for up to sixteen (16) active phases. WALK, flashing DONT WALK, and steady DONT WALK shall be shown
- Vehicle and pedestrian detector actuations for each active phase
- Cycle timer (central and local clocks)
- Timing plan in effect (with cycle length and offset)

- Operational status of the intersection shall include the following, but not be limited to:
- Timing in effect (in coordination, TOD, TR, etc.)
- Status mode (transition, free operation, flash, preemption (railroad or emergency vehicle))
- Control mode (manual control, local control, failed, etc.)

The intersection display shall accommodate all ASC/3<sup>®</sup> phasing.

The intersection display shall be capable of being dynamically sized by a workstation user. Resizing the window shall not reduce the amount of data displayed on a workstation monitor.

#### **14. Intersection Monitoring**

The status of each controller shall be monitored and any detected error condition shall be logged. Error conditions shall be stored in a form that specifies the type, date, and time of the error. Error processing shall be performed during both coordinated and free operations.

The software shall monitor for the following conditions:

#### **15. Communications Status**

The system software shall report the present status of the communication system at the controller. Changes in status of the communication system shall be recorded in the system log.

#### **16. Communication Error**

If communication between the communications server and local intersection is lost for a number of consecutive seconds, a failure shall be identified and an error message shall be logged and the intersection shall be dropped from system monitoring. Upon identification of a communications error, the software shall continuously attempt to re-establish communications to the intersection and regain monitoring of the intersection.

#### **17. Flash Conditions**

The system shall have the following flash mode capabilities:

- **Central Flash:** Individual intersections and control sections shall be capable of being placed on flash by operator command or schedule entry.
- **Cabinet Flash:** Cabinet flash mode shall be indicated when a controller enters flash via manual selection at the cabinet.
- **Conflict Flash:** Conflict flash shall result from a tripped conflict monitor at the local intersection. Conflict flash shall be logged as a failure by the software system.

The type of flash mode (central, cabinet, or conflict), the intersection name, date and time shall be logged for each entry or exit from flash.

#### **18. Local Preemption**

The system shall monitor and recognize the occurrence of preemption at each local intersection. Accordingly, a preempted intersection shall not be erroneously diagnosed as having experienced a coordination failure. System log messages shall be recorded to note the beginning and ending times of local preemption and the type of preemption (e.g. emergency vehicle, railroad, etc.).



**19. Implemented Local Manual Control**

Local manual control shall be initiated and controlled by hardware at the intersection. The software shall identify any intersection that is in local manual control by means of a status message. Accordingly, an intersection being operated under manual control shall not be erroneously diagnosed as having experienced a coordination failure. When the local manual control status has been removed, the local software shall initiate the transition back to normal operation and the system log messages shall be recorded at the start and end of local manual control condition.

**20. Local and System Detectors**

The system shall allow users to set up and gather detector data from local and system detectors for traffic responsive operation or other analytical purposes.

The software shall be able to recognize and report failed detectors (e.g. constant call, no calls, etc.). A detector shall be automatically suspended from use if it is failed. Parameters for determining under counting, over counting, maximum presence shall be adjustable by the user. Detectors classified as marginal shall remain in use, but shall be identified. A change in classification to either failed or marginal and the reason for the change shall be reported to the operator and automatically entered in the system log. A reclassification to acceptable shall also be logged. System detector activity reported from any local controller type shall be monitor for under counting, over counting, and maximum presence.

Regardless of the classification status of any detector, detector status reporting shall continue unless inhibited by an operator command. A detector that has been suspended from use due to a failure shall remain suspended until its operation has been reclassified as either acceptable or marginal, or until the operator enters a command that releases it from suspension.

Detector data smoothing shall be provided to prevent short-term fluctuations from incorrectly influencing traffic-responsive control algorithms. The system software shall automatically use historical data for the traffic-responsive control algorithms when detectors have been classified as failed.

**21. Timing Plans**

An intersection timing plan shall be defined as a unique combination of cycle length, split and offset at an intersection. The software shall monitor a minimum of sixty-four (64) timing plans for ASC/3<sup>®</sup> controllers. In addition, the software shall enable selection of both flashing and free operation of any intersection.

Cycle lengths, offsets, and splits shall be reported in one-second increments, or as a percentage of the cycle length if selected by the user.

Whenever a new timing plan is implemented, each controller shall achieve the new offset by implementing a transition with respect to the new cycle clock reference. For each intersection on the system, the software shall recognize and display a message that local transition is in effect.

**22. Phase Movements**

The system shall monitor each independent movement of up to sixteen (16) phases, for the quad-ring ASC/3<sup>®</sup> controller. This monitoring shall include force off points, and permissive periods for each phase.

**23. Clock Updates**

Following each update of the clock on the communications server, the system shall update the clocks in each local controller and the distributed system server.

The system shall be able to receive clock updates from an external time synchronization source. Clock updates shall be demonstrated and approved by the Engineer. The system shall broadcast, unicast, or use a combination of both to send time updates to controllers on a user-configurable schedule. The user shall be able to configure how often the broadcast is performed, the hour at which the broadcast begins, the number of times the broadcast is repeated, and the time period between repeated broadcasts.

The system shall provide a means of monitoring the time drift of clocks on controllers, provided the controller supports this functionality.

For each controller that supports this functionality, the system shall allow checking controller clock times on a user-specified interval.

The system shall display the time the controller's clock was last checked and the difference between that controller clock and the system time reference.

The system shall also provide the ability to automatically synchronize a controller's clock if the time drift exceeds a user-specified threshold.

The system shall provide a means to synchronize controller clocks with the system time reference upon user command.

This functionality shall be provided in addition to the scheduled time broadcasts previously specified.

**24. Intersection Control**

The software shall allow any user to control and implement changes to any intersection controller via the GUI, either through scheduled events, manually controlled events, or time-of-day plans programmed in the local controller. All parameters and events that can be programmed from the controller front panel shall be available at central for remote implementation. Any aspect of the controller timing shall be assessable from central, and shall allow editing of all timings. Full upload and download of timings to controllers shall also be allowed.

**25. Central Scheduler**

It shall not be necessary to use a special function to implement any of the local controller's basic functions. These functions shall be inherited from the timing plans associated with each type of controller.

The system shall include a centrally based event scheduler that issues scheduled commands to local controllers. The set of schedulable events shall include:

- Coordination plans
- Software flash
- Free operation
- Local TOD
- Traffic responsive operation
- Holidays

- Special Functions (supported by local controller type, including one-time events)

The event scheduler shall support the following features:

- **Day Plans:** The scheduler shall support scheduling of up to 100 unique day plans. Each day plan shall support up to 100 individually schedulable events. The individual events shall be implemented for a specific controller or a control section. The time resolution of each event shall be one minute.
- **Week Plans:** The scheduler shall support up to 52 week plans. Each week plan shall support individual day plan selection for each day of the week.
- **Annual Calendar:** An annual calendar shall support both week plan and individual day plan selection. The calendar shall automatically roll permanently scheduled events from one year to the next.
- **Individual Event Scheduler:** The scheduler shall support up to 500 Individual events to be scheduled at a higher priority than the Calendar events.
- **Manual Command/Temporary Event Scheduler:** The scheduler shall support implementation of temporary events. These events shall be programmed to begin immediately or within a scheduled timeframe. These events shall be automatically deleted from the system upon completion.

a) Time-of-Day Operating Mode

The Time-of-Day/Day-of-Week/Day-of-Year (TOD/DOW/DOY) mode of operation shall allow the advance scheduling of the signal plan and timing plan to be implemented in each section. TOD/DOW/DOY scheduling shall be performed based on the schedule data stored locally at the controller and updated by upload/download operations.

b) Coordination Plan and Scheduler Resolution

Events in the scheduler (both turn-on and turn-off) shall be adjustable in minimum increments of one minute.

c) Section (Zone) Control

The software shall achieve coordinated operation across the boundaries of all control sections operating on the same cycle length or on multiples of the same cycle length by ensuring that all such control sections are synchronized to a common reference.

Timing plan selection shall not be limited to entire sections. Timing plans, at the discretion of the system operator, shall be implemented for a single intersection, section of intersections, or system-wide. The timing plan shall be selectable by the operator (Manual mode), by a time clock scheduler (Time-of-Day/Day-of-Week mode), or by the local controller itself.

d) Traffic-Responsive Operation

In traffic-responsive operation (TRO), the system software implements a V+kO, threshold matching algorithm, and shall select the timing plan based upon system detector information and coordination threshold parameters that have been defined by the user.

The system database shall identify the system detectors that are assigned to each control section for traffic-responsive operation. System detectors may be assigned to more than one control section.

In traffic-responsive operation, the software shall use weighted volume and occupancy from the active system detectors. When the system is running TRO, it shall monitor the control section for failed detectors. Upon detection of failed detectors, TRO will continue to function until the percentage of failed detectors exceeds an operator-specified threshold. The section shall then automatically switch to the TOD/DOW/DOY timing plan. This plan shall remain in effect until the percentage of failed detectors is below a different operator specified threshold. At this time traffic-responsive operation shall automatically resume.

Minimum plan execution time and threshold hysteresis shall be established by the operator to prevent excessive switching between timing plans. The minimum time between timing plan changes for any given section shall be measured in one-minute increments; this value shall be separately defined for each section.

The user shall have the ability to run traffic responsive as a background process wherein a traffic responsive plan is selected, but not implemented. This shall allow the user to verify traffic responsive operation in an off-line mode.

## **26. Database Management**

The system shall be built around a multi-user commercial off-the-shelf (COTS) database software product. The database shall be used to store, retrieve, and maintain system data and parameter files and shall be available for common computer hardware platforms. The database system shall use structured query language (SQL) and conform to Microsoft's open database standards.

The software shall provide user-friendly database facilities that allow changes to be put into effect while the system remains fully operational. The system shall provide the following database management features.

The database management software shall allow programming of the intersection controller databases. Each intersection controller shall have separate database programming pages. These pages shall contain all the programming options unique to each intersection.

All programming entries shall primarily consist of numerical values, "Yes" or "No" entries, and bit data. During configuration data entry, the new data shall overwrite the old data. If the data is in error, changes shall not be permitted and the user shall be alerted by either an error message on the display or a warning tone.

All data items entered from any workstation shall be tested for data type (numeric or text) and allowed range. All string data items shall be tested to ensure that they do not exceed the allowed length. The program shall not terminate because any data item is incorrectly entered. When errors or potential errors are detected, the program shall either display a specific diagnostic message on the screen or shall give an audible alarm and shall place the cursor in the proper field. In any case, the system shall allow the operator to re-enter the item. Prior to or simultaneously with reentry, the diagnostic message, if any, shall be erased.

Whenever a logical grouping of data (such as a full screen or the complete database file) has been entered or edited satisfactorily, that data shall be written to the proper record. This may take place upon return to the main menu or, alternatively, it may take place as the entry or editing of each distinct file is ended.

The screen organization and data entry/edit method shall enable the operator to use all functions without the need to use reference manuals or cards. The software shall minimize the use of mnemonics to interface with the user on the screen, in printed reports, and in the system's documentation or worksheets. Only mnemonics consisting of Engineer approved traffic engineering abbreviations and other straightforward abbreviations shall be acceptable.

All field descriptions and inputs shall be simple and all text shall be in simple English and common traffic engineering terminology. It shall not be necessary to perform any decoding to read the information. All necessary field descriptions shall be specifically and discretely provided on the same display screen as they are needed.

a) Copy Facility

It shall be possible to copy an entire controller database (except for intersection name and identification number) from one controller database to another controller database.

It shall be possible to copy from within the database software all logical segments of the controller database to other like segments of the same controller database using menu commands (IE Timing Table page 1 → Timing Table page 2).

It shall be possible to copy from within the database software all logical segments of the controller database to other like segments of another controller database using menu commands (IE Timing Table page 1 [intersection 100] → Timing Table page 2 [intersection 101]).

It shall be possible to copy from one cell within a database table to another like cell in the same table (IE min green phase 1 to min green phase 2).

b) Upload/Download of Database

Any workstation shall provide for uploading (copying) the database, and logical segments thereof, from any 2070LX controller. The software shall similarly provide for downloading (copying) the database, and logical segments thereof, to a 2070 controller using ASC/3<sup>®</sup> firmware from any workstation.

Uploading a controller database from the field to central (or downloading from central to the field) from one type of controller to another type shall not be permitted.

The upload/download feature shall use block transfer techniques with a cyclic redundancy check (CRC) to ensure data integrity. Non-verified data shall cause termination of the upload or download operation, with no transfer of the corrupted block occurring. A status message shall be displayed when improper termination of the upload or download operation occurs.

c) Database Comparison

Following an upload, the system shall allow the operator to compare the database of any intersection controller to the database stored for that intersection on the file server. This comparison shall identify any differences between the uploaded and stored file data. The system operator shall be able to correct, use, or substitute data values and proceed with further comparison. Provide a means to view/locate stored data on file server.

## 27. Reports

The system shall generate a number of pre-configured reports. The database software shall permit the operator to use structured query language (SQL) to retrieve data and produce pre-configured reports. System report information shall be able to be exported to a XML file with

report data, CSV (comma delimited), PDF file, TIFF file or a Microsoft Word file. All reports should show asset ID number, main street, cross street, asset type and prevalent information to the asset.

The formats (samples) of all pre-configured reports shall be submitted to the Engineer for approval.

The list of pre-configured reports shall include, but not be limited to, the following:

- System Errors/Alerts
- Communications Status Online/Offline
- System and Local Detector VOS Data
- Device Communications Configuration
- Device Configuration
- Events Log
- Control Section/Links Data
- Scheduler
- Signal Changes
- Signal Detector Events
- Split Monitor
- System Activity
- System Events
- Time Drift
- Upload and Compare
- User Login
- Detector VOS
- Daily
- Hourly
- Multi-date / Hourly
- Multi-date / Daily

Use of third party software for the development of custom reports shall be provided by the Contractor. The software shall interface with the signal system software and its data base to allow the user to create custom reports. The user shall be able to define the format of those reports. The system shall also provide a means by which user-specific reports can be created and added to the Reports menu item without the requirement of additional software or custom development work by the software provider.

Training shall be provided on the editing, creation, exporting and general use of pre-configured and custom reports.

## **28. Security**

In addition to the network security features provided by the operating system, the software shall provide customizable levels of access security. Each user must enter a login name and password before gaining access to the software.

The system shall accept any number of users to be configured onto the database. The system shall have three default levels of security, as follows:

- Admin User
- Read Write
- Read Only

The top level (Admin User) shall provide for total access (i.e. permit the operator to view and change all information in the system). Only users with this authorization shall be permitted to view or change access security codes, add new users and delete existing users.

A bottom level (Read Only) shall permit viewing of all information (except access security codes) yet not permit the operator to make any changes to the database.

The system shall also provide the ability to customize each user's privileges with respect to system functionality. Privileges can also be defined with interjurisdictional rights. Specific privileges shall be configurable for each user, with respect to each of the following System Permissions:

- User Setup (Admin User Only)
- Asset Group
- Location
- System Preferences
- Archive Logs
- Export Logs
- Restore Logs
- Purge Logs

Specific privileges shall be configurable for each user, with respect to each of the following Traffic Permissions:

- ITS Communications Server Setup
- Detectors
- Sections
- ICM Port Configuration
- Scheduler
- Traffic responsive
- Time Space Diagram
- AEM
- W4 Special Functions
- Traffic Preferences

Specific privileges shall be configurable for each user, with respect to each of the following alarm assignments:

- Central Communications Failure
- Field Communications Failure
- Technician Flash
- Monitor / Conflict Flash
- Controller Error
- Stop Time
- Detector Failure

- Police Switch
- Door Open
- Local Clock Failure
- Special Function 1
- Special Function 2
- Special Function 3
- Special Function 4

Each user shall have separate privileges to each asset group (a group of intersections defined within the system, which may cross jurisdictional boundaries, allowing multiple agencies to use a single system). Specific privileges shall be configurable for each user, with respect to each of the following asset group functions:

- Properties
- Delete
- Graphics Editor
- Timing Tables
- Upload
- Download
- Manual Commands
- Real Time Clock

## 29. Help

The signal system software shall have comprehensive, online help screens. The help screens shall be context sensitive, providing information specific to the highlighted fields or windows displayed.

### C. Local Controller Firmware

The Engineer will provide local controller firmware that is the latest version of the NCDOT-approved controller software ASC/3 at the time of burn-in. Request the software from the Engineer a minimum of five business days prior to burn-in. The controller firmware Econolite ASC/3 controller shall be compatible on all variants of Safetran 2070LX configurations as well as the following other controller manufacturers' configurations:

Component	Manufacturer	
	McCain	Intelight
Field I/O	M44021 Rev. B	2070-2A Rev. H1
Front Panel	M44017 Rev. A	2070-3B Rev. E1
Power Supply	M34020 Rev. A5	2070-4A 300101-0001
2070-1C Host Card	M52803 Rev B	2070-1C Rev. D2/D4*
2070-1C Engine Board	M52284 Rev A	2070-1C Rev. G1
2070-1C Linux Kernal	2.6.22	3.14
Installed Software	ATC Menu and No Traffic Application	App Manager and No Traffic Application



## **D. System Support Software and Devices**

### **1. Devices**

Furnish one (1) Garmin eTrex Legend GPS Receiver, or approved equivalent, with Cigarette Lighter Adapter (#010-10203-00).

### **2. Productivity Software**

Furnish a network version of the latest release of the Microsoft Office, Professional Edition, including Excel, Access, Word, and PowerPoint. A license shall be provided for each workstation and notebook computer furnished with the project. Furnish and install a copy of the latest release of Microsoft Office, Professional Edition, on each workstation and notebook computer furnished.

Include a complete user's manual and original installation disks or CD-ROMs for each software package. Provide full technical and maintenance support for all software.

### **3. Utility Software**

Furnish utility software for uploading and downloading timing plans locally at the signal cabinet. Furnish software that is compatible with local controller software and signal system central software. Furnish software with printing functionality. Provide a copy of the utility software on all notebook computers furnished under this project. In addition, provide a copy of the utility software to the Engineer prior to Final Acceptance.

## **34.3. INSTALLATION AND INTEGRATION**

### **A. General**

Install and fully integrate distributed processing signal system software on ITS Application Server called for in "Computer Hardware and Peripherals" section of these Project Special Provisions. Install and fully integrate distributed processing signal system software on each notebook computer for the Elizabeth City signal system.

Install and fully integrate distributed processing signal system software with the ITS Communications Server called for in "Computer Hardware and Peripherals" section of these Project Special Provisions as required.

Install all software furnished for the system in accordance with the procedures recommended by the software supplier.

Install a copy of the distributed processing traffic signal system software and all communications software necessary to achieve remote operations on the notebook computers.

Register all software products furnished with this project with the software supplier. NCDOT shall be identified as the registered owner of all software.

### **B. Distributed Processing Signal System Software**

Install and integrate the distributed processing traffic control applications software and all other software with the communications system and local controllers to provide a traffic signal system that provides the functionality required by these Project Special Provisions.

Load all parameters necessary to implement coordinated signal operations. The Engineer will furnish the timing parameters in standard traffic engineering format (cycle, split, and offset) prior to the initiation of the 60-day observation period. Make any modifications to the cycle,

split, and offset information furnished by the Engineer that are necessary to implement the timing plans into the system database. The test period may not begin until the timing parameters have been loaded. The Engineer may, at his/her option, observe the loading of the timing plans.

As directed by the Engineer, make modifications to the coordinated signal timing parameters (cycle, split and offset) prior to system acceptance to improve system coordination and efficiency. The Engineer will furnish the parameters to be modified by the Contractor. Make these modifications at no additional cost. No timing plan changes will be required after the successful completion of the system operational test (as approved by the Engineer).

Prepare comprehensive, detailed graphic displays for the system display, for all control section displays, and for all intersection displays. Contractor shall install all displays and fully integrate with system software. Submit all graphics to the Engineer for approval prior to the System Operational Test and prior to integration in the software.

Program all new system detectors installed under this project, and all existing system detectors being reused, in the signal system software. Install all associated graphics related to system detectors. Integrate system detector locations (based on the actual installation in the field) on all associated system graphics.

Submit specific landmarks and features to be displayed in the section and intersection displays to the Engineer for approval. Develop each screen upon approval of the areas to be displayed by each screen and make revisions as required from review.

Provide training to Department personnel relative to the creation and editing of the sub-area and intersection displays as required in these Project Special Provisions.

### **C. Local Controller Firmware**

Install NCDOT-furnished local controller firmware on all new controllers. Use the latest version available at the time of installation as directed by the Engineer. Request local controller firmware from Engineer a minimum of one (1) week prior to use of software during burn-in period.

The Contractor shall demonstrate porting and functionality of Econolite ASC/3 controller software on the controller vendors listed in Subsection C for “Local Controller Firmware” under “General Requirements” of this Section of these Project Special Provisions. This demonstration will be required on all three configurations of controllers regardless of the manufacturer that is selected for the Project.

All controllers in the final signal system shall have identical local firmware.

### **D. System Support Software and Devices**

Install software, devices, productivity software, and utility software on all workstations and laptop computers provided with the project.

## **34.4. TESTING**

### **A. General**

Provide the following tests and demonstration of the system software:

- System Demonstration Test, if required (see below)
- System Operational Test (as called for in “Testing and Acceptance” section)

- 60-Day Observation Period (as called for in the “Testing and Acceptance” section)

### **B. System Demonstration**

If the signal system software package proposed for this project has not been deployed for a state or municipal system in North Carolina, a system demonstration is required. Otherwise, the system demonstration requirements are considered to have been fulfilled under previous projects.

Within one-hundred (100) calendar days after award of the contract, demonstrate ability to provide a working traffic control system that will be in general accordance with these Project Special Provisions. This shall be accomplished by conducting a demonstration of the major elements of the traffic control software at an existing, operational traffic signal system somewhere within the United States or Canada, excluding Alaska and Hawaii.

The demonstration shall take place at an actual, operating traffic signal system that features software developed and furnished by the same vendor proposed by the Contractor for this project. The candidate demonstration system shall have actual functional performance that is similar to, or better than the system required by these Project Special Provisions. A minimum of thirty (30) days prior to this demonstration, the Contractor shall submit to the Engineer a detailed description of the features provided by the candidate demonstration system and a narrative discussion of how that system differs from the functionality required by these Project Special Provisions. The Engineer shall be the sole judge as to whether or not the candidate demonstration system is sufficiently similar to the one required for the Elizabeth City Signal System. All transportation, lodging and per diem costs for NCDOT personnel to witness the system demonstration will be borne by NCDOT.

### **34.5. MEASUREMENT AND PAYMENT**

*Signal system software* shall be measured and paid as a lump sum, including furnishing, installation and testing, and all materials, 3<sup>rd</sup> party software for reporting, equipment, labor, tools, storage, shipping and incidentals necessary to install the software, complete system integration and provide a complete operational system. Partial payment for this item will be made as follows: 70% of the lump sum price upon delivery and installation of the software and 30% of the lump sum price upon successful completion of the Observation Period. No payment will be made for providing software license and source code as required in these Project Special Provisions.

*System support software and devices* shall be measured and paid as a lump sum, including furnishing and installation, and all materials, equipment, labor, tools, storage, shipping and incidentals necessary to install and configure the software and provide a complete operating system. Payment for this item will be made as follows: 100% of the lump sum price upon delivery, installation and testing of the software into the appropriate hardware. GPS receivers will not be paid for separately but will be incidental. No payment will be made for providing software license and source code as required in these Project Special Provisions.

All other software and hardware otherwise required to accomplish the functionality required by these Project Special Provisions will not be paid for separately but will be incidental. No payment will be made for providing software license and source code as required in these Project Special Provisions.

Contractor shall purchase the licenses for the distributed processing system software.

The controller firmware will be furnished by the Department, the Contractor will conduct demonstration test described in these Project Special Provisions and install the firmware on each controller in the project. The cost of installation of the firmware will be included in the cost of the controller installation.

Testing will not be paid for separately but will be incidental to equipment installation.

Payment will be made under:

<b>Pay Item</b>	<b>Pay Unit</b>
Signal System Software	Lump Sum
System Support Software and Devices	Lump Sum

### 35. COMPUTER HARDWARE AND PERIPHERALS

#### 35.1. DESCRIPTION

Furnish and install all materials with the most recently developed and approved product versions that meet or exceed all applicable standards, specifications, and requirements before the system is considered for acceptance. Ensure that all equipment features, functions, and performance measures are met.

Furnish, assemble, fabricate and install new products obtained from the manufacturer or reseller. Provide commercial off-the-shelf materials, equipment, and components.

Furnish and install ITS servers and one laptop for the signal system supervisor in the TMC. Ensure that all laptop computers can access the ITS LAN and can be used to monitor, interact, and control all critical input and output parameters of the traffic signal system and ITS devices.

#### A. ITS Servers

Furnish and install ITS servers to host the signal system software, communications applications, video decoding and video display.

##### 1. Signal System Servers

Furnish and install signal system servers in the TMC as described in the Plans and these Project Special Provisions. Furnish and install application servers (one primary signal system application server and one redundant signal system application server) in the TMC. Connect the servers in the TMC to the Ethernet core switch and to a UPS protected outlet. (Additional information on Ethernet Core Switch and UPS for communications rack in the “Communications Hardware” section of these Project Special Provisions.)

##### 2. Video Servers

Furnish and install a video server in the TMC as described in the Plans and these Project Special Provisions. Furnish and install a video server for the management and control the CCTVs and video monitor in the TMC. Connect the server in the TMC to the Ethernet core switch and to a UPS protected outlet. (Additional information on Ethernet Core Switch and UPS for communications rack in the “Communications Hardware” section of these Project Special Provisions.)

#### B. Laptop Computers

Furnish and install the signal system supervisor’s computer system consisting of a laptop with two power supplies (one for docking and one for portable use), docking station, two monitors, keyboard, and mouse in the TMC. Also provide carrying bag with additional mouse for portable use.

#### C. KVM Switch

Furnish and install a rack-mounted KVM switch assembly consisting of a monitor, keyboard, and mouse with switching hardware to control and access the servers supplied with this project.

#### D. UPS – Signal System Supervisor’s Laptop

Furnish and install uninterruptible power supply (UPS) unit(s) for the signal supervisor’s computer system in the TMC. The UPS shall also include any ancillary equipment or incidental items, such as required cabling.

## 35.2. MATERIALS

### A. ITS Servers

#### 1. Functional

The ITS servers shall integrate the signal system supervisor's computer with other ITS systems and shall enable video and data accessibility and exchange between various systems. The servers shall function in automated fashion in unmanned mode supporting clients' control functions via ASN.1 and/or XML-defined protocols over TCP/IP. Provide the servers capable of operating in the following configurations:

- Single server configuration (environments with n\*10 controlled objects).
- Multiple server configuration (environments with n\*100 controlled objects).
- Thin server configuration (active control of local part in case of larger system).

Provide ITS servers meeting the following functional requirements:

- Handle commands from system clients via ASN.1 and/or XML defined protocol over standard TCP/IP connection.
- Command underlying nodes (devices such as encoders, video servers).
- Report status of system nodes and alarms.
- Monitor system nodes connections.
- Store recent alarms in internal database.
- Receive Simple Network Management Protocol (SNMP) traps generated by network infrastructure, translate SNMP traps as system alarms, and send alarms as SNMP traps.
- Support remote configuration and diagnostics.
- Restore video and connections in case of system component restarts.
- Support protocols: TCP, UDP, NTP and IP Multicast IGMP.

#### 2. Performance

Provide one signal system application server and one backup application server meeting the following minimum requirements:

- Chassis: Sized for up to eight (8) 3.5-inch hard drives,
- Processor: Dual quad core Intel Xeon E5-2640 v3 or better at 2.6 GHz or greater, QPI, HT, 8C/16T, 20 MB cache, max 1866 MHz, 8.00 GT/s,
- Memory: Minimum 32 GB (4x8 GB) RDIMMS, 2133 MT/s, dual rank, x8 data width,
- Backplane: 1x6 backplane for 3.5 inch drives, expandable to eight drives,
- Power Supply: Dual hot plug and redundant, separate power cords, NEMA 5-15p to C13 wall plug, 15 amps,
- PCIe Riser: Riser with three x 8 PCIe and one PCIe x16 slots
- RAID Controller: PERC H730, 1 GB NV cache,
- Raid Configuration: RAID 5 for H330/H730/H730P (3-16 drives),
- Hard Drives: 4 x 300 GB, 10k RPM, SAS, 6 Gbps 2.5-inch hotplug, 3.5-in HYB CARR,
- CD/DVD ROM: DVD +/-RW SATA Drive, internal,

- Video Card: Integrated video chipset controller 8 MB SD RAM with 480 MB/s memory bandwidth and DirectX 5.0,
- Video Adaptor: SGVA,
- Mounting: Slide rails and cable management arm,
- Network: Broadcom 5720 QP 1 GB daughter card,
- Embedded Controller: Out of band management, iDRAC8 Express, integrated remote access controller,
- Operating System: Microsoft Server 2016, Standard Edition with 5 CALs, and
- Database Software: Microsoft SQL Server 2016, Standard Edition, with 10 CALs.

Provide one video management server meeting the following minimum requirements:

- Chassis: 8GB L3 cache, 866 MHz,
- Memory: Minimum 8 GB DDR3-1600,
- Processor: Dual processor Intel i7 at 3.6 GHz or greater, 2,133 MHz,
- Power Supply: Hot-plug and redundant, NEMA 5-5p to C13 wall plug, 15 amp,
- RAID Controller: PERC H330, 1 GB NV cache,
- Hard Drive: SATA, 1 TB, 256 MB cache, 6 Gbits/s, 7200 RPM,
- Video Output Card: Integrated video chipset controller 8 MB SD RAM including 3D 60 MHz memory, 480 MB/s memory bandwidth and DirectX 5.0,
- Video Adaptor: VGA,
- Mounting: Slide rails and cable management arm,
- Network: 2 x 1 GB,
- Embedded Controller: Out of band management, integrated remote access controller, and
- Operating System: Microsoft Server 2016, Standard Edition and 5 CALs.

### 3. Physical Features

Provide rack-mounted ITS servers for proposed enclosed 19-inch communications rack located in the TMC. Provide servers with a maximum size of 2 RUs.

Provide servers meeting the minimum following power requirements:

- Power supply: 110-130 VAC.
- Power consumption: Typical 750W per power supply.

Provide servers meeting the following data port requirements:

- Serial: One standard serial port,
- Audio: Three jacks – channel out, line in, and microphone.
- Ethernet: Dual 1000 Base T Ethernet with RJ-45 connectors as described above and
- USB port: Four USB 2.0 ports.

Provide servers with at least one direct 10/100/1000 Base T Ethernet LAN interface. The network connector shall be RJ-45 for Category 6 STP for interfacing with the signal system's Gigabit Ethernet core switch.

## B. Laptop Computers

### 1. Functional

Provide laptop computers that can operate the signal system software and the video control software over an Ethernet network in field cabinets, and remotely.

### 2. Performance

Ensure that the laptop computers meet the following requirements. Ensure that the laptops have the capability to be networked with ITS LAN via an Ethernet cable connection through the Gigabit Ethernet core switch located in the TMC and over the Internet. Configure the laptop computers for connection anywhere in the network to facilitate maintenance and troubleshooting activities.

- Processor: Intel quad core i7-6820HQ at 2.7 GHz or greater, 3.60 GHz Turbo mode, 3M L2 cache at 1066 MHz,
- Memory: 8 GB (2x4GB) 2133MHz DDR4 SDRAM, Non-ECC,
- Network: Integrated 10/100/1000 Base T Ethernet with RJ-45 connector, 802.11g wireless LAN card,
- WiFi Adaptor: Dual-band, AC 8260, 802.11 A/G/N 2X2 mini card with Bluetooth 4.1,
- Hard Drive Controller: C1, All SATA drives, non-RAID,
- Hard Drive: 256 GB M.2 PCIe NVMe Class 50 Solid State Drive,
- CD-ROM: 8X DVD+/-RW combo drive,
- Keyboard: 104 key model,
- Mouse: USB, 2 three-button optical mice,
- Audio: Miniature phono jacks – line out, line in, and microphone
- Sound: Integrated audio with internal speakers,
- Video Adaptor: 2 GB GDDR5 memory, 128-bit bus width, 80 Gbps memory bandwidth, MXM 3.1 Type A device type, 3 monitor support, VGA, or HDMI support, 4096x2160 maximum external resolution, 128-bit, 993 MHz clock speed,
- Internal Monitor: 16.5-inch HD, LED backlit, 1920x1080,
- Operating System: Windows® 10 Professional, 64-bit, latest version,
- Application software: Microsoft Office 2016 Professional Edition, Enterprise version of Norton antivirus software and DVD burning software, and
- Other Accessories: Two AC adaptors per laptop, spare battery and nylon travel bag.

### 3. Physical Features

Ensure that the laptop computer operates on an input voltage of 90 to 135 VAC at 50/60 Hz. Provide laptop computers meeting the following minimum port requirements:

- Audio: Three jacks – channel out, line in, and microphone,
- Ethernet: 10/100 Base T Ethernet with RJ-45 connector, and
- USB Port: Two USB 2.0 ports.
- Monitor: LED, anti-glare screen (for outdoor use in sunlight)



Equip the laptop computer with at least one direct 10/100 Base T Ethernet LAN interface. Ensure that the network connector is an RJ-45 for Category 6 STP to interface with the Ethernet core switch.

### **C. Workstation Monitors**

Provide computer monitors for the proposed computer installation for the signal system supervisor.

#### **1. Performance**

Provide computer monitors meeting the following requirements:

- Display: LED, 24-inch, digital flat panel display, DVI-D, HDCP DisplayPorts,
- USB Ports: USB 3.0, one upstream port and three downstream ports,
- Resolution: 1,920 x 1,080 dpi,
- Pixel Pitch: 0.275 mm
- Viewing Angle: 178 degrees vertically and horizontally
- Contrast Ratio: 1,000:1 (typical) and 10,000:1 (dynamic)
- Brightness: 250 cd/m<sup>2</sup>
- Colors: 16.7 million colors.

#### **2. Physical Features**

Provide computer and laptop monitors meeting the minimum power requirements:

- Input voltage: 90-135 V at 50/60 Hz, and
- Output wattage: 825 W.

### **D. Docking Station**

Provide a docking station that supports a minimum of 3 monitors and the minimum port requirements for the associated laptop.

### **E. KVM Switch**

#### **1. Functional**

Provide keyboard-video-mouse (KVM) assembly that can access and provide operator interface for at least 10 servers. The KVM switch may have either an integral tilt-up screen or a separate screen.

#### **2. Performance**

Provide KVM meeting the following requirements:

- Meets EIA-310C & IEC-3 specifications,
- The KVM assembly shall include KVM switch, keyboard, flat screen display, and associated cabling,
- Port selection by pushbuttons, on-screen display, or hot keys,
- Remotely accessible over the network,
- Active port status LEDs,
- Administrative and user assignable rights,
- IP addressable,

- Compatible with Windows® 7 Professional and Windows® Server 2008,
- Support video resolution up to 1,600 x 1,200 at 75 Hz, and
- Servers: Minimum of six.

### 3. Physical Features

Furnish a KVM switch meeting the following material requirements:

- Monitor: Integrated or separate 17-inch, TFT 1,280 x 1,024, 27 dpi, SGVA, LED, folding rack-mounted, contrast ratio of 350:1, frame rate of 60Hz (typ.), 75Hz (Max),
- Keyboard: 104 key model,
- Mouse: Touch pad,
- KVM switch: Rack-mounted, maximum 2 RU size,
- Cabling: All power, keyboard, mouse and display cabling between each server and the KVM assembly; and mounting brackets, and
- Power Supply: 120 VAC.

## F. UPS - Workstation

### 1. Functional

Provide UPS unit(s) that produce uninterruptible power and power conditioning for the signal system supervisor's computer system in the TMC.

Each UPS shall provide adequate capacity to run its respective laptop and monitor(s) without commercial power for twenty minutes. Provide load calculations for each configuration of equipment connecting to a UPS.

### 2. Performance

Provide UPS meeting the following performance requirements:

- Output voltage distortion: less than 5 percent,
- Nominal input voltage: 120V,
- Nominal output voltage: 120V,
- Input frequency: 50/60 Hz  $\pm$ 3Hz, auto-sensing,
- Output frequency (sync to mains): 57-63 Hz for 60 Hz nominal frequency,
- Waveform type: Sine wave, and
- Noise filtering: Full time multi-pole noise filtering shall meet 0.3% IEEE surge let-through; zero clamping response time shall meet UL 1449.

Verify that the UPS meets all specifications and is capable of performing all of its functions during and after being subjected to:

- Operating temperature: 0-104° F,
- Operating relative humidity: 95%,
- Storage temperature: 5-113° F, and
- Storage relative humidity: 95%.

### 3. Physical Features

Supply each UPS unit with twenty-five (25) percent spare outlets. Ensure that the UPS meets the following material requirements:

- Floor mounted for the signal system supervisor's computer system
- Sealed AGM type, maintenance free batteries,
- USB interface port,
- Status Lights: power on, power source and overload,
- Alarms: audible and remote notification, and
- Manual power on/off switch.

Supply UPS unit with multi-pole noise filtering. Ensure that the UPS remote monitoring software performs the following functions:

- Data logging,
- Event logging,
- Fault notification,
- Unattended system shutdown,
- Hibernation,
- Operating system shutdown, and
- Power event summary.

### 35.3. CONSTRUCTION REQUIREMENTS

#### A. General

Receive approval for the System Design Report described in these Project Special Provisions before submitting products submittal data, purchasing, installing and configuring the computer and communications hardware at each facility. Implement the plan upon approval.

Integrate all servers, laptops, and printers on the network so all applications will be fully functional. Install the operating system, software and antivirus software to NCDOT Information Technology (IT) standards.

Furnish all tools, equipment, materials, supplies, and manufactured hardware, and perform all operations and equipment integration necessary to provide a complete, fully operational network. Mount all TMC server equipment as shown in the Plans in existing 19" communications rack.

All cabling shall be:

- Neatly tagged with permanent labels at both ends of every cable,
- Secured with wire ties and cable management hardware in the communications racks, and
- Grounded to rack grounding hardware.

Ensure that all project IP addresses are assigned as defined in the System Design Report. Ensure the as-built documentation includes the identification of all IP addresses and VLANs, and associated hardware devices and device locations.

## **B. ITS Servers**

Install the servers described above in the proposed 19-inch communications racks located in the TMC as shown in the Plans. Install the software packages described in these Project Special Provisions.

Install all software necessary to support the signal system software and to meet all of the data communications requirements described in these Project Special Provisions, including once-per-second polling of all traffic signal controllers.

Connect proposed ITS servers to the respective Ethernet switches. Install Ethernet patch cords between the Ethernet patch panel and the managed Ethernet switch in the TMC. Plug power supplies into outlets on separate circuits. Connect servers to KVM switch. Power up and run diagnostics.

Configure the ITS LAN for remote access through the firewall with remote access software for up to four laptop licenses.

## **C. Laptop Computers**

### **1. General**

Perform the following operational tests for each computer component in accordance with the test plans. After the equipment has been installed, perform the following:

- Connect all components (monitors, mice, keyboards, existing printers, network cables, power supplies),
- Install all software required in these Project Special Provisions,
- Configure network communications,
- Map network drives and existing printers,
- Run diagnostic utilities on the hardware, and
- Print test pages for each laptop on the existing printers to verify printer configuration.

### **2. Signal System Supervisor's Laptop**

Install the computer system in location as shown in the Plans. Install the client software packages described in these Project Special Provisions.

Install the monitors with supporting hardware in the TMC. Connect the monitors to the laptop through docking station.

Connect the computer to the ITS LAN by installing Ethernet patch cords between the Ethernet patch panel and the Ethernet core switch in the TMC.

## **D. KVM Switch**

Install the KVM assembly in the existing 19-inch communications rack with the ITS servers in the TMC. After the KVM assembly has been installed, perform the following operational tests on the KVM assembly in accordance with the test plans:

- Connect all existing and proposed servers, monitors, keyboards, mice, and power supplies,
- Program the on-screen display to assign ports and bank numbers and to enter the names of each server in the menu,

- Program the KVM switch for scan features and access privileges, and
- Select each server and ensure the mouse and keyboard work the selected server and the monitor displays the appropriate server.

#### **E. UPS - Workstation**

Install a UPS unit as close as possible to the signal system supervisor's computer system in the TMC. Connect the UPS unit to a power outlet. Connect the UPS monitoring port to a USB port on its respective computer system.

Install the UPS monitoring software on the laptop of the computer system in the TMC for remote monitoring of the UPS unit. Configure the remote monitoring to send email alerts. Run the UPS diagnostics.

#### **35.4. DOCUMENTATION**

Furnish the Department two copies of the following materials prior to acceptance: installation, operation, training and troubleshooting manuals, wiring diagrams, including cable pinouts, parts lists, warranty materials, and serial and model numbers of all equipment furnished. Furnish all software and operating system on CD or DVD with original license information registered to the Department.

#### **35.5. WARRANTY**

Provide a minimum of three-year manufacturer's warranty to guarantee the materials supplied are free of defects and workmanship. The manufacturer's warranty period starts upon the date of final acceptance.

#### **35.6. MEASUREMENT AND PAYMENT**

*ITS server* will be measured and paid as the actual number of ITS servers (signal system application, video system display and control) furnished, installed and accepted.

*Signal System Supervisor's Computer System* will be measured and paid as the actual number of complete, operational, computer systems including, but not limited to laptop, docking station, two monitors, keyboard, UPS, mouse, all necessary cabling/wiring, operating system, and software furnished, installed, and accepted. No measurement will be made for power supplies (one for docking and one for portable use), carrying bag, AC adaptors, stands and video cables, or additional mouse for portable use as these will be considered incidental to the signal system supervisor's computer system.

No separate measurement will be made for UPS units supplied with the signal system supervisor's computer system. The UPS unit(s) for the computer system will be considered incidental to the pay items for signal system supervisor's computer system(s).

*KVM switch* will be measured and paid as the actual number of KVM switches furnished, installed, and accepted. If a separate LED monitor is provided, then no separate measurement and payment will be made for the monitor.

No separate measurement will be made for communication and video cables, electrical cables, mounting hardware, nuts, bolts, brackets, connectors, risers, grounding equipment, or surge suppression, as these will be considered incidental to the pay items for installing ITS servers, signal system supervisor's computer system, laptops, and KVM switch.

No separate measurement will be made for the Ethernet patch panels as these will be considered incidental to the pay item for Ethernet cable. Ethernet cable will be measured and paid in accordance with the “Ethernet Cable” section of these Project Special Provisions.

No measurement and payment will be made for removal of existing computer hardware and peripherals and existing communications hardware in the TMC as such work will be considered incidental to furnishing and installing computer hardware and peripherals and communications hardware at those locations.

Payment will be made under:

<b>Pay Item</b>	<b>Pay Unit</b>
ITS Server	Each
Signal System Supervisor’s Computer System	Each
KVM Switch	Each

### 36. COMMUNICATIONS HARDWARE

#### 36.1. DESCRIPTION

Furnish and install all equipment described below for a fully functional Gigabit Ethernet network for communication to the signal system and CCTV.

##### **A. Ethernet Core Switch**

Furnish and install a central Layer 3 managed Gigabit Ethernet core switch along with a Category 6 Ethernet cable patch panel for the TMC. Ensure that the managed Ethernet core switch provides Gigabit Ethernet connectivity at transmission rates of 1000 megabits per second (Mbps), and is expandable to 10 Gigabits per second (Gbps).

##### **B. Ethernet Edge Switch**

Furnish and install a hardened, field Ethernet edge switch (hereafter “edge switch”) for field devices. Ensure that the edge switch provides wire-speed, Ethernet connectivity at each ITS device location to the Ethernet core switch.

##### **C. Firewall**

Furnish and install a firewall appliance in the TMC to provide network security from Internet-based traffic, as well as to provide an IPsec Virtual Private Network (VPN) connectivity.

##### **D. Network Management Software**

For the communications network, utilize network management software (NMS) for configuration, troubleshooting, security, and system monitoring. The software shall be furnished and installed by the Contractor to manage and monitor the Ethernet core and Ethernet edge switches and the ITS devices. The Contractor shall perform the initial system integration of all core and edge switches installed on the project.

Install the network management software on all relevant communications hardware, including workstations, laptops and servers, as recommended by the manufacturer’s instructions. Ensure that the network management software is compatible with all elements of the network, including the Ethernet switches, workstations, laptops, and servers. Ensure the system meets the minimum technical requirements and is capable of handling expansion within the ITS network. Ensure that the software manages third party switches and hardware via Simple Network Management Protocol (SNMP) v1 or v3.

Provide system that has a graphical user interface (GUI) for the operator and shall graphically depict the equipment and maintenance/operational status using a graphical map of the system. Include setup and diagnostic utility software for both the server and client computers (licenses to be provided by the Contractor). Ensure that the system is interoperable with all end-to-end communications elements (video encoder, Ethernet switches, and video decoder) that connect each CCTV camera to analog and digital video monitors.

##### **E. Uninterruptible Power Supply (UPS) – Communications Rack**

Furnish and install a new rack-mounted UPS in the TMC to serve the Ethernet core switch, ITS servers and other equipment mounted in the communications racks in the server room. Each

UPS shall also include any ancillary equipment or incidental items, such as required mounting hardware and cabling. Furnish and install monitoring software to provide email alerts.

Furnish all materials with the most recently developed and approved product versions that meet or exceed all applicable standards, specifications, and requirements before the system is considered for acceptance. Size the UPS to provide at least 20 minutes of UPS power. Provide the UPS a 25% reserve of receptacles. Provide load calculations for each configuration of equipment connecting to a UPS.

## **36.2. MATERIALS**

### **A. General**

Ensure that all communications hardware is UL listed.

Ensure that the Ethernet switches are fully compatible and interoperable with the trunk Ethernet network interface and that the Ethernet switches support half and full duplex Ethernet communications.

Furnish Ethernet switches that provide 99.999% error-free operation, and that comply with the Electronic Industries Alliance (EIA) Ethernet data communication requirements using single-mode fiber-optic transmission medium and copper transmission medium. Ensure that the Ethernet switches have a minimum mean time between failures (MTBF) of 10 years, or 87,600 hours, as calculated using the Bellcore/Telcordia SR-332 standard for reliability prediction.

Provide all SMFO jumpers required to connect the Ethernet core switch and Ethernet edge switches with the connector panels of fiber-optic splice centers. Provide SMFO jumpers with factory-assembled LC connectors on one end (i.e., the fiber-optic interconnect center/connector housing end) and, on the other end, factory-assembled connectors of the same type provided on the managed Ethernet core switch and Ethernet edge switch.

Provide SMFO jumpers that are a minimum of three feet in length for Ethernet switches inside controller cabinets, CCTV cabinets, and the TMC. Furnish SMFO jumpers that are a minimum of 6 feet in length for the communications racks inside the TMC. Ensure SMFO jumpers meet the operating characteristics of the SMFO cable with which it is to be coupled.

### **B. Ethernet Core Switch**

#### **1. Standards**

Provide an Ethernet core switch that complies with the following IEEE networking standards for Ethernet communications:

- IEEE 802.1AB Link Layer Discovery Protocol (LLDP)
- IEEE 802.1D Spanning Tree Protocol (STP),
- IEEE 802.1P Quality of Service (QoS),
- IEEE 802.1Q Virtual Local Area Networks (VLAN Tagging),
- IEEE 802.1S Multiple Spanning Tree Protocol (MSTP),
- IEEE 802.1X Port-Based Network Access Control,
- IEEE 802.1W Rapid Spanning Tree Protocol (RSTP),
- IEEE 802.3ad Ethernet Link Aggregation
- IEEE 802.3i for 10BASE-T (10 Mbit/s over Fiber-Optic)
- IEEE 802.3ab for 1000BASE-T (1Gbit/s over Ethernet)



- IEEE 802.3u supplement standard regarding 100 Base TX/100 Base FX,
- IEEE 802.3X Flow Control,
- IEEE 802.3Z Standards Compliant 1000 Base-SX and 1000 Base-LX optics,
- IEEE 802.3ad Link Aggregation,
- RFC 821 – Simple Mail Transfer Protocol (SMTP),
- RFC 854 – Telnet Protocol Specification,
- RFC 1112 – IGMP v1,
- RFC 2131 – Dynamic Host Configuration Protocol for IPv4,
- RFC 2236 – IGMP v2,
- RFC 3315 – Dynamic Host Configuration Protocol for IPv6 (DHCPv6),
- RFC 3376 – IGMP v3,
- RFC 2362 – Protocol Independent Multicast Sparse Mode (PIM-SM),
- RFC 3973 – Protocol Independent Multicast Dense Mode (PIM-DM),
- RFC 2328 – Open Shortest Path First (OSPF) v2,
- RFC 2338 – Virtual Router Redundancy Protocol (VRRP),
- RFC 2570:2575 – SNMP v3,
- RFC 2030 – Simple Network Time Protocol (SNTP), and
- RFC 2267 – Denial of Service (DoS).

Ensure that the Ethernet core switch has a minimum mean time between failures (MTBF) of 10 years, or 87,600 hours, as calculated using the Bellcore/Telcordia SR-332 standard for reliability prediction.

Ensure that the Ethernet core switch has a limited lifetime hardware warranty.

## **2. Functional**

Provide an Ethernet core switch that is comprised of multiple stackable switches that form a single virtual chassis. The virtual chassis shall be managed as a single network device. The Ethernet core switch shall have a minimum of four (4) switches in the initial virtual chassis, however additional switches may be required to meet the port requirements indicated in the Plans. The Ethernet core switch shall have a minimum of two dedicated virtual chassis (stacking) ports providing a minimum 128 Gbps switching capacity across the virtual backplane. Ensure the Ethernet core switch complies with the EIA's Ethernet data communication requirements using a single-mode fiber-optic transmission media; and Category 6 copper transmission media.

Provide a stackable-type design with the capability to expand the stack to a minimum of eight (8) units in a single logical device (virtual chassis) that meets the following minimum requirements:

### *Power:*

- Redundant power supplies, either on a per-switch basis or as a shared resource for each switch in the stack,
- Hot swappable while running without opening the chassis without interrupting the operation,
- Autosensing and autoswitching, and
- 110 VAC single phase power source.

*I/O:*

- A minimum of one (1) switch shall be provided in a full stacking configuration with additional switches provided as needed to meet the required number of optical and copper ports indicated in the plans.
- Each virtual chassis shall contain:
  - A minimum of twenty-four (24) ports per switch,
  - One (1) switch with a total of eight (8) fiber-optic 100/1000 Base-X optical ports and sixteen (16) 10/100/1000 Base-T ports at full wire speed.
- Ethernet single mode fiber-optic ports shall support Standard (10 km) and Long Haul (70+ km) optics.

*High Availability (HA) Features:*

- Redundant, hot swappable power supplies
- Ability for each switch in the stack to serve as the master (1:N availability)
- Cross module link aggregation

*Security Features:*

- IEEE 802.1X – RADIUS Authentication,
- TACACS+,
- Secure Shell (SSH v2),
- Access Control List (ACL), and
- Denial of Service (DoS) Protection.

**Optical Ports:** Ensure that all single mode fiber-optic link ports operate at 1310 or 1550 nanometers. Provide fully-functional ports with Type LC connectors and the optics for the optical ports as specified in the Plans or by the Engineer. Do not use mechanical transfer registered jack (MTRJ) or ST type connectors. At a minimum, the core Ethernet switch shall be equipped with eight (8) fully functional single mode 1 Gbps fiber-optic SFP transceivers, but additional SFPs may be required to meet the total port requirements in the Plans. Provide small form-factor plug-able (SFP) optics with 10 km, 20 km, 40km, 70 km, or 120 km optics as required to meet the distance requirement as indicated in the Plans.

Provide 1 Gbps optical transceivers as specified in the Plans or by the Engineer. Each transceiver consists of fiber pairs; one fiber will transmit (TX) data and one fiber will receive (RX) data. Provide optical transceivers that meet the following minimum requirements:

- Optical receiver sensitivity: -22 dBm,
- Optical transmitter power: -9 dBm,
- Estimated transmission distance: 20 km,
- Operating wavelength: 1310 nm, and
- Operating temperature: -40 to 185 degrees F.

Ensure that the optical ports have an optical power budget of at least 15 dB.

**Copper Ports:** Provide 16 fully functional copper ports installed in the Ethernet core switch virtual chassis. Provide copper ports that are Type RJ-45 and that auto-negotiate speed (i.e., 10/100/1000 Base) and duplex (i.e., full or half). Ensure that all 10/100/1000 Base TX ports meet the specifications detailed in this section and are compliant with the IEEE 802.3 standard

pinouts. Ensure that all Category 6 shielded twisted pair/shielded twisted pair network cables are compliant with the EIA/TIA-568-A standard.

Ensure that the Ethernet core switch (10/100/1000 Mbps ports) supports jumbo frames and full Layer 3 routing. Ensure that the switch includes support for dynamic unicast routing protocols such as RIPv1/v2 and OSPF, and support for multicast routing protocols, including PIM-SM, PIM-DM, and DVMRP.

*Port Security:* Supply an Ethernet core switch that supports/complies with the following (remotely) minimum requirements:

- Ability to configure static MAC addresses,
- Ability to disable automatic address learning per port, known hereafter as Secure Port. Secure Ports only forward data for pre-defined / learned MAC addresses, and
- Trap and alarm upon any unauthorized MAC address and shutdown for programmable duration. Port shutdown requires administrator to manually reset the port before communications are allowed.

### **3. Physical Features**

*Physical:* Provide an Ethernet core switch that is rack mountable into a standard 19-inch EIA rack and not exceed 10 RU in height. Provide all mounting kits, brackets, and hardware for mounting into a standard 19-inch rack.

*Chassis Fan Assembly:* Equip the managed Ethernet core switch with at least one cooling fan assembly per power supply to cool the CPU, main memory, and voltage regulators. Ensure that the fan has sufficient capacity and airflow to cool the switch.

### **4. Electrical Specifications**

Ensure that the Ethernet core switch operates and power is supplied with 115 volts of alternating current (VAC) at 60 Hz input frequency. Ensure that the Ethernet core switch has a minimum operating input of 110 VAC and a maximum operating input of 130 VAC. Ensure that if the device requires operating voltages other than 120 VAC, supply the required voltage converter. Ensure that the maximum power consumption does not exceed 350 watts per switch for the Ethernet core switch. Ensure that the managed Ethernet core switch and GBICs have diagnostic light emitting diodes (LEDs), including link, TX, RX, speed (for Category 6 ports only), and power LEDs.

### **5. Performance Requirements**

Ensure that the Ethernet core switch includes management capabilities, as defined in the following:

- Have a non-blocking architecture,
- Route and switch unicast and multicast traffic simultaneously at wire speed,
- Support fully redundant load sharing and hot swappable power supplies (N+1 support),
- Minimum 88 Gbps switching capacity per switch
- Minimum throughput: 65 Mbps per switch
- Minimum 128 Gbps switching capacity via stacking port
- Minimum 10k unicast routes in hardware
- Minimum 2k multicast routes in hardware

## 6. Management Capabilities

Ensure that the Ethernet core switch includes management capabilities, as defined in the following:

- Incorporate an internal temperature sensor capable of sending system log and/or SNMP traps should the switch exceed a specified warning level,
- Support automatic powering off should the temperature exceed a specified level to prevent damage to the switch,
- Support port mirroring and monitoring to aid in troubleshooting,
- Be capable of utilizing the following standard protocols:
  - Support VLAN (IEEE 802.1Q),
  - Support Multiple Spanning Tree Protocol (IEEE 802.1Q-2005),
  - Support Rapid Spanning Tree Protocol (IEEE 802.1W),
  - Support IGMP Versions 1 and 2 (RFC 1112 and 2236),
  - Support RIP Versions 1 and 2 (RFC 1058 and 1723),
  - Support OSPF Version 2 (RFC 1583 and 2328),
  - Support PIM (SM & DM),
  - Support IGMP Version 1 and 2 (RFC 1112 and 2236),
  - Support DVMRP,
  - Support VRRP (RFC 2338),
  - Support ToS/DSCP mapping to priority queue,
  - Support QoS queue management using weighted round robin (WRR) and strict priority (SP),
  - Support 10/100/1000 BaseTX ports (RJ-45),
  - Support a minimum of (2) 10-Gigabit Ethernet ports per switch,
  - Support Flow Control (IEEE 802.3x),
  - Support Gigabit Ethernet (IEEE 802.3z),
  - Support SNMP Version 1 and 3,
  - Support 4 groups of RMON-I (Groups 1-3, 9),
  - Be managed through console (RS-232), telnet, and Web interface, and
  - Support download and upload of images and configurations via Trivial File Transfer Protocol (TFTP).

Ensure that the Ethernet core switch fully supports all Layer 2 and Layer 3 management features related to multicast data transmission and routing, including, but not be limited to:

- An STP healing/convergence rate that meets or exceeds specifications published in the IEEE 802.1 D standards.
- An RSTP healing/convergence rate that meets or exceeds specifications published in the IEEE 802.1w standard.
- A core switch that is a port-based VLAN and supports VLAN tagging that meets or exceeds specifications as published in the IEEE 802.1Q standard.
- A forwarding/filtering rate that is a minimum of 14,880 packets per second for 10 megabits per second and 148,800 packets per second for 100 megabits per second.
- Support of Traffic Class Expediting and Dynamic Multicast Filtering.
- Support of, at a minimum, Version 2 of the Internet Group Management Protocol (IGMP).

- Support of remote and local setup and management via telnet, Secure Shell (SSHv2) or secure Web-based GUI and command line interfaces.
- Support of the SNMP protocol.
- Verify that the Ethernet core switch can be accessed using the resident EIA-232 management port, a telecommunication network, or the TFTP.
- Port security through controlling access by the users. Ensure that the Ethernet core switch has the capability to generate an alarm and shut down ports when an unauthorized user accesses the network.
- Support of the TFTP and the SNTTP. Ensure that the Ethernet core switch supports port mirroring for troubleshooting purposes when combined with a network analyzer.

## 7. Environmental Specifications

Supply an Ethernet core switch that adheres to the following environmental constraints:

- Operating Temperature Range: 32° F to 104° F,
- Storage Temperature Range: 14° F to 158° F, and
- Operating Relative Humidity Range: 10% to 95%, noncondensing.

### C. Ethernet Edge Switch

#### 1. Standards

Ensure that the Ethernet edge switches comply with all applicable IEEE networking standards for Ethernet communications, including but not limited to:

- IEEE 802.1AB standard for Link Layer Discovery Protocol (LLDP)
- IEEE 802.1D standard for media access control (MAC) bridges used with the Spanning Tree Protocol (STP),
- IEEE 802.1P standard for Quality of Service (QoS),
- IEEE 802.1Q standard for port-based virtual local area networks (VLANs),
- IEEE 802.1Q-2005 standard for MAC bridges used with the Multiple Spanning Tree Protocol,
- IEEE 802.1w standard for MAC bridges used with the Rapid Spanning Tree Protocol (RSTP),
- IEEE 802.1x standard for port based network access control, including RADIUS,
- IEEE 802.3 standard for local area network (LAN) and metropolitan area network (MAN) access and physical layer specifications,
- IEEE 802.3ad standard for Ethernet Link Aggregation
- IEEE 802.3ab standard for 1000BASE-T (1Gbit/s over Ethernet)
- IEEE 802.3i standard for 10BASE-T (10 Mbit/s over Fiber-Optic)
- IEEE 802.3u supplement standard regarding 100 Base TX/100 Base FX,
- IEEE 802.3x standard regarding flow control with full duplex operation, and
- IEEE 802.3z standard for 1000BASE-X (1 Gbit/s Ethernet over Fiber-Optic)
- RFC 783 – TFTP
- RFC 854 – Telnet Protocol Specification,
- RFC 1112 – IGMP v1,
- RFC 1541 – Dynamic Host Configuration Protocol for IPv4,
- RFC 2030 – SNTTP

- RFC 2068 – HTTP
- RFC 2236 – IGMP v2,
- RFC 2865 – RADIUS
- RFC 3414 – SNMPv3-USM
- RFC 3415 – SNMPv3-VACM.

Ensure that the Ethernet edge switches have a minimum mean time between failures (MTBF) of 10 years, or 87,600 hours, as calculated using the Bellcore/Telcordia SR-332 standard for reliability prediction.

## **2. Functional**

Ensure that the Ethernet edge switches support all Layer 2 management features and certain Layer 3 features related to multicast data transmission. These features shall include, but not be limited to:

- An STP healing/convergence rate that meets or exceeds specifications published in the IEEE 802.1D standard,
- An RSTP healing/convergence rate that meets or exceeds specifications published in the IEEE 802.1w standard,
- An Ethernet edge switch that is a port-based VLAN and supports VLAN tagging that meets or exceeds specifications as published in the IEEE 802.1Q standard, and has a minimum 4-kilobit VLAN address table (254 simultaneous),
- A forwarding/filtering rate that is a minimum of 14,880 packets per second for 10 megabits per second and 148,800 packets per second for 100 megabits per second,
- A minimum 4-kilobit MAC address table,
- Support of Traffic Class Expediting and Dynamic Multicast Filtering,
- Support of, at a minimum, snooping of Version 2 of the Internet Group Management Protocol (IGMP),
- Support of remote and local setup and management via telnet or secure Web-based GUI and command line interfaces,
- Support of the Simple Network Management Protocol version 3 (SNMPv3). Verify that the Ethernet edge switch can be accessed using the resident EIA-232 management port, a telecommunication network, or the Trivial File Transfer Protocol (TFTP),
- Port security through controlling access by the users. Ensure that the Ethernet edge switch has the capability to generate an alarm and shut down ports when an unauthorized user accesses the network,
- Support of the TFTP and SNTP. Ensure that the Ethernet edge switch supports port mirroring for troubleshooting purposes when combined with a network analyzer.

## **3. Physical Features**

*Mounting:* Provide mounting kit to attach the Ethernet edge switch to a DIN rail in the cabinet. Supply the DIN rail with the Ethernet edge switch.

*Ports:* Provide 10/100 Mbps auto-negotiating ports (RJ-45) copper Ethernet ports for all Ethernet edge switches. Provide auto-negotiation circuitry that will automatically negotiate the highest possible data rate and duplex operation possible with attached devices supporting the IEEE 802.3 Clause 28 auto-negotiation standard.

*Optical Ports:* Ensure that all fiber-optic link ports operate at 1310 or 1550 nanometers in single mode. Provide fully-functional ports with Type LC connectors and the optics for the optical ports. Do not use mechanical transfer registered jack (MTRJ) or ST type connectors.

Provide Ethernet edge switches having a minimum of two optical 1000 Base FX ports capable of transmitting data at 1000 megabits per second. Ensure that each optical port consists of a pair of fibers, one fiber will transmit (TX) data and one fiber will receive (RX) data.

Provide 1000 Mbps optical ports that consist of fiber pairs, one fiber will transmit (TX) data and one fiber will receive (RX) data. Provide optical ports that meet the following minimum requirements:

- Optical receiver sensitivity: -22 dBm,
- Optical transmitter power: -9 dBm,
- Typical transmission distance: 20 km, and
- Operating wavelength: 1310 nm.

Ensure that the optical ports have an optical power budget of at least 15 dB.

*Copper Ports:* Provide Ethernet edge switches that include a minimum of six copper ports. Provide Type RJ-45 copper ports and that auto-negotiate speed (i.e., 10/100/1000 Base) and duplex (i.e., full or half). Ensure that all 10/100/1000 Base TX ports meet the specifications detailed in this section and are compliant with the IEEE 802.3 standard pinouts. Ensure that all Category 6 shielded twisted pair network cables are compliant with the EIA/TIA-568-C.1 standard.

*Port Security:* Ensure that the Ethernet edge switches support/comply with the following (remotely) minimum requirements:

- Ability to configure static MAC addresses,
- Ability to disable automatic address learning per ports, known hereafter as Secure Port. Secure Ports only forward, and
- Trap and alarm upon any unauthorized MAC address and shutdown for programmable duration. Port shutdown requires administrator to manually reset the port before communications are allowed.

*Network Capabilities:* Provide Ethernet edge switches that support/comply with the following minimum requirements:

- Provide full implementation of IGMPv2 snooping (RFC 2236),
- Provide full implementation of SNMPv1, SNMPv2c, and/or SNMPv3,
- Provide support for the following RMON-I groups, at a minimum:
  - Part 1: Statistics
  - Part 2: History
  - Part 3: Alarm
  - Part 9: Event
- Provide support for the following RMON-2 groups, at a minimum:
  - Part 13: Address Map
  - Part 16: Layer Host
  - Part 17: Layer Matrix
  - Part 18: User History
- Capable of mirroring any port to any other port within the switch,
- Meet the IEEE 802.1Q (VLAN) standard per port for up to four VLANs,

- Meet the IEEE 802.3ad (Port Trunking) standard for a minimum of two groups of four ports,
- Telnet/CLI,
- HTTP (Embedded Web Server) with Secure Sockets Layer (SSL), and
- Full implementation of RFC 783 (TFTP) to allow remote firmware upgrades.

*Network Security:* Provide Ethernet edge switches that support/comply with the following (remotely) minimum network security requirements:

- Multi-level user passwords,
- RADIUS centralized password management (IEEE 802.1X),
- SNMPv3 encrypted authentication and access security,
- Port security through controlling access by the users: ensure that the Ethernet edge switch has the capability to generate an alarm and shut down ports when an unauthorized user accesses the network,
- Support of remote monitoring (RMON) of the Ethernet agent, and
- Support of the TFTP and SNTP. Ensure that the Ethernet edge switch supports port mirroring for troubleshooting purposes when combined with a network analyzer.

#### **4. Electrical Specifications**

Ensure that the Ethernet edge switches operate and power is supplied with 115 current VAC. Ensure that the Ethernet edge switches have a minimum operating input of 110 VAC and a maximum operating input of 130 VAC. Ensure that if the device requires operating voltages other than 120 VAC, supply the required voltage converter. Ensure that the maximum power consumption does not exceed 50 watts. Ensure that the Ethernet edge switches have diagnostic light emitting diodes (LEDs), including link, TX, RX, speed (for Category 6 ports only), and power LEDs.

#### **5. Environmental Specifications**

Provide Ethernet edge switches that adhere to the following environmental constraints as defined in the environmental requirements section of the NEMA TS 2 standard if located within a climate-controlled environment:

- Operating temperature range: -30°F to 165°F,
- Storage temperature range: 14°F to 158°F, and
- Operating relative humidity range: 10% to 90%, non-condensing.

Verify that the Ethernet edge switch manufacturer certifies their device has successfully completed environmental testing as defined in the environmental requirements section of the NEMA TS 2 standard. Verify that vibration and shock resistance meet the requirements of Sections 2.1.9 and 2.1.10, respectively, of the NEMA TS 2 standard. Ensure that the Ethernet edge switch is protected from rain, dust, corrosive elements, and typical conditions found in a roadside environment.

The Ethernet edge switches shall meet or exceed the following environmental standards:

- IEEE 1613 (electric utility substations),
- IEC 6185003 (electric utility substations),
- IEEE 61800-3 (variable speed drive systems), and
- IEC 61000-6-2 (generic industrial).



## D. Firewall

### 1. Standards

Ensure that the firewall appliance complies with all applicable IEEE networking standards for Ethernet communications, including but not limited to:

- RFC 854: Telnet Protocol Specification.
- RFC 4271: Border Gateway Protocol (BGP).
- RFC 2328: Open Shortest Path First (OSPF).
- RFC 2338: Virtual Router Redundancy Protocol (VRRP).
- RFC 2453: Routing Information Protocol (RIP) version 2.
- RFC 2362: Protocol Independent Multicast Sparse Mode (PIM-SM).
- RFC 2236: Internet Group Management Protocol (IGMP) version 2. and
- IEEE 802.1X: Port-Based Network Access Control.

Ensure that the firewall appliance has a minimum mean time between failures (MTBF) of 10 years, or 87,600 hours, as calculated using the Bellcore/Telcordia SR-332 standard for reliability prediction.

### 2. Performance Requirements

Ensure that the firewall appliance meets the following minimum performance requirements:

- Firewall Throughput: 350+ Mbps.
- Advanced Encryption Standard (AES) VPN Throughput: 100 Mbps.
- 3DES Encryption VPN Throughput: 100 Mbps.
- Maximum Concurrent Sessions: 48,000.
- Virtual Routers: 6, and
- Security Zones: 40.

Provide sufficient memory to enable optional features such as Intrusion Prevention System (IPS), antivirus, and anti-spam with no additional hardware upgrades.

### 3. Functional Requirements

Ensure that the firewall appliance supports the following features which shall include, but not be limited to:

- IPsec VPN Capabilities:
  - 500 Concurrent VPN Tunnels.
  - DES, 3DES, and AES.
  - MD-5 and SHA-3 Authentication.
  - Manual Key, Internet Key Exchange (IKE), IKEv2, and EAP Public Key Infrastructure (PKI) (X.509).
  - Remote Access VPN.
- Authentication:
  - Web-based Authentication.
  - RADIUS.
  - 802.1X.
  - RSA SecureID.
- Modes of Operation:

- Layer 2 Mode.
- Layer 3 Mode.
- Address Translation:
  - Network Address translation (NAT).
  - Port Address Translation (PAT).
  - Mapped IP (MIP) (L3 Mode).
  - Virtual IP (VIP) (L3 Mode).
- High Availability (HA):
  - Active/active – L3 mode.
  - Active/passive – Transparent & L3 mode.
  - Configuration Synchronization.
  - VRRP
- Quality of Service / Traffic Management:
  - Guaranteed Bandwidth.
  - Maximum Bandwidth.
  - Priority Bandwidth Utilization.
- Support for optional Intrusion Prevention System (IPS) (Deep Inspection) subscription.
- Support for optional Antivirus, antispam, and web filtering subscription.
- Network Attack Detection.
- DoS and DDos Protection.
- TCP Reassembly for Fragmented Packet Protection.
- Brute Force Attack Mitigation.
- SYN Cookie Protection.
- Zone-based IP Spoofing, and
- Malformed Packet Protection.

#### **4. Physical Features**

*Copper Ports:* Provide a firewall appliance that includes a minimum of six (6) Ethernet 10/100 Base-T copper ports and two (2) Ethernet 10/100/1000 Base-T copper ports. Provide Type RJ-45 copper ports that auto-negotiate speed (i.e., 10/100/1000 Base) and duplex (i.e., full or half). Ensure that all ports meet the specifications detailed in this section and are compliant with the IEEE 802.3 standard pinouts. Ensure that all Category 6 shielded twisted pair network cables are compliant with the EIA/TIA-568-C.1 standard. Provide auto-negotiation circuitry that will automatically negotiate the highest possible data rate and duplex operation possible with attached devices supporting the IEEE 802.3 Clause 28 auto-negotiation standard.

#### **5. Electrical Specifications**

Ensure the firewall appliance meets the following electrical requirements:

- Input voltage range: 110 VAC to 130 VAC, auto ranging, and
- Input frequency: 60 Hz.

Ensure that if the firewall appliance requires operating voltages other than 120 VAC, supply the required voltage converter. Ensure that the maximum power consumption does not exceed 200 watts.

## 6. Management Capabilities

Ensure that the firewall appliance supports all Layer 2 management features and certain Layer 3 features related to multicast data transmission and routing. These features shall include, but not be limited to:

- Support of remote and local setup and management via telnet, Secure Shell (SSHv2) or secure Web-based GUI and command line interfaces, and
- Support of the Simple Network Management Protocol (SNMP).
- Support SHA-3.
- Verify that the firewall can be accessed using the resident EIA-232 management port, a telecommunication network, or the Trivial File Transfer Protocol (TFTP).

*Network Capabilities:* Provide a firewall appliance that supports/complies with the following minimum requirements:

- Provide full implementation of IGMP v2,
- Provide full implementation of SNMPv3,
- Password manageable,
- Telnet/SSHv2,
- HTTP (Embedded Web Server) with Secure Sockets Layer (SSL), and
- Full implementation of RFC 783 (TFTP) to allow remote firmware upgrades.

*Network Security:* Provide a firewall appliance that supports/complies with the following (remotely) minimum network security requirements:

- Multi-level user passwords,
- RADIUS centralized password management (IEEE 802.1X),
- SNMPv3 encrypted authentication and access security,
- Support of the TFTP and SNTTP.

## 7. Environmental Specifications

Provide a firewall appliance that adheres to the following environmental constraints if located within a climate-controlled environment:

- Operating temperature range: 32°F to 104°F,
- Storage temperature range: 14°F to 158°F, and
- Operating relative humidity range: 10% to 90%, non-condensing.

### E. Uninterruptible Power Supply (UPS) – Communications Rack

Provide UPS units that produce uninterruptible power and power conditioning for the ITS servers, Ethernet Core switch, and KVM switch located in the communications rack.

Provide external battery units as necessary to achieve the minimum runtime.

### 1. Standards

Ensure that the UPS units comply with the following standards:

- ANSI,
- ASTM,
- CSA, and
- UL.

## 2. Functional

Each UPS shall provide adequate capacity to run its respective equipment without commercial power for at least 20 minutes. Size the UPS units for the proposed loads. Provide load calculations for each configuration of equipment connecting to a UPS assuming a minimum run time of 20 minutes.

Ensure that the UPS and its remote monitoring software perform the following functions:

- Remote environmental monitoring of temperature and humidity,
- Data logging,
- Event logging,
- Fault notification,
- Hibernation,
- Radius authentication,
- Protocols: HTTP, HTTPS, IPv4, IPv6, SMTP (v1-v3), Telnet, SSH v2, SSL,
- Manage all network UPS units,
- Operating system shutdown,
- Load shedding to turn off selected devices or groups of devices,
- Outlet control to turn off, reboot, or shutdown outlets,
- Power event summary,
- Recommended actions,
- Risk assessment summary,
- Run command file, and
- System event log integration.

## 3. Physical Features

Supply each UPS unit described above with 25 percent spare outlets. Ensure that the UPS meets the following material requirements:

- Input voltage 120 volts nominal,
- Output voltage 120 volts nominal,
- Rack-mounted
- Sealed AGM type, maintenance free batteries,
- LCD control panel with status indicators and screen indicating operating mode, efficiency, wattage or amperage of load, input and output voltage, battery capacity and runtime,
- Ethernet network management card using 10/100 Base TX communications,
- USB interface port,
- Remote environmental monitoring of temperature and humidity with telnet management,
- Status lights: power on, power source and overload,
- Alarms: audible and remote notification,
- Manual power on/off switch, and
- Supply UPS unit with multi-pole noise filtering. Supply UPS with a terminal for connecting the UPS to a surge protection device.

#### 4. Environmental Specifications

Verify that the UPS meets all specifications and is capable of performing all of its functions during and after being subjected to:

- Operating temperature: 0° F to 104° F,
- Operating relative humidity: 95%,
- Storage temperature: 5° F to 113° F, and
- Storage relative humidity: 95%.

Provide UPS units with UL 1449 surge protection and power filtering.

### 36.3. CONSTRUCTION METHODS

#### A. General

Verify that Ethernet cable and patch cords meet all requirements for Category 6 cable based on the “Ethernet Cable” section of these Project Special Provisions. .

Receive approval for the System Design Report described in these Project Special Provisions before submitting product submittal data, purchasing, installing and configuring the computer and communications hardware at each facility.

Ensure the as-built documentation includes the identification of all IP addresses and VLANs, and associated hardware devices and device locations. Configure the Ethernet network so the traffic signals and CCTV cameras are in separate VLANs.

The Engineer will designate who their network administrator is for the ITS LAN. Upon project completion ensure that the network administrator will be able to remotely manage the Ethernet switches for switch configuration, performance monitoring, and troubleshooting.

#### B. Ethernet Switches

##### 1. General

Ensure that all Project IP Address, Default Gateway, Subnet Mask and VLAN ID information are assigned as defined in the System Design Report. Ensure that at a minimum, the switch configuration includes the following features: SNMP, STP, Port Security, all required VLANs, Unicast Routing protocol, and Multicast Routing protocol. Ensure unused switch ports are disabled.

Ensure that the network administrator will be able to manage each Ethernet switch individually or as a group/cluster for switch configuration, performance monitoring, and troubleshooting. Note that these specifications require additional minimum management intelligence (i.e., Layer 2+) typical of most current industrial Ethernet deployments. Ensure that the managed Ethernet switches include Layer 2+ capability providing architecture standardization, open connectivity (i.e., interoperability), bandwidth management, rate limiting, security filtering, and general integration management of an advanced Ethernet switching architecture.

Verify that fiber-optic jumpers consist of a length of cable that is connectorized on both ends, primarily used for interconnecting termination or patching facilities and/or equipment. Use fiber-optic jumpers that are factory assembled and connectorized and are certified by the fiber-optic jumpers' manufacturer to meet the relevant performance standards required below. Verify that

network/field/data jumper cables meet all ANSI/EIA/TIA requirements for Category 6 four-pair shielded twisted pair cabling with solid copper conductors and RJ45 connectors.

## **2. Ethernet Core Switch**

The Ethernet core switch shall act as the central data aggregation node for the new communications network. Locate the Ethernet core switch in the TMC as shown in the Plans and provide full Layer 3 functionality. Ensure that the Ethernet core switch communicates with the firewall, proposed ITS servers, field device cabinets, traffic signal controller and test cabinets, video server, and video processing units at Ethernet data transmission rates of 1 Gbps and the Ethernet edge switches at Ethernet data transmission rates of 100 Mbps. Connect the Ethernet core switch to the firewall in the TMC with Ethernet patch cords.

Install and configure the Ethernet core switch to be fully compatible with the Ethernet edge switches as defined in these Project Special Provisions. Ensure that at a minimum, the Ethernet core switch configuration includes following features: SNMP, STMP, Port Security, all required VLANs, Unicast Routing protocols, and Multicast Routing protocols. Ensure unused switch ports are disabled.

Ensure all fiber connections of the Ethernet core switch are connected to two pairs of single mode fiber strands via fiber-optic splice center for redundant communications.

## **3. Ethernet Edge Switch**

Mount the Ethernet edge switch inside each field cabinet by securely fastening the Ethernet edge switch to the vertical rail of the equipment rack or to a shelf using manufacturer-recommended or Engineer-approved attachment methods, attachment hardware and fasteners. Ensure that the Ethernet edge switch is mounted securely in the cabinet and is fully accessible by field technicians without blocking access to other equipment. Verify that fiber-optic jumpers consist of a length of cable that is connectorized on both ends, primarily used for interconnecting termination or patching facilities and/or equipment.

Use fiber-optic jumpers that are factory assembled and connectorized and are certified by the fiber-optic jumpers' manufacturer to meet the relevant performance standards required below. Verify that network/field/data jumper cables meet all ANSI/EIA/TIA requirements for Category 6 4-pair shielded twisted pair cabling with solid copper conductors and RJ45 connectors.

## **C. Firewall**

Install the firewall appliance in a rack as shown in the Plans in the TMC. Connect the firewall to the carrier demark unit and the Ethernet core switch in the TMC with Ethernet patch cords. Install the latest General Availability (GA) software release available from the manufacturer. Ensure all firewall appliances are running the same revision of software.

Configure a minimum of three (3) zones. Configure appropriate security policies to protect the internal ITS network from Internet-based attacks from the Internet. Configure an IPsec VPN on the firewall to connect to the signal system supervisor's computer system via a secure link over the NCDOT dedicated fiber-optic communications network. Configure remote access VPN capability to allow NCDOT traffic services staff, the Division office, STOC and the Mobility and Safety office to access the network remotely via a secure connection from the Internet. If a VPN client is required for the remote access VPN, the Contractor shall provide a sufficient number of licenses for the required client software. If a server license is required, the Contractor shall provide all licenses for the server software as well.

Ensure that the firewall appliance communicates with the Ethernet core switch at Gigabit Ethernet data transmission rates (1000 Mbps).

Ensure that the network administrator will be able to remotely manage each firewall appliance for configuration, performance monitoring, threat detection, and troubleshooting.

Install and configure the firewall appliance to be fully compatible with the Ethernet core switch.

#### **D. Network Management Software**

Install the Network Management Software (NMS) server application on the ITS communications server. Configure the NMS to monitor and manage the ITS servers, and Ethernet edge switches. Install software to provide access to the NMS software from the workstations and laptop computers connected to the network. Establish user access rights, designate who has administrative, manager and monitoring rights. Build the database through an automatic utility within the NMS or manually enter the data. Establish groupings of devices with like functions or features, this would include geographically related, device types, owners. Setup automatic database and configuration backups. Setup system and device alarms and alarm notifications.

Setup graphical network views. Use mapping images provided by manufacturers to geographically locate devices.

#### **E. Uninterruptible Power Supply (UPS) in Communications Rack**

Install UPS unit in the existing communications rack in the TMC and connect the Ethernet core switch, ITS servers, and KVM switch to the UPS. Configure the UPS for remote monitoring.

### **36.4. MEASUREMENT AND PAYMENT**

The Ethernet switches include all appropriate ports, cabling, grounding, redundancies, labeling and any integration between the Ethernet switches and the communications network as necessary to make a fully working installation. All power supplies, power cords, adapters, mounting hardware, DIN rail mounting brackets, DIN rails, connectors, serial cables, signs, decals, disconnect switches, installation materials, and configuration software necessary to complete this work, will be included and will be incidental.

*Ethernet core switch* will be measured and paid as the actual number of Ethernet core switches furnished, installed and accepted.

*Ethernet edge switch* will be measured and paid as the actual number of Ethernet edge switches furnished, installed and accepted.

*Firewall* will be measured and paid as the actual number of firewalls furnished, installed and accepted.

*Network management software* will be measured and paid as lump sum furnished, installed and accepted.

*UPS in Communications Rack* will be measured and paid as the actual number of UPS in communication rack units furnished, installed and accepted.

Additional software licenses for the network management software shall be incidental to modify network management software.

No separate measurement will be made for SMFO jumpers, coaxial cables, communication cables, Ethernet patch cables, electrical cables, mounting hardware, nuts, bolts, brackets, connectors, risers, grounding equipment, surge suppression, or training as these will be considered incidental to the pay items listed above.

Payment will be made under:

<b>Pay Item</b>	<b>Pay Unit</b>
Ethernet Core Switch	Each
Ethernet Edge Switch	Each
Firewall	Each
Network Management Software	Lump Sum
UPS in Communications Rack	Each



### 37. DIGITAL VIDEO EQUIPMENT

#### 37.1. DESCRIPTION

Furnish and install a monitor in the new TMC.

Provide USB-based joysticks for CCTV selection and control.

#### 37.2. MATERIALS

##### A. Digital Video Monitors

Provide ultra-thin LED monitors, 65-inch minimum, as shown on Plans in the TMC. Coordinate with the Traffic Signal Supervisor to determine the height of the bottom of the monitor and the lateral location, ensuring monitor is visible from the workstation. Provide only new video monitors; do not furnish used or refurbished monitors. Furnish monitors made by the same manufacturer. Provide power cords for all monitors of sufficient length to plug into duplex and quadplex wall receptacle adjacent to monitor mounting location. Monitors and layout must be approved by the Engineer.

Provide monitors with a rated life of 50,000 hours.

Provide monitors meeting the following requirements:

- Display Type: LED, widescreen flat panel, direct LED backlight,
- LED Lifespan: 50,000 hours, 24-hour operation,
- Mounting: Wall-mount,
- Bezel Size: Combined 1.7 mm,
- Resolution: 1,920 x 1,080 dpi,
- Pixel Pitch: .63 mm,
- Response Time: 8 ms,
- Colors: Minimum 16.7 million colors,
- Horizontal Scanning Frequency: >85 kHz,
- Vertical Scanning Frequency: 50-86 Hz,
- Contrast Ratio: 4000:1,
- Aspect ratio: 16:9,
- Viewing Angle (Horizontal): 178 degrees,
- Viewing Angle (Vertical): 178 degrees,
- Brightness: 700 nits (cd/m<sup>2</sup>),
- HDTV Supported Formats: 720p and 1080p,
- Digital Inputs: DisplayPort, HDMI, and (2) DVI-D,
- Digital Outputs: DVI, VGA, composite,
- Analog Inputs: Component, VGA, S-video, composite,
- Controls: RS-232, RS-485, and
- Audio Inputs: RCA audio, stereo mini-jack, DisplayPort audio, HDMI audio.

Provide HDMI video cables with the monitors to reach from the traffic signal supervisors workstation to the new wall monitor. Provide HDMI cables and connectors meeting the following requirements:

- Cable: Individually insulated, 26 AWG copper conductors,

- Connectors: 24x1 pin male on both ends,
- Pins: Gold Plated,
- RFI and EMI Noise Reduction: Clip on ferrites,
- Maximum Resolution: 4096 x 2160P at 24Hz,
- Bit Rate: 24-bit, and
- Bandwidth Rating: 14.93 Gbps at 340 MHz.

### **B. Digital Video Monitor Mounting System**

Provide mounting brackets specifically designed for mounting the size of LED monitors described below on metal and wood stud walls or concrete block walls. Provide brackets that allow vertical and horizontal tilt to optimize viewing angles. Provide brackets with locking setscrews to prevent the monitor from falling or sliding off the bracket. Provide all mounting hardware and fasteners and plywood backboard necessary for securely attaching monitor mount brackets to metal stud and wood stud walls.

Provide a means to service, remove, and replace the monitor.

### **C. PTZ Joysticks**

Provide new USB based joysticks. The joystick controls shall include a variable speed, joystick for precise PTZ control, jog control for video playback, a keypad for camera and monitor selection and control. The joysticks shall meet the following requirements:

- Input Voltage: 100-240 VAC, 50/60 Hz
- Keyboard Interface: USB 2.0 with cable and captive connectors
- Audio Output: Embedded speaker,
- Keyboard Keypad: Numeric keys 0-9, camera, monitor, and multiple Proportional PTZ, variable speed with zoom, iris, and focus controls, and
- Jog/Shuttle: Proportional, fast forward, reverse, and video transport.

The joysticks shall meet the following environmental requirements:

- Storage Temperature: 70 degrees F to 74 degrees F,
- Operating Temperature: 32 degrees F to 104 degrees F, and
- Storage Temperature: -40 degrees F to 149 degrees F.

## **37.3. CONSTRUCTION METHODS**

### **A. General**

Receive approval for the System Design Report described in these Project Special Provisions before submitting products submittal data, purchasing, installing and configuring the central video equipment described in this section of the Project Special Provisions.

### **B. Video Server**

Integrate the digital video equipment with the CCTV system software package as described in the "CCTV SOFTWARE AND INTEGRATION" section of these Project Special Provisions.

### C. Digital Video Monitors

Ensure the mounting brackets are secured to wall studs or plywood backboard according to the manufacturer's recommendations. Utilize a minimum of four bolts into in factory installed mounting threaded holes in each monitor and four bolts for each mounting bracket into the wall.

Mount the TMC monitor on the wall as shown in the Plans and as approved by the Engineer. Ensure the monitors are level and plumb on the wall.

Connect power cords to adjacent receptacles (provided by others) in wall. Conceal all video cabling between each monitor and the video processing units in the wall as shown in the Plans. Connect the HDMI video input of a monitor with a HDMI video output of the video server. Route video wiring through wall up to ceiling over the suspended ceiling to the server room. Install ferrites to reduce RFI and EMI noise. Ensure when completed the power and video cables will be concealed behind the monitors.

### D. PTZ Joysticks

Install joystick controls for camera control in the TMC. Connect each joystick with its respective workstation.

### 37.4. MEASUREMENT AND PAYMENT

The materials provided in this section include all appropriate ports, cabling, grounding, redundancies, labeling, and any integration between the devices and the communications network as necessary to make a fully working installation.

For furnish and install and for furnish only materials all power supplies, power cords, adapters, mounting hardware, connectors, serial cables, HDMI cables, installation materials, and configuration software necessary to complete this work, are to be included and will be incidental to the pay items listed below.

*Digital display monitor* will be measured and paid as the actual number of digital display monitors furnished, installed, and accepted.

No separate measurement will be made for the video wall mounting system as it will be incidental to the digital display monitor listed above.

*PTZ joystick* will be measured and paid as the actual number of PTZ Joysticks furnished, installed, and accepted.

No separate measurement will be made for coaxial or serial cables, cable connectors, Ethernet cables between equipment housed within the same room/rack/cabinet, electrical cables, mounting hardware, nuts, bolts, brackets, connectors, grounding equipment, surge suppression or documentation as these will be considered incidental to the pay items listed above.

Payment will be made under:

<b>Pay Item</b>	<b>Pay Unit</b>
Digital Display Monitor	Each
PTZ Joystick	Each

### 38. COMMUNICATIONS RACKS

#### 38.1. DESCRIPTION

Reuse and modify the existing communications rack at the TMC for the signal system equipment.

#### 38.2. MATERIALS

Provide any equipment necessary to modify the existing communications rack as shown in the plans.

Provide a means for the entry of multiple cables (fiber-optic, video and Ethernet) into the racks from the cable tray above the communications racks.

#### 38.3. CONSTRUCTION METHODS

Ensure that the rack is grounded to a building ground.

Furnish and install an outlet strip and 10-foot power cord along one rear vertical rack frame for signal system use. Furnish and install strips that use 120 VAC 60 Hz power and shall contain at least 10 outlets over the 70 inches for full size racks. Ensure that there is a grounding bus bar system to ground the new rack-mounted electrical equipment. Connect power cord to UPS in communications rack for the signal system.

Furnish and install cable management hardware for attachment vertically along the rack frame and horizontally between 19-inch rack angles. Cable management hardware shall run vertically up one rear rack frame and shall include six horizontal runs per rack. Provide hardware including cable organizers and clamps to provide strain relief and cable mounting.

Modify the existing full-height communications rack cabinets in the TMC as shown in the Plans. Modification may include relocation of existing equipment in the rack. Coordinate with NCDOT Division IT Staff before relocating this equipment.

Install a keyboard shelf at a height comfortable for operator use when sitting on a stool.

#### 38.4. MEASUREMENT AND PAYMENT

*Modify Communications rack* will be measured and paid as the actual number of racks modified and accepted.

No separate measurement and payment will be made for rack set-up and assembly, shelves, keyboard drawers, power strips, mounting of all accessories and equipment specified for installation within the rack, all brackets, fasteners, and hardware required for properly mounting equipment in the rack, as such materials and work will be considered incidental to furnishing and installing the communications racks.

Payment will be made under:

<b>Pay Item</b>	<b>Pay Unit</b>
Modify Communications Rack	Each

### 39. BUILDING MODIFICATIONS AND FIBER-OPTIC CABLE TERMINATION

#### 39.1. DESCRIPTION

At locations called for in the Plans, route fiber-optic cable in new and/or existing conduits and install conduits into buildings as shown. Terminate fiber-optic cable in a fiber-optic splice center in the server room in the building housing the TMC (the NCDOT District office in Elizabeth City) as shown in the Plans. Furnish and install cable and cable routing facilities as shown in the Plans.

All construction to reach the building is paid for using other pay items in these Project Special Provisions. All construction to enter a building (including all work from creating a new entrance or integrating with an existing entrance) and making internal provisions for terminating cables are covered under these building modification pay items.

#### 39.2. MATERIALS

##### A. General

Use existing risers and conduit materials as called for in the *Standard Specifications* or these Project Special Provisions.

Use caulking and sealing materials for sealing entrances into buildings as approved by the Engineer.

Furnish Ethernet outlet boxes equipped with both a single RJ-45 jack and two RJ-45 jacks as shown in the Plans.

##### B. Fiber-Optic Splicing and Termination

Furnish SMFO pigtails with each splice housing, connector housing and interconnect center. Provide pigtails that are a maximum of 6 feet in length with a factory assembled LC connectors on one end. Ensure that the SMFO pigtails meet the operating characteristics of the SMFO cable with which it is to be coupled.

Furnish SMFO jumpers that are a minimum of 3 feet in length with factory assembled LC connectors on one end (i.e., the splice/interconnect center end) and, on the other end, factory-assembled connectors of the same type provided on the Ethernet edge switch and provided on the Ethernet core switch. Ensure that SMFO jumpers meet the operating characteristics of the SMFO cable with which it is to be coupled. Provide all of SMFO jumpers with all of the connector combinations necessary to provide the connectivity indicated in the Plans and required by these Project Special Provisions to produce a fully-functional Ethernet communications system.

Provide connector panels with LC-type connectors for connector housings and interconnect centers installed in all facilities.

For each splice housing and interconnect center, provide splice trays that hold, protect, and organize optical fibers, and secure fibers inside splice tray. Design and size splice trays to be dielectric, to accommodate all fibers entering the splice tray, and to provide sufficient space to prevent microbending of optical fibers.

### **C. Traffic Management Center (TMC) Building Modifications**

#### **1. Rack-Mounted Splice Centers**

Furnish a rack-mountable modular splice center comprising integrated connector panels and splice trays for splicing the fibers in the incoming signal system trunk cables to SMFO fiber-optic pigtails and terminating on patch panels in the communications cabinet being installed in the TMC (i.e., one splice center for each incoming cable). Each splice center shall have LC-compatible connector panels and shall have a capacity for terminating a minimum of 48 fibers on the connector panels as called for in the Plans. The splice center shall occupy one rack unit. The splice center shall include the necessary splice trays/cassettes for fusion splicing the incoming single-mode fibers in the incoming 48-fiber trunk cables to the pigtails. Provide all hardware needed to install the splice centers units in the communications rack.

#### **2. Cable Entry**

Reuse existing conduit for cable entry into the building housing the TMC as shown in the Plans.

#### **3. Cable Tray**

Use the existing cable tray between the wall next to conduits into the building and the servicer room communications rack.

#### **4. Cable Hangers**

Use the existing cable hangers to secure Ethernet cable to walls and ceiling joists. Secure the cable with hangers at least every six feet to the wall or from roof joists.

#### **5. Network Wiring**

Furnish all cover plates and network boxes (i.e., Ethernet outlets) in the building housing the TMC to convey Ethernet cabling within building as shown in the Plans.

### **39.3. CONSTRUCTION METHODS**

#### **A. General**

Contact Engineer prior to entering any building. Coordinate and obtain approval from Engineer regarding allowable working time in buildings.

Whenever possible, use existing cable raceways, ducts and drop ceilings to route fiber-optic cable.

Perform all work called for in the Plans to install cable and to route cabling above suspended ceilings, and in walls.

Terminate all optical fibers in splice centers unless otherwise shown on the Plans.

Install splice centers with connector panels, splice trays, storage for slack cable or fibers, mounting and strain relief hardware, and all necessary hardware. Comply with all requirements of the "Fiber-Optic Splice Centers" section of these Project Special Provisions.

Apply an Engineer-approved, UL-listed fire-stop sealant (putty, caulk, mortar, etc.) to reseal gaps between any existing conduits and holes through interior building walls and partitions.

**B. Traffic Management Center (TMC)****1. General Requirements**

Install equipment and route cable into the building housing the new TMC through existing conduit as shown in the Plans. Contact Madison Phillips, Traffic Signal Supervisor, at (252) 482-1850 at least 30 days in advance of work to confirm work schedule, work restrictions and to make arrangements for gaining access to the building. Perform all work in accordance with NESC regulations and guidelines.

When working inside the building housing the TMC, cover all furnishings, including chairs and electronic/computer equipment with drop cloths to protect them from debris from above-ceiling work and to aid in cleanup. Carefully remove ceiling panels and fiberglass insulation above the removed panels. Replace the insulation and panels and clean up all dust and debris by the end of each work period unless otherwise approved by the Engineer. Replace any drop ceiling panels damaged during installation of the above ceiling conduit at no expense to the Department.

**2. Cable Entry**

Install and route cable into the building housing the new TMC through existing conduit provided by others as shown in the Plans.

**3. Signal System FO and Other Cables and TMC Equipment**

Install the required rack-mounted splice center in the existing communications racks in the TMC as shown in the Plans. Pull the proposed signal system fiber-optic communications cables inside the building. Leave a pull tape for use by others for pulling additional fiber-optic communications cables into the building at a later date.

Fusion splice all fibers in the entering fiber-optic cables to SMFO pigtails inside rack-mounted splice housing, then connect the pigtails to the appropriate connectors in the connector housing. Terminate all pigtails from the incoming cable. Clearly label the patch panels of the connector housing center using an approved labeling method. Install SMFO jumpers between the connector panels and the Ethernet core switch. Store a minimum of 20 LF of each fiber-optic cable inside the communications rack that contains the splice center.

Install new HDMI video cable from the traffic signal supervisors docking station (workstation) to the new video display monitor as shown in the Plans.

Install new Ethernet cable for the outlets as shown in the Plans. Terminate the cable in the control room in network jacks. Terminate the Ethernet cable in the server room in the Ethernet patch panel in the communications rack.

**39.4. MEASUREMENT AND PAYMENT**

*TMC building modifications* will be measured and paid at the contract lump sum price. The price and payment will be full compensation for all work required to route and terminate the fiber-optic cable into the TMC as shown in the Plans, as well as any other work not called for under other items but required to accomplish the building modifications.

The Ethernet cables in the TMC will be measured and paid for in accordance with the "Ethernet Cable" section of these Project Special Provisions.

No separate payment will be made for rack-mounted interconnect centers, patch panels, splice trays, splicing and Ethernet outlet boxes with RJ-45 jacks as these will be considered incidental to the building modifications.

No separate measurement will be made for mounting hardware, nuts, bolts, concrete/masonry anchors, brackets, connectors, grounding equipment as these will be considered incidental to the pay items listed above. No separate payment will be made for wall-mount cabinets/junction boxes, splice housings, connector housings, interconnect centers, patch panels, splice trays, splicing, and fire-stop sealant as these will be considered incidental to the building modifications.

No separate measurement will be made for computer hardware, Ethernet switches, video head-end equipment, and rack cabinets, as these will be measured and paid for elsewhere in these Project Special Provisions.

Computer hardware, Ethernet switches, digital video display monitors, video head-end equipment and communications racks will be measured and paid for separately in accordance with other sections of these Project Special Provisions.

Payment will be made under:

**Pay Item**

**Pay Unit**

TMC Building Modifications

Lump Sum



#### 40. SUBMITTAL DATA AND DOCUMENTATION

##### 40.1. DESCRIPTION

Provide project documentation for Department review and approval as described below.

##### 40.2. SUBMITTALS

###### A. General

The intent of this subsection of the Project Special Provisions is to provide the requirements for submittal data (i.e., shop drawings, catalogue cuts, manufacturers' literature, proposed changes to splice drawings, construction schedule, system design report, etc.) and the process by which submittal data will be reviewed.

Provide all submittal documentation in either 8½" x 11" or 11" x 17" format. No documentation smaller than 8½" x 11" will be accepted. No documentation larger than 11" x 17" will be accepted without the prior approval of the Engineer. All submittals will be reviewed and approved by the Department. Absence of comment will not grant approval.

###### B. Project Construction Schedule

Prepare and submit for approval by the Engineer a schedule of the proposed working progress on the project in accordance with the instructions and on forms furnished by the Department. Update and submit the schedule no less than monthly.

The Contractor shall develop and submit for approval the system design report early in the project, within 45 days of notice-to-proceed, and shall proceed submittals of equipment and software.

The Contractor shall develop and submit for approval the migration plan, within 45 days of notice-to-proceed.

The project schedule shall include a monthly schedule of values. At the end of each calendar month shown on the schedule, show a value (in dollars) of the cumulative project work projected to be completed. The initially proposed project schedule shall be submitted no later than 5 business days prior to the date of the project preconstruction conference and shall be approved before any work is begun on the project. Update and submit the project schedule five business days prior to the monthly construction meetings.

When conditions beyond the Contractor's control have adversely affected the Contractor's progress, or the Department has extended the completion date, the Contractor may submit a revised progress schedule to the Department for approval. Such revised progress schedule will not be approved unless accompanied by a detailed written statement giving the Contractor's reasons for the proposed revision.

The project construction schedule shall show at least:

- Major Activities,
- Critical Path,
- Task Dependencies,
- Float Time for Each Task,
- Project Start and Completion,
- Task Durations,

- Task Begin and End Dates,
- Milestones,
- Material Submittals,
- Submittal Review Periods,
- Equipment Deliveries,
- Sample and Material Testing,
- Acceptance and Demonstration Testing,
- Training,
- Observation Period,
- Final Acceptance.

### **C. Qualified Products**

Refer to the following subsections of these Project Special Provisions:

- the “Qualified Products” subsection of the “General Requirements” section.

### **D. System Design Report**

Prepare a System Design Report to describe the proposed network architecture and its configuration. Provide schematics to illustrate the network architecture and configuration, in addition to the written description. Provide a detailed description of the hardware and software to be installed. The report shall depict and describe the entire layout of the equipment and their connectivity. Provide a detailed listing of the hardware including brand and model numbers, functions and descriptions.

Provide a detailed listing of the VLAN configuration and IP addresses and security protocols and setting to ensure the integrity of the network. Bind the report either in a 3-ring notebook or other type of binding approved by the Engineer. Submit the bound report and obtain approval before providing material submittals for the following packages of items as described below: central video equipment, software, computer hardware, and communications equipment.

### **E. Fiber-optic Splicing Drawings**

Submit drawings that illustrate any proposed changes to the fiber-optic splicing details for Department review and approval at least 10 working days prior to beginning fiber-optic splicing. Do not perform any fiber-optic splicing until the Department approves the proposed changes.

### **F. Submittal Requirements**

Provide written certification to the Department that all Contractor-furnished material is in accordance with the contract. When requested by the Department, provide additional certifications from independent testing laboratories and sufficient data to verify item meets applicable specifications. Ensure additional certification states the testing laboratory is independent of the material manufacturer and neither the laboratory nor the manufacturer has a vested interest in the other.

The intent of submittals is to show that the materials completely meet the requirements of the Plans and Project Special Provisions and how the Contractor intends to construct or configure the materials. The Contractor shall clearly demonstrate in the submittals that the desired materials shall meet or exceed the requirements of the Plans and Project Special Provisions. Each submittal shall be sufficiently complete and detailed for the Department to review and approve

the submittal. If the Department deems the submittal insufficient in detail or completeness for review or approval, the submittal will be returned as rejected. Additional time will not be granted for resubmittal.

Before material submittal data begins, provide to the Department a list of all submittals with approximate dates of submission that the Contractor intends to make. It is incumbent upon the Contractor to schedule reviews in a timely manner that will not delay his schedule.

Certain groups of materials are related in function and operate as a subsystem together. To ensure individual and subsystem compliance with the project requirements materials shall be submitted as packages as follows:

<b>Submittal Package</b>	<b>Description</b>
System Design Report	See "System Design Report" subsection above.
Controllers and Cabinets	2070LX Controllers, 332A, Conflict Monitors, Base Adapters, Base Extenders, Preformed Cabinet Foundations
Fiber-optic Cable	Fiber-optic Cable, Drop Cables, Splice Enclosures, Interconnect Centers, Splice Trays, Cable Addition Kits, Delineator Markers, Communications Cable Identification Markers
CCTV Equipment	CCTV camera, Power over Ethernet (POE) Injectors
Video Equipment*	Video Monitors and Mounting hardware, Video Joysticks
Computer Hardware	ITS Servers, Workstations, Laptops, Ethernet Cable
Communications Equipment*	Ethernet Core Switch, Firewall, Ethernet Edge Switches, KVM Switch, Network Management Software (see "Communications Hardware" section of these Project Special Provisions for further requirements);
Field Infrastructure	Conduit, Junction Boxes, Electrical Service Equipment (Disconnects, Meter Bases, Combination Panels), Heat Shrink Tubing and Retrofit Kits, Signal Heads, Pushbutton Integrated Accessible Pedestrian Signals, Stainless Steel Banding Hardware, and Misc. Hardware

\* Indicates submittal packages that cannot be submitted for review until the System Design Report has been submitted and approved.

Identify all proprietary parts in Contractor-furnished material. The Department reserves the right to reject materials that uses proprietary components not commercially available off-the-shelf products.

For Contractor-furnished material listed on the QPL, furnish submittals in the format defined by the QPL.

For Contractor-furnished material not on the QPL, furnish three copies of the equipment list including three copies of catalog cuts. Identify proposed material on catalog cuts by a reproducible means (highlighter pen does not transfer to copies). Ensure material lists contain material description, brand name, manufacturer's address and telephone number, stock number, size, identifying trademark or symbol, and other appropriate ratings. For submittals showing a variety of models and parts available from the manufacturer, clearly identify by circles, marking our other means the specific materials for which approval is requested.

Allow 40 consecutive calendar days for the Department to review and respond to a submittal. Do not deviate from what is approved without approval by the Department. Do not fabricate or order material until receipt of the Department's approval. All submittals will be returned as either "Approved (as submitted)", "Approved as Noted" or "Rejected." The Contractor may proceed with fabrication or ordering for items marked "Approved." If an item is marked "Approved as Noted" without any stipulation for resubmittal, then the Contractor may proceed with fabrication or ordering. For any other notations, the Contractor shall revise the submittal, address comments and resubmit for approval.

In addition, refer to the following subsections of these Project Special Provisions:

- the "Submittal Requirements" subsection of the "General Requirements" section.

### **40.3. DOCUMENTATION**

#### **A. General**

Provide all manuals and plan of record (i.e., "as-built") documentation. All as-built plans and documentation shall be reviewed and accepted by the Engineer prior to final acceptance of the project. All documentation, except as otherwise specifically approved by the Engineer, must meet the following requirements:

1. Provide final as-built plans on 11" x 17" paper along with a PDF of each as-built plan sheet. Provide draft as-built plans for Department review on 22" x 34" paper. No documentation for as-built plans smaller than 11" x 17" will be accepted.
2. Provide any documentation that exceeds the size of 11" x 17" paper in a reproducible format 22" x 34" in size.
3. For electrical schematics and cabinet wiring diagrams not bound into printed manuals, provide paper copies at least 22" x 34" in size.
4. No non-plan documentation smaller than 8.5" x 11" will be accepted.
5. Do not fold or crease reproducibles.

As a minimum, provide the documentation described in the paragraphs below.

#### **B. Plan of Record Documentation**

Provide as-built drawings that depict any changes of components, measurement or layout of the Plans. Show all construction changes, with the final location and depth of conduits, wiring external to the cabinet, locations of splice closures, system detector locations, and SMFO cable splicing and terminations, etc., in detail in a reproducible format. Submit as-built construction changes within 10 consecutive calendar days after the Observation Period begins. Note and date each change on the drawings. Failure to revise as-built documentation to reflect current work may result in withholding of payments until the as-built documentation is brought current. The submitted as-built documentation may be field-checked by the Engineer at his discretion. If the

as-built documentation is found to have an unacceptable number of inaccuracies, the Engineer may withhold payment until the as-built plans are corrected. Include all field installation including the SMFO cable network installed on the drawings.

For underground conduit systems that house communications cable, furnish the Engineer with a plan of record drawing detailing the locations of the conduit system, including junction boxes and their corresponding GPS coordinates. For directionally-drilled underground conduit systems, identify the vertical location (i.e., depth) of the conduits along the run.

Store documentation for signal installations in a manila envelope placed in a weatherproof holder inside the cabinet drawer. Store all documentation furnished with the controllers and cabinets, including manuals, electrical schematic diagram, and cabinet wiring diagram inside the envelope in the weatherproof holder. Provide two marked-up "redline" copies of the signal plan and the electrical and programming detail, placing one copy in the weatherproof holder inside the cabinet drawer immediately upon installation of the cabinet and giving the second copy to the Engineer.

For CCTV camera assemblies, provide two copies of a parts list(s) that includes serial and model numbers of all Contractor-furnished equipment prior to final acceptance. All equipment and appurtenances shall be identified by name, model number, serial number, technical support and warranty telephone numbers, and any other pertinent information required to facilitate equipment maintenance.

The Department will provide the Contractor one electronic copy of the Plans for his use in developing the as-built drawings. Modify the original electronic file such that all changes are marked with callout boxes or other method approved by the Engineer. Any other base maps that may be necessary for the Contractor to prepare the as-built drawings in accordance with these Project Special Provisions will be the Contractor's responsibility. Use CADD conventions that are consistent with those used on the original plans.

Within 10 consecutive calendar days after the Observation Period begins, furnish one reproducible copy of the draft as-built plans in hard copy format for review. Provide draft hard copy as-built drawings on 22"x 34" bond plan sheets.

Upon receipt of review comments from the Engineer, correct any errors and make all necessary revisions to the draft as-built plans prior to final acceptance of the project. Submit final as-built plans in electronic and hard copy format. Provide final hard copy as-built drawings on 11"x 17" bond plan sheets. Provide electronic plans in MicroStation (latest release in use by the Department) format. Provide the electronic files on CD or DVD.

### **C. Manuals**

Provide at least five hard copies along with one electronic copy (on CD or DVD) of the following manuals:

- Operator's manuals containing detailed operating instructions for each different type or model of equipment. Ensure that manuals contain instructions for possible modification to equipment.
- Maintenance procedures manuals containing detailed preventative and corrective maintenance procedures and troubleshooting procedures for each different type of model of equipment.

- Installation, operations and training manuals for all Contractor-provided software.

The manuals provided above shall be in addition to manuals provided with and stored inside each signal cabinet.

#### **D. Wiring Diagrams**

Provide detailed wiring diagrams that include interconnection of equipment with pin-out configurations, pin functions, and cable parts numbers. This includes configuration at each field equipment cabinet or signal cabinet at central locations. Provide two copies of system connection diagrams showing system interconnection cables and associated terminations. Use naming convention approved by the Engineer and conforming to Belcore standards. Provide one electronic copy of the wiring diagrams in MicroStation format.

#### **E. Splice Diagrams**

Prepare as-built splice diagrams that depict the communications cable plant as constructed. Depict the splices made at each splice enclosure by identifying spliced fiber and buffer tube. Ensure the splice diagram is in a similar format to those provided with the project plans. Identify all expressed fibers, spare fibers, used fibers and capped fibers.

Original splice diagrams will be provided in electronic format in MicroStation format. Designate any changes to these diagrams by using a method approved by the Engineer. Furnish as-built splice diagrams in MicroStation format. Provide the electronic files on CD or DVD.

Provide digital photographs of each fiber-optic splice. Include the splice number in the filename for each digital photo. Organize the photos in a logical folder structure and deliver them on CDs, DVDs or USB jump drive.

#### **40.4. MEASUREMENT AND PAYMENT**

There will be no direct payment for work covered in this section. Payment at the contract unit prices for the various items in the contract will be full compensation for all work covered by this section.

## 41. SYSTEM SUPPORT AND TEST EQUIPMENT

### 41.1. DESCRIPTION

Furnish fiber-optic system support and test equipment and signal system support and test equipment with all necessary hardware in accordance with the Plans and Project Special Provisions.

### 41.2. MATERIALS

#### A. General

Furnish equipment with test probes/leads, batteries (for battery-operated units), line cords (for AC-operated units), and carrying cases. Provide operating instructions and maintenance manuals with each item.

Before starting any system testing or training, furnish all fiber-optic communications system support and test equipment as well as signal system support and test equipment.

#### B. Conflict Monitor Tester with Notebook Computer

Furnish two standalone, portable conflict monitor test units with notebook computers intended for use on workbench. The tester shall use/control an Intel-based notebook computer of equal requirements to other notebook computers furnished under this project for input/output. The tester shall test conflict monitor displays, timing and voltage functions, and input/output combinations of either true or false conflicts. Any software provided with the tester shall be modular, menu driven, and offer a "help" screen. A video "setup/usage" training tape or DVD shall be provided with each unit. All input/outputs shall be in plain English. It shall be possible to generate a hardcopy printout, or to store the results electronically to a disc file. A "No Faults Detected" indication shall be displayed as appropriate.

#### C. 2070 Controller Tester

Furnish two portable 2070 controller testers designed to test all variations of the 2070 series controllers. Furnish testers mounted in a high impact ABS plastic case. The testers shall have an internal power supply such that no controller power is required.

Provide testers with C1 (M104 connector) and C11 (CPC 23-37 plug) connectors.

Provide testers that tests and displays all standard and extended controller functions colored LEDs and their respective C1 and C11 terminal numbers. The testers shall feature five-way test points (signal ground, power interrupt and neutral (3)). The power interrupt test shall be adjustable from .1 to 2.5 seconds. Provide 69 on/off/momentary on test switches. Provide testers that displays all C1 and C11 connector pinouts. Provide multi-purpose label overlays for a variety of controller and software applications.

#### D. Test Controllers with Cabinets

Provide controllers and cabinets that comply with the material requirements for controllers and cabinets in preceding subsections of this Project Special Provision. Fully label each test cabinet. Plug the power cord from each test cabinet into an existing wall receptacle adjacent to the cabinet.

Furnish and install Model 2070LX controllers with Type 332A test cabinets at the TMC. The test cabinets shall include a full complement of detector cards, auxiliary file, switch packs, a

conflict monitor, two (2) AC isolators, two (2) DC isolators, a field Ethernet switch, and a railroad preemption test panel. Provide a railroad preemption panel that is identical to those installed at railroad preemption locations in the field under this contract. Fully label the test cabinet and panels. Equip the Type 332A test cabinet with an auxiliary output file to simulate flashing yellow arrow phasing.

#### **1. Construction**

Furnish each test cabinet with a heavy-duty aluminum dolly base with heavy-duty, locking casters. The base shall accommodate a fully equipped, base-mounted cabinet. Supply a LED cabinet test display panel, which shall be located for convenient use by maintenance personnel. The display panel shall have all indicators on the front and shall have a suitable aluminum enclosure. The panel shall be fully labeled.

#### **8. Indicators**

The panel shall contain indicators to display the outputs of all the cabinet's traffic signal load switched. Red, yellow and green indicators shall be used to display the outputs of the traffic signal load switches. In addition, indicators shall be provided for four (4) pedestrian signal displays and 4 special functions. The indicators shall use LED's that are user replaceable.

#### **9. Controls**

Equip the display panel with controls that are connected to simulate all the inputs, for test purposed, to the controller which are not already accommodated by switches in the controller cabinet.

#### **10. Harnesses**

Connect the display panel to the controller cabinet by means of harnesses. Conceal the harnesses inside the pedestal or pipe supporting the panel and route the harnesses into the test cabinet through the bottom of the cabinet.

#### **11. Connection to the System**

Furnish and install Ethernet cables to connect the test controllers and their corresponding conflict monitors to the Ethernet switch at their respective locations.

### **41.3. MEASUREMENT AND PAYMENT**

*Furnish conflict monitor tester* will be measured and paid as the actual number of conflict monitor testers with notebook computers furnished and accepted. There will be no separate measurement and payment for the notebook computer as it will be incidental to furnishing the conflict monitor tester.

*Furnish 2070 controller tester* will be measured and paid as the actual number of 2070 controller testers furnished and accepted.

*Furnish 2070LX controller* will be measured and paid as the actual number of 2070LX controllers furnished and accepted.

*Furnish 332 cabinet with Aux File* will be measured and paid as the actual number of each type of controller cabinet furnished and accepted.

*Furnish 2018 enhanced conflict monitor* will be measured and paid as the actual number of Model 2018 enhanced conflict monitors furnished and accepted.



*Furnish Ethernet edge switch* will be measured and paid as the actual number of Ethernet edge switches furnished and accepted.

*Furnish CCTV camera assembly* will be measured and paid as the actual number of CCTV camera assemblies furnished and accepted.

*Type 332 test controller with cabinet* will be measured and paid as the actual number of 2070LX controllers with a Type 332 test cabinet furnished, installed in the TMC and accepted.

Test cabinets and controllers will not be included in the numbers of spare cabinets and controllers provided for this project.

No measurement will be made of load switches, AC isolator cards, DC isolator cards, detector cards, preemption panels, and auxiliary output files provide with the test controllers and test cabinets as they will be incidental to furnishing and installing the test controllers with cabinets. No measurement will be made of Ethernet cables required to connect the test controller and conflict monitor to an Ethernet switch and the power cord required to plug the test cabinet into the existing wall receptacle as they will be incidental to furnishing and installing the test controllers with cabinets.

Payment will be made under:

<b>Pay Item</b>	<b>Pay Unit</b>
Furnish Conflict Monitor Tester	Each
Furnish 2070 Controller Tester	Each
Furnish 2070LX Controller	Each
Furnish 332 Cabinet with Aux File	Each
Furnish 2018 Enhanced Conflict Monitor	Each
Furnish Ethernet Edge Switch	Each
Furnish CCTV Camera Assembly	Each
Type 332 Test Controller with Cabinet	Each

## 42. TRAINING

### 42.1. DESCRIPTION

Provide training for the installation, operation and maintenance of:

- Ethernet core switch,
- Ethernet edge switches,
- ITS Servers,
- Network configuration,
- CCTV field equipment,
- Video monitors,
- Signal system and CCTV software,
- Local controller software including:
  - ASC/3-2070 controller software,
- UPS, and
- System support
- Test software and test equipment.

### 42.2. MATERIALS

#### A. General

Provide training in the installation, operation, maintenance, troubleshooting and repair of all equipment and software. Prepare training outline, agenda, training manuals, training exercises, instructor resumes and any other teaching aids and submit them for approval by the Department prior to conducting training. For each course, provide a training exercise to demonstrate through hands-on activities the subject matter covered in the course lecture or course section. For exercises requiring computers, furnish enough computers to have one computer per two students.

Provide all laptop computers, projectors and projector screens needed for the training. Provide all audiovisual equipment needed for presentations and demonstrations, including video players. Provide new test cabinets, controllers and conflict monitors for use during the training. Furnish all power cords, extension cords, power strips and other cables required for the equipment used in the training.

Provide draft-training material to the Department for review and approval at least 60 days prior to the scheduled training. Provide adequate time for review and revision of the draft training materials. Furnish all audio-visual equipment, demonstration equipment, including a test cabinet, and "hands-on" equipment in support of the envisioned training. Each training participant shall receive a copy of course materials including both comprehensive and presentation manuals. Assume there will be a maximum of 10 students in each class session. Provide two additional copies of these documents to the Department.

Utilize training personnel well versed in the subject matter and with extensive field experience dealing with real world problems. Utilize training personnel that have been certified by the respective manufacturers.

The Department will provide the training facility. Provide the Department with a 30-day notification to carry out the training so that arrangements can be made for attendance. Coordinate a mutually agreeable date, time and location with the Division 1 staff through the Engineer. The

date shall be prior to the start of fiber-optic cable testing. The Engineer shall approve the training schedule time and location. A “day” of training shall consist of 8 hours of training.

When two sessions are required, conduct the first session early in the project, scheduling it to occur immediately prior to the first implementation of the given software or hardware so that Department staff can become familiar with the software or hardware prior to its implementation on the project. Conduct the second session near the conclusion of the project. If more than two sessions are required, conduct the remaining sessions approximately midway between the first and last sessions. Do not conduct multiple sessions back-to-back or near end of project.

**Conduct the first session of training on the controller firmware at least one week prior to installing the first new controller with cabinet on the project.**

Develop the course content specifically for the products supplied for this project. The course shall include the following topics:

- Introductory-level briefing to familiarize attendees;
- Terminology;
- Theory of operation;
- Installation;
- Hardware and software configuration;
- Operating procedures and capabilities;
- Testing, diagnostics and troubleshooting;
- Software applications;
- Use of the system documentation to operate, diagnose, maintain, and expand the system; and
- “Hands-on” use of the system, laptop computer and software, system test equipment, and any other system equipment supplied.
- Provide course lengths as follows:

Course	Type of Training	Total Students	No. of Sessions	Length (Days)*
Ethernet Communications and Networking**	Lecture and Hands-on Exercises	10	1	5
CCTV Field Equipment	Lecture and Hands-on Exercises			1
Digital Video Equipment	Lecture and Hands-on Exercises			0.5
Signal System Software	Lecture and Hands-on Exercises			4
CCTV and Video Management Software	Lecture and Hands-on Exercises			2
Maintenance Management System Software	Lecture and Hands-on Exercises			2
UPS	Lecture and Demonstration			0.25
* Length per session ** Do not conduct any training on this topic until the System Design				

Course	Type of Training	Total Students	No. of Sessions	Length (Days)*
Report has been submitted for review and subsequently approved by the Department.				

Provide additional specific training as described below.

**B. Ethernet Communications and Networking**

Provide training using the test and repair equipment furnished for the project. The training session shall be presented by field service specialist(s) employed by the suppliers of the communications system components. Provide training for the Ethernet communications and networking for the following categories and for the minimum number of hours shown:

Course	Type of Training	Total Students	No. of Sessions	Length (Days)
<b>Ethernet Communications and Networks</b>				
Terminology	Lecture			
Theory of design	Lecture			
Network configuration	Lecture			
VLANs	Lecture			
Equipment overview	Lecture			
Network maintenance	Lecture, Demonstration and Hands-on	10	1	2
System backup, data archiving, routine procedures	Hands-on			
Troubleshooting procedures	Hands-on			
Testing	Hands-on			
System restart and recovery	Hands-on			
Question and answer session	Lecture			
<b>Ethernet Switches (all types and configurations)</b>				
Introduction	Lecture			
Configuration and programming	Lecture and Hands-on			
Review of Maintenance Manual	Lecture and Hands-on			
Review of Operations Manual	Lecture and Hands-on	10	1	2
Maintenance	Lecture, Demonstration and Hands-on			
Routine	Hands-on			
Troubleshooting procedures	Hands-on			
Testing	Hands-on			
System restart and recovery	Hands-on			
Question and answer session	Lecture			
<b>Network Management Software</b>				
Introduction	Lecture			
Network Configuration (changes in network only)	Lecture and Hands-on	10	1	1
Question and answer session.	Lecture			

### C. CCTV Field Equipment

Provide training that includes operational theory and procedures of the field components of the CCTV system. This training shall be oriented towards the users and maintenance personnel of the system. The training session shall be presented by field service specialist(s) employed by the suppliers of the CCTV field components. This training session shall include exercises that should take one-half of the day. Provide training for the CCTV field equipment and the local CCTV camera software as described below:

Course	Type of Training	Total Students	No. of Sessions	Length (Days)
Operations	Lecture	10	1	0.5
Theory of operation	Lecture, Demonstration			
Local camera programming	Lecture, Demonstration and Hands-on			
Camera addresses				
Presets				
Privacy zones				
Tours				
Other features				
Maintenance	Lecture			0.5
Routine maintenance	Lecture, Demonstration and Hands-on			
Testing	Lecture, Demonstration and Hands-on			
Troubleshooting	Lecture, Demonstration and Hands-on			

### D. Digital Video Equipment

Provide training that includes operational theory and procedures of the central components of the CCTV system. This training shall be oriented towards users and maintenance personnel of the system. This training session shall include hands-on exercises that should take approximately one-half of the session. The training shall address the use of, but not limited to, the following devices: NVR, encoders, software decoder, monitors, and the video server. Provide training for the digital video equipment as described below:

Course	Type of Training	Total Students	No. of Sessions	Length (Days)
Operations and theory of operations	Lecture	6	1	0.25
Programming	Lecture, Demonstration and Hands-on			0.25
Maintenance				
Routine maintenance				
Testing				
Troubleshooting				

### E. Signal System Software

Provide training that includes operational theory and procedures of the signal system software. This training shall be oriented towards users and maintenance personnel of the system. This training shall include hands-on exercises that should take approximately one-half of the total session. The training session shall be presented by field service specialist(s) employed by the suppliers of the signal system software. Provide training for the signal system central software as described below:

Course	Type of Training	Total Students	No. of Sessions	Length (Days)
Part 1	Lecture & Demonstration	10	1	1
Overview of Part 1				
Time-of-day operation and event scheduling				
Traffic responsive pattern selection algorithms				
Reporting Capabilities	Lecture, Demonstration and Hands-on			
Interactive database manipulation				
Theory and application of traffic responsive operations				
Special functions				
Part 2	Lecture and Hands-on			1
Review of Part 1/Overview of Part 2				
System operations and recommended procedures				
Part 3	Lecture, Demonstration and Hands-on			2
Review of Parts 1 & 2/Overview of Part 3				
Development and modification of system graphics				
Preparation of dynamically functioning graphics				

### F. CCTV and Video Wall Software

Provide training that includes operational theory and procedures of the camera and video wall management software. This training shall be oriented towards users and maintenance personnel of the system. This training shall include hands-on exercises that should take approximately one-half of the total session. The training session shall be presented by field service specialist(s) employed by the suppliers of the signal system software. Provide training for the signal system central software as described below:

Course	Type of Training	Total Students	No. of Sessions	Length (Days)
CCTV Software	Lecture & Demonstration			
Part 1	Lecture, Demonstration and Hands-on	6	1	.5
System Overview				
System Configuration				
User Interface and User Rights				
Applications				
Part 2				
Development and modification of system graphics	Lecture, Demonstration and Hands-on	6	1	1
Part 3				
Development and modification of system graphics	Lecture, Demonstration and Hands-on	10	1	.5

### G. Maintenance Management System Software

Provide training that includes procedures in the use of the maintenance management system software. This training shall be oriented towards supervisors, users and maintenance personnel of the system. This training shall include hands-on exercises that should take approximately one-half of the total session. The training session shall be presented by field service specialist(s) employed by the suppliers of the signal system software. Provide training for the signal system central software as described below:

Course	Type of Training	Total Students	No. of Sessions	Length (Days)
Part 1	Lecture & Demonstration Lecture, Demonstration and Hands-on	10	1	1
Overview of Part 1				
Setup and User Interface				
Preventative Maintenance Tools Reporting Capabilities				
Part 2	Lecture, Demonstration and Hands-on	10	1	1
Review of Part 1/Overview of Part 2				
Schedulers				
Work Order Generation Mobile Device Applications				

### H. 2070LX Controllers, Conflict Monitors, Cabinets and Controller Firmware

Provide three identical training sessions in the basic theory, operation, routine maintenance and troubleshooting of the 2070 controller equipment, cabinets, conflict monitors, auxiliary output files and other related equipment. **Conduct one of these training sessions prior to the**



**installation of any new controllers and cabinet on the project.** Assume the attendees have no working knowledge through their current use of 2070 controllers.

Provide training, both lecture (i.e., classroom instruction) and hands-on exercise in the use of the local controller firmware, including how to load the firmware onto a new controller. Provide one computer for every two students for the hands-on exercises.

Training for controllers and cabinets shall be integrated into a single session with training exercises for cabinets and training exercises for controllers running concurrently. Instructors from the controller Vendor and instructors from the cabinet Vendor shall be in attendance during all days of the session.

Controller-specific instruction during the session shall be taught by experienced Vendor personnel who thoroughly understand both the traffic engineering aspects of signal timing and the entry of timing into the controller and internal TBC's.

The signal controller and cabinet assemblies session shall include, but not be limited to, the following:

- Formal classroom presentation and hands-on workshop on operation of signal monitor tester.
- Hands-on workshop on timing data entry for 2070LX controller.
- All local intersection timing parameters.
- All coordination timing parameters.
- All parameters and threshold levels associated with traffic responsive operation.
- Formal classroom presentation and hands-on workshop on operation of local controller utility software.
- Formal classroom presentation and hands-on workshop on operation of controller tester.
- Hands-on workshop of proper installation, programming, and troubleshooting of conflict monitors.

The lecture, demonstration; hands-on class shall include the following sessions specific to the 2070 related family of hardware and software (controllers, cabinets, signal monitors and detectors):

Course	Type of Training	Total Students	No. of Sessions	Length (Days)
Programming	Lecture, Demonstration and Hands-on	10	1	1.5
Phasing,				
Timing,				
Preemption,				
Coordination, Data transfer				
Operations	Lecture	10	1	1.5
Theory of operation	Lecture, Demonstration and Hands-on			
Testing	Lecture, Demonstration and Hands-on			

Course	Type of Training	Total Students	No. of Sessions	Length (Days)

Each of the identical training sessions shall consist of three consecutive days, beginning on a Monday.

**I. UPS**

Provide training for the UPS units that is 2 hours in length, including both classroom and “hands-on” training.

**42.3. MEASUREMENT AND PAYMENT**

*Training* will be measured and paid at the contract lump sum price. The price and payment will be full compensation for all work required by this section of these Project Special Provisions.

Payment will be made under:

**Pay Item**

**Pay Unit**

Training

Lump Sum

### 43. TESTING AND ACCEPTANCE

#### 43.1. GENERAL

Conduct and complete successfully the following progressive series of tests before acceptance: field demonstration test prior to installation, installed standalone tests, system test of the network hardware, network management software and an operational test. Develop a comprehensive series of test plans for each device to determine the equipment was correctly installed and meets the requirements of materials, workmanship, performance, and functionality required in the plans and project special provisions. The test plans shall describe the functions to be tested, purpose of test, setup requirements, procedures to be followed, any inputs and expected outputs for each test, criteria for pass/fail and any required tools or test equipment. Any software testers shall be pre-approved by the Department.

Develop as part of the Test Plan a Traceability Matrix of all the individual subsystem functional requirements to be used to cross-reference each planned test to a specific contract requirement to be verified. This Test Evaluation/Traceability Matrix shall be used by the Engineer to crosscheck the functional requirements and the results.

A key element of test plans, where appropriate, is the introduction of forced errors into the functional test. The test plan shall check the actual result of the forced error against the anticipated result. Tests will be performed by the Contractor and witnessed by the Department. No deviation from the written test procedure shall be permitted without approval from the Engineer. Any changes to the approved test procedure to accommodate unforeseen events during the time of testing shall be documented in a copy of the master test procedure. Immediately following the conclusion of each test, the Department and the Contractor shall meet to agree on the results observed and recorded during the testing. This will form the basis for the conclusions reported in the test plan. All test results, notes, and observations shall be maintained in both electronic and hard copy. Maintain complete records of all test results during all stages of testing.

#### 43.2. INSTALLED SITE TESTS

Conduct an approved, standalone equipment installation test at the field site. Test all standalone functions of the field equipment using equipment installed as detailed in the plans, or as directed by the Engineer.

Complete approved test plan forms and turn them over to the Engineer for review as a basis for rejection or acceptance. Provide a minimum notice of 30 calendar days prior to all tests to permit the Engineer or his representative to observe each test.

If any unit fails to pass its stand-alone test, correct the unit or substitute another unit in its place, then repeat the test.

If a unit has been modified as a result of a standalone test failure, prepare a report describing the nature of the failure and the corrective action taken and deliver it to the Engineer prior to re-testing the unit. If a failure pattern develops, the Engineer may direct that design and construction modifications be made to all units without additional cost to the Department or an extension of the contract period.

Utilize vendor supplied device software to perform diagnostic tests of each device. The vendor supplied diagnostic software shall be provided to the Department before final acceptance. Test the following features of each competent as described below.

### **A. Fiber-Optic Cable**

Conduct optical time domain reflectometer (OTDR) tests on the cable on the reel and after the cable is installed and terminated. Provide written notification a minimum of ten days before beginning fiber-optic cable testing.

After splicing is completed, perform bi-directional OTDR tests on each fiber, including unused fibers, to ensure the following:

- Fusion splice loss does not exceed 0.05 dB,
- Terminations and connections have a loss of 0.5 dB or less, and
- Reflection loss is 40 dB or greater for each connector.

Install a 1000-foot pre-tested launch cable between the OTDR and fiber-optic cable to be tested.

If exceeded, remake splices until the loss falls below 0.05 dB. The Engineer will record each attempt for purposes of acceptance.

Test the fiber-optic cable at both 1310 and 1550 nm.

Furnish durable labeled plots and electronic copies on a CD or DVD of test results for each fiber including engineering calculations demonstrating that OTDR test results meet or exceed the attenuation requirements and that optical properties of the cable have not been impaired. Clearly label each OTDR trace identifying a starting and ending point for all fibers being tested.

Provide engineering calculations and tests for fiber-optic cable that demonstrate the loss budget where the fiber originates and where the fiber meets an electronic device. The calculations shall summarize the optical losses versus the allowable losses for the communications equipment between each pair of communications hardware. Provide a summary section or spreadsheet with a labeled tabular summary showing each test segment with begin and end points and actual versus allowable losses. Label the manufacturer's make, model number and software version of the OTDR used for testing.

Furnish one hard copy of each of the OTDR trace results and electronic copies of all trace results on a CD or DVD along with digital photographs of all splices.

If any fiber exceeds the maximum allowable attenuation or if the fiber-optic properties of the cable have been impaired, take approved corrective action including replacement of complete segments of fiber-optic cable if required. Corrective action will be at no additional cost to the Department.

### **B. Ethernet Communications System**

#### **1. TMC Wiring**

Test any cable installed as part of this project per TIA 568 specifications for continuity, opens, shorts, split pairs, mis-wiring and reversed pairs. Test for DC resistance, impedance, and line capacitive loading. Correct any faults and retest. If retest fails, replace defective cable or connectors.

#### **2. ITS Servers, Workstations, and Laptop Computers**

The following operational tests shall be performed for each ITS server, workstation, and laptop computer in accordance with the test plans. After the equipment has been installed:

- Connect all components (displays, mice, keyboards, network cables, power supplies),
- Configure network communications,
- Map network drives,
- Test connections to all devices by pinging,
- Run diagnostic utilities on the hardware, and
- Map all network servers.

### **3. Ethernet Switches**

Once the Ethernet core switch and Ethernet edge switches have been installed, conduct local field acceptance tests of the Ethernet edge switch field site according to the submitted test plan. Perform the following:

- Verify that physical construction has been completed as detailed in the Plans,
- Inspect the quality and tightness of ground and surge protector connections,
- Verify proper voltages for all power supplies and related power circuits,
- Connect devices to the power sources,
- Verify all connections, including correct installation of communication and power cables, and
- Perform testing on multicast routing functionality.

Repair or replace defective or failed equipment and retest.

Upon satisfactory completion of operational test, begin an Observation Period of 60 days prior to system acceptance.

### **4. KVM Assembly**

The following operational tests shall be performed for each KVM assembly in accordance with the test Plans. After the KVM assembly has been installed:

- Connect all servers, monitors, keyboards, mice, and power supplies,
- Program the on-screen display to assign ports and bank numbers and to enter the names of each server in the menu,
- Program the KVM switch for scan features, access privileges, and
- Select each server and ensure the mouse and keyboard work the selected server and the monitor displays the appropriate server.

### **C. Traffic Signal Controllers and Conflict Monitors**

The following items, not otherwise required to be tested elsewhere, shall be tested: cable continuity, grounding, power-up self-test, proper controller sequencing, detector and pedestrian pushbutton calls.

### **D. Communications System Support Equipment**

Perform self-diagnostic tests on all electronic test equipment provided to the Department to ensure the equipment is proper operating order. Utilize the supplied test equipment in the training for the fiber-optic cable.

### **E. CCTV Field Equipment**

Develop an operational test plan that demonstrates all requirements of the equipment and software. Submit for approval before conducting tests.

Notify the Department at least 14 calendar days prior to the proposed date for the tests. The Department shall have the right to witness such tests, or to designate an individual or entity to witness such tests.

Perform the following local field operational tests at the camera assembly field site in accordance with the test Plans. A laptop computer shall provide camera control and positioning. After completing the installation of the camera assembly, including the camera hardware, power supply, and connecting cables, the Contractor shall:

- Furnish all equipment, appliances, and labor necessary to test the installed cable and to perform the following tests before any connections are made,
- Verify that physical construction has been completed,
- Inspect the quality and tightness of ground and surge protector connections,
- Perform continuity tests on the surveillance camera's stranded conductor element using a meter having a minimum input resistance of 20,000 ohms per volt and show that each conductor has a resistance of not more than 16 ohms per 984.3 feet of conductor;
- Measure the insulation resistance between the conductors, and between each conductor, ground, and shield using a megger. The resistance must be infinity. Perform all resistance testing after final termination and cable installation, but prior to the connection of any electronics or field devices; and
- Replace any cable that fails to meet these parameters, or if any testing reveals defects in the cable, and retest new cable as specified; and
- Perform the CCTV assembly manufacturer's initial power-on test in accordance with the manufacturer's recommendation,
- Set the camera control address,
- Verify the presence and quality of the video image in the field cabinet with a portable NTSC-approved monitor or laptop computer
- Exercise the pan, tilt, zoom, focus, iris opening, and manual iris control selections, and the operation, preset positioning, and power on/off functions,
- Demonstrate the pan and tilt speeds and extent of movement to meet all applicable standards, specifications, and requirements,
- Interconnect the communication interface device with the communication network's assigned fiber-optic trunk cable and verify that there is a transmission LED illuminated.

Repair or replace defective or failed equipment and retest.

#### **F. Central Digital Video Equipment**

Test the components of the digital video equipment as follows:

- Check all ground, power, data, Ethernet and digital video connections,
- Run power up self test on each piece of equipment,
- Run all available vendor-supplied self-diagnostics.

#### **G. UPS in Communications Rack**

Perform the following operational tests for each UPS in accordance with the test plans. After the UPS has been installed:

- Connect all field devices to UPS,
- Connect UPS monitoring cable to managed Ethernet switch,
- Install and configure UPS monitoring software from the TMC, and
- Configure monitoring software for remote notifications of power outage and use of battery power.

Repair or replace defective or failed equipment and retest.

### **43.3. SYSTEM TESTING**

#### **A. General**

Conduct tests as described below of the traffic signal and CCTV subsystems. Conduct approved device subsystem tests on the field equipment with the TMC equipment including, at a minimum, all remote communications hardware monitoring and control functions. These tests shall be a demonstration of overall system stability. During this test period, limit downtime due to mechanical, electrical, or other malfunctions to a maximum of eight hours. The Engineer has the right to suspend the test to correct deficiencies and restart the test or to extend the test period by time equal to the downtime in excess of eight hours.

Conduct device and subsystem tests of any repaired or replaced equipment.

Display the event log from the traffic signal and CCTV software for a minimum of seven days. Complete approved data forms and turn them over to the Engineer for review, and as a basis for rejection or acceptance.

The Engineer has the right to suspend the test to correct deficiencies and restart the test or to extend the test period by time equal to the downtime in excess of eight hours. If a component has been modified as a result of a test failure, prepare a report and deliver it to the Engineer prior to retesting.

#### **B. CCTV Subsystem**

After completing the integration of the CCTV cameras into the CCTV subsystem software, conduct a minimum of a seven-day test of the CCTV subsystem hardware and software. This will include that portion of the communications network serving the CCTV subsystem. The Engineer has the right to suspend the test to correct deficiencies and restart the test or to extend the test period by time equal to the downtime in excess of eight hours. If during that time it is determined by the Department there are hardware or software failures that are the responsibility of the Contractor, the Contractor shall make repairs or replacements to the satisfaction of the Department.

Test the following features of each competent as described below.

##### **1. CCTV Field Equipment**

The following items, not otherwise required to be tested elsewhere, shall be tested for each CCTV site from the TMC:

- Power-up self-tests,
- Iris control,
- Preset functions,
- Presence and quality of the video image,

- Preset positioning, and power on/off functions,
- Camera and controller access and security from all laptops and workstations,
- Disconnect camera and take local control and reconnect camera at local cabinet to the communications and verify TMC control is regained,
- Confirm ability to change camera ID,
- Verify unique camera identifier and icons on GUI,
- Viewing of camera image on each monitor.

## **2. Digital Video Equipment**

Thoroughly test all functions of the software from the TMC and the STOC to ensure correct operation. Test the components of the CCTV central equipment from the TMC as follows:

- Use the GUI interface and the PTZ control to select and view each camera on any monitor in the TMC;
- Use and the GUI interface and the PTZ control from the TMC to test the ability to control the pan-tilt-zoom and iris settings of each camera;
- Use the GUI interface and the PTZ control and test the ability to select and place any camera on any monitor;
- Use the monitors with CATV access in the TMC to select and display cable TV channels;
- Utilizing each workstation, demonstrate the ability to select, control and view the camera images; and
- Verify that all CCTV images can be displayed correctly on each monitor using the CCTV central software.

## **3. CCTV Central Software**

Thoroughly test all functions of the VideoPro software from the TMC and the STOC to ensure correct operation. Test the components of the CCTV central equipment from both the TMC and the STOC as follows:

- Use the GUI interface to select and view each camera;
- Use and the GUI interface to test the ability to control the pan-tilt-zoom and iris settings of each camera; and
- Use the GUI interface and test the ability to select and place any camera on any monitor.
- Select and display content on the video monitor from the TV tuner and from the signal system.

## **C. Traffic Signal Subsystem**

After completion of the integration of the traffic signals into the new signal system central software, conduct a minimum of a seven-day test of the traffic signal subsystem hardware and that portion of the communications network serving the traffic signal subsystem. The Engineer has the right to suspend the test to correct deficiencies and restart the test or to extend the test period by time equal to the downtime in excess of eight hours. If during that time it is determined by the Department that there are failures that are the responsibility of the Contractor, the Contractor shall make repairs or replacements to the satisfaction of the Department.

Verify communications port addressing from the traffic signal controllers.



#### **D. System Operational Test**

All equipment and software provided in this project shall be fully installed and operational prior to the start of the system operational test. These test procedures shall demonstrate that all equipment is fully integrated and operational, and is properly controlling the system.

Testing of the software and hardware at the TMC and other necessary locations shall include demonstrating proper operation based on these Project Special Provisions. These tests shall also demonstrate the proper function of the CCTV surveillance system, including camera selection, pan/tilt/zoom functions and remote monitoring of video images. These tests shall also demonstrate the proper operation of the new intersections on the graphics display system, the full functionality of the installed operator workstations, and demonstrating proper reception of video signals on the monitor and control panels.

Submit a system acceptance test procedure to the Engineer for review and approval before any tests are conducted.

Submit a system operational test plan a minimum of 60 days prior to the scheduled start of the test. The test plan will be reviewed by the Engineer, who will then either approve it or indicate changes required for approval. The Contractor shall then submit the revised test plan for review and approval. This process shall be repeated until the Engineer is able to approve the test plan.

Provide an operational test matrix at least four weeks prior to the scheduled beginning of the system operational test. The test matrix shall include columns for a description of the test, a summary of the test procedures, a column with sufficient space for comments and a status (pass/fail) column.

Repair or replace any component or software module that fails the system operational test. Retest repaired or replace component(s) or software module.

Testing shall include but not be limited to the following:

- Demonstration of all key functions of the distributed processing signal system software, including but not limited to:
  - Uploading and downloading of controller data;
  - Remote access and paging;
  - All monitoring functions;
  - Detector logging;
  - Signal monitor logging and uploading;
  - Traffic responsive operations;
  - Event scheduler;
  - Security functions;
  - Graphic displays; and
  - Reports.

- Power failure recovery, auto reboot and startup of the distributed processing signal system software;
- Database access, modification, storage and retrieval;
- Remote access to the signal system software and CCTV software from the notebook computers and remote video operation facilities;
- Local area network (LAN) operations; and
- Demonstrating that all features of the CCTV central software operates as called for with all field equipment.

#### **43.4. OBSERVATION PERIOD**

##### **A. General**

A 60-day Observation Period shall begin upon the successful completion of all installed site tests, all subsystem tests and all system tests described in the preceding subsections as well as the correction of all known deficiencies, including minor construction items and punch-list items developed by the Engineer. During this period the Department shall observe equipment and software operation to determine that all components of the fiber-optic communications system operate properly and interface with the traffic signal subsystem components and CCTV subsystem components according to the requirements of the Plans and these Project Special Provisions over an extended period of time.

During the Observation Period, respond to failures of the Contractor's equipment within two hours and make repairs within eight hours. For items that pose a traffic safety hazard such as a controller failure, make repairs within four hours. If any failures affect major system components for more than 48 hours, the Department shall suspend the Observation Period beginning when the failure occurred. Resume the Observation Period after successful repair or replacement. Failures of the following types will cause the Department to terminate the Observation Period and restart the Observation Period from zero once the failures have been corrected:

1. System or component failures that necessitate a redesign of any component; and
2. Three or more major system component failures of like nature within any 30-day period.

Major system components include:

- Ethernet core switch and Ethernet edge switches;
- Fiber-optic communications network;
- LAN and the TMC computer equipment; and
- CCTV equipment.

Begin a new 60-day Observation Period with the approval of the Engineer after the faulty equipment has been repaired or replaced and the redesigned components have been installed.

A successful 60-day Observation Period shall consist of continuous operation with no more than a total of five calendar days of non-operation due to mechanical, electrical, or other malfunctions.

The Observation Period shall be completed by the project completion date and prior to final acceptance of the project. The Observation Period shall not begin until the both the CCTV and traffic signal subsystem tests have been successfully completed. The Observation Period shall not begin without the approval of the Engineer.

### **B. CCTV Subsystem**

During the Observation Period, the Department will observe equipment and software operation according to the requirements of the Plans and these Project Special Provisions. Verify that the STOC can view and control the proposed cameras.

Major subsystem components include the CCTV cameras, Ethernet switches, fiber-optic cable, CCTV monitors, PTZ controls, and CCTV software.

### **C. Traffic Signal Subsystem**

During the Observation Period, the Department will observe equipment and software operation according to the requirements of the Plans and these Project Special Provisions.

Major subsystem components include the all Ethernet switches, fiber-optic cable, controllers and conflict monitors, and cabinets.

## **43.5. MEASUREMENT AND PAYMENT**

There will be no direct payment for work covered in this section. Payment at the contract unit prices for the various items in the contract will be full compensation for all work covered by this section.

## **43.6. FINAL ACCEPTANCE**

Final system acceptance is defined as the time when all work and materials described in the Plans and these Project Special Provisions have been furnished and completely installed by the Contractor; all parts of the work have been approved and accepted by the Engineer; and the CCTV and signal subsystems have been operated continuously and successfully for the 60-day Observation Period.

Final acceptance shall not occur until:

- All field demonstration, installed site, system, and operational tests have been satisfactorily completed;
- All punch-list discrepancies have been rectified;
- All documentation has been delivered and accepted; and
- All required training has been completed.

**PROJECT SPECIAL PROVISION**

(10-18-95) (Rev. 3-21-17))

Z-1a

**PERMITS**

The Contractor's attention is directed to the following permits, which have been issued to the Department of Transportation by the authority granting the permit.

<b><u>PERMIT</u></b>	<b><u>AUTHORITY GRANTING THE PERMIT</u></b>
Dredge and Fill and/or Work in Navigable Waters (404)	U. S. Army Corps of Engineers
Water Quality (401)	Division of Environmental Management, DEQ State of North Carolina
State Dredge and Fill and/or CAMA	Division of Coastal Management, DEQ State of North Carolina

The Contractor shall comply with all applicable permit conditions during construction of this project. Those conditions marked by \* are the responsibility of the Department and the Contractor has no responsibility in accomplishing those conditions.

Agents of the permitting authority will periodically inspect the project for adherence to the permits.

The Contractor's attention is also directed to Articles 107-10 and 107-13 of the *2018 Standard Specifications* and the following:

Should the Contractor propose to utilize construction methods (such as temporary structures or fill in waters and/or wetlands for haul roads, work platforms, cofferdams, etc.) not specifically identified in the permit (individual, general, or nationwide) authorizing the project it shall be the Contractor's responsibility to coordinate with the Engineer to determine what, if any, additional permit action is required. The Contractor shall also be responsible for initiating the request for the authorization of such construction method by the permitting agency. The request shall be submitted through the Engineer. The Contractor shall not utilize the construction method until it is approved by the permitting agency. The request normally takes approximately 60 days to process; however, no extensions of time or additional compensation will be granted for delays resulting from the Contractor's request for approval of construction methods not specifically identified in the permit.

**Where construction moratoriums are contained in a permit condition which restricts the Contractor's activities to certain times of the year, those moratoriums will apply only to the portions of the work taking place in the restricted waters, wetlands or buffer zones, provided that activities outside those areas is done in such a manner as to not affect the restricted waters, wetlands or buffer zones.**



STATE OF NORTH CAROLINA  
DEPARTMENT OF TRANSPORTATION

ROY COOPER  
GOVERNOR

JAMES H. TROGDON, III  
SECRETARY

DATE: April 4, 2019

TO: File

FROM: Deanna Riffey, Environmental Program Consultant  
Environmental Analysis Unit

SUBJECT: U-5942 Notice of Use for Section 404 Nationwide Permit 12 and Section 401  
General Water Quality Certification

Per email correspondence with U.S. Army Corps of Engineers (USACE) Regulatory Specialist Kyle Barnes on April 3, 2019, a non-reporting Nationwide Permit 12 is applicable for the jurisdictional impacts associated with the installation of conduit for fiber-optic signal cable. Under the current design, neither written notifications nor written concurrences from the USACE or the N.C. Division of Water Resources (NCDWR) are required. Due to the minimal permanent impacts to Wetland D of < 0.01 acre mitigation is not proposed. NCDOT must comply with all conditions and descriptions in the attached Permit Drawings, 404 General Conditions, and 401 Standard Conditions. A permit modification may be required if any of the above conditions and descriptions cannot be met.

*Mailing Address:*  
NC DEPARTMENT OF TRANSPORTATION  
ENVIRONMENTAL ANALYSIS UNIT  
1598 MAIL SERVICE CENTER  
RALEIGH, NC 27699-1598

*Telephone:* (919) 707-6000  
*Fax:* (919) 212-5785  
*Customer Service:* 1-877-368-4968

*Website:* [www.ncdot.gov](http://www.ncdot.gov)

*Location:*  
1000 BIRCH RIDGE DRIVE  
RALEIGH, NC 27699

**NATIONWIDE PERMIT 12  
DEPARTMENT OF THE ARMY  
CORPS OF ENGINEERS  
FINAL NOTICE OF ISSUANCE AND MODIFICATION OF NATIONWIDE PERMITS  
FEDERAL REGISTER  
AUTHORIZED MARCH 19, 2017**

**Utility Line Activities.** Activities required for the construction, maintenance, repair, and removal of utility lines and associated facilities in waters of the United States, provided the activity does not result in the loss of greater than 1/2-acre of waters of the United States for each single and complete project.

Utility lines: This NWP authorizes discharges of dredged or fill material into waters of the United States and structures or work in navigable waters for crossings of those waters associated with the construction, maintenance, or repair of utility lines, including outfall and intake structures. There must be no change in pre-construction contours of waters of the United States. A “utility line” is defined as any pipe or pipeline for the transportation of any gaseous, liquid, liquescent, or slurry substance, for any purpose, and any cable, line, or wire for the transmission for any purpose of electrical energy, telephone, and telegraph messages, and internet, radio, and television communication. The term “utility line” does not include activities that drain a water of the United States, such as drainage tile or french drains, but it does apply to pipes conveying drainage from another area.

Material resulting from trench excavation may be temporarily sidecast into waters of the United States for no more than three months, provided the material is not placed in such a manner that it is dispersed by currents or other forces. The district engineer may extend the period of temporary side casting for no more than a total of 180 days, where appropriate. In wetlands, the top 6 to 12 inches of the trench should normally be backfilled with topsoil from the trench. The trench cannot be constructed or backfilled in such a manner as to drain waters of the United States (e.g., backfilling with extensive gravel layers, creating a french drain effect). Any exposed slopes and stream banks must be stabilized immediately upon completion of the utility line crossing of each waterbody.

Utility line substations: This NWP authorizes the construction, maintenance, or expansion of substation facilities associated with a power line or utility line in non-tidal waters of the United States, provided the activity, in combination with all other activities included in one single and complete project, does not result in the loss of greater than 1/2-acre of waters of the United States. This NWP does not authorize discharges into non-tidal wetlands adjacent to tidal waters of the United States to construct, maintain, or expand substation facilities.

Foundations for overhead utility line towers, poles, and anchors: This NWP authorizes the construction or maintenance of foundations for overhead utility line towers, poles, and anchors in all waters of the United States, provided the foundations are the minimum size necessary and separate footings for each tower leg (rather than a larger single pad) are used where feasible.

Access roads: This NWP authorizes the construction of access roads for the construction and maintenance of utility lines, including overhead power lines and utility line substations, in non-tidal waters of the United States, provided the activity, in combination with all other activities included in one single and complete project, does not cause the loss of greater than 1/2-acre of non-tidal waters of the United States. This NWP does not authorize discharges into non-tidal wetlands adjacent to tidal waters for access roads. Access roads must be the minimum width necessary (see Note 2, below). Access roads must be constructed so that the length of the road minimizes any adverse effects on waters of the United States and must be as near as possible to pre-construction contours and elevations (e.g., at grade corduroy roads or geotextile/gravel roads). Access roads constructed above pre-construction contours and elevations in waters of the United States must be properly bridged or culverted to maintain surface flows.

This NWP may authorize utility lines in or affecting navigable waters of the United States even if there is no associated discharge of dredged or fill material (See 33 CFR part 322). Overhead utility lines constructed over section 10 waters and utility lines that are routed in or under section 10 waters without a discharge of dredged or fill material require a section 10 permit.

This NWP authorizes, to the extent that Department of the Army authorization is required, temporary structures, fills, and work necessary for the remediation of inadvertent returns of drilling fluids to waters of the United States through sub-soil fissures or fractures that might occur during horizontal directional drilling activities conducted for the purpose of installing or replacing utility lines. These remediation activities must be done as soon as practicable, to restore the affected waterbody. District engineers may add special conditions to this NWP to require a remediation plan for addressing inadvertent returns of drilling fluids to waters of the United States during horizontal directional drilling activities conducted for the purpose of installing or replacing utility lines.

This NWP also authorizes temporary structures, fills, and work, including the use of temporary mats, necessary to conduct the utility line activity. Appropriate measures must be taken to maintain normal downstream flows and minimize flooding to the maximum extent practicable, when temporary structures, work, and discharges, including cofferdams, are necessary for construction activities, access fills, or dewatering of construction sites. Temporary fills must consist of materials, and be placed in a manner, that will not be eroded by expected high flows. After construction, temporary fills must be removed in their entirety and the affected areas returned to pre-construction elevations. The areas affected by temporary fills must be revegetated, as appropriate.

- \* **Notification:** The permittee must submit a pre-construction notification to the district engineer prior to commencing the activity if any of the following criteria are met: (1) the activity involves mechanized land clearing in a forested wetland for the utility line right-of-way; (2) a section 10 permit is required; (3) the utility line in waters of the United States, excluding overhead lines, exceeds 500 feet; (4) the utility line is placed within a jurisdictional area (i.e., water of the United States), and it runs parallel to or along a stream bed that is within that jurisdictional area; (5) discharges that result in the loss of greater than 1/10-acre of waters of the United States; (6) permanent access roads are constructed above

## P-5

grade in waters of the United States for a distance of more than 500 feet; or (7) permanent access roads are constructed in waters of the United States with impervious materials. (See general condition 32.) (Authorities: Sections 10 and 404)

**Note 1:** Where the utility line is constructed or installed in navigable waters of the United States (i.e., section 10 waters) within the coastal United States, the Great Lakes, and United States territories, a copy of the NWP verification will be sent by the Corps to the National Oceanic and Atmospheric Administration (NOAA), National Ocean Service (NOS), for charting the utility line to protect navigation.

**Note 2:** For utility line activities crossing a single waterbody more than one time at separate and distant locations, or multiple waterbodies at separate and distant locations, each crossing is considered a single and complete project for purposes of NWP authorization. Utility line activities must comply with 33 CFR 330.6(d).

**Note 3:** Utility lines consisting of aerial electric power transmission lines crossing navigable waters of the United States (which are defined at 33 CFR part 329) must comply with the applicable minimum clearances specified in 33 CFR 322.5(i).

**Note 4:** Access roads used for both construction and maintenance may be authorized, provided they meet the terms and conditions of this NWP. Access roads used solely for construction of the utility line must be removed upon completion of the work, in accordance with the requirements for temporary fills.

**Note 5:** Pipes or pipelines used to transport gaseous, liquid, liquescent, or slurry substances over navigable waters of the United States are considered to be bridges, not utility lines, and may require a permit from the U.S. Coast Guard pursuant to section 9 of the Rivers and Harbors Act of 1899. However, any discharges of dredged or fill material into waters of the United States associated with such pipelines will require a section 404 permit (see NWP 15).

**Note 6:** This NWP authorizes utility line maintenance and repair activities that do not qualify for the Clean Water Act section 404(f) exemption for maintenance of currently serviceable fills or fill structures.

**Note 7:** For overhead utility lines authorized by this NWP, a copy of the PCN and NWP verification will be provided to the Department of Defense Siting Clearinghouse, which will evaluate potential effects on military activities.

**Note 8:** For NWP 12 activities that require pre-construction notification, the PCN must include any other NWP(s), regional general permit(s), or individual permit(s) used or intended to be used to authorize any part of the proposed project or any related activity, including other separate and distant crossings that require Department of the Army authorization but do not require pre-construction notification (see paragraph (b) of general condition 32). The district engineer will evaluate the PCN in accordance with Section D, "District Engineer's Decision." The district engineer may require mitigation to ensure that the authorized activity results in no more than minimal individual and cumulative adverse environmental effects (see general condition 23).



**NATIONWIDE PERMIT GENERAL CONDITIONS**

The following General Conditions must be followed in order for any authorization by a NWP to be valid:

1. Navigation. (a) No activity may cause more than a minimal adverse effect on navigation.  
(b) Any safety lights and signals prescribed by the U.S. Coast Guard, through regulations or otherwise, must be installed and maintained at the permittee's expense on authorized facilities in navigable waters of the United States.  
(c) The permittee understands and agrees that, if future operations by the United States require the removal, relocation, or other alteration, of the structure or work herein authorized, or if, in the opinion of the Secretary of the Army or his authorized representative, said structure or work shall cause unreasonable obstruction to the free navigation of the navigable waters, the permittee will be required, upon due notice from the Corps of Engineers, to remove, relocate, or alter the structural work or obstructions caused thereby, without expense to the United States. No claim shall be made against the United States on account of any such removal or alteration.
2. Aquatic Life Movements. No activity may substantially disrupt the necessary life cycle movements of those species of aquatic life indigenous to the waterbody, including those species that normally migrate through the area, unless the activity's primary purpose is to impound water. All permanent and temporary crossings of waterbodies shall be suitably culverted, bridged, or otherwise designed and constructed to maintain low flows to sustain the movement of those aquatic species. If a bottomless culvert cannot be used, then the crossing should be designed and constructed to minimize adverse effects to aquatic life movements.
3. Spawning Areas. Activities in spawning areas during spawning seasons must be avoided to the maximum extent practicable. Activities that result in the physical destruction (e.g., through excavation, fill, or downstream smothering by substantial turbidity) of an important spawning area are not authorized.
4. Migratory Bird Breeding Areas. Activities in waters of the United States that serve as breeding areas for migratory birds must be avoided to the maximum extent practicable.
5. Shellfish Beds. No activity may occur in areas of concentrated shellfish populations, unless the activity is directly related to a shellfish harvesting activity authorized by NWPs 4 and 48, or is a shellfish seeding or habitat restoration activity authorized by NWP 27.
6. Suitable Material. No activity may use unsuitable material (e.g., trash, debris, car bodies, asphalt, etc.). Material used for construction or discharged must be free from toxic pollutants in toxic amounts (see section 307 of the Clean Water Act).

7. Water Supply Intakes. No activity may occur in the proximity of a public water supply intake, except where the activity is for the repair or improvement of public water supply intake structures or adjacent bank stabilization.

8. Adverse Effects From Impoundments. If the activity creates an impoundment of water, adverse effects to the aquatic system due to accelerating the passage of water, and/or restricting its flow must be minimized to the maximum extent practicable.

9. Management of Water Flows. To the maximum extent practicable, the pre-construction course, condition, capacity, and location of open waters must be maintained for each activity, including stream channelization, storm water management activities, and temporary and permanent road crossings, except as provided below. The activity must be constructed to withstand expected high flows. The activity must not restrict or impede the passage of normal or high flows, unless the primary purpose of the activity is to impound water or manage high flows. The activity may alter the pre-construction course, condition, capacity, and location of open waters if it benefits the aquatic environment (e.g., stream restoration or relocation activities).

10. Fills Within 100-Year Floodplains. The activity must comply with applicable FEMA-approved state or local floodplain management requirements.

11. Equipment. Heavy equipment working in wetlands or mudflats must be placed on mats, or other measures must be taken to minimize soil disturbance.

12. Soil Erosion and Sediment Controls. Appropriate soil erosion and sediment controls must be used and maintained in effective operating condition during construction, and all exposed soil and other fills, as well as any work below the ordinary high water mark or high tide line, must be permanently stabilized at the earliest practicable date. Permittees are encouraged to perform work within waters of the United States during periods of low-flow or no-flow, or during low tides.

13. Removal of Temporary Fills. Temporary fills must be removed in their entirety and the affected areas returned to pre-construction elevations. The affected areas must be revegetated, as appropriate.

14. Proper Maintenance. Any authorized structure or fill shall be properly maintained, including maintenance to ensure public safety and compliance with applicable NWP general conditions, as well as any activity-specific conditions added by the district engineer to an NWP authorization.

15. Single and Complete Project. The activity must be a single and complete project. The same NWP cannot be used more than once for the same single and complete project.

16. Wild and Scenic Rivers. (a) No NWP activity may occur in a component of the National Wild and Scenic River System, or in a river officially designated by Congress as a "study river" for possible inclusion in the system while the river is in an official study status,

unless the appropriate Federal agency with direct management responsibility for such river, has determined in writing that the proposed activity will not adversely affect the Wild and Scenic River designation or study status.

(b) If a proposed NWP activity will occur in a component of the National Wild and Scenic River System, or in a river officially designated by Congress as a “study river” for possible inclusion in the system while the river is in an official study status, the permittee must submit a pre-construction notification (see general condition 32). The district engineer will coordinate the PCN with the Federal agency with direct management responsibility for that river. The permittee shall not begin the NWP activity until notified by the district engineer that the Federal agency with direct management responsibility for that river has determined in writing that the proposed NWP activity will not adversely affect the Wild and Scenic River designation or study status.

(c) Information on Wild and Scenic Rivers may be obtained from the appropriate Federal land management agency responsible for the designated Wild and Scenic River or study river (e.g., National Park Service, U.S. Forest Service, Bureau of Land Management, U.S. Fish and Wildlife Service). Information on these rivers is also available at: <http://www.rivers.gov/>.

17. Tribal Rights. No NWP activity may cause more than minimal adverse effects on tribal rights (including treaty rights), protected tribal resources, or tribal lands.

18. Endangered Species. (a) No activity is authorized under any NWP which is likely to directly or indirectly jeopardize the continued existence of a threatened or endangered species or a species proposed for such designation, as identified under the Federal Endangered Species Act (ESA), or which will directly or indirectly destroy or adversely modify the critical habitat of such species. No activity is authorized under any NWP which “may affect” a listed species or critical habitat, unless ESA section 7 consultation addressing the effects of the proposed activity has been completed. Direct effects are the immediate effects on listed species and critical habitat caused by the NWP activity. Indirect effects are those effects on listed species and critical habitat that are caused by the NWP activity and are later in time, but still are reasonably certain to occur.

(b) Federal agencies should follow their own procedures for complying with the requirements of the ESA. If pre-construction notification is required for the proposed activity, the Federal permittee must provide the district engineer with the appropriate documentation to demonstrate compliance with those requirements. The district engineer will verify that the appropriate documentation has been submitted. If the appropriate documentation has not been submitted, additional ESA section 7 consultation may be necessary for the activity and the respective federal agency would be responsible for fulfilling its obligation under section 7 of the ESA.

\* (c) Non-federal permittees must submit a pre-construction notification to the district engineer if any listed species or designated critical habitat might be affected or is in the vicinity of the activity, or if the activity is located in designated critical habitat, and shall not begin work on the activity until notified by the district engineer that the requirements of the ESA have been satisfied and that the activity is authorized. For activities that might affect Federally-listed endangered or threatened species or designated critical habitat, the pre-construction notification must include the name(s) of the endangered or threatened species that

might be affected by the proposed activity or that utilize the designated critical habitat that might be affected by the proposed activity. The district engineer will determine whether the proposed activity “may affect” or will have “no effect” to listed species and designated critical habitat and will notify the non-Federal applicant of the Corps’ determination within 45 days of receipt of a complete pre-construction notification. In cases where the non-Federal applicant has identified listed species or critical habitat that might be affected or is in the vicinity of the activity, and has so notified the Corps, the applicant shall not begin work until the Corps has provided notification that the proposed activity will have “no effect” on listed species or critical habitat, or until ESA section 7 consultation has been completed. If the non-Federal applicant has not heard back from the Corps within 45 days, the applicant must still wait for notification from the Corps.

(d) As a result of formal or informal consultation with the FWS or NMFS the district engineer may add species-specific permit conditions to the NWP.

(e) Authorization of an activity by an NWP does not authorize the “take” of a threatened or endangered species as defined under the ESA. In the absence of separate authorization (e.g., an ESA Section 10 Permit, a Biological Opinion with “incidental take” provisions, etc.) from the FWS or the NMFS, the Endangered Species Act prohibits any person subject to the jurisdiction of the United States to take a listed species, where “take” means to harass, harm, pursue, hunt, shoot, wound, kill, trap, capture, or collect, or to attempt to engage in any such conduct. The word “harm” in the definition of “take” means an act which actually kills or injures wildlife. Such an act may include significant habitat modification or degradation where it actually kills or injures wildlife by significantly impairing essential behavioral patterns, including breeding, feeding or sheltering.

(f) If the non-federal permittee has a valid ESA section 10(a)(1)(B) incidental take permit with an approved Habitat Conservation Plan for a project or a group of projects that includes the proposed NWP activity, the non-federal applicant should provide a copy of that ESA section 10(a)(1)(B) permit with the PCN required by paragraph (c) of this general condition. The district engineer will coordinate with the agency that issued the ESA section 10(a)(1)(B) permit to determine whether the proposed NWP activity and the associated incidental take were considered in the internal ESA section 7 consultation conducted for the ESA section 10(a)(1)(B) permit. If that coordination results in concurrence from the agency that the proposed NWP activity and the associated incidental take were considered in the internal ESA section 7 consultation for the ESA section 10(a)(1)(B) permit, the district engineer does not need to conduct a separate ESA section 7 consultation for the proposed NWP activity. The district engineer will notify the non-federal applicant within 45 days of receipt of a complete pre-construction notification whether the ESA section 10(a)(1)(B) permit covers the proposed NWP activity or whether additional ESA section 7 consultation is required.

(g) Information on the location of threatened and endangered species and their critical habitat can be obtained directly from the offices of the FWS and NMFS or their world wide web pages at <http://www.fws.gov/> or <http://www.fws.gov/ipac> and <http://www.nmfs.noaa.gov/pr/species/esa/> respectively.

19. Migratory Birds and Bald and Golden Eagles. The permittee is responsible for ensuring their action complies with the Migratory Bird Treaty Act and the Bald and Golden Eagle Protection Act. The permittee is responsible for contacting appropriate local office of the U.S. Fish and Wildlife Service to determine applicable measures to reduce impacts to migratory

birds or eagles, including whether “incidental take” permits are necessary and available under the Migratory Bird Treaty Act or Bald and Golden Eagle Protection Act for a particular activity.

20. Historic Properties. (a) In cases where the district engineer determines that the activity may have the potential to cause effects to properties listed, or eligible for listing, in the National Register of Historic Places, the activity is not authorized, until the requirements of Section 106 of the National Historic Preservation Act (NHPA) have been satisfied.

(b) Federal permittees should follow their own procedures for complying with the requirements of section 106 of the National Historic Preservation Act. If pre-construction notification is required for the proposed NWP activity, the Federal permittee must provide the district engineer with the appropriate documentation to demonstrate compliance with those requirements. The district engineer will verify that the appropriate documentation has been submitted. If the appropriate documentation is not submitted, then additional consultation under section 106 may be necessary. The respective federal agency is responsible for fulfilling its obligation to comply with section 106.

\* (c) Non-federal permittees must submit a pre-construction notification to the district engineer if the NWP activity might have the potential to cause effects to any historic properties listed on, determined to be eligible for listing on, or potentially eligible for listing on the National Register of Historic Places, including previously unidentified properties. For such activities, the pre-construction notification must state which historic properties might have the potential to be affected by the proposed NWP activity or include a vicinity map indicating the location of the historic properties or the potential for the presence of historic properties. Assistance regarding information on the location of, or potential for, the presence of historic properties can be sought from the State Historic Preservation Officer, Tribal Historic Preservation Officer, or designated tribal representative, as appropriate, and the National Register of Historic Places (see 33 CFR 330.4(g)). When reviewing pre-construction notifications, district engineers will comply with the current procedures for addressing the requirements of section 106 of the National Historic Preservation Act. The district engineer shall make a reasonable and good faith effort to carry out appropriate identification efforts, which may include background research, consultation, oral history interviews, sample field investigation, and field survey. Based on the information submitted in the PCN and these identification efforts, the district engineer shall determine whether the proposed NWP activity has the potential to cause effects on the historic properties. Section 106 consultation is not required when the district engineer determines that the activity does not have the potential to cause effects on historic properties (see 36 CFR 800.3(a)). Section 106 consultation is required when the district engineer determines that the activity has the potential to cause effects on historic properties. The district engineer will conduct consultation with consulting parties identified under 36 CFR 800.2(c) when he or she makes any of the following effect determinations for the purposes of section 106 of the NHPA: no historic properties affected, no adverse effect, or adverse effect. Where the non-Federal applicant has identified historic properties on which the activity might have the potential to cause effects and so notified the Corps, the non-Federal applicant shall not begin the activity until notified by the district engineer either that the activity has no potential to cause effects to historic properties or that NHPA section 106 consultation has been completed.

(d) For non-federal permittees, the district engineer will notify the prospective permittee within 45 days of receipt of a complete pre-construction notification whether NHPA section 106 consultation is required. If NHPA section 106 consultation is required, the district engineer will notify the non-Federal applicant that he or she cannot begin the activity until section 106 consultation is completed. If the non-Federal applicant has not heard back from the Corps within 45 days, the applicant must still wait for notification from the Corps.

(e) Prospective permittees should be aware that section 110k of the NHPA (54 U.S.C. 306113) prevents the Corps from granting a permit or other assistance to an applicant who, with intent to avoid the requirements of section 106 of the NHPA, has intentionally significantly adversely affected a historic property to which the permit would relate, or having legal power to prevent it, allowed such significant adverse effect to occur, unless the Corps, after consultation with the Advisory Council on Historic Preservation (ACHP), determines that circumstances justify granting such assistance despite the adverse effect created or permitted by the applicant. If circumstances justify granting the assistance, the Corps is required to notify the ACHP and provide documentation specifying the circumstances, the degree of damage to the integrity of any historic properties affected, and proposed mitigation. This documentation must include any views obtained from the applicant, SHPO/THPO, appropriate Indian tribes if the undertaking occurs on or affects historic properties on tribal lands or affects properties of interest to those tribes, and other parties known to have a legitimate interest in the impacts to the permitted activity on historic properties.

21. Discovery of Previously Unknown Remains and Artifacts. If you discover any previously unknown historic, cultural or archeological remains and artifacts while accomplishing the activity authorized by this permit, you must immediately notify the district engineer of what you have found, and to the maximum extent practicable, avoid construction activities that may affect the remains and artifacts until the required coordination has been completed. The district engineer will initiate the Federal, Tribal, and state coordination required to determine if the items or remains warrant a recovery effort or if the site is eligible for listing in the National Register of Historic Places.

22. Designated Critical Resource Waters. Critical resource waters include, NOAA-managed marine sanctuaries and marine monuments, and National Estuarine Research Reserves. The district engineer may designate, after notice and opportunity for public comment, additional waters officially designated by a state as having particular environmental or ecological significance, such as outstanding national resource waters or state natural heritage sites. The district engineer may also designate additional critical resource waters after notice and opportunity for public comment.

(a) Discharges of dredged or fill material into waters of the United States are not authorized by NWP 7, 12, 14, 16, 17, 21, 29, 31, 35, 39, 40, 42, 43, 44, 49, 50, 51, and 52 for any activity within, or directly affecting, critical resource waters, including wetlands adjacent to such waters.

(b) For NWPs 3, 8, 10, 13, 15, 18, 19, 22, 23, 25, 27, 28, 30, 33, 34, 36, 37, 38, and 54, notification is required in accordance with general condition 32, for any activity proposed in the designated critical resource waters including wetlands adjacent to those waters. The district engineer may authorize activities under these NWPs only after it is determined that the impacts to the critical resource waters will be no more than minimal.

23. Mitigation. The district engineer will consider the following factors when determining appropriate and practicable mitigation necessary to ensure that the individual and cumulative adverse environmental effects are no more than minimal:

(a) The activity must be designed and constructed to avoid and minimize adverse effects, both temporary and permanent, to waters of the United States to the maximum extent practicable at the project site (i.e., on site).

(b) Mitigation in all its forms (avoiding, minimizing, rectifying, reducing, or compensating for resource losses) will be required to the extent necessary to ensure that the individual and cumulative adverse environmental effects are no more than minimal.

(c) Compensatory mitigation at a minimum one-for-one ratio will be required for all wetland losses that exceed 1/10-acre and require pre-construction notification, unless the district engineer determines in writing that either some other form of mitigation would be more environmentally appropriate or the adverse environmental effects of the proposed activity are no more than minimal, and provides an activity-specific waiver of this requirement. For wetland losses of 1/10-acre or less that require pre-construction notification, the district engineer may determine on a case-by-case basis that compensatory mitigation is required to ensure that the activity results in only minimal adverse environmental effects.

(d) For losses of streams or other open waters that require pre-construction notification, the district engineer may require compensatory mitigation to ensure that the activity results in no more than minimal adverse environmental effects. Compensatory mitigation for losses of streams should be provided, if practicable, through stream rehabilitation, enhancement, or preservation, since streams are difficult-to-replace resources (see 33 CFR 332.3(e)(3)).

(e) Compensatory mitigation plans for NWP activities in or near streams or other open waters will normally include a requirement for the restoration or enhancement, maintenance, and legal protection (e.g., conservation easements) of riparian areas next to open waters. In some cases, the restoration or maintenance/protection of riparian areas may be the only compensatory mitigation required. Restored riparian areas should consist of native species. The width of the required riparian area will address documented water quality or aquatic habitat loss concerns. Normally, the riparian area will be 25 to 50 feet wide on each side of the stream, but the district engineer may require slightly wider riparian areas to address documented water quality or habitat loss concerns. If it is not possible to restore or maintain/protect a riparian area on both sides of a stream, or if the waterbody is a lake or coastal waters, then restoring or maintaining/protecting a riparian area along a single bank or shoreline may be sufficient. Where both wetlands and open waters exist on the project site, the district engineer will determine the appropriate compensatory mitigation (e.g., riparian areas and/or wetlands compensation) based on what is best for the aquatic environment on a watershed basis. In cases where riparian areas are determined to be the most appropriate form of minimization or compensatory mitigation, the district engineer may waive or reduce the requirement to provide wetland compensatory mitigation for wetland losses.

(f) Compensatory mitigation projects provided to offset losses of aquatic resources must comply with the applicable provisions of 33 CFR part 332.

(1) The prospective permittee is responsible for proposing an appropriate compensatory mitigation option if compensatory mitigation is necessary to ensure that the activity results in no more than minimal adverse environmental effects. For the NWPs, the preferred mechanism for providing compensatory mitigation is mitigation bank credits or in-

lieu fee program credits (see 33 CFR 332.3(b)(2) and (3)). However, if an appropriate number and type of mitigation bank or in-lieu credits are not available at the time the PCN is submitted to the district engineer, the district engineer may approve the use of permittee-responsible mitigation.

(2) The amount of compensatory mitigation required by the district engineer must be sufficient to ensure that the authorized activity results in no more than minimal individual and cumulative adverse environmental effects (see 33 CFR 330.1(e)(3)). (See also 33 CFR 332.3(f)).

(3) Since the likelihood of success is greater and the impacts to potentially valuable uplands are reduced, aquatic resource restoration should be the first compensatory mitigation option considered for permittee-responsible mitigation.

(4) If permittee-responsible mitigation is the proposed option, the prospective permittee is responsible for submitting a mitigation plan. A conceptual or detailed mitigation plan may be used by the district engineer to make the decision on the NWP verification request, but a final mitigation plan that addresses the applicable requirements of 33 CFR 332.4(c)(2) through (14) must be approved by the district engineer before the permittee begins work in waters of the United States, unless the district engineer determines that prior approval of the final mitigation plan is not practicable or not necessary to ensure timely completion of the required compensatory mitigation (see 33 CFR 332.3(k)(3)).

(5) If mitigation bank or in-lieu fee program credits are the proposed option, the mitigation plan only needs to address the baseline conditions at the impact site and the number of credits to be provided.

(6) Compensatory mitigation requirements (e.g., resource type and amount to be provided as compensatory mitigation, site protection, ecological performance standards, monitoring requirements) may be addressed through conditions added to the NWP authorization, instead of components of a compensatory mitigation plan (see 33 CFR 332.4(c)(1)(ii)).

(g) Compensatory mitigation will not be used to increase the acreage losses allowed by the acreage limits of the NWPs. For example, if an NWP has an acreage limit of 1/2-acre, it cannot be used to authorize any NWP activity resulting in the loss of greater than 1/2-acre of waters of the United States, even if compensatory mitigation is provided that replaces or restores some of the lost waters. However, compensatory mitigation can and should be used, as necessary, to ensure that an NWP activity already meeting the established acreage limits also satisfies the no more than minimal impact requirement for the NWPs.

(h) Permittees may propose the use of mitigation banks, in-lieu fee programs, or permittee-responsible mitigation. When developing a compensatory mitigation proposal, the permittee must consider appropriate and practicable options consistent with the framework at 33 CFR 332.3(b). For activities resulting in the loss of marine or estuarine resources, permittee-responsible mitigation may be environmentally preferable if there are no mitigation banks or in-lieu fee programs in the area that have marine or estuarine credits available for sale or transfer to the permittee. For permittee-responsible mitigation, the special conditions of the NWP verification must clearly indicate the party or parties responsible for the implementation and performance of the compensatory mitigation project, and, if required, its long-term management.

(i) Where certain functions and services of waters of the United States are permanently adversely affected by a regulated activity, such as discharges of dredged or fill



material into waters of the United States that will convert a forested or scrub-shrub wetland to a herbaceous wetland in a permanently maintained utility line right-of-way, mitigation may be required to reduce the adverse environmental effects of the activity to the no more than minimal level.

24. Safety of Impoundment Structures. To ensure that all impoundment structures are safely designed, the district engineer may require non-Federal applicants to demonstrate that the structures comply with established state dam safety criteria or have been designed by qualified persons. The district engineer may also require documentation that the design has been independently reviewed by similarly qualified persons, and appropriate modifications made to ensure safety.

25. Water Quality. Where States and authorized Tribes, or EPA where applicable, have not previously certified compliance of an NWP with CWA section 401, individual 401 Water Quality Certification must be obtained or waived (see 33 CFR 330.4(c)). The district engineer or State or Tribe may require additional water quality management measures to ensure that the authorized activity does not result in more than minimal degradation of water quality.

26. Coastal Zone Management. In coastal states where an NWP has not previously received a state coastal zone management consistency concurrence, an individual state coastal zone management consistency concurrence must be obtained, or a presumption of concurrence must occur (see 33 CFR 330.4(d)). The district engineer or a State may require additional measures to ensure that the authorized activity is consistent with state coastal zone management requirements.

27. Regional and Case-By-Case Conditions. The activity must comply with any regional conditions that may have been added by the Division Engineer (see 33 CFR 330.4(e)) and with any case specific conditions added by the Corps or by the state, Indian Tribe, or U.S. EPA in its section 401 Water Quality Certification, or by the state in its Coastal Zone Management Act consistency determination.

28. Use of Multiple Nationwide Permits. The use of more than one NWP for a single and complete project is prohibited, except when the acreage loss of waters of the United States authorized by the NWPs does not exceed the acreage limit of the NWP with the highest specified acreage limit. For example, if a road crossing over tidal waters is constructed under NWP 14, with associated bank stabilization authorized by NWP 13, the maximum acreage loss of waters of the United States for the total project cannot exceed 1/3-acre.

29. Transfer of Nationwide Permit Verifications. If the permittee sells the property associated with a nationwide permit verification, the permittee may transfer the nationwide permit verification to the new owner by submitting a letter to the appropriate Corps district office to validate the transfer. A copy of the nationwide permit verification must be attached to the letter, and the letter must contain the following statement and signature:

“When the structures or work authorized by this nationwide permit are still in existence at the time the property is transferred, the terms and conditions of this nationwide permit, including any special conditions, will continue to be binding on the new owner(s) of the property. To

validate the transfer of this nationwide permit and the associated liabilities associated with compliance with its terms and conditions, have the transferee sign and date below.”

\_\_\_\_\_  
(Transferee)

\_\_\_\_\_  
(Date)

\*

30. Compliance Certification. Each permittee who receives an NWP verification letter from the Corps must provide a signed certification documenting completion of the authorized activity and implementation of any required compensatory mitigation. The success of any required permittee-responsible mitigation, including the achievement of ecological performance standards, will be addressed separately by the district engineer. The Corps will provide the permittee the certification document with the NWP verification letter. The certification document will include:

(a) A statement that the authorized activity was done in accordance with the NWP authorization, including any general, regional, or activity-specific conditions;

(b) A statement that the implementation of any required compensatory mitigation was completed in accordance with the permit conditions. If credits from a mitigation bank or in-lieu fee program are used to satisfy the compensatory mitigation requirements, the certification must include the documentation required by 33 CFR 332.3(l)(3) to confirm that the permittee secured the appropriate number and resource type of credits; and

(c) The signature of the permittee certifying the completion of the activity and mitigation.

The completed certification document must be submitted to the district engineer within 30 days of completion of the authorized activity or the implementation of any required compensatory mitigation, whichever occurs later.

\*

31. Activities Affecting Structures or Works Built by the United States. If an NWP activity also requires permission from the Corps pursuant to 33 U.S.C. 408 because it will alter or temporarily or permanently occupy or use a U.S. Army Corps of Engineers (USACE) federally authorized Civil Works project (a “USACE project”), the prospective permittee must submit a pre-construction notification. See paragraph (b)(10) of general condition 32. An activity that requires section 408 permission is not authorized by NWP until the appropriate Corps office issues the section 408 permission to alter, occupy, or use the USACE project, and the district engineer issues a written NWP verification.

\*

32. Pre-Construction Notification. (a) Timing. Where required by the terms of the NWP, the prospective permittee must notify the district engineer by submitting a pre-construction notification (PCN) as early as possible. The district engineer must determine if the PCN is complete within 30 calendar days of the date of receipt and, if the PCN is determined to be incomplete, notify the prospective permittee within that 30 day period to request the additional information necessary to make the PCN complete. The request must specify the information needed to make the PCN complete. As a general rule, district engineers will request additional information necessary to make the PCN complete only once. However, if the

prospective permittee does not provide all of the requested information, then the district engineer will notify the prospective permittee that the PCN is still incomplete and the PCN review process will not commence until all of the requested information has been received by the district engineer. The prospective permittee shall not begin the activity until either:

(1) He or she is notified in writing by the district engineer that the activity may proceed under the NWP with any special conditions imposed by the district or division engineer; or

(2) 45 calendar days have passed from the district engineer's receipt of the complete PCN and the prospective permittee has not received written notice from the district or division engineer. However, if the permittee was required to notify the Corps pursuant to general condition 18 that listed species or critical habitat might be affected or are in the vicinity of the activity, or to notify the Corps pursuant to general condition 20 that the activity might have the potential to cause effects to historic properties, the permittee cannot begin the activity until receiving written notification from the Corps that there is "no effect" on listed species or "no potential to cause effects" on historic properties, or that any consultation required under Section 7 of the Endangered Species Act (see 33 CFR 330.4(f)) and/or section 106 of the National Historic Preservation Act (see 33 CFR 330.4(g)) has been completed. Also, work cannot begin under NWPs 21, 49, or 50 until the permittee has received written approval from the Corps. If the proposed activity requires a written waiver to exceed specified limits of an NWP, the permittee may not begin the activity until the district engineer issues the waiver. If the district or division engineer notifies the permittee in writing that an individual permit is required within 45 calendar days of receipt of a complete PCN, the permittee cannot begin the activity until an individual permit has been obtained. Subsequently, the permittee's right to proceed under the NWP may be modified, suspended, or revoked only in accordance with the procedure set forth in 33 CFR 330.5(d)(2).

(b) Contents of Pre-Construction Notification: The PCN must be in writing and include the following information:

(1) Name, address and telephone numbers of the prospective permittee;

(2) Location of the proposed activity;

(3) Identify the specific NWP or NWP(s) the prospective permittee wants to use to authorize the proposed activity;

(4) A description of the proposed activity; the activity's purpose; direct and indirect adverse environmental effects the activity would cause, including the anticipated amount of loss of wetlands, other special aquatic sites, and other waters expected to result from the NWP activity, in acres, linear feet, or other appropriate unit of measure; a description of any proposed mitigation measures intended to reduce the adverse environmental effects caused by the proposed activity; and any other NWP(s), regional general permit(s), or individual permit(s) used or intended to be used to authorize any part of the proposed project or any related activity, including other separate and distant crossings for linear projects that require Department of the Army authorization but do not require pre-construction notification. The description of the proposed activity and any proposed mitigation measures should be sufficiently detailed to allow the district engineer to determine that the adverse environmental effects of the activity will be no more than minimal and to determine the need for compensatory mitigation or other mitigation measures. For single and complete linear projects, the PCN must include the quantity of anticipated losses of wetlands, other special aquatic sites, and other waters for each single and complete crossing of those wetlands, other special aquatic sites, and other waters.

Sketches should be provided when necessary to show that the activity complies with the terms of the NWP. (Sketches usually clarify the activity and when provided results in a quicker decision. Sketches should contain sufficient detail to provide an illustrative description of the proposed activity (e.g., a conceptual plan), but do not need to be detailed engineering plans);

(5) The PCN must include a delineation of wetlands, other special aquatic sites, and other waters, such as lakes and ponds, and perennial, intermittent, and ephemeral streams, on the project site. Wetland delineations must be prepared in accordance with the current method required by the Corps. The permittee may ask the Corps to delineate the special aquatic sites and other waters on the project site, but there may be a delay if the Corps does the delineation, especially if the project site is large or contains many wetlands, other special aquatic sites, and other waters. Furthermore, the 45 day period will not start until the delineation has been submitted to or completed by the Corps, as appropriate;

(6) If the proposed activity will result in the loss of greater than 1/10-acre of wetlands and a PCN is required, the prospective permittee must submit a statement describing how the mitigation requirement will be satisfied, or explaining why the adverse environmental effects are no more than minimal and why compensatory mitigation should not be required. As an alternative, the prospective permittee may submit a conceptual or detailed mitigation plan.

(7) For non-Federal permittees, if any listed species or designated critical habitat might be affected or is in the vicinity of the activity, or if the activity is located in designated critical habitat, the PCN must include the name(s) of those endangered or threatened species that might be affected by the proposed activity or utilize the designated critical habitat that might be affected by the proposed activity. For NWP activities that require pre-construction notification, Federal permittees must provide documentation demonstrating compliance with the Endangered Species Act;

(8) For non-Federal permittees, if the NWP activity might have the potential to cause effects to a historic property listed on, determined to be eligible for listing on, or potentially eligible for listing on, the National Register of Historic Places, the PCN must state which historic property might have the potential to be affected by the proposed activity or include a vicinity map indicating the location of the historic property. For NWP activities that require pre-construction notification, Federal permittees must provide documentation demonstrating compliance with section 106 of the National Historic Preservation Act;

(9) For an activity that will occur in a component of the National Wild and Scenic River System, or in a river officially designated by Congress as a “study river” for possible inclusion in the system while the river is in an official study status, the PCN must identify the Wild and Scenic River or the “study river” (see general condition 16); and

(10) For an activity that requires permission from the Corps pursuant to 33 U.S.C. 408 because it will alter or temporarily or permanently occupy or use a U.S. Army Corps of Engineers federally authorized civil works project, the pre-construction notification must include a statement confirming that the project proponent has submitted a written request for section 408 permission from the Corps office having jurisdiction over that USACE project.

(c) Form of Pre-Construction Notification: The standard individual permit application form (Form ENG 4345) may be used, but the completed application form must clearly indicate that it is an NWP PCN and must include all of the applicable information required in paragraphs (b)(1) through (10) of this general condition. A letter containing the required information may also be used. Applicants may provide electronic files of PCNs and

supporting materials if the district engineer has established tools and procedures for electronic submittals.

(d) Agency Coordination: (1) The district engineer will consider any comments from Federal and state agencies concerning the proposed activity's compliance with the terms and conditions of the NWP's and the need for mitigation to reduce the activity's adverse environmental effects so that they are no more than minimal.

(2) Agency coordination is required for: (i) all NWP activities that require pre-construction notification and result in the loss of greater than 1/2-acre of waters of the United States; (ii) NWP 21, 29, 39, 40, 42, 43, 44, 50, 51, and 52 activities that require pre-construction notification and will result in the loss of greater than 300 linear feet of stream bed; (iii) NWP 13 activities in excess of 500 linear feet, fills greater than one cubic yard per running foot, or involve discharges of dredged or fill material into special aquatic sites; and (iv) NWP 54 activities in excess of 500 linear feet, or that extend into the waterbody more than 30 feet from the mean low water line in tidal waters or the ordinary high water mark in the Great Lakes.

(3) When agency coordination is required, the district engineer will immediately provide (e.g., via e-mail, facsimile transmission, overnight mail, or other expeditious manner) a copy of the complete PCN to the appropriate Federal or state offices (FWS, state natural resource or water quality agency, EPA, and, if appropriate, the NMFS). With the exception of NWP 37, these agencies will have 10 calendar days from the date the material is transmitted to notify the district engineer via telephone, facsimile transmission, or e-mail that they intend to provide substantive, site-specific comments. The comments must explain why the agency believes the adverse environmental effects will be more than minimal. If so contacted by an agency, the district engineer will wait an additional 15 calendar days before making a decision on the pre-construction notification. The district engineer will fully consider agency comments received within the specified time frame concerning the proposed activity's compliance with the terms and conditions of the NWP's, including the need for mitigation to ensure the net adverse environmental effects of the proposed activity are no more than minimal. The district engineer will provide no response to the resource agency, except as provided below. The district engineer will indicate in the administrative record associated with each pre-construction notification that the resource agencies' concerns were considered. For NWP 37, the emergency watershed protection and rehabilitation activity may proceed immediately in cases where there is an unacceptable hazard to life or a significant loss of property or economic hardship will occur. The district engineer will consider any comments received to decide whether the NWP 37 authorization should be modified, suspended, or revoked in accordance with the procedures at 33 CFR 330.5.

(4) In cases of where the prospective permittee is not a Federal agency, the district engineer will provide a response to NMFS within 30 calendar days of receipt of any Essential Fish Habitat conservation recommendations, as required by section 305(b)(4)(B) of the Magnuson-Stevens Fishery Conservation and Management Act.

(5) Applicants are encouraged to provide the Corps with either electronic files or multiple copies of pre-construction notifications to expedite agency coordination.

### **DISTRICT ENGINEER'S DECISION**

1. In reviewing the PCN for the proposed activity, the district engineer will determine whether the activity authorized by the NWP will result in more than minimal

individual or cumulative adverse environmental effects or may be contrary to the public interest. If a project proponent requests authorization by a specific NWP, the district engineer should issue the NWP verification for that activity if it meets the terms and conditions of that NWP, unless he or she determines, after considering mitigation, that the proposed activity will result in more than minimal individual and cumulative adverse effects on the aquatic environment and other aspects of the public interest and exercises discretionary authority to require an individual permit for the proposed activity. For a linear project, this determination will include an evaluation of the individual crossings of waters of the United States to determine whether they individually satisfy the terms and conditions of the NWP(s), as well as the cumulative effects caused by all of the crossings authorized by NWP. If an applicant requests a waiver of the 300 linear foot limit on impacts to streams or of an otherwise applicable limit, as provided for in NWPs 13, 21, 29, 36, 39, 40, 42, 43, 44, 50, 51, 52, or 54, the district engineer will only grant the waiver upon a written determination that the NWP activity will result in only minimal individual and cumulative adverse environmental effects. For those NWPs that have a waivable 300 linear foot limit for losses of intermittent and ephemeral stream bed and a 1/2-acre limit (i.e., NWPs 21, 29, 39, 40, 42, 43, 44, 50, 51, and 52), the loss of intermittent and ephemeral stream bed, plus any other losses of jurisdictional waters and wetlands, cannot exceed 1/2-acre.

2. When making minimal adverse environmental effects determinations the district engineer will consider the direct and indirect effects caused by the NWP activity. He or she will also consider the cumulative adverse environmental effects caused by activities authorized by NWP and whether those cumulative adverse environmental effects are no more than minimal. The district engineer will also consider site specific factors, such as the environmental setting in the vicinity of the NWP activity, the type of resource that will be affected by the NWP activity, the functions provided by the aquatic resources that will be affected by the NWP activity, the degree or magnitude to which the aquatic resources perform those functions, the extent that aquatic resource functions will be lost as a result of the NWP activity (e.g., partial or complete loss), the duration of the adverse effects (temporary or permanent), the importance of the aquatic resource functions to the region (e.g., watershed or ecoregion), and mitigation required by the district engineer. If an appropriate functional or condition assessment method is available and practicable to use, that assessment method may be used by the district engineer to assist in the minimal adverse environmental effects determination. The district engineer may add case-specific special conditions to the NWP authorization to address site-specific environmental concerns.

3. If the proposed activity requires a PCN and will result in a loss of greater than 1/10-acre of wetlands, the prospective permittee should submit a mitigation proposal with the PCN. Applicants may also propose compensatory mitigation for NWP activities with smaller impacts, or for impacts to other types of waters (e.g., streams). The district engineer will consider any proposed compensatory mitigation or other mitigation measures the applicant has included in the proposal in determining whether the net adverse environmental effects of the proposed activity are no more than minimal. The compensatory mitigation proposal may be either conceptual or detailed. If the district engineer determines that the activity complies with the terms and conditions of the NWP and that the adverse environmental effects are no more than minimal, after considering mitigation, the district engineer will notify the permittee and

include any activity-specific conditions in the NWP verification the district engineer deems necessary. Conditions for compensatory mitigation requirements must comply with the appropriate provisions at 33 CFR 332.3(k). The district engineer must approve the final mitigation plan before the permittee commences work in waters of the United States, unless the district engineer determines that prior approval of the final mitigation plan is not practicable or not necessary to ensure timely completion of the required compensatory mitigation. If the prospective permittee elects to submit a compensatory mitigation plan with the PCN, the district engineer will expeditiously review the proposed compensatory mitigation plan. The district engineer must review the proposed compensatory mitigation plan within 45 calendar days of receiving a complete PCN and determine whether the proposed mitigation would ensure the NWP activity results in no more than minimal adverse environmental effects. If the net adverse environmental effects of the NWP activity (after consideration of the mitigation proposal) are determined by the district engineer to be no more than minimal, the district engineer will provide a timely written response to the applicant. The response will state that the NWP activity can proceed under the terms and conditions of the NWP, including any activity-specific conditions added to the NWP authorization by the district engineer.

4. If the district engineer determines that the adverse environmental effects of the proposed activity are more than minimal, then the district engineer will notify the applicant either: (a) that the activity does not qualify for authorization under the NWP and instruct the applicant on the procedures to seek authorization under an individual permit; (b) that the activity is authorized under the NWP subject to the applicant's submission of a mitigation plan that would reduce the adverse environmental effects so that they are no more than minimal; or (c) that the activity is authorized under the NWP with specific modifications or conditions. Where the district engineer determines that mitigation is required to ensure no more than minimal adverse environmental effects, the activity will be authorized within the 45-day PCN period (unless additional time is required to comply with general conditions 18, 20, and/or 31, or to evaluate PCNs for activities authorized by NWPs 21, 49, and 50), with activity-specific conditions that state the mitigation requirements. The authorization will include the necessary conceptual or detailed mitigation plan or a requirement that the applicant submit a mitigation plan that would reduce the adverse environmental effects so that they are no more than minimal. When compensatory mitigation is required, no work in waters of the United States may occur until the district engineer has approved a specific mitigation plan or has determined that prior approval of a final mitigation plan is not practicable or not necessary to ensure timely completion of the required compensatory mitigation.

### **FURTHER INFORMATION**

1. District Engineers have authority to determine if an activity complies with the terms and conditions of an NWP.
2. NWPs do not obviate the need to obtain other federal, state, or local permits, approvals, or authorizations required by law.
3. NWPs do not grant any property rights or exclusive privileges.
4. NWPs do not authorize any injury to the property or rights of others.
5. NWPs do not authorize interference with any existing or proposed Federal project (see general condition 31).

**DEFINITIONS**

Best management practices (BMPs): Policies, practices, procedures, or structures implemented to mitigate the adverse environmental effects on surface water quality resulting from development. BMPs are categorized as structural or non-structural.

Compensatory mitigation: The restoration (re-establishment or rehabilitation), establishment (creation), enhancement, and/or in certain circumstances preservation of aquatic resources for the purposes of offsetting unavoidable adverse impacts which remain after all appropriate and practicable avoidance and minimization has been achieved.

Currently serviceable: Useable as is or with some maintenance, but not so degraded as to essentially require reconstruction.

Direct effects: Effects that are caused by the activity and occur at the same time and place.

Discharge: The term “discharge” means any discharge of dredged or fill material into waters of the United States.

Ecological reference: A model used to plan and design an aquatic habitat and riparian area restoration, enhancement, or establishment activity under NWP 27. An ecological reference may be based on the structure, functions, and dynamics of an aquatic habitat type or a riparian area type that currently exists in the region where the proposed NWP 27 activity is located. Alternatively, an ecological reference may be based on a conceptual model for the aquatic habitat type or riparian area type to be restored, enhanced, or established as a result of the proposed NWP 27 activity. An ecological reference takes into account the range of variation of the aquatic habitat type or riparian area type in the region.

Enhancement: The manipulation of the physical, chemical, or biological characteristics of an aquatic resource to heighten, intensify, or improve a specific aquatic resource function(s). Enhancement results in the gain of selected aquatic resource function(s), but may also lead to a decline in other aquatic resource function(s). Enhancement does not result in a gain in aquatic resource area.

Ephemeral stream: An ephemeral stream has flowing water only during, and for a short duration after, precipitation events in a typical year. Ephemeral stream beds are located above the water table year-round. Groundwater is not a source of water for the stream. Runoff from rainfall is the primary source of water for stream flow.

Establishment (creation): The manipulation of the physical, chemical, or biological characteristics present to develop an aquatic resource that did not previously exist at an upland site. Establishment results in a gain in aquatic resource area.

High Tide Line: The line of intersection of the land with the water’s surface at the maximum height reached by a rising tide. The high tide line may be determined, in the absence of actual data, by a line of oil or scum along shore objects, a more or less continuous deposit of fine shell or debris on the foreshore or berm, other physical markings or characteristics, vegetation lines, tidal gages, or other suitable means that delineate the general height reached by a rising tide. The line encompasses spring high tides and other high tides that occur with periodic frequency but does not include storm surges in which there is a departure from the normal or predicted reach of the tide due to the piling up of water against a coast by strong winds such as those accompanying a hurricane or other intense storm.

Historic Property: Any prehistoric or historic district, site (including archaeological site), building, structure, or other object included in, or eligible for inclusion in, the National



Register of Historic Places maintained by the Secretary of the Interior. This term includes artifacts, records, and remains that are related to and located within such properties. The term includes properties of traditional religious and cultural importance to an Indian tribe or Native Hawaiian organization and that meet the National Register criteria (36 CFR part 60).

Independent utility: A test to determine what constitutes a single and complete non-linear project in the Corps Regulatory Program. A project is considered to have independent utility if it would be constructed absent the construction of other projects in the project area. Portions of a multi-phase project that depend upon other phases of the project do not have independent utility. Phases of a project that would be constructed even if the other phases were not built can be considered as separate single and complete projects with independent utility.

Indirect effects: Effects that are caused by the activity and are later in time or farther removed in distance, but are still reasonably foreseeable.

Intermittent stream: An intermittent stream has flowing water during certain times of the year, when groundwater provides water for stream flow. During dry periods, intermittent streams may not have flowing water. Runoff from rainfall is a supplemental source of water for stream flow.

Loss of waters of the United States: Waters of the United States that are permanently adversely affected by filling, flooding, excavation, or drainage because of the regulated activity. Permanent adverse effects include permanent discharges of dredged or fill material that change an aquatic area to dry land, increase the bottom elevation of a waterbody, or change the use of a waterbody. The acreage of loss of waters of the United States is a threshold measurement of the impact to jurisdictional waters for determining whether a project may qualify for an NWP; it is not a net threshold that is calculated after considering compensatory mitigation that may be used to offset losses of aquatic functions and services. The loss of stream bed includes the acres or linear feet of stream bed that are filled or excavated as a result of the regulated activity. Waters of the United States temporarily filled, flooded, excavated, or drained, but restored to pre-construction contours and elevations after construction, are not included in the measurement of loss of waters of the United States. Impacts resulting from activities that do not require Department of the Army authorization, such as activities eligible for exemptions under section 404(f) of the Clean Water Act, are not considered when calculating the loss of waters of the United States.

Navigable waters: Waters subject to section 10 of the Rivers and Harbors Act of 1899. These waters are defined at 33 CFR part 329.

Non-tidal wetland: A non-tidal wetland is a wetland that is not subject to the ebb and flow of tidal waters. Non-tidal wetlands contiguous to tidal waters are located landward of the high tide line (i.e., spring high tide line).

Open water: For purposes of the NWPs, an open water is any area that in a year with normal patterns of precipitation has water flowing or standing above ground to the extent that an ordinary high water mark can be determined. Aquatic vegetation within the area of flowing or standing water is either non-emergent, sparse, or absent. Vegetated shallows are considered to be open waters. Examples of “open waters” include rivers, streams, lakes, and ponds.

Ordinary High Water Mark: An ordinary high water mark is a line on the shore established by the fluctuations of water and indicated by physical characteristics, or by other appropriate means that consider the characteristics of the surrounding areas.

Perennial stream: A perennial stream has flowing water year-round during a typical year. The water table is located above the stream bed for most of the year. Groundwater is the

primary source of water for stream flow. Runoff from rainfall is a supplemental source of water for stream flow.

**Practicable**: Available and capable of being done after taking into consideration cost, existing technology, and logistics in light of overall project purposes.

**Pre-construction notification**: A request submitted by the project proponent to the Corps for confirmation that a particular activity is authorized by nationwide permit. The request may be a permit application, letter, or similar document that includes information about the proposed work and its anticipated environmental effects. Pre-construction notification may be required by the terms and conditions of a nationwide permit, or by regional conditions. A pre-construction notification may be voluntarily submitted in cases where pre-construction notification is not required and the project proponent wants confirmation that the activity is authorized by nationwide permit.

**Preservation**: The removal of a threat to, or preventing the decline of, aquatic resources by an action in or near those aquatic resources. This term includes activities commonly associated with the protection and maintenance of aquatic resources through the implementation of appropriate legal and physical mechanisms. Preservation does not result in a gain of aquatic resource area or functions.

**Protected tribal resources**: Those natural resources and properties of traditional or customary religious or cultural importance, either on or off Indian lands, retained by, or reserved by or for, Indian tribes through treaties, statutes, judicial decisions, or executive orders, including tribal trust resources.

**Re-establishment**: The manipulation of the physical, chemical, or biological characteristics of a site with the goal of returning natural/historic functions to a former aquatic resource. Re-establishment results in rebuilding a former aquatic resource and results in a gain in aquatic resource area and functions.

**Rehabilitation**: The manipulation of the physical, chemical, or biological characteristics of a site with the goal of repairing natural/historic functions to a degraded aquatic resource. Rehabilitation results in a gain in aquatic resource function, but does not result in a gain in aquatic resource area.

**Restoration**: The manipulation of the physical, chemical, or biological characteristics of a site with the goal of returning natural/historic functions to a former or degraded aquatic resource. For the purpose of tracking net gains in aquatic resource area, restoration is divided into two categories: re-establishment and rehabilitation.

**Riffle and pool complex**: Riffle and pool complexes are special aquatic sites under the 404(b)(1) Guidelines. Riffle and pool complexes sometimes characterize steep gradient sections of streams. Such stream sections are recognizable by their hydraulic characteristics. The rapid movement of water over a coarse substrate in riffles results in a rough flow, a turbulent surface, and high dissolved oxygen levels in the water. Pools are deeper areas associated with riffles. A slower stream velocity, a streaming flow, a smooth surface, and a finer substrate characterize pools.

**Riparian areas**: Riparian areas are lands next to streams, lakes, and estuarine- marine shorelines. Riparian areas are transitional between terrestrial and aquatic ecosystems, through which surface and subsurface hydrology connects riverine, lacustrine, estuarine, and marine waters with their adjacent wetlands, non-wetland waters, or uplands. Riparian areas provide a variety of ecological functions and services and help improve or maintain local water quality. (See general condition 23.)

**Shellfish seeding:** The placement of shellfish seed and/or suitable substrate to increase shellfish production. Shellfish seed consists of immature individual shellfish or individual shellfish attached to shells or shell fragments (i.e., spat on shell). Suitable substrate may consist of shellfish shells, shell fragments, or other appropriate materials placed into waters for shellfish habitat.

**Single and complete linear project:** A linear project is a project constructed for the purpose of getting people, goods, or services from a point of origin to a terminal point, which often involves multiple crossings of one or more waterbodies at separate and distant locations. The term “single and complete project” is defined as that portion of the total linear project proposed or accomplished by one owner/developer or partnership or other association of owners/developers that includes all crossings of a single water of the United States (i.e., a single waterbody) at a specific location. For linear projects crossing a single or multiple waterbodies several times at separate and distant locations, each crossing is considered a single and complete project for purposes of NWP authorization. However, individual channels in a braided stream or river, or individual arms of a large, irregularly shaped wetland or lake, etc., are not separate waterbodies, and crossings of such features cannot be considered separately.

**Single and complete non-linear project:** For non-linear projects, the term “single and complete project” is defined at 33 CFR 330.2(i) as the total project proposed or accomplished by one owner/developer or partnership or other association of owners/developers. A single and complete non-linear project must have independent utility (see definition of “independent utility”). Single and complete non-linear projects may not be “piecemealed” to avoid the limits in an NWP authorization.

**Stormwater management:** Stormwater management is the mechanism for controlling stormwater runoff for the purposes of reducing downstream erosion, water quality degradation, and flooding and mitigating the adverse effects of changes in land use on the aquatic environment.

**Stormwater management facilities:** Stormwater management facilities are those facilities, including but not limited to, stormwater retention and detention ponds and best management practices, which retain water for a period of time to control runoff and/or improve the quality (i.e., by reducing the concentration of nutrients, sediments, hazardous substances and other pollutants) of stormwater runoff.

**Stream bed:** The substrate of the stream channel between the ordinary high water marks. The substrate may be bedrock or inorganic particles that range in size from clay to boulders. Wetlands contiguous to the stream bed, but outside of the ordinary high water marks, are not considered part of the stream bed.

**Stream channelization:** The manipulation of a stream’s course, condition, capacity, or location that causes more than minimal interruption of normal stream processes. A channelized stream remains a water of the United States.

**Structure:** An object that is arranged in a definite pattern of organization. Examples of structures include, without limitation, any pier, boat dock, boat ramp, wharf, dolphin, weir, boom, breakwater, bulkhead, revetment, riprap, jetty, artificial island, artificial reef, permanent mooring structure, power transmission line, permanently moored floating vessel, piling, aid to navigation, or any other manmade obstacle or obstruction.

**Tidal wetland:** A tidal wetland is a jurisdictional wetland that is inundated by tidal waters. Tidal waters rise and fall in a predictable and measurable rhythm or cycle due to the gravitational pulls of the moon and sun. Tidal waters end where the rise and fall of the water

surface can no longer be practically measured in a predictable rhythm due to masking by other waters, wind, or other effects. Tidal wetlands are located channelward of the high tide line.

**Tribal lands:** Any lands title to which is either: 1) held in trust by the United States for the benefit of any Indian tribe or individual; or 2) held by any Indian tribe or individual subject to restrictions by the United States against alienation.

**Tribal rights:** Those rights legally accruing to a tribe or tribes by virtue of inherent sovereign authority, unextinguished aboriginal title, treaty, statute, judicial decisions, executive order or agreement, and that give rise to legally enforceable remedies.

**Vegetated shallows:** Vegetated shallows are special aquatic sites under the 404(b)(1) Guidelines. They are areas that are permanently inundated and under normal circumstances have rooted aquatic vegetation, such as seagrasses in marine and estuarine systems and a variety of vascular rooted plants in freshwater systems.

**Waterbody:** For purposes of the NWPs, a waterbody is a jurisdictional water of the United States. If a wetland is adjacent to a waterbody determined to be a water of the United States, that waterbody and any adjacent wetlands are considered together as a single aquatic unit (see 33 CFR 328.4(c)(2)). Examples of “waterbodies” include streams, rivers, lakes, ponds, and wetlands.

**FINAL 2017 REGIONAL CONDITIONS**

*NOTICE ABOUT WEB LINKS IN THIS DOCUMENT:*

*The web links (both internal to our Wilmington District and any external links to collaborating agencies) in this document are valid at the time of publication. However, the Wilmington District Regulatory Program web page addresses, as with other agency web sites, may change over the timeframe of the five-year Nationwide Permit renewal cycle, in response to policy mandates or technology advances. While we will make every effort to check on the integrity of our web links and provide re-direct pages whenever possible, we ask that you report any broken links to us so we can keep the page information current and usable. We apologize in advanced for any broken links that you may encounter, and we ask that you navigate from the Regulatory home page (Regulatory Permit Program Wetlands and Streams) of the Wilmington District Corps of Engineers, to the “Permits” section of our web site to find links for pages that cannot be found by clicking directly on the listed web link in this document.*

**Final 2017 Regional Conditions for Nationwide Permits (NWP) in the Wilmington District**

**1.0 Excluded Waters**

The Corps has identified waters that will be excluded from the use of all NWP’s during certain timeframes. These waters are:

**1.1 Anadromous Fish Spawning Areas**

Waters of the United States identified by either the North Carolina Division of Marine Fisheries (NCDMF) or the North Carolina Wildlife Resources Commission (NCWRC) as anadromous fish spawning areas are excluded during the period between February 15 and June 30, without prior written approval from the Corps and either NCDMF or NCWRC.

**1.2 Trout Waters Moratorium**

Waters of the United States in the designated trout watersheds of North Carolina are excluded during the period between October 15 and April 15 without prior written approval from the NCWRC, or from the Eastern Band of Cherokee Indians (EBCI) Fisheries and Wildlife Management (FWM) office if the project is located on EBCI trust land. (See Section 2.7 for information on the designated trout watersheds).

**1.3 Sturgeon Spawning Areas as Designated by the National Marine Fisheries Service (NMFS)**

Waters of the United States designated as sturgeon spawning areas are excluded during the period between February 1 and June 30, without prior written approval from the NMFS.

**\* 2.0 Waters Requiring Additional Notification**

The Corps has identified waters that will be subject to additional notification requirements for activities authorized by all NWP's. These waters are:

**\* 2.1 Western NC Counties that Drain to Designated Critical Habitat**

For proposed activities within waters of the United States that require a Pre-Construction Notification (PCN) and are located in the sixteen counties listed below, permittees must provide a copy of the PCN to the U.S. Fish and Wildlife Service (USFWS), 160 Zillicoa Street, Asheville, North Carolina 28801. This PCN must be sent concurrently to the U.S. Fish and Wildlife Service and the Corps Asheville Regulatory Field Office. Please see General Condition 18 for specific notification requirements related to the Endangered Species Act and the below website for information on the location of designated critical habitat.

Counties with tributaries that drain to designated critical habitat that require notification to the Asheville U.S. Fish and Wildlife Service: Avery, Cherokee, Forsyth, Graham, Haywood, Henderson, Jackson, Macon, Mecklenburg, Mitchell, Stokes, Surry, Swain, Transylvania, Union and Yancey.

Website and office addresses for Endangered Species Act Information:

The Wilmington District has developed the following website for permittees which provides guidelines on how to review linked websites and maps in order to fulfill NWP General Condition 18 requirements:

<http://www.saw.usace.army.mil/Missions/RegulatoryPermitProgram/AgencyCoordination/ESA.aspx>

Permittees who do not have internet access may contact the appropriate U.S. Fish and Wildlife Service offices listed below or Corps at (910) 251-4633:

Asheville U.S. Fish and Wildlife Service Office counties: All counties west of and including Anson, Stanly, Davidson, Forsythe and Stokes Counties.

U.S. Fish and Wildlife Service  
Asheville Field Office  
160 Zillicoa Street  
Asheville, NC 28801  
Telephone: (828) 258-3939

Raleigh U.S. Fish and Wildlife Service Office counties: all counties east of and including Richmond, Montgomery, Randolph, Guilford, and Rockingham Counties.

U.S. Fish and Wildlife Service  
Raleigh Field Office  
Post Office Box 33726

Raleigh, NC 27636-3726  
Telephone: (919) 856-4520

## \* 2.2 Special Designation Waters

Prior to the use of any NWP, except NWP 3, that involves a discharge of dredged or fill material in any of the following identified waters and/or adjacent wetlands in North Carolina, permittees shall submit a PCN to the District Engineer prior to commencing the activity (see General Condition 32). The North Carolina waters and wetlands that require additional notification requirements are:

“Outstanding Resource Waters” (ORW) or “High Quality Waters” (HQW) as designated by the North Carolina Environmental Management Commission; “Primary Nursery Areas” (PNA), including inland PNA, as designated by the North Carolina Marine Fisheries Commission and the NCWRC; or wetlands adjacent to these waters. Definitions of ORW, HQW and PNA waters can be found in the North Carolina State Administrative Code, Title 15A, Subchapters 2B and 10C (15A NCAC 02B, 15A NCAC 10C) and at the following World Wide Web page:

<http://reports.oah.state.nc.us/ncac.asp?folderName=\Title%2015A%20-%20Environmental%20Quality&lookUpError=15A%20NCAC%20000%20>. Surface water classifications for waters in North Carolina can be viewed at the North Carolina Division of Water Resources website or at the following World Wide Web Page:

<https://deq.nc.gov/about/divisions/water-resources/planning/classification-standards/classifications>

Permittees who do not have internet access may contact the Corps at (910) 251- 4633.

## 2.3 Coastal Area Management Act (CAMA) Areas of Environmental Concern

Non-federal permittees for any NWP in a designated “Area of Environmental Concern” (AEC) in the twenty (20) counties of Eastern North Carolina covered by the North Carolina Coastal Area Management Act (CAMA) must also obtain the required CAMA permit. Development activities for non-federal projects may not commence until a copy of the approved CAMA permit is furnished to the appropriate Wilmington District Regulatory Field Office (Wilmington Field Office – 69 Darlington Avenue, Wilmington, NC 28403, (910) 251-4802 or Washington Field Office – 2407 West 5th Street, Washington, NC 27889, (910) 251-4610).

## \* 2.4 Barrier Islands

Prior to the use of any NWP on a barrier island of North Carolina, permittees must submit a PCN to the District Engineer prior to commencing the activity (see General Condition 32).

## \* 2.5 Mountain or Piedmont Bogs

Prior to the use of any NWP in a Bog, as classified by the North Carolina Wetland Assessment Methodology (NCWAM), permittees shall submit a PCN to the District Engineer prior to commencing the activity (see General Condition 32). The latest version of NCWAM can be

viewed on the Corps RIBITS (Regulatory In-lieu Fee and Bank Information Tracking System) website or at the following World Wide Web Page:

[https://ribits.usace.army.mil/ribits\\_apex/f?p=107:27:0::NO::](https://ribits.usace.army.mil/ribits_apex/f?p=107:27:0::NO::)

**\* 2.6 Animal Waste Facilities**

Prior to use of any NWP for construction of animal waste facilities in waters of the United States, including wetlands, permittees shall submit a PCN to the District Engineer prior to commencing the activity (see General Condition 32).

**\* 2.7 Trout Waters**

Prior to any discharge of dredge or fill material into streams, waterbodies or wetlands within the 294 designated trout watersheds of North Carolina, the permittee shall submit a PCN (see General Condition 32) to the District Engineer prior to commencing the activity, unless other thresholds are established in the Regional Conditions in Section 4 (Additional Regional Conditions for Specific Nationwide Permits). The permittee shall also provide a copy of the notification to the appropriate NCWRC office, or to the EBCI FWM Office (if the project is located on EBCI trust land), to facilitate the determination of any potential impacts to designated Trout Waters.

Notification to the Corps will include a statement with the name of the NCWRC or EBCI FWM biologist contacted, the date of the notification, the location of work, a delineation of wetlands and waters, a discussion of alternatives to working in the mountain trout waters, why alternatives were not selected, and, if applicable, a plan to provide compensatory mitigation for all unavoidable adverse impacts to mountain trout waters.

NCWRC and NC Trout Watersheds:

<b>NCWRC Contact**</b>	<b>Counties that are entirely within Trout Watersheds*</b>	<b>Counties that are partially within Trout Watersheds*</b>
Mountain Coordinator Balsam Depot 20830 Great Smoky Mountain Expressway Waynesville, NC 28786 Telephone: (828) 558-6011  For NCDOT Projects:  NCDOT Coordinator 206 Charter. Street Albemarle, NC 28001 Telephone: (704) 982-9181	Alleghany    Jackson Ashe            Macon Avery           Swain Graham        Transylvania Haywood       Watauga	Burke           McDowell Buncombe     Mitchell Caldwell       Polk Cherokee       Rutherford Clay             Surry Henderson     Wilkes Madison         Yancey



\*NOTE: To determine notification requirements, contact the Corps Asheville Regulatory Field Office at (828) 271-7980 or view maps for each County at the following World Wide Web page: <http://www.saw.usace.army.mil/Missions/Regulatory-Permit-Program/Agency-Coordination/Trout/>.

\*\*If a project is located on EBCI trust land, submit the PCN in accordance with Section 3.14. Contact the Corps Asheville Regulatory Field Office at (828) 271-7980 with questions.

**\* 2.8 Western NC Waters and Corridors**

The permittee shall submit a PCN (see General Condition 32) to the District Engineer prior to commencing the activity in waters of the United States if the activity will occur within any of the following identified waters in western North Carolina, within 0.5 mile on either side of these waters, or within 0.75 mile of the Little Tennessee River, as measured from the top of the bank of the respective water (i.e., river, stream, or creek):

Brasstown Creek  
Burningtown Creek  
Cane River  
Caney Fork  
Cartoogechaye Creek  
Chattooga River  
Cheoah River  
Cowee Creek  
Cullasaja River  
Deep Creek  
Ellijay Creek  
French Broad River  
Garden Creek  
Hiwassee River  
Hominy Creek  
Iotla Creek  
Little Tennessee River (within the river or within 0.75 mile on either side of this river)  
Nantahala River  
Nolichucky River  
North Fork French Broad River  
North Toe River  
Nottley River  
Oconaluftee River (portion not located on trust/EBCI land)  
Peachtree Creek  
Shooting Creek  
Snowbird Creek  
South Toe River  
Stecoah Creek  
Swannanoa River  
Sweetwater Creek

Tuckasegee River (also spelled Tuckaseegee or Tuckaseigee)  
Valley River  
Watauga Creek  
Watauga River  
Wayah Creek  
West Fork French Broad River

To determine notification requirements, contact the Corps Asheville Regulatory Field Office at (828) 271-7980 or view maps for all corridors at the following World Wide Web page:

<http://www.saw.usace.army.mil/Missions/Regulatory-Permit-Program/Agency-Coordination/Designated-Special-Waters.aspx>

### **3.0 List of Corps Regional Conditions for All Nationwide Permits**

The following conditions apply to all Nationwide Permits in the Wilmington District:

#### **3.1 Limitation of Loss of Stream Bed**

NWPs may not be used for activities that may result in the loss or degradation of more than 300 total linear feet of stream bed, unless the District Engineer has waived the 300 linear foot limit for ephemeral and intermittent streams on a case-by-case basis and has determined that the proposed activity will result in minimal individual and cumulative adverse impacts to the aquatic environment. Waivers for the loss of ephemeral and intermittent streams must be in writing and documented by appropriate/accepted stream quality assessments\*. This waiver only applies to the 300 linear feet threshold for NWPs.

This Regional Condition does not apply to NWP 23 (Approved Categorical Exclusions).

\*NOTE: Permittees should utilize the most current methodology prescribed by Wilmington District to assess stream function and quality. Information can be found at:

[https://ribits.usace.army.mil/ribits\\_apex/f?p=107:27:0::NO::](https://ribits.usace.army.mil/ribits_apex/f?p=107:27:0::NO::)

#### **3.2 Mitigation for Loss of Stream Bed**

For any NWP that results in a loss of more than 150 linear feet of stream, the permittee shall provide a mitigation proposal to compensate for more than minimal individual and cumulative adverse impacts to the aquatic environment. For stream losses of 150 linear feet or less that require a PCN, the District Engineer may determine, on a case-by-case basis, that compensatory mitigation is required to ensure that the activity results in minimal adverse effect on the aquatic environment.

#### **3.3 Pre-construction Notification for Loss of Streambed Exceeding 150 Feet**

Prior to use of any NWP for any activity which impacts more than 150 total linear feet of perennial stream, intermittent or ephemeral stream, the permittee shall submit a PCN to the District Engineer prior to commencing the activity (see General Condition 32). This applies to

NWPs that do not have specific notification requirements. If a NWP has specific notification requirements, the requirements of the NWP should be followed.

### **3.4 Restriction on Use of Live Concrete**

For all NWPs which allow the use of concrete as a building material, live or fresh concrete, including bags of uncured concrete, may not come into contact with the water in or entering into waters of the United States. Water inside coffer dams or casings that has been in contact with wet concrete shall only be returned to waters of the United States after the concrete is set and cured and when it no longer poses a threat to aquatic organisms.

### **3.5 Requirements for Using Riprap for Bank Stabilization**

For all NWPs that allow for the use of riprap material for bank stabilization, the following measures shall be applied:

**3.5.1.** Where bank stabilization is conducted as part of an activity, natural design, bioengineering and/or geoengineering methods that incorporate natural durable materials, native seed mixes, and native plants and shrubs are to be utilized to the maximum extent practicable.

**3.5.2.** Filter cloth must be placed underneath the riprap as an additional requirement of its use in North Carolina waters. The placement of filter fabric is not required if the riprap will be pushed or “keyed” into the bank of the waterbody. A waiver from the specifications in this Regional Condition may be requested in writing. The waiver will only be issued if it can be demonstrated that the impacts of complying with this Regional Condition would result in greater adverse impacts to the aquatic environment.

**3.5.3.** The placement of riprap shall be limited to the areas depicted on submitted work plan drawings.

**3.5.4.** The riprap material shall be clean and free from loose dirt or any pollutant except in trace quantities that would not have an adverse environmental effect.

**3.5.5.** It shall be of a size sufficient to prevent its movement from the authorized alignment by natural forces under normal conditions.

**3.5.6.** The riprap material shall consist of clean rock or masonry material such as, but not limited to, granite, marl, or broken concrete.

### **3.6 Requirements for Culvert Placement**

**3.6.1** For all NWPs that involve the construction/installation of culverts, measures will be included in the construction/installation that will promote the safe passage of fish and other aquatic organisms. The dimension, pattern, and profile of the stream above and below a pipe or culvert should not be modified by altering the width or depth of the stream profile in connection with the construction activity. The width, height, and gradient of a proposed culvert should be

sufficient to pass the average historical low flow and spring flow without adversely altering flow velocity. Spring flow is the seasonal sustained high flow that typically occurs in the spring. Spring flows should be determined from gage data, if available. In the absence of such data, bank-full flow can be used as a comparable indicator.

In Public Trust Areas of Environmental Concern (AEC) and/or the Estuarine Waters AEC as designated by the Coastal Area Management Act (CAMA): All pipes/culverts must be sufficiently sized to allow for the burial of the bottom of the culvert at least one foot below normal bed elevation.

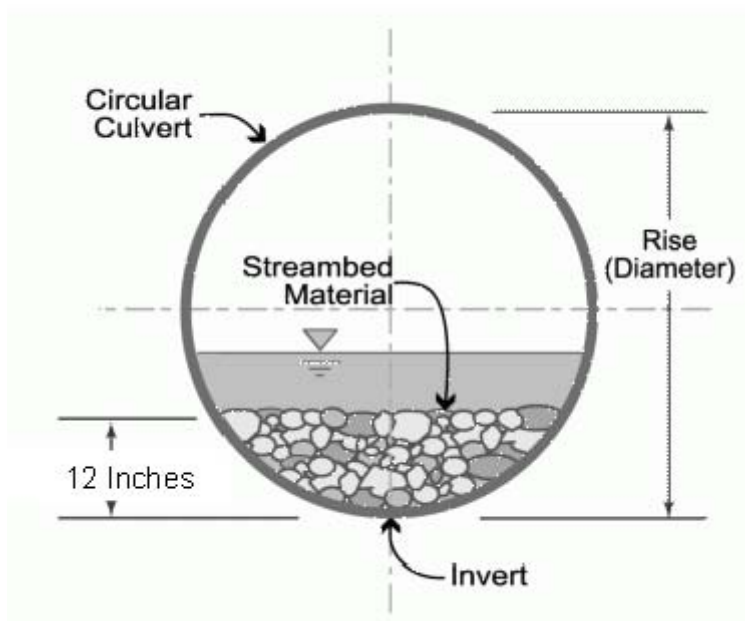

In all other areas: Culverts greater than 48 inches in diameter will be buried at least one foot below the bed of the stream. Culverts 48 inches in diameter or less shall be buried to maintain aquatic passage and to maintain passage during drought or low flow conditions, and every effort shall be made to maintain the existing channel slope.

Culverts must be designed and constructed in a manner that minimizes destabilization and head cutting. Destabilizing the channel and head cutting upstream should be considered and appropriate actions incorporated in the design and placement of the culvert.

A waiver from the depth specifications in this condition may be requested, in writing, by the permittee and issued by the Corp; this request must be specific as to the reasons(s) for the request. The waiver will be issued if it can be demonstrated that the proposed design would result in less impacts to the aquatic environment.

All counties: Culverts placed within riparian and/or riverine wetlands must be installed in a manner that does not restrict the flow and circulation patterns of waters of the United States.

Culverts placed across wetland fills purely for the purposes of equalizing surface water do not have to be buried, but the culverts must be of adequate size and/or number to ensure unrestricted transmission of water.

**3.6.2** Bank-full flows (or less) shall be accommodated through maintenance of the existing bank-full channel cross sectional area. Additional culverts or culvert barrels at such crossings shall be allowed only to receive bank-full flows.

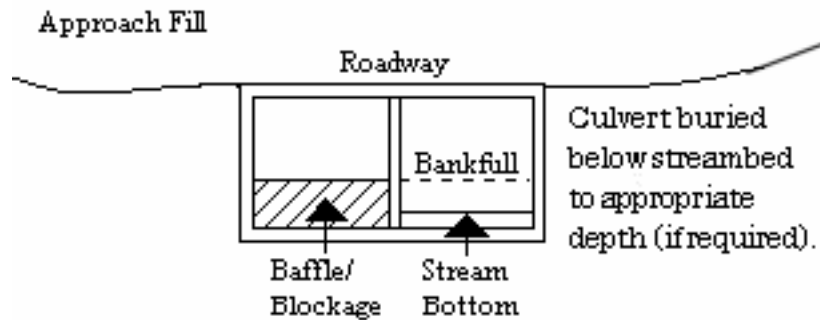

**3.6.3** Where adjacent floodplain is available, flows exceeding bank-full should be accommodated by installing culverts at the floodplain elevation. Additional culverts or culvert barrels at such crossings should not be buried, or if buried, must have sills at the inlets to ensure that they only receive flows exceeding bank-full.

**3.6.4** Excavation of existing stream channels shall be limited to the minimum necessary to construct or install the proposed culvert. The final width of the impacted stream at the culvert inlet and outlet should be no greater than the original stream width. A waiver from this condition may be requested in writing; this request must be specific as to the reason(s) for the request. The waiver will be issued if the proposed design would result in less impacts to the aquatic environment and/or if it can be demonstrated that it is not practicable to restore the final width of the impacted stream at the culvert inlet and outlet to the width of the original stream channel.

**3.6.5** The width of the culvert shall be comparable to the width of the stream channel. If the width of the culvert is wider than the stream channel, the culvert shall include baffles, benches and/or sills to maintain the width of the stream channel. A waiver from this condition may be requested in writing; this request must be specific as to the reason(s) for the request. The waiver will be issued if it can be demonstrated that it is not practicable or necessary to include baffles, benches or sills and the design would result in less impacts to the aquatic environment.

**3.7 Notification to NCDEQ Shellfish Sanitation Section**

Permittees shall notify the NCDEQ Shellfish Sanitation Section prior to dredging in or removing sediment from an area closed to shell fishing where the effluent may be released to an area open for shell fishing or swimming in order to avoid contamination from the disposal area and cause a temporary shellfish closure to be made. Such notification shall also be provided to the appropriate Corps Regulatory Field Office. Any disposal of sand to the ocean beach should occur between November 1 and April 30 when recreational usage is low. Only clean sand

should be used and no dredged sand from closed shell fishing areas may be used. If beach disposal were to occur at times other than stated above or if sand from a closed shell fishing area is to be used, a swimming advisory shall be posted, and a press release shall be issued by the permittee.

### **3.8 Submerged Aquatic Vegetation**

Impacts to Submerged Aquatic Vegetation (SAV) are not authorized by any NWP, except NWP 48, unless EFH Consultation has been completed pursuant to the Magnuson-Stevens Fisheries Conservation and Management Act (Magnuson-Stevens Act). Permittees shall submit a PCN (See NWP General Condition 32) to the District Engineer prior to commencing the activity if the project would affect SAV. The permittee may not begin work until notified by the Corps that the requirements of the Magnuson-Stevens Act have been satisfied and that the activity is authorized.

### **3.9 Sedimentation and Erosion Control Structures and Measures**

All PCNs will identify and describe sedimentation and erosion control structures and measures proposed for placement in waters of the United States. The structures and measures should be depicted on maps, surveys or drawings showing location and impacts to jurisdictional wetlands and streams.

### **3.10 Restoration of Temporary Impacts to Stream Beds**

Upon completion of work that involves temporary stream impacts, streambeds are to be restored to pre-project elevations and widths using natural streambed material such that the impacted stream reach mimics the adjacent upstream and downstream reach. The impacted area shall be backfilled with natural streambed material to a depth of at least 12 inches or to the bottom depth of the impacted area if shallower than 12 inches. An engineered in-stream structure or material can be used to provide protection of a buried structure if it provides benefits to the aquatic environment and can be accomplished by a natural streambed design. A permittee may request a waiver of this condition if it is determined a buried structure needs significant physical protection beyond those provided in this condition. This condition does not apply to NWP 27 – Aquatic Habitat Restoration, Enhancement, and Establishment Activities.

### **3.11 Restoration of Temporary Impacts to Stream Banks**

Upon completion of work involving temporary stream bank impacts, stream banks are to be restored to pre-project grade and contours or beneficial grade and contours if the original bank slope is steep and unstable. Natural durable materials, native seed mixes, and native plants and shrubs are to be utilized in the restoration. Natural designs which use bioengineered and/or geo-engineered methods are to be applied. An engineered structure or material can be used to provide protection of a buried structure if it provides benefits to the stream bank environment, provided it is not in excess of the minimum amount needed for protection and does not exceed an average of one cubic yard per running foot placed along the bank below the plane of the ordinary high water mark. A permittee may request a waiver of this condition if it is determined a buried structure

needs significant physical protection beyond those provided in this condition. This condition does not apply to NWP 27 – Aquatic Habitat Restoration, Enhancement, and Establishment Activities.

## **3.12 Federal Navigation Channel Setbacks and Corps Easements**

**3.12.1** Authorized structures and fills located in or adjacent to Federally authorized waterways will be constructed in accordance with the latest setback criteria established by the Wilmington District Engineer. You may review the setback policy at <http://www.saw.usace.army.mil/Missions/Navigation/Setbacks.aspx>. This general permit does not authorize the construction of hardened or permanently fixed structures within the Federally Authorized Channel Setback, unless the activity is approved by the Corps. The permittee shall submit a PCN (see General Condition 32) to the District Engineer prior to the construction of any structures or fills within the Federally Authorized Channel Setback.

**3.12.2** The permittee shall obtain a Consent to Cross Government Easement from the Wilmington District's Land Use Coordinator prior to any crossing of the Corps easement and/or prior to commencing construction of any structures, authorized dredging or other work within the right-of-way of, or in proximity to, a federally designated disposal area. The Land Use Coordinator may be contacted at: CESAW-OP-N, 69 Darlington Avenue, Wilmington, North Carolina 28403-1343, email: [SAWWeb-NAV@usace.army.mil](mailto:SAWWeb-NAV@usace.army.mil)

## **3.13 Northern Long-eared Bat – Endangered Species Act Compliance**

The Wilmington District, U.S. Army Corps of Engineers has consulted with the United States Fish and Wildlife Service (USFWS) in regards to the threatened Northern long-eared bat (NLEB) (*Myotis septentrionalis*) and Standard Local Operating Procedures for Endangered Species (SLOPES) have been approved by the Corps and the USFWS. This condition concerns effects to the NLEB only and does not address effects to other federally listed species and/or federally designated critical habitat.

A. Procedures when the Corps is the lead federal\* agency for a project:

The permittee must comply with (1) and (2) below when:

- the project is located in the western 41 counties of North Carolina, to include non-federal aid North Carolina Department of Transportation (NCDOT) projects, OR;
- the project is located in the 59 eastern counties of North Carolina, and is a non-NCDOT project.

\*Generally, if a project is located on private property or on non-federal land, and the project is not being funded by a federal entity, the Corps will be the lead federal agency due to the requirement to obtain Department of the Army authorization to impact waters of the United States. If the project is located on federal land, contact the Corps to determine the lead federal agency.

(1) A permittee using a NWP must check to see if their project is located in the range of the NLEB by using the following website:

<http://www.fws.gov/midwest/endangered/mammals/nleb/pdf/WNSZone.pdf>. If the project is within the range of the NLEB, or if the project includes percussive activities (e.g., blasting, pile driving, etc.), the permittee is then required to check the appropriate website in the paragraph below to discover if their project:

- is located in a 12-digit Hydrologic Unit Code area (“red HUC” - shown as red areas on the map), AND/OR;
- involves percussive activities within 0.25 mile of a red HUC.

Red HUC maps - for the western 41 counties in NC (covered by the Asheville Ecological Services Field Office), check the project location against the electronic maps found at: [http://www.fws.gov/asheville/htmls/project\\_review/NLEB\\_in\\_WNC.html](http://www.fws.gov/asheville/htmls/project_review/NLEB_in_WNC.html). For the eastern 59 counties in NC (covered by the Raleigh Ecological Services Field Office), check the project location against the electronic maps found at: [https://www.fws.gov/raleigh/NLEB\\_RFO.html](https://www.fws.gov/raleigh/NLEB_RFO.html).

(2) A permittee must submit a PCN to the District Engineer, and receive written authorization from the District Engineer, prior to commencing the activity, if the activity will involve any of the following:

- tree clearing/removal, construction/installation of wind turbines in a red HUC, AND/OR;
- bridge removal or maintenance, unless the bridge has been inspected and there is no evidence of bat use, (applies anywhere in the range of the NLEB), AND/OR;
- percussive activities in a red HUC, or within 0.25 mile of a red HUC.

The permittee may proceed with the activity without submitting a PCN to either the Corps or the USFWS, provided the activity complies with all applicable NWP terms and general and regional conditions, if the permittee’s review under A.(1) and A.(2) above shows that the project is:

- located outside of a red HUC (and there are no percussive activities), and the activity will NOT include bridge removal or maintenance, unless the bridge has been inspected and there is no evidence of bat use, OR;
- located outside of a red HUC and there are percussive activities, but the percussive activities will not occur within 0.25-mile of a red HUC boundary, and the activity will NOT include bridge removal or maintenance, unless the bridge has been inspected and there is no evidence of bat use, OR;



- located in a red HUC, but the activity will NOT include: tree clearing/removal; construction/installation of wind turbines; bridge removal or maintenance, unless the bridge has been inspected and there is no evidence of bat use, and/or; any percussive activities.

### B. Procedures when the USACE is not the lead federal agency:

For projects where another federal agency is the lead federal agency - if that other federal agency has completed project-specific ESA Section 7(a)(2) consultation for the NLEB, and has (1) determined that the project would not cause prohibited incidental take of the NLEB, and (2) completed coordination/consultation that is required by the USFWS (per the directions on the respective USFWS office's website), that project may proceed without notification to either the USACE or the USFWS, provided all General and Regional Permit Conditions are met.

The NLEB SLOPES can be viewed on the USACE website at the following World Wide Web Page: <http://www.saw.usace.army.mil/Missions/Regulatory-Permit-Program/Agency-Coordination/ESA/>. Permittees who do not have internet access may contact the USACE at (910) 251- 4633.

### **3.14 Work on Eastern Band of Cherokee Indians Land**

All PCNs submitted for activities in waters of the United States on Eastern Band of Cherokee Indians (EBCI) trust land (i.e., Qualla Boundary and non-contiguous tracts of trust land), must comply with the requirements of the latest MOU between the Wilmington District and the Eastern Band of Cherokee Indians.

**4.0 Additional Regional Conditions for Specific Nationwide Permits**

**4.1 NWP #12 - Utility Line Activities**

**4.1.1** Pipeline/utility line construction through jurisdictional waters and wetlands will be accomplished utilizing directional drilling/boring methods to the maximum extent practicable.

**4.1.2** Temporary discharge of excavated or fill material into wetlands and waters of the United States will be for the absolute minimum period of time necessary to accomplish the work. Temporary discharges will be fully contained with appropriate erosion control or containment methods or otherwise such fills will consist of non-erodible materials.

**4.1.3** The work area authorized by this permit, including temporary and/or permanent fills, will be minimized to the greatest extent practicable. Justification for work corridors exceeding forty (40) feet in width is required and will be based on pipeline diameter and length, size of equipment required to construct the utility line, and other construction information deemed necessary to support the request. The permittee is required to provide this information to the Corps with the initial notification package.

**4.1.4** Excavated materials shall be returned to the excavated areas and any remaining materials shall be disposed of in uplands, unless the Corps authorizes disposal in waters of the United States.

**4.1.5** In areas where a sub-aqueous utility line is to cross a federally-maintained channel, (i.e., the Atlantic Intracoastal Waterway [AIWW]), the line will be buried at least six (6) feet below the allowable overdepth of the authorized channel, including all side slopes. For areas outside federally-maintained channels, sub-aqueous lines must be installed at a minimum depth of two (2) feet below the substrate when such lines might interfere with navigation.

**4.1.6** The minimum clearance\*(see NOTE in 4.1.7) for aerial communication lines, or any lines not transmitting electrical power, will be ten (10) feet above the clearance required for nearby stationary bridges as established by the U.S. Coast Guard. In the event the U.S. Coast Guard has not established a bridge clearance, minimum vertical clearances for power and aerial lines will not be less than required by Section 23, Rule 232, of the latest revision of the National Electrical Safety Code (ANSI C2). Clearances will not be less than shown in Table 232-1, Item 7, ANSI C2.

**4.1.7** The minimum clearance\* for an aerial line, transmitting electrical power, is based on the low point of the line under conditions that produce the greatest sag, taking into consideration temperature, load, wind, length or span and the type of supports. The minimum clearance for an aerial electrical power transmission line crossing navigable waters of the United States, where there is an established bridge clearance established by the U.S. Coast Guard, shall be governed by the system voltage, as indicated below:

Nominal System	Minimum Clearance
Voltage, kilovolt	Above Bridge Clearance (As Established by the U.S. Coast Guard)

115 and below	20 feet
138	22
161	24
230	26
350	30
500	35
700	42
750 to 765	45

NOTE: Minimum clearance is the distance measured between the lowest point of a stationary bridge, including any infrastructure attached to underside of the bridge, and the Mean High Water (MHW) of the navigable waters of the United States beneath the bridge.

**4.1.8** On navigable waters of the United States, including all federal navigation projects, where there is no bridge for reference for minimum clearance, the proposed project will need to be reviewed by the Corps in order to determine the minimum clearance between the line and MHW necessary to protect navigational interests.

**4.1.9** A plan to restore and re-vegetate wetland areas cleared for construction must be submitted with the required PCN. Cleared wetland areas shall be re-vegetated to the maximum extent practicable with native species of canopy, shrub, and herbaceous species. Fescue grass shall not be used.

**4.1.10** Any permanently maintained corridor along the utility right of way within forested wetlands shall be considered a permanent impact. A compensatory mitigation plan will be required for all such impacts associated with the requested activity if the activity requires PCN and the cumulative total of permanent forested wetland impacts exceeds 1/10-acre, unless the District Engineer determines in writing that either some other form of mitigation would be more environmentally appropriate or the adverse effects of the proposed activity are minimal.

For permanent forested wetland impacts of 1/10-acre or less, the District Engineer may determine, on a case-by-case basis, that compensatory mitigation is required to ensure that the activity results in minimal adverse effects on the aquatic environment.

**4.1.11** Use of rip-rap or any other engineered structures to stabilize a stream bed should be avoided to the maximum extent practicable. If riprap stabilization is needed, it should be placed only on the stream banks, or, if it is necessary to be placed in the stream bed, the finished top elevation of the riprap should not exceed that of the original stream bed.

**4.1.12** When directional boring or horizontal directional drilling (HDD) under waters of the United States, including wetlands, permittees shall closely monitor the project for hydraulic fracturing or “fracking.” Any discharge from hydraulic fracturing or “fracking” into waters of the United States, including wetlands, shall be reported to the appropriate Corps Regulatory Field Office within 48 hours. Restoration and/or compensatory mitigation may be required as a result of any unintended discharges.

**4.1.13** For purposes of this NWP, the term utility line does not include pipes or culverts associated with driveways, roadways, lots, etc.

**4.1.14** The permittee shall submit a PCN to the District Engineer prior to commencing the activity if the activity will involve the discharge of dredged or fill material into more than 1/10-acre of wetlands or 150 linear feet of stream channel for the construction of temporary access fills and/or temporary road crossings. The PCN must include a restoration plan that thoroughly describes how all temporary fills will be removed, describes how pre-project conditions will be restored, and includes a timetable for all restoration activities.

STATE OF NORTH CAROLINA  
DEPARTMENT OF ENVIRONMENTAL QUALITY  
DIVISION OF WATER RESOURCES

**WATER QUALITY GENERAL CERTIFICATION NO. 4133**

**GENERAL CERTIFICATION FOR PROJECTS ELIGIBLE FOR US ARMY CORPS OF ENGINEERS**

- **NATIONWIDE PERMIT 12 (UTILITY LINE ACTIVITIES)**

Water Quality Certification Number 4133 is issued in conformity with the requirements of Section 401, Public Laws 92-500 and 95-217 of the United States and subject to the North Carolina Regulations in 15A NCAC 02H .0500 and 15A NCAC 02B .0200 for the discharge of fill material to surface waters and wetland areas as described in 33 CFR 330 Appendix A (B) (12) of the US Army Corps of Engineers regulations.

The State of North Carolina certifies that the specified category of activity will not violate applicable portions of Sections 301, 302, 303, 306 and 307 of the Public Laws 92-500 and 95-217 if conducted in accordance with the conditions hereinafter set forth.

Effective date: December 1, 2017

Signed this day: December 1, 2017

By

A handwritten signature in black ink, appearing to be 'Linda Culpepper', written over a horizontal line.

for Linda Culpepper  
Interim Director

## GC4133

**Activities meeting any one (1) of the following thresholds or circumstances require written approval for a 401 Water Quality Certification from the Division of Water Resources (DWR):**

- a) If any of the Conditions of this Certification (listed below) cannot be met; or
- b) Total permanent impacts to wetlands or open waters equal to or greater than one-tenth (1/10) acre within the entire utility project; or
- c) Any permanent impacts to streams; or
- d) Total temporary impacts to streams greater than 500 feet within the entire utility project; or
- e) Any stream relocation or stream restoration; or
- f) Any high-density utility line and associated facilities project, as defined in 15A NCAC 02H .1003(2)(a) and by the density thresholds specified in 15A NCAC 02H .1017, which:
  - i. Disturbs one acre or more of land (including a project that disturbs less than one acre of land that is part of a larger common plan of development or sale); and
  - ii. Has permanent wetland, stream or open water impacts; and
  - iii. Is proposing new built-upon area; and
  - iv. Does not have a stormwater management plan reviewed and approved under a state stormwater program<sup>1</sup> or a state-approved local government stormwater program<sup>2</sup>.

Projects that have vested rights, exemptions, or grandfathering from state or locally-implemented stormwater programs and projects that satisfy state or locally-implemented stormwater programs through use of community in-lieu programs **require written approval**; or

- g) Any permanent impacts to waters, or to wetlands adjacent to waters, designated as: ORW (including SAV), HQW (including PNA), SA, WS-I, WS-II, Trout, or North Carolina or National Wild and Scenic River; or
- h) Any permanent impacts to coastal wetlands [15A NCAC 07H .0205], or Unique Wetlands (UWL); or
- i) Any impact associated with a Notice of Violation or an enforcement action for violation(s) of NC Wetland Rules (15A NCAC 02H .0500), NC Isolated Wetland Rules (15A NCAC 02H .1300), NC Surface Water or Wetland Standards (15A NCAC 02B .0200), or State Regulated Riparian Buffer Rules (15A NCAC 02B .0200); or
- \* j) Any impacts to subject water bodies and/or state regulated riparian buffers along subject water bodies in the Neuse, Tar-Pamlico, or Catawba River Basins or in the Randleman Lake, Jordan Lake or Goose Creek Watersheds (or any other basin or watershed with State Regulated Riparian Area Protection Rules [Buffer Rules] in effect at the time of application) *unless*:
  - i. The activities are listed as "EXEMPT" from these rules; or
  - ii. A Buffer Authorization Certificate is issued by the NC Division of Coastal Management (DCM); or

---

<sup>1</sup> e.g. Coastal Counties, HQW, ORW, or state-implemented Phase II NPDES

<sup>2</sup> e.g. Delegated Phase II NPDES, Water Supply Watershed, Nutrient-Sensitive Waters, or Universal Stormwater Management Program

GC4133

- iii. A Buffer Authorization Certificate or a Minor Variance is issued by a delegated or designated local government implementing a state riparian buffer program pursuant to 143-215.23.

**Activities included in this General Certification that do not meet one of the thresholds listed above do not require written approval.**

**I. ACTIVITY SPECIFIC CONDITIONS:**

1. All sewer lines shall be designed, constructed and maintained in accordance with Title 15A NCAC Chapter 02T.
2. Any utility construction corridor that is parallel to a stream or open water shall not be closer than 10 feet to the top of bank or ordinary high-water mark. Exceptions to this condition require application to and written approval from DWR. [15A NCAC 02H .0506 (b)(4) and (c)(4)]
3. Where there are temporary or permanent impacts from stream crossings, utility lines shall cross the stream channel at a near-perpendicular direction (i.e., between 75 degrees and 105 degrees to the stream bank). Exceptions to this condition require application to and written approval from DWR. [15A NCAC 02H .0506 (b)(2) and (c)(2)]
4. Construction corridors in wetlands and across stream channels shall be minimized to the maximum extent practicable and shall not exceed 50 feet wide for gas utility lines and 40 feet wide for all other utility lines. Exceptions to this condition require application to and written approval from DWR. [15A NCAC 02H .0506 (b)(2) and (c)(2)]

For construction corridors in wetlands and across stream channels, stumps shall be grubbed only as needed to install the utility and remaining stumps shall be cut off at grade level. The general stripping of topsoil within wetlands along the construction corridor is not permitted.

5. Permanent maintained access corridors in wetlands and across stream channels shall be restricted to the minimum width practicable and shall not exceed 30 feet wide for gas utility lines and 20 feet wide for all other utility lines except at manhole locations. 15-foot by 15-foot perpendicular vehicle turnarounds shall be allowed in access corridors but must be spaced at least 500 feet apart. Exceptions to this condition require application to and written approval from DWR. [15A NCAC 02H .0506 (b)(2) and (c)(2)]
6. For all utility lines constructed within wetlands, an anti-seep collar shall be placed at the downstream (utility line gradient) wetland boundary and every 150 feet up the gradient until the utility exits the wetland. Anti-seep collars may be constructed with class B concrete, compacted clay, PVC pipe, or metal collars. Wetland crossings that are directionally drilled, and perpendicular wetland crossings that are open cut and less than 150 feet long do not require anti-seep collars. The compacted clay shall have a specific

GC4133

infiltration of  $1 \times 10^{-5}$  cm/sec or less. A section and plan view diagram is attached for the anti-seep collars. [15A NCAC 02H .0506 (b)(4) and (c)(4)]

The following specifications shall apply to class B concrete:

- a. Minimum cement content, sacks per cubic yard with rounded coarse aggregate 5.0
  - b. Minimum cement content, sacks per cubic yard with angular coarse aggregate 5.5
  - c. Maximum water-cement ratio gallons per sack 6.8
  - d. Slump range 2" to 4"
  - e. Minimum strength - 28-day psi 2,500
7. The applicant shall have a specific plan for restoring wetland contours. Any excess material will be removed to a high ground disposal area. [15A NCAC 02H .0506 (b)(2) and (c)(2)]

The mixing of topsoil and subsoils within the wetlands along utility corridors shall be minimized to the greatest extent practical. During excavation, the soils shall be placed on fabric to minimize impacts whenever possible. Topsoil excavated from utility trenches will be piled separately from subsoils and will be backfilled into the trench only after the subsoils have been placed and compacted.

- \*8. For the North Carolina Department of Transportation, compliance with the NCDOT's individual NPDES permit NCS000250 shall serve to satisfy this condition. All other high-density utility line and associated facilities projects that trigger threshold Item (f) above shall comply with one of the following requirements: [15A NCAC 02H .0506(b)(5) and (c)(5)]
- a. Provide a completed Stormwater Management Plan (SMP) for review and approval, including all appropriate stormwater control measure (SCM) supplemental forms and associated items, that complies with the high-density development requirements of 15A NCAC 02H .1003. Stormwater management shall be provided throughout the entire project area in accordance with 15A NCAC 02H .1003. For the purposes of 15A NCAC 02H .1003(2)(a), density thresholds shall be determined in accordance with 15A NCAC 02H .1017.
  - b. Provide documentation (including calculations, photos, etc.) that the project will not cause degradation of downstream surface waters. Documentation shall include a detailed analysis of the hydrological impacts from stormwater runoff when considering the volume and velocity of stormwater runoff from the project built upon area and the size and existing condition of the receiving stream(s).

Exceptions to this condition require application to and written approval from DWR.

**II. GENERAL CONDITIONS:**

1. When written authorization is required, the plans and specifications for the project are incorporated into the authorization by reference and are an enforceable part of the Certification. Any modifications to the project require notification to DWR and may require an application submittal to DWR with the appropriate fee. [15A NCAC 02H .0501 and .0502]



GC4133

2. No waste, spoil, solids, or fill of any kind shall occur in wetlands or waters beyond the footprint of the impacts (including temporary impacts) as authorized in the written approval from DWR; or beyond the thresholds established for use of this Certification without written authorization. [15A NCAC 02H .0501 and .0502]

No removal of vegetation or other impacts of any kind shall occur to state regulated riparian buffers beyond the footprint of impacts approved in a Buffer Authorization or Variance or as listed as an exempt activity in the applicable riparian buffer rules. [15A NCAC 02B .0200]

- \* 3. In accordance with 15A NCAC 02H .0506(h) and Session Law 2017-10, compensatory mitigation may be required for losses of greater than 300 linear feet of perennial streams and/or greater than one (1) acre of wetlands. Impacts associated with the removal of a dam shall not require mitigation when the removal complies with the requirements of Part 3 of Article 21 in Chapter 143 of the North Carolina General Statutes. Impacts to isolated and other non-404 jurisdictional wetlands shall not be combined with 404 jurisdictional wetlands for the purpose of determining when impact thresholds trigger a mitigation requirement. For linear publicly owned and maintained transportation projects that are not determined to be part of a larger common plan of development by the US Army Corps of Engineers, compensatory mitigation may be required for losses of greater than 300 linear feet per perennial stream.

Compensatory stream and/or wetland mitigation shall be proposed and completed in compliance with G.S. 143-214.11. For applicants proposing to conduct mitigation within a project site, a complete mitigation proposal developed in accordance with the most recent guidance issued by the US Army Corps of Engineers Wilmington District shall be submitted for review and approval with the application for impacts.

4. All activities shall be in compliance with any applicable State Regulated Riparian Buffer Rules in Chapter 2 of Title 15A.
5. When applicable, all construction activities shall be performed and maintained in full compliance with G.S. Chapter 113A Article 4 (Sediment and Pollution Control Act of 1973). Regardless of applicability of the Sediment and Pollution Control Act, all projects shall incorporate appropriate Best Management Practices for the control of sediment and erosion so that no violations of state water quality standards, statutes, or rules occur. [15A NCAC 02H .0506 (b)(3) and (c)(3) and 15A NCAC 02B .0200]

Design, installation, operation, and maintenance of all sediment and erosion control measures shall be equal to or exceed the requirements specified in the most recent version of the *North Carolina Sediment and Erosion Control Manual*, or for linear transportation projects, the *NCDOT Sediment and Erosion Control Manual*.

All devices shall be maintained on all construction sites, borrow sites, and waste pile (spoil) sites, including contractor-owned or leased borrow pits associated with the project. Sufficient materials required for stabilization and/or repair of erosion control measures and stormwater routing and treatment shall be on site at all times.

GC4133

For borrow pit sites, the erosion and sediment control measures shall be designed, installed, operated, and maintained in accordance with the most recent version of the *North Carolina Surface Mining Manual*. Reclamation measures and implementation shall comply with the reclamation in accordance with the requirements of the Sedimentation Pollution Control Act and the Mining Act of 1971.

If the project occurs in waters or watersheds classified as Primary Nursery Areas (PNAs), SA, WS-I, WS-II, High Quality Waters (HQW), or Outstanding Resource Waters (ORW), then the sedimentation and erosion control designs shall comply with the requirements set forth in 15A NCAC 04B .0124, *Design Standards in Sensitive Watersheds*.

6. Sediment and erosion control measures shall not be placed in wetlands or waters except within the footprint of temporary or permanent impacts authorized under this Certification. Exceptions to this condition require application to and written approval from DWR. [15A NCAC 02H .0501 and .0502]
7. Erosion control matting that incorporates plastic mesh and/or plastic twine shall not be used along streambanks or within wetlands. Exceptions to this condition require application to and written approval from DWR. [15A NCAC 02B .0201]
8. An NPDES Construction Stormwater Permit (NCG010000) is required for construction projects that disturb one (1) or more acres of land. The NCG010000 Permit allows stormwater to be discharged during land disturbing construction activities as stipulated in the conditions of the permit. If the project is covered by this permit, full compliance with permit conditions including the erosion & sedimentation control plan, inspections and maintenance, self-monitoring, record keeping and reporting requirements is required. [15A NCAC 02H .0506(b)(5) and (c)(5)]

The North Carolina Department of Transportation (NCDOT) shall be required to be in full compliance with the conditions related to construction activities within the most recent version of their individual NPDES (NCS000250) stormwater permit. [15A NCAC 02H .0506(b)(5) and (c)(5)]

9. All work in or adjacent to streams shall be conducted so that the flowing stream does not come in contact with the disturbed area. Approved best management practices from the most current version of the *NC Sediment and Erosion Control Manual*, or the *NC DOT Construction and Maintenance Activities Manual*, such as sandbags, rock berms, cofferdams, and other diversion structures shall be used to minimize excavation in flowing water. Exceptions to this condition require application to and written approval from DWR. [15A NCAC 02H .0506(b)(3) and (c)(3)]
10. If activities must occur during periods of high biological activity (e.g. sea turtle nesting, fish spawning, or bird nesting), then biological monitoring may be required at the request of other state or federal agencies and coordinated with these activities. [15A NCAC 02H .0506 (b)(2) and 15A NCAC 04B .0125]

## GC4133

All moratoriums on construction activities established by the NC Wildlife Resources Commission (WRC), US Fish and Wildlife Service (USFWS), NC Division of Marine Fisheries (DMF), or National Marine Fisheries Service (NMFS) shall be implemented. Exceptions to this condition require written approval by the resource agency responsible for the given moratorium. A copy of the approval from the resource agency shall be forwarded to DWR.

Work within a designated trout watershed of North Carolina (as identified by the Wilmington District of the US Army Corps of Engineers), or identified state or federal endangered or threatened species habitat, shall be coordinated with the appropriate WRC, USFWS, NMFS, and/or DMF personnel.

11. Culverts shall be designed and installed in such a manner that the original stream profiles are not altered and allow for aquatic life movement during low flows. The dimension, pattern, and profile of the stream above and below a pipe or culvert shall not be modified by widening the stream channel or by reducing the depth of the stream in connection with the construction activity. The width, height, and gradient of a proposed culvert shall be such as to pass the average historical low flow and spring flow without adversely altering flow velocity. [15A NCAC 02H .0506(b)(2) and (c)(2)]

Placement of culverts and other structures in streams shall be below the elevation of the streambed by one foot for all culverts with a diameter greater than 48 inches, and 20% of the culvert diameter for culverts having a diameter less than or equal to 48 inches, to allow low flow passage of water and aquatic life.

If multiple pipes or barrels are required, they shall be designed to mimic the existing stream cross section as closely as possible including pipes or barrels at flood plain elevation and/or sills where appropriate. Widening the stream channel shall be avoided.

When topographic constraints indicate culvert slopes of greater than 5%, culvert burial is not required, provided that all alternative options for flattening the slope have been investigated and aquatic life movement/connectivity has been provided when possible (e.g. rock ladders, cross vanes, etc.). Notification, including supporting documentation to include a location map of the culvert, culvert profile drawings, and slope calculations, shall be provided to DWR 60 calendar days prior to the installation of the culvert.

When bedrock is present in culvert locations, culvert burial is not required provided that there is sufficient documentation of the presence of bedrock. Notification, including supporting documentation such as a location map of the culvert, geotechnical reports, photographs, etc. shall be provided to DWR a minimum of 60 calendar days prior to the installation of the culvert. If bedrock is discovered during construction, then DWR shall be notified by phone or email within 24 hours of discovery.

If other site-specific topographic constraints preclude the ability to bury the culverts as described above and/or it can be demonstrated that burying the culvert would result in destabilization of the channel, then exceptions to this condition require application to and written approval from DWR.

GC4133

Installation of culverts in wetlands shall ensure continuity of water movement and be designed to adequately accommodate high water or flood conditions. When roadways, causeways, or other fill projects are constructed across FEMA-designated floodways or wetlands, openings such as culverts or bridges shall be provided to maintain the natural hydrology of the system as well as prevent constriction of the floodway that may result in destabilization of streams or wetlands.

The establishment of native woody vegetation and other soft stream bank stabilization techniques shall be used where practicable instead of rip-rap or other bank hardening methods.

12. Bridge deck drains shall not discharge directly into the stream. Stormwater shall be directed across the bridge and pre-treated through site-appropriate means to the maximum extent practicable (e.g. grassed swales, pre-formed scour holes, vegetated buffers, etc.) before entering the stream. Exceptions to this condition require application to and written approval from DWR. [15A NCAC 02H .0506(b)(5)]
13. Application of fertilizer to establish planted/seeded vegetation within disturbed riparian areas and/or wetlands shall be conducted at agronomic rates and shall comply with all other Federal, State and Local regulations. Fertilizer application shall be accomplished in a manner that minimizes the risk of contact between the fertilizer and surface waters. [15A NCAC 02B .0200 and 15A NCAC 02B .0231]
14. If concrete is used during construction, then all necessary measures shall be taken to prevent direct contact between uncured or curing concrete and waters of the state. Water that inadvertently contacts uncured concrete shall not be discharged to waters of the state. [15A NCAC 02B .0200]
15. All proposed and approved temporary fill and culverts shall be removed and the impacted area shall be returned to natural conditions within 60 calendar days after the temporary impact is no longer necessary. The impacted areas shall be restored to original grade, including each stream's original cross sectional dimensions, planform pattern, and longitudinal bed profile. For projects that receive written approval, no temporary impacts are allowed beyond those included in the application and authorization. All temporarily impacted sites shall be restored and stabilized with native vegetation. [15A NCAC 02H .0506(b)(2) and (c)(2)]
16. All proposed and approved temporary pipes/culverts/rip-rap pads etc. in streams shall be installed as outlined in the most recent edition of the *North Carolina Sediment and Erosion Control Planning and Design Manual* or the *North Carolina Surface Mining Manual* or the *North Carolina Department of Transportation Best Management Practices for Construction and Maintenance Activities* so as not to restrict stream flow or cause dis-equilibrium during use of this Certification. [15A NCAC 02H .0506(b)(2) and (c)(2)]

**GC4133**

17. Any rip-rap required for proper culvert placement, stream stabilization, or restoration of temporarily disturbed areas shall be restricted to the area directly impacted by the approved construction activity. All rip-rap shall be placed such that the original stream elevation and streambank contours are restored and maintained. Placement of rip-rap or other approved materials shall not result in de-stabilization of the stream bed or banks upstream or downstream of the area or in a manner that precludes aquatic life passage. [15A NCAC 02H .0506(b)(2)]
18. Any rip-rap used for stream or shoreline stabilization shall be of a size and density to prevent movement by wave, current action, or stream flows and shall consist of clean rock or masonry material free of debris or toxic pollutants. Rip-rap shall not be installed in the streambed except in specific areas required for velocity control and to ensure structural integrity of bank stabilization measures. [15A NCAC 02H .0506(b)(2)]
19. Applications for rip-rap groins proposed in accordance with 15A NCAC 07H .1401 (NC Division of Coastal Management General Permit for construction of Wooden and Rip-rap Groins in Estuarine and Public Trust Waters) shall meet all the specific conditions for design and construction specified in 15A NCAC 07H .1405.
20. All mechanized equipment operated near surface waters shall be inspected and maintained regularly to prevent contamination of stream waters from fuels, lubricants, hydraulic fluids, or other toxic materials. Construction shall be staged in order to minimize the exposure of equipment to surface waters to the maximum extent practicable. Fueling, lubrication and general equipment maintenance shall be performed in a manner to prevent, to the maximum extent practicable, contamination of surface waters by fuels and oils. [15A NCAC 02H .0506(b)(3) and (c)(3) and 15A NCAC 02B .0211 (12)]
21. Heavy equipment working in wetlands shall be placed on mats or other measures shall be taken to minimize soil disturbance. [15A NCAC 02H .0506(b)(3) and (c)(3)]
22. In accordance with 143-215.85(b), the applicant shall report any petroleum spill of 25 gallons or more; any spill regardless of amount that causes a sheen on surface waters; any petroleum spill regardless of amount occurring within 100 feet of surface waters; and any petroleum spill less than 25 gallons that cannot be cleaned up within 24 hours.
- \* 23. If an environmental document is required under the State Environmental Policy Act (SEPA), then this General Certification is not valid until a Finding of No Significant Impact (FONSI) or Record of Decision (ROD) is issued by the State Clearinghouse. If an environmental document is required under the National Environmental Policy Act (NEPA), then this General Certification is not valid until a Categorical Exclusion, the Final Environmental Assessment, or Final Environmental Impact Statement is published by the lead agency. [15A NCAC 01C .0107(a)]

GC4133

24. This General Certification does not relieve the applicant of the responsibility to obtain all other required Federal, State, or Local approvals before proceeding with the project, including those required by, but not limited to, Sediment and Erosion Control, Non-Discharge, Water Supply Watershed, and Trout Buffer regulations.
25. The applicant and their authorized agents shall conduct all activities in a manner consistent with State water quality standards (including any requirements resulting from compliance with §303(d) of the Clean Water Act), and any other appropriate requirements of State and Federal Law. If DWR determines that such standards or laws are not being met, including failure to sustain a designated or achieved use, or that State or Federal law is being violated, or that further conditions are necessary to assure compliance, then DWR may revoke or modify a written authorization associated with this General Water Quality Certification. [15A NCAC 02H .0507(d)]
26. The permittee shall require its contractors and/or agents to comply with the terms and conditions of this permit in the construction and maintenance of this project, and shall provide each of its contractors and/or agents associated with the construction or maintenance of this project with a copy of this Certification. A copy of this Certification, including all conditions shall be available at the project site during the construction and maintenance of this project. [15A NCAC 02H .0507 (c) and 15A NCAC 02H .0506 (b)(2) and (c)(2)]
- \* 27. When written authorization is required for use of this Certification, upon completion of all permitted impacts included within the approval and any subsequent modifications, the applicant shall be required to return a certificate of completion (available on the DWR website: <https://edocs.deq.nc.gov/Forms/Certificate-of-Completion>). [15A NCAC 02H .0502(f)]
28. Additional site-specific conditions, including monitoring and/or modeling requirements, may be added to the written approval letter for projects proposed under this Water Quality Certification in order to ensure compliance with all applicable water quality and effluent standards. [15A NCAC 02H .0507(c)]
29. If the property or project is sold or transferred, the new permittee shall be given a copy of this Certification (and written authorization if applicable) and is responsible for complying with all conditions. [15A NCAC 02H .0501 and .0502]

**III. GENERAL CERTIFICATION ADMINISTRATION:**

- \* 1. In accordance with North Carolina General Statute 143-215.3D(e), written approval for a 401 Water Quality General Certification must include the appropriate fee. An applicant for a CAMA permit under Article 7 of Chapter 113A of the General Statutes for which a Water Quality Certification is required shall only make one payment to satisfy both agencies; the fee shall be as established by the Secretary in accordance with 143-215.3D(e)(7).

## GC4133

2. This Certification neither grants nor affirms any property right, license, or privilege in any waters, or any right of use in any waters. This Certification does not authorize any person to interfere with the riparian rights, littoral rights, or water use rights of any other person and this Certification does not create any prescriptive right or any right of priority regarding any usage of water. This Certification shall not be interposed as a defense in any action respecting the determination of riparian or littoral rights or other rights to water use. No consumptive user is deemed by virtue of this Certification to possess any prescriptive or other right of priority with respect to any other consumptive user regardless of the quantity of the withdrawal or the date on which the withdrawal was initiated or expanded.
3. This Certification grants permission to the Director, an authorized representative of the Director, or DWR staff, upon the presentation of proper credentials, to enter the property during normal business hours. [15A NCAC 02H .0502(e)]
4. This General Certification shall expire on the same day as the expiration date of the corresponding Nationwide Permit and/or Regional General Permit. The conditions in effect on the date of issuance of Certification for a specific project shall remain in effect for the life of the project, regardless of the expiration date of this Certification. This General Certification is rescinded when the US Army Corps of Engineers reauthorizes any of the corresponding Nationwide Permits and/or Regional General Permits or when deemed appropriate by the Director of the Division of Water Resources.
5. Non-compliance with or violation of the conditions herein set forth by a specific project may result in revocation of this General Certification for the project and may also result in criminal and/or civil penalties.
- \* 6. The Director of the North Carolina Division of Water Resources may require submission of a formal application for Individual Certification for any project in this category of activity if it is deemed in the public's best interest or determined that the project is likely to have a significant adverse effect upon water quality, including state or federally listed endangered or threatened aquatic species, or degrade the waters so that existing uses of the water or downstream waters are precluded.

*History Note: Water Quality Certification (WQC) Number 4133 issued December 1, 2017 replaces WQC 4086 issued March 3, 2017; WQC 3884 issued March 19, 2012; WQC Number 3819 issued March 19, 2010; WQC Number 3699 issued November 1, 2007; WQC Number 3625 issued March 19, 2007; WQC Number 3374 issued March 18, 2002; WQC Number 3288 issued June 1, 2000; WQC Number 3101 issued February 11, 1997; WQC Number 3022 issued September 6, 1995, WQC Number 2664 issued January 21, 1992.*

**ANTI-SEEP COLLAR**

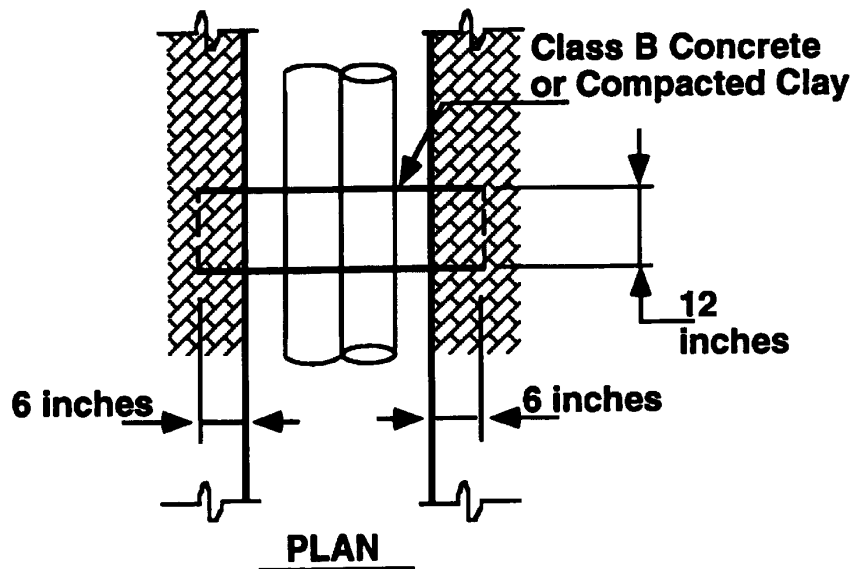
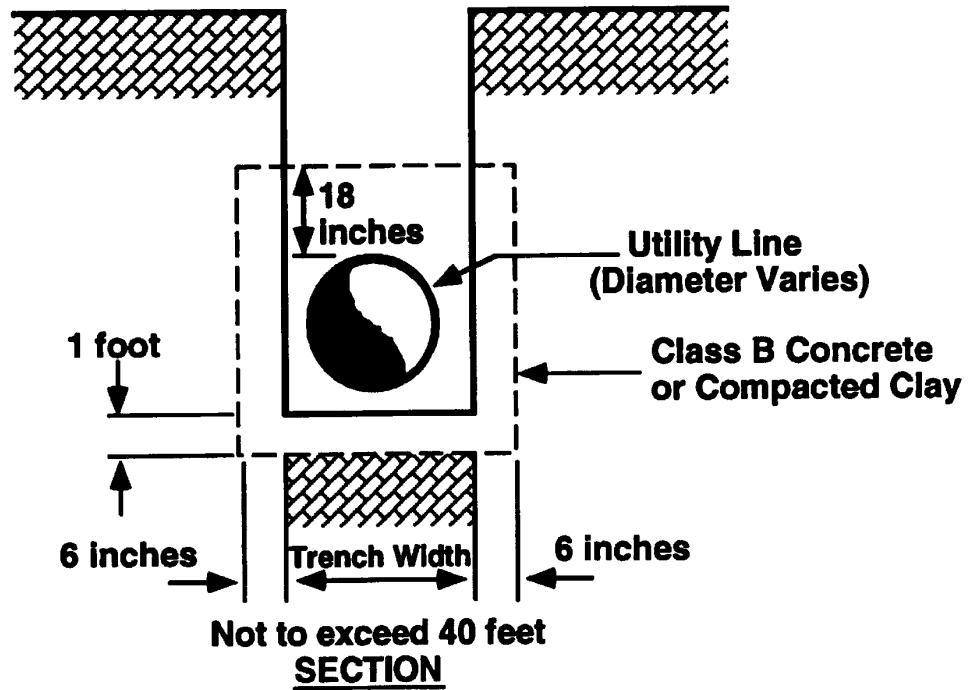





NORTH CAROLINA  
Environmental Quality

ROY COOPER  
Governor

MICHAEL S. REGAN  
Secretary

BRAXTON C. DAVIS  
Director

February 1, 2019

Phillip Harris III, P.E., C.P.M  
Environmental Analysis Unit  
NC Department of Transportation  
1598 Mail Service Center  
Raleigh, NC 27699-1598

RE: Refinement of CAMA Major Development Permit No. 149-10, Replacement of Bridge No. 19 on eastbound US 158 over the Pasquotank River in Pasquotank and Camden Counties, TIP No. U-4438.

Dear Mr. Harris:

This letter is in response to the request from the N.C. Department of Transportation (NCDOT) dated December 17, 2018, including a cover letter and four (4) drawings dated December 17, 2018. The request is for approval for utility work at the northwest corner of Veteran's Park in Elizabeth City adjacent to Bridge No. 19 over the Pasquotank River in Pasquotank County. NCDOT proposes to install a junction box at the base of an existing utility pole and replace a signal cabinet. The authorized activities would include temporary impacts due to trenching within the Coastal Shoreline Area of Environmental Concern (AEC). No impacts to wetlands or water of the State are proposed.

Please be advised that through this **Letter of Refinement**, the N.C. Division of Coastal Management (DCM) conveys its determination that the activities as described in your request dated December 17, 2018 are consistent with existing State rules and regulations and are in keeping with the original purpose and intent of CAMA Major Permit No. 149-10.

This Letter of Refinement shall be attached to the original of CAMA Major Permit No. 149-10, which was issued on December 22, 2010, as well as the Amendment issued on January 6, 2011, and all subsequent modifications and letters of refinement, and copies of all documents shall be readily available on site when a DCM representative inspects the project for compliance.

All conditions and stipulations of the active permit remain in force unless altered herein. This approval does not eliminate the need to obtain any additional permits, approvals or authorizations that may be required.



Letter of Refinement  
CAMA Major Permit No. 149-10  
U-4438, Pasquotank County  
February 1, 2019  
Page 2 of 2

Please contact Greg Daisey at (252) 264-3901 ext. 249 if you have any questions or concerns.

Sincerely,



Doug Huggett  
Manager, Major Permits Section

cc: Greg Daisey, NCDCM  
Cathy Brittingham, NCDCM  
Kyle Barnes, USACE  
Garcy Ward, DWR



CAMA /  DREDGE & FILL  
**GENERAL PERMIT**

New  Modification  Complete Reissue  Partial Reissue

**NO 78699**

Previous permit # 72606 (A) B C D  
Date previous permit issued 04/01/2014

As authorized by the State of North Carolina, Department of Environmental Quality and the Coastal Resources Commission in an area of environmental concern pursuant to 15A NCAC 07H .1600

Applicant Name NC DOT - EAU

Project Location: County PASQUOTANK

Address 1598 MAIL SERVICE CENTER

Street Address/ State Road/ Lot #(s) NC 344 (HALSTEAD

City RALEIGH State NC ZIP 27699

BYP. EXTENSION). NE SIDE OF PASQUOTANK BR. NO. 101

Phone # (919) 707-6000 E-Mail crivenbark@ncdot.gov

Subdivision -

Authorized Agent CHRIS RIVENBARK

City ELIZABETH CITY ZIP 27909

Affected  CW  EW  PTA  ES  PPTS

Phone # ( ) - River Basin PASQUOTANK

AEC(s):  OEA  HHF  IH  UBA  N/A

Adj. Wtr. Body UT TO KNOXES CREEK (nat) /man /unkn)

PWS: \_\_\_\_\_

Closest Maj. Wtr. Body PASQUOTANK RIVER

ORW: yes /  no PNA yes /  no

Type of Project/ Activity INSTALLATION OF UNDERGROUND/SUBAQUEOUS DIRECTIONAL PILE (APPROX. 700') WITHIN THE EXISTING ROW FROM UPLAND TO UPLAND. ADJACENT TO PASQUOTANK BRIDGE NO. 101 (Scale: N/A )

- Pier (dock) length -
- Fixed Platform(s) -
- Floating Platform(s) -
- Finger pier(s) -
- Groin length -
- number -
- Bulkhead/ Riprap length -
- avg distance offshore -
- max distance offshore -
- Basin, channel -
- cubic yards -
- Boat ramp -
- Boathouse/ Boatlift -
- Beach Bulldozing -
- Other UNDERGROUND DIRECTIONAL PILE
- (ASSOCIATED UPLAND PILE PITS)
- Shoreline Length 4500
- SAV: not sure yes  no
- Moratorium: n/a yes  no
- Photos:  yes  no
- Waiver Attached: yes  no

<p><b>PLANS ATTACHED AND INCORPORATED INTO PERMIT</b></p> <p><b>* TWO (2) DATED 11/27/2019</b></p>	
--	--

A building permit may be required by: PASQUOTANK CO.  See note on back regarding River Basin rules.  
( Note Local Planning Jurisdiction)

Notes/ Special Conditions ① SUBAQUEOUS LINES MUST BE PLACED AT A MINIMUM DEPTH OF 2' BELOW BOTTOM  
CONTOUR ② SOILS WHICH ARE PERMANENTLY REMOVED MUST BE PLACED ON A HIGH GROUND DISPOSAL SITE AND  
STABILIZED TO PREVENT RETURN TO WETLAND/WATERS ③ PER NCDOT, SPECIFIC AREA IS TECHNICALLY OUTSIDE TIP POINT AREA

for Philip S. Harris, III, PE, CPM

Agent or Applicant Printed Name Mack C. Rivenbark, III  
Signature Mack C. Rivenbark, III  
Application Fee(s) \$400.00  
Check # WBS# 45861.3.1

Digitally signed by Mack C. Rivenbark, III  
Date: 2020.09.10 06:52:16 -0400

Permit Officer's Printed Name GREG DAISE  
Signature Greg Daise  
Issuing Date 09/08/2020  
Expiration Date 09/08/2021

**Statement of Compliance and Consistency**

This permit is subject to compliance with this application, site drawing and attached general and specific conditions. Any violation of these terms may subject the permittee to a fine or criminal or civil action; and may cause the permit to become null and void.

This permit must be on the project site and accessible to the permit officer when the project is inspected for compliance. The applicant certifies by signing this permit that 1) prior to undertaking any activities authorized by this permit, the applicant will confer with appropriate local authorities to confirm that this project is consistent with the local land use plan and all local ordinances, and 2) a written statement or certified mail return receipt has been obtained from the adjacent riparian landowner(s).

The State of North Carolina and the Division of Coastal Management, in issuing this permit under the best available information and belief, certify that this project is consistent with the North Carolina Coastal Management Program.

**River Basin Rules Applicable To Your Project:**

Tar - Pamlico River Basin Buffer Rules

Other: \_\_\_\_\_

Neuse River Basin Buffer Rules

If indicated on front of permit, your project is subject to the Environmental Management Commission's Buffer Rules for the River Basin checked above due to its location within that River Basin. These buffer rules are enforced by the NC Division of Water Resources. Contact the Division of Water Resources at the Washington Regional Office (252-946-6481) or the Wilmington Regional Office (910-796-7215) for more information on how to comply with these buffer rules.

**Division of Coastal Management Offices**

**Morehead City Headquarters**

400 Commerce Ave  
Morehead City, NC 28557  
252-808-2808/ 1-888-4RCOAST  
Fax: 252-247-3330

(Serves: Carteret, Craven, Onslow -  
North of New River Inlet- and Pamlico  
Counties)

**Washington District**

943 Washington Square Mall  
Washington, NC 27889  
252-946-6481  
Fax: 252-948-0478

(Serves: Beaufort, Bertie, Hertford, Hyde,  
Tyrrell and Washington Counties)

**Elizabeth City District**

401 S. Griffin St.  
Ste. 300  
Elizabeth City, NC 27909  
252-264-3901  
Fax: 252-264-3723

(Serves: Camden, Chowan, Currituck,  
Dare, Gates, Pasquotank and Perquimans  
Counties)

**Wilmington District**

127 Cardinal Drive Ext.  
Wilmington, NC 28405-3845  
910-796-7215  
Fax: 910-395-3964

(Serves: Brunswick, New Hanover,  
Onslow - South of New River Inlet-  
and Pender Counties)

**SECTION .1600 - GENERAL PERMIT FOR THE INSTALLATION OF AERIAL AND SUBAQUEOUS UTILITY LINES WITH ATTENDANT STRUCTURES IN COASTAL WETLANDS: ESTUARINE WATERS: PUBLIC TRUST WATERS AND ESTUARINE SHORELINES**

**15A NCAC 07H .1601 PURPOSE**

A permit under this Section shall allow for the installation of utility lines both aerially and subaqueously in the coastal wetland, estuarine water, public trust areas and estuarine and public trust shoreline AECs according to the authority provided in Subchapter 7J .1100 and according rules in this Section. This general permit shall not apply to the ocean hazard AECs.

*History Note: Authority G.S. 113-229(c1); 113A-107(a)(b); 113A-113(b); 113A-118.1; Eff. March 1, 1985; Amended Eff. August 1, 2000; August 1, 1998.*

**15A NCAC 07H .1602 APPROVAL PROCEDURES**

(a) The applicant must contact the Division of Coastal Management and complete an application form requesting approval for development. The applicant shall provide information on site location, dimensions of the project area, and his name and address.

(b) The applicant must provide:

- (1) confirmation that a written statement has been obtained signed by the adjacent riparian property owners indicating that they have no objections to the proposed work; or
- (2) confirmation that the adjacent riparian property owners have been notified by certified mail of the proposed work. Such notice should instruct adjacent property owners to provide any comments on the proposed development in writing for consideration by permitting officials to the Division of Coastal Management within ten days of receipt of the notice, and, indicate that no response will be interpreted as no objection. DCM staff will review all comments and determine, based on their relevance to the potential impacts of the proposed project, if the proposed project can be approved by a General Permit. If DCM staff finds that the comments are worthy of more in-depth review, the applicant will be notified that he must submit an application for a major development permit.

(c) No work shall begin until an on-site meeting is held with the applicant and appropriate Division of Coastal Management representative so that the utility line alignment can be appropriately marked. Written authorization to proceed with the proposed development will be issued during this visit. Construction on the utility line must begin within twelve months of this visit or the general authorization expires.

*History Note: Authority G.S. 113A-107(a)(b); 113A-113(b); 113A-118.1; 113A-229(c1); Eff. March 1, 1985; Amended Eff. January 1, 1990.*

**15A NCAC 07H .1603 PERMIT FEE**

The applicant shall pay a permit fee of four hundred dollars (\$400.00) by check or money order payable to the Department.

*History Note: Authority G.S. 113-229(c1); 113A-107; 113A-113(b); 113A-118.1; 113A-119; 113A-119.1; Eff. March 1, 1985; Amended Eff. September 1, 2006; August 1, 2000; March 1, 1991.*

**15A NCAC 07H .1604 GENERAL CONDITIONS**

(a) Utility lines for the purpose of this general permit or any pipes or pipelines for the transportation of potable water, domestic sanitary sewage, natural gas, and any cable, line, or wire for the transmission, for any purpose, of electrical energy, telephone and telegraph messages, and radio and television communication.

(b) There must be no resultant change in preconstruction bottom contours. Authorized fill includes only that necessary to backfill or bed the utility line. Any excess material must be removed to an upland disposal area.

(c) The utility line crossing will not adversely affect a public water supply intake.

(d) The utility line route or construction method will not disrupt the movement of those species of aquatic life indigenous to the waterbody.

(e) Individuals shall allow authorized representatives of the Department of Environment, Health, and Natural Resources to make periodic inspections at any time necessary to ensure that the activity being performed under authority of this general permit is in accordance with the terms and conditions prescribed herein.

(f) This general permit will not be applicable to proposed construction where the Department has determined, based on an initial review of the application, that notice and review pursuant to G.S. 113A-119 is necessary because there are unresolved questions concerning the proposed activity's impact on adjoining properties or on water quality; air quality; coastal wetlands; cultural or historic sites; wildlife; fisheries resources; or public trust rights.

(g) This permit does not eliminate the need to obtain any other required state, local, or federal authorization, nor, to abide by regulations adopted by any federal or other state agency.

(h) Development carried out under this permit must be consistent with all local requirements, AEC guidelines, and local Land Use Plans current at the time of authorization.

*History Note: Authority G.S. 113-229(c1); 113A-107(a)(b); 113A-113(b); 113A-118.1;  
Eff. March 1, 1985;  
Amended Eff. May 1, 1990;  
RRC Objection due to ambiguity Eff. May 19, 1994;  
Amended Eff. August 1, 1998; July 1, 1994.*

#### **15A NCAC 07H .1605 SPECIFIC CONDITIONS**

Proposed utility line installations must meet each of the following specific conditions to be eligible for authorization by this general permit:

- (1) All domestic sanitary sewer line requests must be accompanied by a statement of prior approval from the NC Division Water Quality.
- (2) All spoils which are permanently removed must be placed on a high ground disposal site and stabilized so as not to return to waters, marsh or other wetlands.
- (3) Any additional backfill material required must be clean sand or rock free of organic matter.
- (4) Cuts through wetlands must be minimized.
- (5) Finished grades or subaqueous or wetland crossing must be returned to preproject contours.
- (6) There can be no work within any productive shellfish beds.
- (7) No excavation or filling activities will be permitted between April 1 and September 30 of any year within any designated primary nursery area.
- (8) Subaqueous lines must be placed at a depth of six feet below the project depth of federal projects. In other areas they will be installed at a minimum depth of two feet below the bottom contour.
- (9) The minimum clearance for aerial communication lines or any lines not transmitting electricity will be 10' above the clearance required for bridges in the vicinity.
- (10) The minimum clearance for aerial electrical transmission lines shall be consistent with those established by the US Army Corps of Engineers and US Coast Guard.
- (11) The installation of a utility line on pipe bents or otherwise above the elevation of mean high or mean ordinary water must be of sufficient height to allow for traditional navigation in the water body. Additionally the utility line must not interfere with the waterflow of normal or flood waters.
- (12) Natural gas lines must not exceed 11 inches in diameter.

*History Note: Authority G.S. 113-229(c1); 113A-107(a)(b); 113A-113(b); 113A-118.1;  
Eff. March 1, 1985;  
Amended Eff. August 1, 1998.*

Permit Class  
NEW

Permit Number  
149-10

STATE OF NORTH CAROLINA  
Department of Environment and Natural Resources  
and  
Coastal Resources Commission

# Permit

for

Major Development in an Area of Environmental Concern  
pursuant to NCGS 113A-118

Excavation and/or filling pursuant to NCGS 113-229

Issued to N.C. Department of Transportation, 1598 Mail Service Center, Raleigh, NC 27699-1598

Authorizing development in Pasquotank and Camden County at Pasquotank River, Bridge No. 19 on eastbound US 158 as requested in the permittee's application dated 10/20/10, including the attached workplan drawings (20) as referenced in Condition No. 1 of this permit.

This permit, issued on 12/22/10, is subject to compliance with the application (where consistent with the permit), all applicable regulations, special conditions and notes set forth below. Any violation of these terms may be subject to fines, imprisonment or civil action; or may cause the permit to be null and void.

**TIP No. U-4438**

- 1) All work authorized by this permit shall be carried out in accordance with the following attached workplan drawings(20), except as modified herein: 4 dated 10/19/10; 1 dated 10/14/10; 1 dated 10/15/10; and 14 dated as received 10/20/10.
- 2) In order to protect anadromous fisheries resources, no in-water work shall be conducted from February 15 to June 30 of any year without prior approval of the N.C. Division of Coastal Management (DCM), in consultation with the N.C. Wildlife Resources Commission (WRC) and the N.C. Division of Marine Fisheries (DMF).

**(See attached sheets for Additional Conditions)**

This permit action may be appealed by the permittee or other qualified persons within twenty (20) days of the issuing date. An appeal requires resolution prior to work initiation or continuance as the case may be.

This permit must be accessible on-site to Department personnel when the project is inspected for compliance.

Any maintenance work or project modification not covered hereunder requires further Division approval.

All work must cease when the permit expires on

**No expiration date, pursuant to GS 136-44.7B**

In issuing this permit, the State of North Carolina agrees that your project is consistent with the North Carolina Coastal Management Program.

Signed by the authority of the Secretary of DENR and the Chairman of the Coastal Resources Commission.



James H. Gregson, Director  
Division of Coastal Management

This permit and its conditions are hereby accepted.

\_\_\_\_\_  
Signature of Permittee

**ADDITIONAL CONDITIONS**

- 3) Unless specifically altered herein, any mitigative measures, environmental commitments, or protection measures relating to historical and cultural resource protection specifically made by the permittee in the Coastal Area Management Act (CAMA) permit application and/or the Finding of No Significant Impact (FONSI) document dated 1/28/10 shall be implemented, regardless of whether or not such commitments are addressed by individual conditions of this permit.

**NOTE:** This project will impact approximately 0.06 acres of CAMA Coastal Wetlands due to shading. This project will permanently impact approximately 0.02 acres of 404 wetlands and approximately 0.03 acres of surface waters due to excavation and/or filling. This project will temporarily impact approximately 0.10 acres of 404 wetlands and approximately 0.30 acres of surface waters.

- 4) Fill slopes in wetlands shall be 3:1 or steeper.
- 5) In accordance with commitments made by the permittee, all clearing within wetlands shall be accomplished by hand clearing only. Any other method of clearing within wetlands shall require additional approval from the Division. There shall be no clearing of wetlands outside of the areas indicated on the attached workplan drawings, without prior approval from the Division.
- 6) Construction mats shall be utilized to support equipment within hand cleared areas to minimize impacts. These mats shall be removed immediately following project completion.
- 7) The permittee shall minimize the need to cross wetlands in transporting equipment for hand clearing operations to the maximum extent practicable.
- 8) No excavation or filling shall take place at any time in any vegetated wetlands or surrounding waters outside of the alignment of the areas indicated on the attached workplan drawings, without permit modification.
- 9) Material excavated may be used in fill areas associated with the project once properly dewatered or shall be removed from the site and taken to a high ground location.
- 10) The temporary placement or double handling of excavated and/or fill materials within waters or vegetated wetlands is not authorized.
- 11) All excavated materials shall be confined above normal water level and landward of regularly or irregularly flooded wetlands behind adequate dikes or other retaining structures to prevent spillover of solids into any wetlands or surrounding waters.
- 12) All fill material shall be clean and free of any pollutants, except in trace quantities.
- 13) Placement of riprap shall be limited to the areas as depicted on the attached workplan drawings. The riprap material shall be free from loose dirt or any pollutant. The riprap material shall consist of clean rock or masonry materials such as but not limited to granite, marl or broken concrete.
- 14) Live concrete shall not be allowed to contact the water in or entering into the Pasquotank River, or the adjacent wetlands.



**ADDITIONAL CONDITIONS**

- 15) Construction staging areas shall be located only in upland areas, and not in wetlands or Waters of the State.
- 16) All materials and debris associated with the removal and/or construction of the existing and/or new bridge and associated structures and components, roadway asphalt, other existing structures within the Right-of-Way as authorized by this permit and associated materials shall not enter wetlands or Waters of the State, even temporarily. Any such material shall be disposed of at an approved upland site or shall be recycled in an environmentally appropriate manner provided appropriate authorizations from any relevant state, federal, or local authorities are obtained.
- 17) Pilings from the existing bridge, as well as any remnant pilings from previous bridges, shall be removed in their entirety. In the event that a piling breaks during removal and cannot be removed in its entirety, the piling may be cut off flush with the bed of the water body and DCM shall be notified of each occurrence within one working day.
- 18) Construction access for bridge demolition and construction shall be through the use of the existing bridge, temporary work bridges, and/or barges.
- 19) Dredging in any manner, including “kicking” with boat propellers is not authorized.
- 20) The temporary work bridges shall be removed in their entirety within 90 days after they are no longer needed. However, if this timeframe occurs while the moratorium referenced in Condition No. 2 of this permit is in effect, then the temporary work bridges shall be removed in their entirety within 30 days of the moratorium end date.
- 21) The installation of the bridge piles shall be accomplished by pile driving and/or the use of a vibratory hammer. Should the permittee and/or its contractor desire to utilize another type of pile installation, such as drilled shaft construction or jetting, additional authorization from DCM shall be required.
- 22) Bridge deck drains shall not be located over CAMA Coastal Wetlands. Bridge deck drains shall not cause erosion of adjacent wetlands.
- 23) The permittee shall follow DOT’s “Best Management Practices for Bridge Demolition and Removal” (9/20/99) to avoid any temporary fill in “Waters of the United States”.

**NOTE:** The bridge demolition debris may be suitable for use as artificial reef material. The permittee is encouraged to contact the Artificial Reef Coordinator at the DMF Morehead City Office at (252) 726-7021 to coordinate review of the suitability of the material and arrangements for such use.

**Bulkhead**

- 24) The authorized alignment of the bulkhead shall be staked by the permittee and approved on-site by a representative of DCM prior to the start of any construction.
- 25) The authorized alignment of the bulkhead shall adhere to the alignment depicted on the attached workplan drawings.

**ADDITIONAL CONDITIONS**

- 26) The bulkhead shall be in place and the filter fabric associated with backfill shall be in place prior to the placement of any backfill.
- 27) All backfill material shall be obtained from a high ground source. No unconfined backfill shall be discharged into estuarine or public trust waters. The fill material shall be clean and free of any pollutants except in trace quantities.
- 28) The bulkhead shall be structurally tight so as to prevent seepage of fill materials through the structure. The bulkhead shall be solid and constructed of treated wood, concrete slabs, metal or vinyl sheet piles or other suitable materials approved by the N.C. Division of Coastal Management.

**Sedimentation and Erosion Control**

- 29) The permittee shall follow "Best Management Practices for the Protection of Surface Waters".
- 30) This project shall conform to all requirements of the NC Sedimentation Pollution Control Act and NC DOT's Memorandum of Agreement with the Division of Land Resources.
- 31) In order to protect water quality, runoff from construction shall not visibly increase the amount of suspended sediments in adjacent waters.
- 32) Appropriate sedimentation and erosion control devices, measures or structures shall be implemented to ensure that eroded materials do not enter adjacent wetlands, watercourses and property (e.g. silt fence, diversion swales or berms, etc.).

**Stormwater Management**

**NOTE:** The N.C. Division of Water Quality (DWQ) confirmed in a letter dated 10/21/10 that the subject project is excluded from State Stormwater permitting requirements as set forth in Section 2(d)(1) of Session Law 2008-211, effective October 1, 2008, and the stormwater rules under Title 15A NCAC 2H .1000, as amended.

**Utility Impacts**

- 33) Any relocation of utility lines that is not specifically depicted on the attached workplan drawings, or specifically described within the attached permit application, shall require approval from DCM, either under the authority of this permit, or by obtaining separate authorization.

**NOTE:** CAMA General Permit 07H .1600 (No. 55251) was issued by DCM on 10/28/10 authorizing a portion of the utility work associated with this project.

- 34) All subaqueous utility lines shall be placed a minimum of 6' below the bottom contour.
- 35) The permittee shall obtain final approval from the N.C. Division of Environmental Health Public Water Supply Plan Review Section for the relocation and/or replacement of potable water supply lines prior to construction.

**ADDITIONAL CONDITIONS**

**NOTE:** Potable water supply lines may lie in or near the proposed project area. The permittee should contact the City of Elizabeth City for assistance in determining precise locations of existing utilities on the west side of the Pasquotank River and the permittee should contact the South Camden Water and Sewer District for utility locations on the east side of the River.

**General**

- 36) No attempt shall be made by the permittee to prevent the full and free use by the public of all navigable waters at or adjacent to the authorized work following completion of construction activities.
- 37) During bridge demolition and construction, the permittee shall make every attempt to allow the same navigation that is currently possible in the Pasquotank River through the bridge opening. If this is not possible, then adequate notice shall be provided to the public that navigation will be limited during construction. The notice shall include an estimate of the amount of time that the limited navigation will occur.
- 38) The permittee shall install and maintain at his expense any signal lights or signals prescribed by the U.S. Coast Guard, through regulation or otherwise, on the authorized facilities including temporary workbridges.
- 39) The permittee shall exercise all available precautions in the day-to-day operation of the facility to prevent waste from entering the adjacent wetlands and Waters of the State.
- 40) If it is determined that additional permanent and/or temporary impacts are necessary that are not shown on the attached workplan drawings or described in the authorized permit application, a permit modification and/or additional authorization from DCM shall be required. In addition, any changes in the approved plan may also require a permit modification and/or additional authorization from DCM. The permittee shall contact a representative of DCM prior to commencement of any such activity for this determination and any permit modification.
- 41) Development authorized by this permit shall only be conducted within NCDOT Right-of-Ways and/or easements.
- 42) The N.C. Division of Water Quality has authorized the proposed project under General Water Quality Certifications No. 3687 and 3819 (DWQ Project No. 20100874 v.1), which were issued on 11/4/10. Any violation of the Certifications approved by DWQ shall be considered a violation of this CAMA permit.

**NOTE:** The permittee and/or his contractor is strongly encouraged to contact the DCM Transportation Project Coordinator in Morehead City to request a pre-construction conference prior to project initiation.

**NOTE:** The U.S. Army Corps of Engineers authorized the proposed project under Nationwide Permit Number 3 and Nationwide Permit Number 12 (COE Action ID No. 2008-00944), which were issued on 10/21/10.

**ADDITIONAL CONDITIONS**

**NOTE:**

This permit does not eliminate the need to obtain any additional state, federal or local permits, approvals or authorizations that may be required.

Permit Class  
**AMENDED**

Permit Number  
**149-10**

STATE OF NORTH CAROLINA  
Department of Environment and Natural Resources  
and  
Coastal Resources Commission

**Permit**

for

Major Development in an Area of Environmental Concern  
pursuant to NCGS 113A-118

Excavation and/or filling pursuant to NCGS 113-229

Issued to N.C. Department of Transportation, 1598 Mail Service Center, Raleigh, NC 27699-1598

Authorizing development in Pasquotank and Camden County at Pasquotank River, Bridge No. 19 on eastbound US 158 as requested in the permittee's application dated 10/20/10, including the attached workplan drawings (21) as referenced in Condition No. 1 of this permit.

This permit, issued on 1/6/11, is subject to compliance with the application (where consistent with the permit), all applicable regulations, special conditions and notes set forth below. Any violation of these terms may be subject to fines, imprisonment or civil action; or may cause the permit to be null and void.

**TIP No. U-4438**

- 1) All work authorized by this permit shall be carried out in accordance with the following attached workplan drawings(21), except as modified herein: 4 dated 10/19/10; 1 dated 10/14/10; 1 dated 10/15/10; 14 dated as received 10/20/10; and 1 dated 1/6/11.
- 2) In order to protect anadromous fisheries resources, no in-water work shall be conducted from February 15 to June 15 of any year without prior approval of the N.C. Division of Coastal Management (DCM), in consultation with the N.C. Wildlife Resources Commission (WRC) and the N.C. Division of Marine Fisheries (DMF).

**(See attached sheets for Additional Conditions)**

This permit action may be appealed by the permittee or other qualified persons within twenty (20) days of the issuing date. An appeal requires resolution prior to work initiation or continuance as the case may be.

This permit must be accessible on-site to Department personnel when the project is inspected for compliance.

Any maintenance work or project modification not covered hereunder requires further Division approval.

All work must cease when the permit expires on

**No expiration date, pursuant to GS 136-44.7B**

In issuing this permit, the State of North Carolina agrees that your project is consistent with the North Carolina Coastal Management Program.

Signed by the authority of the Secretary of DENR and the Chairman of the Coastal Resources Commission.

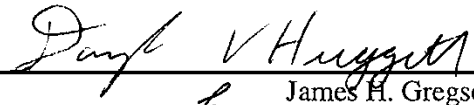
  
James H. Gregson, Director  
Division of Coastal Management

This permit and its conditions are hereby accepted.

\_\_\_\_\_  
Signature of Permittee

**ADDITIONAL CONDITIONS**

- 3) Unless specifically altered herein, any mitigative measures, environmental commitments, or protection measures relating to historical and cultural resource protection specifically made by the permittee in the Coastal Area Management Act (CAMA) permit application and/or the Finding of No Significant Impact (FONSI) document dated 1/28/10 shall be implemented, regardless of whether or not such commitments are addressed by individual conditions of this permit.

**NOTE:** This project will impact approximately 0.06 acres of CAMA Coastal Wetlands due to shading. This project will permanently impact approximately 0.02 acres of 404 wetlands and approximately 0.03 acres of surface waters due to excavation and/or filling. This project will temporarily impact approximately 0.10 acres of 404 wetlands and approximately 0.30 acres of surface waters.

- 4) Fill slopes in wetlands shall be 3:1 or steeper.
- 5) In accordance with commitments made by the permittee, all clearing within wetlands shall be accomplished by hand clearing only. Any other method of clearing within wetlands shall require additional approval from the Division. There shall be no clearing of wetlands outside of the areas indicated on the attached workplan drawings, without prior approval from the Division.
- 6) Construction mats shall be utilized to support equipment within hand cleared areas to minimize impacts. These mats shall be removed immediately following project completion.
- 7) The permittee shall minimize the need to cross wetlands in transporting equipment for hand clearing operations to the maximum extent practicable.
- 8) No excavation or filling shall take place at any time in any vegetated wetlands or surrounding waters outside of the alignment of the areas indicated on the attached workplan drawings, without permit modification.
- 9) Material excavated may be used in fill areas associated with the project once properly dewatered or shall be removed from the site and taken to a high ground location.
- 10) The temporary placement or double handling of excavated and/or fill materials within waters or vegetated wetlands is not authorized.
- 11) All excavated materials shall be confined above normal water level and landward of regularly or irregularly flooded wetlands behind adequate dikes or other retaining structures to prevent spillover of solids into any wetlands or surrounding waters.
- 12) All fill material shall be clean and free of any pollutants, except in trace quantities.
- 13) Placement of riprap shall be limited to the areas as depicted on the attached workplan drawings. The riprap material shall be free from loose dirt or any pollutant. The riprap material shall consist of clean rock or masonry materials such as but not limited to granite, marl or broken concrete.
- 14) Live concrete shall not be allowed to contact the water in or entering into the Pasquotank River, or the adjacent wetlands.

**ADDITIONAL CONDITIONS**

- 15) Construction staging areas shall be located only in upland areas, and not in wetlands or Waters of the State.
- 16) All materials and debris associated with the removal and/or construction of the existing and/or new bridge and associated structures and components, roadway asphalt, other existing structures within the Right-of-Way as authorized by this permit and associated materials shall not enter wetlands or Waters of the State, even temporarily. Any such material shall be disposed of at an approved upland site or shall be recycled in an environmentally appropriate manner provided appropriate authorizations from any relevant state, federal, or local authorities are obtained.
- 17) Pilings from the existing bridge, as well as any remnant pilings from previous bridges, shall be removed in their entirety. In the event that a piling breaks during removal and cannot be removed in its entirety, the piling may be cut off flush with the bed of the water body and DCM shall be notified of each occurrence within one working day.
- 18) Construction access for bridge demolition and construction shall be through the use of the existing bridge, temporary work bridges, and/or barges.
- 19) Dredging in any manner, including “kicking” with boat propellers is not authorized.
- 20) The temporary work bridges shall be removed in their entirety within 90 days after they are no longer needed. However, if this timeframe occurs while the moratorium referenced in Condition No. 2 of this permit is in effect, then the temporary work bridges shall be removed in their entirety within 30 days of the moratorium end date.
- 21) The installation of the bridge piles shall be accomplished by pile driving and/or the use of a vibratory hammer. Should the permittee and/or its contractor desire to utilize another type of pile installation, such as drilled shaft construction or jetting, additional authorization from DCM shall be required.
- 22) Bridge deck drains shall not be located over CAMA Coastal Wetlands. Bridge deck drains shall not cause erosion of adjacent wetlands.
- 23) The permittee shall follow DOT’s “Best Management Practices for Bridge Demolition and Removal” (9/20/99) to avoid any temporary fill in “Waters of the United States”.

**NOTE:** The bridge demolition debris may be suitable for use as artificial reef material. The permittee is encouraged to contact the Artificial Reef Coordinator at the DMF Morehead City Office at (252) 726-7021 to coordinate review of the suitability of the material and arrangements for such use.

**Bulkhead**

- 24) The authorized alignment of the bulkhead shall be staked by the permittee and approved on-site by a representative of DCM prior to the start of any construction.
- 25) The authorized alignment of the bulkhead shall adhere to the alignment depicted on the attached workplan drawings.

**ADDITIONAL CONDITIONS**

- 26) The bulkhead shall be in place and the filter fabric associated with backfill shall be in place prior to the placement of any backfill.
- 27) All backfill material shall be obtained from a high ground source. No unconfined backfill shall be discharged into estuarine or public trust waters. The fill material shall be clean and free of any pollutants except in trace quantities.
- 28) The bulkhead shall be structurally tight so as to prevent seepage of fill materials through the structure. The bulkhead shall be solid and constructed of treated wood, concrete slabs, metal or vinyl sheet piles or other suitable materials approved by the N.C. Division of Coastal Management.

**Sedimentation and Erosion Control**

- 29) Turbidity curtains and silt fences shall be used to isolate all work areas from the Pasquotank River, including but not limited to installation of the submarine cable for the bridge powerline, pile installation and removal, placement of riprap, and excavation and filling activities within or adjacent to surface waters. The turbidity curtains shall encircle the immediate work area, however, they shall not extend across the river or impede navigation. The turbidity curtains shall be of sufficient length and effectiveness to prevent a visible increase in the amount of suspended sediments in adjacent waters. The turbidity curtains shall be properly maintained and retained in the water until construction is complete. The turbidity curtains shall be removed when turbidity within the curtains reaches ambient levels.
- 30) The permittee shall follow "Best Management Practices for the Protection of Surface Waters".
- 31) This project shall conform to all requirements of the NC Sedimentation Pollution Control Act and NC DOT's Memorandum of Agreement with the Division of Land Resources.
- 32) In order to protect water quality, runoff from construction shall not visibly increase the amount of suspended sediments in adjacent waters.
- 33) Appropriate sedimentation and erosion control devices, measures or structures shall be implemented to ensure that eroded materials do not enter adjacent wetlands, watercourses and property (e.g. silt fence, diversion swales or berms, etc.).

**Stormwater Management**

**NOTE:** The N.C. Division of Water Quality (DWQ) confirmed in a letter dated 10/21/10 that the subject project is excluded from State Stormwater permitting requirements as set forth in Section 2(d)(1) of Session Law 2008-211, effective October 1, 2008, and the stormwater rules under Title 15A NCAC 2H .1000, as amended.

**Utility Impacts**

- 34) Any relocation of utility lines that is not specifically depicted on the attached workplan drawings, or specifically described within the attached permit application, shall require approval from DCM, either under the authority of this permit, or by obtaining separate authorization.



**ADDITIONAL CONDITIONS**

**NOTE:** CAMA General Permit 07H .1600 (No. 55251) was issued by DCM on 10/28/10 authorizing a portion of the utility work associated with this project.

- 35) All subaqueous utility lines shall be placed a minimum of 6' below the bottom contour.
- 36) The permittee shall obtain final approval from the N.C. Division of Environmental Health Public Water Supply Plan Review Section for the relocation and/or replacement of potable water supply lines prior to construction.

**NOTE:** Potable water supply lines may lie in or near the proposed project area. The permittee should contact the City of Elizabeth City for assistance in determining precise locations of existing utilities on the west side of the Pasquotank River and the permittee should contact the South Camden Water and Sewer District for utility locations on the east side of the River.

**General**

- 37) No attempt shall be made by the permittee to prevent the full and free use by the public of all navigable waters at or adjacent to the authorized work following completion of construction activities.
- 38) During bridge demolition and construction, the permittee shall make every attempt to allow the same navigation that is currently possible in the Pasquotank River through the bridge opening. If this is not possible, then adequate notice shall be provided to the public that navigation will be limited during construction. The notice shall include an estimate of the amount of time that the limited navigation will occur.
- 39) The permittee shall install and maintain at his expense any signal lights or signals prescribed by the U.S. Coast Guard, through regulation or otherwise, on the authorized facilities including temporary workbridges.
- 40) The permittee shall exercise all available precautions in the day-to-day operation of the facility to prevent waste from entering the adjacent wetlands and Waters of the State.
- 41) If it is determined that additional permanent and/or temporary impacts are necessary that are not shown on the attached workplan drawings or described in the authorized permit application, a permit modification and/or additional authorization from DCM shall be required. In addition, any changes in the approved plan may also require a permit modification and/or additional authorization from DCM. The permittee shall contact a representative of DCM prior to commencement of any such activity for this determination and any permit modification.
- 42) Development authorized by this permit shall only be conducted within NCDOT Right-of-Ways and/or easements.
- 43) The N.C. Division of Water Quality has authorized the proposed project under General Water Quality Certifications No. 3687 and 3819 (DWQ Project No. 20100874 v.1), which were issued on 11/4/10. Any violation of the Certifications approved by DWQ shall be considered a violation of this CAMA permit.

**ADDITIONAL CONDITIONS**

**NOTE:** The permittee and/or his contractor is strongly encouraged to contact the DCM Transportation Project Coordinator in Morehead City to request a pre-construction conference prior to project initiation.

**NOTE:** The U.S. Army Corps of Engineers authorized the proposed project under Nationwide Permit Number 3 and Nationwide Permit Number 12 (COE Action ID No. 2008-00944), which were issued on 10/21/10.

**NOTE:** This permit does not eliminate the need to obtain any additional state, federal or local permits, approvals or authorizations that may be required.

See Sheet ITS-1.01 For Index of Sheets

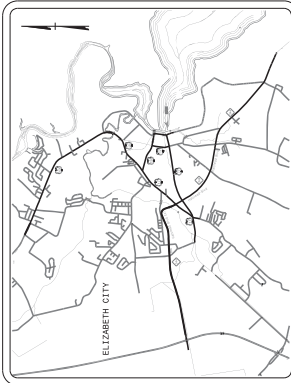

VICINITY MAP

NORTH CAROLINA  
DEPARTMENT OF TRANSPORTATION

---

PLANS FOR PROPOSED IMPROVEMENTS  
**ELIZABETH CITY**  
COMPUTERIZED TRAFFIC SIGNAL SYSTEM

REPLACEMENT OF VARIOUS STANDALONE CLOSED-LOOP TRAFFIC SIGNAL SYSTEMS WITH A NEW COMPUTERIZED TRAFFIC SIGNAL SYSTEM.  
RELATED WORK INCLUDES:  
UPGRADING LOCAL INTERSECTION TRAFFIC SIGNALS AND SYSTEM DETECTORS WITH LIMITED SIGNAL WIRING AND SIGNAL HEAD UPGRADES WHEN NECESSARY, UPGRADE AND EXPANSION OF CCTV MONITORING NETWORK, INSTALLING CENTRAL EQUIPMENT AND CENTRAL SOFTWARE AND INSTALLATION OF AN ETHERNET COMMUNICATIONS NETWORK COMPRISED OF FIBER-OPTIC CABLE WITH ALL RELATED EQUIPMENT.

Sheet 1 of 6



STATE	PROJECT NUMBER	DATE	SCALE
N.C.	U-5942	ITS-1.00	
45861.11	E.L. HALL	PE	
45861.XX	STGB-011125	CONST	

**CONTRACT:**

2008 STANDARD SPECIFICATION  
LETTING DATE: JANUARY 15, 2009  
PROJECT LENGTH - 20 MILES

Prepared for the Offices of:



750 N. Greenfield Pkwy., Garner, NC 27529

NC DOT CONTACTS:  
TRANSPORTATION DIVISION  
INTELLIGENT TRANSPORTATION SYSTEMS SECTION  
JASON GALLOWAY, P. E. - STATE SIGNALS ENGINEER  
NEIL AVERY - SIGNAL COMMUNICATION PROJECT ENGINEER

Plans Prepared By:  
**DRMP**  
8000 Main Street, Suite 175  
Charlotte, NC 28217 (919) 686-0088

LI MOON, P. E. - SENIOR PROJECT ENGINEER  
AJ DAVIS, P. E. - PROJECT DESIGN ENGINEER  
RO LAWTON, EIT - PROJECT ENGINEER  
DJ WHITE - PROJECT ENGINEER

INCOMPLETE PLANS  
DO NOT USE FOR CONSTRUCTION

DOCUMENT NOT CONSIDERED FINAL  
UNLESS ALL SIGNATURES COMPLETED



PROJECT REFERENCE NO. U-5842  
SHEET NO. Sheet 2 of 6

**SITE 1**

DATE: 11/27/18  
SCALE: AS SHOWN  
DRAWN BY: [Name]  
CHECKED BY: [Name]  
APPROVED BY: [Name]

Professional Engineer Seal: [Seal]

November 27, 2018

11/27/2018 11:15  
C:\Users\jgriest\OneDrive\Documents\Projects\18-0001\18-0001.dwg  
Sheet 2 of 6

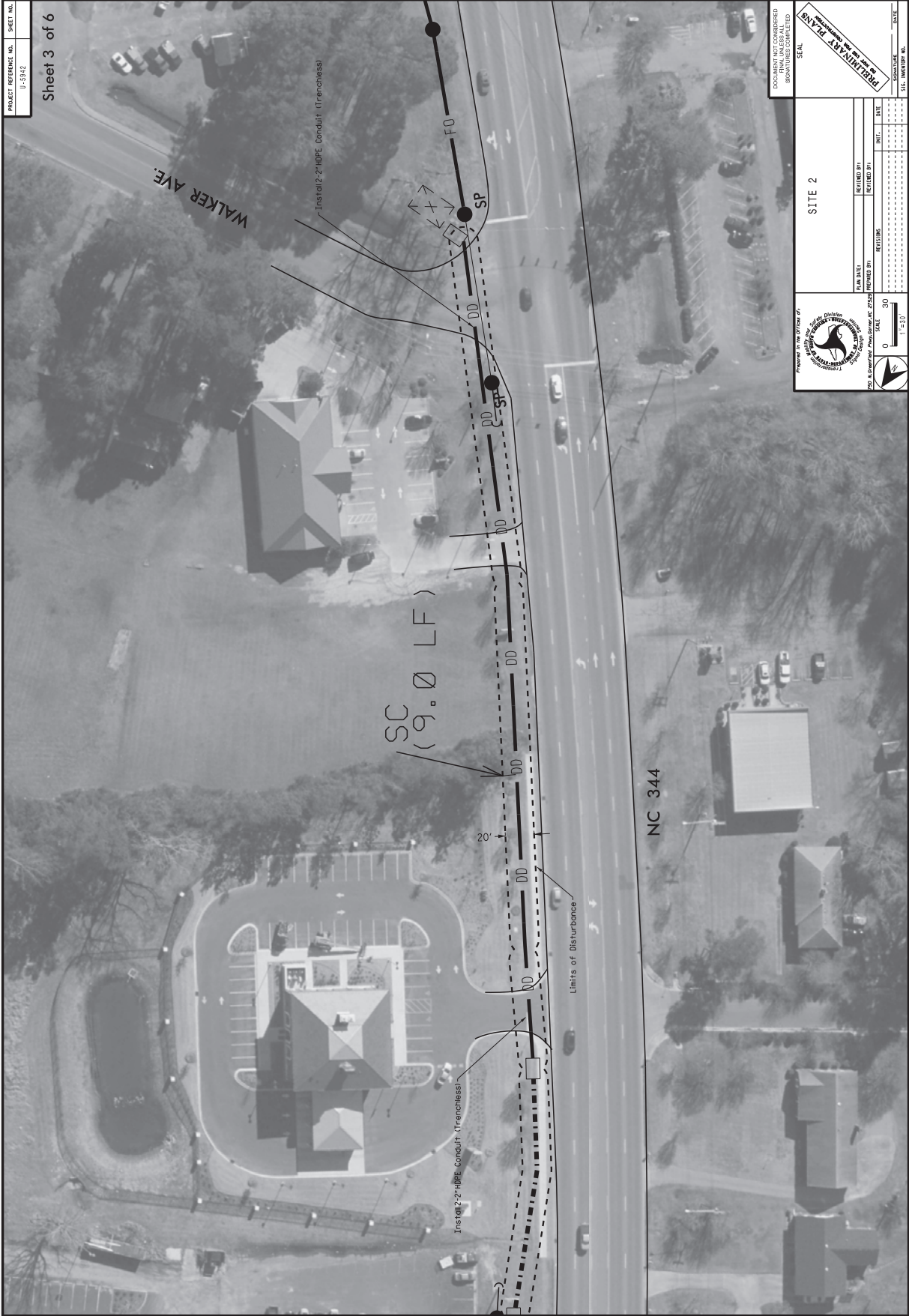

PROJECT REFERENCE NO. 11-5342  
SHEET NO. 3 of 6

STATE OF NORTH CAROLINA  
DIVISION OF PUBLIC WORKS  
REGISTERED PROFESSIONAL ENGINEER  
No. 22526  
200 S. Salisbury Street, Raleigh, NC 27601

SCALE: 1" = 50'

DATE: 11/27/18

PROJECT: SITE 2

DESIGNED BY: [ ]  
CHECKED BY: [ ]  
DATE: [ ]

SCALE: 0 30 60  
1" = 50'

DOCUMENT NOT CONSIDERED  
VALID UNLESS SIGNED AND  
SEALED



PROJECT REFERENCE NO. 4-5342 SHEET NO. 4 of 6

Sheet 4 of 6

DOCUMENT NOT CONSIDERED VALID UNLESS SIGNED AND SEALED BY A PROFESSIONAL ENGINEER

SCALE: 1" = 50'

DATE: \_\_\_\_\_

SCALE: 0 30 60

1" = 50'

Professional Engineer Seal

Professional Engineer License No. \_\_\_\_\_

Professional Engineer Name \_\_\_\_\_

Professional Engineer Title \_\_\_\_\_

Professional Engineer Firm Name \_\_\_\_\_

Professional Engineer Firm Address \_\_\_\_\_

Professional Engineer Firm Phone No. \_\_\_\_\_

Professional Engineer Firm Fax No. \_\_\_\_\_

Professional Engineer Firm Website \_\_\_\_\_

Professional Engineer Firm Email \_\_\_\_\_

Professional Engineer Firm State \_\_\_\_\_

Professional Engineer Firm Zip Code \_\_\_\_\_

Professional Engineer Firm City \_\_\_\_\_

Professional Engineer Firm Country \_\_\_\_\_

Professional Engineer Firm Post Office Box \_\_\_\_\_

Professional Engineer Firm Post Office City \_\_\_\_\_

Professional Engineer Firm Post Office State \_\_\_\_\_

Professional Engineer Firm Post Office Zip Code \_\_\_\_\_

Professional Engineer Firm Post Office Country \_\_\_\_\_

Professional Engineer Firm Post Office Post Office Box \_\_\_\_\_

Professional Engineer Firm Post Office Post Office City \_\_\_\_\_

Professional Engineer Firm Post Office Post Office State \_\_\_\_\_

Professional Engineer Firm Post Office Post Office Zip Code \_\_\_\_\_

Professional Engineer Firm Post Office Post Office Country \_\_\_\_\_

Professional Engineer Firm Post Office Post Office Post Office Box \_\_\_\_\_

Professional Engineer Firm Post Office Post Office Post Office City \_\_\_\_\_

Professional Engineer Firm Post Office Post Office Post Office State \_\_\_\_\_

Professional Engineer Firm Post Office Post Office Post Office Zip Code \_\_\_\_\_

Professional Engineer Firm Post Office Post Office Post Office Country \_\_\_\_\_

November 27, 2018



PROJECT REFERENCE NO. 11-5342 SHEET NO. Sheet 5 of 6

STATE OF NORTH CAROLINA  
 DEPARTMENT OF TRANSPORTATION  
 TRANSPORTATION TRAILWAYS DIVISION  
 PROJECT NO. 11-5342  
 SHEET NO. 5 OF 6

SCALE: 1" = 40'

DATE: 11/27/18

DESIGNED BY: [ ]  
 CHECKED BY: [ ]  
 IN CHARGE: [ ]  
 DATE: [ ]

APPROVED BY: [ ]  
 DATE: [ ]

DOCUMENT NOT CONSIDERED VALID UNLESS SIGNED AND SEALED BY A LICENSED PROFESSIONAL ENGINEER

November 27, 2018

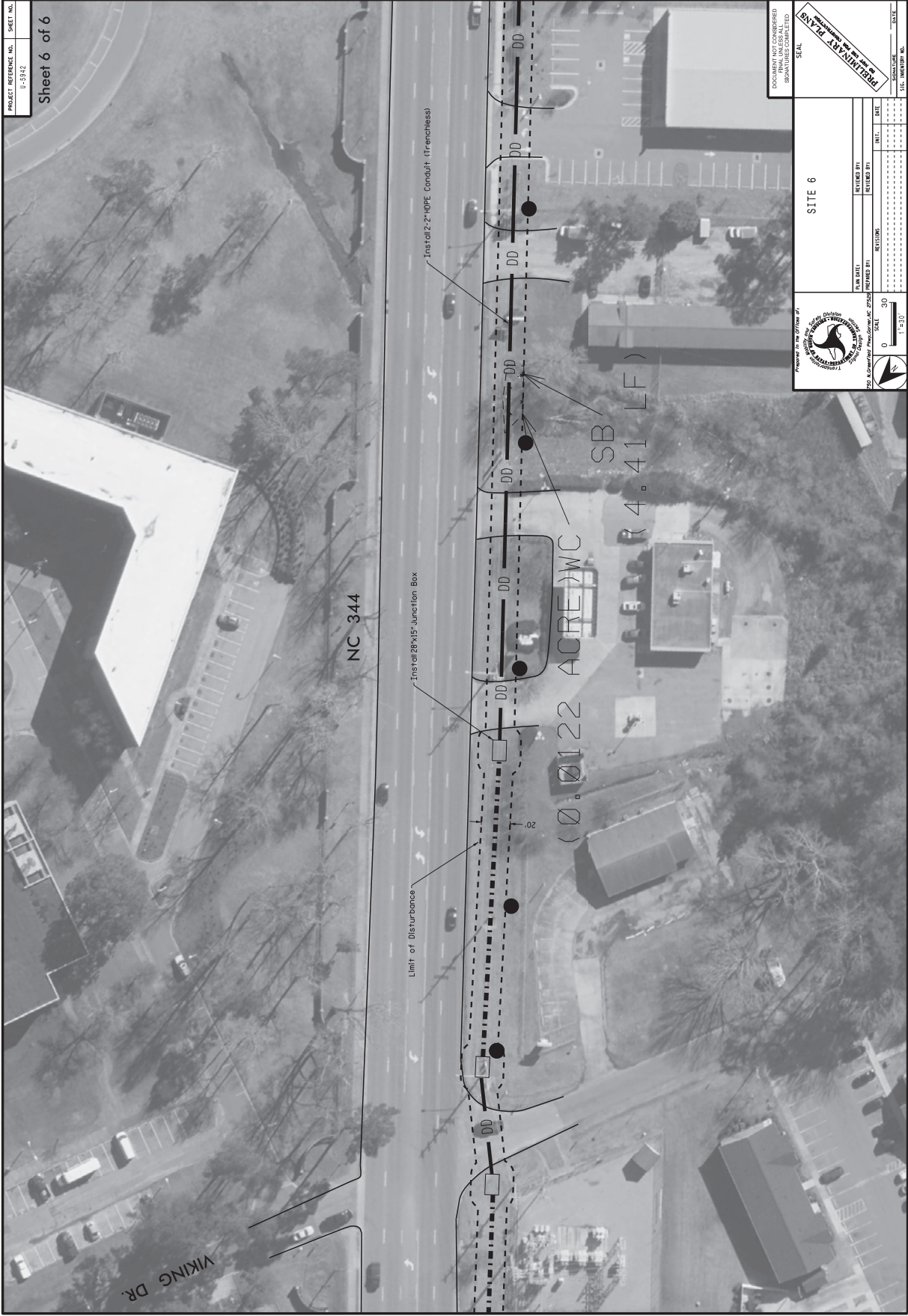

PROJECT REFERENCE NO. 14-5342  
 SHEET NO. Sheet 6 of 6

Prepared in the Office of  
  
 Thomas J. Williams  
 250 S. Campbell Street, Suite 27256  
 Raleigh, NC 27603  
 SCALE: 3/0  
 1" = 50'

DOCUMENT NOT CONSIDERED  
 VALID UNLESS SIGNED AND  
 SEALED BY THE ENGINEER

SITE 6

DESIGNED BY	REVIEWED BY
DRAWN BY	REVIEWED BY
REVISIONS	INITIALS
DATE	DATE
CALCULATED BY	
DATE	



See Sheet ITS-1.01 For Index of Sheets

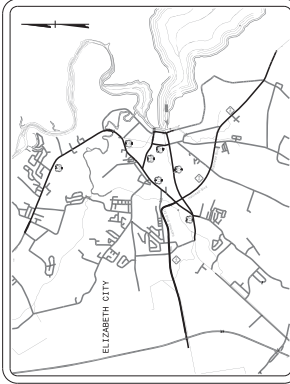

VICINITY MAP

NORTH CAROLINA  
DEPARTMENT OF TRANSPORTATION

PLANS FOR PROPOSED IMPROVEMENTS

**ELIZABETH CITY**  
COMPUTERIZED TRAFFIC SIGNAL SYSTEM

REPLACEMENT OF VARIOUS STANDALONE CLOSED-LOOP TRAFFIC SIGNAL SYSTEMS WITH A NEW COMPUTERIZED TRAFFIC SIGNAL SYSTEM.  
RELATED WORK INCLUDES:  
UPGRADING LOCAL INTERSECTION TRAFFIC SIGNALS AND SYSTEM DETECTORS WITH LIMITED SIGNAL WIRING AND SIGNAL HEAD UPGRADES WHEN NECESSARY, UPGRADE AND EXPANSION OF CCTV MONITORING NETWORK, INSTALLING CENTRAL EQUIPMENT AND CENTRAL SOFTWARE AND INSTALLATION OF AN ETHERNET COMMUNICATIONS NETWORK COMPRISED OF FIBER-OPTIC CABLE WITH ALL RELATED EQUIPMENT.

Utility Drawing  
Sheet 1 of 4



DATE	PROJECT REVISIONS TO	SHEET NO.	TOTAL SHEETS
N.C.	U-5942	ITS-1.00	
4/5/86 J.L.	4/5/86 J.L.	PE	
4/5/86 J.L.	4/5/86 J.L.	CONST	

CONTRACT:

2008 STANDARD SPECIFICATION  
LETTING DATE: JANUARY 15, 2009  
PROJECT LENGTH - 20 MILES

Prepared for the Offices of:



750 N. Greenfield Pkwy., Garner, NC 27529

NC DOT CONTACTS:  
TRANSPORTATION DIVISION  
INTELLIGENT TRANSPORTATION SYSTEMS SECTION  
JASON GALLOWAY, P. E. - STATE SIGNALS ENGINEER  
NEIL AVERY - SIGNAL COMMUNICATION PROJECT ENGINEER

Plans Prepared By:

**DRMP**

8000 Main St., Suite 175  
Charlotte, NC 28226  
Phone: 704.366.0008  
Fax: 704.366.0008

LI MOON, P. E. - SENIOR PROJECT ENGINEER  
AJ DAVIS, P. E. - PROJECT DESIGN ENGINEER  
RD LAWTON, EIT - PROJECT ENGINEER  
DJ WHITE - PROJECT ENGINEER

INCOMPLETE PLANS  
DO NOT USE FOR CONSTRUCTION

DOCUMENT NOT CONSIDERED FINAL  
UNLESS ALL REVISIONS COMPLETED

Utility Drawing  
Sheet 2 of 4

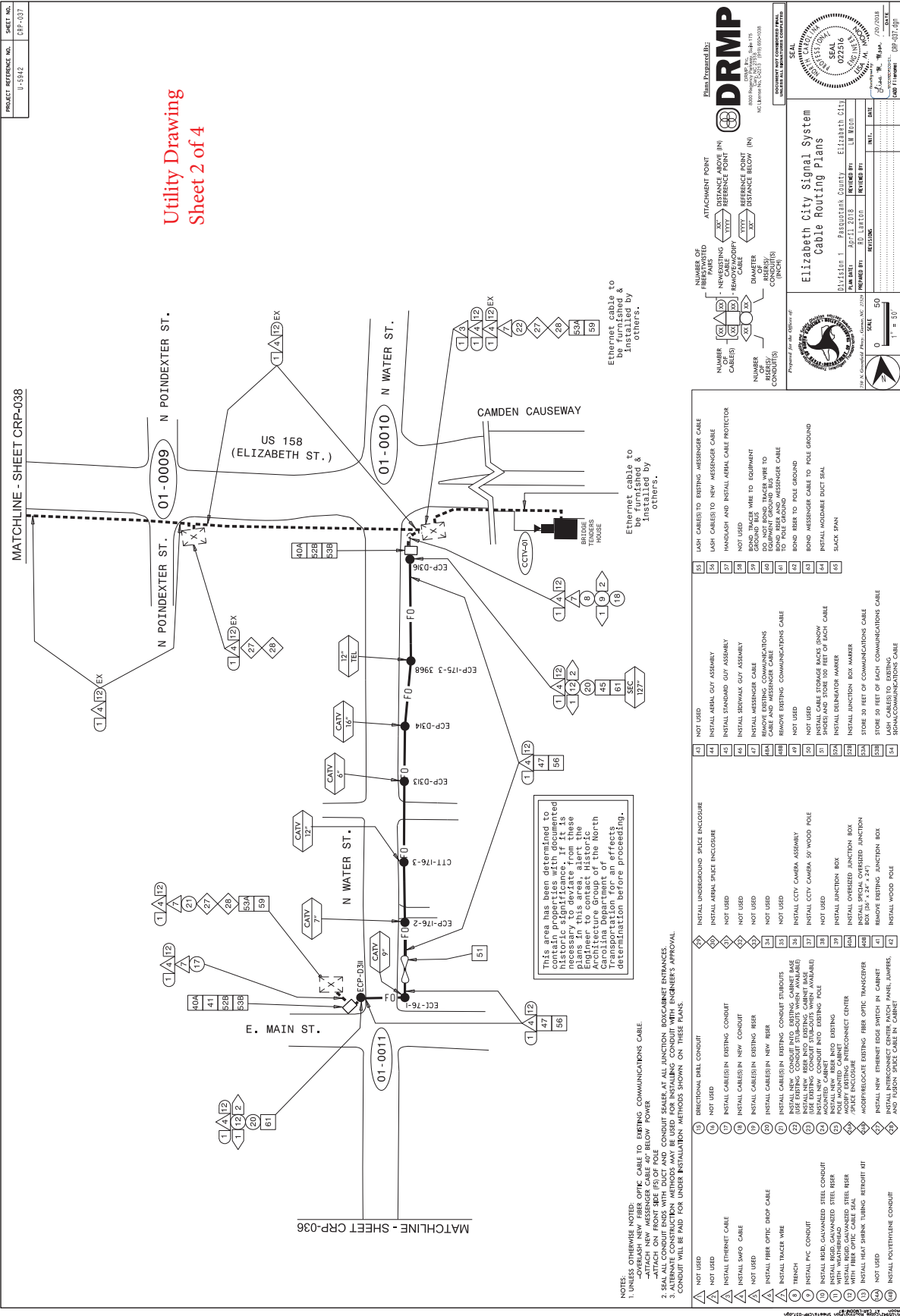

Ethernet cable to be furnished & installed by others.

Ethernet cable to be furnished & installed by others.

This area has been determined to contain properties with documented historic significance. It is recommended that the construction plans in this area, alert the Engineer to contact Historic Resources Commission of the North Carolina Department of Transportation for an effects determination before proceeding.

- NOTES:
1. UNLESS OTHERWISE NOTED:
    - OVERLASH NEW FIBER OPTIC CABLE TO EXISTING COMMUNICATIONS CABLE
    - ATTACH NEW MESSENGER CABLE 40" BELOW POWER
    - SEAL ALL CONDUIT ENDS WITH DUCT AND CONDUIT SEALER AT ALL JUNCTION BOX/CABINET ENTRANCES
    - ALTERNATE CONSTRUCTION METHODS MAY BE USED FOR INSTALLING CONDUIT WITH ENGINEER'S APPROVAL
    - CONDUIT WILL BE PAID FOR UNDER INSTALLATION METHODS SHOWN ON THESE PLANS.

PROJECT REFERENCE NO. U-5842  
SHEET NO. DRP-037

Elizabeth City Signal System  
Cable Routing Plans

DRMP  
DRMP INC.  
3000 Peachtree Road, Suite 100  
Atlanta, Georgia 30328  
Tel: 404.525.1234 Fax: 404.525.1235

Prepared for the Office of  
Elizabeth City

Division 1 - Public Works  
8/11/2018  
REVISIONS:  
DATE: 8/11/2018  
BY: [Signature]  
CHECKED BY: [Signature]  
APPROVED BY: [Signature]

SCALE: 1" = 50'

1	NOT USED	INSTALL UNDERGROUND SPICE ENCLOSURE
2	NOT USED	INSTALL AERIAL SPICE ENCLOSURE
3	NOT USED	NOT USED
4	NOT USED	NOT USED
5	NOT USED	NOT USED
6	NOT USED	NOT USED
7	NOT USED	NOT USED
8	NOT USED	NOT USED
9	NOT USED	NOT USED
10	NOT USED	NOT USED
11	NOT USED	NOT USED
12	NOT USED	NOT USED
13	NOT USED	NOT USED
14	NOT USED	NOT USED
15	NOT USED	NOT USED
16	NOT USED	NOT USED
17	NOT USED	NOT USED
18	NOT USED	NOT USED
19	NOT USED	NOT USED
20	NOT USED	NOT USED
21	NOT USED	NOT USED
22	NOT USED	NOT USED
23	NOT USED	NOT USED
24	NOT USED	NOT USED
25	NOT USED	NOT USED
26	NOT USED	NOT USED
27	NOT USED	NOT USED
28	NOT USED	NOT USED
29	NOT USED	NOT USED
30	NOT USED	NOT USED
31	NOT USED	NOT USED
32	NOT USED	NOT USED
33	NOT USED	NOT USED
34	NOT USED	NOT USED
35	NOT USED	NOT USED
36	NOT USED	NOT USED
37	NOT USED	NOT USED
38	NOT USED	NOT USED
39	NOT USED	NOT USED
40	NOT USED	NOT USED
41	NOT USED	NOT USED
42	NOT USED	NOT USED
43	NOT USED	NOT USED
44	NOT USED	NOT USED
45	NOT USED	NOT USED
46	NOT USED	NOT USED
47	NOT USED	NOT USED
48	NOT USED	NOT USED
49	NOT USED	NOT USED
50	NOT USED	NOT USED
51	NOT USED	NOT USED
52	NOT USED	NOT USED
53	NOT USED	NOT USED
54	NOT USED	NOT USED
55	LASH CABLES TO EXISTING MESSENGER CABLE	
56	LASH CABLES TO NEW MESSENGER CABLE	
57	HANDLASH AND INSTALL AERIAL CABLE PROTECTOR	
58	NOT USED	
59	NOT USED	
60	BOND TRACER WIRE TO EQUIPMENT	
61	EQUIPMENT GROUND BUS TRACER WIRE TO EQUIPMENT	
62	TOP POLE GROUNDING	
63	BOND RISE TO POLE GROUND	
64	BOND MESSENGER CABLE TO POLE GROUND	
65	INSTALL MODULABLE DUCT SEAL	
66	SLACK SPAN	

INSTALLATION CROSS-SECTION

**JUNCTION BOX OVER-SIZED**

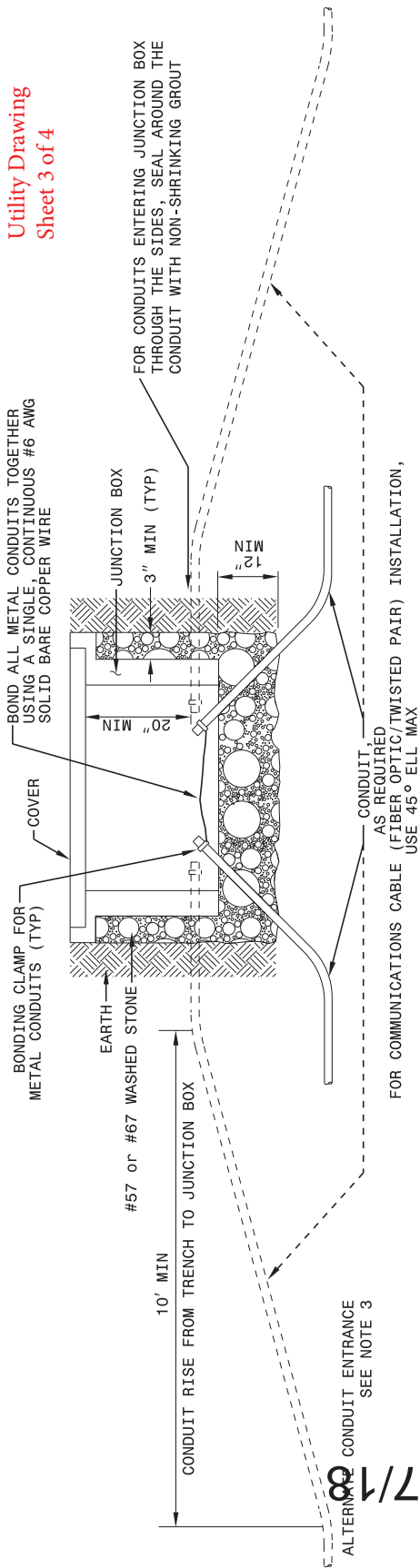

Utility Drawing  
Sheet 3 of 4

**TOP VIEW OF COVER**

STANDARD SIZE JUNCTION BOX



EMBOSSED, IMPRESSED, MOLDED OR ENGRAVED LETTERS  
MIN 1/2" HIGH

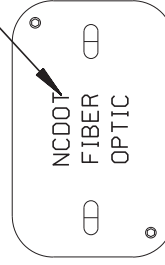

OVER-SIZED JUNCTION BOX

NOTES

1. OTHER STYLES OF JUNCTION BOXES WILL BE ACCEPTABLE PROVIDED THEY SATISFY REQUIREMENTS OF SECTION 1716 OF THE NCDOT STANDARD SPECIFICATIONS FOR ROADS AND STRUCTURES.
2. SECURE COVER WITH TWO HEX BOLTS.
3. INSTALL CONDUIT THROUGH BOTTOM OF JUNCTION BOX. AS AN ALTERNATIVE, CONDUIT MAY ENTER THROUGH "MOUSE HOLE" INTO SIDE OF JUNCTION BOX.
4. FOR CURB AND GUTTER SECTIONS, LOCATE JUNCTION BOXES A MINIMUM OF 6" BEHIND BACK OF CURB AND FOR PAVEMENT SECTIONS A MINIMUM OF 2' FROM PAVEMENT EDGE OR WITHIN RIGHT OF WAY.
5. COIL AND STORE 10' OF TRACER WIRE IN ALL JUNCTION BOXES WITH FIBER OPTIC CABLE.

**JUNCTION BOX STANDARD SIZE**

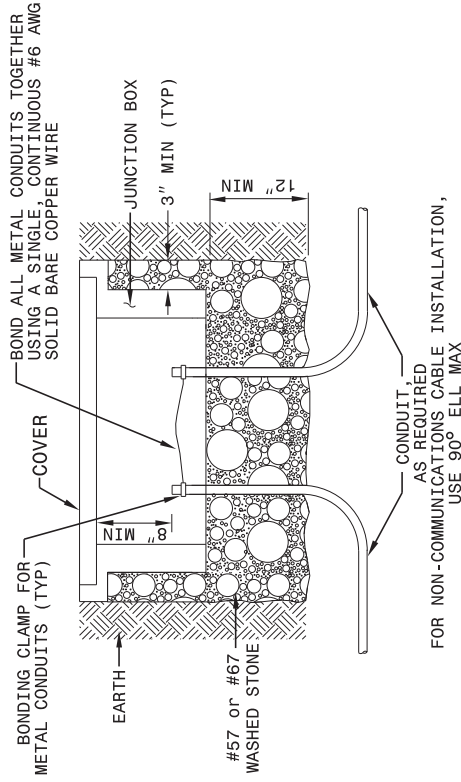

Utility Drawing  
Sheet 4 of 4

CONDUIT TRENCHING

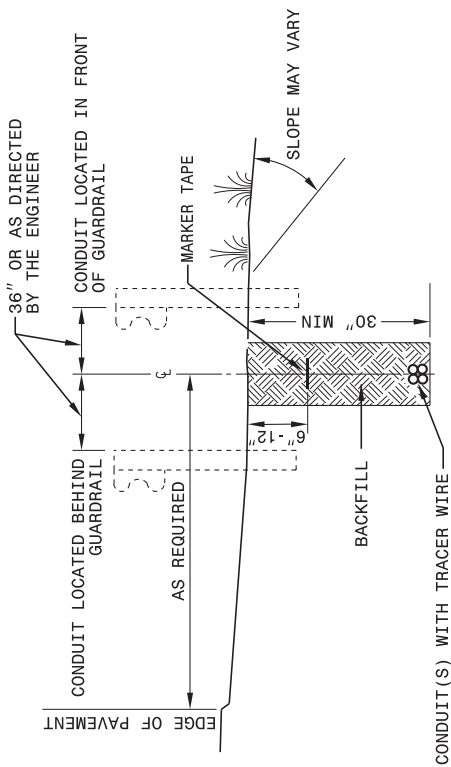

NOTE

THE CONTRACTOR, WITH APPROVAL FROM THE ENGINEER, MAY ADJUST FINAL BURIAL DEPTH OF CONDUIT(S) IN ORDER TO TRAVERSE NON-MOVABLE OBJECTS.

CONDUIT TRENCHING AROUND NON-MOVABLE OBJECT

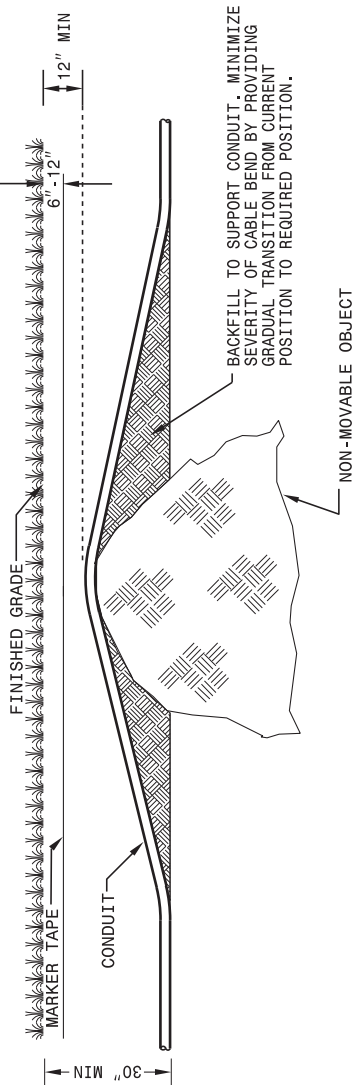

12/17/18

County : Pasquotank

Line #	Item Number	Sec #	Description	Quantity	Unit Cost	Amount
<b>ROADWAY ITEMS</b>						
0001	0000100000-N	800	MOBILIZATION	Lump Sum	L.S.	
0002	2591000000-E	848	4" CONCRETE SIDEWALK	90	SY	
0003	4405000000-E	1110	WORK ZONE SIGNS (PORTABLE)	325	SF	
0004	4410000000-E	1110	WORK ZONE SIGNS (BARRICADE MOUNTED)	72	SF	
0005	4415000000-N	1115	FLASHING ARROW BOARD	2	EA	
0006	4422000000-N	1120	PORTABLE CHANGEABLE MESSAGE SIGN (SHORT TERM)	40	DAY	
0007	4430000000-N	1130	DRUMS	60	EA	
0008	4435000000-N	1135	CONES	40	EA	
0009	4445000000-E	1145	BARRICADES (TYPE III)	48	LF	
0010	4447000000-E	SP	PEDESTRIAN CHANNELIZING DEVICES	30	LF	
0011	4455000000-N	1150	FLAGGER	320	DAY	
0012	4480000000-N	1165	TMA	2	EA	
0013	4510000000-N	1190	LAW ENFORCEMENT	250	HR	
0014	4516000000-N	1180	SKINNY DRUM	80	EA	
0015	4600000000-N	SP	GENERIC TRAFFIC CONTROL ITEM AUDIBLE WARNING DEVICES	8	EA	
0016	4600000000-N	SP	GENERIC TRAFFIC CONTROL ITEM TEMPORARY CURB RAMPS	4	EA	
0017	4685000000-E	1205	THERMOPLASTIC PAVEMENT MARKING LINES (4", 90 MILS)	300	LF	
0018	4720000000-E	1205	THERMOPLASTIC PAVEMENT MARKING CHARACTER (90 MILS)	4	EA	
0019	4725000000-E	1205	THERMOPLASTIC PAVEMENT MARKING SYMBOL (90 MILS)	4	EA	

County : Pasquotank

Line #	Item Number	Sec #	Description	Quantity	Unit Cost	Amount
0020	4850000000-E	1205	REMOVAL OF PAVEMENT MARKING LINES (4")	160	LF	
0021	4870000000-E	1205	REMOVAL OF PAVEMENT MARKING LINES (24")	590	LF	
0022	4875000000-N	1205	REMOVAL OF PAVEMENT MARKING SYMBOLS & CHARACTERS	7	EA	
0023	4891000000-E	1205	GENERIC PAVEMENT MARKING ITEM THERMOPLASTIC PAVEMENT MARKING LINES (24", 90 MILS)	2,470	LF	
0024	7048500000-E	1705	PEDESTRIAN SIGNAL HEAD (16", 1 SECTION W/COUNTDOWN)	58	EA	
0025	7060000000-E	1705	SIGNAL CABLE	22,040	LF	
0026	7120000000-E	1705	VEHICLE SIGNAL HEAD (12", 3 SECTION)	110	EA	
0027	7132000000-E	1705	VEHICLE SIGNAL HEAD (12", 4 SECTION)	26	EA	
0028	7144000000-E	1705	VEHICLE SIGNAL HEAD (12", 5 SECTION)	9	EA	
0029	7252000000-E	1710	MESSENGER CABLE (1/4")	25,058	LF	
0030	7264000000-E	1710	MESSENGER CABLE (3/8")	2,630	LF	
0031	7279000000-E	1715	TRACER WIRE	44,687	LF	
0032	7301000000-E	1715	DIRECTIONAL DRILL (*****) (1, 2")	80	LF	
0033	7301000000-E	1715	DIRECTIONAL DRILL (*****) (2, 2")	19,145	LF	
0034	7324000000-N	1716	JUNCTION BOX (STANDARD SIZE)	39	EA	
0035	7348000000-N	1716	JUNCTION BOX (OVER-SIZED, HEAVY DUTY)	114	EA	
0036	7372000000-N	1721	GUY ASSEMBLY	116	EA	
0037	7396000000-E	1722	1/2" RISER WITH WEATHERHEAD	12	EA	

County : Pasquotank

Line #	Item Number	Sec #	Description	Quantity	Unit Cost	Amount
0038	7408000000-E	1722	1" RISER WITH WEATHERHEAD	1 EA		
0039	7420000000-E	1722	2" RISER WITH WEATHERHEAD	26 EA		
0040	7432000000-E	1722	2" RISER WITH HEAT SHRINK TUBING	38 EA		
0041	7444000000-E	1725	INDUCTIVE LOOP SAWCUT	5,380 LF		
0042	7456000000-E	1726	LEAD-IN CABLE (*****) (14-2)	46,950 LF		
0043	7516000000-E	1730	COMMUNICATIONS CABLE (**FIBER) (12)	14,785 LF		
0044	7516000000-E	1730	COMMUNICATIONS CABLE (**FIBER) (48)	91,379 LF		
0045	7528000000-E	1730	DROP CABLE	9,537 LF		
0046	7540000000-N	1731	SPLICE ENCLOSURE	38 EA		
0047	7552000000-N	1731	INTERCONNECT CENTER	44 EA		
0048	7566000000-N	1733	DELINEATOR MARKER	67 EA		
0049	7575142200-N	SP	NEW ELECTRICAL SERVICE	10 EA		
0050	7575160000-E	1734	REMOVE EXISTING COMMUNICATIONS CABLE	13,318 LF		
0051	7575180000-N	1735	CABLE TRANSFER	10 EA		
0052	7576000000-N	SP	METAL STRAIN SIGNAL POLE	2 EA		
0053	7613000000-N	SP	SOIL TEST	2 EA		
0054	7614100000-E	SP	DRILLED PIER FOUNDATION	23.3 CY		
0055	7636000000-N	1745	SIGN FOR SIGNALS	3 EA		
0056	7642100000-N	1743	TYPE I POST WITH FOUNDATION	4 EA		

County : Pasquotank

Line #	Item Number	Sec #	Description	Quantity	Unit Cost	Amount
0057	7642200000-N	1743	TYPE II PEDESTAL WITH FOUNDATION	22 EA		
0058	7684000000-N	1750	SIGNAL CABINET FOUNDATION	8 EA		
0059	7686000000-N	1752	CONDUIT ENTRANCE INTO EXISTING FOUNDATION	19 EA		
0060	7708000000-N	1751	DETECTOR CARD (*****) (MODEL 222)	282 EA		
0061	7901000000-N	1753	CABINET BASE EXTENDER	44 EA		
0062	7980000000-N	SP	GENERIC SIGNAL ITEM CCTV CAMERA ASSEMBLY	20 EA		
0063	7980000000-N	SP	GENERIC SIGNAL ITEM CONTROLLER WITH CABINET WITH AUX FILE (2070LX, 332)	44 EA		
0064	7980000000-N	SP	GENERIC SIGNAL ITEM DIGITAL DISPLAY MONITOR	1 EA		
0065	7980000000-N	SP	GENERIC SIGNAL ITEM ETHERNET CORE SWITCH	1 EA		
0066	7980000000-N	SP	GENERIC SIGNAL ITEM ETHERNET EDGE SWITCH	44 EA		
0067	7980000000-N	SP	GENERIC SIGNAL ITEM FIREWALL	1 EA		
0068	7980000000-N	SP	GENERIC SIGNAL ITEM FURNISH 2018 ENHANCED CONFLICT MONITOR	3 EA		
0069	7980000000-N	SP	GENERIC SIGNAL ITEM FURNISH 2070 CONTROLLER TESTER	1 EA		
0070	7980000000-N	SP	GENERIC SIGNAL ITEM FURNISH 2070LX CONTROLLER	3 EA		
0071	7980000000-N	SP	GENERIC SIGNAL ITEM FURNISH 332 CABINET WITH AUX FILE	3 EA		
0072	7980000000-N	SP	GENERIC SIGNAL ITEM FURNISH CCTV CAMERA ASSEMBLY	2 EA		



County : Pasquotank

Line #	Item Number	Sec #	Description	Quantity	Unit Cost	Amount
0073	7980000000-N	SP	GENERIC SIGNAL ITEM FURNISH CONFLICT MONITOR TEST- ER	1 EA		
0074	7980000000-N	SP	GENERIC SIGNAL ITEM FURNISH ETHERNET EDGE SWITCH	3 EA		
0075	7980000000-N	SP	GENERIC SIGNAL ITEM GUY ASSEMBLY - AERIAL	1 EA		
0076	7980000000-N	SP	GENERIC SIGNAL ITEM GUY ASSEMBLY - SIDEWALK	8 EA		
0077	7980000000-N	SP	GENERIC SIGNAL ITEM HEAT SHRINK TUBING KIT	12 EA		
0078	7980000000-N	SP	GENERIC SIGNAL ITEM ITS SERVER	3 EA		
0079	7980000000-N	SP	GENERIC SIGNAL ITEM JUNCTION BOX (SPECIAL-SIZED)	15 EA		
0080	7980000000-N	SP	GENERIC SIGNAL ITEM JUNCTION BOX MARKER	46 EA		
0081	7980000000-N	SP	GENERIC SIGNAL ITEM KVM SWITCH	1 EA		
0082	7980000000-N	SP	GENERIC SIGNAL ITEM MODIFY COMMUNICATIONS RACK	1 EA		
0083	7980000000-N	SP	GENERIC SIGNAL ITEM MODIFY EXISTING ELECTRICAL SERVICE	8 EA		
0084	7980000000-N	SP	GENERIC SIGNAL ITEM MODIFY FOUNDATION FOR CONTROL- LER CABINET	6 EA		
0085	7980000000-N	SP	GENERIC SIGNAL ITEM POLE GROUNDING SYSTEM	71 EA		
0086	7980000000-N	SP	GENERIC SIGNAL ITEM POWDER COAT FOR STRAIN POLE (BLACK)	2 EA		
0087	7980000000-N	SP	GENERIC SIGNAL ITEM PTZ JOYSTICK	1 EA		

County : Pasquotank

Line #	Item Number	Sec #	Description	Quantity	Unit Cost	Amount
0088	7980000000-N	SP	GENERIC SIGNAL ITEM RELOCATE EXISTING CABINET EQUIPMENT	30 EA		
0089	7980000000-N	SP	GENERIC SIGNAL ITEM SIGNAL SYSTEM SUPERVISOR'S COMPUTER SYSTEM	1 EA		
0090	7980000000-N	SP	GENERIC SIGNAL ITEM SPAN TRANSFER	69 EA		
0091	7980000000-N	SP	GENERIC SIGNAL ITEM TYPE 332 TEST CONTROLLER WITH CABINET	1 EA		
0092	7980000000-N	SP	GENERIC SIGNAL ITEM UPS IN COMMUNICATIONS RACK	1 EA		
0093	7980000000-N	SP	GENERIC SIGNAL ITEM WOOD POLE FOR SIGNALS	9 EA		
0094	7980000000-N	SP	GENERIC SIGNAL ITEM WOOD POLE FOR SIGNALS WITH CCTV	13 EA		
0095	7985000000-N	SP	GENERIC SIGNAL ITEM CCTV SOFTWARE	Lump Sum	L.S.	
0096	7985000000-N	SP	GENERIC SIGNAL ITEM NETWORK MANAGEMENT SOFTWARE	Lump Sum	L.S.	
0097	7985000000-N	SP	GENERIC SIGNAL ITEM SIGNAL SYSTEM SOFTWARE	Lump Sum	L.S.	
0098	7985000000-N	SP	GENERIC SIGNAL ITEM SYSTEM SUPPORT SOFTWARE & DEVICES	Lump Sum	L.S.	
0099	7985000000-N	SP	GENERIC SIGNAL ITEM TMC BUILDING MODIFICATIONS	Lump Sum	L.S.	
0100	7985000000-N	SP	GENERIC SIGNAL ITEM TRAINING	Lump Sum	L.S.	
0101	7990000000-E	SP	GENERIC SIGNAL ITEM AERIAL CABLE PROTECTOR	75 LF		
0102	7990000000-E	SP	GENERIC SIGNAL ITEM ETHERNET CABLE	3,787 LF		

County : Pasquotank

Line #	Item Number	Sec #	Description	Quantity	Unit Cost	Amount
0103	7990000000-E	SP	GENERIC SIGNAL ITEM UNDERGROUND CONDUIT (1, 1")	185	LF	
0104	7990000000-E	SP	GENERIC SIGNAL ITEM UNDERGROUND CONDUIT (1, 2")	1,955	LF	
0105	7990000000-E	SP	GENERIC SIGNAL ITEM UNDERGROUND CONDUIT (2, 2")	24,158	LF	
0106	7990000000-E	SP	GENERIC SIGNAL ITEM UNDERGROUND CONDUIT (3, 2")	40	LF	
0107	7991000000-E	SP	GENERIC SIGNAL ITEM BRICK PAVERS	8	SF	

1520/May12/Q331663.3/D749105482200/E107

Total Amount Of Bid For Entire Project :

DBE Goal Set: 0%  
DBE Goal Obtained: 0%

Vendor 1 of 2: ALS OF NORTH CAROLINA LLC (3412)  
Call Order 001 (Proposal: C204648)

### Bid Information

---

<b>Proposal County:</b> PASQUOTANK	<b>Bid Checksum:</b> 7936DEA1E8
<b>Vendor Address:</b> 502 KLUMAC RD SALISBURY , NC , 28144	<b>Bid Total:</b> \$4,399,018.00
<b>Signature Check:</b> PHILLIP ANASTASIOS KARAGANIS	<b>Items Total:</b> \$4,399,018.00
<b>Time Bid Received:</b> June 15, 2021 10:01 AM	<b>Time Total:</b> \$0.00
<b>Amendment Count:</b> 0	

**Bidding Errors:**  
None.

Vendor 1 of 2: ALS OF NORTH CAROLINA LLC (3412)  
Call Order 001 (Proposal: C204648)

Bid Bond Information

---

<b>Projects:</b>	<b>Bond Maximum:</b>
<b>Counties:</b>	<b>State of Incorporation:</b>
<b>Bond ID:</b> SNC21673936	<b>Agency Execution Date:</b> 06/04/2021 11
<b>Paid by Check:</b> No	<b>Surety Name:</b> Surety2000
<b>Bond Percent:</b> 5%	<b>Bond Agency Name:</b> Travelers Pennsylvania

Letting: L210615  
06/15/2021 02:00:00 PM

North Carolina Department of Transportation  
3412 - ALS of North Carolina, LLC

Contract ID: C204648  
Call: 001

BondID: SNC21673936  
Surety Registry Agency: Surety2000  
Verified?: 1  
Surety Agency: Travelers Pennsylvania  
Bond Execution Date: 06/04/2021 11:35:41 AM

Line Number	Item Number	Quantity	Unit	Unit Price	Extension Price
Section 0001 ROADWAY ITEMS					
0001	0000100000-N MOBILIZATION	1.000	LS	\$471,786.0000	\$471,786.00
0002	2591000000-E 4" CONCRETE SIDEWALK	90.000	SY	\$450.0000	\$40,500.00
0003	4405000000-E WORK ZONE SIGNS (PORTABLE)	325.000	SF	\$35.0000	\$11,375.00
0004	4410000000-E WORK ZONE SIGNS (BARRICADE MOUNTED)	72.000	SF	\$15.5000	\$1,116.00
0005	4415000000-N FLASHING ARROW BOARD	2.000	EA	\$10,000.0000	\$20,000.00
0006	4422000000-N PORTABLE CHANGEABLE MESSAGE SIGN (SHORT TERM)	40.000	DAY	\$325.0000	\$13,000.00
0007	4430000000-N DRUMS	60.000	EA	\$72.0000	\$4,320.00
0008	4435000000-N CONES	40.000	EA	\$80.0000	\$3,200.00
0009	4445000000-E BARRICADES (TYPE III)	48.000	LF	\$78.0000	\$3,744.00
0010	4447000000-E PEDESTRIAN CHANNELIZING DEVICES	30.000	LF	\$55.0000	\$1,650.00
0011	4455000000-N FLAGGER	320.000	DAY	\$270.0000	\$86,400.00
0012	4480000000-N TMA	2.000	EA	\$17,500.0000	\$35,000.00
0013	4510000000-N LAW ENFORCEMENT	250.000	HR	\$100.0000	\$25,000.00
0014	4516000000-N SKINNY DRUM	80.000	EA	\$40.0000	\$3,200.00
0015	4600000000-N GENERIC TRAFFIC CONTROL ITEM AUDIBLE WARNING DEVICES	8.000	EA	\$1,400.0000	\$11,200.00
0016	4600000000-N GENERIC TRAFFIC CONTROL ITEM TEMPORARY CURB RAMPS	4.000	EA	\$3,500.0000	\$14,000.00
0017	4685000000-E THERMOPLASTIC PAVEMENT MARKING LINES (4", 90 MILS)	300.000	LF	\$3.5000	\$1,050.00
0018	4720000000-E THERMOPLASTIC PAVEMENT MARKING CHARACTER (90 MILS)	4.000	EA	\$350.0000	\$1,400.00
0019	4725000000-E THERMOPLASTIC PAVEMENT MARKING SYMBOL (90 MILS)	4.000	EA	\$350.0000	\$1,400.00
0020	4850000000-E REMOVAL OF PAVEMENT MARKING LINES (4")	160.000	LF	\$8.0000	\$1,280.00
0021	4870000000-E REMOVAL OF PAVEMENT MARKING LINES (24")	590.000	LF	\$5.7500	\$3,392.50
0022	4875000000-N REMOVAL OF PAVEMENT MARKING SYMBOLS & CHARACTERS	7.000	EA	\$190.0000	\$1,330.00
0023	4891000000-E	2470.000	LF	\$13.0000	\$32,110.00

GENERIC PAVEMENT MARKING ITEM THERMOPLASTIC PAVEMENT MARKING LINES (24", 90 MILS)					
0024	7048500000-E	58.000	EA	\$1,000.0000	\$58,000.00
	PEDESTRIAN SIGNAL HEAD (16", 1SECTION W/COUNTDOWN)				
0025	7060000000-E	22040.000	LF	\$3.7500	\$82,650.00
	SIGNAL CABLE				
0026	7120000000-E	110.000	EA	\$820.0000	\$90,200.00
	VEHICLE SIGNAL HEAD (12", 3 SECTION)				
0027	7132000000-E	26.000	EA	\$1,100.0000	\$28,600.00
	VEHICLE SIGNAL HEAD (12", 4 SECTION)				
0028	7144000000-E	9.000	EA	\$1,500.0000	\$13,500.00
	VEHICLE SIGNAL HEAD (12", 5 SECTION)				
0029	7252000000-E	25058.000	LF	\$3.4000	\$85,197.20
	MESSENGER CABLE (1/4")				
0030	7264000000-E	2630.000	LF	\$5.5000	\$14,465.00
	MESSENGER CABLE (3/8")				
0031	7279000000-E	44687.000	LF	\$0.7500	\$33,515.25
	TRACER WIRE				
0032	7301000000-E	80.000	LF	\$17.0000	\$1,360.00
	DIRECTIONAL DRILL (***** ) (1, 2")				
0033	7301000000-E	19145.000	LF	\$17.2000	\$329,294.00
	DIRECTIONAL DRILL (***** ) (2, 2")				
0034	7324000000-N	39.000	EA	\$300.0000	\$11,700.00
	JUNCTION BOX (STANDARD SIZE)				
0035	7348000000-N	114.000	EA	\$565.0000	\$64,410.00
	JUNCTION BOX (OVER-SIZED, HEA-VY DUTY)				
0036	7372000000-N	116.000	EA	\$725.0000	\$84,100.00
	GUY ASSEMBLY				
0037	7396000000-E	12.000	EA	\$700.0000	\$8,400.00
	1/2" RISER WITH WEATHERHEAD				
0038	7408000000-E	1.000	EA	\$665.2000	\$665.20
	1" RISER WITH WEATHERHEAD				
0039	7420000000-E	26.000	EA	\$750.0000	\$19,500.00
	2" RISER WITH WEATHERHEAD				
0040	7432000000-E	38.000	EA	\$900.0000	\$34,200.00
	2" RISER WITH HEAT SHRINK TUBING				
0041	7444000000-E	5380.000	LF	\$9.0000	\$48,420.00
	INDUCTIVE LOOP SAWCUT				
0042	7456000000-E	46950.000	LF	\$2.1500	\$100,942.50
	LEAD-IN CABLE (***** ) (14-2)				
0043	7516000000-E	14785.000	LF	\$2.5000	\$36,962.50
	COMMUNICATIONS CABLE (**FIBER) (12)				
0044	7516000000-E	91379.000	LF	\$3.0000	\$274,137.00
	COMMUNICATIONS CABLE (**FIBER) (48)				
0045	7528000000-E	9537.000	LF	\$2.4000	\$22,888.80
	DROP CABLE				
0046	7540000000-N	38.000	EA	\$1,500.0000	\$57,000.00
	SPLICE ENCLOSURE				
0047	7552000000-N	44.000	EA	\$1,525.0000	\$67,100.00



INTERCONNECT CENTER

0048	7566000000-N DELINEATOR MARKER	67.000 EA	\$95.0000	\$6,365.00
0049	7575142200-N NEW ELECTRICAL SERVICE	10.000 EA	\$1,800.0000	\$18,000.00
0050	7575160000-E REMOVE EXISTING COMMUNICATIONSCABLE	13318.000 LF	\$1.0000	\$13,318.00
0051	7575180000-N CABLE TRANSFER	10.000 EA	\$360.0000	\$3,600.00
0052	7576000000-N METAL STRAIN SIGNAL POLE	2.000 EA	\$17,150.0000	\$34,300.00
0053	7613000000-N SOIL TEST	2.000 EA	\$3,000.0000	\$6,000.00
0054	7614100000-E DRILLED PIER FOUNDATION	23.300 CY	\$1,700.0000	\$39,610.00
0055	7636000000-N SIGN FOR SIGNALS	3.000 EA	\$600.0000	\$1,800.00
0056	7642100000-N TYPE I POST WITH FOUNDATION	4.000 EA	\$1,700.0000	\$6,800.00
0057	7642200000-N TYPE II PEDESTAL WITH FOUND- ATION	22.000 EA	\$1,975.0000	\$43,450.00
0058	7684000000-N SIGNAL CABINET FOUNDATION	8.000 EA	\$2,500.0000	\$20,000.00
0059	7686000000-N CONDUIT ENTRANCE INTO EXISTINGFOUNDATION	19.000 EA	\$600.0000	\$11,400.00
0060	7708000000-N DETECTOR CARD (***** (MODEL 222)	282.000 EA	\$90.0000	\$25,380.00
0061	7901000000-N CABINET BASE EXTENDER	44.000 EA	\$500.0000	\$22,000.00
0062	7980000000-N GENERIC SIGNAL ITEM CCTV CAMERA ASSEMBLY	20.000 EA	\$4,900.0000	\$98,000.00
0063	7980000000-N GENERIC SIGNAL ITEM CONTROLLER WITH CABINET WITH AUX FILE (2070LX, 332)	44.000 EA	\$12,500.0000	\$550,000.00
0064	7980000000-N GENERIC SIGNAL ITEM DIGITAL DISPLAY MONITOR	1.000 EA	\$3,800.0000	\$3,800.00
0065	7980000000-N GENERIC SIGNAL ITEM ETHERNET CORE SWITCH	1.000 EA	\$55,451.9500	\$55,451.95
0066	7980000000-N GENERIC SIGNAL ITEM ETHERNET EDGE SWITCH	44.000 EA	\$1,700.0000	\$74,800.00
0067	7980000000-N GENERIC SIGNAL ITEM FIREWALL	1.000 EA	\$5,000.0000	\$5,000.00
0068	7980000000-N GENERIC SIGNAL ITEM FURNISH 2018 ENHANCED CONFLICTMONITOR	3.000 EA	\$1,200.0000	\$3,600.00
0069	7980000000-N GENERIC SIGNAL ITEM FURNISH 2070 CONTROLLER TESTER	1.000 EA	\$8,000.0000	\$8,000.00
0070	7980000000-N GENERIC SIGNAL ITEM FURNISH 2070LX CONTROLLER	3.000 EA	\$1,800.0000	\$5,400.00
0071	7980000000-N GENERIC SIGNAL ITEM FURNISH 332 CABINET WITH AUX FILE	3.000 EA	\$9,000.0000	\$27,000.00

0072	7980000000-N	2.000 EA	\$3,500.0000	\$7,000.00
	GENERIC SIGNAL ITEM FURNISH CCTV CAMERA ASSEMBLY			
0073	7980000000-N	1.000 EA	\$27,000.0000	\$27,000.00
	GENERIC SIGNAL ITEM FURNISH CONFLICT MONITOR TEST-ER			
0074	7980000000-N	3.000 EA	\$1,700.0000	\$5,100.00
	GENERIC SIGNAL ITEM FURNISH ETHERNET EDGE SWITCH			
0075	7980000000-N	1.000 EA	\$1,000.0000	\$1,000.00
	GENERIC SIGNAL ITEM GUY ASSEMBLY - AERIAL			
0076	7980000000-N	8.000 EA	\$950.0000	\$7,600.00
	GENERIC SIGNAL ITEM GUY ASSEMBLY - SIDEWALK			
0077	7980000000-N	12.000 EA	\$150.0000	\$1,800.00
	GENERIC SIGNAL ITEM HEAT SHRINK TUBING KIT			
0078	7980000000-N	3.000 EA	\$10,000.0000	\$30,000.00
	GENERIC SIGNAL ITEM ITS SERVER			
0079	7980000000-N	15.000 EA	\$950.0000	\$14,250.00
	GENERIC SIGNAL ITEM JUNCTION BOX (SPECIAL-SIZED)			
0080	7980000000-N	46.000 EA	\$60.0000	\$2,760.00
	GENERIC SIGNAL ITEM JUNCTION BOX MARKER			
0081	7980000000-N	1.000 EA	\$3,400.0000	\$3,400.00
	GENERIC SIGNAL ITEM KVM SWITCH			
0082	7980000000-N	1.000 EA	\$6,000.0000	\$6,000.00
	GENERIC SIGNAL ITEM MODIFY COMMUNICATIONS RACK			
0083	7980000000-N	8.000 EA	\$500.0000	\$4,000.00
	GENERIC SIGNAL ITEM MODIFY EXISTING ELECTRICAL SERVICE			
0084	7980000000-N	6.000 EA	\$1,250.0000	\$7,500.00
	GENERIC SIGNAL ITEM MODIFY FOUNDATION FOR CONTROL- LER CABINET			
0085	7980000000-N	71.000 EA	\$280.0000	\$19,880.00
	GENERIC SIGNAL ITEM POLE GROUNDING SYSTEM			
0086	7980000000-N	2.000 EA	\$1,001.0000	\$2,002.00
	GENERIC SIGNAL ITEM POWDER COAT FOR STRAIN POLE (BLACK)			
0087	7980000000-N	1.000 EA	\$1,200.0000	\$1,200.00
	GENERIC SIGNAL ITEM PTZ JOYSTICK			
0088	7980000000-N	30.000 EA	\$100.0000	\$3,000.00
	GENERIC SIGNAL ITEM RELOCATE EXISTING CABINET EQUIPMENT			
0089	7980000000-N	1.000 EA	\$6,500.0000	\$6,500.00
	GENERIC SIGNAL ITEM SIGNAL SYSTEM SUPERVISOR'S COMPUTER SYSTEM			
0090	7980000000-N	69.000 EA	\$60.0000	\$4,140.00
	GENERIC SIGNAL ITEM SPAN TRANSFER			
0091	7980000000-N	1.000 EA	\$15,000.0000	\$15,000.00
	GENERIC SIGNAL ITEM TYPE 332 TEST CONTROLLER WITH CABINET			
0092	7980000000-N	1.000 EA	\$8,300.0000	\$8,300.00
	GENERIC SIGNAL ITEM UPS IN COMMUNICATIONS RACK			
0093	7980000000-N	9.000 EA	\$1,500.0000	\$13,500.00
	GENERIC SIGNAL ITEM WOOD POLE FOR SIGNALS			
0094	7980000000-N	13.000 EA	\$3,700.0000	\$48,100.00
	GENERIC SIGNAL ITEM WOOD POLE FOR SIGNALS WITH CCTV			
0095	7985000000-N	1.000 LS	\$14,000.0000	\$14,000.00
	GENERIC SIGNAL ITEM CCTV SOFTWARE			
0096	7985000000-N	1.000 LS	\$16,650.0000	\$16,650.00

GENERIC SIGNAL ITEM NETWORK MANAGEMENT SOFTWARE				
0097	7985000000-N	1.000 LS	\$285,000.0000	\$285,000.00
GENERIC SIGNAL ITEM SIGNAL SYSTEM SOFTWARE				
0098	7985000000-N	1.000 LS	\$28,000.0000	\$28,000.00
GENERIC SIGNAL ITEM SYSTEM SUPPORT SOFTWARE & DEVICES				
0099	7985000000-N	1.000 LS	\$32,260.6000	\$32,260.60
GENERIC SIGNAL ITEM TMC BUILDING MODIFICATIONS				
0100	7985000000-N	1.000 LS	\$71,507.0000	\$71,507.00
GENERIC SIGNAL ITEM TRAINING				
0101	7990000000-E	75.000 LF	\$20.0000	\$1,500.00
GENERIC SIGNAL ITEM AERIAL CABLE PROTECTOR				
0102	7990000000-E	3787.000 LF	\$4.5000	\$17,041.50
GENERIC SIGNAL ITEM ETHERNET CABLE				
0103	7990000000-E	185.000 LF	\$10.5000	\$1,942.50
GENERIC SIGNAL ITEM UNDERGROUND CONDUIT (1, 1")				
0104	7990000000-E	1955.000 LF	\$10.5000	\$20,527.50
GENERIC SIGNAL ITEM UNDERGROUND CONDUIT (1, 2")				
0105	7990000000-E	24158.000 LF	\$9.5000	\$229,501.00
GENERIC SIGNAL ITEM UNDERGROUND CONDUIT (2, 2")				
0106	7990000000-E	40.000 LF	\$40.0000	\$1,600.00
GENERIC SIGNAL ITEM UNDERGROUND CONDUIT (3, 2")				
0107	7991000000-E	8.000 SF	\$340.0000	\$2,720.00
GENERIC SIGNAL ITEM BRICK PAVERS				
Section 0001 Total				\$4,399,018.00
Item Total				\$4,399,018.00

**ELECTRONIC BID SUBMISSION**

By submitting this bid electronically, I hereby acknowledge that all requirements included in the hard copy proposal, addendum, amendments, plans, standard specifications, supplemental specifications and special provisions are part of the bid and contract. Further, I acknowledge that I have read, understand, accept, acknowledge and agree to comply with all statements in this electronic bid.

=====

**NON-COLLUSION, DEBARMENT AND GIFT BAN CERTIFICATION**

The prequalified bidder declares (or certifies, verifies, or states) under penalty of perjury under the laws of the United States that neither he, nor any official, agent or employee has entered into any agreement, participated in any collusion, or otherwise taken any action which is in restraint of free competitive bidding in connection with any bid or contract, that the prequalified bidder has not been convicted of violating N.C.G.S. §133-24 within the last three years, and that the prequalified bidder intends to do the work with his own bonafide employees or subcontractors and will not bid for the benefit of another contractor.

By submitting this non-collusion, debarment and gift ban certification, the Contractor is attesting his status under penalty of perjury under the laws of the United States in accordance with the Debarment Certification attached, provided that the Debarment Certification also includes any required statements concerning exceptions that are applicable.

N.C.G.S. §133-32 and Executive Order 24 prohibit the offer to, or acceptance by, any State Employee of any gift from anyone with a contract with the State, or from any person seeking to do business with the State. By execution of any response in this procurement, you attest, for your entire organization and its employees or agents, that you are not aware that any such gift has been offered, accepted, or promised by any employees of your organization.

**DEBARMENT CERTIFICATION OF PREQUALIFIED BIDDER**

Conditions for certification:

1. The prequalified bidder shall provide immediate written notice to the Department if at any time the bidder learns that his certification was erroneous when he submitted his debarment certification or explanation that is file with the Department, or has become erroneous because of changed circumstances.
2. The terms covered transaction, debarred, suspended, ineligible, lower tier

covered transaction, participant, person, primary covered transaction, principal, proposal, and voluntarily excluded, as used in this provision, have the meanings set out in the Definitions and Coverage sections of the rules implementing Executive Order 12549. A copy of the Federal Rules requiring this certification and detailing the definitions and coverages may be obtained from the Contract Officer of the Department.

3. The prequalified bidder agrees by submitting this form, that he will not knowingly enter into any lower tier covered transaction with a person who is debarred, suspended, declared ineligible, or voluntarily excluded from participation in NCDOT contracts, unless authorized by the Department.

4. For Federal Aid projects, the prequalified bidder further agrees that by submitting this form he will include the Federal- Aid Provision titled Required Contract Provisions Federal-Aid Construction Contract (Form FHWA PR 1273) provided by the Department, without subsequent modification, in all lower tier covered transactions.

5. The prequalified bidder may rely upon a certification of a participant in a lower tier covered transaction that he is not debarred, suspended, ineligible, or voluntarily excluded from the covered transaction, unless he knows that the certification is erroneous. The bidder may decide the method and frequency by which he will determine the eligibility of his subcontractors.

6. Nothing contained in the foregoing shall be construed to require establishment of a system of records in order to render in good faith the certification required by this provision. The knowledge and information of a participant is not required to exceed that which is normally possessed by a prudent person in the ordinary course of business dealings.

7. Except as authorized in paragraph 6 herein, the Department may terminate any contract if the bidder knowingly enters into a lower tier covered transaction with a person who is suspended, debarred, ineligible, or voluntarily excluded from participation in this transaction, in addition to other remedies available by the Federal Government.

#### **DEBARMENT CERTIFICATION**

The prequalified bidder certifies to the best of his knowledge and belief, that he and his principals:

a. Are not presently debarred, suspended, proposed for debarment, declared ineligible, or voluntarily excluded from covered transactions by any Federal department or agency;

b. Have not within a three-year period preceding this proposal been convicted of or had a civil judgment rendered against them for commission of fraud or a criminal offense in connection with obtaining, attempting to obtain, or performing a public (Federal, State or local) transaction or contract under a public transaction; violation of Federal or State antitrust statutes or

commission of embezzlement, theft, forgery, bribery, falsification or destruction of records; making false statements; or receiving stolen property;

c. Are not presently indicted for or otherwise criminally or civilly charged by a governmental entity (Federal, State or local) with commission of any of the offenses enumerated in paragraph b. of this certification; and

d. Have not within a three-year period preceding this proposal had one or more public transactions (Federal, State or local) terminated for cause or default.

e. Will submit a revised Debarment Certification immediately if his status changes and will show in his bid proposal an explanation for the change in status.

If the prequalified bidder cannot certify that he is not debarred, he shall provide an explanation with this submittal. An explanation will not necessarily result in denial of participation in a contract.

Failure to submit a non-collusion and debarment certification will result in the prequalified bidder's bid being considered non-responsive.

**EXPLANATION:**

=====

### **Award Limits on Multiple Projects**

By answering YES to this statement, the bidder acknowledges that they are using the award limits on multiple projects? **Yes**  **No**

A bidder who desires to bid on more than one project on which bids are to be opened on the same date, and who also desires to avoid receiving an award of more projects than he is equipped to handle, may bid on any number of projects but may limit the total amount of work awarded to him on selected projects by completing the AWARD LIMITS ON MULTIPLE PROJECTS.

The Award Limits on Multiple Projects must be filled in on each project bid for which the Bidder desires protection.

It is the desire of the Bidder to be awarded contracts, the value of which will not exceed a total of     for those

projects indicated herein, for which bids will be opened on     (MM/DD/YY)

The Award Limits shall apply to the following projects:

Contract Number  
County

Contract Number  
County

Contract Number  
County

Contract Number  
County

Contract Number  
County

Contract Number  
County

It is agreed that if I am (we are) the low Bidder(s) on indicated projects, the total value of which is more than the above stipulated award limits, the Board of Transportation will award me (us) projects from among those indicated

that have a total value not to exceed the award limit and will result in the lowest total bids to the Department of Transportation.



THIS PROPOSAL CONTAINS THE FOLLOWING ERRORS/WARNINGS (IF ANY)

This Bid contains 0 amendment files

**Electronic Bid Submission**

By submitting this bid electronically, I hereby acknowledge that all requirements included in the hard copy proposal, addendum, amendments, plans, standard specifications, supplemental specifications and special provisions are part of the bid and contract. Further, I acknowledge that I have read, understand, accept, acknowledge and agree to comply with all statements in this electronic bid.

I hereby certify that I have the authority to submit this bid.

Signature \_\_\_\_\_

Agency \_\_\_\_\_

Date \_\_\_\_\_

Signature \_\_\_\_\_

Agency \_\_\_\_\_

Date \_\_\_\_\_

Signature \_\_\_\_\_

Agency \_\_\_\_\_

Date \_\_\_\_\_

## Contract Item Sheets For C204648

Line #	ItemNumber	Sec #	Description	Quantity Unit	Unit Bid Price	Amount Bid
<b>ROADWAY ITEMS</b>						
0001	0000100000-N	800	MOBILIZATION	Lump Sum LS	471,786.00	471,786.00
0002	2591000000-E	848	4" CONCRETE SIDEWALK	90 SY	450.00	40,500.00
0003	4405000000-E	1110	WORK ZONE SIGNS (PORTABLE)	325 SF	35.00	11,375.00
0004	4410000000-E	1110	WORK ZONE SIGNS (BARRICADE MOUNTED)	72 SF	15.50	1,116.00
0005	4415000000-N	1115	FLASHING ARROW BOARD	2 EA	10,000.00	20,000.00
0006	4422000000-N	1120	PORTABLE CHANGEABLE MESSAGE SIGN (SHORT TERM)	40 DAY	325.00	13,000.00
0007	4430000000-N	1130	DRUMS	60 EA	72.00	4,320.00
0008	4435000000-N	1135	CONES	40 EA	80.00	3,200.00
0009	4445000000-E	1145	BARRICADES (TYPE III)	48 LF	78.00	3,744.00
0010	4447000000-E	SP	PEDESTRIAN CHANNELIZING DEVICES	30 LF	55.00	1,650.00
0011	4455000000-N	1150	FLAGGER	320 DAY	270.00	86,400.00
0012	4480000000-N	1165	TMA	2 EA	17,500.00	35,000.00
0013	4510000000-N	1190	LAW ENFORCEMENT	250 HR	100.00	25,000.00
0014	4516000000-N	1180	SKINNY DRUM	80 EA	40.00	3,200.00
0015	4600000000-N	SP	GENERIC TRAFFIC CONTROL ITEM AUDIBLE WARNING DEVICES	8 EA	1,400.00	11,200.00
0016	4600000000-N	SP	GENERIC TRAFFIC CONTROL ITEM TEMPORARY CURB RAMPS	4 EA	3,500.00	14,000.00
0017	4685000000-E	1205	THERMOPLASTIC PAVEMENT MARKING LINES (4", 90 MILS)	300 LF	3.50	1,050.00
0018	4720000000-E	1205	THERMOPLASTIC PAVEMENT MARKING CHARACTER (90 MILS)	4 EA	350.00	1,400.00
0019	4725000000-E	1205	THERMOPLASTIC PAVEMENT MARKING SYMBOL (90 MILS)	4 EA	350.00	1,400.00

Line #	ItemNumber	Sec #	Description	Quantity Unit	Unit Bid Price	Amount Bid
0020	4850000000-E	1205	REMOVAL OF PAVEMENT MARKING LINES (4")	160 LF	8.00	1,280.00
0021	4870000000-E	1205	REMOVAL OF PAVEMENT MARKING LINES (24")	590 LF	5.75	3,392.50
0022	4875000000-N	1205	REMOVAL OF PAVEMENT MARKING SYMBOLS & CHARACTERS	7 EA	190.00	1,330.00
0023	4891000000-E	1205	GENERIC PAVEMENT MARKING ITEM THERMOPLASTIC PAVEMENT MARKING LINES (24", 90 MILS)	2,470 LF	13.00	32,110.00
0024	7048500000-E	1705	PEDESTRIAN SIGNAL HEAD (16", 1 SECTION W/COUNTDOWN)	58 EA	1,000.00	58,000.00
0025	7060000000-E	1705	SIGNAL CABLE	22,040 LF	3.75	82,650.00
0026	7120000000-E	1705	VEHICLE SIGNAL HEAD (12", 3 SECTION)	110 EA	820.00	90,200.00
0027	7132000000-E	1705	VEHICLE SIGNAL HEAD (12", 4 SECTION)	26 EA	1,100.00	28,600.00
0028	7144000000-E	1705	VEHICLE SIGNAL HEAD (12", 5 SECTION)	9 EA	1,500.00	13,500.00
0029	7252000000-E	1710	MESSENGER CABLE (1/4")	25,058 LF	3.40	85,197.20
0030	7264000000-E	1710	MESSENGER CABLE (3/8")	2,630 LF	5.50	14,465.00
0031	7279000000-E	1715	TRACER WIRE	44,687 LF	0.75	33,515.25
0032	7301000000-E	1715	DIRECTIONAL DRILL (*****) (1, 2")	80 LF	17.00	1,360.00
0033	7301000000-E	1715	DIRECTIONAL DRILL (*****) (2, 2")	19,145 LF	17.20	329,294.00
0034	7324000000-N	1716	JUNCTION BOX (STANDARD SIZE)	39 EA	300.00	11,700.00
0035	7348000000-N	1716	JUNCTION BOX (OVER-SIZED, HEAVY DUTY)	114 EA	565.00	64,410.00
0036	7372000000-N	1721	GUY ASSEMBLY	116 EA	725.00	84,100.00
0037	7396000000-E	1722	1/2" RISER WITH WEATHERHEAD	12 EA	700.00	8,400.00

Line #	ItemNumber	Sec #	Description	Quantity Unit	Unit Bid Price	Amount Bid
0038	7408000000-E	1722	1" RISER WITH WEATHERHEAD	1 EA	665.20	665.20
0039	7420000000-E	1722	2" RISER WITH WEATHERHEAD	26 EA	750.00	19,500.00
0040	7432000000-E	1722	2" RISER WITH HEAT SHRINK TUBING	38 EA	900.00	34,200.00
0041	7444000000-E	1725	INDUCTIVE LOOP SAWCUT	5,380 LF	9.00	48,420.00
0042	7456000000-E	1726	LEAD-IN CABLE (***** (14-2)	46,950 LF	2.15	100,942.50
0043	7516000000-E	1730	COMMUNICATIONS CABLE (**FIBER) (12)	14,785 LF	2.50	36,962.50
0044	7516000000-E	1730	COMMUNICATIONS CABLE (**FIBER) (48)	91,379 LF	3.00	274,137.00
0045	7528000000-E	1730	DROP CABLE	9,537 LF	2.40	22,888.80
0046	7540000000-N	1731	SPLICE ENCLOSURE	38 EA	1,500.00	57,000.00
0047	7552000000-N	1731	INTERCONNECT CENTER	44 EA	1,525.00	67,100.00
0048	7566000000-N	1733	DELINEATOR MARKER	67 EA	95.00	6,365.00
0049	7575142200-N	SP	NEW ELECTRICAL SERVICE	10 EA	1,800.00	18,000.00
0050	7575160000-E	1734	REMOVE EXISTING COMMUNICATIONS CABLE	13,318 LF	1.00	13,318.00
0051	7575180000-N	1735	CABLE TRANSFER	10 EA	360.00	3,600.00
0052	7576000000-N	SP	METAL STRAIN SIGNAL POLE	2 EA	17,150.00	34,300.00
0053	7613000000-N	SP	SOIL TEST	2 EA	3,000.00	6,000.00
0054	7614100000-E	SP	DRILLED PIER FOUNDATION	23.3 CY	1,700.00	39,610.00
0055	7636000000-N	1745	SIGN FOR SIGNALS	3 EA	600.00	1,800.00
0056	7642100000-N	1743	TYPE I POST WITH FOUNDATION	4 EA	1,700.00	6,800.00
0057	7642200000-N	1743	TYPE II PEDESTAL WITH FOUND- ATION	22 EA	1,975.00	43,450.00

Line #	ItemNumber	Sec #	Description	Quantity Unit	Unit Bid Price	Amount Bid
0058	7684000000-N	1750	SIGNAL CABINET FOUNDATION	8 EA	2,500.00	20,000.00
0059	7686000000-N	1752	CONDUIT ENTRANCE INTO EXISTING FOUNDATION	19 EA	600.00	11,400.00
0060	7708000000-N	1751	DETECTOR CARD (***** (MODEL 222)	282 EA	90.00	25,380.00
0061	7901000000-N	1753	CABINET BASE EXTENDER	44 EA	500.00	22,000.00
0062	7980000000-N	SP	GENERIC SIGNAL ITEM CCTV CAMERA ASSEMBLY	20 EA	4,900.00	98,000.00
0063	7980000000-N	SP	GENERIC SIGNAL ITEM CONTROLLER WITH CABINET WITH AUX FILE (2070LX, 332)	44 EA	12,500.00	550,000.00
0064	7980000000-N	SP	GENERIC SIGNAL ITEM DIGITAL DISPLAY MONITOR	1 EA	3,800.00	3,800.00
0065	7980000000-N	SP	GENERIC SIGNAL ITEM ETHERNET CORE SWITCH	1 EA	55,451.95	55,451.95
0066	7980000000-N	SP	GENERIC SIGNAL ITEM ETHERNET EDGE SWITCH	44 EA	1,700.00	74,800.00
0067	7980000000-N	SP	GENERIC SIGNAL ITEM FIREWALL	1 EA	5,000.00	5,000.00
0068	7980000000-N	SP	GENERIC SIGNAL ITEM FURNISH 2018 ENHANCED CONFLICT MONITOR	3 EA	1,200.00	3,600.00
0069	7980000000-N	SP	GENERIC SIGNAL ITEM FURNISH 2070 CONTROLLER TESTER	1 EA	8,000.00	8,000.00
0070	7980000000-N	SP	GENERIC SIGNAL ITEM FURNISH 2070LX CONTROLLER	3 EA	1,800.00	5,400.00
0071	7980000000-N	SP	GENERIC SIGNAL ITEM FURNISH 332 CABINET WITH AUX FILE	3 EA	9,000.00	27,000.00
0072	7980000000-N	SP	GENERIC SIGNAL ITEM FURNISH CCTV CAMERA ASSEMBLY	2 EA	3,500.00	7,000.00
0073	7980000000-N	SP	GENERIC SIGNAL ITEM FURNISH CONFLICT MONITOR TEST- ER	1 EA	27,000.00	27,000.00

Line #	ItemNumber	Sec #	Description	Quantity Unit	Unit Bid Price	Amount Bid
0074	7980000000-N	SP	GENERIC SIGNAL ITEM FURNISH ETHERNET EDGE SWITCH	3 EA	1,700.00	5,100.00
0075	7980000000-N	SP	GENERIC SIGNAL ITEM GUY ASSEMBLY - AERIAL	1 EA	1,000.00	1,000.00
0076	7980000000-N	SP	GENERIC SIGNAL ITEM GUY ASSEMBLY - SIDEWALK	8 EA	950.00	7,600.00
0077	7980000000-N	SP	GENERIC SIGNAL ITEM HEAT SHRINK TUBING KIT	12 EA	150.00	1,800.00
0078	7980000000-N	SP	GENERIC SIGNAL ITEM ITS SERVER	3 EA	10,000.00	30,000.00
0079	7980000000-N	SP	GENERIC SIGNAL ITEM JUNCTION BOX (SPECIAL-SIZED)	15 EA	950.00	14,250.00
0080	7980000000-N	SP	GENERIC SIGNAL ITEM JUNCTION BOX MARKER	46 EA	60.00	2,760.00
0081	7980000000-N	SP	GENERIC SIGNAL ITEM KVM SWITCH	1 EA	3,400.00	3,400.00
0082	7980000000-N	SP	GENERIC SIGNAL ITEM MODIFY COMMUNICATIONS RACK	1 EA	6,000.00	6,000.00
0083	7980000000-N	SP	GENERIC SIGNAL ITEM MODIFY EXISTING ELECTRICAL SERVICE	8 EA	500.00	4,000.00
0084	7980000000-N	SP	GENERIC SIGNAL ITEM MODIFY FOUNDATION FOR CONTROL- LER CABINET	6 EA	1,250.00	7,500.00
0085	7980000000-N	SP	GENERIC SIGNAL ITEM POLE GROUNDING SYSTEM	71 EA	280.00	19,880.00
0086	7980000000-N	SP	GENERIC SIGNAL ITEM POWDER COAT FOR STRAIN POLE (BLACK)	2 EA	1,001.00	2,002.00
0087	7980000000-N	SP	GENERIC SIGNAL ITEM PTZ JOYSTICK	1 EA	1,200.00	1,200.00
0088	7980000000-N	SP	GENERIC SIGNAL ITEM RELOCATE EXISTING CABINET EQUIPMENT	30 EA	100.00	3,000.00

Line #	ItemNumber	Sec #	Description	Quantity Unit	Unit Bid Price	Amount Bid
0089	7980000000-N	SP	GENERIC SIGNAL ITEM SIGNAL SYSTEM SUPERVISOR'S COMPUTER SYSTEM	1 EA	6,500.00	6,500.00
0090	7980000000-N	SP	GENERIC SIGNAL ITEM SPAN TRANSFER	69 EA	60.00	4,140.00
0091	7980000000-N	SP	GENERIC SIGNAL ITEM TYPE 332 TEST CONTROLLER WITH CABINET	1 EA	15,000.00	15,000.00
0092	7980000000-N	SP	GENERIC SIGNAL ITEM UPS IN COMMUNICATIONS RACK	1 EA	8,300.00	8,300.00
0093	7980000000-N	SP	GENERIC SIGNAL ITEM WOOD POLE FOR SIGNALS	9 EA	1,500.00	13,500.00
0094	7980000000-N	SP	GENERIC SIGNAL ITEM WOOD POLE FOR SIGNALS WITH CCTV	13 EA	3,700.00	48,100.00
0095	7985000000-N	SP	GENERIC SIGNAL ITEM CCTV SOFTWARE	Lump Sum LS	14,000.00	14,000.00
0096	7985000000-N	SP	GENERIC SIGNAL ITEM NETWORK MANAGEMENT SOFTWARE	Lump Sum LS	16,650.00	16,650.00
0097	7985000000-N	SP	GENERIC SIGNAL ITEM SIGNAL SYSTEM SOFTWARE	Lump Sum LS	285,000.00	285,000.00
0098	7985000000-N	SP	GENERIC SIGNAL ITEM SYSTEM SUPPORT SOFTWARE & DEVICES	Lump Sum LS	28,000.00	28,000.00
0099	7985000000-N	SP	GENERIC SIGNAL ITEM TMC BUILDING MODIFICATIONS	Lump Sum LS	32,260.60	32,260.60
0100	7985000000-N	SP	GENERIC SIGNAL ITEM TRAINING	Lump Sum LS	71,507.00	71,507.00
0101	7990000000-E	SP	GENERIC SIGNAL ITEM AERIAL CABLE PROTECTOR	75 LF	20.00	1,500.00
0102	7990000000-E	SP	GENERIC SIGNAL ITEM ETHERNET CABLE	3,787 LF	4.50	17,041.50
0103	7990000000-E	SP	GENERIC SIGNAL ITEM UNDERGROUND CONDUIT (1, 1")	185 LF	10.50	1,942.50
0104	7990000000-E	SP	GENERIC SIGNAL ITEM UNDERGROUND CONDUIT (1, 2")	1,955 LF	10.50	20,527.50

## Contract Item Sheets For C204648

Line #	ItemNumber	Sec #	Description	Quantity Unit	Unit Bid Price	Amount Bid
0105	7990000000-E	SP	GENERIC SIGNAL ITEM UNDERGROUND CONDUIT (2, 2")	24,158 LF	9.50	229,501.00
0106	7990000000-E	SP	GENERIC SIGNAL ITEM UNDERGROUND CONDUIT (3, 2")	40 LF	40.00	1,600.00
0107	7991000000-E	SP	GENERIC SIGNAL ITEM BRICK PAVERS	8 SF	340.00	2,720.00

---

**TOTAL AMOUNT OF BID FOR ENTIRE PROJECT****\$4,399,018.00**

---

**1226/Jul01/Q331663.3/D749105482200/E107**



**NON-COLLUSION, DEBARMENT CERTIFICATION AND GIFT BAN CERTIFICATION**

**LIMITED LIABILITY COMPANY**

The prequalified bidder, declares (or certifies, verifies, or states) under penalty of perjury under the laws of the United States that neither he, nor any official, agent or employee has entered into any agreement, participated in any collusion, or otherwise taken any action which is in restraint of free competitive bidding in connection with any bid or contract, that the prequalified bidder has not been convicted of violating *N.C.G.S. § 133-24* within the last three years, and that the prequalified bidder intends to do the work with its own bonafide employees or subcontractors and will not bid for the benefit of another contractor.

By submitting this non-collusion, debarment and gift ban certification, the Contractor is attesting his status under penalty of perjury under the laws of the United States in accordance with the Debarment Certification attached, provided that the Debarment Certification also includes any required statements concerning exceptions that are applicable.

*N.C.G.S. § 133-32* and Executive Order 24 prohibit the offer to, or acceptance by, any State Employee of any gift from anyone with a contract with the State, or from any person seeking to do business with the State. By execution of any response in this procurement, you attest, for your entire organization and its employees or agents, that you are not aware that any such gift has been offered, accepted, or promised by any employees of your organization.

**SIGNATURE OF PREQUALIFIED BIDDER**

ALS of North Carolina, LLC

Full Name of Firm

502 Klumac Road Salisbury, NC 28144

Address as Prequalified



Signature of Witness



Signature of ~~Member~~/Manager/Authorized Agent  
Select appropriate title

Julie Coleman

Print or type Signer's name

Ronald R. Hallock

Print or type Signer's Name

## DEBARMENT CERTIFICATION

### Conditions for certification:

1. The prequalified bidder shall provide immediate written notice to the Department if at any time the bidder learns that his certification was erroneous when he submitted his debarment certification or explanation filed with the Department, or has become erroneous because of changed circumstances.
2. The terms *covered transaction, debarred, suspended, ineligible, lower tier covered transaction, participant, person, primary covered transaction, principal, proposal, and voluntarily excluded*, as used in this provision, have the meanings set out in the Definitions and Coverage sections of the rules implementing Executive Order 12549. A copy of the Federal Rules requiring this certification and detailing the definitions and coverages may be obtained from the Contract Officer of the Department.
3. The prequalified bidder agrees by submitting this form, that he will not knowingly enter into any lower tier covered transaction with a person who is debarred, suspended, declared ineligible, or voluntarily excluded from participation in NCDOT contracts, unless authorized by the Department.
4. For Federal Aid projects, the prequalified bidder further agrees that by submitting this form he will include the Federal-Aid Provision titled *Required Contract Provisions Federal-Aid Construction Contract (Form FHWA PR 1273)* provided by the Department, without subsequent modification, in all lower tier covered transactions.
5. The prequalified bidder may rely upon a certification of a participant in a lower tier covered transaction that he is not debarred, suspended, ineligible, or voluntarily excluded from the covered transaction, unless he knows that the certification is erroneous. The bidder may decide the method and frequency by which he will determine the eligibility of his subcontractors.
6. Nothing contained in the foregoing shall be construed to require establishment of a system of records in order to render in good faith the certification required by this provision. The knowledge and information of a participant is not required to exceed that which is normally possessed by a prudent person in the ordinary course of business dealings.
7. Except as authorized in paragraph 6 herein, the Department may terminate any contract if the bidder knowingly enters into a lower tier covered transaction with a person who is suspended, debarred, ineligible, or voluntarily excluded from participation in this transaction, in addition to other remedies available by the Federal Government.

### DEBARMENT CERTIFICATION

The prequalified bidder certifies to the best of his knowledge and belief, that he and his principals:

- a. Are not presently debarred, suspended, proposed for debarment, declared ineligible, or voluntarily excluded from covered transactions by any Federal department or agency;
- b. Have not within a three-year period preceding this proposal been convicted of or had a civil judgment rendered against them for commission of fraud or a criminal offense in connection with obtaining, attempting to obtain, or performing a public (Federal, State or local) transaction or contract under a public transaction; violation of Federal or State antitrust statutes or commission of embezzlement, theft, forgery, bribery, falsification or destruction of records; making false statements; or receiving stolen property;
- c. Are not presently indicted for or otherwise criminally or civilly charged by a governmental entity (Federal, State or local) with commission of any of the offenses enumerated in paragraph b. of this certification; and
- d. Have not within a three-year period preceding this proposal had one or more public transactions (Federal, State or local) terminated for cause or default.
- e. Will submit a revised Debarment Certification immediately if his status changes and will show in his bid proposal an explanation for the change in status.

If the prequalified bidder cannot certify that he is not debarred, he shall provide an explanation with this submittal. An explanation will not necessarily result in denial of participation in a contract.

Failure to submit a non-collusion and debarment certification will result in the prequalified bidder's bid being considered non-responsive.

Check here if an explanation is attached to this certification.

**Contract No.**     **C204648**

**County (ies):**    **Pasquotank**

ACCEPTED BY THE  
DEPARTMENT OF TRANSPORTATION

DocuSigned by:  
*Ronald E. Davenport, Jr.*  
F81B6038A47A442...  
\_\_\_\_\_  
Contract Officer

7/13/2021  
\_\_\_\_\_  
Date

Execution of Contract and Bonds  
Approved as to Form:

DocuSigned by:  
*Thomas H. Moore*  
A2E31ABDC19E410...  
\_\_\_\_\_  
Attorney General

7/13/2021  
\_\_\_\_\_  
Date

Bond No. 107461946

**CONTRACT PAYMENT BOND**

Date of Payment Bond Execution

Name of Principal Contractor

**ALS of North Carolina, LLC**

Name of Surety:

TRAVELERS CASUALTY AND SURETY COMPANY OF AMERICA

Name of Contracting Body:

**North Carolina Department of Transportation**

**Raleigh, North Carolina**

Amount of Bond:

**4,399,018.00**

Contract ID No.:

**C204648**

County Name:

**Pasquotank**

KNOW ALL MEN BY THESE PRESENTS, That we, the PRINCIPAL CONTRACTOR (hereafter, PRINCIPAL) and SURETY above named, are held and firmly bound unto the above named Contracting Body, hereinafter called the Contracting Body, in the penal sum of the amount stated above for the payment of which sum well and truly to be made, we bind ourselves, our heirs, executors, administrators, and successors, jointly and severally, firmly by these presents.

THE CONDITION OF THIS OBLIGATION IS SUCH, that whereas the principal entered into a certain contract with the Contracting Body, numbered as shown above and hereto attached:

NOW THEREFORE, if the principal shall promptly make payment to all persons supplying labor and material in the prosecution of the work provided for in said contract, and any and all duly authorized modifications of said contract that may hereafter be made, notice of which modifications to the surety being hereby waived, then this obligation to be void; otherwise to remain in full force and virtue.

IN WITNESS WHEREOF, the above-bound parties have executed this instrument under their several seals on the date indicated above, the name and corporate seal of each corporate party being hereto affixed and these presents duly signed by its undersigned representative, pursuant to authority of its governing body.

Contract No.  
County

# C204648

Pasquotank

Rev 5-17-11

## CONTRACT PAYMENT BOND

*Affix Seal of Surety Company*

TRAVELERS CASUALTY AND SURETY COMPANY OF AMERICA  
Print or type Surety Company Name

By Patricia A. Rambo, Attorney-in-Fact  
Print, stamp or type name of Attorney-in-Fact



Signature of Attorney-in-Fact



Signature of Witness



Sara Owens

Print or type Signer's name

1650 Market Street, Philadelphia, PA 19102

Address of Attorney-in-Fact

## CONTRACT PAYMENT BOND

### LIMITED LIABILITY COMPANY

SIGNATURE OF CONTRACTOR (Principal)

Name of Contractor

# ALS of North Carolina, LLC

Full name of Firm

## 502 Klumac Road Salisbury, NC 28144

Address as prequalified

By:



Signature of ~~Member~~, **Manager**, Authorized Agent  
*Select appropriate title*

Ann P. Ercolani, Asst. Sec. (Ins./Bonds)

Print or type Signer's name



Bond No 107461946

**CONTRACT PERFORMANCE BOND**

Date of Performance Bond Execution: July 1, 2021

Name of Principal Contractor:

ALS of North Carolina, LLC

Name of Surety:

TRAVELERS CASUALTY AND SURETY COMPANY OF AMERICA

Name of Contracting Body:

North Carolina Department of Transportation

Raleigh, North Carolina

Amount of Bond:

4,399,018.00

Contract ID No.:

C204648

County Name:

Pasquotank

KNOW ALL MEN BY THESE PRESENTS, That we, the PRINCIPAL CONTRACTOR (hereafter, PRINCIPAL) and SURETY above named, are held and firmly bound unto the above named Contracting Body, hereinafter called the Contracting Body, in the penal sum of the amount stated above for the payment of which sum well and truly to be made, we bind ourselves, our heirs, executors, administrators, and successors, jointly and severally, firmly by these presents.

THE CONDITION OF THIS OBLIGATION IS SUCH, that whereas the principal entered into a certain contract with the Contracting Body, numbered as shown above and hereto attached:

NOW THEREFORE, if the principal shall well and truly perform and fulfill all the undertakings, covenants, terms, conditions, and agreements of said contract during the original term of said contract and any extensions thereof that may be granted by the Contracting Body, with or without notice to the Surety, and during the life of any guaranty required under the contract, and shall also well and truly perform and fulfill all the undertakings, covenants, terms, conditions, and agreements of any and all duly authorized modifications of said contract that may hereafter be made, notice of which modifications to the surety being hereby waived, then this obligation to be void; otherwise to remain in full force and virtue.

IN WITNESS WHEREOF, the above-bound parties have executed this instrument under their several seals on the date indicated above, the name and corporate seal of each corporate party being hereto affixed and these presents duly signed by its undersigned representative, pursuant to authority of its governing body.



Contract No.  
County

**C204648**

Pasquotank

Rev 5-17-11

**CONTRACT PERFORMANCE BOND**

*Affix Seal of Surety Company*

TRAVELERS CASUALTY AND SURETY COMPANY OF AMERICA

Print or type Surety Company Name

By Patricia A. Rambo, Attorney-in-Fact

Print, stamp or type name of Attorney-in-Fact

*Patricia A. Rambo*

Signature of Attorney-in-Fact



*Sara Owens*

Signature of Witness

Sara Owens

Print or type Signer's name

1650 Market Street, Philadelphia, PA 19120

Address of Attorney-in-Fact

**CONTRACT PERFORMANCE BOND**

**LIMITED LIABILITY COMPANY**

SIGNATURE OF CONTRACTOR (Principal)

Name of Contractor

**ALS of North Carolina, LLC**

Full name of Firm

**502 Klumac Road Salisbury, NC 28144**

Address as prequalified

By:



Signature of ~~Member~~, ~~Manager~~, Authorized Agent

Select appropriate title

Ann P. Ercolani, Asst. Sec. (Ins./Bonds)

Print or type Signer's name





**Travelers Casualty and Surety Company of America  
Travelers Casualty and Surety Company  
St. Paul Fire and Marine Insurance Company**

**POWER OF ATTORNEY**

**KNOW ALL MEN BY THESE PRESENTS:** That Travelers Casualty and Surety Company of America, Travelers Casualty and Surety Company, and St. Paul Fire and Marine Insurance Company are corporations duly organized under the laws of the State of Connecticut (herein collectively called the "Companies"), and that the Companies do hereby make, constitute and appoint **Patricia A. Rambo of Philadelphia, Pennsylvania** their true and lawful Attorney-in-Fact to sign, execute, seal and acknowledge any and all bonds, recognizances, conditional undertakings and other writings obligatory in the nature thereof on behalf of the Companies in their business of guaranteeing the fidelity of persons, guaranteeing the performance of contracts and executing or guaranteeing bonds and undertakings required or permitted in any actions or proceedings allowed by law.

**IN WITNESS WHEREOF**, the Companies have caused this instrument to be signed, and their corporate seals to be hereto affixed, this **3rd** day of **February**, 2017.



State of Connecticut

City of Hartford ss.

By:   
Robert L. Raney, Senior Vice President

On this the **3rd** day of **February**, 2017, before me personally appeared **Robert L. Raney**, who acknowledged himself to be the Senior Vice President of Travelers Casualty and Surety Company of America, Travelers Casualty and Surety Company, and St. Paul Fire and Marine Insurance Company, and that he, as such, being authorized so to do, executed the foregoing instrument for the purposes therein contained by signing on behalf of the corporations by himself as a duly authorized officer.

**In Witness Whereof**, I hereunto set my hand and official seal.

My Commission expires the **30th** day of **June**, 2021



Marie C. Tetreault, Notary Public

This Power of Attorney is granted under and by the authority of the following resolutions adopted by the Boards of Directors of Travelers Casualty and Surety Company of America, Travelers Casualty and Surety Company, and St. Paul Fire and Marine Insurance Company, which resolutions are now in full force and effect, reading as follows:

**RESOLVED**, that the Chairman, the President, any Vice Chairman, any Executive Vice President, any Senior Vice President, any Vice President, any Second Vice President, the Treasurer, any Assistant Treasurer, the Corporate Secretary or any Assistant Secretary may appoint Attorneys-in-Fact and Agents to act for and on behalf of the Company and may give such appointee such authority as his or her certificate of authority may prescribe to sign with the Company's name and seal with the Company's seal bonds, recognizances, contracts of indemnity, and other writings obligatory in the nature of a bond, recognizance, or conditional undertaking, and any of said officers or the Board of Directors at any time may remove any such appointee and revoke the power given him or her; and it is

**FURTHER RESOLVED**, that the Chairman, the President, any Vice Chairman, any Executive Vice President, any Senior Vice President or any Vice President may delegate all or any part of the foregoing authority to one or more officers or employees of this Company, provided that each such delegation is in writing and a copy thereof is filed in the office of the Secretary; and it is

**FURTHER RESOLVED**, that any bond, recognizance, contract of indemnity, or writing obligatory in the nature of a bond, recognizance, or conditional undertaking shall be valid and binding upon the Company when (a) signed by the President, any Vice Chairman, any Executive Vice President, any Senior Vice President or any Vice President, any Second Vice President, the Treasurer, any Assistant Treasurer, the Corporate Secretary or any Assistant Secretary and duly attested and sealed with the Company's seal by a Secretary or Assistant Secretary; or (b) duly executed (under seal, if required) by one or more Attorneys-in-Fact and Agents pursuant to the power prescribed in his or her certificate or their certificates of authority or by one or more Company officers pursuant to a written delegation of authority; and it is

**FURTHER RESOLVED**, that the signature of each of the following officers: President, any Executive Vice President, any Senior Vice President, any Vice President, any Assistant Vice President, any Secretary, any Assistant Secretary, and the seal of the Company may be affixed by facsimile to any Power of Attorney or to any certificate relating thereto appointing Resident Vice Presidents, Resident Assistant Secretaries or Attorneys-in-Fact for purposes only of executing and attesting bonds and undertakings and other writings obligatory in the nature thereof, and any such Power of Attorney or certificate bearing such facsimile signature or facsimile seal shall be valid and binding upon the Company and any such power so executed and certified by such facsimile signature and facsimile seal shall be valid and binding on the Company in the future with respect to any bond or understanding to which it is attached.

I, **Kevin E. Hughes**, the undersigned, Assistant Secretary of Travelers Casualty and Surety Company of America, Travelers Casualty and Surety Company, and St. Paul Fire and Marine Insurance Company, do hereby certify that the above and foregoing is a true and correct copy of the Power of Attorney executed by said Companies, which remains in full force and effect.

Dated this **1st** day of **JULY**, 2021



Kevin E. Hughes, Assistant Secretary

**To verify the authenticity of this Power of Attorney, please call us at 1-800-421-3880.  
Please refer to the above-named Attorney-in-Fact and the date of this bond to which the power is attached.**