

STATE OF NORTH CAROLINA  
DEPARTMENT OF TRANSPORTATION  
RALEIGH, N.C.

C204729

CONTRACT AND  
CONTRACT BONDS  
FOR CONTRACT NO. C204729

WBS 48811.3.1 1560005

T.I.P NO. U-6223

COUNTY OF JOHNSTON

THIS IS THE ROADWAY CONTRACT

ROUTE NUMBER SR-1560 LENGTH 0.692 MILES

LOCATION SR-1560 (RANCH RD EXT) FROM US-70 BUS/NC-42 TO EXISTING RANCH RD  
IN CLAYTON.

CONTRACTOR FSC II LLC DBA FRED SMITH COMPANY

ADDRESS 701 CORPORATE CENTER DRIVE  
STE 101  
RALEIGH, NC 27607

BIDS OPENED JULY 19, 2022

CONTRACT EXECUTION 09/28/2022

STATE OF NORTH CAROLINA  
DEPARTMENT OF TRANSPORTATION  
RALEIGH, N.C.

PROPOSAL

**INCLUDES ADDENDUM No.1 DATED 07-08-2022**

DATE AND TIME OF BID OPENING: **Jul 19, 2022 AT 02:00 PM**

CONTRACT ID C204729  
WBS 48811.3.1

FEDERAL-AID NO. 1560005  
COUNTY JOHNSTON  
T.I.P NO. U-6223  
MILES 0.692  
ROUTE NO. SR-1560  
LOCATION SR-1560 (RANCH RD EXT) FROM US-70 BUS/NC-42 TO EXISTING RANCH RD IN CLAYTON.

TYPE OF WORK GRADING, DRAINAGE, PAVING, AND WALLS.

**NOTICE:**

ALL BIDDERS SHALL COMPLY WITH ALL APPLICABLE LAWS REGULATING THE PRACTICE OF GENERAL CONTRACTING AS CONTAINED IN CHAPTER 87 OF THE GENERAL STATUTES OF NORTH CAROLINA WHICH REQUIRES THE BIDDER TO BE LICENSED BY THE N.C. LICENSING BOARD FOR CONTRACTORS WHEN BIDDING ON ANY NON-FEDERAL AID PROJECT WHERE THE BID IS \$30,000 OR MORE, EXCEPT FOR CERTAIN SPECIALTY WORK AS DETERMINED BY THE LICENSING BOARD. BIDDERS SHALL ALSO COMPLY WITH ALL OTHER APPLICABLE LAWS REGULATING THE PRACTICES OF ELECTRICAL, PLUMBING, HEATING AND AIR CONDITIONING AND REFRIGERATION CONTRACTING AS CONTAINED IN CHAPTER 87 OF THE GENERAL STATUTES OF NORTH CAROLINA. NOTWITHSTANDING THESE LIMITATIONS ON BIDDING, THE BIDDER WHO IS AWARDED ANY FEDERAL - AID FUNDED PROJECT SHALL COMPLY WITH CHAPTER 87 OF THE GENERAL STATUTES OF NORTH CAROLINA FOR LICENSING REQUIREMENTS WITHIN 60 CALENDAR DAYS OF BID OPENING.

**BIDS WILL BE RECEIVED AS SHOWN BELOW:**

**THIS IS A ROADWAY PROPOSAL**

**5% BID BOND OR BID DEPOSIT REQUIRED**

---

**PROPOSAL FOR THE CONSTRUCTION OF  
CONTRACT No. C204729 IN JOHNSTON COUNTY, NORTH CAROLINA**

Date \_\_\_\_\_ 20 \_\_\_\_\_

**DEPARTMENT OF TRANSPORTATION,  
RALEIGH, NORTH CAROLINA**

The Bidder has carefully examined the location of the proposed work to be known as Contract No. C204729 has carefully examined the plans and specifications, which are acknowledged to be part of the proposal, the special provisions, the proposal, the form of contract, and the forms of contract payment bond and contract performance bond; and thoroughly understands the stipulations, requirements and provisions. The undersigned bidder agrees to bound upon his execution of the bid and subsequent award to him by the Board of Transportation in accordance with this proposal to provide the necessary contract payment bond and contract performance bond within fourteen days after the written notice of award is received by him. The undersigned Bidder further agrees to provide all necessary machinery, tools, labor, and other means of construction; and to do all the work and to furnish all materials, except as otherwise noted, necessary to perform and complete the said contract in accordance with *the 2018 Standard Specifications for Roads and Structures* by the dates(s) specified in the Project Special Provisions and in accordance with the requirements of the Engineer, and at the unit or lump sum prices, as the case may be, for the various items given on the sheets contained herein.

The Bidder shall provide and furnish all the materials, machinery, implements, appliances and tools, and perform the work and required labor to construct and complete State Highway Contract No. C204729 in Johnston County, for the unit or lump sum prices, as the case may be, bid by the Bidder in his bid and according to the proposal, plans, and specifications prepared by said Department, which proposal, plans, and specifications show the details covering this project, and hereby become a part of this contract.

The published volume entitled *North Carolina Department of Transportation, Raleigh, Standard Specifications for Roads and Structures, January 2018* with all amendments and supplements thereto, is by reference incorporated into and made a part of this contract; that, except as herein modified, all the construction and work included in this contract is to be done in accordance with the specifications contained in said volume, and amendments and supplements thereto, under the direction of the Engineer.

If the proposal is accepted and the award is made, the contract is valid only when signed either by the Contract Officer or such other person as may be designated by the Secretary to sign for the Department of Transportation. The conditions and provisions herein cannot be changed except over the signature of the said Contract Officer.

The quantities shown in the itemized proposal for the project are considered to be approximate only and are given as the basis for comparison of bids. The Department of Transportation may increase or decrease the quantity of any item or portion of the work as may be deemed necessary or expedient.

An increase or decrease in the quantity of an item will not be regarded as sufficient ground for an increase or decrease in the unit prices, nor in the time allowed for the completion of the work, except as provided for the contract.

Accompanying this bid is a bid bond secured by a corporate surety, or certified check payable to the order of the Department of Transportation, for five percent of the total bid price, which deposit is to be forfeited as liquidated damages in case this bid is accepted and the Bidder shall fail to provide the required payment and performance bonds with the Department of Transportation, under the condition of this proposal, within 14 calendar days after the written notice of award is received by him, as provided in the *Standard Specifications*; otherwise said deposit will be returned to the Bidder.



*State Contract Officer*

DocuSigned by:

*Ronald Elton Davenport, Jr.*

F81B6038A47A442...

07/08/2022

**TABLE OF CONTENTS**

**COVER SHEET**  
**PROPOSAL SHEET**

**PROJECT SPECIAL PROVISIONS**

INTERESTED PARTIES LIST ..... G-1  
 CONTRACT TIME AND LIQUIDATED DAMAGES: ..... G-1  
 INTERMEDIATE CONTRACT TIME NUMBER 1 AND LIQUIDATED DAMAGES: ..... G-2  
 INTERMEDIATE CONTRACT TIME NUMBER 2 AND LIQUIDATED DAMAGES: ..... G-2  
 INTERMEDIATE CONTRACT TIME NUMBER 3 AND LIQUIDATED DAMAGES: ..... G-3  
 PERMANENT VEGETATION ESTABLISHMENT:..... G-4  
 DELAY IN RIGHT OF ENTRY: ..... G-5  
 MAJOR CONTRACT ITEMS: ..... G-5  
 SPECIALTY ITEMS: ..... G-5  
 FUEL PRICE ADJUSTMENT:..... G-5  
 STEEL PRICE ADJUSTMENT:..... G-6  
 SCHEDULE OF ESTIMATED COMPLETION PROGRESS:..... G-17  
 DISADVANTAGED BUSINESS ENTERPRISE: ..... G-17  
 CERTIFICATION FOR FEDERAL-AID CONTRACTS: ..... G-31  
 CONTRACTOR'S LICENSE REQUIREMENTS: ..... G-31  
 RESTRICTIONS ON ITS EQUIPMENT AND SERVICES:..... G-31  
 USE OF UNMANNED AIRCRAFT SYSTEM (UAS): ..... G-32  
 EQUIPMENT IDLING GUIDELINES:..... G-32  
 U.S. DEPARTMENT OF TRANSPORTATION HOTLINE: ..... G-33  
 CARGO PREFERENCE ACT: ..... G-33  
 SUBSURFACE INFORMATION:..... G-34  
 MAINTENANCE OF THE PROJECT: ..... G-34  
 ELECTRONIC BIDDING:..... G-35  
 AWARD LIMITS: ..... G-35  
 TWELVE MONTH GUARANTEE: ..... G-35  
 EROSION AND SEDIMENT CONTROL/STORMWATER CERTIFICATION: ..... G-36  
 PROCEDURE FOR MONITORING BORROW PIT DISCHARGE:..... G-41  
  
 ROADWAY .....R-1

**STANDARD SPECIAL PROVISIONS**

AVAILABILITY FUNDS – TERMINATION OF CONTRACTS ..... SSP-1  
 NCDOT GENERAL SEED SPECIFICATION FOR SEED QUALITY ..... SSP-2  
 ERRATA..... SSP-5  
 PLANT AND PEST QUARANTINES ..... SSP-7  
 TITLE VI AND NONDISCRIMINATION ..... SSP-8  
 MINORITY AND FEMALE EMPLOYMENT REQUIREMENTS ..... SSP-16  
 REQUIRED CONTRACT PROVISIONS FEDERAL-AID CONST. CONTRACTS ..... SSP-19  
 ON-THE-JOB TRAINING ..... SSP-28  
 MINIMUM WAGES ..... SSP-31

**UNIT PROJECT SPECIAL PROVISIONS**

GEOTECHNICAL .....GT-0.1  
 TRAFFIC CONTROL ..... TC-1  
 UTILITY CONSTRUCTION ..... UC-1  
 UTILITY BY OTHERS .....UBO-1  
 EROSION CONTROL ..... EC-1  
 TRAFFIC SIGNALS ..... TS-1  
 STRUCTURE / CULVERTS..... SBW-1

**PERMITS** .....P-1

**PROPOSAL ITEM SHEET**

ITEM SHEET(S) (TAN SHEETS)

**PROJECT SPECIAL PROVISIONS****GENERAL****INTERESTED PARTIES LIST:**

(6-21-22)(Rev. 7-19-22)

102

SP1 G02

Revise the *2018 Standard Specifications* as follows:

**Page 1-12, Article 102-3 PROPOSALS AND PLAN HOLDER LISTS**, lines 45-49, delete and replace with the following:

**102-3 PROPOSALS AND INTERESTED PARTIES LIST**

On Department projects advertised, the prospective bidder shall sign up on the *Interested Parties List* no later than one business day prior to the Letting day of that project, for which he intends to submit a bid. There is no cost for signing up on the *Interested Parties List* that can be found on the Department's website at [connect.ncdot.gov/letting](http://connect.ncdot.gov/letting).

**Page 1-12, Article 102-3 PROPOSALS AND PLAN HOLDER LISTS**, lines 1-3, delete and replace the first sentence of the second paragraph with the following:

The proposal will state the location of the contemplated construction and show a schedule of contract items with the approximate quantity of each of these items for which bid prices are invited.

**Page 1-14, Article 102-8 PREPARATION AND SUBMISSION OF BIDS**, lines 30-31, delete and replace the first paragraph with the following:

Prior to submitting a bid on a project, the bidder shall sign up on the *Interested Parties List* in conformance with Article 102-3. The bidder shall submit a unit or lump sum price for every item in the proposal other than items that are authorized alternates to those items for which a bid price has been submitted.

**CONTRACT TIME AND LIQUIDATED DAMAGES:**

(8-15-00) (Rev. 12-18-07)

108

SP1 G07 A

The date of availability for this contract is **November 28, 2022**, except that work in jurisdictional waters and wetlands shall not begin until a meeting between the DOT, Regulatory Agencies, and the Contractor is held as stipulated in the permits contained elsewhere in this proposal. This delay in availability has been considered in determining the contract time for this project.

The completion date for this contract is **October 29, 2025**.

Except where otherwise provided by the contract, observation periods required by the contract will not be a part of the work to be completed by the completion date and/or intermediate contract times stated in the contract. The acceptable completion of the observation periods that extend beyond the final completion date shall be a part of the work covered by the performance and payment bonds.

The liquidated damages for this contract are **Two Hundred Dollars (\$ 200.00)** per calendar day. These liquidated damages will not be cumulative with any liquidated damages which may become chargeable under Intermediate Contract Time Number 1.

**INTERMEDIATE CONTRACT TIME NUMBER 1 AND LIQUIDATED DAMAGES:**

(7-1-95) (Rev. 2-21-12)

108

SP1 G13 A

Except for that work required under the Project Special Provisions entitled *Planting, Reforestation* and/or *Permanent Vegetation Establishment*, included elsewhere in this proposal, the Contractor will be required to complete all work included in this contract and shall place and maintain traffic on same.

The date of availability for this intermediate contract time is **November 28, 2022**.

The completion date for this intermediate contract time is **May 1, 2025**.

The liquidated damages for this intermediate contract time are **One Thousand Five Hundred Dollars (\$ 1,500.00)** per calendar day.

Upon apparent completion of all the work required to be completed by this intermediate date, a final inspection will be held in accordance with Article 105-17 and upon acceptance, the Department will assume responsibility for the maintenance of all work except *Planting, Reforestation* and/or *Permanent Vegetation Establishment*. The Contractor will be responsible for and shall make corrections of all damages to the completed roadway caused by his planting operations, whether occurring prior to or after placing traffic through the project.

**INTERMEDIATE CONTRACT TIME NUMBER 2 AND LIQUIDATED DAMAGES:**

(2-20-07)

108

SP1 G14 A

The Contractor shall complete the required work of installing, maintaining, and removing the traffic control devices for lane closures and restoring traffic to the existing traffic pattern. The Contractor shall not close or narrow a lane of traffic on **US 70 Business** during the following time restrictions:

**DAY AND TIME RESTRICTIONS**

**Monday thru Sunday, 6:00 a.m. to 8:30 p.m.**

In addition, the Contractor shall not close or narrow a lane of traffic on **SR 1560, SR 1563, Rose Street and/or US 70 Business**, detain and/or alter the traffic flow on or during holidays, holiday weekends, special events, or any other time when traffic is unusually heavy, including the following schedules:

**HOLIDAY AND HOLIDAY WEEKEND LANE CLOSURE RESTRICTIONS**

1. For **unexpected occurrence** that creates unusually high traffic volumes, as directed by the Engineer.

2. For **New Year's Day**, between the hours of **6:00 a.m.** December 31<sup>st</sup> and **8:30 p.m.** January 2<sup>nd</sup>. If New Year's Day is on a Friday, Saturday, Sunday or Monday, then until **8:30 p.m.** the following Tuesday.
3. For **Easter**, between the hours of **6:00 a.m.** Thursday and **8:30 p.m.** Monday.
4. For **Memorial Day**, between the hours of **6:00 a.m.** Friday and **8:30 p.m.** Tuesday.
5. For **Independence Day**, between the hours of **6:00 a.m.** the day before Independence Day and **8:30 p.m.** the day after Independence Day.  
  
If **Independence Day** is on a Friday, Saturday, Sunday or Monday, then between the hours of **6:00 a.m.** the Thursday before Independence Day and **8:30 p.m.** the Tuesday after Independence Day.
6. For **Labor Day**, between the hours of **6:00 a.m.** Friday and **8:30 p.m.** Tuesday.
7. For **Thanksgiving**, between the hours of **6:00 a.m.** Tuesday and **8:30 p.m.** Monday.
8. For **Christmas**, between the hours of **6:00 a.m.** the Friday before the week of Christmas Day and **8:30 p.m.** the following Tuesday after the week of Christmas Day.

Holidays and holiday weekends shall include New Year's, Easter, Memorial Day, Independence Day, Labor Day, Thanksgiving, and Christmas. The Contractor shall schedule his work so that lane closures will not be required during these periods, unless otherwise directed by the Engineer.

The time of availability for this intermediate contract work shall be the time the Contractor begins to install all traffic control devices for lane closures according to the time restrictions listed herein.

The completion time for this intermediate contract work shall be the time the Contractor is required to complete the removal of all traffic control devices for lane closures according to the time restrictions stated above and place traffic in the existing traffic pattern.

The liquidated damages are **One Thousand Two Hundred Fifty Dollars (\$ 1,250.00)** per fifteen **(15)** minute time period.

**INTERMEDIATE CONTRACT TIME NUMBER 3 AND LIQUIDATED DAMAGES:**

(2-20-07)

108

SP1 G14 C

The Contractor shall complete the required work of installing, maintaining and removing the traffic control devices for lane closures and restoring traffic to the existing traffic pattern. The Contractor shall not close or narrow a lane of traffic on **SR 1560, SR 1563 and/or Rose Street** during the following time restrictions:

DAY AND TIME RESTRICTIONS

**Monday thru Friday, 6:00 a.m. to 9:00 a.m. and 4:00 p.m. to 7:00 p.m.**



The time of availability for this intermediate contract time will be the time the Contractor begins to install traffic control devices required for the lane closures according to the time restrictions stated herein.

The completion time for this intermediate contract time will be the time the Contractor is required to complete the removal of traffic control devices required for the lane closures according to the time restrictions stated herein and restore traffic to the existing traffic pattern.

The liquidated damages are **Two Hundred Fifty Dollars (\$ 250.00)** per hour.

**PERMANENT VEGETATION ESTABLISHMENT:**

(2-16-12) (Rev. 10-15-13)

104

SP1 G16

Establish a permanent stand of the vegetation mixture shown in the contract. During the period between initial vegetation planting and final project acceptance, perform all work necessary to establish permanent vegetation on all erodible areas within the project limits, as well as, in borrow and waste pits. This work shall include erosion control device maintenance and installation, repair seeding and mulching, supplemental seeding and mulching, mowing, and fertilizer topdressing, as directed. All work shall be performed in accordance with the applicable section of the *2018 Standard Specifications*. All work required for initial vegetation planting shall be performed as a part of the work necessary for the completion and acceptance of the Intermediate Contract Time (ICT). Between the time of ICT and Final Project acceptance, or otherwise referred to as the vegetation establishment period, the Department will be responsible for preparing the required National Pollutant Discharge Elimination System (NPDES) inspection records.

Once the Engineer has determined that the permanent vegetation establishment requirement has been achieved at an 80% vegetation density (the amount of established vegetation per given area to stabilize the soil) and no erodible areas exist within the project limits, the Contractor will be notified to remove the remaining erosion control devices that are no longer needed. The Contractor will be responsible for, and shall correct any areas disturbed by operations performed in permanent vegetation establishment and the removal of temporary erosion control measures, whether occurring prior to or after placing traffic on the project.

Payment for *Response for Erosion Control, Seeding and Mulching, Repair Seeding, Supplemental Seeding, Mowing, Fertilizer Topdressing, Silt Excavation, and Stone for Erosion Control* will be made at contract unit prices for the affected items. Work required that is not represented by contract line items will be paid in accordance with Articles 104-7 or 104-3 of the *2018 Standard Specifications*. No additional compensation will be made for maintenance and removal of temporary erosion control items.

**DELAY IN RIGHT OF ENTRY:**

(7-1-95)

108

SP1 G22 B

The Contractor will not be allowed right of entry to the following parcels prior to the listed dates unless otherwise permitted by the Engineer.

<b><u>Parcel No.</u></b>	<b><u>Property Owner</u></b>	<b><u>Date</u></b>
008	Larry Watson	July 18, 2022
013	Revis Pounds	July 18, 2022
014	Revis Pounds	July 18, 2022

**MAJOR CONTRACT ITEMS:**

(2-19-02)

104

SP1 G28

The following listed items are the major contract items for this contract (see Article 104-5 of the 2018 Standard Specifications):

<b>Line #</b>	<b>Description</b>
29	Asphalt Concrete Base Course, Type B25.0C
30	Asphalt Concrete Intermediate Course, Type I19.0C
31	Asphalt Concrete Surface Course, Type S9.5C
199	Sound Barrier Wall

**SPECIALTY ITEMS:**

(7-1-95)(Rev. 7-20-21)

108-6

SP1 G37

Items listed below will be the specialty items for this contract (see Article 108-6 of the 2018 Standard Specifications).

<b>Line #</b>	<b>Description</b>
61-65	Guardrail
66	Fencing
70-74	Signing
87-91	Long-Life Pavement Markings
102	Permanent Pavement Markers
104-136	Utility Construction
137-166	Erosion Control
167	Reforestation
168-196	Signals/ITS System

**FUEL PRICE ADJUSTMENT:**

(11-15-05) (Rev. 7-20-21)

109-8

SP1 G43

Revise the 2018 Standard Specifications as follows:

**Page 1-87, Article 109-8, Fuel Price Adjustments,** add the following:

The base index price for DIESEL #2 FUEL is \$ **4.8185** per gallon. Where any of the following are included as pay items in the contract, they will be eligible for fuel price adjustment.

The pay items and the fuel factor used in calculating adjustments to be made will be as follows:

<b>Description</b>	<b>Units</b>	<b>Fuel Usage Factor Diesel</b>
Unclassified Excavation	Gal/CY	0.29
Borrow Excavation	Gal/CY	0.29
Class IV Subgrade Stabilization	Gal/Ton	0.55
Aggregate Base Course	Gal/Ton	0.55
Sub-Ballast	Gal/Ton	0.55
Asphalt Concrete Base Course, Type _____	Gal/Ton	0.90 or 2.90
Asphalt Concrete Intermediate Course, Type _____	Gal/Ton	0.90 or 2.90
Asphalt Concrete Surface Course, Type _____	Gal/Ton	0.90 or 2.90
Open-Graded Asphalt Friction Course	Gal/Ton	0.90 or 2.90
Permeable Asphalt Drainage Course, Type _____	Gal/Ton	0.90 or 2.90
Sand Asphalt Surface Course, Type _____	Gal/Ton	0.90 or 2.90
Aggregate for Cement Treated Base Course	Gal/Ton	0.55
Portland Cement for Cement Treated Base Course	Gal/Ton	0.55
___ " Portland Cement Concrete Pavement	Gal/SY	0.245
Concrete Shoulders Adjacent to ___ " Pavement	Gal/SY	0.245

For the asphalt items noted in the chart as eligible for fuel adjustments, the bidder may include the *Fuel Usage Factor Adjustment Form* with their bid submission if they elect to use the fuel usage factor. The *Fuel Usage Factor Adjustment Form* is found at the following link:

<https://connect.ncdot.gov/letting/LetCentral/Fuel%20Usage%20Factor%20Adjustment%20Form.pdf>

Select either 2.90 Gal/Ton fuel factor or 0.90 Gal/Ton fuel factor for each asphalt line item on the *Fuel Usage Factor Adjustment Form*. The selected fuel factor for each asphalt item will remain in effect for the duration of the contract.

Failure to complete the *Fuel Usage Factor Adjustment Form* will result in using 2.90 gallons per ton as the Fuel Usage Factor for Diesel for the asphalt items noted above. The contractor will not be permitted to change the Fuel Usage Factor after the bids are submitted.

### **STEEL PRICE ADJUSTMENT:**

(4-19-22)

SP1 G47

### **Description and Purpose**

Steel price adjustments will be made to the payments due the Contractor for items as defined herein that are permanently incorporated into the work, when the price of raw steel mill products utilized on the contract have fluctuated. The Department will adjust monthly progress payments up or down as appropriate for cost changes in steel according to this provision.

**Eligible Items**

The list of eligible bid items for steel price adjustment can be found on the Departments website at the following address:

<https://connect.ncdot.gov/letting/LetCentral/Eligible%20Bid%20Items%20for%20Steel%20Price%20Adjustment.xlsx>

Nuts, bolts, anchor bolts, rebar chairs, connecting bands and other miscellaneous hardware associated with these items shall not be included in the price adjustment.

Adjustments will only be made for fluctuations in the cost of the steel used in the above products as specified in the Product Relationship Table below. The producing mill is defined as the source of steel product before any fabrication has occurred (e.g., coil, plate, rebar, hot rolled shapes, etc.). No adjustment will be made for changes in the cost of fabrication, coating, shipping, storage, etc.

No steel price adjustments will be made for any products manufactured from steel having an adjustment date, as defined by the Product Relationship Table below, prior to the letting date.

**Bid Submittal Requirements**

The successful bidder, within 14 calendar days after the notice of award is received by him, shall provide the completed Form SPA-1 to the Department. Form SPA-1 can be found on the Departments website at the following address:

<https://connect.ncdot.gov/letting/LetCentral/Form%20SPA-1.xlsm>

The Contractor shall provide Form SPA-1 listing the Contract Line Number, (with corresponding Item Number, Item Description, and Category) for the steel products they wish to have an adjustment calculated. Only the contract items corresponding to the list of eligible item numbers for steel price adjustment may be entered on Form SPA-1. The Contractor may choose to have steel price adjustment applied to any, all, or none of the eligible items. However, the Contractor's selection of items for steel price adjustment or non-selection (non-participation) may not be changed once Form SPA-1 has been received by the Department. Items the Bidder chooses for steel price adjustment must be designated by writing the word "Yes" in the column titled "Option" by each Pay Item chosen for adjustment. The Bidder's designations on Form SPA-1 must be written in ink or typed and signed by the Bidder to be considered complete. Items not properly designated, designated with "No", or left blank on the Bidder's Form SPA-1 will automatically be removed from consideration for adjustment. No steel items will be eligible for steel price adjustment on this Project if the Bidder fails to return Form SPA-1 in accordance with this provision.

**Establishing the Base Price**

The Department will use a blend of monthly average prices as reported from the Fastmarkets platform to calculate the monthly adjustment indices (BI and MI). This data is typically

available on the first day of the month for the preceding month. The indices will be calculated by the Department for the different categories found on the Product Relationship Table below. For item numbers that include multiple types of steel products, the category listed for that item number will be used for adjusting each steel component.

The bidding index for Category 1 Steel items is **\$ 56.50** per hundredweight.

The bidding index for Category 2 Steel items is **\$ 90.37** per hundredweight.

The bidding index for Category 3 Steel items is **\$ 74.50** per hundredweight.

The bidding index for Category 4 Steel items is **\$ 67.38** per hundredweight.

The bidding index for Category 5 Steel items is **\$ 67.06** per hundredweight.

The bidding index for Category 6 Steel items is **\$ 98.34** per hundredweight.

The bidding index for Category 7 Steel items is **\$ 61.30** per hundredweight.

The bidding index represents a selling price of steel based on Fastmarkets data for the month of **May 2022**.

MI = Monthly Index. – in Dollars (\$) per hundredweight (CWT). Use the adjustment indices from the month the steel was shipped from the producing mill, received on the project, or member cast as defined in the Product Relationship Table.

BI = Bidding Index. - in Dollars (\$) per hundredweight (CWT). Use the adjustment indices as listed in the proposal.

<i>Steel Product (Title)</i>	BI, MI*	Adjustment Date for MI	Category
Reinforcing Steel, Bridge Deck, and SIP Forms	Based on one or more Fastmarkets indices	Delivery Date from Producing Mill	1
Structural Steel and Encasement Pipe	Based on one or more Fastmarkets indices	Delivery Date from Producing Mill	2
Steel H-Piles, Soldier Pile Walls	Based on one or more Fastmarkets indices	Delivery Date from Producing Mill	3
Guardrail and Pipe Piles Items	Based on one or more Fastmarkets indices	Material Received Date**	4
Fence Items	Based on one or more Fastmarkets indices	Material Received Date**	5
Overhead Sign Assembly, Signal Poles, High Mount Standards	Based on one or more Fastmarkets indices	Material Received Date**	6
Prestressed Concrete Members	Based on one or more Fastmarkets indices	Cast Date of Member	7

Submit documentation to the Engineer for all items listed in the Contract for which the Contractor is requesting a steel price adjustment.

### Submittal Requirements

The items in categories 1,2, and 3, shall be specifically stored, labeled, or tagged, recognizable by color marking, and identifiable by Project for inspection and audit verification immediately upon arrival at the fabricator.

Furnish the following documentation for all steel products to be incorporated into the work and documented on Form SPA-2, found on the Departments website at the following address:

<https://connect.ncdot.gov/projects/construction/Construction%20Forms/Form%20SPA-2.xlsx>

Submit all documentation to the Engineer prior to incorporation of the steel into the completed work. The Department will withhold progress payments for the affected contract line item if the documentation is not provided and at the discretion of the Engineer the work is allowed to proceed. Progress payments will be made upon receipt of the delinquent documentation.

#### Step 1 (Form SPA -2)

Utilizing Form SPA-2, submit separate documentation packages for each line item from Form SPA-1 for which the Contractor opted for a steel price adjustment. For line items with multiple components of steel, each component should be listed separately. Label each SPA-2 documentation package with a unique number as described below.

- a. Documentation package number: (Insert the contract line-item) - (Insert sequential package number beginning with "1").  
Example: 412 - 1,  
412 - 2,  
424 - 1,  
424 - 2,  
424 - 3, etc.
- b. The steel product quantity in pounds
  - i. The following sources should be used, in declining order of precedence, to determine the weight of steel/iron, based on the Engineers decision:
    1. Department established weights of steel/iron by contract pay item per pay unit;
    2. Approved Shop Drawings;
    3. Verified Shipping Documents;
    4. Contract Plans;
    5. Standard Drawing Sheets;
    6. Industry Standards (i.e., AISC Manual of Steel Construction, AWWA Standards, etc.); and
    7. Manufacture's data.
  - ii. Any item requiring approved shop drawings shall have the weights of steel calculated and shown on the shop drawings or submitted and certified separately by the fabricator.
- c. The date the steel product, subject to adjustment, was shipped from the producing mill (Categories 1-3), received on the project (Categories 4-6), or casting date (Category 7).

#### Step 2 (Monthly Calculator Spreadsheet)

For each month, upon the incorporation of the steel product into the work, provide the Engineer the following:

- 1) Completed NCDOT Steel Price Adjustment Calculator Spreadsheet, summarizing all the steel submittal packages (Form SPA-2) actually incorporated into the completed work in the given month.
  - a. Contract Number
  - b. Bidding Index Reference Month
  - c. Contract Completion Date or Revised Completion Date
  - d. County, Route, and Project TIP information
  - e. Item Number
  - f. Line-Item Description
  - g. Submittal Number from Form SPA-2
  - h. Adjustment date
  - i. Pounds of Steel
- 2) An affidavit signed by the Contractor stating the documentation provided in the NCDOT Steel Price Adjustment Calculator Spreadsheet is true and accurate.

### Price Adjustment Conditions

Download the Monthly Steel Adjustment Spreadsheet with the most current reference data from the Department's website each month at the following address:

<https://connect.ncdot.gov/projects/construction/Construction%20Forms/Form%20SPA-3%20NCDOT%20Steel%20Price%20Adjustment%20Calculator.xlsx>

If the monthly Fastmarkets data is not available, the data for the most recent immediately preceding month will be used as the basis for adjustment.

### Price Adjustment Calculations

The price adjustment will be determined by comparing the percentage of change in index value listed in the proposal (BI) to the monthly index value (MI). (See included sample examples). Weights and date of shipment must be documented as required herein. The final price adjustment dollar value will be determined by multiplying this percentage increase or decrease in the index by the represented quantity of steel incorporated into the work, and the established bidding index (BI) subject to the limitations herein.

### Price increase/decrease will be computed as follows:

$$\text{SPA} = ((\text{MI} / \text{BI}) - 1) * \text{BI} * (\text{Q} / 100)$$

Where;

SPA = Steel price adjustment in dollars

MI = Monthly Shipping Index. - in Dollars (\$) per hundredweight (CWT). Use the adjustment indices from the month the steel was shipped from the producing mill, received on the project, or member cast as defined in the Product Relationship Table.

BI = Bidding Index. - in Dollars (\$) per hundredweight (CWT). Use the adjustment indices as listed in the proposal.

Q = Quantity of steel, product, pounds actually incorporated into the work as documented by the Contractor, or Design Build Team and verified by the Engineer.

Calculations for price adjustment shall be shown separate from the monthly progress estimate and will not be included in the total cost of work for determination of progress or for extension of Contract time in accordance with Subarticle 108-10(B)(1).

Any apparent attempt to unbalance bids in favor of items subject to price adjustment may result in rejection of the bid proposal.

Adjustments will be paid or charged to the Contractor only. Any Contractor receiving an adjustment under this provision shall distribute the proper proportional part of such adjustments to the subcontractor who performed the applicable work.

Delays to the work caused by steel shortages may be justification for a Contract time extension but will not constitute grounds for claims for standby equipment, extended office overhead, or other costs associated with such delays.

If an increase in the steel material price is anticipated to exceed 50% of the original quoted price, the contractor must notify the Department within 7 days prior to purchasing the material. Upon receipt of such notification, the Department will direct the Contractor to either (1) proceed with the work or (2) suspend the work and explore the use of alternate options.

If the decrease in the steel material exceeds 50% of the original quoted price, the contractor may submit to the Department additional market index information specific to the item in question to dispute the decrease. The Department will review this information and determine if the decrease is warranted.

When the steel product adjustment date, as defined in the Product Relationship Table, is after the approved contract completion date, the steel price adjustments will be based on the lesser value of either the MI for the month of the approved contract completion date or the MI for the actual adjustment date.

If the price adjustment is based on estimated material quantities for that time, and a revision to the total material quantity is made in a subsequent or final estimate, an appropriate adjustment will be made to the price adjustment previously calculated. The adjustment will be based on the same indices used to calculate the price adjustment which is being revised. If the adjustment date of the revised material quantity cannot be determined, the adjustment for the quantity in question, will be based on the indices utilized to calculate the steel price adjustment for the last initial documentation package submission, for the steel product subject to adjustment, that was incorporated into the particular item of work, for which quantities are being finalized.

Example: Structural steel for a particular bridge was provided for in three different shipments with each having a different mill shipping date. The quantity of structural steel actually used for the bridge was calculated and a steel price adjustment was made in a progress payment. At the conclusion of the work an error was found in the plans of the final quantity of structural steel used for the bridge. The quantity to be adjusted cannot be directly related to any one of the three mill shipping dates. The steel price adjustment for the quantity in question would be calculated



using the indices that were utilized to calculate the steel price adjustment for the quantity of structural steel represented by the last initial structural steel documentation package submission. The package used will be the one with the greatest sequential number.

**Extra Work/Force Account:**

When steel products, as specified herein, are added to the contract as extra work, in accordance with the provisions of Article 104-7 or 104-3, the Engineer will determine and specify in the supplemental agreement, the need for application of steel price adjustments on a case-by-case basis. No steel price adjustments will be made for any products manufactured from steel having an adjustment date prior to the supplemental agreement execution date. Price adjustments will be made as provided herein, except the Bidding Index will be based on the month in which the supplemental agreement pricing was executed.

For work performed on force account basis, reimbursement of actual material costs, along with the specified overhead and profit markup, will be considered to include full compensation for the current cost of steel and no steel price adjustments will be made.

**Examples Form SPA-2  
Steel Price Adjustment Submission Form**

Contract Number C203394 Bid Reference Month January 2019

Submittal Date 8/31/2019

Contract Line Item 237

Line Item Description APPROX...LBS Structural Steel

Sequential Submittal  
Number 2

Supplier	Description of material	Location information	Quantity in lbs.	Adjustment Date
XYZ mill	Structural Steel	Structure 3, Spans A-C	1,200,000	May 4, 2020
ABC distributing	Various channel & angle shapes	Structure 3 Spans A-C	35,000	July 14, 2020
		Total Pounds of Steel	1,235,000	

Note: Attach the following supporting documentation to this form.

- Bill of Lading to support the shipping dates

- Supporting information for weight documentation (e.g., Pay item reference, Shop drawings, shipping documents, Standards Sheets, industry standards, or manufacturer's data)

By providing this data under my signature, I attest to the accuracy of and validity of the data on this form and certify that no deliberate misrepresentation in any manner has occurred.

Printed Name

Signature

---

**Examples Form SPA-2****Steel Price Adjustment Submission Form**Contract Number C203394 Bid Reference Month January 2019Submittal Date August 31, 2019Contract Line Item 237Line Item Description SUPPORT, OVRHD SIGN STR -DFEB – STA 36+00

Sequential Submittal

Number 2

Supplier	Description of material	Location information	Quantity in lbs.	Adjustment Date
XYZ mill	Tubular Steel (Vertical legs)	<u>-DFEB – STA 36+00</u>	12000	December 11, 2021
PDQ Mill	4" Tubular steel (Horizontal legs)	<u>-DFEB – STA 36+00</u>	5900	December 11, 2021
ABC distributing	Various channel & angle shapes (see quote)	<u>-DFEB – STA 36+00</u>	1300	December 11, 2021
	Catwalk assembly	<u>-DFEB – STA 36+00</u>	2000	December 11, 2021
Nucor	Flat plate	<u>-DFEB – STA 36+00</u>	650	December 11, 2021
		Total Pounds of Steel	21,850	

Note: Attach the following supporting documentation to this form.

- Bill of Lading to support the shipping dates
- Supporting information for weight documentation (e.g., Pay item reference, Shop drawings, shipping documents, Standards Sheets, industry standards, or manufacturer's data)

By providing this data under my signature, I attest to the accuracy of and validity of the data on this form and certify that no deliberate misrepresentation in any manner has occurred.

Printed Name

Signature

\_\_\_\_\_

\_\_\_\_\_

**Price Adjustment Sample Calculation (increase)**

Project bid on September 17, 2019

Line Item 635 “Structural Steel” has a plan quantity of 2,717,000 lbs.

Bidding Index for Structural Steel (Category 2) in the proposal was \$36.12/CWT = BI

450,000 lbs. of Structural Steel for Structure 2 at Station 44+08.60 were shipped to fabricator from the producing mill in same month, May 2021.

Monthly Index for Structural Steel (Category 2) for May 2021 was \$64.89/CWT = MI

The Steel Price Adjustment formula is as follows:

$$\text{SPA} = ((\text{MI} / \text{BI}) - 1) * \text{BI} * (\text{Q} / 100)$$

Where; SPA = Steel price adjustment in dollars

BI = Bidding Index – in dollars (\$) per hundredweight (CWT). Use the adjustment indices as listed in the proposal.

MI = Mill Shipping Index – in dollars (\$) per hundredweight (CWT). Use the adjustment indices from the month the steel was shipped from the producing mill, received on the project, or member cast as defined in the Product Relationship Table.

Q = Quantity of steel product, in pounds (lbs.) actually incorporated into the work as documented by the Contractor, or Design Build Team and verified by the Engineer.

$$\text{BI} = \$36.12 / \text{CWT}$$

$$\text{MI} = \$64.89 / \text{CWT}$$

$$\% \text{ change} = ((\text{MI} / \text{BI}) - 1) = (\$64.89 / \$36.12 - 1) = (1.79651 - 1) = 0.79651162791$$

Q = 450,000 lbs.

SPA =  $0.79651162791 \times \$36.12 \times (450,000/100)$

SPA =  $0.79651162791 * \$36.12 * 4,500$

SPA = \$129,465 pay adjustment to Contractor for Structural Steel (Structure 2 at Station 44+08.60)

### Price Adjustment Sample Calculation (decrease)

---

Project bid on December 18, 2018

Line Item 635 Structural Steel has a plan quantity of 2,717,000 lbs.

Bidding Index for Structural Steel (Category 2) in the proposal was \$46.72/CWT = BI

600,000 lbs. of Structural Steel for Structure 1 at Station 22+57.68 were shipped to fabricator from the producing mill in same month, August 2020.

Monthly Index for Structural Steel (Category 2) for August 2020 was \$27.03/CWT = MI

The Steel Price Adjustment formula is as follows:

$$\text{SPA} = ((\text{MI} / \text{BI}) - 1) * \text{BI} * (\text{Q} / 100)$$

Where; SPA = Steel price adjustment in dollars

BI = Bidding Index – in dollars (\$) per hundredweight (CWT). Use the adjustment indices as listed in the proposal.

MI = Mill Shipping Index – in dollars (\$) per hundredweight (CWT). Use the adjustment indices from the month the steel was shipped from the producing mill, received on the project, or member cast as defined in the Product Relationship Table.

Q = Quantity of steel product, in pounds (lbs.) actually incorporated into the work as documented by the Contractor, or Design Build Team and verified by the Engineer.

BI = \$46.72/ CWT

MI = \$27.03 / CWT

% change =  $((\text{MI} / \text{BI}) - 1) = (\$27.03 / \$46.72 - 1) = (0.57855 - 1) = -0.421446917808$

Q = 600,000 lbs.

$$\text{SPA} = -0.421446917808 * \$46.72 * (600,000/100)$$

$$\text{SPA} = -0.421446917808 * \$46.72 * 6,000$$

$$\text{SPA} = \$ 118,140.00 \text{ Credit to the Department for Structural Steel (Structure 1 at Station 22+57.68)}$$

### Price Adjustment Sample Calculation (increase)

---

Project bid on July 16, 2020

Line Item 614 Reinforced Concrete Deck Slab has a plan quantity of 241974 lbs.

Bidding Index Reference Month was May 2020. Bidding Index for Reinforced Concrete Deck Slab (Category 1) in the proposal was \$29.21/CWT = BI

51,621 lbs. of reinforcing steel and 52,311 lbs. of epoxy coated reinforcing steel for Structure 2 at Station 107+45.55 -L- was shipped to fabricator from the producing mill in same month, May 2021.

Monthly Index for Reinforced Concrete Deck Slab (Category 1) for May 2021 was \$43.13/CWT = MI

The Steel Price Adjustment formula is as follows:

$$\text{SPA} = ((\text{MI} / \text{BI}) - 1) * \text{BI} * (\text{Q} / 100)$$

Where; SPA = Steel price adjustment in dollars

BI = Bidding Index – in dollars (\$) per hundredweight (CWT). Use the adjustment indices as listed in the proposal.

MI = Mill Shipping Index – in dollars (\$) per hundredweight (CWT). Use the adjustment indices from the month the steel was shipped from the producing mill, received on the project, or member cast as defined in the Product Relationship Table.

Q = Quantity of steel product, in pounds (lbs.) actually incorporated into the work as documented by the Contractor, or Design Build Team and verified by the Engineer.

$$\text{BI} = \$29.21 / \text{CWT}$$

$$\text{MI} = \$43.13 / \text{CWT}$$

$$\% \text{ change} = ((\text{MI} / \text{BI}) - 1) = (\$43.13 / \$29.21 - 1) = (1.47655 - 1) = 0.47654912701$$

$$\text{Q} = 103932 \text{ lbs.}$$

SPA =  $0.47654912701 * \$29.21 * (103,932/100)$

SPA =  $0.47654912701 * \$29.21 * 1,039.32$

SPA = \$14,467.33 Pay Adjustment to Contractor for Reinforced Concrete Deck Slab (Category 1) at Station 107+45.55 -L-

**SCHEDULE OF ESTIMATED COMPLETION PROGRESS:**

(7-15-08) (Rev. 5-13-19)

108-2

SP1 G58

The Contractor's attention is directed to the Standard Special Provision entitled *Availability of Funds Termination of Contracts* included elsewhere in this proposal. The Department of Transportation's schedule of estimated completion progress for this project as required by that Standard Special Provision is as follows:

	<b><u>Fiscal Year</u></b>	<b><u>Progress (% of Dollar Value)</u></b>
2023	(7/01/22 - 6/30/23)	<b>31%</b> of Total Amount Bid
2024	(7/01/23 - 6/30/24)	<b>45%</b> of Total Amount Bid
2025	(7/01/24 - 6/30/25)	<b>24%</b> of Total Amount Bid

The Contractor shall also furnish his own progress schedule in accordance with Article 108-2 of the *2018 Standard Specifications*. Any acceleration of the progress as shown by the Contractor's progress schedule over the progress as shown above shall be subject to the approval of the Engineer.

**DISADVANTAGED BUSINESS ENTERPRISE:**

(10-16-07)(Rev. 8-17-21)

102-15(J)

SP1 G61

**Description**

The purpose of this Special Provision is to carry out the U.S. Department of Transportation's policy of ensuring nondiscrimination in the award and administration of contracts financed in whole or in part with Federal funds. This provision is guided by 49 CFR Part 26.

**Definitions**

*Additional DBE Subcontractors* - Any DBE submitted at the time of bid that will not be used to meet the DBE goal. No submittal of a Letter of Intent is required.

*Committed DBE Subcontractor* - Any DBE submitted at the time of bid that is being used to meet the DBE goal by submission of a Letter of Intent. Or any DBE used as a replacement for a previously committed DBE firm.

*Contract Goal Requirement* - The approved DBE participation at time of award, but not greater than the advertised contract goal.

*DBE Goal* - A portion of the total contract, expressed as a percentage, that is to be performed by committed DBE subcontractor(s).

*Disadvantaged Business Enterprise (DBE)* - A firm certified as a Disadvantaged Business Enterprise through the North Carolina Unified Certification Program.

*Goal Confirmation Letter* - Written documentation from the Department to the bidder confirming the Contractor's approved, committed DBE participation along with a listing of the committed DBE firms.

*Manufacturer* - A firm that operates or maintains a factory or establishment that produces on the premises, the materials or supplies obtained by the Contractor.

*Regular Dealer* - A firm that owns, operates, or maintains a store, warehouse, or other establishment in which the materials or supplies required for the performance of the contract are bought, kept in stock, and regularly sold to the public in the usual course of business. A regular dealer engages in, as its principal business and in its own name, the purchase and sale or lease of the products in question. A regular dealer in such bulk items as steel, cement, gravel, stone, and petroleum products need not keep such products in stock, if it owns and operates distribution equipment for the products. Brokers and packagers are not regarded as manufacturers or regular dealers within the meaning of this section.

*Replacement / Substitution* – A full or partial reduction in the amount of work subcontracted to a committed (or an approved substitute) DBE firm.

*North Carolina Unified Certification Program (NCUCP)* - A program that provides comprehensive services and information to applicants for DBE certification, such that an applicant is required to apply only once for a DBE certification that will be honored by all recipients of USDOT funds in the state and not limited to the Department of Transportation only. The Certification Program is in accordance with 49 CFR Part 26.

*United States Department of Transportation (USDOT)* - Federal agency responsible for issuing regulations (49 CFR Part 26) and official guidance for the DBE program.

### **Forms and Websites Referenced in this Provision**

*DBE Payment Tracking System* - On-line system in which the Contractor enters the payments made to DBE subcontractors who have performed work on the project.  
<https://apps.dot.state.nc.us/Vendor/PaymentTracking/>

*DBE-IS Subcontractor Payment Information* - Form for reporting the payments made to all DBE firms working on the project. This form is for paper bid projects only.  
<https://connect.ncdot.gov/business/Turnpike/Documents/Form%20DBE-IS%20Subcontractor%20Payment%20Information.pdf>

*RF-1 DBE Replacement Request Form* - Form for replacing a committed DBE.  
<http://connect.ncdot.gov/projects/construction/Construction%20Forms/DBE%20MBE%20WBE%20Replacement%20Request%20Form.pdf>

*SAF Subcontract Approval Form* - Form required for approval to sublet the contract.  
<http://connect.ncdot.gov/projects/construction/Construction%20Forms/Subcontract%20Approval%20Form%20Rev.%202012.zip>

*JC-1 Joint Check Notification Form* - Form and procedures for joint check notification. The form acts as a written joint check agreement among the parties providing full and prompt disclosure of the expected use of joint checks.

<http://connect.ncdot.gov/projects/construction/Construction%20Forms/Joint%20Check%20Notification%20Form.pdf>

*Letter of Intent* - Form signed by the Contractor and the DBE subcontractor, manufacturer or regular dealer that affirms that a portion of said contract is going to be performed by the signed DBE for the estimated amount (based on quantities and unit prices) listed at the time of bid.

<http://connect.ncdot.gov/letting/LetCentral/Letter%20of%20Intent%20to%20Perform%20as%20a%20Subcontractor.pdf>

*Listing of DBE Subcontractors Form* - Form for entering DBE subcontractors on a project that will meet this DBE goal. This form is for paper bids only.

[http://connect.ncdot.gov/municipalities/Bid%20Proposals%20for%20LGA%20Content/08%20DBE%20Subcontractors%20\(Federal\).docx](http://connect.ncdot.gov/municipalities/Bid%20Proposals%20for%20LGA%20Content/08%20DBE%20Subcontractors%20(Federal).docx)

*Subcontractor Quote Comparison Sheet* - Spreadsheet for showing all subcontractor quotes in the work areas where DBEs quoted on the project. This sheet is submitted with good faith effort packages.

<http://connect.ncdot.gov/business/SmallBusiness/Documents/DBE%20Subcontractor%20Quote%20Comparison%20Example.xls>

## **DBE Goal**

The following DBE goal for participation by Disadvantaged Business Enterprises is established for this contract:

Disadvantaged Business Enterprises **6.0** %

- (A) *If the DBE goal is more than zero*, the Contractor shall exercise all necessary and reasonable steps to ensure that DBEs participate in at least the percent of the contract as set forth above as the DBE goal.
- (B) *If the DBE goal is zero*, the Contractor shall make an effort to recruit and use DBEs during the performance of the contract. Any DBE participation obtained shall be reported to the Department.

## **Directory of Transportation Firms (Directory)**

Real-time information is available about firms doing business with the Department and firms that are certified through NCUCP in the Directory of Transportation Firms. Only firms identified in the Directory as DBE certified shall be used to meet the DBE goal. The Directory can be found at the following link. [https:// www.ebs.nc.gov/VendorDirectory/default.html](https://www.ebs.nc.gov/VendorDirectory/default.html)



The listing of an individual firm in the directory shall not be construed as an endorsement of the firm's capability to perform certain work.

### **Listing of DBE Subcontractors**

At the time of bid, bidders shall submit all DBE participation that they anticipate to use during the life of the contract. Only those identified to meet the DBE goal will be considered committed, even though the listing shall include both committed DBE subcontractors and additional DBE subcontractors. Additional DBE subcontractor participation submitted at the time of bid will be used toward the Department's overall race-neutral goal. Only those firms with current DBE certification at the time of bid opening will be acceptable for listing in the bidder's submittal of DBE participation. The Contractor shall indicate the following required information:

#### (A) Electronic Bids

Bidders shall submit a listing of DBE participation in the appropriate section of the electronic submittal file.

- (1) Submit the names and addresses of DBE firms identified to participate in the contract. If the bidder uses the updated listing of DBE firms shown in the electronic submittal file, the bidder may use the dropdown menu to access the name and address of the DBE firm.
- (2) Submit the contract line numbers of work to be performed by each DBE firm. When no figures or firms are entered, the bidder will be considered to have no DBE participation.
- (3) The bidder shall be responsible for ensuring that the DBE is certified at the time of bid by checking the Directory of Transportation Firms. If the firm is not certified at the time of the bid-letting, that DBE's participation will not count towards achieving the DBE goal.

#### (B) Paper Bids

- (1) *If the DBE goal is more than zero,*
  - (a) Bidders, at the time the bid proposal is submitted, shall submit a listing of DBE participation, including the names and addresses on *Listing of DBE Subcontractors* contained elsewhere in the contract documents in order for the bid to be considered responsive. Bidders shall indicate the total dollar value of the DBE participation for the contract.
  - (b) If bidders have no DBE participation, they shall indicate this on the *Listing of DBE Subcontractors* by entering the word "None" or the number "0." This form shall be completed in its entirety. **Blank forms will not be deemed to represent zero participation.** Bids submitted that do not have DBE participation indicated on the appropriate form will not be read

publicly during the opening of bids. The Department will not consider these bids for award and the proposal will be rejected.

- (c) The bidder shall be responsible for ensuring that the DBE is certified at the time of bid by checking the Directory of Transportation Firms. If the firm is not certified at the time of the bid-letting, that DBE's participation will not count towards achieving the corresponding goal.
- (2) *If the DBE goal is zero*, entries on the *Listing of DBE Subcontractors* are not required for the zero goal, however any DBE participation that is achieved during the project shall be reported in accordance with requirements contained elsewhere in the special provision.

### **DBE Prime Contractor**

When a certified DBE firm bids on a contract that contains a DBE goal, the DBE firm is responsible for meeting the goal or making good faith efforts to meet the goal, just like any other bidder. In most cases, a DBE bidder on a contract will meet the DBE goal by virtue of the work it performs on the contract with its own forces. However, all the work that is performed by the DBE bidder and any other DBE subcontractors will count toward the DBE goal. The DBE bidder shall list itself along with any DBE subcontractors, if any, in order to receive credit toward the DBE goal.

For example, if the DBE goal is 45% and the DBE bidder will only perform 40% of the contract work, the prime will list itself at 40%, and the additional 5% shall be obtained through additional DBE participation with DBE subcontractors or documented through a good faith effort.

DBE prime contractors shall also follow Sections A and B listed under *Listing of DBE Subcontractor* just as a non-DBE bidder would.

### **Written Documentation – Letter of Intent**

The bidder shall submit written documentation for each DBE that will be used to meet the DBE goal of the contract, indicating the bidder's commitment to use the DBE in the contract. This documentation shall be submitted on the Department's form titled *Letter of Intent*.

The documentation shall be received in the office of the State Contractor Utilization Engineer or at DBE@ncdot.gov no later than 10:00 a.m. of the sixth calendar day following opening of bids, unless the sixth day falls on an official state holiday. In that situation, it is due in the office of the State Contractor Utilization Engineer no later than 10:00 a.m. on the next official state business day.

If the bidder fails to submit the Letter of Intent from each committed DBE to be used toward the DBE goal, or if the form is incomplete (i.e. both signatures are not present), the DBE participation will not count toward meeting the DBE goal. If the lack of this participation drops the commitment below the DBE goal, the Contractor shall submit evidence of good faith efforts, completed in its entirety, to the State Contractor Utilization Engineer or DBE@ncdot.gov no later than 10:00 a.m. on the eighth calendar day following opening of bids, unless the eighth day falls on an official state

holiday. In that situation, it is due in the office of the State Contractor Utilization Engineer no later than 10:00 a.m. on the next official state business day.

### **Submission of Good Faith Effort**

If the bidder fails to meet or exceed the DBE goal, the apparent lowest responsive bidder shall submit to the Department documentation of adequate good faith efforts made to reach the DBE goal.

A hard copy and an electronic copy of this information shall be received in the office of the State Contractor Utilization Engineer or at [DBE@ncdot.gov](mailto:DBE@ncdot.gov) no later than 10:00 a.m. on the sixth calendar day following opening of bids unless the sixth day falls on an official state holiday. In that situation, it is due in the office of the State Contractor Utilization Engineer no later than 10:00 a.m. on the next official state business day. If the contractor cannot send the information electronically, then one complete set and 5 copies of this information shall be received under the same time constraints above.

Note: Where the information submitted includes repetitious solicitation letters, it will be acceptable to submit a representative letter along with a distribution list of the firms that were solicited. Documentation of DBE quotations shall be a part of the good faith effort submittal. This documentation may include written subcontractor quotations, telephone log notations of verbal quotations, or other types of quotation documentation.

### **Consideration of Good Faith Effort for Projects with DBE Goals More Than Zero**

Adequate good faith efforts mean that the bidder took all necessary and reasonable steps to achieve the goal which, by their scope, intensity, and appropriateness, could reasonably be expected to obtain sufficient DBE participation. Adequate good faith efforts also mean that the bidder actively and aggressively sought DBE participation. Mere *pro forma* efforts are not considered good faith efforts.

The Department will consider the quality, quantity, and intensity of the different kinds of efforts a bidder has made. Listed below are examples of the types of actions a bidder will take in making a good faith effort to meet the goal and are not intended to be exclusive or exhaustive, nor is it intended to be a mandatory checklist.

- (A) Soliciting through all reasonable and available means (e.g. attendance at pre-bid meetings, advertising, written notices, use of verifiable electronic means through the use of the NCDOT Directory of Transportation Firms) the interest of all certified DBEs who have the capability to perform the work of the contract. The bidder must solicit this interest within at least 10 days prior to bid opening to allow the DBEs to respond to the solicitation. Solicitation shall provide the opportunity to DBEs within the Division and surrounding Divisions where the project is located. The bidder must determine with certainty if the DBEs are interested by taking appropriate steps to follow up initial solicitations.

- (B) Selecting portions of the work to be performed by DBEs in order to increase the likelihood that the DBE goals will be achieved.
- (1) Where appropriate, break out contract work items into economically feasible units to facilitate DBE participation, even when the prime contractor might otherwise prefer to perform these work items with its own forces.
  - (2) Negotiate with subcontractors to assume part of the responsibility to meet the contract DBE goal when the work to be sublet includes potential for DBE participation (2<sup>nd</sup> and 3<sup>rd</sup> tier subcontractors).
- (C) Providing interested DBEs with adequate information about the plans, specifications, and requirements of the contract in a timely manner to assist them in responding to a solicitation.
- (D) (1) Negotiating in good faith with interested DBEs. It is the bidder's responsibility to make a portion of the work available to DBE subcontractors and suppliers and to select those portions of the work or material needs consistent with the available DBE subcontractors and suppliers, to facilitate DBE participation. Evidence of such negotiation includes the names, addresses, and telephone numbers of DBEs that were considered; a description of the information provided regarding the plans and specifications for the work selected for subcontracting; and evidence as to why additional agreements could not be reached for DBEs to perform the work.
- (2) A bidder using good business judgment would consider a number of factors in negotiating with subcontractors, including DBE subcontractors, and would take a firm's price and capabilities as well as contract goals into consideration. However, the fact that there may be some additional costs involved in finding and using DBEs is not in itself sufficient reason for a bidder's failure to meet the contract DBE goal, as long as such costs are reasonable. Also, the ability or desire of a prime contractor to perform the work of a contract with its own organization does not relieve the bidder of the responsibility to make good faith efforts. Bidding contractors are not, however, required to accept higher quotes from DBEs if the price difference is excessive or unreasonable.
- (E) Not rejecting DBEs as being unqualified without sound reasons based on a thorough investigation of their capabilities. The bidder's standing within its industry, membership in specific groups, organizations, or associates and political or social affiliations (for example, union vs. non-union employee status) are not legitimate causes for the rejection or non-solicitation of bids in the bidder's efforts to meet the project goal.
- (F) Making efforts to assist interested DBEs in obtaining bonding, lines of credit, or insurance as required by the recipient or bidder.
- (G) Making efforts to assist interested DBEs in obtaining necessary equipment, supplies, materials, or related assistance or services.

- (H) Effectively using the services of available minority/women community organizations; minority/women contractors' groups; Federal, State, and local minority/women business assistance offices; and other organizations as allowed on a case-by-case basis to provide assistance in the recruitment and placement of DBEs. Contact within 7 days from the bid opening the Business Opportunity and Work Force Development Unit at BOWD@ncdot.gov to give notification of the bidder's inability to get DBE quotes.
- (I) Any other evidence that the bidder submits which shows that the bidder has made reasonable good faith efforts to meet the DBE goal.

In addition, the Department may take into account the following:

- (1) Whether the bidder's documentation reflects a clear and realistic plan for achieving the DBE goal.
- (2) The bidders' past performance in meeting the DBE goals.
- (3) The performance of other bidders in meeting the DBE goal. For example, when the apparent successful bidder fails to meet the DBE goal, but others meet it, you may reasonably raise the question of whether, with additional reasonable efforts the apparent successful bidder could have met the goal. If the apparent successful bidder fails to meet the DBE goal, but meets or exceeds the average DBE participation obtained by other bidders, the Department may view this, in conjunction with other factors, as evidence of the apparent successful bidder having made a good faith effort.

If the Department does not award the contract to the apparent lowest responsive bidder, the Department reserves the right to award the contract to the next lowest responsive bidder that can satisfy to the Department that the DBE goal can be met or that an adequate good faith effort has been made to meet the DBE goal.

### **Non-Good Faith Appeal**

The State Prequalification Engineer will notify the contractor verbally and in writing of non-good faith. A contractor may appeal a determination of non-good faith made by the Goal Compliance Committee. If a contractor wishes to appeal the determination made by the Committee, they shall provide written notification to the State Prequalification Engineer or at DBE@ncdot.gov. The appeal shall be made within 2 business days of notification of the determination of non-good faith.

### **Counting DBE Participation Toward Meeting DBE Goal**

- (A) Participation

The total dollar value of the participation by a committed DBE will be counted toward the contract goal requirement. The total dollar value of participation by a committed DBE will be based upon the value of work actually performed by the DBE and the actual payments to DBE firms by the Contractor.

## (B) Joint Checks

Prior notification of joint check use shall be required when counting DBE participation for services or purchases that involves the use of a joint check. Notification shall be through submission of Form JC-1 (*Joint Check Notification Form*) and the use of joint checks shall be in accordance with the Department's Joint Check Procedures.

## (C) Subcontracts (Non-Trucking)

A DBE may enter into subcontracts. Work that a DBE subcontracts to another DBE firm may be counted toward the contract goal requirement. Work that a DBE subcontracts to a non-DBE firm does not count toward the contract goal requirement. If a DBE contractor or subcontractor subcontracts a significantly greater portion of the work of the contract than would be expected on the basis of standard industry practices, it shall be presumed that the DBE is not performing a commercially useful function. The DBE may present evidence to rebut this presumption to the Department. The Department's decision on the rebuttal of this presumption is subject to review by the Federal Highway Administration but is not administratively appealable to USDOT.

## (D) Joint Venture

When a DBE performs as a participant in a joint venture, the Contractor may count toward its contract goal requirement a portion of the total value of participation with the DBE in the joint venture, that portion of the total dollar value being a distinct clearly defined portion of work that the DBE performs with its forces.

## (E) Suppliers

A contractor may count toward its DBE requirement 60 percent of its expenditures for materials and supplies required to complete the contract and obtained from a DBE regular dealer and 100 percent of such expenditures from a DBE manufacturer.

## (F) Manufacturers and Regular Dealers

A contractor may count toward its DBE requirement the following expenditures to DBE firms that are not manufacturers or regular dealers:

- (1) The fees or commissions charged by a DBE firm for providing a *bona fide* service, such as professional, technical, consultant, or managerial services, or for providing bonds or insurance specifically required for the performance of a DOT-assisted contract, provided the fees or commissions are determined to be reasonable and not excessive as compared with fees and commissions customarily allowed for similar services.
- (2) With respect to materials or supplies purchased from a DBE, which is neither a manufacturer nor a regular dealer, count the entire amount of fees or commissions charged for assistance in the procurement of the materials and supplies, or fees or transportation charges for the delivery of materials or supplies required on a job site

(but not the cost of the materials and supplies themselves), provided the fees are determined to be reasonable and not excessive as compared with fees customarily allowed for similar services.

### **Commercially Useful Function**

#### **(A) DBE Utilization**

The Contractor may count toward its contract goal requirement only expenditures to DBEs that perform a commercially useful function in the work of a contract. A DBE performs a commercially useful function when it is responsible for execution of the work of the contract and is carrying out its responsibilities by actually performing, managing, and supervising the work involved. To perform a commercially useful function, the DBE shall also be responsible with respect to materials and supplies used on the contract, for negotiating price, determining quality and quantity, ordering the material and installing (where applicable) and paying for the material itself. To determine whether a DBE is performing a commercially useful function, the Department will evaluate the amount of work subcontracted, industry practices, whether the amount the firm is to be paid under the contract is commensurate with the work it is actually performing and the DBE credit claimed for its performance of the work, and any other relevant factors.

#### **(B) DBE Utilization in Trucking**

The following factors will be used to determine if a DBE trucking firm is performing a commercially useful function:

- (1) The DBE shall be responsible for the management and supervision of the entire trucking operation for which it is responsible on a particular contract, and there shall not be a contrived arrangement for the purpose of meeting DBE goals.
- (2) The DBE shall itself own and operate at least one fully licensed, insured, and operational truck used on the contract.
- (3) The DBE receives credit for the total value of the transportation services it provides on the contract using trucks it owns, insures, and operates using drivers it employs.
- (4) The DBE may subcontract the work to another DBE firm, including an owner-operator who is certified as a DBE. The DBE who subcontracts work to another DBE receives credit for the total value of the transportation services the subcontracted DBE provides on the contract.
- (5) The DBE may also subcontract the work to a non-DBE firm, including from an owner-operator. The DBE who subcontracts the work to a non-DBE is entitled to credit for the total value of transportation services provided by the non-DBE subcontractor not to exceed the value of transportation services provided by DBE-owned trucks on the contract. Additional participation by non-DBE subcontractors receives credit only for the fee or commission it receives as a result of the subcontract arrangement. The value of services performed under

subcontract agreements between the DBE and the Contractor will not count towards the DBE contract requirement.

- (6) A DBE may lease truck(s) from an established equipment leasing business open to the general public. The lease must indicate that the DBE has exclusive use of and control over the truck. This requirement does not preclude the leased truck from working for others during the term of the lease with the consent of the DBE, so long as the lease gives the DBE absolute priority for use of the leased truck. This type of lease may count toward the DBE's credit as long as the driver is under the DBE's payroll.
- (7) Subcontracted/leased trucks shall display clearly on the dashboard the name of the DBE that they are subcontracted/leased to and their own company name if it is not identified on the truck itself. Magnetic door signs are not permitted.

### **DBE Replacement**

When a Contractor has relied on a commitment to a DBE subcontractor (or an approved substitute DBE subcontractor) to meet all or part of a contract goal requirement, the contractor shall not terminate the DBE subcontractor for convenience. This includes, but is not limited to, instances in which the Contractor seeks to perform the work of the terminated subcontractor with another DBE subcontractor, a non-DBE subcontractor, or with the Contractor's own forces or those of an affiliate.

The Contractor must give notice in writing both by certified mail and email to the DBE subcontractor, with a copy to the Engineer of its intent to request to terminate and/or substitute, and the reason for the request. The Contractor must give the DBE subcontractor five (5) business days to respond to the Contractor's Notice of Intent to Request Termination and/or Substitution. If the DBE subcontractor objects to the intended termination/substitution, the DBE, within five (5) business days must advise the Contractor and the Department of the reasons why the action should not be approved. The five-day notice period shall begin on the next business day after written notice is provided to the DBE subcontractor.

A committed DBE subcontractor may only be terminated after receiving the Department's written approval based upon a finding of good cause for the proposed termination and/or substitution. For purposes of this section, good cause shall include the following circumstances:

- (a) The listed DBE subcontractor fails or refuses to execute a written contract;
- (b) The listed DBE subcontractor fails or refuses to perform the work of its subcontract in a way consistent with normal industry standards. Provided, however, that good cause does not exist if the failure or refusal of the DBE subcontractor to perform its work on the subcontract results from the bad faith or discriminatory action of the prime contractor;
- (c) The listed DBE subcontractor fails or refuses to meet the prime contractor's reasonable, nondiscriminatory bond requirements;
- (d) The listed DBE subcontractor becomes bankrupt, insolvent, or exhibits credit unworthiness;
- (e) The listed DBE subcontractor is ineligible to work on public works projects because of suspension and debarment proceedings pursuant to 2 CFR Parts 180, 215 and 1,200 or applicable state law;
- (f) The listed DBE subcontractor is not a responsible contractor;



- (g) The listed DBE voluntarily withdraws from the project and provides written notice of withdrawal;
- (h) The listed DBE is ineligible to receive DBE credit for the type of work required;
- (i) A DBE owner dies or becomes disabled with the result that the listed DBE contractor is unable to complete its work on the contract;
- (j) Other documented good cause that compels the termination of the DBE subcontractor. Provided, that good cause does not exist if the prime contractor seeks to terminate a DBE it relied upon to obtain the contract so that the prime contractor can self-perform the work for which the DBE contractor was engaged or so that the prime contractor can substitute another DBE or non-DBE contractor after contract award.

The Contractor shall comply with the following for replacement of a committed DBE:

(A) Performance Related Replacement

When a committed DBE is terminated for good cause as stated above, an additional DBE that was submitted at the time of bid may be used to fulfill the DBE commitment. A good faith effort will only be required for removing a committed DBE if there were no additional DBEs submitted at the time of bid to cover the same amount of work as the DBE that was terminated.

If a replacement DBE is not found that can perform at least the same amount of work as the terminated DBE, the Contractor shall submit a good faith effort documenting the steps taken. Such documentation shall include, but not be limited to, the following:

- (1) Copies of written notification to DBEs that their interest is solicited in contracting the work defaulted by the previous DBE or in subcontracting other items of work in the contract.
- (2) Efforts to negotiate with DBEs for specific subbids including, at a minimum:
  - (a) The names, addresses, and telephone numbers of DBEs who were contacted.
  - (b) A description of the information provided to DBEs regarding the plans and specifications for portions of the work to be performed.
- (3) A list of reasons why DBE quotes were not accepted.
- (4) Efforts made to assist the DBEs contacted, if needed, in obtaining bonding or insurance required by the Contractor.

(B) Decertification Replacement

- (1) When a committed DBE is decertified by the Department after the SAF (*Subcontract Approval Form*) has been received by the Department, the Department will not require the Contractor to solicit replacement DBE participation equal to the remaining work to be performed by the decertified firm. The participation equal to the remaining work performed by the decertified firm will count toward the contract goal requirement.

- (2) When a committed DBE is decertified prior to the Department receiving the SAF (*Subcontract Approval Form*) for the named DBE firm, the Contractor shall take all necessary and reasonable steps to replace the DBE subcontractor with another DBE subcontractor to perform at least the same amount of work to meet the DBE goal requirement. If a DBE firm is not found to do the same amount of work, a good faith effort must be submitted to NCDOT (see A herein for required documentation).
- (3) Exception: If the DBE's ineligibility is caused solely by its having exceeded the size standard during the performance of the contract, the Department will not require the Contractor to solicit replacement DBE participation equal to the remaining work to be performed by the decertified firm. The participation equal to the remaining work performed by the decertified firm will count toward the contract goal requirement and overall goal.

All requests for replacement of a committed DBE firm shall be submitted to the Engineer for approval on Form RF-1 (*DBE Replacement Request*). If the Contractor fails to follow this procedure, the Contractor may be disqualified from further bidding for a period of up to 6 months.

### **Changes in the Work**

When the Engineer makes changes that result in the reduction or elimination of work to be performed by a committed DBE, the Contractor will not be required to seek additional participation. When the Engineer makes changes that result in additional work to be performed by a DBE based upon the Contractor's commitment, the DBE shall participate in additional work to the same extent as the DBE participated in the original contract work.

When the Engineer makes changes that result in extra work, which has more than a minimal impact on the contract amount, the Contractor shall seek additional participation by DBEs unless otherwise approved by the Engineer.

When the Engineer makes changes that result in an alteration of plans or details of construction, and a portion or all of the work had been expected to be performed by a committed DBE, the Contractor shall seek participation by DBEs unless otherwise approved by the Engineer.

When the Contractor requests changes in the work that result in the reduction or elimination of work that the Contractor committed to be performed by a DBE, the Contractor shall seek additional participation by DBEs equal to the reduced DBE participation caused by the changes.

### **Reports and Documentation**

A SAF (*Subcontract Approval Form*) shall be submitted for all work which is to be performed by a DBE subcontractor. The Department reserves the right to require copies of actual subcontract agreements involving DBE subcontractors.

When using transportation services to meet the contract commitment, the Contractor shall submit a proposed trucking plan in addition to the SAF. The plan shall be submitted prior to beginning construction on the project. The plan shall include the names of all trucking firms proposed for

use, their certification type(s), the number of trucks owned by the firm, as well as the individual truck identification numbers, and the line item(s) being performed.

Within 30 calendar days of entering into an agreement with a DBE for materials, supplies or services, not otherwise documented by the SAF as specified above, the Contractor shall furnish the Engineer a copy of the agreement. The documentation shall also indicate the percentage (60% or 100%) of expenditures claimed for DBE credit.

### **Reporting Disadvantaged Business Enterprise Participation**

The Contractor shall provide the Engineer with an accounting of payments made to all DBE firms, including material suppliers and contractors at all levels (prime, subcontractor, or second tier subcontractor). This accounting shall be furnished to the Engineer for any given month by the end of the following month. Failure to submit this information accordingly may result in the following action:

- (A) Withholding of money due in the next partial pay estimate; or
- (B) Removal of an approved contractor from the prequalified bidders' list or the removal of other entities from the approved subcontractors list.

While each contractor (prime, subcontractor, 2nd tier subcontractor) is responsible for accurate accounting of payments to DBEs, it shall be the prime contractor's responsibility to report all monthly and final payment information in the correct reporting manner.

Failure on the part of the Contractor to submit the required information in the time frame specified may result in the disqualification of that contractor and any affiliate companies from further bidding until the required information is submitted.

Failure on the part of any subcontractor to submit the required information in the time frame specified may result in the disqualification of that contractor and any affiliate companies from being approved for work on future DOT projects until the required information is submitted.

Contractors reporting transportation services provided by non-DBE lessees shall evaluate the value of services provided during the month of the reporting period only.

At any time, the Engineer can request written verification of subcontractor payments.

The Contractor shall report the accounting of payments through the Department's DBE Payment Tracking System.

### **Failure to Meet Contract Requirements**

Failure to meet contract requirements in accordance with Subarticle 102-15(J) of the *2018 Standard Specifications* may be cause to disqualify the Contractor.

**CERTIFICATION FOR FEDERAL-AID CONTRACTS:**

(3-21-90)

SP1 G85

The prospective participant certifies, by signing and submitting this bid or proposal, to the best of his or her knowledge and belief, that:

- (A) No Federal appropriated funds have been paid or will be paid, by or on behalf of the undersigned, to any person for influencing or attempting to influence an officer or employee of any Federal agency, a Member of Congress, an officer or employee of Congress, or an employee of a Member of Congress in connection with the awarding of any Federal contract, the making of any Federal grant, the making of any Federal loan, the entering into of any cooperative agreement, and the extension, continuation, renewal, amendment, or modification of any Federal contract, grant, loan, or cooperative agreement.
- (B) If any funds other than Federal appropriated funds have been paid or will be paid to any person for influencing or attempting to influence an officer or employee of any Federal agency, a Member of Congress, an officer or employee of Congress, or an employee of a Member of Congress in connection with this Federal contract, grant, loan, or cooperative agreement, the undersigned shall complete and submit Standard Form-LLL, *Disclosure Form to Report Lobbying*, in accordance with its instructions.

This certification is a material representation of fact upon which reliance was placed when this transaction was made or entered into. Submission of this certification is a prerequisite for making or entering into this transaction imposed by *Section 1352, Title 31, U.S. Code*. Any person who fails to file the required certification shall be subject to a civil penalty of not less than \$10,000 and not more than \$100,000 for each such failure.

The prospective participant also agrees by submitting his or her bid or proposal that he or she shall require that the language of this certification be included in all lower tier subcontracts, which exceed \$100,000 and that all such subrecipients shall certify and disclose accordingly.

**CONTRACTOR'S LICENSE REQUIREMENTS:**

(7-1-95)

102-14

SP1 G88

If the successful bidder does not hold the proper license to perform any plumbing, heating, air conditioning, or electrical work in this contract, he will be required to sublet such work to a contractor properly licensed in accordance with *Article 2 of Chapter 87 of the General Statutes* (licensing of heating, plumbing, and air conditioning contractors) and *Article 4 of Chapter 87 of the General Statutes* (licensing of electrical contractors).

**RESTRICTIONS ON ITS EQUIPMENT AND SERVICES:**

(11-17-20)

SP01 G090

All telecommunications, video or other ITS equipment or services installed or utilized on this project must be in conformance with UNIFORM ADMINISTRATIVE REQUIREMENTS, COST PRINCIPLES, AND AUDIT REQUIREMENTS FOR FEDERAL AWARDS **2 CFR, § 200.216** **Prohibition on certain telecommunications and video surveillance services or equipment.**

**USE OF UNMANNED AIRCRAFT SYSTEM (UAS):**

(8-20-19)

SP1 G092

The Contractor shall adhere to all Federal, State and Local regulations and guidelines for the use of Unmanned Aircraft Systems (UAS). This includes but is not limited to US 14 CFR Part 107 *Small UAS Rule*, NC GS 15A-300.2 *Regulation of launch and recovery sites*, NC GS 63-95 *Training required for the operation of unmanned aircraft systems*, NC GS 63-96 *Permit required for commercial operation of unmanned aircraft system*, and NCDOT UAS Policy. The required operator certifications include possessing a current Federal Aviation Administration (FAA) Remote Pilot Certificate, a NC UAS Operator Permit as well as operating a UAS registered with the FAA.

Prior to beginning operations, the Contractor shall complete the NCDOT UAS – Flight Operation Approval Form and submit it to the Engineer for approval. All UAS operations shall be approved by the Engineer prior to beginning the operations.

All contractors or subcontractors operating UAS shall have UAS specific general liability insurance to cover all operations under this contract.

The use of UAS is at the Contractor's discretion. No measurement or payment will be made for the use of UAS. In the event that the Department directs the Contractor to utilize UAS, payment will be in accordance with Article 104-7 Extra Work.

**EQUIPMENT IDLING GUIDELINES:**

(1-19-21)

107

SP1 G096

Exercise reduced fuel consumption and reduced equipment emissions during the construction of all work associated with this contract. Employees engaged in the construction of this project should turn off vehicles when stopped for more than thirty (30) minutes and off-highway equipment should idle no longer than fifteen (15) consecutive minutes.

These guidelines for turning off vehicles and equipment when idling do not apply to:

1. Idling when queuing.
2. Idling to verify the vehicle is in safe operating condition.
3. Idling for testing, servicing, repairing or diagnostic purposes.
4. Idling necessary to accomplish work for which the vehicle was designed (such as operating a crane, mixing concrete, etc.).
5. Idling required to bring the machine system to operating temperature.
6. Emergency vehicles, utility company, construction, and maintenance vehicles where the engines must run to perform needed work.
7. Idling to ensure safe operation of the vehicle.
8. Idling when the propulsion engine is providing auxiliary power for other than heating or air conditioning. (such as hydraulic systems for pavers)
9. When specific traffic, safety, or emergency situations arise.
10. If the ambient temperature is less than 32 degrees Fahrenheit. Limited idling to provide for the safety of vehicle occupants (e.g. to run the heater).

11. If the ambient temperature is greater than 90 degrees Fahrenheit. Limited idling to provide for the safety of vehicle occupants of off-highway equipment (e.g. to run the air conditioning) no more than 30 minutes.

12. Diesel powered vehicles may idle for up to 30 minutes to minimize restart problems. Any vehicle, truck, or equipment in which the primary source of fuel is natural gas or electricity is exempt from the idling limitations set forth in this special provision.

**U.S. DEPARTMENT OF TRANSPORTATION HOTLINE:**

(11-22-94)

108-5

SP1 G100

To report bid rigging activities call: **1-800-424-9071**

The U.S. Department of Transportation (DOT) operates the above toll-free hotline Monday through Friday, 8:00 a.m. to 5:00 p.m. eastern time. Anyone with knowledge of possible bid rigging, bidder collusion, or other fraudulent activities should use the hotline to report such activities.

The hotline is part of the DOT's continuing effort to identify and investigate highway construction contract fraud and abuse is operated under the direction of the DOT Inspector General. All information will be treated confidentially and caller anonymity will be respected.

**CARGO PREFERENCE ACT:**

(2-16-16)

Privately owned United States-flag commercial vessels transporting cargoes are subject to the Cargo Preference Act (CPA) of 1954 requirements and regulations found in 46 CFR 381.7. Contractors are directed to clause (b) of 46 CFR 381.7 as follows:

(b) Contractor and Subcontractor Clauses. "Use of United States-flag vessels: The contractor agrees-

" (1) To utilize privately owned United States-flag commercial vessels to ship at least 50 percent of the gross tonnage (computed separately for dry bulk carriers, dry cargo liners, and tankers) involved, whenever shipping any equipment, material, or commodities pursuant to this contract, to the extent such vessels are available at fair and reasonable rates for United States-flag commercial vessels.

(2) To furnish within 20 days following the date of loading for shipments originating within the United States or within 30 working days following the date of loading for shipments originating outside the United States a legible copy of a rated, 'on-board' commercial ocean bill-of-lading in English for each shipment of cargo described in paragraph (b) (1) of this section to both the Contracting Officer (through the prime contractor in the case of subcontractor bills-of-lading) and to the Division of National Cargo, Office of Market Development, Maritime Administration, Washington, DC 20590.

(3) To insert the substance of the provisions of this clause in all subcontracts issued pursuant to this contract."

**SUBSURFACE INFORMATION:**

(7-1-95)

450

SP1 G112 C

Subsurface information is available on the roadway and structure portions of this project.

**MAINTENANCE OF THE PROJECT:**

(11-20-07) (Rev. 1-17-12)

104-10

SP1 G125

Revise the *2018 Standard Specifications* as follows:

**Page 1-39, Article 104-10 Maintenance of the Project, line 25,** add the following after the first sentence of the first paragraph:

All guardrail/guiderail within the project limits shall be included in this maintenance.

**Page 1-39, Article 104-10 Maintenance of the Project, line 30,** add the following as the last sentence of the first paragraph:

The Contractor shall perform weekly inspections of guardrail and guiderail and shall report damages to the Engineer on the same day of the weekly inspection. *Where damaged guardrail or guiderail is repaired or replaced as a result of maintaining the project in accordance with this article, such repair or replacement shall be performed within 7 consecutive calendar days of such inspection report.*

**Page 1-39, Article 104-10 Maintenance of the Project, lines 42-44,** replace the last sentence of the last paragraph with the following:

The Contractor will not be directly compensated for any maintenance operations necessary, except for maintenance of guardrail/guiderail, as this work will be considered incidental to the work covered by the various contract items. The provisions of Article 104-7, Extra Work, and Article 104-8, Compensation and Record Keeping will apply to authorized maintenance of guardrail/guiderail. Performance of weekly inspections of guardrail/guiderail, and the damage reports required as described above, will be considered to be an incidental part of the work being paid for by the various contract items.

**ELECTRONIC BIDDING:**

(2-19-19)

101, 102, 103

SP1 G140

Revise the *2018 Standard Specifications* as follows:

**Page 1-4, Article 101-3, DEFINITIONS, BID (OR PROPOSAL) *Electronic Bid*, line 1,** replace “Bid Express®” with “the approved electronic bidding provider”.

**Page 1-15, Subarticle 102-8(B), Electronic Bids, lines 39-40,** replace “to Bid Express®” with “via the approved electronic bidding provider”.

**Page 1-15, Subarticle 102-8(B)(1), Electronic Bids, line 41,** delete “from Bid Express®”

**Page 1-17, Subarticle 102-9(C)(2), Electronic Bids, line 21,** replace “Bid Express® miscellaneous folder within the .ebs” with “electronic submittal”.

**Page 1-29, Subarticle 103-4(C)(2), Electronic Bids, line 32,** replace “.ebs miscellaneous data file of Expedite” with “electronic submittal file”

**AWARD LIMITS:**

(4-19-22)

103

SP1 G141

Revise the *2018 Standard Specifications* as follows:

**Page 1-29, Subarticle 103-4(C), Award Limits, line 4-8,** delete and replace the first sentence in the first paragraph with the following:

A bidder who desires to bid on more than one project on which bids are to be opened in the same letting and who desires to avoid receiving an award of more projects than he is equipped to handle, may bid on any number of projects but may limit the total amount of work awarded to him on selected projects by completing the form Award Limits on Multiple Projects for each project subject to the award limit.

**TWELVE MONTH GUARANTEE:**

(7-15-03)

108

SP1 G145

- (A) The Contractor shall guarantee materials and workmanship against latent and patent defects arising from faulty materials, faulty workmanship or negligence for a period of twelve months following the date of final acceptance of the work for maintenance and shall replace such defective materials and workmanship without cost to the Department. The Contractor will not be responsible for damage due to faulty design, normal wear and tear, for negligence on the part of the Department, and/or for use in excess of the design.
- (B) Where items of equipment or material carry a manufacturer’s guarantee for any period in excess of twelve months, then the manufacturer’s guarantee shall apply for that particular piece of equipment or material. The Department’s first remedy shall be through the manufacturer although the Contractor is responsible for invoking the warranted repair work with the manufacturer. The Contractor’s responsibility shall be limited to the term of the



manufacturer's guarantee. NCDOT would be afforded the same warranty as provided by the Manufacturer.

This guarantee provision shall be invoked only for major components of work in which the Contractor would be wholly responsible for under the terms of the contract. Examples would include pavement structures, bridge components, and sign structures. This provision will not be used as a mechanism to force the Contractor to return to the project to make repairs or perform additional work that the Department would normally compensate the Contractor for. In addition, routine maintenance activities (i.e. mowing grass, debris removal, ruts in earth shoulders,) are not parts of this guarantee.

Appropriate provisions of the payment and/or performance bonds shall cover this guarantee for the project.

To ensure uniform application statewide the Division Engineer will forward details regarding the circumstances surrounding any proposed guarantee repairs to the Chief Engineer for review and approval prior to the work being performed.

### **EROSION AND SEDIMENT CONTROL/STORMWATER CERTIFICATION:**

(1-16-07) (Rev 12-15-20)

105-16, 225-2, 16

SP1 G180

#### **General**

Schedule and conduct construction activities in a manner that will minimize soil erosion and the resulting sedimentation and turbidity of surface waters. Comply with the requirements herein regardless of whether or not a National Pollution discharge Elimination System (NPDES) permit for the work is required.

Establish a chain of responsibility for operations and subcontractors' operations to ensure that the *Erosion and Sediment Control/Stormwater Pollution Prevention Plan* is implemented and maintained over the life of the contract.

- (A) *Certified Supervisor* - Provide a certified Erosion and Sediment Control/Stormwater Supervisor to manage the Contractor and subcontractor operations, insure compliance with Federal, State and Local ordinances and regulations, and manage the Quality Control Program.
- (B) *Certified Foreman* - Provide a certified, trained foreman for each construction operation that increases the potential for soil erosion or the possible sedimentation and turbidity of surface waters.
- (C) *Certified Installer* - Provide a certified installer to install or direct the installation for erosion or sediment/stormwater control practices.
- (D) *Certified Designer* - Provide a certified designer for the design of the erosion and sediment control/stormwater component of reclamation plans and, if applicable, for the design of the project erosion and sediment control/stormwater plan.

## Roles and Responsibilities

- (A) *Certified Erosion and Sediment Control/Stormwater Supervisor* - The Certified Supervisor shall be Level II and responsible for ensuring the erosion and sediment control/stormwater plan is adequately implemented and maintained on the project and for conducting the quality control program. The Certified Supervisor shall be on the project within 24 hours notice from initial exposure of an erodible surface to the project's final acceptance. Perform the following duties:
- (1) **Manage Operations** - Coordinate and schedule the work of subcontractors so that erosion and sediment control/stormwater measures are fully executed for each operation and in a timely manner over the duration of the contract.
    - (a) Oversee the work of subcontractors so that appropriate erosion and sediment control/stormwater preventive measures are conformed to at each stage of the work.
    - (b) Prepare the required National Pollutant Discharge Elimination System (NPDES) Inspection Record and submit to the Engineer.
    - (c) Attend all weekly or monthly construction meetings to discuss the findings of the NPDES inspection and other related issues.
    - (d) Implement the erosion and sediment control/stormwater site plans requested.
    - (e) Provide any needed erosion and sediment control/stormwater practices for the Contractor's temporary work not shown on the plans, such as, but not limited to work platforms, temporary construction, pumping operations, plant and storage yards, and cofferdams.
    - (f) Acquire applicable permits and comply with requirements for borrow pits, dewatering, and any temporary work conducted by the Contractor in jurisdictional areas.
    - (g) Conduct all erosion and sediment control/stormwater work in a timely and workmanlike manner.
    - (h) Fully perform and install erosion and sediment control/stormwater work prior to any suspension of the work.
    - (i) Coordinate with Department, Federal, State and Local Regulatory agencies on resolution of erosion and sediment control/stormwater issues due to the Contractor's operations.
    - (j) Ensure that proper cleanup occurs from vehicle tracking on paved surfaces or any location where sediment leaves the Right-of-Way.
    - (k) Have available a set of erosion and sediment control/stormwater plans that are initialed and include the installation date of Best Management Practices. These practices shall include temporary and permanent groundcover and be properly updated to reflect necessary plan and field changes for use and review by Department personnel as well as regulatory agencies.
  - (2) **Requirements set forth under the NPDES Permit** - The Department's NPDES Stormwater permit (NCS000250) outlines certain objectives and management measures pertaining to construction activities. The permit references *NCG010000, General Permit to Discharge Stormwater* under the NPDES, and states that the

Department shall incorporate the applicable requirements into its delegated Erosion and Sediment Control Program for construction activities disturbing one or more acres of land. The Department further incorporates these requirements on all contracted bridge and culvert work at jurisdictional waters, regardless of size. Some of the requirements are, but are not limited to:

- (a) Control project site waste to prevent contamination of surface or ground waters of the state, i.e. from equipment operation/maintenance, construction materials, concrete washout, chemicals, litter, fuels, lubricants, coolants, hydraulic fluids, any other petroleum products, and sanitary waste.
  - (b) Inspect erosion and sediment control/stormwater devices and stormwater discharge outfalls at least once every 7 calendar days and within 24 hours after a rainfall event equal to or greater than 1.0 inch that occurs within a 24 hour period. Additional monitoring may be required at the discretion of Division of Water Resources personnel if the receiving stream is 303(d) listed for turbidity and the project has had documented problems managing turbidity.
  - (c) Maintain an onsite rain gauge or use the Department's Multi-Sensor Precipitation Estimate website to maintain a daily record of rainfall amounts and dates.
  - (d) Maintain erosion and sediment control/stormwater inspection records for review by Department and Regulatory personnel upon request.
  - (e) Implement approved reclamation plans on all borrow pits, waste sites and staging areas.
  - (f) Maintain a log of turbidity test results as outlined in the Department's Procedure for Monitoring Borrow Pit Discharge.
  - (g) Provide secondary containment for bulk storage of liquid materials.
  - (h) Provide training for employees concerning general erosion and sediment control/stormwater awareness, the Department's NPDES Stormwater Permit NCS000250 requirements, and the applicable requirements of the *General Permit, NCG010000*.
  - (i) Report violations of the NPDES permit to the Engineer immediately who will notify the Division of Water Quality Regional Office within 24 hours of becoming aware of the violation.
- (3) Quality Control Program - Maintain a quality control program to control erosion, prevent sedimentation and follow provisions/conditions of permits. The quality control program shall:
- (a) Follow permit requirements related to the Contractor and subcontractors' construction activities.
  - (b) Ensure that all operators and subcontractors on site have the proper erosion and sediment control/stormwater certification.
  - (c) Notify the Engineer when the required certified erosion and sediment control/stormwater personnel are not available on the job site when needed.
  - (d) Conduct the inspections required by the NPDES permit.
  - (e) Take corrective actions in the proper timeframe as required by the NPDES permit for problem areas identified during the NPDES inspections.

- (f) Incorporate erosion control into the work in a timely manner and stabilize disturbed areas with mulch/seed or vegetative cover on a section-by-section basis.
  - (g) Use flocculants approved by state regulatory authorities where appropriate and where required for turbidity and sedimentation reduction.
  - (h) Ensure proper installation and maintenance of temporary erosion and sediment control devices.
  - (i) Remove temporary erosion or sediment control devices when they are no longer necessary as agreed upon by the Engineer.
  - (j) The Contractor's quality control and inspection procedures shall be subject to review by the Engineer. Maintain NPDES inspection records and make records available at all times for verification by the Engineer.
- (B) *Certified Foreman* - At least one Certified Foreman shall be onsite for each type of work listed herein during the respective construction activities to control erosion, prevent sedimentation and follow permit provisions:
- (1) Foreman in charge of grading activities
  - (2) Foreman in charge of bridge or culvert construction over jurisdictional areas
  - (3) Foreman in charge of utility activities

The Contractor may request to use the same person as the Level II Supervisor and Level II Foreman. This person shall be onsite whenever construction activities as described above are taking place. This request shall be approved by the Engineer prior to work beginning.

The Contractor may request to name a single Level II Foreman to oversee multiple construction activities on small bridge or culvert replacement projects. This request shall be approved by the Engineer prior to work beginning.

- (C) *Certified Installers* - Provide at least one onsite, Level I Certified Installer for each of the following erosion and sediment control/stormwater crew:
- (1) Seeding and Mulching
  - (2) Temporary Seeding
  - (3) Temporary Mulching
  - (4) Sodding
  - (5) Silt fence or other perimeter erosion/sediment control device installations
  - (6) Erosion control blanket installation
  - (7) Hydraulic tackifier installation
  - (8) Turbidity curtain installation
  - (9) Rock ditch check/sediment dam installation
  - (10) Ditch liner/matting installation
  - (11) Inlet protection
  - (12) Riprap placement
  - (13) Stormwater BMP installations (such as but not limited to level spreaders, retention/detention devices)
  - (14) Pipe installations within jurisdictional areas

If a Level I *Certified Installer* is not onsite, the Contractor may substitute a Level II Foreman for a Level I Installer, provided the Level II Foreman is not tasked to another crew requiring Level II Foreman oversight.

- (D) *Certified Designer* - Include the certification number of the Level III Certified Designer on the erosion and sediment control/stormwater component of all reclamation plans and if applicable, the certification number of the Level III Certified Designer on the design of the project erosion and sediment control/stormwater plan.

### **Preconstruction Meeting**

Furnish the names of the *Certified Erosion and Sediment Control/Stormwater Supervisor*, *Certified Foremen*, *Certified Installers* and *Certified Designer* and notify the Engineer of changes in certified personnel over the life of the contract within 2 days of change.

### **Ethical Responsibility**

Any company performing work for the North Carolina Department of Transportation has the ethical responsibility to fully disclose any reprimand or dismissal of an employee resulting from improper testing or falsification of records.

### **Revocation or Suspension of Certification**

Upon recommendation of the Chief Engineer to the certification entity, certification for *Supervisor*, *Certified Foremen*, *Certified Installers* and *Certified Designer* may be revoked or suspended with the issuance of an *Immediate Corrective Action (ICA)*, *Notice of Violation (NOV)*, or *Cease and Desist Order* for erosion and sediment control/stormwater related issues.

The Chief Engineer may recommend suspension or permanent revocation of certification due to the following:

- (A) Failure to adequately perform the duties as defined within this certification provision.
- (B) Issuance of an ICA, NOV, or Cease and Desist Order.
- (C) Failure to fully perform environmental commitments as detailed within the permit conditions and specifications.
- (D) Demonstration of erroneous documentation or reporting techniques.
- (E) Cheating or copying another candidate's work on an examination.
- (F) Intentional falsification of records.
- (G) Directing a subordinate under direct or indirect supervision to perform any of the above actions.
- (H) Dismissal from a company for any of the above reasons.
- (I) Suspension or revocation of one's certification by another entity.

Suspension or revocation of a certification will be sent by certified mail to the certificant and the Corporate Head of the company that employs the certificant.

A certificant has the right to appeal any adverse action which results in suspension or permanent revocation of certification by responding, in writing, to the Chief Engineer within 10 calendar days after receiving notice of the proposed adverse action.

Chief Engineer  
1536 Mail Service Center  
Raleigh, NC 27699-1536

Failure to appeal within 10 calendar days will result in the proposed adverse action becoming effective on the date specified on the certified notice. Failure to appeal within the time specified will result in a waiver of all future appeal rights regarding the adverse action taken. The certificant will not be allowed to perform duties associated with the certification during the appeal process.

The Chief Engineer will hear the appeal and make a decision within 7 days of hearing the appeal. Decision of the Chief Engineer will be final and will be made in writing to the certificant.

If a certification is temporarily suspended, the certificant shall pass any applicable written examination and any proficiency examination, at the conclusion of the specified suspension period, prior to having the certification reinstated.

### **Measurement and Payment**

*Certified Erosion and Sediment Control/Stormwater Supervisor, Certified Foremen, Certified Installers and Certified Designer* will be incidental to the project for which no direct compensation will be made.

### **PROCEDURE FOR MONITORING BORROW PIT DISCHARGE:**

(2-20-07) (Rev. 4-5-19)

105-16, 230, 801

SP1 G181

Water discharge from borrow pit sites shall not cause surface waters to exceed 50 NTUs (nephelometric turbidity unit) in streams not designated as trout waters and 10 NTUs in streams, lakes or reservoirs designated as trout waters. For lakes and reservoirs not designated as trout waters, the turbidity shall not exceed 25 NTUs. If the turbidity exceeds these levels due to natural background conditions, the existing turbidity level shall not be increased.

If during any operating day, the downstream water quality exceeds the standard, the Contractor shall do all of the following:

- (A) Either cease discharge or modify the discharge volume or turbidity levels to bring the downstream turbidity levels into compliance, or
- (B) Evaluate the upstream conditions to determine if the exceedance of the standard is due to natural background conditions. If the background turbidity measurements exceed the standard, operation of the pit and discharge can continue as long as the stream turbidity levels are not increased due to the discharge.
- (C) Measure and record the turbidity test results (time, date and sampler) at all defined sampling locations 30 minutes after startup and at a minimum, one additional sampling of all sampling locations during that 24-hour period in which the borrow pit is discharging.

- (D) Notify DWQ within 24 hours of any stream turbidity standard exceedances that are not brought into compliance.

During the Environmental Assessment required by Article 230-4 of the *2018 Standard Specifications*, the Contractor shall define the point at which the discharge enters into the State's surface waters and the appropriate sampling locations. Sampling locations shall include points upstream and downstream from the point at which the discharge enters these waters. Upstream sampling location shall be located so that it is not influenced by backwater conditions and represents natural background conditions. Downstream sampling location shall be located at the point where complete mixing of the discharge and receiving water has occurred.

The discharge shall be closely monitored when water from the dewatering activities is introduced into jurisdictional wetlands. Any time visible sedimentation (deposition of sediment) on the wetland surface is observed, the dewatering activity will be suspended until turbidity levels in the stilling basin can be reduced to a level where sediment deposition does not occur. Staining of wetland surfaces from suspended clay particles, occurring after evaporation or infiltration, does not constitute sedimentation. No activities shall occur in wetlands that adversely affect the functioning of a wetland. Visible sedimentation will be considered an indication of possible adverse impacts on wetland use.

The Engineer will perform independent turbidity tests on a random basis. These results will be maintained in a log within the project records. Records will include, at a minimum, turbidity test results, time, date and name of sampler. Should the Department's test results exceed those of the Contractor's test results, an immediate test shall be performed jointly with the results superseding the previous test results of both the Department and the Contractor.

The Contractor shall use the *NCDOT Turbidity Reduction Options for Borrow Pits Matrix*, available at <https://connect.ncdot.gov/resources/roadside/FieldOperationsDocuments/TurbidityReductionOptionSheet.pdf> to plan, design, construct, and maintain BMPs to address water quality standards. Tier I Methods include stilling basins which are standard compensatory BMPs. Other Tier I methods are noncompensatory and shall be used when needed to meet the stream turbidity standards. Tier II Methods are also noncompensatory and are options that may be needed for protection of rare or unique resources or where special environmental conditions exist at the site which have led to additional requirements being placed in the DWQ's 401 Certifications and approval letters, Isolated Wetland Permits, Riparian Buffer Authorization or a DOT Reclamation Plan's Environmental Assessment for the specific site. Should the Contractor exhaust all Tier I Methods on a site exclusive of rare or unique resources or special environmental conditions, Tier II Methods may be required by regulators on a case by case basis per supplemental agreement.

The Contractor may use cation exchange capacity (CEC) values from proposed site borings to plan and develop the bid for the project. CEC values exceeding 15 milliequivalents per 100 grams of soil may indicate a high potential for turbidity and should be avoided when dewatering into surface water is proposed.

No additional compensation for monitoring borrow pit discharge will be paid.

**PROJECT SPECIAL PROVISIONS****ROADWAY****CLEARING AND GRUBBING - METHOD III:**

(4-6-06) (Rev.8-18-15)

200

SP2 R02B

Perform clearing on this project to the limits established by Method “III” shown on Standard Drawing No. 200.03 of the *2018 Roadway Standard Drawings*. Conventional clearing methods may be used except where permit drawings or conditions have been included in the proposal which require certain areas to be cleared by hand methods.

**BURNING RESTRICTIONS:**

(7-1-95)

200, 210, 215

SP2 R05

Open burning is not permitted on any portion of the right-of-way limits established for this project. Do not burn the clearing, grubbing or demolition debris designated for disposal and generated from the project at locations within the project limits, off the project limits or at any waste or borrow sites in this county. Dispose of the clearing, grubbing and demolition debris by means other than burning, according to state or local rules and regulations.

**BUILDING REMOVAL:**

(1-1-02) (Rev. 11-15-16)

215

SP2 R15 C

Remove the buildings and appurtenances listed below in accordance with Section 215 of the *2018 Standard Specifications*:

Parcel 022 – Right and Left of Approx. Survey Station 57+70, Survey Line –L-  
One Story Brick Dwelling

Parcel 026 – Left of Approx. Survey Station 62+30, Survey Line –L-  
One Story Brick Dwelling

When the description of the work for an item indicates a building partially inside and partially outside the right of way and/or construction area, but does not require the building to be cut off, the entire building shall be removed.

**SHOULDER AND FILL SLOPE MATERIAL:**

(5-21-02)

235, 560

SP2 R45 B

**Description**

Perform the required shoulder and slope construction for this project in accordance with the applicable requirements of Section 560 and Section 235 of the *2018 Standard Specifications*.

**Measurement and Payment**

When the Contractor elects to obtain material from an area located beneath a proposed fill sections which does not require excavation for any reason other than to generate acceptable shoulder and fill slope material, the work of performing the excavation will be considered incidental to the item of *Borrow Excavation* or *Shoulder Borrow*. If there is no pay item for *Borrow* or *Shoulder Borrow*



in the contract, this work will be considered incidental to *Unclassified Excavation*. Stockpile the excavated material in a manner to facilitate measurement by the Engineer. Fill the void created by the excavation of the shoulder and fill slope material with suitable material. Payment for material used from the stockpile will be made at the contract unit price for *Borrow Excavation* or *Shoulder Borrow*. If there is no pay item for *Borrow Excavation* or *Shoulder Borrow*, then the material will be paid for at the contract unit price for *Unclassified Excavation*. The material used to fill the void created by the excavation of the shoulder and fill slope material will be made at the contract unit price for *Unclassified Excavation*, *Borrow Excavation*, or *Shoulder Borrow*, depending on the source of the material.

Material generated from undercut excavation, unclassified excavation or clearing and grubbing operations that is placed directly on shoulders or slope areas, will not be measured separately for payment, as payment for the work requiring the excavation will be considered adequate compensation for depositing and grading the material on the shoulders or slopes.

When undercut excavation is performed at the direction of the Engineer and the material excavated is found to be suitable for use as shoulder and fill slope material, and there is no area on the project currently prepared to receive the material generated by the undercut operation, the Contractor may construct a stockpile for use as borrow at a later date. Payment for the material used from the stockpile will be made at the contract unit price for *Borrow Excavation* or *Shoulder Borrow*.

When shoulder material is obtained from borrow sources or from stockpiled material, payment for the work of shoulder construction will be made at the contract unit price per cubic yard for *Borrow Excavation* or *Shoulder Borrow* in accordance with the applicable provisions of Section 230 or Section 560 of the *2018 Standard Specifications*.

### **MANUFACTURED QUARRY FINES IN EMBANKMENTS:**

(01-17-17)

235

SP02 R72

#### **Description**

This specification addresses the use of manufactured quarry fines that are not classified as select materials. The specification allows the Contractor an option, with the approval of the Engineer, to use manufactured quarry fines (MQFs) in embankments as a substitute for conventional borrow material. Furnish and place geotextile for pavement stabilization in accordance with the Geotextile for Pavement Stabilization special provision and detail. Geotextile for pavement stabilization is required to prevent pavement cracking and provide separation between the subgrade and pavement section at embankment locations where manufactured quarry fines are utilized and as directed by the Engineer.

#### **Materials**

Manufactured Quarry Fines.

Site specific approval of MQFs material will be required prior to beginning construction as detailed in the preconstruction requirements of this provision.

The following MQFs are unacceptable:

- (A) Frozen material,
- (B) Material with a maximum dry unit weight of less than 90 pounds per cubic foot when tested in accordance with AASHTO T-99 Method A or C.
- (C) Material with greater than 80% by weight Passing the #200 sieve

Collect and transport MQFs in a manner that will prevent nuisances and hazards to public health and safety. Moisture condition the MQFs as needed and transport in covered trucks to prevent dusting. If MQFs are blended with natural earth material, follow Borrow Criteria in Section 1018 of the *Standard Specifications*.

### **Geotextiles**

Areas of embankment where MQFs are incorporated, Geotextile for Pavement Stabilization shall be used. If the Geotextile for Pavement Stabilization special provision is not included elsewhere in this contract, then it along with a detail will be incorporated as part of the contractors request to use. Notification of subgrade elevation, sampling and waiting period as required in the Construction Methods section of the Geotextile for Pavement Stabilization special provision are not required.

### **Preconstruction Requirements**

When MQFs are to be used as a substitute for earth borrow material, request written approval from the Engineer at least ninety (90) days in advance of the intent to use MQFs and include the following details:

- (A) Description, purpose and location of project.
- (B) Estimated start and completion dates of project.
- (C) Estimated volume of MQFs to be used on project with specific locations and construction details of the placement.
- (D) The names, address, and contact information for the generator of the MQFs.
- (E) Physical location of the site at which the MQFs were generated.

The Engineer will forward this information to the State Materials Engineer for review and material approval.

### **Construction Methods**

Place MQFs in the core of the embankment section with at least 4 feet of earth cover to the outside limits of the embankments or subgrade.

Construct embankments by placing MQFs in level uniform lifts with no more than a lift of 10 inches and compacted to at least a density of 95 percent as determined by test methods in AASHTO T-99, Determination of Maximum Dry Density and Optimum Moisture Content, Method A or C depending upon particle size of the product. Provide a moisture content at the time of compaction of within 4 percent of optimum but not greater than one percent above optimum as determined by AASHTO T-99, Method A or C.

Areas of embankment where MQFs are incorporated, Geotextile for Pavement Stabilization shall be used. See Geotextile for Pavement Stabilization special provision for geotextile type and construction method.

### **Measurement and Payment**

*Borrow Excavation* will be measured by truck volume and paid in cubic yards in accordance with Article 230-5 of the *2018 Standard Specifications*. As an alternate weigh tickets can be provided and payment made by converting weight to cubic yards based on the verifiable unit weight.

Where the pay item of *Geotextile for Pavement Stabilization* is included in the original contract

the material will be measured and paid in square yards (see Geotextile for Pavement Stabilization special provision). Where the pay item of *Geotextile for Pavement Stabilization* is not included in the original contract then no payment will be made for this item and will be considered incidental to the use of MQFs in embankment.

**CULVERT PIPE:**

(8-20-19)(Rev. 5-17-22)

305.310

SP3 R35

Revise the *2018 Standard Specifications* as follows:

**Page 3-5, Article 305-1 DESCRIPTION**, lines 12-14, replace with the following:

Where shown in the plans, the Contractor may use reinforced concrete pipe, aluminum alloy pipe, aluminized corrugated steel pipe, galvanized corrugated steel pipe, HDPE pipe, Polypropylene pipe or PVC pipe in accordance with the following requirements.

**Page 3-5, Article 305-2 MATERIALS**, add the following after line 16:

<b>Item</b>	<b>Section</b>
Polypropylene Pipe	1032-9
Galvanized Corrugated Steel Pipe	1032-3

**Page 3-6, Article 310-2 MATERIALS**, add the following after line 9:

<b>Item</b>	<b>Section</b>
Polypropylene Pipe	1032-9
Galvanized Corrugated Steel Pipe	1032-3

**Page 3-6, Article 310-4 SIDE DRAIN PIPE**, lines 24-25, replace the first sentence of the second paragraph with the following:

Where shown in the plans, side drain pipe may be Class II reinforced concrete pipe, aluminized corrugated steel pipe, galvanized corrugated steel pipe, corrugated aluminum alloy pipe, Polypropylene pipe, HDPE pipe or PVC pipe.

**Page 3-7, Article 310-5 PIPE END SECTIONS**, lines 2-4, replace the second sentence with the following:

Both corrugated steel and concrete pipe end sections will work on concrete pipe, corrugated steel pipe, Polypropylene pipe and HDPE smooth lined corrugated plastic pipe.

**Page 3-7, Article 310-6 MEASUREMENT AND PAYMENT**, add the following after line 14:

<b>Pay Item</b>	<b>Pay Unit</b>
___" Polypropylene Pipe	Linear Foot

**Page 10-60, add Article 1032-9:**

(A) General

Use polypropylene pipe from sources participating in the Department's Polypropylene Pipe QA/QC Program. A list of participating sources is available from the Materials and Tests Unit. The Department will remove a manufacturer of polypropylene pipe from this program if the monitoring efforts indicated that non-specification material is being provided or test procedures are not being followed.

Use polypropylene culvert pipe that meets AASHTO M 330 for Type S or Type D, or ASTM F2881 or ASTM F2764 Double or Triple wall; and has been evaluated by NTPEP.

**(B) End Treatments, Pipe Tees and Elbows**

End treatments, pipe tees and elbows shall meet AASHTO M 330, Section 7.7, or ASTM F2764, Section 6.6.

**(C) Marking**

Clearly mark each section of pipe, end section, tee and elbow and other accessories according to the Department's Polypropylene Pipe QC/QA Program:

- (1) AASHTO or ASTM Designation
- (2) The date of manufacture
- (3) Name or trademark of the manufacturer

When polypropylene pipe, end sections, tees and elbows have been inspected and accepted a sticker will be applied to the inside of the pipe. Do not use pipe sections, flared end sections, tees or elbows which do not have this seal of approval.

**AGGREGATE SUBGRADE:**

(5-15-18)

505

SP5 R8

Revise the *2018 Standard Specifications* as follows:

**Page 5-8, Article 505-1 DESCRIPTION, lines 4-6,** replace the paragraph with the following:

Construct aggregate subgrades in accordance with the contract. Install geotextile for soil stabilization and place Class IV subgrade stabilization at locations shown in the plans and as directed.

Undercut natural soil materials if necessary to construct aggregate subgrades. Define "subbase" as the portion of the roadbed below the Class IV subgrade stabilization. For Type 2 aggregate subgrades, undercut subbases as needed. The types of aggregate subgrade with thickness and compaction requirements for each are as shown below.

**Type 1** – A 6 to 24 inch thick aggregate subgrade with Class IV subgrade stabilization compacted to 92% of AASHTO T 180 as modified by the Department or to the highest density that can be reasonably obtained.

**Type 2** – An 8 inch thick aggregate subgrade on a proof rolled subbase with Class IV subgrade

stabilization compacted to 97% of AASHTO T 180 as modified by the Department.

**Page 5-8, Article 505-3 CONSTRUCTION METHODS, line 12**, insert the following after the first sentence of the first paragraph:

For Type 2 aggregate subgrades, proof roll subbases in accordance with Section 260 before installing geotextile for soil stabilization.

**Page 5-8, Article 505-3 CONSTRUCTION METHODS, lines 16-17**, replace the last sentence of the first paragraph with the following:

Compact ABC as required for the type of aggregate subgrade constructed.

**Page 5-8, Article 505-4 MEASUREMENT AND PAYMENT, line 26**, insert the following after the last sentence of the first paragraph:

*Undercut Excavation* of natural soil materials from subbases for Type 2 aggregate subgrades will be measured and paid in accordance with Article 225-7 or 226-3. No measurement will be made for any undercut excavation of fill materials from subbases.

### **DITCHING:**

1-18-05

SPI 2-02

### **Description**

The Contractor's attention is directed to the fact that there are areas where existing ditches need to be cleaned in conjunction with resurfacing.

The ditching operation is to be used as directed by the Engineer where existing ditches are excessively overgrown or obstructed. The Contractor shall restore proper drainage by cleaning the ditch to a condition acceptable to the Engineer.

Material removed from drainage ditches shall be disposed of in waste areas furnished by the Contractor or as directed by the Engineer in accordance with Section 240 of the *Standard Specifications*.

### **Measurement and Payment**

The quantity of such work to be paid for will be the actual number of linear feet of ditch, which has been cleaned. The quantity will be paid for at the contract unit price per linear foot for "Ditching". Such price and payment will be full compensation for removal and disposal of debris, seeding and mulching of the ditch line, and all incidentals associated with performing this work.

Payment will be made under:

**Pay Item**  
Ditching

**Pay Unit**  
Linear Foot

**PRICE ADJUSTMENT - ASPHALT BINDER FOR PLANT MIX:**

(11-21-00)

620

SP6 R25

Price adjustments for asphalt binder for plant mix will be made in accordance with Section 620 of the *2018 Standard Specifications*.

The base price index for asphalt binder for plant mix is \$ **751.11** per ton.

This base price index represents an average of F.O.B. selling prices of asphalt binder at supplier's terminals on **June 1, 2022**.

**ASPHALT CONCRETE PLANT MIX PAVEMENTS:**

(2-20-18) (Rev.1-15-19)

610, 1012

SP6 R65

Revise the *2018 Standard Specifications* as follows:

**Page 6-14, Table 609-3, LIMITS OF PRECISION FOR TEST RESULTS**, replace with the following:

<b>TABLE 609-3 LIMITS OF PRECISION FOR TEST RESULTS</b>	
<b>Mix Property</b>	<b>Limits of Precision</b>
25.0 mm sieve (Base Mix)	± 10.0%
19.0 mm sieve (Base Mix)	± 10.0%
12.5 mm sieve (Intermediate & Type P-57)	± 6.0%
9.5 mm sieve (Surface Mix)	± 5.0%
4.75 mm sieve (Surface Mix)	± 5.0%
2.36 mm sieve (All Mixes, except S4.75A)	± 5.0%
1.18 mm sieve (S4.75A)	± 5.0%
0.075 mm sieve (All Mixes)	± 2.0%
Asphalt Binder Content	± 0.5%
Maximum Specific Gravity ( $G_{mm}$ )	± 0.020
Bulk Specific Gravity ( $G_{mb}$ )	± 0.030
TSR	± 15.0%
QA retest of prepared QC Gyratory Compacted Volumetric Specimens	± 0.015
Retest of QC Core Sample	± 1.2% (% Compaction)
Comparison QA Core Sample	± 2.0% (% Compaction)
QA Verification Core Sample	± 2.0% (% Compaction)
Density Gauge Comparison of QC Test	± 2.0% (% Compaction)
QA Density Gauge Verification Test	± 2.0% (% Compaction)

Page 6-17, Table 610-1, MIXING TEMPERATURE AT THE ASPHALT PLANT, replace with the following:

Binder Grade	JMF Temperature
PG 58-28; PG 64-22	250 - 290°F
PG 76-22	300 - 325°F

Page 6-17, Subarticle 610-3(C), Job Mix Formula (JMF), lines 38-39, delete the fourth paragraph.

Page 6-18, Subarticle 610-3(C), Job Mix Formula (JMF), line 12, replace “SF9.5A” with “S9.5B”.

Page 6-18, Table 610-3, MIX DESIGN CRITERIA, replace with the following:

Mix Type	Design ESALs millions <sup>A</sup>	Binder PG Grade	Compaction Levels		Max. Rut Depth (mm)	Volumetric Properties <sup>B</sup>			
			Gmm @			VMA % Min.	VTM %	VFA Min.-Max.	%Gmm @ N <sub>ini</sub>
			N <sub>ini</sub>	N <sub>des</sub>					
S4.75A	< 1	64 - 22	6	50	11.5	16.0	4.0 - 6.0	65 - 80	≤ 91.5
S9.5B	0 - 3	64 - 22	6	50	9.5	16.0	3.0 - 5.0	70 - 80	≤ 91.5
S9.5C	3 - 30	64 - 22	7	65	6.5	15.5	3.0 - 5.0	65 - 78	≤ 90.5
S9.5D	> 30	76 - 22	8	100	4.5	15.5	3.0 - 5.0	65 - 78	≤ 90.0
I19.0C	ALL	64 - 22	7	65	-	13.5	3.0 - 5.0	65 - 78	≤ 90.5
B25.0C	ALL	64 - 22	7	65	-	12.5	3.0 - 5.0	65 - 78	≤ 90.5
<b>Design Parameter</b>						<b>Design Criteria</b>			
All Mix Types	Dust to Binder Ratio (P <sub>0.075</sub> / P <sub>be</sub> )					0.6 - 1.4 <sup>C</sup>			
	Tensile Strength Ratio (TSR) <sup>D</sup>					85% Min. <sup>E</sup>			

- A. Based on 20 year design traffic.
- B. Volumetric Properties based on specimens compacted to N<sub>des</sub> as modified by the Department.
- C. Dust to Binder Ratio (P<sub>0.075</sub> / P<sub>be</sub>) for Type S4.75A is 1.0 - 2.0.
- D. NCDOT-T-283 (No Freeze-Thaw cycle required).
- E. TSR for Type S4.75A & B25.0C mixes is 80% minimum.

Page 6-19, Table 610-5, BINDER GRADE REQUIREMENTS (BASED ON RBR%), replace with the following:

Mix Type	%RBR ≤ 20%	21% ≤ %RBR ≤ 30%	%RBR ≥ 30%
S4.75A, S9.5B, S9.5C, I19.0C, B25.0C	PG 64-22	PG 64-22 <sup>A</sup>	PG-58-28
S9.5D, OGFC	PG 76-22 <sup>B</sup>	n/a	n/a

- A. If the mix contains any amount of RAS, the virgin binder shall be PG 58-28.
- B. Maximum Recycled Binder Replacement (%RBR) is 18% for mixes using PG 76-22 binder.

**Page 6-20, Table 610-6, PLACEMENT TEMPERATURES FOR ASPHALT**, replace with the following:

<b>Asphalt Concrete Mix Type</b>	<b>Minimum Surface and Air Temperature</b>
B25.0C	35°F
I19.0C	35°F
S4.75A, S9.5B, S9.5C	40°F <sup>A</sup>
S9.5D	50°F

A. For the final layer of surface mixes containing recycled asphalt shingles (RAS), the minimum surface and air temperature shall be 50°F.

**Page 6-21, Article 610-8, SPREADING AND FINISHING, lines 34-35**, delete the second sentence and replace with the following:

Use an MTV for all surface mix regardless of binder grade on Interstate, US Routes, and NC Routes (primary routes) that have 4 or more lanes and median divided.

**Page 6-21, Article 610-8, SPREADING AND FINISHING, lines 36-38**, delete the fourth sentence and replace with the following:

Use MTV for all ramps, loops, Y-line that have 4 or more lanes and are median divided, full width acceleration lanes, full width deceleration lanes, and full width turn lanes that are greater than 1000 feet in length.

**Page 6-23, Table 610-7, DENSITY REQUIREMENTS**, replace with the following:

<b>Mix Type</b>	<b>Minimum % G<sub>mm</sub> (Maximum Specific Gravity)</b>
S4.75A	85.0 <sup>A</sup>
S9.5B	90.0
S9.5C, S9.5D, I19.0C, B25.0C	92.0

A. Compaction to the above specified density will be required when the S4.75A mix is applied at a rate of 100 lbs/sy or higher.

**Page 6-24, Article 610-13, FINAL SURFACE TESTING, lines 35-36**, delete the second sentence and replace with the following:

Final surface testing is not required on ramps, loops and turn lanes.

**Page 6-26, Subarticle 610-13(A)(1), Acceptance for New Construction, lines 29-30**, delete the second sentence and replace with the following:



Areas excluded from testing by the profiler may be tested using a 10-foot straightedge in accordance with Article 610-12.

**Page 6-27, Subarticle 610-13(B), Option 2- North Carolina Hearne Straightedge, lines 41-46,** delete the eighth and ninth sentence of this paragraph and replace with the following:

Take profiles over the entire length of the final surface travel lane pavement exclusive of structures, approach slabs, paved shoulders, tapers, or other irregular shaped areas of pavement, unless otherwise approved by the Engineer. Test in accordance with this provision all mainline travel lanes, full width acceleration or deceleration lanes and collector lanes.

**Page 6-28, Subarticle 610-13(B), Option 2- North Carolina Hearne Straightedge, lines 1-2,** delete these two lines.

**Page 6-32, Article 610-16 MEASUREMENT AND PAYMENT,** replace with the following:

<b>Pay Item</b>	<b>Pay Unit</b>
Asphalt Concrete Base Course, Type B25.0C	Ton
Asphalt Concrete Intermediate Course, Type I19.0C	Ton
Asphalt Concrete Surface Course, Type S4.75A	Ton
Asphalt Concrete Surface Course, Type S9.5B	Ton
Asphalt Concrete Surface Course, Type S9.5C	Ton
Asphalt Concrete Surface Course, Type S9.5D	Ton

**Page 10-30, Table 1012-1, AGGREGATE CONSENSUS PROPERTIES,** replace with the following:

**TABLE 1012-1  
AGGREGATE CONSENSUS PROPERTIES<sup>A</sup>**

<b>Mix Type</b>	<b>Coarse Aggregate Angularity<sup>B</sup></b>	<b>Fine Aggregate Angularity % Minimum</b>	<b>Sand Equivalent % Minimum</b>	<b>Flat and Elongated 5 : 1 Ratio % Maximum</b>
<i>Test Method</i>	<i>ASTM D5821</i>	<i>AASHTO T 304</i>	<i>AASHTO T 176</i>	<i>ASTM D4791</i>
S4.75A; S9.5B	75 / -	40	40	-
S9.5C; I19.0C; B25.0C	95 / 90	45	45	10
S9.5D	100 / 100	45	50	10
OGFC	100 / 100	45	45	10
UBWC	100 / 85	45	45	10

A. Requirements apply to the design aggregate blend.

B. 95 / 90 denotes that 95% of the coarse aggregate has one fractured face and 90% has 2 or more fractured faces.

**AUTOMATED MACHINE GUIDANCE**

(1-2-11)

801

SP8 R01

**General**

This Special Provision contains requirements to be followed if the Contractor elects to use Global Positioning System (GPS) machine control grading and shall be used in conjunction with Section 801 of the *Standard Specifications*. The use of this technology is referenced as Automated Machine Guidance (AMG).

All equipment using AMG shall be able to generate end results that meet the *Standard Specifications*. Perform test sections for each type of work to be completed with AMG to demonstrate that the system has the capability to achieve acceptable results. If acceptable results cannot be achieved, conform to the requirements for conventional stakeout.

The Contractor shall be responsible for all errors resulting from the use of AMG and shall correct deficiencies to the satisfaction of the Engineer at no cost to the Department.

**Submittals**

If the Contractor elects to use AMG, a Digital Terrain Model (DTM) of the design surface and all intermediate surfaces shall be developed and submitted to the Engineer for review.

At least 90 days prior to beginning grading operations, the Contractor shall submit to the Engineer an AMG work plan to include, but not limited to, proposed equipment, control software manufacturer and version, types of work to be completed using AMG, project site calibration report, repetitive calibration methods for construction equipment and rover units to be used for the duration of the project, and local GPS base station to be used for broadcasting differential correction data to rover units (this may include the NC Network RTK). All surveys must be tied to existing project control as established by NCDOT.

**Inspection**

The Engineer will perform quality assurance checks of all work associated with AMG. If it is determined that work is not being performed in a manner that will assure accurate results, the Engineer may require corrective action at no cost to the Department.

The Contractor shall provide the Engineer with one GPS rover unit for use during the duration of the contract. The rover will be loaded with the same model that is used with the AMG and have the same capability as rover units used by the Contractor. The rover will be kept in the possession of the Engineer and will be returned to the Contractor upon completion of the contract. Any maintenance or repairs required for the rover will be the responsibility of the Contractor. Formal training of at least 8 hours shall be provided to the Engineer by the Contractor on the use of the proposed AMG system.

**Subgrade and Base Controls**

If the Contractor elects to use AMG for fine grading and placement of base or other roadway materials, the GPS shall be supplemented with a laser or robotic total station. Include details of

the proposed system in the AMG work plan. In addition, the following requirements apply for the use of AMG for subgrade and base construction.

Provide control points at intervals along the project not to exceed 1,000 feet. The horizontal position of these points shall be determined by static GPS sessions or by traverse connection from the original base line control points. The elevation of these control points shall be established using differential leveling from project benchmarks, forming closed loops where practical. A copy of all new control point information shall be provided to the Engineer prior to construction activities.

Provide control points and conventional survey grade stakes at 500 foot intervals and at critical points such as, but not limited to, PCs, PTs, superelevation transition points, and other critical points as requested by the Engineer.

Provide hubs at the top of the finished subgrade at all hinge points on the cross section at 500 foot intervals. These hubs shall be established using conventional survey methods for use by the Engineer to check the accuracy of construction.

### **Measurement and Payment**

No direct payment will be made for work required to utilize this provision. All work will be considered incidental to various grading operations.

#### **SUPPLEMENTAL SURVEYING:**

(4-20-21)

801

SP8 R03

Revise the *2018 Standard Specifications* as follows:

**Page 8-7, Article 801-3 MEASUREMENT AND PAYMENT**, lines 10-11, replace with the following:

*Supplemental Surveying Office Calculations* will be paid at the stated price of \$85.00 per hour. *Supplemental Field Surveying* will be paid at the stated price of \$145.00 per hour. The

#### **GUARDRAIL END UNITS, TYPE - TL-3:**

(4-20-04) (Rev. 7-1-17)

862

SP8 R65

### **Description**

Furnish and install guardrail end units in accordance with the details in the plans, the applicable requirements of Section 862 of the *2018 Standard Specifications*, and at locations shown in the plans.

### **Materials**

Furnish guardrail end units listed on the NCDOT [Approved Products List](https://apps.dot.state.nc.us/vendor/approvedproducts/) at <https://apps.dot.state.nc.us/vendor/approvedproducts/> or approved equal.

Prior to installation the Contractor shall submit to the Engineer:

- (A) FHWA acceptance letter for each guardrail end unit certifying it meets the requirements of the AASHTO Manual for Assessing Safety Hardware, Test Level 3, in accordance with Article 106-2 of the *2018 Standard Specifications*.
- (B) Certified working drawings and assembling instructions from the manufacturer for each guardrail end unit in accordance with Article 105-2 of the *2018 Standard Specifications*.

No modifications shall be made to the guardrail end unit without the express written permission from the manufacturer. Perform installation in accordance with the details in the plans, and details and assembling instructions furnished by the manufacturer.

### **Construction Methods**

Guardrail end delineation is required on all approach and trailing end sections for both temporary and permanent installations. Guardrail end delineation consists of yellow reflective sheeting applied to the entire end section of the guardrail in accordance with Article 1088-3 of the *2018 Standard Specifications* and is incidental to the cost of the guardrail end unit.

### **Measurement and Payment**

Measurement and payment will be made in accordance with Article 862-6 of the *2018 Standard Specifications*.

Payment will be made under:

<b>Pay Item</b>	<b>Pay Unit</b>
Guardrail End Units, Type TL-3	Each

### **GUARDRAIL ANCHOR UNITS AND TEMPORARY GUARDRAIL ANCHOR UNITS:**

(1-16-2018)

862

SP8 R70

Guardrail anchor units will be in accordance with the details in the plans and the applicable requirements of Section 862 of the *2018 Standard Specifications*.

Revise the *2018 Standard Specifications* as follows:

**Page 8-42, Article 862-6 MEASUREMENT AND PAYMENT**, add the following:

*Guardrail Anchor Units, Type \_\_\_ and Temporary Guardrail Anchor Units Type \_\_\_* will be measured and paid as units of each completed and accepted. No separate measurement will be made of any rail, terminal sections, posts, offset blocks, concrete, hardware or any other components of the completed unit that are within the pay limits shown in the plans for the unit as all such components will be considered to be part of the unit.

Payment will be made under:

<b>Pay Item</b>	<b>Pay Unit</b>
Guardrail Anchor Units, Type ___	Each
Temporary Guardrail Anchor Units, Type ___	Each

**PEDESTRIAN SAFETY RAIL:**

(8-28-09)

SPD 8-600

Furnish and install steel pipe handrail at locations as shown in the plans, in accordance with the detail in the plans and as directed by the Engineer.

**Measurement and Payment**

*Pedestrian Safety Rail* will be measured and paid as the actual number of linear feet of steel pipe handrail measured along the top of the handrail to the nearest 0.1 of a foot. Such price and payment shall be full compensation for fabricating, furnishing, installing, painting and all incidentals necessary to satisfactorily install the handrail.

Payment will be made under:

**Pay Item**

Pedestrian Safety Rail

**Pay Unit**

Linear Foot

**PORTLAND CEMENT CONCRETE PRODUCTION AND DELIVERY:**

(9-15-20)

1000, 1014, 1024

SP10 R01

Revise the *2018 Standard Specifications* as follows:

**Page 10-6, Table 1000-1, REQUIREMENTS FOR CONCRETE**, replace with the following:

<b>TABLE 1000-1 REQUIREMENTS FOR CONCRETE</b>											
<b>Class of Concrete</b>	<b>Min. Compressive Strength at 28 days</b>	<b>Maximum Water-Cement Ratio</b>				<b>Consistency Maximum Slump</b>		<b>Cement Content</b>			
		<b>Air-Entrained Concrete</b>		<b>Non-Air- Entrained Concrete</b>		<b>Vibrated</b>	<b>Non- Vibrated</b>	<b>Vibrated</b>		<b>Non-Vibrated</b>	
		Rounded Aggregate	Angular Aggregate	Rounded Aggregate	Angular Aggregate			Min.	Max.	Min.	Max.
		<i>Units</i>	<i>psi</i>					<i>inch</i>	<i>inch</i>	<i>lb/cy</i>	<i>lb/cy</i>
AA	4500	0.381	0.426	---	---	3.5 <sup>A</sup>	---	639	715	---	---
AA Slip Form	4500	0.381	0.426	---	---	1.5	---	639	715	---	---
Drilled Pier	4500	---	---	0.450	0.450	---	5 - 7 dry  7 - 9 wet	---	---	640	800
A	3000	0.488	0.532	0.550	0.594	3.5 <sup>A</sup>	4.0	564	---	602	---
B	2500	0.488	0.567	0.559	0.630	1.5 machine placed  2.5 <sup>A</sup>	4.0	508	---	545	---

						hand placed					
Sand Light-weight	4500	---	0.420	---	---	4.0 <sup>A</sup>	---	715	---	---	---
Latex Modified	3000 (at 7 days)	0.400	0.400	---	---	6.0	---	658	---	---	---
Flowable Fill excavatable	150 max. (at 56 days)	as needed	as needed	as needed	as needed	---	Flowable	---	---	40	100
Flowable Fill non-excavatable	125	as needed	as needed	as needed	as needed	---	Flowable	---	---	100	as needed
Pavement	4500 Design, field 650 flexural, design only	0.559	0.559	---	---	1.5 slip form 3.0 hand placed	---	526	---	---	---
Precast	See Table 1077-1	as needed	as needed	---	---	6.0	as needed	as needed	as needed	as needed	as needed
Prestressed	per contract	See Table 1078-1	See Table 1078-1	---	---	8.0	---	564	as needed	---	---

- A. The slump may be increased to 6 inches, provided the increase in slump is achieved by adding a chemical admixture conforming to Section 1024-3. In no case shall the water-cement ratio on the approved design be exceeded. Concrete exhibiting segregation and/or excessive bleeding will be rejected. Utilizing an Admixture to modify slump does not relinquish the contractor's responsibility to ensure the final product quality and overall configuration meets design specifications. Caution should be taken when placing these modified mixes on steep grades to prevent unintended changes to the set slope.

### **HIGH STRENGTH CONCRETE FOR DRIVEWAYS:**

(11-21-00) (Rev. 1-17-12)

848

SP10 R02

Use high early strength concrete for all driveways shown in the plans and as directed by the Engineer. Provide high early strength concrete that meets the requirements of Article 1000-5 of the *2018 Standard Specifications*.

Measurement and payment will be in accordance with Section 848 of the *2018 Standard Specifications*.

**THERMOPLASTIC INTERMIXED BEAD TESTING:**

7-19-22

1087

SP10 R04

Revise the *2018 Standard Specifications* as follows:

**Page 10-183, Subarticle 1087-7(B) Thermoplastic Pavement Marking Material Composition**, delete line 34 and 35.

**Page 10-184, Article 1087-8 MATERIAL CERTIFICATION**, delete and replace with the following after line 34:

Drop-on Glass Beads	Type 3 Material Certification and Type 4 Material Certification
Intermix Glass Beads	Type 2 Material Certification and Type 3 Material Certification
Paint	Type 3 Material Certification
Removable Tape	Type 3 Material Certification
Thermoplastic	Type 3 Material Certification and Type 4 Material Certification
Cold Applied Plastic	Type 2 Material Certification and Type 3 Material Certification
Polyurea	Type 2 Material Certification and Type 3 Material Certification

**THERMOPLASTIC PAVEMENT MARKING MATERIAL – COLOR TESTING:**

3-19-19

1087

SP10 R05

Revise the *2018 Standard Specifications* as follows:

**Pages 10-183 and 10-184, Subarticle 1087-7(D)(1)(b) Yellow**, lines 9-11, delete and replace with the following:

Obtain Color Values Y,x,y per ASTM E1349 using C/2° illuminant/observer.  
Results shall be  $Y \geq 45\%$ , and x,y shall fall within PR#1 chart chromaticity limits.

**MATERIALS FOR PORTLAND CEMENT CONCRETE:**

(9-15-20)

1000, 1024

SP10 R24

Revise the *2018 Standard Specifications* as follows:

**Page 10-52, Article 1024-4, WATER, lines 3-6**, delete and replace with the following:

Test water from wells at all locations. Test public water supplies from all out of state locations and in the following counties: Beaufort, Bertie, Brunswick, Camden, Carteret, Chowan, Craven, Currituck, Dare, Gates, Hyde, New Hanover, Onslow, Pamlico, Pasquotank, Pender, Perquimans, Tyrell and Washington unless the Engineer waives the testing requirements.

Page 10-52, Table 1024-2, PHYSICAL PROPERTIES OF WATER, replace with the following:

Property	Requirement	Test Method
Compression Strength, minimum percent of control at 3 and 7 days	90%	ASTM C1602
Time of set, deviation from control	From 1:00 hr. earlier to 1:30 hr. later	ASTM C1602
pH	4.5 to 8.5	ASTM D1293 *
Chloride Ion Content, Max.	250 ppm	ASTM D512 *
Total Solids Content (Residue), Max.	1,000 ppm	SM 2540B *
Resistivity, Min.	0.500 kohm-cm	ASTM D1125 *

\*Denotes an alternate method is acceptable. Test method used shall be referenced in the test report.

**MATERIAL AND EQUIPMENT STORAGE & PARKING OF PERSONAL VEHICLES:**

11-17-21

1101

SP11 R03

Revise the *2018 Standard Specifications* as follows:

Page 11-2, Article 1101-8 MATERIAL AND EQUIPMENT STORAGE, line 35-38, delete and replace with the following:

When work is not in progress, keep all personnel, equipment, machinery, tools, construction debris, materials and supplies away from active travel lanes that meets Table 1101-1.

TABLE 1101-1 MATERIAL AND EQUIPMENT STORAGE FROM ACTIVE TRAVEL LANES	
Posted Speed Limit (mph)	Distance (ft)
40 or less	≥ 18
45-50	≥ 28
55	≥ 32
60 or higher	≥ 40

When vehicles, equipment and materials are protected by concrete barrier or guardrail, they shall be offset at least 5 feet from the barrier or guardrail.

Page 11-2, Article 1101-9 PARKING OF PERSONAL VEHICLES, line 40-41, delete and replace with the following:

Provide staging areas for personal vehicle parking in accordance with section 1101-8 or as directed by the Engineer before use.



**WORK ZONE INSTALLER:**

(7-20-21)(Rev. 7-19-22)

1101, 1150

SP11 R04

Provide the service of at least one qualified work zone installer during the setup, installation, and removal of temporary traffic control within the highway right of way. The qualified work zone installer shall serve as crew leader and shall be on site and directing the installation and removal of temporary traffic control. If multiple temporary traffic control installations or removals are occurring simultaneously, then each shall have a qualified work zone installer.

The work zone installer shall be qualified by an NCDOT approved training agency or other approved training provider in the safe and competent set up of temporary traffic control. For a complete listing of approved training agencies, see the Work Zone Safety Training webpage.

A work zone supervisor, in accordance with Article 1101-13 of the *Standard Specifications*, may fulfill the role of the work zone installer during the setup, installation, and removal of temporary traffic control within the highway right of way provided they are on site and directing the installation and removal of temporary traffic control.

All other individuals participating in the setup, installation, and removal of temporary traffic control within the highway right of way shall be certified as a qualified flagger in accordance with Article 1150-3 of the *Standard Specifications*, even if flagging is not being performed as part of the traffic control.

Provide the name and contact information of all qualified work zone installers to the Engineer prior to or at the preconstruction conference. Additionally, provide a qualification statement that all other individuals participating in the setup, installation, and removal of temporary traffic control are qualified flaggers that have been properly trained through an NCDOT approved training agency.

All certification records for qualified work zone installers and flaggers shall be uploaded by the approved training agency or other approved training provider to the Department's Work Zone Education Verification App (WZ-EVA) prior to the qualified work zone installer or flagger performing any traffic control duties on the project. For more information about WZ-EVA, see the Work Zone Safety Training webpage.

**EXTRUDED THERMOPLASTIC PAVEMENT MARKING THICKNESS:**

3-19-19 (Rev. 6-21-22)

1205

SP12 R05

Revise the *2018 Standard Specifications* as follows:

**Page 12-6, Subarticle 1205-4(A)(1) General, lines 5-8,** delete the second sentence and replace with the following:

Use application equipment that provides multiple width settings ranging from 4 inches to 12 inches and multiple thickness settings to achieve the required thickness above the surface of the pavement as shown in Table 1205-3.

**Page 12-7, Table 1205-3, THICKNESS REQUIREMENTS FOR THERMOPLASTIC,** replace with the following:

<b>TABLE 1205-3 MINIMUM THICKNESS REQUIREMENTS FOR THERMOPLASTIC</b>	
<b>Thickness</b>	<b>Location</b>
240 mils	In-lane and shoulder-transverse pavement markings (rumble strips). May be placed in 2 passes.
90 mils	Center lines, skip lines, transverse bands, mini-skip lines, characters, bike lane symbols, crosswalk lines, edge lines, gore lines, diagonals, and arrow symbols

**PORTABLE CONSTRUCTION LIGHTING:**

4-19-22

1413

SP14 R13

Revise the *2018 Standard Specifications* as follows:

**Page 14-24, Article 1413-3 TOWER LIGHT, lines 2-7,** delete and replace the first and second sentence in the first paragraph with the following:

Use tower lights which consist of mercury vapor, metal halide, high pressure sodium, low pressure sodium or light emitting diode (with correlated color temperature of 4000 Kelvin or less) fixtures mounted on a tower approximately 30 feet in height. Use tower light fixtures which are heavy duty flood, area, or roadway style with wide beam spread, have sufficient output to provide the minimum illumination requirements for the Category of work, are weatherproof and supplied with attached waterproof power cord and plug.

**Page 14-24, Article 1413-3 TOWER LIGHT, lines 11-12,** delete and replace the second paragraph with the following:

Provide tower lights of sufficient wattage or quantity to provide the minimum average maintained horizontal illuminance over the work area based on the Category of work as shown in Table 1413-1. For any work not covered in Table 1413-1, provide a minimum average maintained horizontal illuminance of 20.0 footcandles over the work area.

Category	Description of Construction and Maintenance Task	Minimum Average Maintained Horizontal Illuminance
I	Excavation; Embankment, Fill and Compaction; Maintenance of Embankment; Asphalt Pavement Rolling; Subgrade, Stabilization and Construction; Base Course Rolling; Sweeping and Cleaning; Landscaping, Sod and Seeding; Reworking Shoulders.	5.0 footcandle
II	Barrier Wall and Traffic Separators; Milling, Removal of Pavement; Asphalt Paving and Resurfacing; Concrete Pavement; Base Course Grading and Shaping; Surface Treatment; Waterproofing and Sealing; Sidewalk Construction; Guardrails and Fencing; Striping and Pavement Marking; Highway Signs; Bridge Decks; Drainage Structures and Drainage Piping; Other Concrete Structures; Repair of Concrete Pavement; Pothole Filling; Repair of Guardrail and Fencing.	10.0 footcandle
III	Traffic Signals; Highway Lighting Systems; Crack Filling.	20.0 footcandle

**Page 14-24, Article 1413-4 MACHINE LIGHTS, lines 18-21**, delete and replace the first and second sentence in the first paragraph with the following:

Use machine lights which have mercury vapor, metal halide, high pressure sodium, low pressure sodium or light emitting diode (with correlated color temperature of 4000 Kelvin or less) fixtures mounted on supports attached to the construction machine at a height of approximately 13 feet.

**Page 14-24, Article 1413-5 CONSTRUCTION METHODS, lines 33-34**, delete and replace the third and fourth sentence in the first paragraph with the following:

Submit photometric calculations showing the minimum average maintained horizontal illuminance over the work area and the tower spacing to the Engineer for review and approval prior to installation.

**PERMANENT SEEDING AND MULCHING:**

(7-1-95)

1660

SP16 R02

The Department desires that permanent seeding and mulching be established on this project as soon as practical after slopes or portions of slopes have been graded. As an incentive to obtain an early stand of vegetation on this project, the Contractor's attention is called to the following:

For all permanent seeding and mulching that is satisfactorily completed in accordance with the requirements of Section 1660 in the *2018 Standard Specifications* and within the following percentages of elapsed contract times, an additional payment will be made to the Contractor as an incentive additive. The incentive additive will be determined by multiplying the number of acres of seeding and mulching satisfactorily completed times the contract unit bid price per acre for Seeding and Mulching times the appropriate percentage additive.

<b>Percentage of Elapsed Contract Time</b>	<b>Percentage Additive</b>
0% - 30%	30%
30.01% - 50%	15%

Percentage of elapsed contract time is defined as the number of calendar days from the date of availability of the contract to the date the permanent seeding and mulching is acceptably completed divided by the total original contract time.

**STANDARD SPECIAL PROVISION**  
**AVAILABILITY OF FUNDS – TERMINATION OF CONTRACTS**

(5-20-08)

Z-2

*General Statute 143C-6-11. (h) Highway Appropriation* is hereby incorporated verbatim in this contract as follows:

(h) Amounts Encumbered. – Transportation project appropriations may be encumbered in the amount of allotments made to the Department of Transportation by the Director for the estimated payments for transportation project contract work to be performed in the appropriation fiscal year. The allotments shall be multiyear allotments and shall be based on estimated revenues and shall be subject to the maximum contract authority contained in *General Statute 143C-6-11(c)*. Payment for transportation project work performed pursuant to contract in any fiscal year other than the current fiscal year is subject to appropriations by the General Assembly. Transportation project contracts shall contain a schedule of estimated completion progress, and any acceleration of this progress shall be subject to the approval of the Department of Transportation provided funds are available. The State reserves the right to terminate or suspend any transportation project contract, and any transportation project contract shall be so terminated or suspended if funds will not be available for payment of the work to be performed during that fiscal year pursuant to the contract. In the event of termination of any contract, the contractor shall be given a written notice of termination at least 60 days before completion of scheduled work for which funds are available. In the event of termination, the contractor shall be paid for the work already performed in accordance with the contract specifications.

Payment will be made on any contract terminated pursuant to the special provision in accordance with Subarticle 108-13(D) of the *2018 Standard Specifications*.

**STANDARD SPECIAL PROVISION**  
**NCDOT GENERAL SEED SPECIFICATION FOR SEED QUALITY**

(5-17-11)

Z-3

Seed shall be sampled and tested by the North Carolina Department of Agriculture and Consumer Services, Seed Testing Laboratory. When said samples are collected, the vendor shall supply an independent laboratory report for each lot to be tested. Results from seed so sampled shall be final. Seed not meeting the specifications shall be rejected by the Department of Transportation and shall not be delivered to North Carolina Department of Transportation warehouses. If seed has been delivered it shall be available for pickup and replacement at the supplier's expense.

Any re-labeling required by the North Carolina Department of Agriculture and Consumer Services, Seed Testing Laboratory, that would cause the label to reflect as otherwise specified herein shall be rejected by the North Carolina Department of Transportation.

Seed shall be free from seeds of the noxious weeds Johnsongrass, Balloonvine, Jimsonweed, Witchweed, Itchgrass, Serrated Tussock, Showy Crotalaria, Smooth Crotalaria, Sicklepod, Sandbur, Wild Onion, and Wild Garlic. Seed shall not be labeled with the above weed species on the seed analysis label. Tolerances as applied by the Association of Official Seed Analysts will NOT be allowed for the above noxious weeds except for Wild Onion and Wild Garlic.

Tolerances established by the Association of Official Seed Analysts will generally be recognized. However, for the purpose of figuring pure live seed, the found pure seed and found germination percentages as reported by the North Carolina Department of Agriculture and Consumer Services, Seed Testing Laboratory will be used. Allowances, as established by the NCDOT, will be recognized for minimum pure live seed as listed on the following pages.

The specifications for restricted noxious weed seed refers to the number per pound as follows:

<b><u>Restricted Noxious Weed</u></b>	<b><u>Limitations per Lb. Of Seed</u></b>	<b><u>Restricted Noxious Weed</u></b>	<b><u>Limitations per Lb. of Seed</u></b>
Blessed Thistle	4 seeds	Cornflower (Ragged Robin)	27 seeds
Cocklebur	4 seeds	Texas Panicum	27 seeds
Spurred Anoda	4 seeds	Bracted Plantain	54 seeds
Velvetleaf	4 seeds	Buckhorn Plantain	54 seeds
Morning-glory	8 seeds	Broadleaf Dock	54 seeds
Corn Cockle	10 seeds	Curly Dock	54 seeds
Wild Radish	12 seeds	Dodder	54 seeds
Purple Nutsedge	27 seeds	Giant Foxtail	54 seeds
Yellow Nutsedge	27 seeds	Horsenettle	54 seeds
Canada Thistle	27 seeds	Quackgrass	54 seeds
Field Bindweed	27 seeds	Wild Mustard	54 seeds
Hedge Bindweed	27 seeds		

Seed of Pensacola Bahiagrass shall not contain more than 7% inert matter, Kentucky Bluegrass, Centipede and Fine or Hard Fescue shall not contain more than 5% inert matter whereas a maximum of 2% inert matter will be allowed on all other kinds of seed. In addition, all seed shall

not contain more than 2% other crop seed nor more than 1% total weed seed. The germination rate as tested by the North Carolina Department of Agriculture shall not fall below 70%, which includes both dormant and hard seed. Seed shall be labeled with not more than 7%, 5% or 2% inert matter (according to above specifications), 2% other crop seed and 1% total weed seed.

Exceptions may be made for minimum pure live seed allowances when cases of seed variety shortages are verified. Pure live seed percentages will be applied in a verified shortage situation. Those purchase orders of deficient seed lots will be credited with the percentage that the seed is deficient.

FURTHER SPECIFICATIONS FOR EACH SEED GROUP ARE GIVEN BELOW:

Minimum 85% pure live seed; maximum 1% total weed seed; maximum 2% total other crop seed; maximum 144 restricted noxious weed seed per pound. Seed less than 83% pure live seed will not be approved.

Sericea Lespedeza  
Oats (seeds)

Minimum 80% pure live seed; maximum 1% total weed seed; maximum 2% total other crop; maximum 144 restricted noxious weed seed per pound. Seed less than 78% pure live seed will not be approved.

Tall Fescue (all approved varieties)	Bermudagrass
Kobe Lespedeza	Browntop Millet
Korean Lespedeza	German Millet – Strain R
Weeping Lovegrass	Clover – Red/White/Crimson
Carpetgrass	

Minimum 78% pure live seed; maximum 1% total weed seed; maximum 2% total other crop seed; maximum 144 restricted noxious weed seed per pound. Seed less than 76% pure live seed will not be approved.

Common or Sweet Sundangrass

Minimum 76% pure live seed; maximum 1% total weed seed; maximum 2% total other crop seed; maximum 144 restricted noxious weed seed per pound. Seed less than 74% pure live seed will not be approved.

Rye (grain; all varieties)  
Kentucky Bluegrass (all approved varieties)  
Hard Fescue (all approved varieties)  
Shrub (bicolor) Lespedeza

Minimum 70% pure live seed; maximum 1% total weed seed; maximum 2% total other crop seed; maximum 144 noxious weed seed per pound. Seed less than 70% pure live seed will not be approved.

Centipedegrass	Japanese Millet
Crownvetch	Reed Canary Grass
Pensacola Bahiagrass	Zoysia
Creeping Red Fescue	

Minimum 70% pure live seed; maximum 1% total weed seed; maximum 2% total other crop seed; maximum 5% inert matter; maximum 144 restricted noxious weed seed per pound.

Barnyard Grass  
Big Bluestem  
Little Bluestem  
Bristly Locust  
Birdsfoot Trefoil  
Indiangrass  
Orchardgrass  
Switchgrass  
Yellow Blossom Sweet Clover



**STANDARD SPECIAL PROVISION****ERRATA**

(10-16-18) (Rev. 7-19-22)

Z-4

Revise the *2018 Standard Specifications* as follows:

**Division 4**

**Page 4-84, Article 458-5 MEASUREMENT AND PAYMENT, line 31,** replace article number “454-1” with “458-1”.

**Division 6**

**Page 6-7, Article 609-1 DESCRIPTION, line 29,** replace article number “609-10” with “609-9”.

**Page 6-26, Subarticle 610-13(A)(1) Acceptance for New Construction, line 31,** replace Table number “610-7” with “610-8”.

**Page 6-29, Subarticle 610-13(B) North Carolina Hearne Straightedge, line 32,** replace Table number “610-8” with “610-9”.

**Page 6-31, Article 610-14 DENSITY ACCEPTANCE, Specified Density prior to line 30 and line 32,** replace Table number “610-6” with “610-7”.

**Division 7**

**Page 7-27, Article 725-1 MEASUREMENT AND PAYMENT, line 4,** replace article number “725-1” with “724-4”.

**Page 7-28, Article 725-1 MEASUREMENT AND PAYMENT, line 10,** replace article number “725-1” with “725-3”.

**Division 10**

**Page 10-78, Article 1056-4 GEOTEXTILES, TABLE 1056-1, Permittivity, Type 2,** replace “Table 6<sup>D</sup>” with “Table 7<sup>D</sup>” and **Permittivity, Type 3<sup>B</sup>,** replace “Table 7<sup>D</sup>” with “Table 8<sup>D</sup>”.

**Page 10-121, Article 1076-7, REPAIR OF GALVANIZING, line 8,** replace article number “1080-9” with “1080-7”.

**Page 10-162, Article 1080-50 PAINT FOR VERTICAL MARKERS, line 1,** replace article number “1080-50” with “1080-10”.

**Page 10-162, Article 1080-61 EPOXY RESIN FOR REINFORCING STEEL, line 5,** replace article number “1080-61” with “1080-11”.

**Page 10-162, Article 1080-72 ABRASIVE MATERIALS FOR BLAST CLEANING STEEL, line 22,** replace article number “1080-72” with “1080-12”.

**Page 10-163, Article 1080-83 FIELD PERFORMANCE AND SERVICES, line 25,** replace article number “1080-83” with “1080-13”.

**Division 17**

**Page 17-15, Article 1715-4 MEASUREMENT AND PAYMENT, lines 42-44**, replace the second sentence with the following:

An example is an installation of a single 1.25 inch HDPE conduit would be paid as:

Directional Drill (1)(1.25") Linear Foot

**Page 17-15, Subarticle 1715-3(E) Bore and Jack, line 5**, replace article number "1540-4" with "1550-4".

**Page 17-15, Subarticle 1715-3(E) Bore and Jack, lines 10 & 11**, replace "*NCDOT Policies and Procedures for Accommodating Utilities on Highway Rights of Way*" with "*NCDOT Utilities Accommodations Manual*".

**STANDARD SPECIAL PROVISION****PLANT AND PEST QUARANTINES****(Imported Fire Ant, Gypsy Moth, Witchweed, Emerald Ash Borer, Guava Root Knot Nematode, And Other Noxious Weeds)**

(3-18-03) (Rev. 5-21-19)

Z-04a

**Within Quarantined Area**

This project may be within a county regulated for plant and/or pests. If the project or any part of the Contractor's operations is located within a quarantined area, thoroughly clean all equipment prior to moving out of the quarantined area. Comply with federal/state regulations by obtaining a certificate or limited permit for any regulated article moving from the quarantined area.

**Originating in a Quarantined County**

Obtain a certificate or limited permit issued by the N.C. Department of Agriculture/United States Department of Agriculture. Have the certificate or limited permit accompany the article when it arrives at the project site.

**Contact**

Contact the N.C. Department of Agriculture/United States Department of Agriculture at 1-800-206-9333, 919-707-3730, or <https://www.ncagr.gov/plantindustry/Plant/quaran/table2.htm> to determine those specific project sites located in the quarantined area or for any regulated article used on this project originating in a quarantined county.

**Regulated Articles Include**

1. Soil, sand, gravel, compost, peat, humus, muck, and decomposed manure, separately or with other articles. This includes movement of articles listed above that may be associated with cut/waste, ditch pulling, and shoulder cutting.
2. Plants with roots including grass sod.
3. Plant crowns and roots.
4. Bulbs, corms, rhizomes, and tubers of ornamental plants.
5. Hay, straw, fodder, and plant litter of any kind.
6. Clearing and grubbing debris.
7. Used agricultural cultivating and harvesting equipment.
8. Used earth-moving equipment.
9. Any other products, articles, or means of conveyance, of any character, if determined by an inspector to present a hazard of spreading imported fire ant, gypsy moth, witchweed, emerald ash borer, guava root knot nematode, or other noxious weeds.

**STANDARD SPECIAL PROVISION****TITLE VI AND NONDISCRIMINATION:**

(6-28-77)(Rev 6/19/2018)

Z-6

Revise the *2018 Standard Specifications* as follows:

Replace Article 103-4(B) with the following:

The North Carolina Department of Transportation is committed to carrying out the U.S. Department of Transportation's policy of ensuring nondiscrimination in the award and administration of contracts.

The provisions of this section related to United States Department of Transportation (US DOT) Order 1050.2A, Title 49 Code of Federal Regulations (CFR) part 21, 23 United States Code (U.S.C.) 140 and 23 CFR part 200 (or 49 CFR 303, 49 U.S.C. 5332 or 49 U.S.C. 47123) are applicable to all North Carolina Department of Transportation (NCDOT) contracts and to all related subcontracts, material supply, engineering, architectural and other service contracts, regardless of dollar amount. Any Federal provision that is specifically required not specifically set forth is hereby incorporated by reference.

(1) **Title VI Assurances (USDOT Order 1050.2A, Appendix A)**

During the performance of this contract, the contractor, for itself, its assignees, and successors in interest (hereinafter referred to as the "contractor") agrees as follows:

(a) Compliance with Regulations

The contractor (hereinafter includes consultants) shall comply with the Acts and the Regulations relative to Nondiscrimination in Federally-assisted programs of the U.S. Department of Transportation, Federal Highway Administration (FHWA), as they may be amended from time to time, which are herein incorporated by reference and made a part of this contract.

(b) Nondiscrimination

The contractor, with regard to the work performed by it during the contract, shall not discriminate on the grounds of race, color, or national origin in the selection and retention of subcontractors, including procurements of materials and leases of equipment. The contractor shall not participate directly or indirectly in the discrimination prohibited by the Acts and the Regulations, including employment practices when the contract covers any activity, project, or program set forth in Appendix B of 49 CFR Part 21.

(c) Solicitations for Subcontractors, Including Procurements of Materials and Equipment

In all solicitations, either by competitive bidding, or negotiation made by the contractor for work to be performed under a subcontract, including procurements of materials, or leases of equipment, each potential subcontractor or supplier shall be notified by the contractor of the contractor's obligations under this contract and the Acts and the Regulations relative to Nondiscrimination on the grounds of race, color, or national origin.

(d) Information and Reports

The contractor shall provide all information and reports required by the Acts, the Regulations, and directives issued pursuant thereto and shall permit access to its books, records, accounts, other sources of information, and its facilities as may be determined by the Recipient or the FHWA to be pertinent to ascertain compliance with such Acts,

Regulations, and instructions. Where any information required of a contractor is in the exclusive possession of another who fails or refuses to furnish the information, the contractor shall so certify to the Recipient or the FHWA, as appropriate, and shall set forth what efforts it has made to obtain the information.

(e) Sanctions for Noncompliance:

In the event of a contractor's noncompliance with the Non-discrimination provisions of this contract, the Recipient will impose such contract sanctions as it and/or the FHWA may determine to be appropriate, including, but not limited to:

- (i) Withholding payments to the contractor under the contract until the contractor complies; and/or
- (ii) Cancelling, terminating, or suspending a contract, in whole or in part.

(f) Incorporation of Provisions

The contractor shall include the provisions of paragraphs (a) through (f) in every subcontract, including procurements of materials and leases of equipment, unless exempt by the Acts, the Regulations and directives issued pursuant thereto. The contractor shall take action with respect to any subcontract or procurement as the Recipient or the FHWA may direct as a means of enforcing such provisions including sanctions for noncompliance. Provided, that if the contractor becomes involved in, or is threatened with litigation by a subcontractor, or supplier because of such direction, the contractor may request the Recipient to enter into any litigation to protect the interests of the Recipient. In addition, the contractor may request the United States to enter into the litigation to protect the interests of the United States.

(2) **Title VI Nondiscrimination Program (23 CFR 200.5(p))**

The North Carolina Department of Transportation (NCDOT) has assured the USDOT that, as a condition to receiving federal financial assistance, NCDOT will comply with Title VI of the Civil Rights Act of 1964 and all requirements imposed by Title 49 CFR part 21 and related nondiscrimination authorities to ensure that no person shall, on the ground of race, color, national origin, limited English proficiency, sex, age, or disability (including religion/creed or income-level, where applicable), be excluded from participation in, be denied the benefits of, or be subjected to discrimination under any programs, activities, or services conducted or funded by NCDOT. Contractors and other organizations under contract or agreement with NCDOT must also comply with Title VI and related authorities, therefore:

(a) During the performance of this contract or agreement, contractors (e.g., subcontractors, consultants, vendors, prime contractors) are responsible for complying with NCDOT's Title VI Program. Contractors are not required to prepare or submit Title VI Programs. To comply with this section, the prime contractor shall:

1. Post NCDOT's Notice of Nondiscrimination and the Contractor's own Equal Employment Opportunity (EEO) Policy in conspicuous locations accessible to all employees, applicants and subcontractors on the jobsite.
2. Physically incorporate the required Title VI clauses into all subcontracts on federally-assisted and state-funded NCDOT projects, and ensure inclusion by subcontractors into all lower-tier subcontracts.
3. Required Solicitation Language. The Contractor shall include the following notification in all solicitations for bids and requests for work or material, regardless of funding source:

"The North Carolina Department of Transportation, in accordance with the provisions of Title VI of the Civil Rights Act of 1964 (78 Stat. 252, 42 US.C. §§ 2000d to 2000d-4) and the Regulations, hereby notifies all bidders that it will affirmatively ensure that any contract

entered into pursuant to this advertisement, disadvantaged business enterprises will be afforded full and fair opportunity to submit bids in response to this invitation and will not be discriminated against on the grounds of race, color, or national origin in consideration for an award. In accordance with other related nondiscrimination authorities, bidders and contractors will also not be discriminated against on the grounds of sex, age, disability, low-income level, creed/religion, or limited English proficiency in consideration for an award.”

4. Physically incorporate the FHWA-1273, in its entirety, into all subcontracts and subsequent lower tier subcontracts on Federal-aid highway construction contracts only.
  5. Provide language assistance services (i.e., written translation and oral interpretation), free of charge, to LEP employees and applicants. Contact NCDOT OCR for further assistance, if needed.
  6. For assistance with these Title VI requirements, contact the NCDOT Title VI Nondiscrimination Program at 1-800-522-0453.
- (b) Subrecipients (e.g. cities, counties, LGAs, planning organizations) may be required to prepare and submit a Title VI Plan to NCDOT, including Title VI Assurances and/or agreements. Subrecipients must also ensure compliance by their contractors and subrecipients with Title VI. (23 CFR 200.9(b)(7))
- (c) If reviewed or investigated by NCDOT, the contractor or subrecipient agrees to take affirmative action to correct any deficiencies found within a reasonable time period, not to exceed 90 calendar days, unless additional time is granted by NCDOT. (23 CFR 200.9(b)(15))
- (d) The Contractor is responsible for notifying subcontractors of NCDOT’s External Discrimination Complaints Process.
1. Applicability  
Title VI and related laws protect participants and beneficiaries (e.g., members of the public and contractors) from discrimination by NCDOT employees, subrecipients and contractors, regardless of funding source.
  2. Eligibility  
Any person—or class of persons—who believes he/she has been subjected to discrimination based on race, color, national origin, Limited English Proficiency (LEP), sex, age, or disability (and religion in the context of employment, aviation, or transit) may file a written complaint. The law also prohibits intimidation or retaliation of any sort.
  3. Time Limits and Filing Options  
Complaints may be filed by the affected individual(s) or a representative and must be filed no later than 180 calendar days after the following:
    - (i) The date of the alleged act of discrimination; or
    - (ii) The date when the person(s) became aware of the alleged discrimination; or
    - (iii) Where there has been a continuing course of conduct, the date on which that conduct was discontinued or the latest instance of the conduct.Title VI and related discrimination complaints may be submitted to the following entities:
    - North Carolina Department of Transportation, Office of Civil Rights, Title VI Program, 1511 Mail Service Center, Raleigh, NC 27699-1511; toll free 1-800-522-0453
    - Federal Highway Administration, North Carolina Division Office, 310 New Bern Avenue, Suite 410, Raleigh, NC 27601, 919-747-7010

- US Department of Transportation, Departmental Office of Civil Rights, External Civil Rights Programs Division, 1200 New Jersey Avenue, SE, Washington, DC 20590; 202-366-4070
4. Format for Complaints  
Complaints must be in writing and signed by the complainant(s) or a representative, and include the complainant's name, address, and telephone number. Complaints received by fax or e-mail will be acknowledged and processed. Allegations received by telephone will be reduced to writing and provided to the complainant for confirmation or revision before processing. Complaints will be accepted in other languages, including Braille.
  5. Discrimination Complaint Form  
Contact NCDOT Civil Rights to receive a full copy of the Discrimination Complaint Form and procedures.
  6. Complaint Basis  
Allegations must be based on issues involving race, color, national origin (LEP), sex, age, disability, or religion (in the context of employment, aviation or transit). "Basis" refers to the complainant's membership in a protected group category.

**TABLE 103-1  
COMPLAINT BASIS**

Protected Categories	Definition	Examples	Applicable Nondiscrimination Authorities
Race and Ethnicity	An individual belonging to one of the accepted racial groups; or the perception, based usually on physical characteristics that a person is a member of a racial group	Black/African American, Hispanic/Latino, Asian, American Indian/Alaska Native, Native Hawaiian/Pacific Islander, White	Title VI of the Civil Rights Act of 1964; 49 CFR Part 21; 23 CFR 200; 49 U.S.C. 5332(b); 49 U.S.C. 47123. ( <i>Executive Order 13166</i> )
Color	Color of skin, including shade of skin within a racial group	Black, White, brown, yellow, etc.	
National Origin ( <i>Limited English Proficiency</i> )	Place of birth. Citizenship is not a factor. ( <i>Discrimination based on language or a person's accent is also covered</i> )	Mexican, Cuban, Japanese, Vietnamese, Chinese	
Sex	Gender. The sex of an individual. <i>Note: Sex under this program does not include sexual orientation.</i>	Women and Men	1973 Federal-Aid Highway Act; 49 U.S.C. 5332(b); 49 U.S.C. 47123.
Age	Persons of any age	21-year-old person	Age Discrimination Act of 1975 49 U.S.C. 5332(b); 49 U.S.C. 47123.
Disability	Physical or mental impairment, permanent or temporary, or perceived.	Blind, alcoholic, para-amputee, epileptic, diabetic, arthritic	Section 504 of the Rehabilitation Act of 1973; Americans with Disabilities Act of 1990

<p>Religion (in the context of employment) <i>(Religion/ Creed in all aspects of any aviation or transit-related construction)</i></p>	<p>An individual belonging to a religious group; or the perception, based on distinguishable characteristics that a person is a member of a religious group. In practice, actions taken as a result of the moral and ethical beliefs as to what is right and wrong, which are sincerely held with the strength of traditional religious views. <b>Note:</b> Does not have to be associated with a recognized religious group or church; if an individual sincerely holds to the belief, it is a protected religious practice.</p>	<p>Muslim, Christian, Sikh, Hindu, etc.</p>	<p>Title VII of the Civil Rights Act of 1964; 23 CFR 230; FHWA-1273 Required Contract Provisions. <i>(49 U.S.C. 5332(b); 49 U.S.C. 47123)</i></p>
--	---	---	---

### (3) Pertinent Nondiscrimination Authorities

During the performance of this contract, the contractor, for itself, its assignees, and successors in interest agrees to comply with the following non-discrimination statutes and authorities, including, but not limited to:

- (a) Title VI of the Civil Rights Act of 1964 (42 U.S.C. § 2000d et seq., 78 stat. 252), (prohibits discrimination on the basis of race, color, national origin); and 49 CFR Part 21.
- (b) The Uniform Relocation Assistance and Real Property Acquisition Policies Act of 1970, (42 U.S.C. § 4601), (prohibits unfair treatment of persons displaced or whose property has been acquired because of Federal or Federal-aid programs and projects);
- (c) Federal-Aid Highway Act of 1973, (23 U.S.C. § 324 et seq.), (prohibits discrimination on the basis of sex);
- (d) Section 504 of the Rehabilitation Act of 1973, (29 U.S.C. § 794 et seq.), as amended, (prohibits discrimination on the basis of disability) and 49 CFR Part 27;
- (e) The Age Discrimination Act of 1975, as amended, (42 U.S.C. § 6101 et seq.), (prohibits discrimination on the basis of age);
- (f) Airport and Airway Improvement Act of 1982, (49 USC § 471, Section 47123), as amended, (prohibits discrimination based on race, creed, color, national origin, or sex);
- (g) The Civil Rights Restoration Act of 1987, (PL 100-209), (Broadened the scope, coverage and applicability of Title VI of the Civil Rights Act of 1964, The Age Discrimination Act of 1975 and Section 504 of the Rehabilitation Act of 1973, by expanding the definition of the terms "programs or activities" to include all of the programs or activities of the Federal-aid recipients, sub-recipients and contractors, whether such programs or activities are Federally funded or not);
- (h) Titles II and III of the Americans with Disabilities Act, which prohibit discrimination on the basis of disability in the operation of public entities, public and private transportation systems, places of public accommodation, and certain testing entities (42 U.S.C. §§ 12131-12189) as implemented by Department of Transportation regulations at 49 C.F.R. parts 37 and 38;
- (i) The Federal Aviation Administration's Nondiscrimination statute (49 U.S.C. § 47123) (prohibits discrimination on the basis of race, color, national origin, and sex);
- (j) Executive Order 12898, Federal Actions to Address Environmental Justice in Minority Populations and Low-Income Populations, which ensures Nondiscrimination against minority populations by discouraging programs, policies, and activities with



- disproportionately high and adverse human health or environmental effects on minority and low-income populations;
- (k) Executive Order 13166, Improving Access to Services for Persons with Limited English Proficiency, and resulting agency guidance, national origin discrimination includes discrimination because of Limited English proficiency (LEP). To ensure compliance with Title VI, you must take reasonable steps to ensure that LEP persons have meaningful access to your programs (70 Fed. Reg. at 74087 to 74100);
  - (l) Title IX of the Education Amendments of 1972, as amended, which prohibits you from discriminating because of sex in education programs or activities (20 U.S.C. 1681 et seq).
  - (m) Title VII of the Civil Rights Act of 1964 (42 U.S.C. § 2000e et seq., Pub. L. 88-352), (prohibits employment discrimination on the basis of race, color, religion, sex, or national origin).
- (4) **Additional Title VI Assurances**

*\*\*The following Title VI Assurances (Appendices B, C and D) shall apply, as applicable*

- (a) Clauses for Deeds Transferring United States Property (1050.2A, Appendix B)  
The following clauses will be included in deeds effecting or recording the transfer of real property, structures, or improvements thereon, or granting interest therein from the United States pursuant to the provisions of Assurance 4.

NOW, THEREFORE, the U.S. Department of Transportation as authorized by law and upon the condition that the North Carolina Department of Transportation (NCDOT) will accept title to the lands and maintain the project constructed thereon in accordance with the North Carolina General Assembly, the Regulations for the Administration of the Federal-Aid Highway Program, and the policies and procedures prescribed by the Federal Highway Administration of the U.S. Department of Transportation in accordance and in compliance with all requirements imposed by Title 49, Code of Federal Regulations, U.S. Department of Transportation, Subtitle A, Office of the Secretary, Part 21, Nondiscrimination in Federally-assisted programs of the U.S. Department of Transportation pertaining to and effectuating the provisions of Title VI of the Civil Rights Act of 1964 (78 Stat. 252; 42 U.S.C. § 2000d to 2000d-4), does hereby remise, release, quitclaim and convey unto the NCDOT all the right, title and interest of the U.S. Department of Transportation in and to said lands described in Exhibit A attached hereto and made a part hereof.

(HABENDUM CLAUSE)

TO HAVE AND TO HOLD said lands and interests therein unto the North Carolina Department of Transportation (NCDOT) and its successors forever, subject, however, to the covenants, conditions, restrictions and reservations herein contained as follows, which will remain in effect for the period during which the real property or structures are used for a purpose for which Federal financial assistance is extended or for another purpose involving the provision of similar services or benefits and will be binding on the NCDOT, its successors and assigns.

The NCDOT, in consideration of the conveyance of said lands and interests in lands, does hereby covenant and agree as a covenant running with the land for itself, its successors and assigns, that (1) no person will on the grounds of race, color, or national origin, be excluded from participation in, be denied the benefits of, or be otherwise subjected to discrimination with regard to any facility located wholly or in part on, over, or under such lands hereby conveyed [,] [and]\* (2) that the NCDOT will use the lands and interests in lands and interests in lands so conveyed, in compliance with all requirements imposed by or pursuant to Title 49, Code of Federal Regulations, U.S. Department of Transportation, Subtitle A, Office of the Secretary, Part 21, Non-discrimination in Federally-assisted programs of the U.S. Department of Transportation, Effectuation of Title VI of the Civil Rights Act of 1964, and as said Regulations and Acts may be amended [, and (3) that in the event of breach of any of the above-mentioned nondiscrimination conditions, the Department will have a right to enter or re-enter said lands and facilities on said land, and that above described land and facilities will thereon revert to and vest in and become the absolute property of the U.S. Department of Transportation and its assigns as such interest existed prior to this instruction].\*

(\*Reverter clause and related language to be used only when it is determined that such a clause is necessary in order to make clear the purpose of Title VI.)

(b) Clauses for Transfer of Real Property Acquired or Improved Under the Activity, Facility, or Program (1050.2A, Appendix C)

The following clauses will be included in deeds, licenses, leases, permits, or similar instruments entered into by the North Carolina Department of Transportation (NCDOT) pursuant to the provisions of Assurance 7(a):

1. The (grantee, lessee, permittee, etc. as appropriate) for himself/herself, his/her heirs, personal representatives, successors in interest, and assigns, as a part of the consideration hereof, does hereby covenant and agree [in the case of deeds and leases add "as a covenant running with the land"] that:
  - (i.) In the event facilities are constructed, maintained, or otherwise operated on the property described in this (deed, license, lease, permit, etc.) for a purpose for which a U.S. Department of Transportation activity, facility, or program is extended or for another purpose involving the provision of similar services or benefits, the (grantee, licensee, lessee, permittee, etc.) will maintain and operate such facilities and services in compliance with all requirements imposed by the Acts and Regulations (as may be amended) such that no person on the grounds of race, color, or national origin, will be excluded from participation in, denied the benefits of, or be otherwise subjected to discrimination in the use of said facilities.
2. With respect to licenses, leases, permits, etc., in the event of breach of any of the above Nondiscrimination covenants, the NCDOT will have the right to terminate the (lease, license, permit, etc.) and to enter, re-enter, and repossess said lands and facilities thereon, and hold the same as if the (lease, license, permit, etc.) had never been made or issued. \*
3. With respect to a deed, in the event of breach of any of the above Nondiscrimination covenants, the NCDOT will have the right to enter or re-enter the lands and facilities thereon, and the above described lands and facilities will there upon revert to and vest in and become the absolute property of the NCDOT and its assigns. \*

- (\*Reverter clause and related language to be used only when it is determined that such a clause is necessary to make clear the purpose of Title VI.)
- (c) Clauses for Construction/Use/Access to Real Property Acquired Under the Activity, Facility or Program (1050.2A, Appendix D)

The following clauses will be included in deeds, licenses, permits, or similar instruments/ agreements entered into by the North Carolina Department of Transportation (NCDOT) pursuant to the provisions of Assurance 7(b):

1. The (grantee, licensee, permittee, etc., as appropriate) for himself/herself, his/her heirs, personal representatives, successors in interest, and assigns, as a part of the consideration hereof, does hereby covenant and agree (in the case of deeds and leases add, "as a covenant running with the land") that (1) no person on the ground of race, color, or national origin, will be excluded from participation in, denied the benefits of, or be otherwise subjected to discrimination in the use of said facilities, (2) that in the construction of any improvements on, over, or under such land, and the furnishing of services thereon, no person on the ground of race, color, or national origin, will be excluded from participation in, denied the benefits of, or otherwise be subjected to discrimination, (3) that the (grantee, licensee, lessee, permittee, etc.) will use the premises in compliance with all other requirements imposed by or pursuant to the Acts and Regulations, as amended, set forth in this Assurance.
2. With respect to (licenses, leases, permits, etc.), in the event of breach of any of the above Non-discrimination covenants, the NCDOT will have the right to terminate the (license, permit, etc., as appropriate) and to enter or re-enter and repossess said land and the facilities thereon, and hold the same as if said (license, permit, etc., as appropriate) had never been made or issued. \*
3. With respect to deeds, in the event of breach of any of the above Nondiscrimination covenants, the NCDOT will there upon revert to and vest in and become the absolute property of the NCDOT and its assigns. \*

(\*Reverter clause and related language to be used only when it is determined that such a clause is necessary to make clear the purpose of Title VI.)

**STANDARD SPECIAL PROVISION****MINORITY AND FEMALE EMPLOYMENT REQUIREMENTS**

Z-7

NOTICE OF REQUIREMENTS FOR AFFIRMATIVE ACTION TO ENSURE EQUAL EMPLOYMENT OPPORTUNITY (*EXECUTIVE NUMBER 11246*)

1. The goals and timetables for minority and female participation, expressed in percentage terms for the Contractor's aggregate workforce in each trade on all construction work in the covered area, see as shown on the attached sheet entitled "Employment Goals for Minority and Female participation".

These goals are applicable to all the Contractor's construction work (whether or not it is Federal or federally assisted) performed in the covered area. If the Contractor performs construction work in a geographical area located outside of the covered area, it shall apply the goals established for such geographical area where the work is actually performed. With regard to this second area, the Contractor also is subject to the goals for both its federally involved and nonfederally involved construction.

The Contractor's compliance with the Executive Order and the regulations in *41 CFR Part 60-4* shall be based on its implementation of the Equal Opportunity Clause, specific affirmative action obligations required by the specifications set forth in *41 CFR 60-4.3(a)*, and its effort to meet the goals. The hours of minority and female employment and training must be substantially uniform throughout the length of the contract, and in each trade and the Contractor shall make a good faith effort to employ minorities and women evenly on each of its projects. The transfer of minority or female employees or trainees from Contractor to Contractor or from project to project for the sole purpose of meeting the Contractor's goals shall be a violation of the contract, the executive Order and the regulations in *41 CFR Part 60-4*. Compliance with the goals will be measured against the total work hours performed.

2. As used in this Notice and in the contract resulting from this solicitation, the "covered area" is the county or counties shown on the cover sheet of the proposal form and contract.

**EMPLOYMENT GOALS FOR MINORITY  
AND FEMALE PARTICIPATION**

Economic Areas

**Area 023 29.7%**

Bertie County  
Camden County  
Chowan County  
Gates County  
Hertford County  
Pasquotank County  
Perquimans County

**Area 024 31.7%**

Beaufort County  
Carteret County  
Craven County  
Dare County  
Edgecombe County  
Green County  
Halifax County  
Hyde County  
Jones County  
Lenoir County  
Martin County  
Nash County  
Northampton County  
Pamlico County  
Pitt County  
Tyrrell County  
Washington County  
Wayne County  
Wilson County

**Area 025 23.5%**

Columbus County  
Duplin County  
Onslow County  
Pender County

**Area 026 33.5%**

Bladen County  
Hoke County  
Richmond County  
Robeson County  
Sampson County  
Scotland County

**Area 027 24.7%**

Chatham County  
Franklin County  
Granville County  
Harnett County  
Johnston County  
Lee County  
Person County  
Vance County  
Warren County

**Area 028 15.5%**

Alleghany County  
Ashe County  
Caswell County  
Davie County  
Montgomery County  
Moore County  
Rockingham County  
Surry County  
Watauga County  
Wilkes County

**Area 029 15.7%**

Alexander County  
Anson County  
Burke County  
Cabarrus County  
Caldwell County  
Catawba County  
Cleveland County  
Iredell County  
Lincoln County  
Polk County  
Rowan County  
Rutherford County  
Stanly County

**Area 0480 8.5%**

Buncombe County  
Madison County

**Area 030 6.3%**

Avery County  
Cherokee County  
Clay County  
Graham County  
Haywood County  
Henderson County  
Jackson County  
McDowell County  
Macon County  
Mitchell County  
Swain County  
Transylvania County  
Yancey County

**SMSA Areas**

**Area 5720 26.6%**

Currituck County

**Area 9200 20.7%**

Brunswick County

New Hanover County

**Area 2560 24.2%**

Cumberland County

**Area 6640 22.8%**

Durham County

Orange County

Wake County

**Area 1300 16.2%**

Alamance County

**Area 3120 16.4%**

Davidson County

Forsyth County

Guilford County

Randolph County

Stokes County

Yadkin County

**Area 1520 18.3%**

Gaston County

Mecklenburg County

Union County

---

**Goals for Female**

**Participation in Each Trade**

(Statewide) 6.9%

**STANDARD SPECIAL PROVISION****REQUIRED CONTRACT PROVISIONS FEDERAL - AID CONSTRUCTION CONTRACTS**

FHWA - 1273 Electronic Version - May 1, 2012

Z-8

- I. General
- II. Nondiscrimination
- III. Nonsegregated Facilities
- IV. Davis-Bacon and Related Act Provisions
- V. Contract Work Hours and Safety Standards Act Provisions
- VI. Subletting or Assigning the Contract
- VII. Safety: Accident Prevention
- VIII. False Statements Concerning Highway Projects
- IX. Implementation of Clean Air Act and Federal Water Pollution Control Act
- X. Compliance with Governmentwide Suspension and Debarment Requirements
- XI. Certification Regarding Use of Contract Funds for Lobbying

**ATTACHMENTS**

- A. Employment and Materials Preference for Appalachian Development Highway System or Appalachian Local Access Road Contracts (included in Appalachian contracts only)

**I. GENERAL**

1. Form FHWA-1273 must be physically incorporated in each construction contract funded under Title 23 (excluding emergency contracts solely intended for debris removal). The contractor (or subcontractor) must insert this form in each subcontract and further require its inclusion in all lower tier subcontracts (excluding purchase orders, rental agreements and other agreements for supplies or services).  
The applicable requirements of Form FHWA-1273 are incorporated by reference for work done under any purchase order, rental agreement or agreement for other services. The prime contractor shall be responsible for compliance by any subcontractor, lower-tier subcontractor or service provider.  
Form FHWA-1273 must be included in all Federal-aid design-build contracts, in all subcontracts and in lower tier subcontracts (excluding subcontracts for design services, purchase orders, rental agreements and other agreements for supplies or services). The design-builder shall be responsible for compliance by any subcontractor, lower-tier subcontractor or service provider.  
Contracting agencies may reference Form FHWA-1273 in bid proposal or request for proposal documents, however, the Form FHWA-1273 must be physically incorporated (not referenced) in all contracts, subcontracts and lower-tier subcontracts (excluding purchase orders, rental agreements and other agreements for supplies or services related to a construction contract).
2. Subject to the applicability criteria noted in the following sections, these contract provisions shall apply to all work performed on the contract by the contractor's own organization and with the assistance of workers under the contractor's immediate superintendence and to all work performed on the contract by piecework, station work, or by subcontract.
3. A breach of any of the stipulations contained in these Required Contract Provisions may be sufficient grounds for withholding of progress payments, withholding of final payment, termination of the contract, suspension / debarment or any other action determined to be appropriate by the contracting agency and FHWA.
4. Selection of Labor: During the performance of this contract, the contractor shall not use convict labor for any purpose within the limits of a construction project on a Federal-aid highway unless it is labor performed by convicts who are on parole, supervised release, or probation. The term Federal-aid highway does not include roadways functionally classified as local roads or rural minor collectors.

**II. NONDISCRIMINATION**

The provisions of this section related to 23 CFR Part 230 are applicable to all Federal-aid construction contracts and to all related construction subcontracts of \$10,000 or more. The provisions of 23 CFR Part 230 are not applicable to material supply, engineering, or architectural service contracts.

In addition, the contractor and all subcontractors must comply with the following policies: Executive Order 11246, 41 CFR 60, 29 CFR 1625-1627, Title 23 USC Section 140, the Rehabilitation Act of 1973, as amended (29 USC 794), Title VI of the Civil Rights Act of 1964, as amended, and related regulations including 49 CFR Parts 21, 26 and 27; and 23 CFR Parts 200, 230, and 633.

The contractor and all subcontractors must comply with: the requirements of the Equal Opportunity Clause in 41 CFR 60-1.4(b) and, for all construction contracts exceeding \$10,000, the Standard Federal Equal Employment Opportunity Construction Contract Specifications in 41 CFR 60-4.3.

Note: The U.S. Department of Labor has exclusive authority to determine compliance with Executive Order 11246 and the policies of the Secretary of Labor including 41 CFR 60, and 29 CFR 1625-1627. The contracting agency and the FHWA have the authority and the responsibility to ensure compliance with Title 23 USC Section 140, the Rehabilitation Act of 1973, as amended (29 USC 794), and Title VI of the Civil Rights Act of 1964, as amended, and related regulations including 49 CFR Parts 21, 26 and 27; and 23 CFR Parts 200, 230, and 633.

The following provision is adopted from 23 CFR 230, Appendix A, with appropriate revisions to conform to the U.S. Department of Labor (US DOL) and FHWA requirements.

1. **Equal Employment Opportunity:** Equal employment opportunity (EEO) requirements not to discriminate and to take affirmative action to assure equal opportunity as set forth under laws, executive orders, rules, regulations (28 CFR 35, 29 CFR 1630, 29 CFR 1625-1627, 41 CFR 60 and 49 CFR 27) and orders of the Secretary of Labor as modified by the provisions prescribed herein, and imposed pursuant to 23 U.S.C. 140 shall constitute the EEO and specific affirmative action standards for the contractor's project activities under this contract. The provisions of the Americans with Disabilities Act of 1990 (42 U.S.C. 12101 et seq.) set forth under 28 CFR 35 and 29 CFR 1630 are incorporated by reference in this contract. In the execution of this contract, the contractor agrees to comply with the following minimum specific requirement activities of EEO:
  - a. The contractor will work with the contracting agency and the Federal Government to ensure that it has made every good faith effort to provide equal opportunity with respect to all of its terms and conditions of employment and in their review of activities under the contract.
  - b. The contractor will accept as its operating policy the following statement:

"It is the policy of this Company to assure that applicants are employed, and that employees are treated during employment, without regard to their race, religion, sex, color, national origin, age or disability. Such action shall include: employment, upgrading, demotion, or transfer; recruitment or recruitment advertising; layoff or termination; rates of pay or other forms of compensation; and selection for training, including apprenticeship, pre-apprenticeship, and/or on-the-job training."

2. **EEO Officer:** The contractor will designate and make known to the contracting officers an EEO Officer who will have the responsibility for and must be capable of effectively administering and promoting an active EEO program and who must be assigned adequate authority and responsibility to do so.
3. **Dissemination of Policy:** All members of the contractor's staff who are authorized to hire, supervise, promote, and discharge employees, or who recommend such action, or who are substantially involved in such action, will be made fully cognizant of, and will implement, the contractor's EEO policy and contractual responsibilities to provide EEO in each grade and classification of employment. To ensure that the above agreement will be met, the following actions will be taken as a minimum:
  - a. Periodic meetings of supervisory and personnel office employees will be conducted before the start of work and then not less often than once every six months, at which time the contractor's EEO policy and its implementation will be reviewed and explained. The meetings will be conducted by the EEO Officer.
  - b. All new supervisory or personnel office employees will be given a thorough indoctrination by the EEO Officer, covering all major aspects of the contractor's EEO obligations within thirty days following their reporting for duty with the contractor.
  - c. All personnel who are engaged in direct recruitment for the project will be instructed by the EEO Officer in the contractor's procedures for locating and hiring minorities and women.
  - d. Notices and posters setting forth the contractor's EEO policy will be placed in areas readily accessible to employees, applicants for employment and potential employees.
  - e. The contractor's EEO policy and the procedures to implement such policy will be brought to the attention of employees by means of meetings, employee handbooks, or other appropriate means.
4. **Recruitment:** When advertising for employees, the contractor will include in all advertisements for employees the notation: "An Equal Opportunity Employer." All such advertisements will be placed in publications having a large circulation among minorities and women in the area from which the project work force would normally be derived.
  - a. The contractor will, unless precluded by a valid bargaining agreement, conduct systematic and direct recruitment through public and private employee referral sources likely to yield qualified minorities and women. To meet this requirement, the contractor will identify sources of potential minority group employees, and establish with such identified sources procedures whereby minority and women applicants may be referred to the contractor for employment consideration.
  - b. In the event the contractor has a valid bargaining agreement providing for exclusive hiring hall referrals, the contractor is expected to observe the provisions of that agreement to the extent that the system meets the contractor's compliance with EEO contract provisions. Where implementation of such an agreement has the effect of discriminating against minorities or women, or obligates the contractor to do the same, such implementation violates Federal nondiscrimination provisions.
  - c. The contractor will encourage its present employees to refer minorities and women as applicants for employment. Information and procedures with regard to referring such applicants will be discussed with employees.
5. **Personnel Actions:** Wages, working conditions, and employee benefits shall be established and administered, and personnel actions of every type, including hiring, upgrading, promotion, transfer, demotion, layoff, and termination, shall be taken without regard to race, color, religion, sex, national origin, age or disability. The following procedures shall be followed:
  - a. The contractor will conduct periodic inspections of project sites to insure that working conditions and employee facilities do not indicate discriminatory treatment of project site personnel.
  - b. The contractor will periodically evaluate the spread of wages paid within each classification to determine any evidence of discriminatory wage practices.
  - c. The contractor will periodically review selected personnel actions in depth to determine whether there is evidence of discrimination. Where evidence is found, the contractor will promptly take corrective action. If the review indicates that the discrimination may extend beyond the actions reviewed, such corrective action shall include all affected persons.
  - d. The contractor will promptly investigate all complaints of alleged discrimination made to the contractor in connection with its obligations under this contract, will attempt to resolve such complaints, and will take appropriate corrective action within a reasonable time. If the investigation indicates that the discrimination may affect persons other than the complainant, such corrective action shall include such other persons. Upon completion of each investigation, the contractor will inform every complainant of all of their avenues of appeal.
6. **Training and Promotion:**
  - a. The contractor will assist in locating, qualifying, and increasing the skills of minorities and women who are applicants for employment or current employees. Such efforts should be aimed at developing full journey level status employees in the type of trade or job classification involved.
  - b. Consistent with the contractor's work force requirements and as permissible under Federal and State regulations, the contractor shall make full use of training programs, i.e., apprenticeship, and on-the-job training programs for the geographical area of contract performance. In the event a special provision for training is provided under this contract, this subparagraph will be superseded as indicated in the special provision. The contracting agency may reserve training positions for persons who receive welfare assistance in accordance with 23 U.S.C. 140(a).
  - c. The contractor will advise employees and applicants for employment of available training programs and entrance requirements for each.
  - d. The contractor will periodically review the training and promotion potential of employees who are minorities and women and will encourage eligible employees to apply for such training and promotion.
7. **Unions:** If the contractor relies in whole or in part upon unions as a source of employees, the contractor will use good faith efforts to obtain the cooperation of such unions to increase opportunities for minorities and women. Actions by the contractor, either directly or through a contractor's association acting as agent, will include the procedures set forth below:
  - a. The contractor will use good faith efforts to develop, in cooperation with the unions, joint training programs aimed toward qualifying more minorities and women for membership in the unions and increasing the skills of minorities and women so that they may qualify for higher paying employment.
  - b. The contractor will use good faith efforts to incorporate an EEO clause into each union agreement to the end that such union will be contractually bound to refer applicants without regard to their race, color, religion, sex, national origin, age or disability.
  - c. The contractor is to obtain information as to the referral practices and policies of the labor union except that to the extent such information is within the exclusive possession of the labor union and such labor union refuses to furnish such information to the contractor, the contractor shall so certify to the contracting agency and shall set forth what efforts have been made to obtain such information.



- d. In the event the union is unable to provide the contractor with a reasonable flow of referrals within the time limit set forth in the collective bargaining agreement, the contractor will, through independent recruitment efforts, fill the employment vacancies without regard to race, color, religion, sex, national origin, age or disability; making full efforts to obtain qualified and/or qualifiable minorities and women. The failure of a union to provide sufficient referrals (even though it is obligated to provide exclusive referrals under the terms of a collective bargaining agreement) does not relieve the contractor from the requirements of this paragraph. In the event the union referral practice prevents the contractor from meeting the obligations pursuant to Executive Order 11246, as amended, and these special provisions, such contractor shall immediately notify the contracting agency.
8. **Reasonable Accommodation for Applicants / Employees with Disabilities:** The contractor must be familiar with the requirements for and comply with the Americans with Disabilities Act and all rules and regulations established there under. Employers must provide reasonable accommodation in all employment activities unless to do so would cause an undue hardship.
9. **Selection of Subcontractors, Procurement of Materials and Leasing of Equipment:** The contractor shall not discriminate on the grounds of race, color, religion, sex, national origin, age or disability in the selection and retention of subcontractors, including procurement of materials and leases of equipment. The contractor shall take all necessary and reasonable steps to ensure nondiscrimination in the administration of this contract.
- a. The contractor shall notify all potential subcontractors and suppliers and lessors of their EEO obligations under this contract.
- b. The contractor will use good faith efforts to ensure subcontractor compliance with their EEO obligations.
10. **Assurance Required by 49 CFR 26.13(b):**
- a. The requirements of 49 CFR Part 26 and the State DOT's U.S. DOT-approved DBE program are incorporated by reference.
- b. The contractor or subcontractor shall not discriminate on the basis of race, color, national origin, or sex in the performance of this contract. The contractor shall carry out applicable requirements of 49 CFR Part 26 in the award and administration of DOT-assisted contracts. Failure by the contractor to carry out these requirements is a material breach of this contract, which may result in the termination of this contract or such other remedy as the contracting agency deems appropriate.
11. **Records and Reports:** The contractor shall keep such records as necessary to document compliance with the EEO requirements. Such records shall be retained for a period of three years following the date of the final payment to the contractor for all contract work and shall be available at reasonable times and places for inspection by authorized representatives of the contracting agency and the FHWA.
- a. The records kept by the contractor shall document the following:
- (1) The number and work hours of minority and non-minority group members and women employed in each work classification on the project;
- (2) The progress and efforts being made in cooperation with unions, when applicable, to increase employment opportunities for minorities and women; and
- (3) The progress and efforts being made in locating, hiring, training, qualifying, and upgrading minorities and women;
- b. The contractors and subcontractors will submit an annual report to the contracting agency each July for the duration of the project, indicating the number of minority, women, and non-minority group employees currently engaged in each work classification required by the contract work. This information is to be reported on Form FHWA-1391. The staffing data should represent the project work force on board in all or any part of the last payroll period preceding the end of July. If on-the-job training is being required by special provision, the contractor will be required to collect and report training data. The employment data should reflect the work force on board during all or any part of the last payroll period preceding the end of July.

### III. NONSEGREGATED FACILITIES

This provision is applicable to all Federal-aid construction contracts and to all related construction subcontracts of \$10,000 or more.

The contractor must ensure that facilities provided for employees are provided in such a manner that segregation on the basis of race, color, religion, sex, or national origin cannot result. The contractor may neither require such segregated use by written or oral policies nor tolerate such use by employee custom. The contractor's obligation extends further to ensure that its employees are not assigned to perform their services at any location, under the contractor's control, where the facilities are segregated. The term "facilities" includes waiting rooms, work areas, restaurants and other eating areas, time clocks, restrooms, washrooms, locker rooms, and other storage or dressing areas, parking lots, drinking fountains, recreation or entertainment areas, transportation, and housing provided for employees. The contractor shall provide separate or single-user restrooms and necessary dressing or sleeping areas to assure privacy between sexes.

### IV. DAVIS-BACON AND RELATED ACT PROVISIONS

This section is applicable to all Federal-aid construction projects exceeding \$2,000 and to all related subcontracts and lower-tier subcontracts (regardless of subcontract size). The requirements apply to all projects located within the right-of-way of a roadway that is functionally classified as Federal-aid highway. This excludes roadways functionally classified as local roads or rural minor collectors, which are exempt. Contracting agencies may elect to apply these requirements to other projects.

The following provisions are from the U.S. Department of Labor regulations in 29 CFR 5.5 "Contract provisions and related matters" with minor revisions to conform to the FHWA-1273 format and FHWA program requirements.

#### 1. Minimum wages

- a. All laborers and mechanics employed or working upon the site of the work, will be paid unconditionally and not less often than once a week, and without subsequent deduction or rebate on any account (except such payroll deductions as are permitted by regulations issued by the Secretary of Labor under the Copeland Act (29 CFR part 3)), the full amount of wages and bona fide fringe benefits (or cash equivalents thereof) due at time of payment computed at rates not less than those contained in the wage determination of the Secretary of Labor which is attached hereto and made a part hereof, regardless of any contractual relationship which may be alleged to exist between the contractor and such laborers and mechanics.

Contributions made or costs reasonably anticipated for bona fide fringe benefits under section 1(b)(2) of the Davis-Bacon Act on behalf of laborers or mechanics are considered wages paid to such laborers or mechanics, subject to the provisions of paragraph 1.d. of this section; also, regular contributions made or costs incurred for more than a weekly period (but not less often than quarterly) under plans, funds, or programs which cover the particular weekly period, are deemed to be constructively made or incurred during such weekly period. Such laborers and mechanics shall be paid the appropriate wage rate and fringe benefits on the wage determination for the classification of work actually performed, without regard to skill, except as provided in 29 CFR 5.5(a)(4). Laborers or mechanics performing work in more than one classification may be compensated at the rate specified for each classification for the time actually worked therein: Provided, That the employer's payroll records accurately set forth the time spent in each classification in which work is performed. The wage determination (including any additional classification and wage rates conformed under paragraph 1.b. of this section) and the Davis-Bacon poster (WH-1321) shall be posted at all times by the contractor and its subcontractors at the site of the work in a prominent and accessible place where it can be easily seen by the workers.

- b. (1) The contracting officer shall require that any class of laborers or mechanics, including helpers, which is not listed in the wage determination and which is to be employed under the contract shall be classified in conformance with the wage determination. The contracting officer shall approve an additional classification and wage rate and fringe benefits therefore only when the following criteria have been met:
  - (i) The work to be performed by the classification requested is not performed by a classification in the wage determination; and
  - (ii) The classification is utilized in the area by the construction industry; and
  - (iii) The proposed wage rate, including any bona fide fringe benefits, bears a reasonable relationship to the wage rates contained in the wage determination.
- (2) If the contractor and the laborers and mechanics to be employed in the classification (if known), or their representatives, and the contracting officer agree on the classification and wage rate (including the amount designated for fringe benefits where appropriate), a report of the action taken shall be sent by the contracting officer to the Administrator of the Wage and Hour Division, Employment Standards Administration, U.S. Department of Labor, Washington, DC 20210. The Administrator, or an authorized representative, will approve, modify, or disapprove every additional classification action within 30 days of receipt and so advise the contracting officer or will notify the contracting officer within the 30-day period that additional time is necessary.
- (3) In the event the contractor, the laborers or mechanics to be employed in the classification or their representatives, and the contracting officer do not agree on the proposed classification and wage rate (including the amount designated for fringe benefits, where appropriate), the contracting officer shall refer the questions, including the views of all interested parties and the recommendation of the contracting officer, to the Wage and Hour Administrator for determination. The Wage and Hour Administrator, or an authorized representative, will issue a determination within 30 days of receipt and so advise the contracting officer or will notify the contracting officer within the 30-day period that additional time is necessary.
- (4) The wage rate (including fringe benefits where appropriate) determined pursuant to paragraphs 1.b.(2) or 1.b.(3) of this section, shall be paid to all workers performing work in the classification under this contract from the first day on which work is performed in the classification.
- c. Whenever the minimum wage rate prescribed in the contract for a class of laborers or mechanics includes a fringe benefit which is not expressed as an hourly rate, the contractor shall either pay the benefit as stated in the wage determination or shall pay another bona fide fringe benefit or an hourly cash equivalent thereof.
- d. If the contractor does not make payments to a trustee or other third person, the contractor may consider as part of the wages of any laborer or mechanic the amount of any costs reasonably anticipated in providing bona fide fringe benefits under a plan or program. Provided, That the Secretary of Labor has found, upon the written request of the contractor, that the applicable standards of the Davis-Bacon Act have been met. The Secretary of Labor may require the contractor to set aside in a separate account assets for the meeting of obligations under the plan or program.
2. **Withholding.** The contracting agency shall upon its own action or upon written request of an authorized representative of the Department of Labor, withhold or cause to be withheld from the contractor under this contract, or any other Federal contract with the same prime contractor, or any other federally-assisted contract subject to Davis-Bacon prevailing wage requirements, which is held by the same prime contractor, so much of the accrued payments or advances as may be considered necessary to pay laborers and mechanics, including apprentices, trainees, and helpers, employed by the contractor or any subcontractor the full amount of wages required by the contract. In the event of failure to pay any laborer or mechanic, including any apprentice, trainee, or helper, employed or working on the site of the work, all or part of the wages required by the contract, the contracting agency may, after written notice to the contractor, take such action as may be necessary to cause the suspension of any further payment, advance, or guarantee of funds until such violations have ceased.
3. **Payrolls and basic records**
  - a. Payrolls and basic records relating thereto shall be maintained by the contractor during the course of the work and preserved for a period of three years thereafter for all laborers and mechanics working at the site of the work. Such records shall contain the name, address, and social security number of each such worker, his or her correct classification, hourly rates of wages paid (including rates of contributions or costs anticipated for bona fide fringe benefits or cash equivalents thereof of the types described in section 1(b)(2)(B) of the Davis-Bacon Act), daily and weekly number of hours worked, deductions made and actual wages paid. Whenever the Secretary of Labor has found under 29 CFR 5.5(a)(1)(iv) that the wages of any laborer or mechanic include the amount of any costs reasonably anticipated in providing benefits under a plan or program described in section 1(b)(2)(B) of the Davis-Bacon Act, the contractor shall maintain records which show that the commitment to provide such benefits is enforceable, that the plan or program is financially responsible, and that the plan or program has been communicated in writing to the laborers or mechanics affected, and records which show the costs anticipated or the actual cost incurred in providing such benefits. Contractors employing apprentices or trainees under approved programs shall maintain written evidence of the registration of apprenticeship programs and certification of trainee programs, the registration of the apprentices and trainees, and the ratios and wage rates prescribed in the applicable programs.
  - b. (1) The contractor shall submit weekly for each week in which any contract work is performed a copy of all payrolls to the contracting agency. The payrolls submitted shall set out accurately and completely all of the information required to be maintained under 29 CFR 5.5(a)(3)(i), except that full social security numbers and home addresses shall not be included on weekly transmittals. Instead the payrolls shall only need to include an individually identifying number for each employee ( e.g. , the last four digits of the employee's social security number). The required weekly payroll information may be submitted in any form desired. Optional Form WH-347 is available for this purpose from the Wage and Hour Division Web site at <http://www.dol.gov/esa/whd/forms/wh347instr.htm> or its successor site. The prime contractor is responsible for the submission of copies of payrolls by all subcontractors. Contractors and subcontractors shall maintain the full social security number and current address of each covered worker, and shall provide them upon request to the contracting agency for transmission to the State DOT, the FHWA or the Wage and Hour Division of the Department of Labor for purposes of an investigation or audit of compliance with prevailing wage requirements. It is not a violation of this section for a prime contractor to require a subcontractor to provide addresses and social security numbers to the prime contractor for its own records, without weekly submission to the contracting agency.
  - (2) Each payroll submitted shall be accompanied by a "Statement of Compliance," signed by the contractor or subcontractor or his or her agent who pays or supervises the payment of the persons employed under the contract and shall certify the following:
    - (i) That the payroll for the payroll period contains the information required to be provided under §5.5 (a)(3)(ii) of Regulations, 29 CFR part 5, the appropriate information is being maintained under §5.5 (a)(3)(i) of Regulations, 29 CFR part 5, and that such information is correct and complete;
    - (ii) That each laborer or mechanic (including each helper, apprentice, and trainee) employed on the contract during the payroll period has been paid the full weekly wages earned, without rebate, either directly or indirectly, and that no deductions have been made either directly or indirectly from the full wages earned, other than permissible deductions as set forth in Regulations, 29 CFR part 3;
    - (iii) That each laborer or mechanic has been paid not less than the applicable wage rates and fringe benefits or cash equivalents for the classification of work performed, as specified in the applicable wage determination incorporated into the contract.

- (3) The weekly submission of a properly executed certification set forth on the reverse side of Optional Form WH-347 shall satisfy the requirement for submission of the "Statement of Compliance" required by paragraph 3.b.(2) of this section.
- (4) The falsification of any of the above certifications may subject the contractor or subcontractor to civil or criminal prosecution under section 1001 of title 18 and section 231 of title 31 of the United States Code.
- c. The contractor or subcontractor shall make the records required under paragraph 3.a. of this section available for inspection, copying, or transcription by authorized representatives of the contracting agency, the State DOT, the FHWA, or the Department of Labor, and shall permit such representatives to interview employees during working hours on the job. If the contractor or subcontractor fails to submit the required records or to make them available, the FHWA may, after written notice to the contractor, the contracting agency or the State DOT, take such action as may be necessary to cause the suspension of any further payment, advance, or guarantee of funds. Furthermore, failure to submit the required records upon request or to make such records available may be grounds for debarment action pursuant to 29 CFR 5.12.
4. **Apprentices and trainees**
- a. Apprentices (programs of the USDOL). Apprentices will be permitted to work at less than the predetermined rate for the work they performed when they are employed pursuant to and individually registered in a bona fide apprenticeship program registered with the U.S. Department of Labor, Employment and Training Administration, Office of Apprenticeship Training, Employer and Labor Services, or with a State Apprenticeship Agency recognized by the Office, or if a person is employed in his or her first 90 days of probationary employment as an apprentice in such an apprenticeship program, who is not individually registered in the program, but who has been certified by the Office of Apprenticeship Training, Employer and Labor Services or a State Apprenticeship Agency (where appropriate) to be eligible for probationary employment as an apprentice.
- The allowable ratio of apprentices to journeymen on the job site in any craft classification shall not be greater than the ratio permitted to the contractor as to the entire work force under the registered program. Any worker listed on a payroll at an apprentice wage rate, who is not registered or otherwise employed as stated above, shall be paid not less than the applicable wage rate on the wage determination for the classification of work actually performed. In addition, any apprentice performing work on the job site in excess of the ratio permitted under the registered program shall be paid not less than the applicable wage rate on the wage determination for the work actually performed. Where a contractor is performing construction on a project in a locality other than that in which its program is registered, the ratios and wage rates (expressed in percentages of the journeyman's hourly rate) specified in the contractor's or subcontractor's registered program shall be observed.
- Every apprentice must be paid at not less than the rate specified in the registered program for the apprentice's level of progress, expressed as a percentage of the journeymen hourly rate specified in the applicable wage determination. Apprentices shall be paid fringe benefits in accordance with the provisions of the apprenticeship program. If the apprenticeship program does not specify fringe benefits, apprentices must be paid the full amount of fringe benefits listed on the wage determination for the applicable classification. If the Administrator determines that a different practice prevails for the applicable apprentice classification, fringes shall be paid in accordance with that determination.
- In the event the Office of Apprenticeship Training, Employer and Labor Services, or a State Apprenticeship Agency recognized by the Office, withdraws approval of an apprenticeship program, the contractor will no longer be permitted to utilize apprentices at less than the applicable predetermined rate for the work performed until an acceptable program is approved.
- b. Trainees (programs of the USDOL). Except as provided in 29 CFR 5.16, trainees will not be permitted to work at less than the predetermined rate for the work performed unless they are employed pursuant to and individually registered in a program which has received prior approval, evidenced by formal certification by the U.S. Department of Labor, Employment and Training Administration.
- The ratio of trainees to journeymen on the job site shall not be greater than permitted under the plan approved by the Employment and Training Administration.
- Every trainee must be paid at not less than the rate specified in the approved program for the trainee's level of progress, expressed as a percentage of the journeyman hourly rate specified in the applicable wage determination. Trainees shall be paid fringe benefits in accordance with the provisions of the trainee program. If the trainee program does not mention fringe benefits, trainees shall be paid the full amount of fringe benefits listed on the wage determination unless the Administrator of the Wage and Hour Division determines that there is an apprenticeship program associated with the corresponding journeyman wage rate on the wage determination which provides for less than full fringe benefits for apprentices. Any employee listed on the payroll at a trainee rate who is not registered and participating in a training plan approved by the Employment and Training Administration shall be paid not less than the applicable wage rate on the wage determination for the classification of work actually performed. In addition, any trainee performing work on the job site in excess of the ratio permitted under the registered program shall be paid not less than the applicable wage rate on the wage determination for the work actually performed.
- In the event the Employment and Training Administration withdraws approval of a training program, the contractor will no longer be permitted to utilize trainees at less than the applicable predetermined rate for the work performed until an acceptable program is approved.
- c. Equal employment opportunity. The utilization of apprentices, trainees and journeymen under this part shall be in conformity with the equal employment opportunity requirements of Executive Order 11246, as amended, and 29 CFR part 30.
- d. Apprentices and Trainees (programs of the U.S. DOT). Apprentices and trainees working under apprenticeship and skill training programs which have been certified by the Secretary of Transportation as promoting EEO in connection with Federal-aid highway construction programs are not subject to the requirements of paragraph 4 of this Section IV. The straight time hourly wage rates for apprentices and trainees under such programs will be established by the particular programs. The ratio of apprentices and trainees to journeymen shall not be greater than permitted by the terms of the particular program.
5. **Compliance with Copeland Act requirements.** The contractor shall comply with the requirements of 29 CFR part 3, which are incorporated by reference in this contract.
6. **Subcontracts.** The contractor or subcontractor shall insert Form FHWA-1273 in any subcontracts and also require the subcontractors to include Form FHWA-1273 in any lower tier subcontracts. The prime contractor shall be responsible for the compliance by any subcontractor or lower tier subcontractor with all the contract clauses in 29 CFR 5.5.
7. **Contract termination:** debarment. A breach of the contract clauses in 29 CFR 5.5 may be grounds for termination of the contract, and for debarment as a contractor and a subcontractor as provided in 29 CFR 5.12.
8. **Compliance with Davis-Bacon and Related Act requirements.** All rulings and interpretations of the Davis-Bacon and Related Acts contained in 29 CFR parts 1, 3, and 5 are herein incorporated by reference in this contract.
9. **Disputes concerning labor standards.** Disputes arising out of the labor standards provisions of this contract shall not be subject to the general disputes clause of this contract. Such disputes shall be resolved in accordance with the procedures of the Department of Labor set forth in 29 CFR parts 5, 6, and 7. Disputes within the meaning of this clause include disputes between the contractor (or any of its subcontractors) and the contracting agency, the U.S. Department of Labor, or the employees or their representatives.
10. **Certification of eligibility.**
- a. By entering into this contract, the contractor certifies that neither it (nor he or she) nor any person or firm who has an interest in the contractor's firm is a person or firm ineligible to be awarded Government contracts by virtue of section 3(a) of the Davis-Bacon Act or 29 CFR 5.12(a)(1).

- b. No part of this contract shall be subcontracted to any person or firm ineligible for award of a Government contract by virtue of section 3(a) of the Davis-Bacon Act or 29 CFR 5.12(a)(1).
- c. The penalty for making false statements is prescribed in the U.S. Criminal Code, 18 U.S.C. 1001.

#### V. CONTRACT WORK HOURS AND SAFETY STANDARDS ACT

The following clauses apply to any Federal-aid construction contract in an amount in excess of \$100,000 and subject to the overtime provisions of the Contract Work Hours and Safety Standards Act. These clauses shall be inserted in addition to the clauses required by 29 CFR 5.5(a) or 29 CFR 4.6. As used in this paragraph, the terms laborers and mechanics include watchmen and guards.

1. **Overtime requirements.** No contractor or subcontractor contracting for any part of the contract work which may require or involve the employment of laborers or mechanics shall require or permit any such laborer or mechanic in any workweek in which he or she is employed on such work to work in excess of forty hours in such workweek unless such laborer or mechanic receives compensation at a rate not less than one and one-half times the basic rate of pay for all hours worked in excess of forty hours in such workweek.
2. **Violation; liability for unpaid wages; liquidated damages.** In the event of any violation of the clause set forth in paragraph (1.) of this section, the contractor and any subcontractor responsible therefor shall be liable for the unpaid wages. In addition, such contractor and subcontractor shall be liable to the United States (in the case of work done under contract for the District of Columbia or a territory, to such District or to such territory), for liquidated damages. Such liquidated damages shall be computed with respect to each individual laborer or mechanic, including watchmen and guards, employed in violation of the clause set forth in paragraph (1.) of this section, in the sum of \$10 for each calendar day on which such individual was required or permitted to work in excess of the standard workweek of forty hours without payment of the overtime wages required by the clause set forth in paragraph (1.) of this section.
3. **Withholding for unpaid wages and liquidated damages.** The FHWA or the contacting agency shall upon its own action or upon written request of an authorized representative of the Department of Labor withhold or cause to be withheld, from any moneys payable on account of work performed by the contractor or subcontractor under any such contract or any other Federal contract with the same prime contractor, or any other federally-assisted contract subject to the Contract Work Hours and Safety Standards Act, which is held by the same prime contractor, such sums as may be determined to be necessary to satisfy any liabilities of such contractor or subcontractor for unpaid wages and liquidated damages as provided in the clause set forth in paragraph (2.) of this section.
4. **Subcontracts.** The contractor or subcontractor shall insert in any subcontracts the clauses set forth in paragraph (1.) through (4.) of this section and also a clause requiring the subcontractors to include these clauses in any lower tier subcontracts. The prime contractor shall be responsible for compliance by any subcontractor or lower tier subcontractor with the clauses set forth in paragraphs (1.) through (4.) of this section.

#### VI. SUBLETTING OR ASSIGNING THE CONTRACT

This provision is applicable to all Federal-aid construction contracts on the National Highway System.

1. The contractor shall perform with its own organization contract work amounting to not less than 30 percent (or a greater percentage if specified elsewhere in the contract) of the total original contract price, excluding any specialty items designated by the contracting agency. Specialty items may be performed by subcontract and the amount of any such specialty items performed may be deducted from the total original contract price before computing the amount of work required to be performed by the contractor's own organization (23 CFR 635.116).
  - a. The term "perform work with its own organization" refers to workers employed or leased by the prime contractor, and equipment owned or rented by the prime contractor, with or without operators. Such term does not include employees or equipment of a subcontractor or lower tier subcontractor, agents of the prime contractor, or any other assignees. The term may include payments for the costs of hiring leased employees

from an employee leasing firm meeting all relevant Federal and State regulatory requirements. Leased employees may only be included in this term if the prime contractor meets all of the following conditions:

- (1) the prime contractor maintains control over the supervision of the day-to-day activities of the leased employees;
  - (2) the prime contractor remains responsible for the quality of the work of the leased employees;
  - (3) the prime contractor retains all power to accept or exclude individual employees from work on the project; and
  - (4) the prime contractor remains ultimately responsible for the payment of predetermined minimum wages, the submission of payrolls, statements of compliance and all other Federal regulatory requirements.
- b. "Specialty Items" shall be construed to be limited to work that requires highly specialized knowledge, abilities, or equipment not ordinarily available in the type of contracting organizations qualified and expected to bid or propose on the contract as a whole and in general are to be limited to minor components of the overall contract.
2. The contract amount upon which the requirements set forth in paragraph (1) of Section VI is computed includes the cost of material and manufactured products which are to be purchased or produced by the contractor under the contract provisions.
  3. The contractor shall furnish (a) a competent superintendent or supervisor who is employed by the firm, has full authority to direct performance of the work in accordance with the contract requirements, and is in charge of all construction operations (regardless of who performs the work) and (b) such other of its own organizational resources (supervision, management, and engineering services) as the contracting officer determines is necessary to assure the performance of the contract.
  4. No portion of the contract shall be sublet, assigned or otherwise disposed of except with the written consent of the contracting officer, or authorized representative, and such consent when given shall not be construed to relieve the contractor of any responsibility for the fulfillment of the contract. Written consent will be given only after the contracting agency has assured that each subcontract is evidenced in writing and that it contains all pertinent provisions and requirements of the prime contract.
  5. The 30% self-performance requirement of paragraph (1) is not applicable to design-build contracts; however, contracting agencies may establish their own self-performance requirements.

#### **VII. SAFETY: ACCIDENT PREVENTION**

This provision is applicable to all Federal-aid construction contracts and to all related subcontracts.

1. In the performance of this contract the contractor shall comply with all applicable Federal, State, and local laws governing safety, health, and sanitation (23 CFR 635). The contractor shall provide all safeguards, safety devices and protective equipment and take any other needed actions as it determines, or as the contracting officer may determine, to be reasonably necessary to protect the life and health of employees on the job and the safety of the public and to protect property in connection with the performance of the work covered by the contract.
2. It is a condition of this contract, and shall be made a condition of each subcontract, which the contractor enters into pursuant to this contract, that the contractor and any subcontractor shall not permit any employee, in performance of the contract, to work in surroundings or under conditions which are unsanitary, hazardous or dangerous to his/her health or safety, as determined under construction safety and health standards (29 CFR 1926) promulgated by the Secretary of Labor, in accordance with Section 107 of the Contract Work Hours and Safety Standards Act (40 U.S.C. 3704).
3. Pursuant to 29 CFR 1926.3, it is a condition of this contract that the Secretary of Labor or authorized representative thereof, shall have right of entry to any site of contract performance to inspect or investigate the matter of compliance with the construction safety and health standards and to carry out the duties of the Secretary under Section 107 of the Contract Work Hours and Safety Standards Act (40 U.S.C.3704).

#### **VIII. FALSE STATEMENTS CONCERNING HIGHWAY PROJECTS**

This provision is applicable to all Federal-aid construction contracts and to all related subcontracts.

In order to assure high quality and durable construction in conformity with approved plans and specifications and a high degree of reliability on statements and representations made by engineers, contractors, suppliers, and workers on Federal-aid highway projects, it is essential that all persons concerned with the project perform their functions as carefully, thoroughly, and honestly as possible. Willful falsification, distortion, or misrepresentation with respect to any facts related to the project is a violation of Federal law. To prevent any misunderstanding regarding the seriousness of these and similar acts, Form FHWA-1022 shall be posted on each Federal-aid highway project (23 CFR 635) in one or more places where it is readily available to all persons concerned with the project:

18 U.S.C. 1020 reads as follows:

"Whoever, being an officer, agent, or employee of the United States, or of any State or Territory, or whoever, whether a person, association, firm, or corporation, knowingly makes any false statement, false representation, or false report as to the character, quality, quantity, or cost of the material used or to be used, or the quantity or quality of the work performed or to be performed, or the cost thereof in connection with the submission of plans, maps, specifications, contracts, or costs of construction on any highway or related project submitted for approval to the Secretary of Transportation; or

Whoever knowingly makes any false statement, false representation, false report or false claim with respect to the character, quality, quantity, or cost of any work performed or to be performed, or materials furnished or to be furnished, in connection with the construction of any highway or related project approved by the Secretary of Transportation; or

Whoever knowingly makes any false statement or false representation as to material fact in any statement, certificate, or report submitted pursuant to provisions of the Federal-aid Roads Act approved July 1, 1916, (39 Stat. 355), as amended and supplemented;

Shall be fined under this title or imprisoned not more than 5 years or both."

#### **IX. IMPLEMENTATION OF CLEAN AIR ACT AND FEDERAL WATER POLLUTION CONTROL ACT**

This provision is applicable to all Federal-aid construction contracts and to all related subcontracts.

By submission of this bid/proposal or the execution of this contract, or subcontract, as appropriate, the bidder, proposer, Federal-aid construction contractor, or subcontractor, as appropriate, will be deemed to have stipulated as follows:

1. That any person who is or will be utilized in the performance of this contract is not prohibited from receiving an award due to a violation of Section 508 of the Clean Water Act or Section 306 of the Clean Air Act.
2. That the contractor agrees to include or cause to be included the requirements of paragraph (1) of this Section X in every subcontract, and further agrees to take such action as the contracting agency may direct as a means of enforcing such requirements.

#### **X. CERTIFICATION REGARDING DEBARMENT, SUSPENSION, INELIGIBILITY AND VOLUNTARY EXCLUSION**

This provision is applicable to all Federal-aid construction contracts, design-build contracts, subcontracts, lower-tier subcontracts, purchase orders, lease agreements, consultant contracts or any other covered transaction requiring FHWA approval or that is estimated to cost \$25,000 or more – as defined in 2 CFR Parts 180 and 1200.

**1. Instructions for Certification – First Tier Participants:**

- a. By signing and submitting this proposal, the prospective first tier participant is providing the certification set out below.
- b. The inability of a person to provide the certification set out below will not necessarily result in denial of participation in this covered transaction. The prospective first tier participant shall submit an explanation of why it cannot provide the certification set out below. The certification or explanation will be considered in connection with the department or agency's determination whether to enter into this transaction. However, failure of the prospective first tier participant to furnish a certification or an explanation shall disqualify such a person from participation in this transaction.
- c. The certification in this clause is a material representation of fact upon which reliance was placed when the contracting agency determined to enter into this transaction. If it is later determined that the prospective participant knowingly rendered an erroneous certification, in addition to other remedies available to the Federal Government, the contracting agency may terminate this transaction for cause of default.
- d. The prospective first tier participant shall provide immediate written notice to the contracting agency to whom this proposal is submitted if any time the prospective first tier participant learns that its certification was erroneous when submitted or has become erroneous by reason of changed circumstances.
- e. The terms "covered transaction," "debarred," "suspended," "ineligible," "participant," "person," "principal," and "voluntarily excluded," as used in this clause, are defined in 2 CFR Parts 180 and 1200. "First Tier Covered Transactions" refers to any covered transaction between a grantee or subgrantee of Federal funds and a participant (such as the prime or general contract). "Lower Tier Covered Transactions" refers to any covered transaction under a First Tier Covered Transaction (such as subcontracts). "First Tier Participant" refers to the participant who has entered into a covered transaction with a grantee or subgrantee of Federal funds (such as the prime or general contractor). "Lower Tier Participant" refers any participant who has entered into a covered transaction with a First Tier Participant or other Lower Tier Participants (such as subcontractors and suppliers).
- f. The prospective first tier participant agrees by submitting this proposal that, should the proposed covered transaction be entered into, it shall not knowingly enter into any lower tier covered transaction with a person who is debarred, suspended, declared ineligible, or voluntarily excluded from participation in this covered transaction, unless authorized by the department or agency entering into this transaction.
- g. The prospective first tier participant further agrees by submitting this proposal that it will include the clause titled "Certification Regarding Debarment, Suspension, Ineligibility and Voluntary Exclusion-Lower Tier Covered Transactions," provided by the department or contracting agency, entering into this covered transaction, without modification, in all lower tier covered transactions and in all solicitations for lower tier covered transactions exceeding the \$25,000 threshold.
- h. A participant in a covered transaction may rely upon a certification of a prospective participant in a lower tier covered transaction that is not debarred, suspended, ineligible, or voluntarily excluded from the covered transaction, unless it knows that the certification is erroneous. A participant is responsible for ensuring that its principals are not suspended, debarred, or otherwise ineligible to participate in covered transactions. To verify the eligibility of its principals, as well as the eligibility of any lower tier prospective participants, each participant may, but is not required to, check the Excluded Parties List System website (<https://www.epls.gov/>), which is compiled by the General Services Administration.
- i. Nothing contained in the foregoing shall be construed to require the establishment of a system of records in order to render in good faith the certification required by this clause. The knowledge and information of the prospective participant is not required to exceed that which is normally possessed by a prudent person in the ordinary course of business dealings.
- j. Except for transactions authorized under paragraph (f) of these instructions, if a participant in a covered transaction knowingly enters into a lower tier covered transaction with a person who is suspended, debarred, ineligible, or voluntarily excluded from participation in this transaction, in addition to other remedies available to the Federal Government, the department or agency may terminate this transaction for cause or default.

\* \* \* \* \*

**2. Certification Regarding Debarment, Suspension, Ineligibility and Voluntary Exclusion – First Tier Participants:**

- a. The prospective first tier participant certifies to the best of its knowledge and belief, that it and its principals:
  - (1) Are not presently debarred, suspended, proposed for debarment, declared ineligible, or voluntarily excluded from participating in covered transactions by any Federal department or agency;
  - (2) Have not within a three-year period preceding this proposal been convicted of or had a civil judgment rendered against them for commission of fraud or a criminal offense in connection with obtaining, attempting to obtain, or performing a public (Federal, State or local) transaction or contract under a public transaction; violation of Federal or State antitrust statutes or commission of embezzlement, theft, forgery, bribery, falsification or destruction of records, making false statements, or receiving stolen property;
  - (3) Are not presently indicted for or otherwise criminally or civilly charged by a governmental entity (Federal, State or local) with commission of any of the offenses enumerated in paragraph (a)(2) of this certification; and
  - (4) Have not within a three-year period preceding this application/proposal had one or more public transactions (Federal, State or local) terminated for cause or default.
- b. Where the prospective participant is unable to certify to any of the statements in this certification, such prospective participant shall attach an explanation to this proposal.

**2. Instructions for Certification - Lower Tier Participants:**

(Applicable to all subcontracts, purchase orders and other lower tier transactions requiring prior FHWA approval or estimated to cost \$25,000 or more - 2 CFR Parts 180 and 1200)

- a. By signing and submitting this proposal, the prospective lower tier is providing the certification set out below.
- b. The certification in this clause is a material representation of fact upon which reliance was placed when this transaction was entered into. If it is later determined that the prospective lower tier participant knowingly rendered an erroneous certification, in addition to other remedies available to the Federal Government, the department, or agency with which this transaction originated may pursue available remedies, including suspension and/or debarment.
- c. The prospective lower tier participant shall provide immediate written notice to the person to which this proposal is submitted if at any time the prospective lower tier participant learns that its certification was erroneous by reason of changed circumstances.
- d. The terms "covered transaction," "debarred," "suspended," "ineligible," "participant," "person," "principal," and "voluntarily excluded," as used in this clause, are defined in 2 CFR Parts 180 and 1200. You may contact the person to which this proposal is submitted for assistance in obtaining a copy of those regulations. "First Tier Covered Transactions" refers to any covered transaction between a grantee or subgrantee of

Federal funds and a participant (such as the prime or general contract). "Lower Tier Covered Transactions" refers to any covered transaction under a First Tier Covered Transaction (such as subcontracts). "First Tier Participant" refers to the participant who has entered into a covered transaction with a grantee or subgrantee of Federal funds (such as the prime or general contractor). "Lower Tier Participant" refers to any participant who has entered into a covered transaction with a First Tier Participant or other Lower Tier Participants (such as subcontractors and suppliers).

- e. The prospective lower tier participant agrees by submitting this proposal that, should the proposed covered transaction be entered into, it shall not knowingly enter into any lower tier covered transaction with a person who is debarred, suspended, declared ineligible, or voluntarily excluded from participation in this covered transaction, unless authorized by the department or agency with which this transaction originated.
- f. The prospective lower tier participant further agrees by submitting this proposal that it will include this clause titled "Certification Regarding Debarment, Suspension, Ineligibility and Voluntary Exclusion-Lower Tier Covered Transaction," without modification, in all lower tier covered transactions and in all solicitations for lower tier covered transactions exceeding the \$25,000 threshold.
- g. A participant in a covered transaction may rely upon a certification of a prospective participant in a lower tier covered transaction that is not debarred, suspended, ineligible, or voluntarily excluded from the covered transaction, unless it knows that the certification is erroneous. A participant is responsible for ensuring that its principals are not suspended, debarred, or otherwise ineligible to participate in covered transactions. To verify the eligibility of its principals, as well as the eligibility of any lower tier prospective participants, each participant may, but is not required to, check the Excluded Parties List System website (<https://www.epls.gov/>), which is compiled by the General Services Administration.
- h. Nothing contained in the foregoing shall be construed to require establishment of a system of records in order to render in good faith the certification required by this clause. The knowledge and information of participant is not required to exceed that which is normally possessed by a prudent person in the ordinary course of business dealings.
- i. Except for transactions authorized under paragraph e of these instructions, if a participant in a covered transaction knowingly enters into a lower tier covered transaction with a person who is suspended, debarred, ineligible, or voluntarily excluded from participation in this transaction, in addition to other remedies available to the Federal Government, the department or agency with which this transaction originated may pursue available remedies, including suspension and/or debarment.

\* \* \* \* \*

**Certification Regarding Debarment, Suspension, Ineligibility and Voluntary Exclusion--Lower Tier Participants:**

1. The prospective lower tier participant certifies, by submission of this proposal, that neither it nor its principals is presently debarred, suspended, proposed for debarment, declared ineligible, or voluntarily excluded from participating in covered transactions by any Federal department or agency.
2. Where the prospective lower tier participant is unable to certify to any of the statements in this certification, such prospective participant shall attach an explanation to this proposal.

\* \* \* \* \*

**XI. CERTIFICATION REGARDING USE OF CONTRACT FUNDS FOR LOBBYING**

This provision is applicable to all Federal-aid construction contracts and to all related subcontracts which exceed \$100,000 (49 CFR 20).

1. The prospective participant certifies, by signing and submitting this bid or proposal, to the best of his or her knowledge and belief, that:
  - a. No Federal appropriated funds have been paid or will be paid, by or on behalf of the undersigned, to any person for influencing or attempting to influence an officer or employee of any Federal agency, a Member of Congress, an officer or employee of Congress, or an employee of a Member of Congress in connection with the awarding of any Federal contract, the making of any Federal grant, the making of any Federal loan, the entering into of any cooperative agreement, and the extension, continuation, renewal, amendment, or modification of any Federal contract, grant, loan, or cooperative agreement.
  - b. If any funds other than Federal appropriated funds have been paid or will be paid to any person for influencing or attempting to influence an officer or employee of any Federal agency, a Member of Congress, an officer or employee of Congress, or an employee of a Member of Congress in connection with this Federal contract, grant, loan, or cooperative agreement, the undersigned shall complete and submit Standard Form-LLL, "Disclosure Form to Report Lobbying," in accordance with its instructions.
2. This certification is a material representation of fact upon which reliance was placed when this transaction was made or entered into. Submission of this certification is a prerequisite for making or entering into this transaction imposed by 31 U.S.C. 1352. Any person who fails to file the required certification shall be subject to a civil penalty of not less than \$10,000 and not more than \$100,000 for each such failure.
3. The prospective participant also agrees by submitting its bid or proposal that the participant shall require that the language of this certification be included in all lower tier subcontracts, which exceed \$100,000 and that all such recipients shall certify and disclose accordingly.

**STANDARD SPECIAL PROVISION****ON-THE-JOB TRAINING**

(10-16-07) (Rev. 4-21-15)

Z-10

**Description**

The North Carolina Department of Transportation will administer a custom version of the Federal On-the-Job Training (OJT) Program, commonly referred to as the Alternate OJT Program. All contractors (existing and newcomers) will be automatically placed in the Alternate Program. Standard OJT requirements typically associated with individual projects will no longer be applied at the project level. Instead, these requirements will be applicable on an annual basis for each contractor administered by the OJT Program Manager.

On the Job Training shall meet the requirements of 23 CFR 230.107 (b), 23 USC – Section 140, this provision and the On-the-Job Training Program Manual.

The Alternate OJT Program will allow a contractor to train employees on Federal, State and privately funded projects located in North Carolina. However, priority shall be given to training employees on NCDOT Federal-Aid funded projects.

**Minorities and Women**

Developing, training and upgrading of minorities and women toward journeyman level status is a primary objective of this special training provision. Accordingly, the Contractor shall make every effort to enroll minority and women as trainees to the extent that such persons are available within a reasonable area of recruitment. This training commitment is not intended, and shall not be used, to discriminate against any applicant for training, whether a member of a minority group or not.

**Assigning Training Goals**

The Department, through the OJT Program Manager, will assign training goals for a calendar year based on the contractors' past three years' activity and the contractors' anticipated upcoming year's activity with the Department. At the beginning of each year, all contractors eligible will be contacted by the Department to determine the number of trainees that will be assigned for the upcoming calendar year. At that time the Contractor shall enter into an agreement with the Department to provide a self-imposed on-the-job training program for the calendar year. This agreement will include a specific number of annual training goals agreed to by both parties. The number of training assignments may range from 1 to 15 per contractor per calendar year. The Contractor shall sign an agreement to fulfill their annual goal for the year.\



## Training Classifications

The Contractor shall provide on-the-job training aimed at developing full journeyman level workers in the construction craft/operator positions. Preference shall be given to providing training in the following skilled work classifications:

Equipment Operators	Office Engineers
Truck Drivers	Estimators
Carpenters	Iron / Reinforcing Steel Workers
Concrete Finishers	Mechanics
Pipe Layers	Welders

The Department has established common training classifications and their respective training requirements that may be used by the contractors. However, the classifications established are not all-inclusive. Where the training is oriented toward construction applications, training will be allowed in lower-level management positions such as office engineers and estimators. Contractors shall submit new classifications for specific job functions that their employees are performing. The Department will review and recommend for acceptance to FHWA the new classifications proposed by contractors, if applicable. New classifications shall meet the following requirements:

Proposed training classifications are reasonable and realistic based on the job skill classification needs, and

The number of training hours specified in the training classification is consistent with common practices and provides enough time for the trainee to obtain journeyman level status.

The Contractor may allow trainees to be trained by a subcontractor provided that the Contractor retains primary responsibility for meeting the training and this provision is made applicable to the subcontract. However, only the Contractor will receive credit towards the annual goal for the trainee.

Where feasible, 25 percent of apprentices or trainees in each occupation shall be in their first year of apprenticeship or training. The number of trainees shall be distributed among the work classifications on the basis of the contractor's needs and the availability of journeymen in the various classifications within a reasonable area of recruitment.

No employee shall be employed as a trainee in any classification in which they have successfully completed a training course leading to journeyman level status or in which they have been employed as a journeyman.

## Records and Reports

The Contractor shall maintain enrollment, monthly and completion reports documenting company compliance under these contract documents. These documents and any other information as requested shall be submitted to the OJT Program Manager.

Upon completion and graduation of the program, the Contractor shall provide each trainee with a certification Certificate showing the type and length of training satisfactorily completed.

**Trainee Interviews**

All trainees enrolled in the program will receive an initial and Trainee/Post graduate interview conducted by the OJT program staff.

**Trainee Wages**

Contractors shall compensate trainees on a graduating pay scale based upon a percentage of the prevailing minimum journeyman wages (Davis-Bacon Act). Minimum pay shall be as follows:

60 percent	of the journeyman wage for the first half of the training period
75 percent	of the journeyman wage for the third quarter of the training period
90 percent	of the journeyman wage for the last quarter of the training period

In no instance shall a trainee be paid less than the local minimum wage. The Contractor shall adhere to the minimum hourly wage rate that will satisfy both the NC Department of Labor (NCDOL) and the Department.

**Achieving or Failing to Meet Training Goals**

The Contractor will be credited for each trainee employed by him on the contract work who is currently enrolled or becomes enrolled in an approved program and who receives training for at least 50 percent of the specific program requirement. Trainees will be allowed to be transferred between projects if required by the Contractor's scheduled workload to meet training goals.

If a contractor fails to attain their training assignments for the calendar year, they may be taken off the NCDOT's Bidders List.

**Measurement and Payment**

No compensation will be made for providing required training in accordance with these contract documents.

**STANDARD SPECIAL PROVISION**  
**MINIMUM WAGES**  
**GENERAL DECISION NC20220090 02/25/2022 NC90**

Z-090

Date: February 25, 2022

General Decision Number: NC20220090 02/25/2022 NC90

Superseded General Decision Numbers: NC20210090

State: North Carolina

Construction Type: HIGHWAY

**COUNTIES:**

Brunswick	Greene	Onslow
Cumberland	Hoke	Pender
Currituck	Johnston	Pitt
Edgecombe	Nash	Wake
Franklin	New Hanover	Wayne

HIGHWAY CONSTRUCTION PROJECTS (excluding tunnels, building structures in rest area projects & railroad construction; bascule, suspension & spandrel arch bridges designed for commercial navigation, bridges involving marine construction; and other major bridges).

Note: Contracts subject to the Davis-Bacon Act are generally required to pay at least the applicable minimum wage rate required under Executive Order 14026 or Executive Order 13658. Please note that these Executive Orders apply to covered contracts entered into by the federal government that are subject to the Davis-Bacon Act itself, but do not apply to contracts subject only to the Davis-Bacon Related Acts, including those set forth at 29 CFR 5.1(a)(2)-(60).

If the contract is entered into on or after January 30, 2022, or the contract is renewed or extended (e.g., an option is exercised) on or after January 30, 2022:	Executive Order 14026 generally applies to the contract.  The contractor must pay all covered workers at least \$15.00 per hour (or the applicable wage rate listed on this wage determination, if it is higher) for all hours spent performing on that contract in 2022.
If the contract was awarded on or between January 1, 2015 and January 29, 2022, and the contract is not renewed or extended on or after January 30, 2022:	Executive Order 13658 generally applies to the contract.  The contractor must pay all covered workers at least \$11.25 per hour (or the applicable wage rate listed on this wage determination, if it is higher) for all hours spent performing on that contract in 2022.

The applicable Executive Order minimum wage rate will be adjusted annually. If this contract is covered by one of the Executive Orders and a classification considered necessary for performance of work on the contract does not appear on this wage determination, the contractor must still submit a conformance request.

Additional information on contractor requirements and worker protections under the Executive Orders is available at <https://www.dol.gov/agencies/whd/government-contracts>.

Modification Number	Publication Date
0	01/07/2022
1	02/25/2022

SUNC2014-005 11/17/2014

	Rates	Fringes
BLASTER	21.04	
CARPENTER	13.72 **	
CEMENT MASON/CONCRETE FINISHER	14.48 **	
ELECTRICIAN		
Electrician	17.97	
Telecommunications Technician	16.79	.63
IRONWORKER	16.02	
LABORER		
Asphalt Raker and Spreader	12.46 **	
Asphalt Screed/Jackman	14.33 **	
Carpenter Tender	12.88 **	
Cement Mason/Concrete Finisher Tender	12.54 **	
Common or General	10.20 **	
Guardrail/Fence Installer	12.87 **	
Pipelayer	12.17 **	
Traffic Signal/Lighting Installer	14.89 **	
PAINTER		
Bridge	24.57	
POWER EQUIPMENT OPERATORS		
Asphalt Broom Tractor	11.85 **	
Bulldozer Fine	17.04	
Bulldozer Rough	14.34 **	
Concrete Grinder/Groover	20.34	2.30
Crane Boom Trucks	20.54	
Crane Other	20.08	
Crane Rough/All-Terrain	20.67	
Drill Operator Rock	14.38 **	
Drill Operator Structure	21.14	
Excavator Fine	16.60	
Excavator Rough	14.00 **	
Grader/Blade Fine	18.47	
Grader/Blade Rough	14.62 **	
Loader 2 Cubic Yards or Less	13.76 **	
Loader Greater Than 2 Cubic Yards	14.14 **	
Material Transfer Vehicle (Shuttle Buggy)	15.18	
Mechanic	17.55	
Milling Machine	15.36	
Off-Road Hauler/Water Tanker	11.36 **	
Oiler/Greaser	13.55 **	
Pavement Marking Equipment	12.11 **	
Paver Asphalt	15.59	
Paver Concrete	18.20	
Roller Asphalt Breakdown	12.45 **	
Roller Asphalt Finish	13.85 **	

	Rates	Fringes
Roller Other	11.36 **	
Scraper Finish	12.71 **	
Scraper Rough	11.35 **	
Slip Form Machine	16.50	
Tack Truck/Distributor Operator	14.52 **	
TRUCK DRIVER		
GVWR of 26,000 Lbs or Less	11.12 **	
GVWR of 26,001 Lbs or Greater	12.37 **	

Welders – Receive rate prescribed for craft performing operation to which welding is incidental.

\*\* Workers in this classification may be entitled to a higher minimum wage under Executive Order 14026 (\$15.00) or 13658 (\$11.25). Please see the Note at the top of the wage determination for more information.

Note: Executive Order (EO) 13706, Establishing Paid Sick Leave for Federal Contractors applies to all contracts subject to the Davis-Bacon Act for which the contract is awarded (and any solicitation was issued) on or after January 1, 2017. If this contract is covered by the EO, the contractor must provide employees with 1 hour of paid sick leave for every 30 hours they work, up to 56 hours of paid sick leave each year. Employees must be permitted to use paid sick leave for their own illness, injury or other health-related needs, including preventive care; to assist a family member (or person who is like family to the employee) who is ill, injured, or has other health-related needs, including preventive care; or for reasons resulting from, or to assist a family member (or person who is like family to the employee) who is a victim of, domestic violence, sexual assault, or stalking. Additional information on contractor requirements and worker protections under the EO is available at <https://www.dol.gov/agencies/whd/government-contracts>.

Unlisted classifications needed for work not included within the scope of the classifications listed may be added after award only as provided in the labor standards contract clauses (29 CFR 5.5(a)(1)(ii)).

The body of each wage determination lists the classification and wage rates that have been found to be prevailing for the cited type(s) of construction in the area covered by the wage determination. The classifications are listed in alphabetical order of "identifiers" that indicate whether the particular rate is a union rate (current union negotiated rate for local), a survey rate (weighted average rate) or a union average rate (weighted union average rate).

#### Union Rate Identifiers

A four letter classification abbreviation identifier enclosed in dotted lines beginning with characters other than "SU" or "UAVG" denotes that the union classification and rate were prevailing for that classification in the survey. Example: PLUM0198-005 07/01/2014. PLUM is an abbreviation identifier of the union which prevailed in the survey for this classification, which in this example would be Plumbers. 0198 indicates the local union number or district council number where applicable, i.e., Plumbers Local 0198. The next number, 005 in the example, is an internal number used in processing the wage determination. 07/01/2014 is the effective date of the most current negotiated rate, which in this example is July 1, 2014.

Union prevailing wage rates are updated to reflect all rate changes in the collective bargaining agreement (CBA) governing this classification and rate.

### Survey Rate Identifiers

Classifications listed under the "SU" identifier indicate that no one rate prevailed for this classification in the survey and the published rate is derived by computing a weighted average rate based on all the rates reported in the survey for that classification. As this weighted average rate includes all rates reported in the survey, it may include both union and non-union rates. Example: SULA2012-007 5/13/2014. SU indicates the rates are survey rates based on a weighted average calculation of rates and are not majority rates. LA indicates the State of Louisiana. 2012 is the year of survey on which these classifications and rates are based. The next number, 007 in the example, is an internal number used in producing the wage determination. 5/13/2014 indicates the survey completion date for the classifications and rates under that identifier.

Survey wage rates are not updated and remain in effect until a new survey is conducted.

### Union Average Rate Identifiers

Classification(s) listed under the UAVG identifier indicate that no single majority rate prevailed for those classifications; however, 100% of the data reported for the classifications was union data. EXAMPLE: UAVG-OH-0010 08/29/2014. UAVG indicates that the rate is a weighted union average rate. OH indicates the state. The next number, 0010 in the example, is an internal number used in producing the wage determination. 08/29/2014 indicates the survey completion date for the classifications and rates under that identifier.

A UAVG rate will be updated once a year, usually in January of each year, to reflect a weighted average of the current negotiated/CBA rate of the union locals from which the rate is based.

### WAGE DETERMINATION APPEALS PROCESS

1.) Has there been an initial decision in the matter? This can be:

- \* an existing published wage determination
- \* a survey underlying a wage determination
- \* a Wage and Hour Division letter setting forth a position on a wage determination matter
- \* a conformance (additional classification and rate) ruling

On survey related matters, initial contact, including requests for summaries of surveys, should be with the Wage and Hour National Office because National Office has responsibility for the David-Bacon survey program. If the response from this initial contact is not satisfactory, then the process described in 2.) and 3.) should be followed.

With regard to any other matter not yet ripe for the formal process described here, initial contact should be with the Branch of Construction Wage Determinations. Write to:

Branch of Construction Wage Determinations  
Wage and Hour Division  
U. S. Department of Labor  
200 Constitution Avenue, N.W.  
Washington, D.C. 20210

- 2.) If the answer to the question in 1.) is yes, then an interested party (those affected by the action) can request review and reconsideration from the Wage and Hour Administrator (See 29 CFR Part 1.8 and 29 CFR Part 7). Write to:

Wage and Hour Administrator  
U.S. Department of Labor  
200 Constitution Avenue, N.W.  
Washington, D.C. 20210

The request should be accompanied by a full statement of the interested party's position and by any information (wage payment data, project description, area practice material, etc.) that the requestor considers relevant to the issue.

- 3.) If the decision of the Administrator is not favorable, an interested party may appeal directly to the Administrative Review Board (formerly the Wage Appeals Board). Write to:

Administrative Review Board  
U.S. Department of Labor  
200 Constitution Avenue, N.W.  
Washington, D.C. 20210

- 4.) All decisions by the Administrative Review Board are final.

END OF GENERAL DECISION

**PROJECT SPECIAL PROVISIONS**

**GEOTECHNICAL**

MECHANICALLY STABILIZED EARTH RETAINING WALLS - (10/19/2021)	GT-1.1 - GT-1.12
CONTINUOUS FLIGHT AUGER PILES FOR SOUND BARRIER WALLS (SPECIAL)	GT-2.1 - GT-2.5

DocuSigned by:  
*Geotechnical Engineering Unit*  
E06538624A11498...  
04/25/2022



**MECHANICALLY STABILIZED EARTH RETAINING WALLS****(10-19-21)****1.0 GENERAL**

Construct mechanically stabilized earth (MSE) retaining walls consisting of steel or geosynthetic reinforcement in the reinforced zone connected to vertical facing elements. Use precast concrete panels for vertical facing elements and coarse aggregate in the reinforced zone unless noted otherwise in the plans. Provide reinforced concrete coping and pile sleeves as required. Design and construct MSE retaining walls based on actual elevations and wall dimensions in accordance with the contract and accepted submittals. Use a prequalified MSE Wall Installer to construct MSE retaining walls.

Define MSE wall terms as follows:

*Geosynthetic Reinforcement* – Polyester Type (PET), HDPE or Polypropylene (PP) geosynthetic grids, i.e., geogrid reinforcement or polymer straps, i.e., geostrip reinforcement,

*Geogrid* – PET, HDPE or PP geogrid,

*Reinforcement* – Steel or geosynthetic reinforcement,

*Aggregate* – Coarse or fine aggregate,

*Panel* – Precast concrete panel,

*Coping* – Precast or CIP concrete coping,

*Design Height (H)* – Wall height + wall embedment as shown in the plans,

*MSE Wall* – Mechanically stabilized earth retaining wall,

*MSE Wall Vendor* – Vendor supplying the chosen MSE wall system,

*MSE Panel Wall* – MSE wall with panels,

*MSE Segmental Wall* – MSE wall with segmental retaining wall (SRW) units and

*Abutment Wall* – MSE wall with bridge foundations in any portion of the reinforced zone or an MSE wall connected to an abutment wall (even if bridge foundations only penetrate a small part of the reinforced zone, the entire MSE wall is considered an abutment wall).

For bridge approach fills behind end bents with MSE abutment walls, design reinforcement connected to end bent caps in accordance with the plans and this provision. Construct Type III Reinforced Bridge Approach Fills in accordance with the *Bridge Approach Fills* provision and Roadway Detail Drawing No. 422D10.

Use an approved MSE wall system in accordance with the plans and any NCDOT restrictions or exceptions for the chosen system. Value engineering proposals for other MSE wall systems will not be considered. Do not use MSE wall systems with an “approved for provisional use” status for MSE walls with design heights greater than 35 ft or walls supporting or adjacent to railroads or interstate highways. The list of approved MSE wall systems with approval status is available from:

[connect.ncdot.gov/resources/Geological/Pages/Products.aspx](http://connect.ncdot.gov/resources/Geological/Pages/Products.aspx)

**2.0 MATERIALS**

Refer to the *Standard Specifications*.

**Item**

**Section**

Aggregate	1014
Asphalt Concrete Base Course, Type B25.0C	620
Corrugated Steel Pipe	1032-3
Epoxy, Type 3A	1081
Geosynthetics	1056
Grout, Type 3	1003
Joint Materials	1028
Portland Cement Concrete, Class A	1000
Precast Retaining Wall Coping	1077
Reinforcing Steel	1070
Retaining Wall Panels	1077
Segmental Retaining Wall Units	1040-4
Select Material, Class V	1016
Shoulder Drain Materials	816-2
Steel Pipe	1036-4(A)

Use galvanized corrugated steel pipe with a zinc coating weight of 2 oz/sf (G200) for pile sleeves. Provide Type 2 geotextile for filtration and separation geotextiles. Use Class A concrete for CIP coping, leveling concrete and pads. Use galvanized steel pipe, threaded rods and nuts for the PET geogrid reinforcement vertical obstruction detail. Provide galvanized Grade 36 anchor rods and Grade A hex nuts that meet AASHTO M 314 for threaded rods and nuts.

Use panels and SRW units from producers approved by the Department and licensed by the MSE Wall Vendor. Provide steel strip connectors embedded in panels fabricated from structural steel that meets the requirements for steel strip reinforcement. Unless required otherwise in the contract, produce panels with a smooth flat final finish that meets Article 1077-11 of the *Standard Specifications*. Accurately locate and secure reinforcement connectors in panels and maintain required concrete cover. Produce panels within 1/4" of the panel dimensions shown in the accepted submittals.

Damaged panels or SRW units with excessive discoloration, chips or cracks as determined by the Engineer will be rejected. Do not damage reinforcement connection devices or mechanisms in handling or storing panels and SRW units.

Store steel materials on blocking at least 12" above the ground and protect it at all times from damage; and when placing in the work make sure it is free from dirt, dust, loose mill scale, loose rust, paint, oil or other foreign materials. Handle and store geosynthetics in accordance with Article 1056-2 of the *Standard Specifications*. Load, transport, unload and store MSE wall materials so materials are kept clean and free of damage. Bent, damaged or defective materials will be rejected.

#### A. Aggregate

Use standard size No. 57, 57M, 67 or 78M that meets Table 1005-1 of the *Standard Specifications* for coarse aggregate and the following for fine aggregate:

1. Standard size No. 1S, 2S, 2MS or 4S that meets Table 1005-2 of the *Standard*

*Specifications or*

2. Gradation that meets Class III, Type 3 select material in accordance with Article 1016-3 of the *Standard Specifications*.

Fine aggregate is exempt from mortar strength in Subarticle 1014-1(E) of the *Standard Specifications*. Use fine aggregate with a maximum organic content of 1.0%. Provide aggregate with chemical properties that meet the following requirements:

<b>AGGREGATE pH REQUIREMENTS</b>		
<b>Aggregate Type (in reinforced zone)</b>	<b>Reinforcement or Connector Material</b>	<b>pH</b>
Coarse or Fine	Steel	5 – 10
Coarse or Fine	Geosynthetic	4.5 – 9

<b>AGGREGATE ELECTROCHEMICAL REQUIREMENTS (Steel Reinforcement/Connector Materials Only)</b>			
<b>Aggregate Type (in reinforced zone)</b>	<b>Resistivity</b>	<b>Chlorides</b>	<b>Sulfates</b>
Coarse	$\geq 5,000 \Omega \cdot \text{cm}$	$\leq 100 \text{ ppm}$	$\leq 200 \text{ ppm}$
Fine	$\geq 3,000 \Omega \cdot \text{cm}$		

Use aggregate from sources participating in the Department's Aggregate QC/QA Program as described in Section 1006 of the *Standard Specifications*. Sample and test aggregate in accordance with the *Mechanically Stabilized Earth Wall Aggregate Sampling and Testing Procedures*.

#### B. Reinforcement

Provide steel or geosynthetic reinforcement supplied by the MSE Wall Vendor or a manufacturer approved or licensed by the vendor. Use reinforcement approved for the chosen MSE wall system. The list of approved reinforcement for each MSE wall system is available from the website shown elsewhere in this provision.

##### 1. Steel Reinforcement

Provide Type 1 material certifications in accordance with Article 106-3 of the *Standard Specifications* for steel reinforcement. Use welded wire grid reinforcement ("mesh", "mats" and "ladders") that meet Article 1070-3 of the *Standard Specifications* and steel strip reinforcement ("straps") that meet ASTM A572, A1011 or A463. Use 10 gauge or heavier structural steel Grade 50 or higher for steel strip reinforcement. Galvanize steel reinforcement in accordance with Section 1076 of the *Standard Specifications* or provide aluminized steel strip reinforcement that meet ASTM A463, Type 2-100.

##### 2. Geosynthetic Reinforcement

Provide Type 1 material certifications and identify geosynthetic reinforcement in accordance with Article 1056-3 of the *Standard Specifications*. Define machine direction (MD) and cross-machine direction (CD) for geogrids per Article 1056-3 of the *Standard Specifications*.

Use HDPE or PP geogrid for geogrid reinforcement cast into backwalls of end bent caps. Use PET or HDPE geogrid for geogrid reinforcement connected directly to SRW units and only HDPE geogrid for geogrid reinforcement cast into panels.

Provide extruded geogrids produced in the United States and manufactured from punched and drawn polypropylene sheets for PP geogrids that meet the following:

<b>PP GEOGRID REQUIREMENTS</b>		
<b>Property</b>	<b>Requirement<sup>1</sup></b>	<b>Test Method</b>
Aperture Dimensions <sup>2</sup>	1" x 1.2"	N/A
Minimum Rib Thickness <sup>2</sup>	0.07" x 0.07"	N/A
Tensile Strength @ 2% Strain <sup>2</sup>	580 lb/ft x 690 lb/ft	ASTM D6637, Method B
Tensile Strength @ 5% Strain <sup>2</sup>	1,200 lb/ft x 1,370 lb/ft	
Ultimate Tensile Strength <sup>2</sup>	1,850 lb/ft x 2,050 lb/ft	
Junction Efficiency <sup>3</sup> (MD)	93%	ASTM D7737
Flexural Rigidity <sup>4</sup>	2,000,000 mg-cm	ASTM D7748
Aperture Stability Modulus <sup>5</sup>	0.55 lb-ft/degrees	ASTM D7864
UV Stability (Retained Strength)	100% (after 500 hr of exposure)	ASTM D4355

- MARV per Article 1056-3 of the *Standard Specifications* except dimensions and thickness are nominal.
- Requirement for MD x CD.
- Junction Efficiency (%) = (Average Junction Strength ( $X_{j_{ave}}$ ) / Ultimate Tensile Strength in the MD from ASTM D6637, Method A)  $\times$  100.
- Test specimens two ribs wide, with transverse ribs cut flush with exterior edges of longitudinal ribs, and sufficiently long to enable measurement of the overhang dimension.
- Applied moment of 17.7 lb-inch (torque increment).

### C. Bearing Pads

For MSE panel walls, use preformed ethylene propylene diene monomer rubber bearing pads that meet ASTM D2000 Grade 2, Type A, Class A with a durometer hardness of 60 or 80  $\pm$  5. Provide bearing pads with thicknesses that meet the following:

<b>BEARING PAD THICKNESS</b>	
<b>Facing Area per Panel (A)</b>	<b>Minimum Pad Thickness After Compression (based on 2 times panel weight above pads)</b>
$A \leq 30$ sf	1/2"
$30 \text{ sf} < A \leq 75$ sf	3/4"

#### D. Miscellaneous Components

Miscellaneous components may include connectors (e.g., anchors, bars, clamps, pins, plates, ties, etc.), fasteners (e.g., bolts, nuts, washers, etc.) and any other MSE wall components not included above. Use 10 gauge or heavier structural steel Grade 50 or higher for steel strip panel anchors and connectors. Galvanize steel components in accordance with Section 1076 of the *Standard Specifications*. Provide miscellaneous components approved for the chosen MSE wall system. The list of approved miscellaneous components for each MSE wall system is available from the website shown elsewhere in this provision.

### 3.0 PRECONSTRUCTION REQUIREMENTS

#### A. MSE Wall Surveys

The Retaining Wall Plans show a plan view, typical sections, details, notes and an elevation or profile view (wall envelope) for each MSE wall. Before beginning MSE wall design, survey existing ground elevations shown in the plans and other elevations in the vicinity of MSE wall locations as needed. For proposed slopes above or below MSE walls, survey existing ground elevations to at least 10 ft beyond slope stake points. Based on these elevations, finished grades and actual MSE wall dimensions and details, submit revised wall envelopes for acceptance. Use accepted wall envelopes for design.

#### B. MSE Wall Designs

For MSE wall designs, submit PDF files of working drawings and design calculations at least 30 days before the preconstruction meeting. Note name and NCDOT ID number of the panel or SRW unit production facility on working drawings. Do not begin MSE wall construction until a design submittal is accepted.

Use a prequalified MSE Segmental Wall Design Consultant to design MSE segmental walls. Provide MSE segmental wall designs sealed by a Design Engineer approved as a Geotechnical Engineer (key person) for the MSE Segmental Wall Design Consultant. Provide MSE panel wall designs sealed by a Design Engineer licensed in the state of North Carolina and employed or contracted by the MSE Wall Vendor.

Design MSE walls in accordance with the plans, *AASHTO LRFD Bridge Design Specifications* and any NCDOT restrictions for the chosen MSE wall system unless otherwise required. For abutment walls only, design MSE walls for seismic if wall sites meet either or both of the following:

- Wall site is in seismic zone 2 based on Figure 2-1 of the *Structure Design Manual*,
- Wall site is classified as AASHTO Site Class E, as noted in the plans, and is in or west of Pender, Duplin, Wayne, Johnston, Wake, Durham or Person County.

Connect reinforcement to panels or SRW units with methods or devices approved for the chosen system. Use a uniform reinforcement length throughout the height of the

wall of at least 0.7H or 6 ft, whichever is longer, unless noted otherwise in the plans. Extend the reinforced zone at least 6" beyond end of reinforcement. Do not locate drains, the reinforced zone or leveling pads outside right-of-way or easement limits.

Use the simplified method for determining maximum reinforcement loads and design parameters approved for the chosen MSE wall system or default values in accordance with the AASHTO LRFD specifications. Design steel components including reinforcement and connectors for the design life noted in the plans and aggregate type in the reinforced zone. If an MSE wall system with geosynthetic reinforcement includes any steel parts for obstructions, bin walls, connections or other components, design steel exposed to aggregate for the design life noted in the plans and aggregate type in the reinforced zone. Use "loss of galvanizing" metal loss rates for nonaggressive backfill in accordance with the AASHTO LRFD specifications for galvanized and aluminized steel and metal loss rates for carbon steel in accordance with the following:

<b>CARBON STEEL CORROSION RATES</b>	
<b>Aggregate Type (in reinforced zone)</b>	<b>Carbon Steel Loss Rate (after coating depletion)</b>
Coarse	0.47 mil/year
Fine (except abutment walls)	0.58 mil/year
Fine (abutment walls)	0.70 mil/year

For PET or HDPE geogrid and geostrip reinforcement and geosynthetic connectors, use approved geosynthetic properties for the design life noted in the plans and aggregate type in the reinforced zone. For geogrid reinforcement connected to end bent caps, embed reinforcement or connectors in caps as shown in the plans. For PP geogrid reinforcement connected to end bent caps, use the following design parameters for the aggregate type in the reinforced approach fill.

<b>PP GEOGRID REINFORCEMENT DESIGN PARAMETERS</b>				
<b>Aggregate Type (in reinforced zone)</b>	<b>T<sub>al</sub> (MD)</b>	<b>F*</b>	<b>α</b>	<b>ρ</b>
Coarse	400 lb/ft	0.70	0.8	32.0°
Fine	428 lb/ft	0.54	0.8	28.35°

Where,

- T<sub>al</sub> = long-term design strength (LTDS),  
 F\* = pullout resistance factor,  
 α = scale effect correction factor and  
 ρ = soil-geogrid friction angle.

When noted in the plans, design MSE walls for a live load (traffic) surcharge of 250 psf in accordance with Figure C11.5.6-3(b) of the AASHTO LRFD specifications. For steel beam guardrail with 8 ft posts or concrete barrier rail above MSE walls, analyze top 2 reinforcement layers for traffic impact loads in accordance with Section 7.2 of *FHWA Design and Construction of Mechanically Stabilized Earth Walls and*

*Reinforced Soil Slopes – Volume I* (Publication No. FHWA-NHI-10-024) except use the following for geosynthetic reinforcement rupture:

$$\phi T_{al} R_c \geq T_{max} + (T_I / RF_{CR})$$

Where,

- $\phi$  = resistance factor for tensile resistance in accordance with Section 7.2.1 of the FHWA MSE wall manual,
- $T_{al}$  = long-term geosynthetic design strength approved for chosen MSE wall system,
- $R_c$  = reinforcement coverage ratio = 1 for continuous geosynthetic reinforcement,
- $T_{max}$  = factored static load in accordance with Section 7.2 of the FHWA MSE wall manual,
- $T_I$  = factored impact load in accordance with Section 7.2 of the FHWA MSE wall manual and
- $RF_{CR}$  = creep reduction factor approved for chosen MSE wall system.

When shown in the plans for abutment walls, use pile sleeves to segregate piles from aggregate in the reinforced zone. If existing or future obstructions such as foundations, guardrail, fence or handrail posts, moment slabs, pavements, pipes, inlets or utilities will interfere with reinforcement, maintain a clearance of at least 3" between obstructions and reinforcement unless otherwise approved. Design reinforcement for obstructions and locate reinforcement layers so all of reinforcement length is within 3" of corresponding connection elevations. Modify PET geogrid reinforcement for obstructions as shown in the plans.

Use 6" thick CIP unreinforced concrete leveling pads beneath panels and SRW units that are continuous at steps and extend at least 6" in front of and behind bottom row of panels or SRW units. Unless required otherwise in the plans, embed top of leveling pads in accordance with the following requirements:

<b>WALL EMBEDMENT REQUIREMENTS</b>		
<b>Front Slope<sup>1</sup> (H:V)</b>	<b>Minimum Embedment Depth<sup>2</sup> (whichever is greater)</b>	
6:1 or flatter (except abutment walls)	H/20	1 ft for H ≤ 10 ft 2 ft for H > 10 ft
6:1 or flatter (abutment walls)	H/10	2 ft
> 6:1 to < 3:1	H/10	2 ft
3:1 to 2:1	H/7	2 ft

1. Front slope is as shown in the plans.
2. H is the maximum design height per wall.

When noted in the plans, locate a continuous aggregate shoulder drain along the base of the reinforced zone behind the aggregate. Provide wall drainage systems consisting of drains and outlet components in accordance with Roadway Standard Drawing No. 816.02.

For MSE panel walls, cover joints at back of panels with filtration geotextiles at least 12" wide. If the approval of the chosen MSE wall system does not require a minimum number of bearing pads, provide the number of pads in accordance with the following:

<b>NUMBER OF BEARING PADS</b>		
<b>Facing Area per Panel (A)</b>	<b>Maximum Height of Wall Above Horizontal Panel Joint</b>	<b>Minimum Number of Pads per Horizontal Panel Joint</b>
A ≤ 30 sf	25 ft	2
	35 ft <sup>1</sup>	3
30 sf < A ≤ 75 sf	25 ft	3
	35 ft <sup>1</sup>	4

1. Additional bearing pads per horizontal panel joint may be required for wall heights above joints greater than 35 ft.

For MSE segmental walls, coarse aggregate is required in any SRW unit core spaces and between and behind SRW units for a horizontal distance of at least 18".

Separation geotextiles are required between the aggregate and overlying fill sections. When noted in the plans, separation geotextiles are also required at the back of the reinforced zone between the aggregate and backfill or natural ground. When placing pavement sections directly on the reinforced zone, cap aggregate with 4" of asphalt concrete base course. Unless required otherwise in the plans, use reinforced concrete coping at top of walls that meets the following requirements:

1. Coping dimensions as shown in the plans,
2. At the Contractor's option, coping that is precast or CIP concrete for MSE panel walls unless CIP coping is required as shown in the plans,
3. CIP concrete coping for MSE segmental walls and
4. At the Contractor's option and when shown in the plans, CIP concrete coping that extends down back of panels or SRW units or connects to panels or SRW units with dowels.

For MSE segmental walls with dowels, attach dowels to top courses of SRW units in accordance with the following:

1. Set dowels in core spaces of SRW units filled with grout instead of coarse aggregate or
2. Embed adhesively anchored dowels in holes of solid SRW units with epoxy.

For MSE panel walls with coping, connect CIP concrete coping or leveling concrete for precast concrete coping to top row of panels with dowels cast into panels. When concrete barrier rail is required above MSE walls, use concrete barrier rail with moment slab as shown in the plans.

Submit working drawings and design calculations for acceptance in accordance with



Article 105-2 of the *Standard Specifications*. Submit working drawings showing plan views, wall profiles with foundation pressures, typical sections with reinforcement and connection details, aggregate locations and types, geotextile locations and details of leveling pads, panels or SRW units, coping, bin walls, slip joints, pile sleeves, etc. If necessary, include details on working drawings for concrete barrier rail with moment slab, reinforcement splices if allowed for the chosen MSE wall system, reinforcement connected to end bent caps, curved MSE walls with tight (short) radii and obstructions extending through walls or interfering with reinforcement, leveling pads, barriers or moment slabs. Submit design calculations for each wall section with different surcharge loads, geometry or material parameters. At least one analysis is required for each wall section with different reinforcement lengths. When designing MSE walls with computer software other than MSEW, use MSEW manufactured by ADAMA Engineering, Inc. to verify the design. At least one MSEW analysis is required per 100 ft of wall length with at least one analysis for the wall section with the longest reinforcement. Submit electronic MSEW input files and PDF output files with design calculations.

#### C. Preconstruction Meeting

Before starting MSE wall construction, hold a preconstruction meeting to discuss the construction and inspection of the MSE walls. If this meeting occurs before all MSE wall submittals have been accepted, additional preconstruction meetings may be required before beginning construction of MSE walls without accepted submittals. The Resident or Bridge Maintenance Engineer, Area Construction Engineer, Geotechnical Operations Engineer, Contractor and MSE Wall Installer Superintendent will attend preconstruction meetings.

#### 4.0 CORROSION MONITORING

Corrosion monitoring is required for MSE walls with steel reinforcement. The Engineer will determine the number of monitoring locations and where to install the instrumentation. Contact M&T before beginning wall construction. M&T will provide the corrosion monitoring instrumentation kits and if necessary, assistance with installation.

#### 5.0 SITE ASSISTANCE

Unless otherwise approved, an MSE Wall Vendor representative is required to assist and guide the MSE Wall Installer on-site for at least 8 hours when the first panels or SRW units and reinforcement layer are placed. If problems are encountered during construction, the Engineer may require the vendor representative to return to the site for a time period determined by the Engineer.

#### 6.0 CONSTRUCTION METHODS

Control drainage during construction in the vicinity of MSE walls. Direct run off away from MSE walls, aggregate and backfill. Contain and maintain aggregate and backfill and protect material from erosion.

Excavate as necessary for MSE walls in accordance with the accepted submittals. If applicable and at the Contractor's option, use temporary shoring for wall construction instead of temporary slopes to construct MSE walls. Define "temporary shoring for wall construction" as temporary shoring not shown in the plans or required by the Engineer including shoring for OSHA reasons or the Contractor's convenience.

Unless required otherwise in the plans, install foundations and if required, pile sleeves located in the reinforced zone before placing aggregate or reinforcement. Brace piles in the reinforced zone to maintain alignment when placing and compacting aggregate. Secure piles together with steel members near top of piles. Clamp members to piles instead of welding if bracing is at or below pile cut-off elevations.

Notify the Engineer when foundation excavation is complete. Do not place leveling pad concrete, aggregate or reinforcement until excavation dimensions and foundation material are approved.

Construct CIP concrete leveling pads at elevations and with dimensions shown in the accepted submittals and in accordance with Section 420 of the *Standard Specifications*. Cure leveling pads at least 24 hours before placing panels or SRW units.

Erect and support panels and stack SRW units so the final wall position is as shown in the accepted submittals. Stagger SRW units to create a running bond by centering SRW units over joints in the row below as shown in the accepted submittals. Space bearing pads in horizontal panel joints as shown in the accepted submittals and cover all panel joints with filtration geotextiles as shown in the accepted submittals. Attach filtration geotextiles to back of panels with adhesives, tapes or other approved methods.

Construct MSE walls with the following tolerances:

- A. SRW units are level from front to back and between units when checked with a 4 ft long level,
- B. Vertical joint widths are 1/4" maximum for SRW units and 3/4",  $\pm 1/4$ " for panels,
- C. Final wall face is within 3/4" of horizontal and vertical alignment shown in the accepted submittals when measured along a 10 ft straightedge and
- D. Final wall plumbness (batter) is not negative (wall face leaning forward) and within 0.5° of vertical unless otherwise approved.

Place reinforcement at locations and elevations shown in the accepted submittals and within 3" of corresponding connection elevations. Install reinforcement with the direction shown in the accepted submittals. Before placing aggregate, pull geosynthetic reinforcement taut so it is in tension and free of kinks, folds, wrinkles or creases. Reinforcement may be spliced once per reinforcement length if shown in the accepted submittals. Use reinforcement pieces at least 6 ft long. Contact the Engineer when unanticipated existing or future obstructions such as foundations, guardrail, fence or handrail posts, pavements, pipes, inlets or utilities will interfere with reinforcement. To avoid obstructions, deflect, skew or modify reinforcement as shown in the accepted submittals.

Place aggregate in the reinforced zone in 8" to 10" thick lifts. Compact fine aggregate in accordance with Subarticle 235-3(C) of the *Standard Specifications*. Use only hand operated compaction equipment to compact aggregate within 3 ft of panels or SRW units. At a distance greater than 3 ft, compact aggregate with at least 4 passes of an 8 ton to 10 ton vibratory roller in a direction parallel to the wall face. Smooth wheeled or rubber tired rollers are also acceptable for compacting aggregate. Do not use sheepsfoot, grid rollers or other types of compaction equipment with feet. Do not displace or damage reinforcement when placing and compacting aggregate. End dumping directly on geosynthetics is not permitted. Do not operate heavy equipment on reinforcement until it is covered with at least 8" of aggregate. Replace any damaged reinforcement to the satisfaction of the Engineer.

Backfill for MSE walls outside the reinforced zone in accordance with Article 410-8 of the *Standard Specifications*. If a drain is required, install wall drainage systems as shown in the accepted submittals and in accordance with Section 816 of the *Standard Specifications*. If pile sleeves are required, fill sleeves with loose uncompacted sand before constructing end bent caps.

Install dowels as necessary for SRW units and place and construct coping and leveling concrete as shown in the accepted submittals. Construct leveling concrete in accordance with Section 420 of the *Standard Specifications*. Construct CIP concrete coping in accordance with Subarticle 452-4(B) of the *Standard Specifications*. When single faced precast concrete barrier is required in front of and against MSE walls, stop coping just above barrier so coping does not interfere with placing barrier up against wall faces. If the gap between a single faced barrier and wall face is wider than 2", fill gap with Class V select material (standard size No. 78M stone). Otherwise, fill gap with backer rod and seal joint between barrier and MSE wall with silicone sealant.

When separation geotextiles are required, overlap adjacent geotextiles at least 18" and hold geotextiles in place with wire staples or anchor pins as needed. Seal joints above and behind MSE walls between coping and concrete slope protection with silicone sealant.

## 7.0 MEASUREMENT AND PAYMENT

*MSE Retaining Wall No. \_\_\_* will be measured and paid in square feet. MSE walls will be measured as the square feet of wall face area with the pay height equal to the difference between top of wall and top of leveling pad elevations. Define "top of wall" as top of coping or top of panels or SRW units for MSE walls without coping.

The contract unit price for *MSE Retaining Wall No. \_\_\_* will be full compensation for providing designs, submittals, labor, tools, equipment and MSE wall materials, excavating, hauling and removing excavated materials, placing and compacting aggregate and backfill material and supplying site assistance, leveling pads, panels, SRW units, reinforcement, aggregate, wall drainage systems, geotextiles, aggregate concrete base course, bearing pads, coping, miscellaneous components and any incidentals necessary to construct MSE walls. The contract unit price for *MSE Retaining Wall No. \_\_\_* will also be full compensation for reinforcement and connector design for reinforcement connected to end

bent caps, wall modifications for obstructions, pile sleeves filled with sand, joints sealed with silicone sealant and gaps between barriers and MSE walls filled with backer rod or No. 78M stone, if required.

No separate payment will be made for temporary shoring for wall construction. Temporary shoring for wall construction will be incidental to the contract unit price for *MSE Retaining Wall No. \_\_*.

The contract unit price for *MSE Retaining Wall No. \_\_* does not include the cost for ditches, fences, handrails, barrier or guardrail associated with MSE walls as these items will be paid for elsewhere in the contract. The contract unit price for *MSE Retaining Wall No. \_\_* also does not include the cost for constructing bridge approach fills behind end bents with MSE abutment walls. See *Bridge Approach Fills* provision for measurement and payment of Type III Reinforced Bridge Approach Fills.

Where it is necessary to provide backfill material behind the reinforced zone from sources other than excavated areas or borrow sources used in connection with other work in the contract, payment for furnishing and hauling such backfill material will be paid as extra work in accordance with Article 104-7 of the *Standard Specifications*. Placing and compacting such backfill material is not considered extra work but is incidental to the work being performed.

Payment will be made under:

**Pay Item**

MSE Retaining Wall No. \_\_

**Pay Unit**

Square Foot



DocuSigned by:  
*Scott A. Hidden*  
F760CAEB96FC4D3...  
04/25/2022

**CONTINUOUS FLIGHT AUGER PILES FOR SOUND BARRIER WALLS (SPECIAL)****1.0 GENERAL**

Continuous flight auger (CFA) piles are constructed by drilling a borehole with a continuous flight hollow stem auger and filling the borehole by pumping grout through the auger as it is withdrawn. After completing grout placement, reinforcement is inserted into the column of fluid grout. At the Contractor's option, construct CFA piles for sound barrier walls instead of pile excavation. Install CFA piles with the required depth in accordance with the contract and accepted submittals. Use a prequalified CFA Pile Subcontractor for CFA pile work. Define "pile" as a CFA pile and "reinforcement" as pile extending out of CFA pile.

**2.0 INSTALLATION PLAN SUBMITTAL**

Provide 4 copies and a PDF copy of the CFA pile installation plan submittal. Submit the installation plan at least 15 days before starting CFA pile construction. Do not begin pile construction until the CFA pile installation plan is accepted.

Provide detailed project specific information in the installation plan that includes the following:

1. List and sizes of proposed equipment including CFA drilling rigs, augers and other drilling tools and grouting equipment;
2. Step-by-step description of CFA pile installation and sequence of pile construction;
3. Methods for placing reinforcement with procedures for supporting and positioning the reinforcement;
4. Minimum grout volume factor;
5. Equipment and procedures for monitoring and recording grout volume;
6. Examples of construction records to be provided that meet Section 6.0 of this provision;
7. Procedures for containment and disposal of drilling spoils and waste grout;
8. Approved packaged grout or grout mix design that meets Section 1003 of the *Standard Specifications*; and
9. Other information shown in the plans or requested by the Engineer.

If alternate installation procedures are proposed or necessary, a revised CFA pile installation plan submittal may be required. If the work deviates from the accepted submittal without prior approval, the Engineer may suspend CFA pile construction until a revised plan is accepted.

**3.0 MATERIALS**

Use Type 2 grout that meets Section 1003 of the *Standard Specifications*.

Use piles extending out of CFA piles that meet the *Sound Barrier Wall* provision.

#### 4.0 PRECONSTRUCTION MEETING

Before starting CFA pile construction, hold a preconstruction meeting to discuss the installation and monitoring of the piles. Schedule this meeting after the CFA Pile Subcontractor mobilizes to the site. If this meeting occurs before all CFA pile submittals have been accepted, additional preconstruction meetings may be required before beginning construction of CFA piles without accepted submittals. The Resident or Bridge Maintenance Engineer, Bridge Construction Engineer, Geotechnical Operations Engineer, Contractor and CFA Pile Subcontractor Superintendent and Project Manager will attend preconstruction meetings.

#### 5.0 CONSTRUCTION METHODS

Use equipment and methods accepted in the CFA pile installation plan or approved by the Engineer. Inform the Engineer of any deviations from the accepted plan.

Dispose of drilling spoils and waste grout as directed and in accordance with Section 802 of the *Standard Specifications*. Drilling spoils consist of all excavated material and fluids removed from boreholes.

##### A. Drilling

Use CFA piling rigs capable of drilling to the dimensions and depths shown in the plans or required otherwise by the Engineer. Install CFA piles with tip elevations no higher than shown in the plans or approved by the Engineer.

Use single helix hollow stem augers with uniform diameters and continuous flights from the top of the auger to the bottom tip of the cutting face. Provide augers with flights and teeth that cut the bottom of the borehole flat. Augers with outside diameters at least 97% of the pile design diameter are required. Augers capable of installing piles to a depth 20% greater than plan depth are also required.

Unless piles are installed with a hydraulic fixed mast installation platform and the stem to which the auger is fixed has an outside diameter 10" or greater, at least one guide connected to the leads of the CFA piling rig is required. Prevent the leads from rotating during drilling and grouting.

Seal the grout injection port to prevent entry during drilling. Keep the hollow stem of augers clean when drilling. Clearly mark augers or leads every foot along their length with markings visible to the unaided eye from the ground. Check for correct pile location and alignment before beginning drilling. Do not begin drilling until enough grout to complete the pile is on the project site.

Advance the auger into the ground at a continuous rate. Do not raise the auger until beginning grout placement. Control the auger rotation speed to prevent excess spoil from being transported to the ground surface and surrounding soil being drawn laterally into the borehole.

If muck, organics, soft soil or other unsuitable materials are encountered within 5 ft of the ground surface, contact the Engineer as these materials can cause problems with top of pile construction. If auger refusal is encountered before reaching plan depth, stop the auger rotation and inform the Engineer. Unless it is determined otherwise, define refusal as less than 1 ft of auger penetration per minute.

#### B. Grouting

Remove oil, rust inhibitors, residual drilling slurries and similar foreign materials from holding tanks/hoppers, stirring devices, pumps and lines and all other equipment in contact with grout before use.

Place a screen between the ready mix truck and the grout pump to remove large particles or cement balls using a mesh that has openings no larger than  $\frac{3}{4}$ ".

Use a positive displacement piston type pump with a known volume per stroke that can develop peak pressures at the pump of at least 350 psi. Size the pump to maintain a smooth continuous delivery of grout while limiting pressure variations (particularly pressure drops) due to pump strokes. At the beginning of construction, provide the grout volume delivered by each pump stroke and verify this value is within 3% of the actual volume. Recalibrate the grout volume per pump stroke during construction as necessary or directed.

Measure grout temperature and flow during grouting with at least the same frequency grout cubes are made for compressive strength. Perform flow field tests in the presence of the Engineer in accordance with ASTM C939 (Flow Cone).

Place grout in accordance with the contract and accepted submittals. Pump grout without difficulty to fill any soft or porous zones and with sufficient pressure to ensure a continuous monolithic pile with at least the plan cross section from the maximum borehole depth to the top of the grout column. Provide grout free of segregation, intrusions, contamination, structural damage or inadequate consolidation (honeycombing).

Begin placing grout within 5 minutes after the auger has reached plan depth. At the beginning of grout placement, lift the auger 6" to 12" and remove the sealing device by applying grout pressure or with a steel bar. Do not lift the auger beyond this range in order to minimize soil movement. After initiating grout flow, reinsert the auger to the original depth.

Pump grout continuously while extracting the auger at a smooth steady rate. Maintain a positive grout pressure at the auger injection point at all times. If rotation occurs while removing the auger, rotate the auger in the same direction as during drilling. If grout placement is suspended for any reason, inform the Engineer and redrill the CFA pile.

Monitor the depth of the auger injection point while counting pump strokes during grouting. Record the grout volume and factor versus depth of the auger injection point in increments of 5 ft or less. The grout volume factor is the grout volume placed

divided by the theoretical grout volume for each depth increment. A grout volume factor of at least 1.15 is required.

C. Top of Pile Finishing and Protection

After placing grout, remove all excess grout and spoil from and place a temporary form within the top of the grout column. Use a form 3 ft to 5 ft long with a diameter equal to or larger than the pile diameter. Place the form with equal lengths above and below the ground surface. Recheck the top of the grout and remove any foreign material. After the Engineer determines that grout reaches initial set, remove the form without disturbing the ground surface around the pile.

After inserting reinforcement, square the top of the CFA pile with the pile axis while grout is still fluid or by cutting off hardened grout. Construct the top of CFA pile to the elevation shown in the plans.

D. Reinforcement

Provide reinforcement for CFA piles consisting of piles shown in the plans and accepted submittals. Insert reinforcement as a unit while the grout is still fluid. Lower or gently push reinforcement into the grout. Do not vibrate or drive the reinforcement. Support the reinforcement at the ground surface until the grout strength reaches 2,500 psi. Contact the Engineer if reinforcement cannot be properly inserted to the required depth.

## **6.0 CONSTRUCTION RECORDS**

Provide 2 copies of CFA pile construction records after completing each pile. Include the following in construction records:

1. Names of CFA Pile Subcontractor, Superintendent, Drill Rig Operator and Project Manager;
2. Project description, county, Department's contract, TIP and WBS element number;
3. Wall station and number and pile location and identifier;
4. The grout volume and factor versus depth of the auger injection point in increments of 5 ft or less;
5. CFA pile diameter, length and tip elevation, top of pile and ground surface elevations;
6. Auger diameter and theoretical volume of the borehole;
7. Grout temperature and flow records;
8. Size, length, top elevation and grade of reinforcement;
9. Date and time drilling begins and ends, grout is mixed and arrives on-site, pumping grout begins and ends and reinforcement is placed;
10. Weather conditions including air temperature at time of grout placement; and
11. All other pertinent details related to CFA pile construction.



After completing CFA piles for each sound barrier wall, provide a PDF copy of all corresponding construction records.

## 7.0 CFA PILE ACCEPTANCE

CFA pile acceptance is based in part on the following criteria.

1. Grout volume factor is greater than the minimum required for any 5 ft depth increment.
2. Grout is properly placed and does not have any evidence of segregation, intrusions, contamination, structural damage or inadequate consolidation (honeycombing).
3. CFA pile and reinforcement location, alignment and elevations are within tolerances for sound barrier walls for pile excavation and reinforcement is in accordance with the contract and accepted submittals.

If the Engineer determines a CFA pile is unacceptable, additional testing, remedial measures or replacement piles are required at no additional cost to the Department. Do not begin remediation work until remediation plans are approved.

## 8.0 MEASUREMENT AND PAYMENT

CFA piles for sound barrier walls will be paid at the contract unit price for *Sound Barrier Wall*. No separate payment will be made for CFA piles. The contract unit price for *Sound Barrier Wall* will be full compensation for all costs for submittals, monitoring and recording, labor, tools, equipment, reinforcement and grout complete and in place and all incidentals necessary to drill and construct CFA piles in accordance with this provision. No payment will be made for any costs associated with unacceptable CFA piles.



DocuSigned by:

A handwritten signature in black ink, appearing to read "Jinyoung Park".

A713DB5C81BA498...  
03/28/2022

# TC-1

U-6223

Johnston County

## WORK ZONE TRAFFIC CONTROL Project Special Provisions Table of Contents

Special Provision	Page
ADA Compliant Pedestrian Traffic Control Devices	TC-2

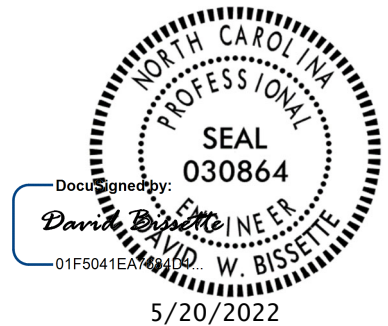

**TC-2**

U-6223

Johnston County

**ADA COMPLIANT PEDESTRIAN TRAFFIC CONTROL DEVICES:**

(10/31/2017)

**Description**

Furnish, install, and maintain ADA compliant pedestrian traffic control devices for existing pedestrian facilities that are closed by planned work activities.

The ADA compliant pedestrian traffic control devices used to close pedestrian facilities are Pedestrian Channelizing Devices.

**Construction Methods**

The ADA compliant pedestrian traffic control devices involved in the closing or redirecting of pedestrians as designated on the Transportation Management Plan (TMP) shall be manufactured and assembled in accordance with the requirements of the Americans with Disabilities Act (ADA) and be on the NCDOT approved products list.

Pedestrian Channelizing Devices shall be manufactured and assembled to be connected as to eliminate any gaps that allow pedestrians to stray from the channelizing path. Any Pedestrian Channelizing Devices used to close or block a pedestrian facility shall have a "SIDEWALK CLOSED" sign affixed to it and any audible warning devices, if designated on the TMP.

**Measurement and Payment**

*Pedestrian Channelizing Devices* will be measured and paid as the maximum number of linear feet of *Pedestrian Channelizing Devices* furnished, acceptably placed, and in use at any one time during the life of the project.

No direct payment will be made for any sign affixed to a pedestrian channelizing device. Signs mounted to pedestrian channelizing devices will be considered incidental to the device.

Relocation, replacement, repair, maintenance, or disposal of *Pedestrian Channelizing Devices* will be incidental to the pay item.

Payment will be made under:

**Pay Item****Pay Unit**

Pedestrian Channelizing Devices

Linear Foot

PROJECT SPECIAL PROVISIONS  
Utility Construction



120 N. Boylan Avenue  
Raleigh, NC 27603  
(919) 828-0531

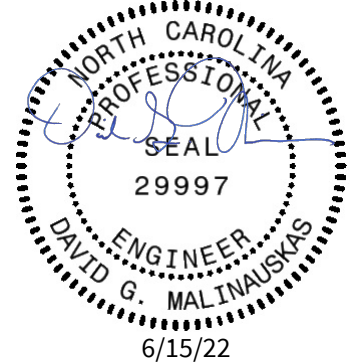

**Revise the 2018 Standard Specifications as follows:**

**Page 10-62, Sub-article 1036-3 Plastic Pipe, (A) PVC Pipe (2) Pressure Class Pipe, line 37:**  
Add the following to the end:

All pipe shall bear the National Sanitation Foundation Seal of Approval for potable water, the manufacturer’s name, and class of pipe. Stored PVC pipe shall not be exposed to sunlight for more than ninety (90) days. Any excess pipe stored on-site for more than ninety (90) days shall be covered with an opaque tarpaulin with means provided for heat dissipation and ventilation. Pipe discolored due to sunlight exposure shall not be installed. The Utility Owner’s representative shall determine the suitability of the exposed pipe.

**Page 10-63, Sub-article 1036-5 Ductile Iron Pipe and Fittings, lines 10 through 12:**  
Replace the paragraph with the following:

Ductile iron fittings shall conform to the requirements of ANSI Specification A21.10, with mechanical joint ends conforming to ANSI Specification A21.1, except that material and manufacturer shall conform to ASTM Specification A339, Grade 80-60-03. All fittings, except sleeves, shall be bituminous coated and cement lined as required for pipe. Minimum class shall be class 350 pipe. NO push-on joints will be allowed. Compact fittings are acceptable.

**Page 10-63, Sub-article 1036-7 Water Valves (A) Gate Valves, line 23:**  
Replace the first sentence with the following sentences:

Use iron body gate valves which conform to AWWA C509 for resilient seat-type valves. Extension stems shall be furnished where depth of bury places the operating nut in excess of four (4) feet below finished grade. Extension stems must have centering ring.

**Page 10-64, Sub-article 1036-8 Sleeves, Couplings, and Miscellaneous, after line 2:**

Add the following to the end:

**(C) Valve Boxes**

Valve boxes shall be of cast iron, three-piece screw type with covers and bases. They shall be of suitable size for the valve with which they are used and fully adjustable for depth of setting, extension pieces being furnished where necessary. Drop type covers shall be provided for each box with the word "WATER" designating the valve service cast into the top surface. Brick bases shall be provided and shall be so designed to fully support the valve box without the weight of the valve box and/or superimposed load being transmitted to any part of the valve or adjacent pipe on either side. A circular precast concrete collar shall be installed around all valve boxes.

**(D) Valve Markers**

Valve markers shall be of reinforced concrete. Concrete shall be of a mix design to produce a 3,000 psi compressive strength at 28 days. Valve Marker shall be marked with the recessed letters MV. Valve markers shall be installed no more than 18" above grade and such that all the letters on the marker can be read.

**Page 15-1, Sub-article 1500-2 Cooperation with the Utility Owner, line 19:**

Add the following sentences:

The utility owner for the water line facilities is Johnston County. The contact person is Mr. Michael Keen and he can be reached by phone at 919-989-5075. The utility owner for the sanitary sewer facilities is the Town of Clayton. The contact person is Mr. Joshua Baird, P.E. and can be reached at 919-359-1288.

**Page 15-2, Sub-article 1500-7 Submittals and Records, line 28:**

Replace the paragraph with the following:

Provide surveyed as-builts of the installed utility. The plans shall include notations of the size and type of material installed; GPS coordinates of all: fittings, utility controls, and the horizontal and vertical locations of the piping. Provide boring logs from trenchless installations. Provide 2 copies to the utility owner and 2 copies to the Engineer at the end of the project.

**Page 15-6, Sub-article 1510-2 Materials, after line 4:**

Add the following paragraphs:

Electronic location marker balls shall consist of 4" marker balls having a passive device capable of reflecting a specifically designated repulse frequency, unique to the utility being installed. The marker ball will contain a passive-tuned antenna, molded inside a plastic disk, which is free-floating inside a water resistant polyethylene shell. The shell shall be impervious to minerals, chemicals, and temperature extremes. Marker balls shall be color coded in accordance with the American Public Works Association's utility location and coordinating council standards.

Marker balls shall be installed directly over the center line of the point to be located, and a minimum of 6" from any metal objects. Burial of marker balls shall not be less than 18" nor more than 2 feet maximum. Marker balls shall be installed concurrently with water lines. Ball markers to be hand backfilled to 1 foot above ball marker as to prevent movement or damage. Electronic marker balls shall be installed at the following locations on ductile iron and PVC pipe:

1. At a minimum of every one hundred (100) linear feet directly over the pipe.
2. At bends 22.5 degrees and larger.
3. At capped or plugged ends if there is no blow-off assembly.
4. At tees.
5. At reducers.

**Page 15-6, Sub-article 1510-3 Construction Methods, (A) General, line 18:**

Replace the sentence with the following:

Install water lines 10-inches and larger in nominal diameter with a minimum of 42 inches of cover to finished grade unless otherwise directed or approved.

**Page 15-6, Sub-article 1510-3 Construction Methods, (A) General, after line 22:**

Add the following sentence:

Stone bedding installed to the spring line of the pipe is required in all wet or unsuitable soil areas.

**Page 15-6, Sub-article 1510-3 Construction Methods, (B) Testing and Sterilization, line 27:**

Add the following sentences:

A Johnston County representative shall be present for the pressure test, chlorination, sample collection, and flushing of all new water lines.

**Page 15-7, Sub-article 1510-3 Construction Methods, (B) Testing and Sterilization, line 13:**

Add the following sentence:

A 2" or greater temporary blow-off shall be installed for the purpose of discharging super-chlorinated water.

**Page 15-13, Sub-article 1520-3 Construction Methods, (B) Force Main Sanitary Sewer, line 3:**

Add the following sentences:

Air release valves shall be combination air valves incorporating the functions of an air and vacuum valve with those of a pressure air release valve in a single housing. Valves shall be 2" minimum with stainless steel or reinforced nylon bodies with a 2" threaded inlet. All internal metal parts shall be made of 316 stainless steel. Minimum orifice size shall be 0.012 square inch. Valves shall be pressure tested to a minimum of 200 psi. Valves shall be installed inside a minimum 5' diameter precast flattop manhole with one joint of C900 PVC pipe centered in the manhole. A concrete cradle shall be poured around the pipe to support the weight of the manhole. Ductile iron pipe may be used in the manhole if the interior of the manhole and the exposed ductile iron pipe is coated with at least 50 mils (surface dry) epoxy sealer prime and finish coating approved by Johnston County. Force main shall be installed at a sufficient depth through the high point so that the ARV manhole is flush with the finished grade.

## Utility Owner's Preferred Product List

### Electronic Marker Balls

1. 3M Telecom Systems
2. Or Approved Equal

### Ductile Iron Pipe Exterior Coating for Sanitary Sewer Pipe

1. NSP 100 Prime Coat; NSP 120 Finish Coat
2. Carboline
3. Or Approved Equal

### Ductile Iron Pipe Interior Coating for Sanitary Sewer Pipe

1. Sewper Coat (Lafarge Calcium Aluminate)
2. Protecto 401 (U.S. Pipe)
3. Or Approved Equal

### Air Release Valve for Force Main Sanitary Sewer

1. ARI model D-020
2. ARI model D-025
3. Crispin model UX20
4. Or Approved Equal

PROJECT SPECIAL PROVISIONS  
Utilities by Others

NCDOT Division 4 Utilities

**General:**

The following utility companies have facilities that will be in conflict with the construction of this project:

- A) Piedmont Natural Gas – Gas (Distribution)
- B) Lumen Technologies - Communications
- C) Spectrum - Communications
- D) Town of Clayton – Power (Distribution)
- E) Duke Energy Progress – Power (Distribution)

The conflicting facilities of these concerns will be adjusted prior to the date of availability, unless otherwise noted and are therefore listed in these special provisions for the benefit of the Contractor. All utility work listed herein will be done by the utility owners. All utilities are shown on the plans from the best available information.

The Contractor’s attention is directed to Article 105-8 of the 2018 Standard Specifications.

**Utilities Requiring Adjustment:**

Utility relocations are shown on the Utilities by Others Plans.

- A) Piedmont Natural Gas – Gas (Distribution)
  - 1) Contact person for Piedmont Natural Gas is Ms. Linda Scharf-Byers at 919-222-9906
- B) Lumen Technologies – Communications
  - 1) Contact person for Lumen Technologies is Mr. Ryan Mesimer at 252-751-5763
- C) Spectrum – Communications
  - 1) Contact person for Spectrum is Mr. Robert Dabrowski at 919-288-4867



PROJECT SPECIAL PROVISIONS  
Utilities by Others

D) Town of Clayton – Power (Distribution)

- 1) Contact person for Town of Clayton is Mr. Ethan Poppe at 919-320-6523

E) Duke Energy Progress – Power (Distribution)

- 1) Contact person for Duke Energy Progress is Mr. Mark Blackman at 919-717-472

**Project Special Provisions  
Erosion Control**

**STABILIZATION REQUIREMENTS:**

(4-30-2019)

Stabilization for this project shall comply with the time frame guidelines as specified by the NCG-010000 general construction permit effective April 1, 2019 issued by the North Carolina Department of Environmental Quality Division of Water Resources. Temporary or permanent ground cover stabilization shall occur within 7 calendar days from the last land-disturbing activity, with the following exceptions in which temporary or permanent ground cover shall be provided in 14 calendar days from the last land-disturbing activity:

- Slopes between 2:1 and 3:1, with a slope length of 10 ft. or less
- Slopes 3:1 or flatter, with a slope of length of 50 ft. or less
- Slopes 4:1 or flatter

The stabilization timeframe for High Quality Water (HQW) Zones shall be 7 calendar days with no exceptions for slope grades or lengths. High Quality Water Zones (HQW) Zones are defined by North Carolina Administrative Code 15A NCAC 04A.0105 (25). Temporary and permanent ground cover stabilization shall be achieved in accordance with the provisions in this contract and as directed.

**SEEDING AND MULCHING:**

**(East)**

The kinds of seed and fertilizer, and the rates of application of seed, fertilizer, and limestone, shall be as stated below. During periods of overlapping dates, the kind of seed to be used shall be determined. All rates are in pounds per acre.

All Roadway Areas

<b>March 1 - August 31</b>		<b>September 1 - February 28</b>	
50#	Tall Fescue	50#	Tall Fescue
10#	Centipede	10#	Centipede
25#	Bermudagrass (hulled)	35#	Bermudagrass (unhulled)
500#	Fertilizer	500#	Fertilizer
4000#	Limestone	4000#	Limestone

Waste and Borrow Locations

<b>March 1 - August 31</b>		<b>September 1 - February 28</b>	
75#	Tall Fescue	75#	Tall Fescue
25#	Bermudagrass (hulled)	35#	Bermudagrass (unhulled)
500#	Fertilizer	500#	Fertilizer
4000#	Limestone	4000#	Limestone

Note: 50# of Bahiagrass may be substituted for either Centipede or Bermudagrass only upon Engineer's request.

### Approved Tall Fescue Cultivars

06 Dust	Escalade	Justice	Serengeti
2 <sup>nd</sup> Millennium	Essential	Kalahari	Shelby
3 <sup>rd</sup> Millennium	Evergreen 2	Kitty Hawk 2000	Sheridan
Apache III	Falcon IV	Legitimate	Signia
Avenger	Falcon NG	Lexington	Silver Hawk
Barlexas	Falcon V	LSD	Sliverstar
Barlexas II	Faith	Magellan	Shenandoah Elite
Bar Fa	Fat Cat	Matador	Sidewinder
Barrera	Festnova	Millennium SRP	Skyline
Barrington	Fidelity	Monet	Solara
Barrobusto	Finelawn Elite	Mustang 4	Southern Choice II
Barvado	Finelawn Xpress	Ninja 2	Speedway
Biltmore	Finesse II	Ol' Glory	Spyder LS
Bingo	Firebird	Olympic Gold	Sunset Gold
Bizem	Firecracker LS	Padre	Taccoa
Blackwatch	Firenza	Patagonia	Tanzania
Blade Runner II	Five Point	Pedigree	Trio
Bonsai	Focus	Picasso	Tahoe II
Braveheart	Forte	Piedmont	Talladega
Bravo	Garrison	Plantation	Tarheel
Bullseye	Gazelle II	Proseeds 5301	Terrano
Cannavaro	Gold Medallion	Prospect	Titan ltd
Catalyst	Grande 3	Pure Gold	Titanium LS
Cayenne	Greenbrooks	Quest	Tracer
Cessane Rz	Greenkeeper	Raptor II	Traverse SRP
Chipper	Gremlin	Rebel Exeda	Tulsa Time
Cochise IV	Greystone	Rebel Sentry	Turbo
Constitution	Guardian 21	Rebel IV	Turbo RZ
Corgi	Guardian 41	Regiment II	Tuxedo RZ
Corona	Hemi	Regenerate	Ultimate
Coyote	Honky Tonk	Rendition	Venture
Darlington	Hot Rod	Rhambler 2 SRP	Umbrella
Davinci	Hunter	Rembrandt	Van Gogh
Desire	Inferno	Reunion	Watchdog
Dominion	Innovator	Riverside	Wolfpack II
Dynamic	Integrity	RNP	Xtremegreen
Dynasty	Jaguar 3	Rocket	
Endeavor	Jamboree	Scorpion	

On cut and fill slopes 2:1 or steeper Centipede shall be applied at the rate of 5 pounds per acre and add 20# of Sericea Lespedeza from January 1 - December 31.

Fertilizer shall be 10-20-20 analysis. A different analysis of fertilizer may be used provided the 1-2-2 ratio is maintained and the rate of application adjusted to provide the same amount of plant food as a 10-20-20 analysis and as directed.

**Native Grass Seeding and Mulching (East)**

Native Grass Seeding and Mulching shall be performed on the disturbed areas of wetlands and riparian areas, and adjacent to Stream Relocation construction within a 50 foot zone on both sides of the stream or depression, measured from top of stream bank or center of depression. The stream bank of the stream relocation shall be seeded by a method that does not alter the typical cross section of the stream bank. Native Grass Seeding and Mulching shall also be performed in the permanent soil reinforcement mat section of preformed scour holes, and in other areas as directed.

The kinds of seed and fertilizer, and the rates of application of seed, fertilizer, and limestone, shall be as stated below. During periods of overlapping dates, the kind of seed to be used shall be determined. All rates are in pounds per acre.

<b>March 1 - August 31</b>		<b>September 1 - February 28</b>	
18#	Creeping Red Fescue	18#	Creeping Red Fescue
6#	Indiangrass	6#	Indiangrass
8#	Little Bluestem	8#	Little Bluestem
4#	Switchgrass	4#	Switchgrass
25#	Browntop Millet	35#	Rye Grain
500#	Fertilizer	500#	Fertilizer
4000#	Limestone	4000#	Limestone

Approved Creeping Red Fescue Cultivars:

Aberdeen                      Boreal                      Epic                      Cindy Lou

Fertilizer shall be 10-20-20 analysis. A different analysis of fertilizer may be used provided the 1-2-2 ratio is maintained and the rate of application adjusted to provide the same amount of plant food as a 10-20-20 analysis and as directed.

Native Grass Seeding and Mulching shall be performed in accordance with Section 1660 of the *Standard Specifications* and vegetative cover sufficient to restrain erosion shall be installed immediately following grade establishment.

**Measurement and Payment**

Native Grass *Seeding and Mulching* will be measured and paid for in accordance with Article 1660-8 of the *Standard Specifications*.

All areas seeded and mulched shall be tacked with asphalt. Crimping of straw in lieu of asphalt tack shall not be allowed on this project.

**CRIMPING STRAW MULCH:**

Crimping shall be required on this project adjacent to any section of roadway where traffic is to be maintained or allowed during construction. In areas within six feet of the edge of pavement, straw is to be applied and then crimped. After the crimping operation is complete, an additional application of straw shall be applied and immediately tacked with a sufficient amount of undiluted emulsified asphalt.

Straw mulch shall be of sufficient length and quality to withstand the crimping operation.

Crimping equipment including power source shall be subject to the approval of the Engineer providing that maximum spacing of crimper blades shall not exceed 8".

**TEMPORARY SEEDING:**

Fertilizer shall be the same analysis as specified for *Seeding and Mulching* and applied at the rate of 400 pounds and seeded at the rate of 50 pounds per acre. Sweet Sudan Grass, German Millet or Browntop Millet shall be used in summer months and Rye Grain during the remainder of the year. The Engineer will determine the exact dates for using each kind of seed.

**FERTILIZER TOPDRESSING:**

Fertilizer used for topdressing on all roadway areas except slopes 2:1 and steeper shall be 10-20-20 grade and shall be applied at the rate of 500 pounds per acre. A different analysis of fertilizer may be used provided the 1-2-2 ratio is maintained and the rate of application adjusted to provide the same amount of plant food as 10-20-20 analysis and as directed.

Fertilizer used for topdressing on slopes 2:1 and steeper and waste and borrow areas shall be 16-8-8 grade and shall be applied at the rate of 500 pounds per acre. A different analysis of fertilizer may be used provided the 2-1-1 ratio is maintained and the rate of application adjusted to provide the same amount of plant food as 16-8-8 analysis and as directed.

**SUPPLEMENTAL SEEDING:**

The kinds of seed and proportions shall be the same as specified for *Seeding and Mulching*, with the exception that no centipede seed will be used in the seed mix for supplemental seeding. The rate of application for supplemental seeding may vary from 25# to 75# per acre. The actual rate per acre will be determined prior to the time of topdressing and the Contractor will be notified in writing of the rate per acre, total quantity needed, and areas on which to apply the supplemental seed. Minimum tillage equipment, consisting of a sod seeder shall be used for incorporating seed into the soil as to prevent disturbance of existing vegetation. A clodbuster (ball and chain) may be used where degree of slope prevents the use of a sod seeder.

**MOWING:**

The minimum mowing height on this project shall be 4 inches.

**REFORESTATION:****Description**

*Reforestation* will be planted in areas as directed. *Reforestation* is not shown on the plan sheets. See the Reforestation Detail Sheet.

All non-maintained riparian buffers impacted by the placement of temporary fill or clearing activities shall be restored to the preconstruction contours and revegetated with native woody species.

The entire *Reforestation* operation shall comply with the requirements of Section 1670 of the *Standard Specifications*.

**Materials**

*Reforestation* shall be bare root seedlings 12"-18" tall.

**Construction Methods**

*Reforestation* shall be planted as soon as practical following permanent *Seeding and Mulching*. The seedlings shall be planted in a 16-foot wide swath adjacent to mowing pattern line, or as directed.

Root dip: The roots of reforestation seedlings shall be coated with a slurry of water, and either a fine clay (kaolin) or a superabsorbent that is designated as a bare root dip. The type, mixture ratio, method of application, and the time of application shall be submitted to the Engineer for approval.

With the approval of the Engineer, seedlings may be coated before delivery to the job or at the time of planting, but at no time shall the roots of the seedlings be allowed to dry out. The roots shall be moistened immediately prior to planting.

Seasonal Limitations: *Reforestation* shall be planted from November 15 through March 15.

**Measurement and Payment**

*Reforestation* will be measured and paid for in accordance with Article 1670-17 of the *Standard Specifications*.

**RESPONSE FOR EROSION CONTROL:****Description**

Furnish the labor, materials, tools and equipment necessary to move personnel, equipment, and supplies to the project necessary for the pursuit of any or all of the following work as shown herein, by an approved subcontractor.

<b>Section</b>	<b>Erosion Control Item</b>	<b>Unit</b>
1605	Temporary Silt Fence	LF
1606	Special Sediment Control Fence	LF/TON
1615	Temporary Mulching	ACR
1620	Seed - Temporary Seeding	LB
1620	Fertilizer - Temporary Seeding	TN
1631	Matting for Erosion Control	SY
SP	Coir Fiber Mat	SY
1640	Coir Fiber Baffles	LF
SP	Permanent Soil Reinforcement Mat	SY
1660	Seeding and Mulching	ACR
1661	Seed - Repair Seeding	LB
1661	Fertilizer - Repair Seeding	TON
1662	Seed - Supplemental Seeding	LB
1665	Fertilizer Topdressing	TON
SP	Safety/Highly Visible Fencing	LF
SP	Response for Erosion Control	EA

**Construction Methods**

Provide an approved subcontractor who performs an erosion control action as described in the NPDES Inspection Form SPPP30. Each erosion control action may include one or more of the above work items.

**Measurement and Payment**

*Response for Erosion Control* will be measured and paid for by counting the actual number of times the subcontractor moves onto the project, including borrow and waste sites, and satisfactorily completes an erosion control action described in Form 1675. The provisions of Article 104-5 of the *Standard Specifications* will not apply to this item of work.

Payment will be made under:

<b>Pay Item</b>	<b>Pay Unit</b>
Response for Erosion Control	Each

**ENVIRONMENTALLY SENSITIVE AREAS:**

**Description**

This project is located in an *Environmentally Sensitive Area*. This designation requires special procedures to be used for clearing and grubbing, temporary stream crossings, and grading operations within the Environmentally Sensitive Areas identified on the plans and as designated by the Engineer. This also requires special procedures to be used for seeding and mulching and staged seeding within the project.

The Environmentally Sensitive Area shall be defined as a 50-foot buffer zone on both sides of the stream or depression measured from top of streambank or center of depression.

**Construction Methods**

(A) Clearing and Grubbing

In areas identified as Environmentally Sensitive Areas, the Contractor may perform clearing operations, but not grubbing operations until immediately prior to beginning grading operations as described in Article 200-1 of the *Standard Specifications*. Only clearing operations (not grubbing) shall be allowed in this buffer zone until immediately prior to beginning grading operations. Erosion control devices shall be installed immediately following the clearing operation.

(B) Grading

Once grading operations begin in identified Environmentally Sensitive Areas, work shall progress in a continuous manner until complete. All construction within these areas shall progress in a continuous manner such that each phase is complete and areas are permanently stabilized prior to beginning of next phase. Failure on the part of the Contractor to complete any phase of construction in a continuous manner in Environmentally Sensitive Areas will be just cause for the Engineer to direct the suspension of work in accordance with Article 108-7 of the *Standard Specifications*.

(C) Temporary Stream Crossings

Any crossing of streams within the limits of this project shall be accomplished in accordance with the requirements of Subarticle 107-12 of the *Standard Specifications*.



(D) Seeding and Mulching

Seeding and mulching shall be performed in accordance with Section 1660 of the *Standard Specifications* and vegetative cover sufficient to restrain erosion shall be installed immediately following grade establishment.

Seeding and mulching shall be performed on the areas disturbed by construction immediately following final grade establishment. No appreciable time shall lapse into the contract time without stabilization of slopes, ditches and other areas within the Environmentally Sensitive Areas.

(E) Stage Seeding

The work covered by this section shall consist of the establishment of a vegetative cover on cut and fill slopes as grading progresses. Seeding and mulching shall be done in stages on cut and fill slopes that are greater than 20 feet in height measured along the slope, or greater than 2 acres in area. Each stage shall not exceed the limits stated above.

Additional payments will not be made for the requirements of this section, as the cost for this work shall be included in the contract unit prices for the work involved.

**MINIMIZE REMOVAL OF VEGETATION:**

The Contractor shall minimize removal of vegetation within project limits to the maximum extent practicable. Vegetation along stream banks and adjacent to other jurisdictional resources outside the construction limits shall only be removed upon approval of Engineer. No additional payment will be made for this minimization work.

**STOCKPILE AREAS:**

The Contractor shall install and maintain erosion control devices sufficient to contain sediment around any erodible material stockpile areas as directed.

**ACCESS AND HAUL ROADS:**

At the end of each working day, the Contractor shall install or re-establish temporary diversions or earth berms across access/haul roads to direct runoff into sediment devices. Silt fence sections that are temporarily removed shall be reinstalled across access/haul roads at the end of each working day.

**CONSTRUCTION MATERIALS MANAGEMENT**

(3-19-19) (rev. 04-27-19)

**Description**

The requirements set forth shall be adhered to in order to meet the applicable materials handling requirements of the NCG010000 permit. Structural controls installed to manage construction materials stored or used on site shall be shown on the E&SC Plan. Requirements for handling materials on construction sites shall be as follows:

**Polyacrylamides (PAMS) and Flocculants**

Polyacrylamides (PAMS) and flocculants shall be stored in leak-proof containers that are kept under storm-resistant cover or surrounded by secondary containment structures designed to protect adjacent surface waters. PAMS or other flocculants used shall be selected from the NC DWR List of Approved PAMS/Flocculants. The concentration of PAMS and other flocculants used shall not exceed those specified in the NC DWR List of Approved PAMS/Flocculants and in accordance with the manufacturer's instructions. The NC DWR List of Approved PAMS/Flocculants is available at:

[https://files.nc.gov/ncdeq/Water%20Quality/Environmental%20Sciences/ATU/ApprovedPAMS\\_4\\_1\\_2017.pdf](https://files.nc.gov/ncdeq/Water%20Quality/Environmental%20Sciences/ATU/ApprovedPAMS_4_1_2017.pdf)

**Equipment Fluids**

Fuels, lubricants, coolants, and hydraulic fluids, and other petroleum products shall be handled and disposed of in a manner so as not to enter surface or ground waters and in accordance with applicable state and federal regulations. Equipment used on the site must be operated and maintained properly to prevent discharge of fluids. Equipment, vehicle, and other wash waters shall not be discharged into E&SC basins or other E&SC devices. Alternative controls should be provided such that there is no discharge of soaps, solvents, or detergents.

**Waste Materials**

Construction materials and land clearing waste shall be disposed of in accordance with North Carolina General Statutes, Chapter 130A, Article 9 - Solid Waste Management, and rules governing the disposal of solid waste (15A NCAC 13B). Areas dedicated for managing construction material and land clearing waste shall be at least 50 feet away from storm drain inlets and surface waters unless it can be shown that no other alternatives are reasonably available. Paint and other liquid construction material waste shall not be dumped into storm drains. Paint and other liquid construction waste washouts should be located at least 50 feet away from storm drain inlets unless there is no alternative. Other options are to install lined washouts or use portable, removable bags or bins. Hazardous or toxic waste shall be managed in accordance with the federal Resource Conservation and Recovery Act (RCRA) and NC Hazardous Waste Rules at 15A NCAC, Subchapter 13A. Litter and sanitary waste shall be managed in a manner to prevent it from entering jurisdictional waters and shall be disposed of offsite.

**Herbicide, Pesticide, and Rodenticides**

Herbicide, pesticide, and rodenticides shall be stored and applied in accordance with the Federal Insecticide, Fungicide, and Rodenticide Act, North Carolina Pesticide Law of 1971 and labeling restrictions.

**Concrete Materials**

Concrete materials onsite, including excess concrete, must be controlled and managed to avoid contact with surface waters, wetlands or buffers. No concrete or cement slurry shall be discharged from the site. (Note that discharges from onsite concrete plants require coverage under a separate NPDES permit – NCG140000.) Concrete wash water shall be managed in accordance with the *Concrete Washout Structure* provision. Concrete slurry shall be managed and disposed of in accordance with *NCDOT DGS and HOS DCAR Distribution of Class A Residuals Statewide* (Permit No. WQ0035749). Any hardened concrete residue will be disposed of, or recycled on site, in accordance with state solid waste regulations.

**Earthen Material Stock Piles**

Earthen material stock piles shall be located at least 50 feet away from storm drain inlets and surface waters unless it can be shown that no other alternatives are reasonably available.

**Measurement and Payment**

Conditions set within the *Construction Materials Management* provision are incidental to the project for which no direct compensation will be made.

**WASTE AND BORROW SOURCES:**

(2-16-11) (Rev. 3-17-22)

Payment for temporary erosion control measures, except those made necessary by the Contractor's own negligence or for his own convenience, will be paid for at the appropriate contract unit price for the devices or measures utilized in borrow sources and waste areas.

No additional payment will be made for erosion control devices or permanent seeding and mulching in any commercial borrow or waste pit. All erosion and sediment control practices that may be required on a commercial borrow or waste site will be done at the Contractor's expense.

All offsite Staging Areas, Borrow and Waste sites shall be in accordance with "Borrow and Waste Site Reclamation Procedures for Contracted Projects" located at:

<https://connect.ncdot.gov/resources/roadside/FieldOperationsDocuments/Contract%20Reclamation%20Procedures.pdf>

All forms and documents referenced in the “Borrow and Waste Site Reclamation Procedures for Contracted Projects” shall be included with the reclamation plans for offsite staging areas, and borrow and waste sites.

**TEMPORARY DIVERSION:**

This work consists of installation, maintenance, and cleanout of *Temporary Diversions* in accordance with Section 1630 of the *Standard Specifications*. The quantity of excavation for installation and cleanout will be measured and paid for as *Silt Excavation* in accordance with Article 1630-3 of the *Standard Specifications*.

**SAFETY FENCE AND JURISDICTIONAL FLAGGING:**

**Description**

*Safety Fence* shall consist of furnishing materials, installing and maintaining polyethylene or polypropylene fence along the outside riparian buffer, wetland, or water boundary, or other boundaries located within the construction corridor to mark the areas that have been approved to infringe within the buffer, wetland, endangered vegetation, culturally sensitive areas or water. The fence shall be installed prior to any land disturbing activities.

Interior boundaries for jurisdictional areas noted above shall be delineated by stakes and highly visible flagging.

Jurisdictional boundaries at staging areas, waste sites, or borrow pits, whether considered outside or interior boundaries shall be delineated by stakes and highly visible flagging.

**Materials**

(A) Safety Fencing

Polyethylene or polypropylene fence shall be a highly visible preconstructed safety fence approved by the Engineer. The fence material shall have an ultraviolet coating.

Either wood posts or steel posts may be used. Wood posts shall be hardwood with a wedge or pencil tip at one end, and shall be at least 5 ft. in length with a minimum nominal 2" x 2" cross section. Steel posts shall be at least 5 ft. in length, and have a minimum weight of 0.85 lb/ft of length.

(B) Boundary Flagging

Wooden stakes shall be 4 feet in length with a minimum nominal 3/4" x 1-3/4" cross section. The flagging shall be at least 1" in width. The flagging material shall be vinyl and shall be orange in color and highly visible.

## Construction Methods

No additional clearing and grubbing is anticipated for the installation of this fence. The fence shall be erected to conform to the general contour of the ground.

### (A) Safety Fencing

Posts shall be set at a maximum spacing of 10 ft., maintained in a vertical position and hand set or set with a post driver. Posts shall be installed a minimum of 2 ft. into the ground. If hand set, all backfill material shall be thoroughly tamped. Wood posts may be sharpened to a dull point if power driven. Posts damaged by power driving shall be removed and replaced prior to final acceptance. The tops of all wood posts shall be cut at a 30-degree angle. The wood posts may, at the option of the Contractor, be cut at this angle either before or after the posts are erected.

The fence geotextile shall be attached to the wood posts with one 2" galvanized wire staple across each cable or to the steel posts with wire or other acceptable means.

Place construction stakes to establish the location of the safety fence in accordance with Article 105-9 or Article 801-1 of the *Standard Specifications*. No direct pay will be made for the staking of the safety fence. All stakeouts for safety fence shall be considered incidental to the work being paid for as "Construction Surveying", except that where there is no pay item for construction surveying, all safety fence stakeout will be performed by state forces.

The Contractor shall be required to maintain the safety fence in a satisfactory condition for the duration of the project as determined by the Engineer.

### (B) Boundary Flagging

Boundary flagging delineation of interior boundaries shall consist of wooden stakes on 25 feet maximum intervals with highly visible orange flagging attached. Stakes shall be installed a minimum of 6" into the ground. Interior boundaries may be staked on a tangent that runs parallel to buffer but must not encroach on the buffer at any location. Interior boundaries of hand clearing shall be identified with a different colored flagging to distinguish it from mechanized clearing.

Boundary flagging delineation of interior boundaries will be placed in accordance with Article 105-9 or Article 801-1 of the *Standard Specifications*. No direct pay will be made for delineation of the interior boundaries. This delineation will be considered incidental to the work being paid for as *Construction Surveying*, except that where there is no pay item or construction surveying the cost of boundary flagging delineation shall be included in the unit prices bid for the various items in the contract. Installation for delineation of all jurisdictional boundaries at staging areas, waste sites, or borrow pits shall consist of wooden stakes on 25 feet maximum intervals with highly visible orange flagging attached. Stakes shall be installed a minimum of 6" into the ground. Additional flagging may be placed on overhanging vegetation to enhance visibility but does not substitute for installation of stakes.

Installation of boundary flagging for delineation of all jurisdictional boundaries at staging areas, waste sites, or borrow pits shall be performed in accordance with Subarticle 230-4(B)(5) or Subarticle 802-2(F) of the *Standard Specifications*. No direct pay will be made for this delineation, as the cost of same shall be included in the unit prices bid for the various items in the contract.

The Contractor shall be required to maintain alternative stakes and highly visible flagging in a satisfactory condition for the duration of the project as determined by the Engineer.

### Measurement and Payment

*Safety Fence* will be measured and paid as the actual number of linear feet of polyethylene or polypropylene fence installed in place and accepted. Such payment will be full compensation including but not limited to furnishing and installing fence geotextile with necessary posts and post bracing, staples, tie wires, tools, equipment and incidentals necessary to complete this work.

Payment will be made under:

<b>Pay Item</b>	<b>Pay Unit</b>
Safety Fence	Linear Foot

### **SKIMMER BASIN WITH BAFFLES:** (East)

#### Description

Provide a skimmer basin to remove sediment from construction site runoff at locations shown in the erosion control plans. See the Skimmer Basin with Baffles Detail sheet provided in the erosion control plans. Work includes constructing sediment basin, installation of temporary slope drain pipe and coir fiber baffles, furnishing, installation and cleanout of skimmer, providing and placing stone pad on bottom of basin underneath skimmer device, providing and placing a geotextile spillway liner, providing coir fiber mat stabilization for the skimmer outlet, disposing of excess materials, removing temporary slope drain, coir fiber baffles, geotextile liner and skimmer device, backfilling basin area with suitable material and providing proper drainage when basin area is abandoned.

#### Materials

<b>Item</b>	<b>Section</b>
Stone for Erosion Control, Class B	1042
Geotextile for Soil Stabilization, Type 4	1056
Fertilizer for Temporary Seeding	1060-2
Seed for Temporary Seeding	1060-4
Seeding and Mulching	1060-4
Matting for Erosion Control	1060-8
Staples	1060-8
Coir Fiber Mat	1060-14
Temporary Slope Drain	1622-2

Coir Fiber Baffle

1640

Provide appropriately sized and approved skimmer device.

Provide Schedule 40 PVC pipe with a length of 6 ft. to attach to the skimmer and the coupling connection to serve as the arm pipe. For skimmer sizes of 2.5 in. and smaller, the arm pipe diameter shall be 1.5 inches. For skimmer sizes of 3 in. and larger, refer to manufacturer recommendation.

Provide 4" diameter Schedule 40 PVC pipe to attach to coupling connection of skimmer to serve as the barrel pipe through the earthen dam.

The geotextile for the spillway liner shall meet the following minimum physical properties for low permeability, woven polypropylene geotextiles:

Property	Test Method	Value	Unit
Tensile Strength	ASTM D-4632	315	lb.
Tensile Elongation (Maximum)	ASTM D-4632	15	%
Trapezoidal Tear	ASTM D-4533	120	lbs.
CBR Puncture	ASTM D-6241	900	lbs.
UV Resistance (% retained at 500 hrs.)	ASTM D-4355	70	%
Apparent Opening Size (AOS)	ASTM D-4751	40	US Std. Sieve
Permittivity	ASTM D-4491	0.05	sec <sup>-1</sup>
Water Flow Rate	ASTM D-4491	4	gal/min/ft <sup>2</sup>

Anchors: Staples, stakes, or reinforcement bars shall be used as anchors.

Wooden Stakes:

Provide hardwood stakes 12"- 24" long with a 2" x 2" nominal square cross section. One end of the stake must be sharpened or beveled to facilitate driving through the coir fiber mat and down into the underlying soil. The other end of the stake needs to have a 1"- 2" long head at the top with a 1"- 2" notch following to catch and secure the coir fiber mat.

Steel Reinforcement Bars:

Provide uncoated #10 steel reinforcement bars 24" nominal length. The bars shall have a 4" diameter bend at one end with a 4" straight section at the tip to catch and secure the coir fiber mat.

Staples:

Provide staples made of 0.125" diameter new steel wire formed into a *u* shape not less than 12" in length with a throat of 1" in width.

## Construction Methods

Excavate basin according to the erosion control plans with basin surface free of obstructions, debris, and pockets of low-density material. Install temporary slope drain pipe and construct the primary spillway according to the Skimmer Basin with Baffles Detail sheet in the erosion control plans. Temporary slope drain pipe at inlet of basin may be replaced by Type 4 geotextile as directed. Construct the coir fiber baffles according to *Roadway Standard Drawings* No. 1640.01 and Section 1640 of the *Standard Specifications*.

Install skimmer device according to manufacturer recommendations. Install 4" Schedule 40 PVC pipe into dam on the lower side of basin 1 ft. from the bottom of the basin and according to the detail, and extend the pipe so the basin will drain. Attach a 6 ft. arm pipe to the coupling connection and skimmer according to manufacturer recommendations. The coupling shall be rigid and non-buoyant and not exceed a diameter of 4" and 12" in length. Attach the rope included with the skimmer to the tee between the vent socket and the tube inlet, and the other end to a wooden stake or metal post. Clean out skimmer device when it becomes clogged with sediment and/or debris and is unable to float at the top of water in skimmer basin. Take appropriate measures to avoid ice accumulation in the skimmer device. Construct a stone pad of Class B stone directly underneath the skimmer device at bottom of basin. The pad shall be a minimum of 12" in height, and shall have a minimum cross sectional area of 4 ft. by 4 ft.

Line primary spillway with low permeability polypropylene geotextile unrolled in the direction of flow and lay smoothly but loosely on soil surface without creases. Bury edges of geotextile in a trench at least 5" deep and tamp firmly. If geotextile for the primary spillway is not one continuous piece of material, make horizontal overlaps a minimum of 18" with upstream geotextile overlapping the downstream geotextile. Secure geotextile with eleven gauge wire staples shaped into a *u* shape with a length of not less than 12" and a throat not less than 1" in width. Place staples along outer edges and throughout the geotextile a maximum of 3 ft. horizontally and vertically. Geotextile shall be placed to the bottom and across the entire width of the basin according to the Skimmer Basin with Baffles detail. Place sealant inside basin around barrel pipe on top of geotextile with a minimum width of 6 in.

At the skimmer outlet, provide a smooth soil surface free from stones, clods, or debris that will prevent contact of the coir fiber matting with the soil. Unroll the matting and apply without stretching such that it will lie smoothly but loosely on the soil surface. Wooden stakes, reinforcement bars, or staples may be used as anchors in accordance with the details in the plans and as directed. Place anchors across the matting at the ends approximately 1 ft. apart. Place anchors along the outer edges and down the center of the matting 3 ft. apart.

All bare side slope sections of the skimmer basin shall be seeded with a temporary or permanent seed mix as directed and in accordance with Articles 1620-3, 1620-4, 1620-5, 1660-4, 1660-5 and 1660-7 of the *Standard Specifications*. Straw or excelsior matting shall be installed on all bare side slope sections immediately upon the completion of seeding and in accordance with Article 1631-3 of the *Standard Specifications*.



**Measurement and Payment**

*Silt Excavation* will be measured and paid for in accordance with Article 1630-4 of the *Standard Specifications*, as calculated from the typical section throughout the length of the basin as shown on the final approved plans.

*Geotextile for Soil Stabilization* will be measured and paid for in accordance with Article 270-4 of the *Standard Specifications*.

*Low Permeability Geotextile* will be measured and paid for as the actual number of square yards measured along the surface of the spillway over which the geotextile is installed and accepted.

*Coir Fiber Baffles* will be measured and paid for in accordance with Article 1640-4 of the *Standard Specifications*.

\_\_" *Skimmer* will be measured in units of each. \_\_" *Skimmer* will be measured and paid for as the maximum number of each size skimmer acceptably installed and in use at any one time during the life of the project. Barrel and arm pipe, cleanout, relocation and reinstallation of \_\_" *Skimmer* is considered incidental to the measurement of the quantity of \_\_" *Skimmer* and no separate payment will be made. No separate payment shall be made if \_\_" *Skimmer*, barrel and/or arm pipe(s) are damaged by ice accumulation.

*Coir Fiber Mat* will be measured and paid for as the actual number of square yards measured along the surface of the ground over which coir fiber mat is installed and accepted.

*Temporary Slope Drain* will be measured and paid for in accordance with Article 1622-4 of the *Standard Specifications*.

*Stone for Erosion Control, Class \_\_* will be measured and paid for in accordance with Article 1610-4 of the *Standard Specifications*.

*Seeding and Mulching* will be measured and paid for in accordance with Article 1660-8 of the *Standard Specifications*.

*Seed for Temporary Seeding* will be measured and paid for in accordance with Article 1620-6 of the *Standard Specifications*.

*Fertilizer for Temporary Seeding* will be measured and paid for in accordance with Article 1620-6 of the *Standard Specifications*.

*Matting for Erosion Control* will be measured and paid for in accordance with Article 1631-4 of the *Standard Specifications*.

No measurement will be made for other items or for over excavation or stockpiling.

Payment will be made under:

<b>Pay Item</b>	<b>Pay Unit</b>
___" Skimmer	Each
Coir Fiber Mat	Square Yard
Low Permeability Geotextile	Square Yard

**WATTLES WITH POLYACRYLAMIDE (PAM):**

**Description**

Wattles are tubular products consisting of excelsior fibers encased in synthetic netting. Wattles are used on slopes or channels to intercept runoff and act as a velocity break. Wattles are to be placed at locations shown on the plans or as directed. Installation shall follow the detail provided in the plans and as directed. Work includes furnishing materials, installation of wattles, matting installation, PAM application, and removing wattles.

**Materials**

Wattle shall meet the following specifications:

100% Curled Wood (Excelsior) Fibers	
Minimum Diameter	12 in.
Minimum Density	2.5 lb/ft <sup>3</sup> +/- 10%
Net Material	Synthetic
Net Openings	1 in. x 1 in.
Net Configuration	Totally Encased
Minimum Weight	20 lb. +/- 10% per 10 ft. length

Anchors: Stakes shall be used as anchors.

Wooden Stakes:

Provide hardwood stakes a minimum of 2-ft. long with a 2 in. x 2 in. nominal square cross section. One end of the stake must be sharpened or beveled to facilitate driving down into the underlying soil.

Matting shall meet the requirements of Article 1060-8 of the *Standard Specifications*, or shall meet specifications provided elsewhere in this contract.

Provide staples made of 0.125" diameter new steel wire formed into a *u* shape not less than 12" in length with a throat of 1" in width.

Polyacrylamide (PAM) shall be applied in powder form and shall be anionic or neutrally charged. Soil samples shall be obtained in areas where the wattles will be placed, and from offsite material used to construct the roadway, and analyzed for the appropriate PAM flocculant to be utilized with

each wattle. The PAM product used shall be listed on the North Carolina Department of Environmental Quality Division of Water Resources web site as an approved PAM product for use in North Carolina.

### **Construction Methods**

Wattles shall be secured to the soil by wire staples approximately every 1 linear foot and at the end of each section of wattle. A minimum of 4 stakes shall be installed on the downstream side of the wattle with a maximum spacing of 2 linear feet along the wattle, and according to the detail. Install a minimum of 2 stakes on the upstream side of the wattle according to the detail provided in the plans. Stakes shall be driven into the ground a minimum of 10 in. with no more than 2 in. projecting from the top of the wattle. Drive stakes at an angle according to the detail provided in the plans.

Only install wattle(s) to a height in ditch so flow will not wash around wattle and scour ditch slopes and according to the detail provided in the plans and as directed. Overlap adjoining sections of wattles a minimum of 6 in.

Installation of matting shall be in accordance with the detail provided in the plans, and in accordance with Article 1631-3 of the *Standard Specifications*, or in accordance with specifications provided elsewhere in this contract.

Apply PAM over the lower center portion of the wattle where the water is going to flow over at a rate of 2 ounces per wattle, and 1 ounce of PAM on matting on each side of the wattle. PAM applications shall be done during construction activities after every rainfall event that is equal to or exceeds 0.50 in.

The Contractor shall maintain the wattles until the project is accepted or until the wattles are removed, and shall remove and dispose of silt accumulations at the wattles when so directed in accordance with the requirements of Section 1630 of the *Standard Specifications*.

### **Measurement and Payment**

*Wattles* will be measured and paid for by the actual number of linear feet of wattles which are installed and accepted. Such price and payment will be full compensation for all work covered by this section, including, but not limited to, furnishing all materials, labor, equipment and incidentals necessary to install the *Wattles*.

Matting will be measured and paid for in accordance with Article 1631-4 of the *Standard Specifications*, or in accordance with specifications provided elsewhere in this contract.

*Polyacrylamide(PAM)* will be measured and paid for by the actual weight in pounds of PAM applied to the wattles. Such price and payment will be full compensation for all work covered by this section, including, but not limited to, furnishing all materials, labor, equipment and incidentals necessary to apply the *Polyacrylamide(PAM)*.

Payment will be made under:

<b>Pay Item</b>	<b>Pay Unit</b>
Polyacrylamide(PAM)	Pound
Wattle	Linear Foot

**TEMPORARY ROCK SILT CHECK TYPE A WITH EXCELSIOR MATTING AND POLYACRYLAMIDE (PAM):**

**Description**

Temporary Rock Silt Checks Type A with Excelsior Matting and Polyacrylamide (PAM) are devices utilized in temporary and permanent ditches to reduce runoff velocity and incorporate PAM into the construction runoff to increase settling of sediment particles and reduce turbidity of runoff. Temporary Rock Silt Checks Type A with Excelsior Matting and PAM are to be placed at locations shown on the plans or as directed. Installation shall follow the detail provided in the plans and as directed. Work includes furnishing materials, installation of Temporary Rock Silt Checks Type A, matting installation, PAM application, and removing Temporary Rock Silt Checks Type A with Excelsior Matting and PAM.

**Materials**

Structural stone shall be class B stone that meets the requirements of Section 1042 of the *Standard Specifications* for Stone for Erosion Control, Class B.

Sediment control stone shall be #5 or #57 stone, which meets the requirements of Section 1005 of the *Standard Specifications* for these stone sizes.

Matting shall meet the requirements of Excelsior Matting in Subarticle 1060-8(B) of the *Standard Specifications*, or shall meet specifications provided elsewhere in this contract.

Polyacrylamide (PAM) shall be applied in powder form and shall be anionic or neutrally charged. Soil samples shall be obtained in areas where the Temporary Rock Silt Checks Type A with Excelsior Matting and PAM will be placed, and from offsite material used to construct the roadway, and analyzed for the appropriate PAM flocculant to be utilized with each Temporary Rock Silt Check Type A. The PAM product used shall be listed on the North Carolina Department of Environmental Quality Division of Water Resources web site as an approved PAM product for use in North Carolina.

**Construction Methods**

Temporary Rock Silt Checks Type A shall be installed in accordance with Subarticle 1633-3(A) of the *Standard Specifications*, Roadway Standard Drawing No. 1633.01 and the detail provided in the plans.

Installation of matting shall be in accordance with the detail provided in the plans, and anchored by placing Class B stone on top of the matting at the upper and lower ends.

Apply PAM at a rate of 4 ounces over the center portion of the Temporary Rock Silt Checks Type A and matting where the water is going to flow over. PAM applications shall be done during construction activities and after every rainfall event that is equal to or exceeds 0.50 in.

The Contractor shall maintain the Temporary Rock Silt Checks Type A with Excelsior Matting and PAM until the project is accepted or until the Temporary Rock Silt Checks Type A with Excelsior Matting and PAM are removed, and shall remove and dispose of silt accumulations at the Temporary Rock Silt Checks Type A with Excelsior Matting and PAM when so directed in accordance with the requirements of Section 1630 of the *Standard Specifications*.

**Measurement and Payment**

*Temporary Rock Silt Checks Type A* will be measured and paid for in accordance with Article 1633-5 of the *Standard Specifications*, or in accordance with specifications provided elsewhere in this contract.

Matting will be measured and paid for in accordance with Article 1631-4 of the *Standard Specifications*, or in accordance with specifications provided elsewhere in this contract.

*Polyacrylamide(PAM)* will be measured and paid for by the actual weight in pounds of PAM applied to the Temporary Rock Silt Checks Type A. Such price and payment will be full compensation for all work covered by this section, including, but not limited to, furnishing all materials, labor, equipment and incidentals necessary to apply the *Polyacrylamide(PAM)*.

Payment will be made under:

<b>Pay Item</b>	<b>Pay Unit</b>
Polyacrylamide(PAM)	Pound

**IMPERVIOUS DIKE:**

**Description**

This work consists of furnishing, installing, maintaining, and removing an *Impervious Dike* for the purpose of diverting normal stream flow around the construction site. The Contractor shall construct an impervious dike in such a manner approved by the Engineer. The impervious dike shall not permit seepage of water into the construction site or contribute to siltation of the stream. The impervious dike shall be constructed of an acceptable material in the locations noted on the plans or as directed.

**Materials**

Acceptable materials shall include but not be limited to sheet piles, sandbags, and/or the placement of an acceptable size stone lined with polypropylene or other impervious geotextile.

Earth material shall not be used to construct an impervious dike when it is in direct contact with the stream unless vegetation can be established before contact with the stream takes place.

**Measurement and Payment**

*Impervious Dike* will be measured and paid as the actual number of linear feet of impervious dike(s) constructed, measured in place from end to end of each separate installation that has been completed and accepted. Such price and payment will be full compensation for all work including but not limited to furnishing materials, construction, maintenance, and removal of the impervious dike.

Payment will be made under:

**Pay Item**

Impervious Dike

**Pay Unit**

Linear Foot

**PUMP AROUND OPERATION:****Description**

The work covered by this section consists of furnishing, installing, maintaining and removing any and all pump around systems used on this project. The Contractor shall install a pump around system in locations as shown in the plans and in other locations approved by the Engineer. The pump around system shall provide a passageway for the stream flow around the work site.

The quantity of pump around systems may be increased, decreased, or eliminated entirely as directed. Such variations in quantity will not be considered as alterations in the details of construction or a change in the character of the work. See NCDOT *Best Management Practices for Construction and Maintenance Activities* manual for example pump around operation.

**Materials****Item**

Special Stilling Basin

**Section**

1639

*Impervious Dike* shall meet the specifications as provided elsewhere in this contract.

Pumps shall be of sufficient size to divert the stream flow around the work area, as approved by the Engineer.

### **Construction Methods**

Install *impervious dike(s)* as shown on the plans or as directed. Pump water around the work site. If the water is turbid or exposed to bare soil, pump through a *special stilling basin*. Once the work is complete in an area remove the *impervious dike(s)* and pump system, and stabilize the area.

### **Measurement and Payment**

*Impervious Dike* will be measured and paid for as provided elsewhere in this contract.

*Special Stilling Basin* will be measured and paid for in accordance with Article 1639-4 of the *Standard Specifications*.

Payment for pumping operations shall be considered incidental to the work of installing pipes and culverts. The pumping operations shall include but not be limited to, diverting the stream flow around the work area and pumping runoff from the work area into a stilling basin, special stilling basin or other sediment control device. No additional payment will be made for furnishing materials or maintenance of the pumping operations for the installation of pipes and culverts.

The above prices and payments will be full compensation for all work covered by this section including, but not limited to furnishing all of the necessary materials, construction, maintenance and removal of the impervious dike and pump around system.

### **COIR FIBER MAT:**

#### **Description**

Furnish material, install and maintain coir fiber mat in locations shown on the plans or in locations as directed. Work includes providing all materials, excavating and backfilling, and placing and securing coir fiber mat with stakes, steel reinforcement bars or staples as directed.

#### **Materials**

<b>Item</b>	<b>Section</b>
Coir Fiber Mat	1060-14

Anchors: Stakes, reinforcement bars, or staples shall be used as anchors.

#### Wooden Stakes:

Provide hardwood stakes 12"- 24" long with a 2" x 2" nominal square cross section. One end of the stake must be sharpened or beveled to facilitate driving through the coir fiber mat and down into the underlying soil. The other end of the stake needs to have a 1"- 2" long head at the top with a 1"- 2" notch following to catch and secure the coir fiber mat.

**Steel Reinforcement Bars:**

Provide uncoated #10 steel reinforcement bars 24" nominal length. The bars shall have a 4" diameter bend at one end with a 4" straight section at the tip to catch and secure the coir fiber mat.

**Staples:**

Provide staples made of 0.125" diameter new steel wire formed into a *u* shape not less than 12" in length with a throat of 1" in width.

**Construction Methods**

Place the coir fiber mat immediately upon final grading. Provide a smooth soil surface free from stones, clods, or debris that will prevent the contact of the mat with the soil. Unroll the mat and apply without stretching such that it will lie smoothly but loosely on the soil surface.

For stream relocation applications, take care to preserve the required line, grade, and cross section of the area covered. Bury the top slope end of each piece of mat in a narrow trench at least 6 in. deep and tamp firmly. Where one roll of matting ends and a second roll begins, overlap the end of the upper roll over the buried end of the second roll so there is a 6 in. overlap. Construct check trenches at least 12 in. deep every 50 ft. longitudinally along the edges of the mat or as directed. Fold over and bury mat to the full depth of the trench, close and tamp firmly. Overlap mat at least 6 in. where 2 or more widths of mat are installed side by side.

Place anchors across the mat at the ends approximately 1 ft. apart. Place anchors along the outer edges and down the center of the mat 3 ft. apart.

Adjustments in the trenching or anchoring requirements to fit individual site conditions may be required.

**Measurement and Payment**

*Coir Fiber Mat* will be measured and paid for as the actual number of square yards measured along the surface of the ground over which coir fiber mat is installed and accepted.

No measurement will be made for anchor items.

Payment will be made under:

**Pay Item**

Coir Fiber Mat

**Pay Unit**

Square Yard



**CONCRETE WASHOUT STRUCTURE:**

(12-10-20)

**Description**

Concrete washout structures are enclosures above or below grade to contain concrete waste water and associated concrete mix from washing out ready-mix trucks, drums, pumps, or other equipment. Concrete washouts must collect and retain all the concrete washout water and solids, so that this material does not migrate to surface waters or into the ground water. These enclosures are not intended for concrete waste not associated with wash out operations.

The concrete washout structure may include constructed devices above or below ground and or commercially available devices designed specifically to capture concrete wash water.

**Materials**

<b>Item</b>	<b>Section</b>
Temporary Silt Fence	1605

*Safety Fence* shall meet the specifications as provided elsewhere in this contract.

Geomembrane basin liner shall meet the following minimum physical properties for low permeability; it shall consist of a polypropylene or polyethylene 10 mil thick geomembrane. If the minimum setback dimensions can be achieved the liner is not required. (5 feet above groundwater, 50 feet from top of bank of perennial stream, other surface water body, or wetland.)

**Construction Methods**

Build an enclosed earthen berm or excavate to form an enclosure in accordance with the details and as directed.

Install temporary silt fence around the perimeter of the enclosure in accordance with the details and as directed if structure is not located in an area where existing erosion and sedimentation control devices are capable to containing any loss of sediment.

Post a sign with the words "Concrete Washout" in close proximity of the concrete washout area, so it is clearly visible to site personnel. Install safety fence as directed for visibility to construction traffic.

The construction details for the above grade and below grade concrete washout structures can be found on the following web page link:

<https://connect.ncdot.gov/resources/roadside/SoilWaterDocuments/ConcreteWashoutStructureDetail.pdf>

Alternate details for accommodating concrete washout may be submitted for review and approval.

The alternate details shall include the method used to retain and dispose of the concrete waste water within the project limits and in accordance with the minimum setback requirements. (5 feet above groundwater, 50 feet from top of bank of perennial stream, other surface water body, or wetland.)

### **Maintenance and Removal**

Maintain the concrete washout structure(s) to provide adequate holding capacity plus a minimum freeboard of 12 inches. Remove and dispose of hardened concrete and return the structure to a functional condition after reaching 75% capacity.

Inspect concrete washout structures for damage and maintain for effectiveness.

Remove the concrete washout structures and sign upon project completion. Grade the earth material to match the existing contours and permanently seed and mulch area.

### **Measurement and Payment**

*Concrete Washout Structure* will be paid for per each enclosure installed in accordance with the details. If alternate details or commercially available devices are approved, then those devices will also be paid for per each approved and installed device.

*Temporary Silt Fence* will be measured and paid for in accordance with Article 1605-5 of the *Standard Specifications*.

*Safety Fence* shall be measured and paid for as provided elsewhere in this contract.

No measurement will be made for other items or for over excavation or stockpiling.

Payment will be made under:

<b>Pay Item</b>	<b>Pay Unit</b>
Concrete Washout Structure	Each

### **TACK FOR MULCH FOR EROSION CONTROL:**

(07-19-22)

### **Description**

This work consists of supplying and installing of an approved material for binding mulch for erosion control in accordance with Section 1060-5, Section 1615 and Section 1660 of the *Standard Specifications*. This provision defines acceptable materials and rates for tacking material for holding mulch in place.

**Materials**

## (a) Emulsified Asphalt

Asphalt emulsion tack shall conform to the requirements of AASHTO M 140, Specification for Emulsified Asphalt. The emulsified asphalt may be rapid setting, medium setting, or slow setting. Apply emulsified asphalt tackifier at a rate of 0.10 gallons per square yard (approximately 484 gallons per acre).

## (b) Cellulose Hydromulch

Cellulose hydromulch products shall be non-toxic, weed-free, prepackaged cellulose fiber (pulp) material containing no more than 3% ash or other inert materials. Cellulose hydromulches may contain dyes or binders specifically formulated to enhance the adhesive qualities of the hydromulch. Apply cellulose hydromulches at a rate of 1000 pounds (dry weight) per acre.

Wood fiber or wood fiber blend hydromulches may be substituted for cellulose hydromulch at the same application rate.

## (c) Other tackifiers

Other approved materials, specifically designed and manufactured for application as a straw mulch tacking agent, may be used at the manufacturer's recommended rate.

**Construction Methods**

Apply the Tack for Mulch for Erosion Control uniformly across straw mulch per Section 1615 and Section 1660 of the *Standard Specifications*.

**Payment**

*Tack for Mulch for Erosion Control* is incidental to the application of *Temporary Mulching*, Section 1615-4, and *Seeding and Mulching*, Section 1660-8, and no additional payment will be made.

Signals and Intelligent Transportation Systems  
Project Special Provisions  
(Version 18.6)

Prepared By: KGP, Jr.  
4-Apr-22

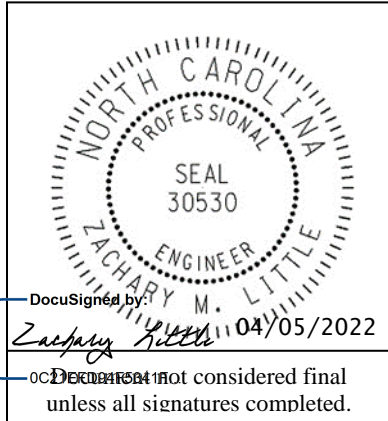

Contents

**1. 2018 STANDARD SPECIFICATIONS FOR ROADS & STRUCTURES.....3**

1.1. GENERAL REQUIREMENTS – CONSTRUCTION METHODS (1700-3(K)) .....3

1.2. GENERAL REQUIREMENTS – CONSTRUCTION METHODS (1700-3(M)).....3

1.3. WOOD POLES – CONSTRUCTION METHODS (1720-3) .....3

**2. SIGNAL HEADS.....3**

2.1. MATERIALS .....3

A. General: .....3

B. Vehicle Signal Heads:.....5

C. Signal Cable:.....7

D. Louvers: .....7

**3. CONTROLLERS WITH CABINETS .....7**

3.1. MATERIALS – GENERAL CABINETS .....7

3.2. MATERIALS – TYPE 170E CABINETS .....8

A. Type 170 E Cabinets General: .....8

B. Type 170 E Cabinet Electrical Requirements: .....9

C. Type 170 E Cabinet Physical Requirements:.....15

D. Model 2018 Enhanced Conflict Monitor: .....18

E. Preemption and Sign Control Box .....28

3.3. MATERIALS – TYPE 170 DETECTOR SENSOR UNITS .....31

3.4. MATERIALS – TYPE 2070E CONTROLLERS .....31

**4. ETHERNET EDGE SWITCH.....31**

4.1. DESCRIPTION .....31

A. Ethernet Edge Switch: .....31

B. Network Management: .....31

4.2. MATERIALS .....32

A. General: .....32

B. Compatibility Acceptance.....32

C. Standards: .....32

D. Functional: .....33

E. Physical Features: .....33

F. Management Capabilities: .....34

G. Electrical Specifications: .....35

H. Environmental Specifications: .....35

I. Ethernet Patch Cable: .....36

4.3. CONSTRUCTION METHODS .....36

A. General: .....36

B. Edge Switch:.....36

4.4. MEASUREMENT AND PAYMENT.....36

**5. MODIFY SPREAD SPECTRUM WIRELESS RADIO.....37**

5.1. DESCRIPTION .....37  
5.2. MATERIALS .....37  
5.1. CONSTRUCTION METHODS .....37  
5.1. MEASUREMENT AND PAYMENT .....37

## 1. 2018 STANDARD SPECIFICATIONS FOR ROADS & STRUCTURES

*The 2018 Standard Specifications are revised as follows:*

### 1.1. GENERAL REQUIREMENTS – Construction Methods (1700-3(K))

Page 17-4, revise sentence starting on line 14 to read “Modify existing electrical services, as necessary, to meet the grounding requirements of the NEC, these *Standard Specifications*, *Standard Drawings*, and the project plans.”

Page 17-4, revise sentence beginning on line 21 to read “Furnish and install additional ground rods to grounding electrode system as necessary to meet the *Standard Specifications*, *Standard Drawings*, and test requirements.”

### 1.2. GENERAL REQUIREMENTS – Construction Methods (1700-3(M))

Page 17-4, Replace the sentence beginning on line 41 with “Prior to placing signal in the steady (stop-and-go) mode, the signal should be placed in the flashing mode for up to 7 days or as directed by the Engineer. The signal should not be placed in the steady (stop-and-go) mode on a Saturday or Sunday without prior approval from the Engineer. Do not place the signal in steady (stop-and-go) mode until inspected and without the prior approval of the Engineer.”

### 1.3. WOOD POLES – Construction Methods (1720-3)

Page 17-18, revise sentence starting on line 13 to read “On new Department-owned poles, install a grounding system consisting of #6 AWG solid bare copper wire that is mechanically crimped using an irreversible compression tool with die to a single ground rod installed at base of pole or to the electrical service grounding electrode system located within 10 feet of the pole.”

## 2. SIGNAL HEADS

### 2.1. MATERIALS

#### A. General:

Fabricate vehicle signal head housings and end caps from die-cast aluminum. Fabricate 12-inch and 16-inch pedestrian signal head housings and end caps from die-cast aluminum. Fabricate 9-inch pedestrian signal head housings, end caps, and visors from virgin polycarbonate material. Provide visor mounting screws, door latches, and hinge pins fabricated from stainless steel. Provide interior screws, fasteners, and metal parts fabricated from stainless steel.

Fabricate tunnel and traditional visors from sheet aluminum.

Paint all surfaces inside and outside of signal housings and doors. Paint outside surfaces of tunnel and traditional visors, wire outlet bodies, wire entrance fitting brackets and end caps when supplied as components of messenger cable mounting assemblies, pole and pedestal mounting assemblies, and pedestrian pushbutton housings. Have electrostatically-applied, fused-polyester paint in highway yellow (Federal Standard 595C, Color Chip Number 13538) a minimum of 2.5 to 3.5 mils thick. Do not apply paint to the latching hardware, rigid vehicle signal head mounting brackets for mast-arm attachments, messenger cable hanger components or balance adjuster components.

Have the interior surfaces of tunnel and traditional visors painted an alkyd urea black synthetic baking enamel with a minimum gloss reflectance and meeting the requirements of MIL-E-10169, “Enamel Heat Resisting, Instrument Black.”

Where required, provide polycarbonate signal heads and visors that comply with the provisions pertaining to the aluminum signal heads listed on the QPL with the following exceptions:

Fabricate signal head housings, end caps, and visors from virgin polycarbonate material. Provide UV stabilized polycarbonate plastic with a minimum thickness of  $0.1 \pm 0.01$  inches that is highway yellow (Federal Standard 595C, Color Chip 13538). Ensure the color is incorporated into the plastic material before molding the signal head housings and end caps. Ensure the plastic formulation provides the following physical properties in the assembly (tests may be performed on separately molded specimens):

Test	Required	Method
Specific Gravity	1.17 minimum	ASTM D 792
Flammability	Self-extinguishing	ASTM D 635
Tensile Strength, yield, PSI	8500 minimum	ASTM D 638
Izod impact strength, ft-lb/in [notched, 1/8 inch]	12 minimum	ASTM D 256

For pole mounting, provide side of pole mounting assemblies with framework and all other hardware necessary to make complete, watertight connections of the signal heads to the poles and pedestals. Fabricate the mounting assemblies and frames from aluminum with all necessary hardware, screws, washers, etc. to be stainless steel. Provide mounting fittings that match the positive locking device on the signal head with the serrations integrally cast into the brackets. Provide upper and lower pole plates that have a 1 ¼-inch vertical conduit entrance hubs with the hubs capped on the lower plate and 1 ½-inch horizontal hubs. Ensure that the assemblies provide rigid attachments to poles and pedestals so as to allow no twisting or swaying of the signal heads. Ensure that all raceways are free of sharp edges and protrusions, and can accommodate a minimum of ten Number 14 AWG conductors.

For pedestal mounting, provide a post-top slipfitter mounting assembly that matches the positive locking device on the signal head with serrations integrally cast into the slipfitter. Provide stainless steel hardware, screws, washers, etc. Provide a minimum of six 3/8 X 3/4-inch long square head bolts for attachment to pedestal. Provide a center post for multi-way slipfitters.

For light emitting diode (LED) traffic signal modules, provide the following requirements for inclusion on the Department's Qualified Products List for traffic signal equipment.

1. Sample submittal,
2. Third-party independent laboratory testing results for each submitted module with evidence of testing and conformance with all of the Design Qualification Testing specified in section 6.4 of each of the following Institute of Transportation Engineers (ITE) specifications:
  - Vehicle Traffic Control Signal Heads – Light Emitting Diode (LED) Circular Signal Supplement
  - Vehicle Traffic Control Signal Heads – Light Emitting Diode (LED) Vehicle Arrow Traffic Signal Supplement
  - Pedestrian Traffic Control Signal Indications –Light Emitting Diode (LED) Signal Modules.

(Note: The Department currently recognizes two approved independent testing laboratories. They are Intertek ETL Semko and Light Metrics, Incorporated with Garwood Laboratories. Independent laboratory tests from other laboratories may be considered as part of the QPL submittal at the discretion of the Department,

3. Evidence of conformance with the requirements of these specifications,

4. A manufacturer's warranty statement in accordance with the required warranty, and
5. Submittal of manufacturer's design and production documentation for the model, including but not limited to, electrical schematics, electronic component values, proprietary part numbers, bill of materials, and production electrical and photometric test parameters.
6. Evidence of approval of the product to bear the Intertek ETL Verified product label for LED traffic signal modules.

In addition to meeting the performance requirements for the minimum period of 60 months, provide a written warranty against defects in materials and workmanship for the modules for a period of 60 months after installation of the modules. During the warranty period, the manufacturer must provide new replacement modules within 45 days of receipt of modules that have failed at no cost to the State. Repaired or refurbished modules may not be used to fulfill the manufacturer's warranty obligations. Provide manufacturer's warranty documentation to the Department during evaluation of product for inclusion on Qualified Products List (QPL).

#### **B. Vehicle Signal Heads:**

Comply with the ITE standard "Vehicle Traffic Control Signal Heads". Provide housings with provisions for attaching backplates.

Provide visors that are 8 inches in length for 8-inch vehicle signal head sections. Provide visors that are 10 inches in length for 12-inch vehicle signal heads.

Provide a termination block with one empty terminal for field wiring for each indication plus one empty terminal for the neutral conductor. Have all signal sections wired to the termination block. Provide barriers between the terminals that have terminal screws with a minimum Number 8 thread size and that will accommodate and secure spade lugs sized for a Number 10 terminal screw.

Mount termination blocks in the yellow signal head sections on all in-line vehicle signal heads. Mount the termination block in the red section on five-section vehicle signal heads.

Furnish vehicle signal head interconnecting brackets. Provide one-piece aluminum brackets less than 4.5 inches in height and with no threaded pipe connections. Provide hand holes on the bottom of the brackets to aid in installing wires to the signal heads. Lower brackets that carry no wires and are used only for connecting the bottom signal sections together may be flat in construction.

For messenger cable mounting, provide messenger cable hangers, wire outlet bodies, balance adjusters, bottom caps, wire entrance fitting brackets, and all other hardware necessary to make complete, watertight connections of the vehicle signal heads to the messenger cable. Fabricate messenger cable hanger components, wire outlet bodies and balance adjuster components from stainless steel or malleable iron galvanized in accordance with ASTM A153 (Class A) or ASTM A123. Provide serrated rings made of aluminum. Provide messenger cable hangers with U-bolt clamps. Fabricate washers, screws, hex-head bolts and associated nuts, clevis pins, cotter pins, U-bolt clamps and nuts from stainless steel.

For mast-arm mounting, provide rigid vehicle signal head mounting brackets and all other hardware necessary to make complete, watertight connections of the vehicle signal heads to the mast arms and to provide a means for vertically adjusting the vehicle signal heads to proper alignment. Fabricate the mounting assemblies from aluminum, and provide serrated rings made of aluminum. Provide stainless steel cable attachment assemblies to secure the brackets to the mast arms. Ensure all fastening hardware and fasteners are fabricated from stainless steel.

Provide LED vehicular traffic signal modules (hereafter referred to as modules) that consist of an assembly that uses LEDs as the light source in lieu of an incandescent lamp for use in traffic signal



sections. Use LEDs that are aluminum indium gallium phosphorus (AlInGaP) technology for red and yellow indications and indium gallium nitride (InGaN) for green indications. Install the ultra bright type LEDs that are rated for 100,000 hours of continuous operation from -40°F to +165°F. Design modules to have a minimum useful life of 60 months and to meet all parameters of this specification during this period of useful life.

For the modules, provide spade terminals crimped to the lead wires and sized for a #10 screw connection to the existing terminal block in a standard signal head. Do not provide other types of crimped terminals with a spade adapter.

Ensure the power supply is integral to the module assembly. On the back of the module, permanently mark the date of manufacture (month & year) or some other method of identifying date of manufacture.

Tint the red, yellow and green lenses to correspond with the wavelength (chromaticity) of the LED. Transparent tinting films are unacceptable. Provide a lens that is integral to the unit with a smooth outer surface.

### 1. LED Circular Signal Modules:

Provide modules in the following configurations: 12-inch circular sections, and 8-inch circular sections. All makes and models of LED modules purchased for use on the State Highway System shall appear on the current NCDOT Traffic Signal Qualified Products List (QPL).

Provide the manufacturer's model number and the product number (assigned by the Department) for each module that appears on the 2018 or most recent Qualified Products List. In addition, provide manufacturer's certification in accordance with Article 106-3 of the *Standard Specifications*, that each module meets or exceeds the ITE "Vehicle Traffic Control Signal Heads – Light Emitting Diode (LED) Circular Signal Supplement" dated June 27, 2005 (hereafter referred to as VTCSH Circular Supplement) and other requirements stated in this specification.

Provide modules that meet the following requirements when tested under the procedures outlined in the VTCSH Circular Supplement:

Module Type	Max. Wattage at 165° F	Nominal Wattage at 77° F
12-inch red circular	17	11
8-inch red circular	13	8
12-inch green circular	15	15
8-inch green circular	12	12

For yellow circular signal modules, provide modules tested under the procedures outlined in the VTCSH Circular Supplement to insure power required at 77° F is 22 Watts or less for the 12-inch circular module and 13 Watts or less for the 8-inch circular module.

Note: Use a wattmeter having an accuracy of  $\pm 1\%$  to measure the nominal wattage and maximum wattage of a circular traffic signal module. Power may also be derived from voltage, current and power factor measurements.

### 2. LED Arrow Signal Modules

Provide 12-inch omnidirectional arrow signal modules. All makes and models of LED modules purchased for use on the State Highway System shall appear on the current NCDOT Traffic Signal Qualified Products List (QPL).

Provide the manufacturer's model number and the product number (assigned by the Department) for each module that appears on the 2018 or most recent Qualified Products List. In addition, provide

manufacturer's certification in accordance with Article 106-3 of the *Standard Specifications*, that each module meets or exceeds the requirements for 12-inch omnidirectional modules specified in the ITE "Vehicle Traffic Control Signal Heads – Light Emitting Diode (LED) Vehicle Arrow Traffic Signal Supplement" dated July 1, 2007 (hereafter referred to as VTCSH Arrow Supplement) and other requirements stated in this specification.

Provide modules that meet the following requirements when tested under the procedures outlined in the VTCSH Arrow Supplement:

Module Type	Max. Wattage at 165° F	Nominal Wattage at 77° F
12-inch red arrow	12	9
12-inch green arrow	11	11

For yellow arrow signal modules, provide modules tested under the procedures outlined in the VTCSH Arrow Supplement to insure power required at 77° F is 12 Watts or less.

Note: Use a wattmeter having an accuracy of  $\pm 1\%$  to measure the nominal wattage and maximum wattage of an arrow traffic signal module. Power may also be derived from voltage, current and power factor measurements.

### C. Signal Cable:

Furnish 16-4 and 16-7 signal cable that complies with IMSA specification 20-1 except provide the following conductor insulation colors:

- For 16-4 cable: white, yellow, red, and green
- For 16-7 cable: white, yellow, red, green, yellow with black stripe tracer, red with black stripe tracer, and green with black stripe tracer. Apply continuous stripe tracer on conductor insulation with a longitudinal or spiral pattern.

Provide a ripcord to allow the cable jacket to be opened without using a cutter. IMSA specification 19-1 will not be acceptable. Provide a cable jacket labeled with the IMSA specification number and provide conductors constructed of stranded copper.

### D. Louvers:

Material, equipment, and hardware furnished under this section must be pre-approved on the Department's QPL by the date of installation.

Provide louvers made from sheet aluminum. Paint the louvers alkyd urea black synthetic baked enamel with a minimum gloss reflectance and meeting the requirements of MIL-E-10169, "Enamel Heat Resisting, Instrument Black."

Ensure that the louvers have a 0-degree horizontal viewing angle. Provide a minimum of 5 vanes.

## 3. CONTROLLERS WITH CABINETS

### 3.1. MATERIALS – GENERAL CABINETS

Provide a moisture resistant coating on all circuit boards.

Provide one 20 mm diameter radial lead UL-recognized metal oxide varistor (MOV) between each load switch field terminal and equipment ground. Electrical performance is outlined below.

PROPERTIES OF MOV SURGE PROTECTOR	
Maximum Continuous Applied Voltage at 185° F	150 VAC (RMS) 200 VDC
Maximum Peak 8x20µs Current at 185° F	6500 A
Maximum Energy Rating at 185° F	80 J
Voltage Range 1 mA DC Test at 77° F	212-268 V
Max. Clamping Voltage 8x20µs, 100A at 77° F	395 V
Typical Capacitance (1 MHz) at 77° F	1600 pF

Provide a power line surge protector that is a two-stage device that will allow connection of the radio frequency interference filter between the stages of the device. Ensure that a maximum continuous current is at least 10A at 120V. Ensure that the device can withstand a minimum of 20 peak surge current occurrences at 20,000A for an 8x20 microsecond waveform. Provide a maximum clamp voltage of 395V at 20,000A with a nominal series inductance of 200µh. Ensure that the voltage does not exceed 395V. Provide devices that comply with the following:

Frequency (Hz)	Minimum Insertion Loss (dB)
60	0
10,000	30
50,000	55
100,000	50
500,000	50
2,000,000	60
5,000,000	40
10,000,000	20
20,000,000	25

### 3.2. MATERIALS – TYPE 170E CABINETS

#### A. Type 170 E Cabinets General:

Conform to the city of Los Angeles' Specification No. 54-053-08, *Traffic Signal Cabinet Assembly Specification* (dated July 2008), except as required herein.

Furnish model 336S pole mounted cabinets configured for 8 vehicle phases, 4 pedestrian phases, and 6 overlaps. Do not reassign load switches to accommodate overlaps unless shown on electrical details. Provide 336S pole mounted cabinets that are 46" high with 40" high internal rack assemblies.

Furnish model 332 base mounted cabinets configured for 8 vehicle phases, 4 pedestrian phases, and 6 overlaps. When overlaps are required, provide auxiliary output files for the overlaps. Do not reassign load switches to accommodate overlaps unless shown on electrical details.

Provide model 200 load switches, model 222 loop detector sensors, model 252 AC isolators, and model 242 DC isolators according to the electrical details. As a minimum, provide one (1) model 2018 conflict monitor, one (1) model 206L power supply unit, two (2) model 204 flashers, one (1) DC isolator (located in slot I14), and four (4) model 430 flash transfer relays (provide seven (7) model 430 flash transfer relays if auxiliary output file is installed) with each cabinet.

**B. Type 170 E Cabinet Electrical Requirements:**

Provide a cabinet assembly designed to ensure that upon leaving any cabinet switch or conflict monitor initiated flashing operation, the controller starts up in the programmed start up phases and start up interval.

Furnish two sets of non-fading cabinet wiring diagrams and schematics in a paper envelope or container and placed in the cabinet drawer.

All AC+ power is subject to radio frequency signal suppression.

Provide surge suppression in the cabinet for each type of cabinet device. Provide surge protection for the full capacity of the cabinet input file. Provide surge suppression devices that operate properly over a temperature range of -40° F to +185° F. Ensure the surge suppression devices provide both common and differential modes of protection.

Provide a pluggable power line surge protector that is installed on the back of the PDA (power distribution assembly) chassis to filter and absorb power line noise and switching transients. Ensure the device incorporates LEDs for failure indication and provides a dry relay contact closure for the purpose of remote sensing. Ensure the device meets the following specifications:

Peak Surge Current (Single pulse, 8x20µs).....	20,000A
Occurrences (8x20µs waveform).....	10 minimum @ 20,000A
Maximum Clamp Voltage.....	395VAC
Operating Current.....	15 amps
Response Time.....	< 5 nanoseconds

Provide a loop surge suppressor for each set of loop terminals in the cabinet. Ensure the device meets the following specifications:

Peak Surge Current (6 times, 8x20µs)	
(Differential Mode).....	400A
(Common Mode).....	1,000A
Occurrences (8x20µs waveform).....	500 min @ 200A
Maximum Clamp Voltage	
(Differential Mode @400A).....	35V
(Common Mode @1,000A).....	35V
Response Time.....	< 5 nanoseconds
Maximum Capacitance.....	35 pF

Provide a data communications surge suppressor for each communications line entering or leaving the cabinet. Ensure the device meets the following specifications:

Peak Surge Current (Single pulse, 8x20 $\mu$ s).....	10,000A
Occurrences (8x20 $\mu$ s waveform).....	100 min @ 2,000A
Maximum Clamp Voltage.....	Rated for equipment protected
Response Time.....	< 1 nanosecond
Maximum Capacitance.....	1,500 pF
Maximum Series Resistance.....	15 $\Omega$

Provide a DC signal surge suppressor for each DC input channel in the cabinet. Ensure the device meets the following specifications:

Peak Surge Current (Single pulse, 8x20 $\mu$ s).....	10,000A
Occurrences (8x20 $\mu$ s waveform).....	100 @ 2,000A
Maximum Clamp Voltage.....	30V
Response Time.....	< 1 nanosecond

Provide a 120 VAC signal surge suppressor for each AC+ interconnect signal input. Ensure the device meets the following specifications:

Peak Surge Current (Single pulse, 8x20 $\mu$ s).....	20,000A
Maximum Clamp Voltage.....	350VAC
Response Time.....	< 200 nanoseconds
Discharge Voltage.....	<200 Volts @ 1,000A
Insulation Resistance.....	$\geq$ 100 M $\Omega$

Provide conductors for surge protection wiring that are of sufficient size (ampacity) to withstand maximum overcurrents which could occur before protective device thresholds are attained and current flow is interrupted.

If additional surge protected power outlets are needed to accommodate fiber transceivers, modems, etc., install a UL listed, industrial, heavy-duty type power outlet strip with a minimum rating of 15 A / 125 VAC, 60 Hz. Provide a strip that has a minimum of 3 grounded outlets. Ensure the power outlet strip plugs into one of the controller unit receptacles located on the rear of the PDA. Ensure power outlet strip is mounted securely; provide strain relief if necessary.

Provide a door switch in the front and a door switch in the rear of the cabinet that will provide the controller unit with a Door Ajar alarm when either the front or the rear door is open. Ensure the door switches apply DC ground to the Input File when either the front door or the rear door is open.

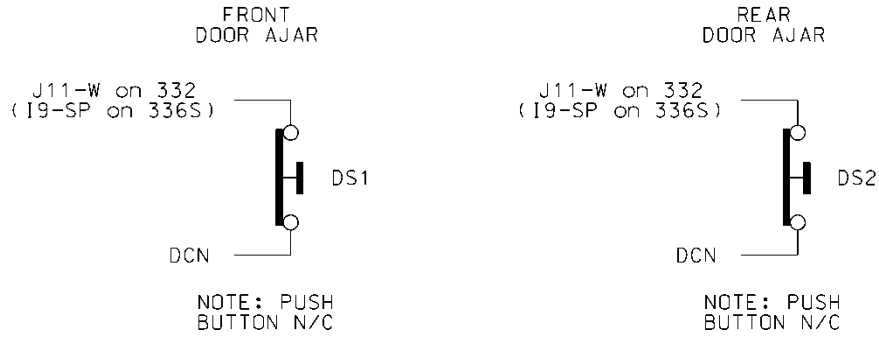

Furnish a fluorescent fixture in the rear across the top of the cabinet and another fluorescent fixture in the front across the top of the cabinet at a minimum. Ensure that the fixtures provide sufficient light to illuminate all terminals, labels, switches, and devices in the cabinet. Conveniently locate the fixtures so as not to interfere with a technician’s ability to perform work on any devices or terminals in the cabinet. Provide a protective diffuser to cover exposed bulbs. Install 16 watt T-4 lamps in the fluorescent fixtures. Provide a door switch to provide power to each fixture when the respective door is open. Wire the fluorescent fixtures to the 15 amp ECB (equipment circuit breaker).

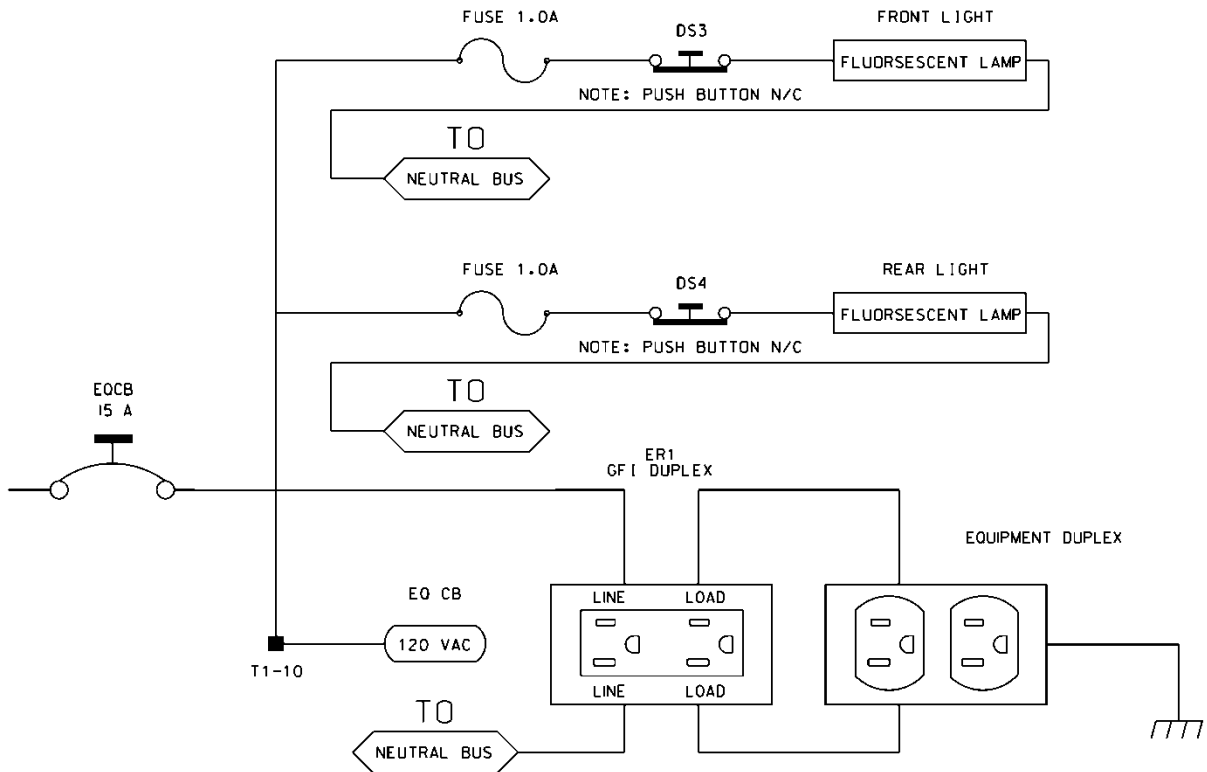

Furnish a police panel with a police panel door. For model 336S cabinets, mount the police panel on the rear door. Ensure that the police panel door permits access to the police panel when the main door is closed. Ensure that no rainwater can enter the cabinet even with the police panel door open. Provide a police panel door hinged on the right side as viewed from the front. Provide a police panel

door lock that is keyed to a standard police/fire call box key. In addition to the requirements of LA Specification No. 54-053-08, provide the police panel with a toggle switch connected to switch the intersection operation between normal stop-and-go operation (AUTO) and manual operation (MANUAL). Ensure that manual control can be implemented using inputs and software such that the controller provides full programmed clearance times for the yellow clearance and red clearance for each phase while under manual control.

Provide a 1/4-inch locking phone jack in the police panel for a hand control to manually control the intersection. Provide sufficient room in the police panel for storage of a hand control and cord.

Ensure the 336S cabinet Input File is wired as follows:

336S Cabinet														
Port-Bit/C-1 Pin Assignment														
Slot #	1	2	3	4	5	6	7	8	9	10	11	12	13	14
C-1 (Spares)	59	60	61	62	63	64	65	66	75	76	77	78	79	80
Port C-1	3-2	1-1	3-4	1-3	3-1	1-2	3-3	1-4	2-5	5-5	5-6	5-1	5-2	6-7
C-1	56	39	58	41	55	40	57	42	51	71	72	67	68	81
Port C-1	2-1	1-5	2-3	1-7	2-2	1-6	2-4	1-8	2-6	5-7	5-8	5-3	5-4	6-8
C-1	47	43	49	45	48	44	50	46	52	73	74	69	70	82

For model 332 base mounted cabinets, ensure terminals J14-E and J14-K are wired together on the rear of the Input File. Connect TB9-12 (J14 Common) on the Input Panel to T1-2 (AC-) on the rear of the PDA.

Provide detector test switches mounted at the top of the cabinet rack or other convenient location which may be used to place a call on each of eight phases based on the chart below. Provide three positions for each switch: On (place call), Off (normal detector operation), and Momentary On (place momentary call and return to normal detector operation after switch is released). Ensure that the switches are located such that the technician can read the controller display and observe the intersection.

Connect detector test switches for cabinets as follows:

336S Cabinet		332 Cabinet	
Detector Call Switches	Terminals	Detector Call Switches	Terminals
Phase 1	I1-F	Phase 1	I1-W
Phase 2	I2-F	Phase 2	I4-W
Phase 3	I3-F	Phase 3	I5-W
Phase 4	I4-F	Phase 4	I8-W
Phase 5	I5-F	Phase 5	J1-W
Phase 6	I6-F	Phase 6	J4-W
Phase 7	I7-F	Phase 7	J5-W
Phase 8	I8-F	Phase 8	J8-W

Provide the PCB 28/56 connector for the conflict monitor unit (CMU) with 28 independent contacts per side, dual-sided with 0.156 inch contact centers. Provide the PCB 28/56 connector contacts with solder eyelet terminations. Ensure all connections to the PCB 28/56 connector are soldered to the solder eyelet terminations.

Ensure that all cabinets have the CMU connector wired according to the 332 cabinet connector pin assignments (include all wires for auxiliary output file connection). Wire pins 13, 16, R, and U of the CMU connector to a separate 4 pin plug, P1, as shown below. Provide a second plug, P2, which will mate with P1 and is wired to the auxiliary output file as shown below. Provide an additional plug, P3, which will mate with P1 and is wired to the pedestrian yellow circuits as shown below. When no auxiliary output file is installed in the cabinet, provide wires for the green and yellow inputs for channels 11, 12, 17, and 18, the red inputs for channels 17 and 18, and the wires for the P2 plug. Terminate the two-foot wires with ring type lugs, insulated, and bundled for optional use.

PIN	P1		P2		P3	
	FUNCTION	CONN TO	FUNCTION	CONN TO	FUNCTION	CONN TO
1	CH-9G	CMU-13	OLA-GRN	A123	2P-YEL	114
2	CH-9Y	CMU-16	OLA-YEL	A122	4P-YEL	105
3	CH-10G	CMU-R	OLB-GRN	A126	6P-YEL	120
4	CH-10Y	CMU-U	OLB-YEL	A125	8P-YEL	111

Do not provide the P20 terminal assembly (red monitor board) or red interface ribbon cable as specified in LA Specification No. 54-053-08.

Provide a P20 connector that mates with and is compatible with the red interface connector mounted on the front of the conflict monitor. Ensure that the P20 connector and the red interface connector on the conflict monitor are center polarized to ensure proper connection. Ensure that removal of the P20 connector will cause the conflict monitor to recognize a latching fault condition and place the cabinet into flashing operation.

Wire the P20 connector to the output file and auxiliary output file using 22 AWG stranded wires. Ensure the length of these wires is a minimum of 42 inches in length. Provide a durable braided sleeve around the wires to organize and protect the wires.

Wire the P20 connector to the traffic signal red displays to provide inputs to the conflict monitor as shown below. Ensure the pedestrian Don't Walk circuits are wired to channels 13 through 16 of the P20 connector. When no auxiliary output file is installed in the cabinet, provide wires for channels 9 through 12 reds. Provide a wire for special function 1. Terminate the unused wires with ring type lugs, insulated, and bundled for optional use.

P20 Connector					
PIN	FUNCTION	CONN TO	PIN	FUNCTION	CONN TO
1	Channel 15 Red	119	2	Channel 16 Red	110
3	Channel 14 Red	104	4	Chassis GND	01-9



5	Channel 13 Red	113	6	N/C	
7	Channel 12 Red	AUX 101	8	Spec Function 1	
9	Channel 10 Red	AUX 124	10	Channel 11 Red	AUX 114
11	Channel 9 Red	AUX 121	12	Channel 8 Red	107
13	Channel 7 Red	122	14	Channel 6 Red	134
15	Channel 5 Red	131	16	Channel 4 Red	101
17	Channel 3 Red	116	18	Channel 2 Red	128
19	Channel 1 Red	125	20	Red Enable	01-14

Ensure the controller unit outputs to the auxiliary output file are pre-wired to the C5 connector. When no auxiliary output file is installed in the cabinet, connect the C5 connector to a storage socket located on the Input Panel or on the rear of the PDA.

Do not wire pin 12 of the load switch sockets.

In addition to the requirements of LA Specification No. 54-053-08, ensure relay K1 on the Power Distribution Assembly (PDA) is a four pole relay and K2 on the PDA is a two pole relay.

Provide a two pole, ganged circuit breaker for the flash bus circuit. Ensure the flash bus circuit breaker is an inverse time circuit breaker rated for 10 amps at 120 VAC with a minimum of 10,000 RMS symmetrical amperes short circuit current rating. Do not provide the auxiliary switch feature on the flash bus circuit breaker. Ensure the ganged flash bus circuit breaker is certified by the circuit breaker manufacturer to provide gang tripping operation.

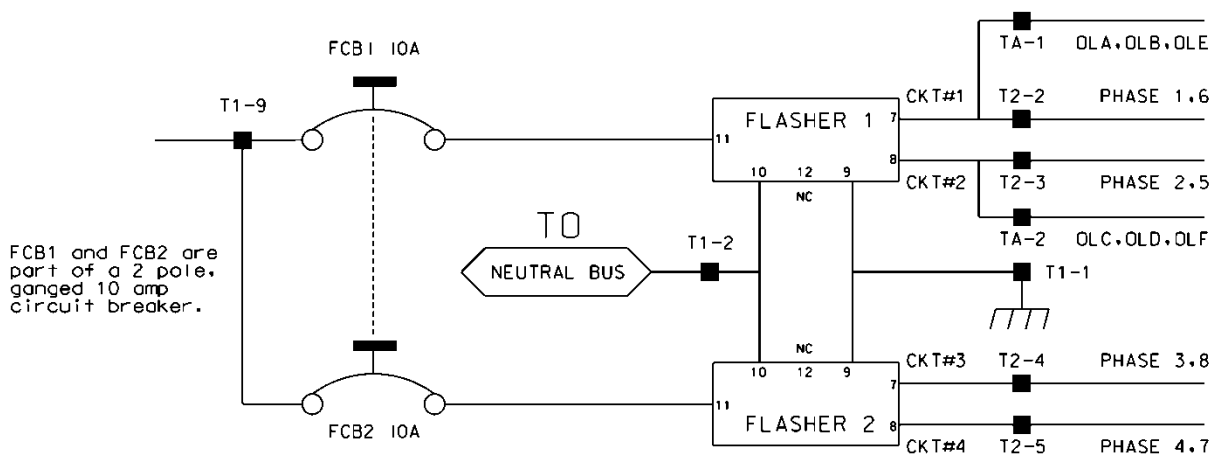

Ensure auxiliary output files are wired as follows:

AUXILIARY OUTPUT FILE TERMINAL BLOCK TA ASSIGNMENTS	
POSITION	FUNCTION
1	Flasher Unit #1, Circuit 1/FTR1 (OLA, OLB)/FTR3 (OLE)
2	Flasher Unit #1, Circuit 2/FTR2 (OLC, OLD)/FTR3 (OLF)
3	Flash Transfer Relay Coils
4	AC -
5	Power Circuit 5
6	Power Circuit 5
7	Equipment Ground Bus
8	NC

Provide four spare load resistors mounted in each cabinet. Ensure each load resistor is rated as shown in the table below. Wire one side of each load resistor to AC-. Connect the other side of each resistor to a separate terminal on a four (4) position terminal block. Mount the load resistors and terminal block either inside the back of Output File No. 1 or on the upper area of the Service Panel.

ACCEPTABLE LOAD RESISTOR VALUES	
VALUE (ohms)	WATTAGE
1.5K – 1.9 K	25W (min)
2.0K – 3.0K	10W (min)

Provide Model 200 load switches, Model 204 flashers, Model 242 DC isolators, Model 252 AC isolators, and Model 206L power supply units that conform to CALTRANS' "Transportation Electrical Equipment Specifications" dated March 12, 2009 with Erratum 1.

### C. Type 170 E Cabinet Physical Requirements:

Do not mold, cast, or scribe the name "City of Los Angeles" on the outside of the cabinet door as specified in LA Specification No. 54-053-08. Do not provide a Communications Terminal Panel as specified in LA Specification No. 54-053-08. Do not provide terminal block TBB on the Service Panel. Do not provide Cabinet Verification Test Program software or associated test jigs as specified in LA Specification No. 54-053-08.

Furnish unpainted, natural, aluminum cabinet shells. Ensure that all non-aluminum hardware on the cabinet is stainless steel or a Department approved non-corrosive alternate.

Ensure the lifting eyes, gasket channels, police panel, and all supports welded to the enclosure and doors are fabricated from 0.125 inch minimum thickness aluminum sheet and meet the same standards as the cabinet and doors.

Provide front and rear doors with latching handles that allow padlocking in the closed position. Furnish 0.75 inch minimum diameter stainless steel handles with a minimum 0.5 inch shank. Place

the padlocking attachment at 4.0 inches from the handle shank center to clear the lock and key. Provide an additional 4.0 inches minimum gripping length.

Provide Corbin #2 locks on the front and rear doors. Provide one (1) Corbin #2 and one (1) police master key with each cabinet. Ensure main door locks allow removal of keys in the locked position only.

Provide a surge protection panel with 16 loop surge protection devices and designed to allow sufficient free space for wire connection/disconnection and surge protection device replacement. For model 332 cabinets, provide an additional 20 loop surge protection devices. Provide an additional two AC+ interconnect surge devices to protect one slot and eight DC surge protection devices to protect four slots. Provide no protection devices on slot I14.

For pole mounted cabinets, mount surge protection devices for the AC+ interconnect inputs, inductive loop detector inputs, and low voltage DC inputs on a swing down panel assembly fabricated from sturdy aluminum. Attach the swing down panel to the bottom rear cabinet rack assembly using thumb screws. Ensure the swing down panel allows for easy removal of the input file without removing the surge protection panel assembly or its parts. Have the surge protection devices mounted horizontally on the panel and soldered to the feed through terminals of four 14 position terminal blocks with #8 screws mounted on the other side. Ensure the top row of terminals is connected to the upper slots and the bottom row of terminals is connected to the bottom slots. Provide a 15 position copper equipment ground bus attached to the field terminal side (outside) of the swing down panel for termination of loop lead-in shield grounds. Ensure that a Number 4 AWG green wire connects the surge protection panel assembly ground bus to the main cabinet equipment ground.

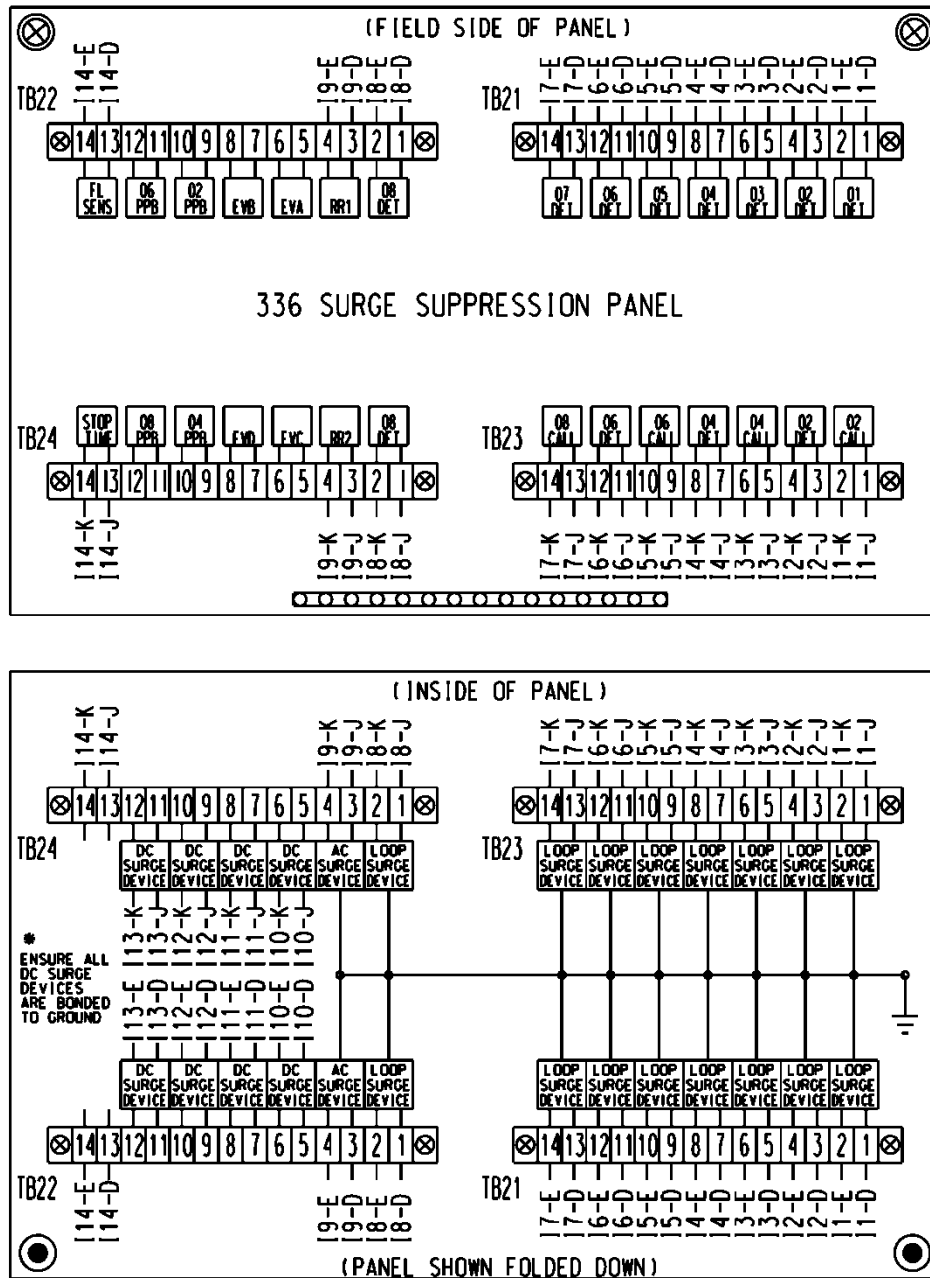

For base mounted cabinets, mount surge protection panels on the left side of the cabinet as viewed from the rear. Attach each panel to the cabinet rack assembly using bolts and make it easily removable. Mount the surge protection devices in vertical rows on each panel and connect the devices to one side of 12 position, double row terminal blocks with #8 screws. For each surge protection panel, terminate all grounds from the surge protection devices on a copper equipment ground bus attached to the surge protection panel. Wire the terminals to the rear of a standard input file using spade lugs for input file protection.

Provide permanent labels that indicate the slot and the pins connected to each terminal that may be viewed from the rear cabinet door. Label and orient terminals so that each pair of inputs is next to each other. Indicate on the labeling the input file (I or J), the slot number (1-14) and the terminal pins of the input slots (either D & E for upper or J & K for lower).

Provide a minimum 14 x 16 inch pull out, hinged top shelf located immediately below controller mounting section of the cabinet. Ensure the shelf is designed to fully expose the table surface outside the controller at a height approximately even with the bottom of the controller. Ensure the shelf has a storage bin interior which is a minimum of 1 inch deep and approximately the same dimensions as the shelf. Provide an access to the storage area by lifting the hinged top of the shelf. Fabricate the shelf and slide from aluminum or stainless steel and ensure the assembly can support the 2070L controller plus 15 pounds of additional weight. Ensure shelf has a locking mechanism to secure it in the fully extended position and does not inhibit the removal of the 2070L controller or removal of cards inside the controller when fully extended. Provide a locking mechanism that is easily released when the shelf is to be returned to its non-use position directly under the controller.

#### **D. Model 2018 Enhanced Conflict Monitor:**

Furnish Model 2018 Enhanced Conflict Monitors that provide monitoring of 18 channels. Ensure each channel consists of a green, yellow, and red field signal input. Ensure that the conflict monitor meets or exceeds CALTRANS' Transportation Electrical Equipment Specifications dated March 12, 2009, with Erratum 1 (hereafter referred to as CALTRANS' 2009 TEES) for a model 210 monitor unit and other requirements stated in this specification.

Ensure the conflict monitor is provided with an 18 channel conflict programming card. Pin EE and Pin T of the conflict programming card shall be connected together. Pin 16 of the conflict programming card shall be floating. Ensure that the absence of the conflict programming card will cause the conflict monitor to trigger (enter into fault mode), and remain in the triggered state until the programming card is properly inserted and the conflict monitor is reset.

Provide a conflict monitor that incorporates LED indicators into the front panel to dynamically display the status of the monitor under normal conditions and to provide a comprehensive review of field inputs with monitor status under fault conditions. Ensure that the monitor indicates the channels that were active during a conflict condition and the channels that experienced a failure for all other per channel fault conditions detected. Ensure that these indications and the status of each channel are retained until the Conflict Monitor is reset. Furnish LED indicators for the following:

- AC Power (Green LED indicator)
- VDC Failed (Red LED indicator)
- WDT Error (Red LED indicator)
- Conflict (Red LED indicator)
- Red Fail (Red LED indicator)
- Dual Indication (Red LED indicator)
- Yellow/Clearance Failure (Red LED indicator)
- PCA/PC Ajar (Red LED indicator)
- Monitor Fail/Diagnostic Failure (Red LED indicator)
- 54 Channel Status Indicators (1 Red, 1 Yellow, and 1 Green LED indicator for each of the 18 channels)

Provide a switch to set the Red Fail fault timing. Ensure that when the switch is in the ON position the Red Fail fault timing value is set to 1350 +/- 150 ms (2018 mode). Ensure that when the switch is in the OFF position the Red Fail fault timing value is set to 850 +/- 150 ms (210 mode).

Provide a switch to set the Watchdog fault timing. Ensure that when the switch is in the ON position the Watchdog fault timing value is set to 1.0 +/- 0.1 s (2018 mode). Ensure that when the switch is in the OFF position the Watchdog fault timing value is set to 1.5 +/- 0.1 s (210 mode).

Provide a jumper or switch to set the AC line brown-out levels. Ensure that when the jumper is present or the switch is in the ON position the AC line dropout voltage threshold is 98 +/- 2 Vrms, the AC line restore voltage threshold is 103 +/- 2 Vrms, and the AC line brown-out timing value is set to 400 +/- 50ms (2018 mode). Ensure that when the jumper is not present or the switch is in the OFF position the AC line dropout voltage threshold is 92 +/- 2 Vrms, the AC line restore voltage threshold is 98 +/- 2 Vrms, and the AC line brown-out timing value is set to 80 +/- 17 ms (210 mode).

Provide a jumper or switch that will enable and disable the Watchdog Latch function. Ensure that when the jumper is not present or the switch is in the OFF position the Watchdog Latch function is disabled. In this mode of operation, a Watchdog fault will be reset following a power loss, brownout, or power interruption. Ensure that when the jumper is present or the switch is in the ON position the Watchdog Latch function is enabled. In this mode of operation, a Watchdog fault will be retained until a Reset command is issued.

Provide a jumper that will reverse the active polarity for pin #EE (output relay common). Ensure that when the jumper is not present pin #EE (output relay common) will be considered 'Active' at a voltage greater than 70 Vrms and 'Not Active' at a voltage less than 50 Vrms (Caltrans mode). Ensure that when the jumper is present pin #EE (output relay common) will be considered 'Active' at a voltage less than 50 Vrms and 'Not Active' at a voltage greater than 70 Vrms (Failsafe mode).

In addition to the connectors required by CALTRANS' 2009 TEES, provide the conflict monitor with a red interface connector mounted on the front of the monitor. Ensure the connector is a 20 pin, right angle, center polarized, male connector with latching clip locks and polarizing keys. Ensure the right angle solder tails are designed for a 0.062" thick printed circuit board. Keying of the connector shall be between pins 3 and 5, and between 17 and 19. Ensure the connector has two rows of pins with the odd numbered pins on one row and the even pins on the other row. Ensure the connector pin row spacing is 0.10" and pitch is 0.10". Ensure the mating length of the connector pins is 0.24". Ensure the pins are finished with gold plating 30μ" thick.

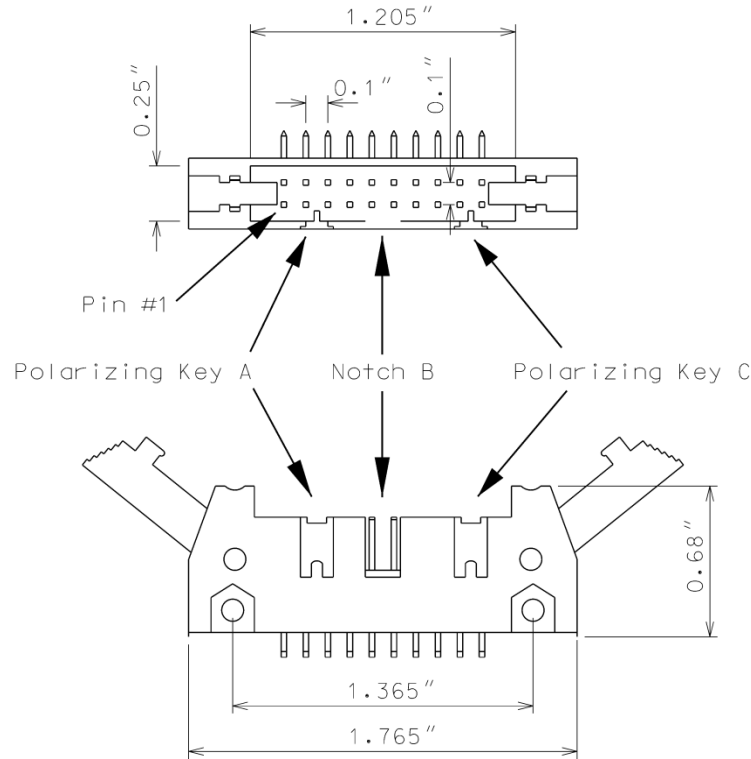

Ensure the red interface connector pins on the monitor have the following functions:

Pin #	Function	Pin #	Function
1	Channel 15 Red	2	Channel 16 Red
3	Channel 14 Red	4	Chassis Ground
5	Channel 13 Red	6	Special Function 2
7	Channel 12 Red	8	Special Function 1
9	Channel 10 Red	10	Channel 11 Red
11	Channel 9 Red	12	Channel 8 Red
13	Channel 7 Red	14	Channel 6 Red
15	Channel 5 Red	16	Channel 4 Red
17	Channel 3 Red	18	Channel 2 Red
19	Channel 1 Red	20	Red Enable

Ensure that removal of the P20 cable connector will cause the conflict monitor to recognize a latching fault condition and place the cabinet into flashing operation.

Provide Special Function 1 and Special Function 2 inputs to the unit which shall disable only Red Fail Monitoring when either input is sensed active. A Special Function input shall be sensed active when the input voltage exceeds 70 Vrms with a minimum duration of 550 ms. A Special Function input shall be sensed not active when the input voltage is less than 50 Vrms or the duration is less

than 250 ms. A Special Function input is undefined by these specifications and may or may not be sensed active when the input voltage is between 50 Vrms and 70 Vrms or the duration is between 250 ms and 550 ms.

Ensure the conflict monitor recognizes field signal inputs for each channel that meet the following requirements:

- consider a Red input greater than 70 Vrms and with a duration of at least 500 ms as an “on” condition;
- consider a Red input less than 50 Vrms or with a duration of less than 200 ms as an “off” condition (no valid signal);
- consider a Red input between 50 Vrms and 70 Vrms or with a duration between 200 ms and 500 ms to be undefined by these specifications;
- consider a Green or Yellow input greater than 25 Vrms and with a duration of at least 500 ms as an “on” condition;
- consider a Green or Yellow input less than 15 Vrms or with a duration of less than 200 ms as an “off” condition; and
- consider a Green or Yellow input between 15 Vrms and 25 Vrms or with a duration between 200 ms and 500 ms to be undefined by these specifications.

Provide a conflict monitor that recognizes the faults specified by CALTRANS’ 2009 TEES and the following additional faults. Ensure the conflict monitor will trigger upon detection of a fault and will remain in the triggered (in fault mode) state until the unit is reset at the front panel or through the external remote reset input for the following failures:

1. **Red Monitoring or Absence of Any Indication (Red Failure):** A condition in which no “on” voltage signal is detected on any of the green, yellow, or red inputs to a given monitor channel. If a signal is not detected on at least one input (R, Y, or G) of a conflict monitor channel for a period greater than 1000 ms when used with a 170 controller and 1500 ms when used with a 2070 controller, ensure monitor will trigger and put the intersection into flash. If the absence of any indication condition lasts less than 700 ms when used with a 170 controller and 1200 ms when used with a 2070 controller, ensure conflict monitor will not trigger. Red fail monitoring shall be enabled on a per channel basis by the use of switches located on the conflict monitor. Have red monitoring occur when all of the following input conditions are in effect:
  - a) Red Enable input to monitor is active (Red Enable voltages are “on” at greater than 70 Vrms, off at less than 50 Vrms, undefined between 50 and 70 Vrms), and
  - b) Neither Special Function 1 nor Special Function 2 inputs are active.
  - c) Pin #EE (output relay common) is not active
2. **Short/Missing Yellow Indication Fault (Clearance Error):** Yellow indication following a green is missing or shorter than 2.7 seconds (with  $\pm 0.1$ -second accuracy). If a channel fails to detect an “on” signal at the Yellow input for a minimum of 2.7 seconds ( $\pm 0.1$  second) following the detection of an “on” signal at a Green input for that channel, ensure that the monitor triggers and generates a clearance/short yellow error fault indication. Short/missing



yellow (clearance) monitoring shall be enabled on a per channel basis by the use of switches located on the conflict monitor. This fault shall not occur when the channel is programmed for Yellow Inhibit, when the Red Enable signal is inactive or pin #EE (output relay common) is active.

3. **Dual Indications on the Same Channel:** In this condition, more than one indication (R,Y,G) is detected as “on” at the same time on the same channel. If dual indications are detected for a period greater than 500 ms, ensure that the conflict monitor triggers and displays the proper failure indication (Dual Ind fault). If this condition is detected for less than 200 ms, ensure that the monitor does not trigger. G-Y-R dual indication monitoring shall be enabled on a per channel basis by the use of switches located on the conflict monitor. G-Y dual indication monitoring shall be enabled for all channels by use of a switch located on the conflict monitor. This fault shall not occur when the Red Enable signal is inactive or pin #EE (output relay common) is active.
4. **Configuration Settings Change:** The configuration settings are comprised of (as a minimum) the permissive diode matrix, dual indication switches, yellow disable jumpers, any option switches, any option jumpers, and the Watchdog Enable switch. Ensure the conflict monitor compares the current configuration settings with the previous stored configuration settings on power-up, on reset, and periodically during operation. If any of the configuration settings are changed, ensure that the conflict monitor triggers and causes the program card indicator to flash. Ensure that configuration change faults are only reset by depressing and holding the front panel reset button for a minimum of three seconds. Ensure the external remote reset input does not reset configuration change faults.

Ensure the conflict monitor will trigger and the AC Power indicator will flash at a rate of  $2 \text{ Hz} \pm 20\%$  with a 50% duty cycle when the AC Line voltage falls below the “drop-out” level. Ensure the conflict monitor will resume normal operation when the AC Line voltage returns above the “restore” level. Ensure the AC Power indicator will remain illuminated when the AC voltage returns above the “restore” level. Should an AC Line power interruption occur while the monitor is in the fault mode, then upon restoration of AC Line power, the monitor will remain in the fault mode and the correct fault and channel indicators will be displayed.

Provide a flash interval of at least 6 seconds and at most 10 seconds in duration following a power-up, an AC Line interruption, or a brownout restore. Ensure the conflict monitor will suspend all fault monitoring functions, close the Output relay contacts, and flash the AC indicator at a rate of  $4 \text{ Hz} \pm 20\%$  with a 50% duty cycle during this interval. Ensure the termination of the flash interval after at least 6 seconds if the Watchdog input has made 5 transitions between the True and False state and the AC Line voltage is greater than the “restore” level. If the watchdog input has not made 5 transitions between the True and False state within  $10 \pm 0.5$  seconds, the monitor shall enter a WDT error fault condition.

Ensure the conflict monitor will monitor an intersection with a minimum of four approaches using the four-section Flashing Yellow Arrow (FYA) vehicle traffic signal as outlined by the NCHRP 3-54 research project for protected-permissive left turn signal displays. Ensure the conflict monitor will operate in the FYA mode and FYAc (Compact) mode as specified below to monitor each channel pair for the following fault conditions: Conflict, Flash Rate Detection, Red Fail, Dual Indication, and

Clearance. Provide a switch to select between the FYA mode and FYAc mode. Provide a switch to select each FYA phase movement for monitoring.

#### FYA mode

FYA Signal Head	Phase 1	Phase 3	Phase 5	Phase 7
Red Arrow	Channel 9 Red	Channel 10 Red	Channel 11 Red	Channel 12 Red
Yellow Arrow	Channel 9 Yellow	Channel 10 Yellow	Channel 11 Yellow	Channel 12 Yellow
Flashing Yellow Arrow	Channel 9 Green	Channel 10 Green	Channel 11 Green	Channel 12 Green
Green Arrow	Channel 1 Green	Channel 3 Green	Channel 5 Green	Channel 7 Green

#### FYAc mode

FYA Signal Head	Phase 1	Phase 3	Phase 5	Phase 7
Red Arrow	Channel 1 Red	Channel 3 Red	Channel 5 Red	Channel 7 Red
Yellow Arrow	Channel 1 Yellow	Channel 3 Yellow	Channel 5 Yellow	Channel 7 Yellow
Flashing Yellow Arrow	Channel 1 Green	Channel 3 Green	Channel 5 Green	Channel 7 Green
Green Arrow	Channel 9 Green	Channel 9 Yellow	Channel 10 Green	Channel 10 Yellow

If a FYA channel pair is enabled for FYA operation, the conflict monitor will monitor the FYA logical channel pair for the additional following conditions:

1. **Conflict:** Channel conflicts are detected based on the permissive programming jumpers on the program card. This operation remains unchanged from normal operation except for the solid Yellow arrow (FYA clearance) signal.
2. **Yellow Change Interval Conflict:** During the Yellow change interval of the Permissive Turn channel (flashing Yellow arrow) the conflict monitor shall verify that no conflicting channels to the solid Yellow arrow channel (clearance) are active. These conflicting channels shall be determined by the program card compatibility programming of the Permissive Turn channel (flashing Yellow arrow). During the Yellow change interval of the Protected Turn channel (solid Green arrow) the conflict monitor shall verify that no conflicting channels to the solid Yellow arrow channel (clearance) are active as determined by the program card compatibility programming of the Protected Turn channel (solid Green arrow).

3. **Flash Rate Detection:** The conflict monitor unit shall monitor for the absence of a valid flash rate for the Permissive turn channel (flashing Yellow arrow). If the Permissive turn channel (flashing Yellow arrow) is active for a period greater than 1600 milliseconds, ensure the conflict monitor triggers and puts the intersection into flash. If the Permissive turn channel (flashing Yellow arrow) is active for a period less than 1400 milliseconds, ensure the conflict monitor does not trigger. Ensure the conflict monitor will remain in the triggered (in fault mode) state until the unit is reset at the front panel or through the external remote reset input. Provide a jumper or switch that will enable and disable the Flash Rate Detection function. Ensure that when the jumper is not present or the switch is in the OFF position the Flash Rate Detection function is enabled. Ensure that when the jumper is present or the switch is in the ON position the Flash Rate Detection function is disabled.
4. **Red Monitoring or Absence of Any Indication (Red Failure):** The conflict monitor unit shall detect a red failure if there is an absence of voltage on all four of the inputs of a FYA channel pair (RA, YA, FYA, GA).
5. **Dual Indications on the Same Channel:** The conflict monitor unit shall detect a dual indication if two or more inputs of a FYA channel pair (RA, YA, FYA, GA) are “on” at the same time.
6. **Short/Missing Yellow Indication Fault (Clearance Error):** The conflict monitor unit shall monitor the solid Yellow arrow for a clearance fault when terminating both the Protected Turn channel (solid Green arrow) interval and the Permissive Turn channel (flashing Yellow arrow) interval.

Ensure that the conflict monitor will log at least nine of the most recent events detected by the monitor in non-volatile EEPROM memory (or equivalent). For each event, record at a minimum the time, date, type of event, status of each field signal indication with RMS voltage, and specific channels involved with the event. Ensure the conflict monitor will log the following events: monitor reset, configuration, previous fault, and AC line. Furnish the signal sequence log that shows all channel states (Greens, Yellows, and Reds) and the Red Enable State for a minimum of 2 seconds prior to the current fault trigger point. Ensure the display resolution of the inputs for the signal sequence log is not greater than 50 ms.

For conflict monitors used within an Ethernet communications system, provide a conflict monitor with an Ethernet 10/100 Mbps, RJ-45 port for data communication access to the monitor by a local notebook computer and remotely via a workstation or notebook computer device connected to the signal system local area network. The Ethernet port shall be electrically isolated from the conflict monitor’s electronics and shall provide a minimum of 1500 Vrms isolation. Integrate monitor with Ethernet network in cabinet. Provide software to retrieve the time and date from a network server in order to synchronize the on-board times between the conflict monitor and the controller. Furnish and install the following Windows based, graphic user interface software on workstations and notebook computers where the signal system client software is installed: 1) software to view and retrieve all event log information, 2) software that will search and display a list of conflict monitor IP addresses and IDs on the network, and 3) software to change the conflict monitor’s network parameters such as IP address and subnet mask.

For non-Ethernet connected monitors, provide a RS-232C/D compliant port (DB-9 female connector) on the front panel of the conflict monitor in order to provide communications from the conflict monitor to the 170/2070 controller or to a Department-furnished laptop computer. Electrically isolate the port interface electronics from all monitor electronics, excluding Chassis Ground. Ensure that the controller can receive all event log information through a controller

Asynchronous Communications Interface Adapter (Type 170E) or Async Serial Comm Module (2070). Furnish and connect a serial cable from the conflict monitor's DB-9 connector to Comm Port 1 of the 2070 controller. Ensure conflict monitor communicates with the controller. Provide a Windows based graphic user interface software to communicate directly through the same monitor RS-232C/D compliant port to retrieve and view all event log information to a Department-furnished laptop computer. The RS-232C/D compliant port on the monitor shall allow the monitor to function as a DCE device with pin connections as follows:

<b>Conflict Monitor RS-232C/D (DB-9 Female) Pinout</b>		
<b>Pin Number</b>	<b>Function</b>	<b>I/O</b>
1	DCD	O
2	TX Data	O
3	RX Data	I
4	DTR	I
5	Ground	-
6	DSR	O
7	CTS	I
8	RTS	O
9	NC	-

---

**MONITOR BOARD EDGE CONNECTOR**

---

<b>Pin #</b>	<b>Function (Back Side)</b>	<b>Pin #</b>	<b>Function (Component Side)</b>
1	Channel 2 Green	A	Channel 2 Yellow
2	Channel 13 Green	B	Channel 6 Green
3	Channel 6 Yellow	C	Channel 15 Green
4	Channel 4 Green	D	Channel 4 Yellow
5	Channel 14 Green	E	Channel 8 Green
6	Channel 8 Yellow	F	Channel 16 Green
7	Channel 5 Green	H	Channel 5 Yellow
8	Channel 13 Yellow	J	Channel 1 Green
9	Channel 1 Yellow	K	Channel 15 Yellow
10	Channel 7 Green	L	Channel 7 Yellow
11	Channel 14 Yellow	M	Channel 3 Green
12	Channel 3 Yellow	N	Channel 16 Yellow
13	Channel 9 Green	P	Channel 17 Yellow
14	Channel 17 Green	R	Channel 10 Green
15	Channel 11 Yellow	S	Channel 11 Green
16	Channel 9 Yellow	T	Channel 18 Yellow
17	Channel 18 Green	U	Channel 10 Yellow
--		--	
18	Channel 12 Yellow	V	Channel 12 Green
19	Channel 17 Red	W	Channel 18 Red
20	Chassis Ground	X	Not Assigned
21	AC-	Y	DC Common
22	Watchdog Timer	Z	External Test Reset
23	+24VDC	AA	+24VDC
24	Tied to Pin 25	BB	Stop Time (Output)
25	Tied to Pin 24	CC	Not Assigned
26	Not Assigned	DD	Not Assigned
27	Relay Output, Side #3, N.O.	EE	Relay Output, Side #2, Common
28	Relay Output, Side #1, N.C.	FF	AC+

-- Slotted for keying between Pins 17/U and 18/V

---

**CONFLICT PROGRAM CARD PIN ASSIGNMENTS**

---

<b>Pin #</b>	<b>Function (Back Side)</b>	<b>Pin #</b>	<b>Function (Component Side)</b>
1	Channel 2 Green	A	Channel 1 Green
2	Channel 3 Green	B	Channel 2 Green
3	Channel 4 Green	C	Channel 3 Green
4	Channel 5 Green	D	Channel 4 Green
5	Channel 6 Green	E	Channel 5 Green
6	Channel 7 Green	F	Channel 6 Green
7	Channel 8 Green	H	Channel 7 Green
8	Channel 9 Green	J	Channel 8 Green
9	Channel 10 Green	K	Channel 9 Green
10	Channel 11 Green	L	Channel 10 Green
11	Channel 12 Green	M	Channel 11 Green
12	Channel 13 Green	N	Channel 12 Green
13	Channel 14 Green	P	Channel 13 Green
14	Channel 15 Green	R	Channel 14 Green
15	Channel 16 Green	S	Channel 15 Green
16	N/C	T	PC AJAR
17	Channel 1 Yellow	U	Channel 9 Yellow
18	Channel 2 Yellow	V	Channel 10 Yellow
19	Channel 3 Yellow	W	Channel 11 Yellow
20	Channel 4 Yellow	X	Channel 12 Yellow
21	Channel 5 Yellow	Y	Channel 13 Yellow
22	Channel 6 Yellow	Z	Channel 14 Yellow
23	Channel 7 Yellow	AA	Channel 15 Yellow
24	Channel 8 Yellow	BB	Channel 16 Yellow
--		--	
25	Channel 17 Green	CC	Channel 17 Yellow
26	Channel 18 Green	DD	Channel 18 Yellow
27	Channel 16 Green	EE	PC AJAR (Program Card)
28	Yellow Inhibit Common	FF	Channel 17 Green

-- Slotted for keying between Pins 24/BB and 25/CC

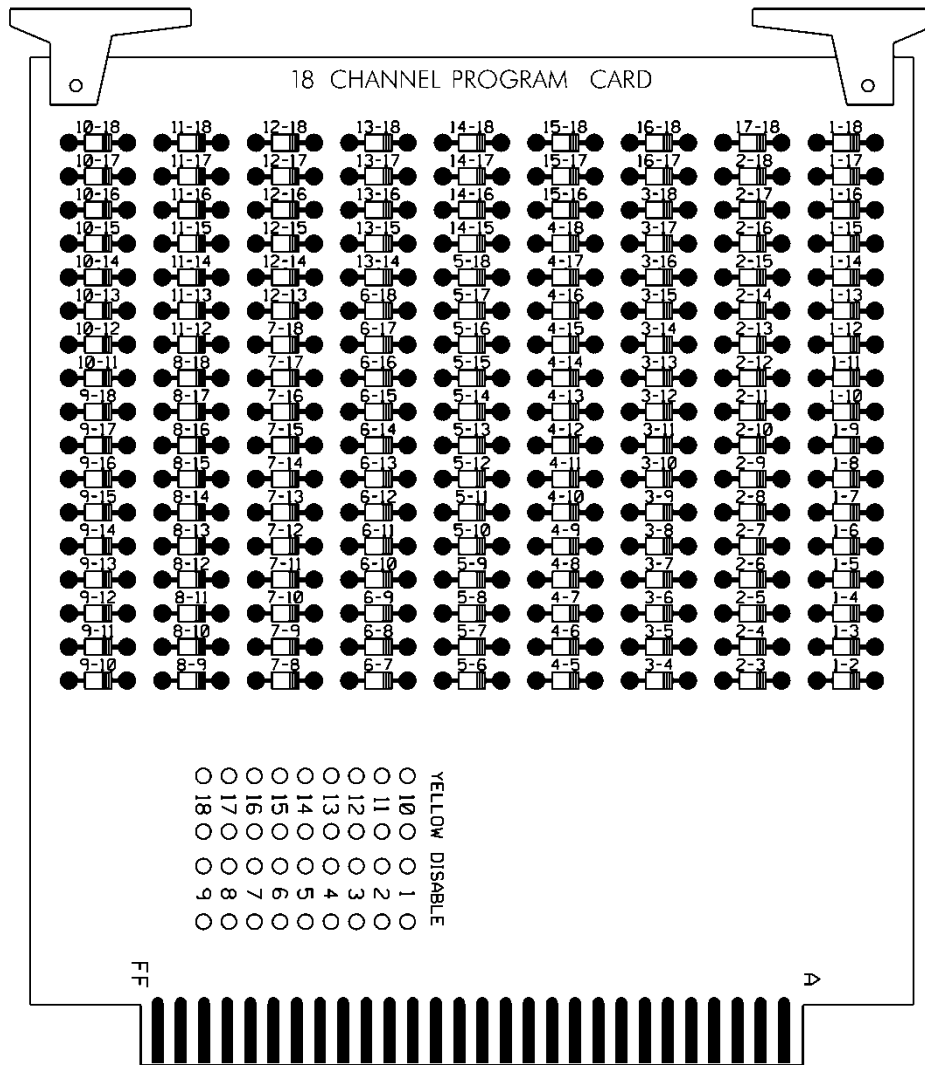

**E. Preemption and Sign Control Box**

Provide preemption and sign control box to operate in a Model 332 and Model 336S cabinet. Provide hardware to mount the box to the cage of the cabinet to ensure the front side is facing the opposite side of the cabinet. Furnish the material of the box from a durable finished metallic or thermoplastic case. Ensure the size of the box is not greater than 7(l) x 5(w) x 5(d) inches. Ensure that no modification is necessary to mount the box on the cabinet cage.

Provide the following components in the preemption and sign control box: relays, fuses, terminal blocks, MOVs, resistor, RC network, lamp, and push button switch.

Provide UL Listed or Recognized relay K1 as a DPDT enclosed relay (120 VAC, 60 Hz coil) with an 8-pin octal-style plug and associated octal base. Provide contact material made of AgCdO with a 10 amp, 240 VAC rating. Ensure the relay has a specified pickup voltage of 102 VAC.

Provide relay SSR1 as a Triac SPST normally open solid state relay that is rated for 120 VAC input and zero-crossing (resistive load) 25 amp @ 120 VAC output. Ensure the relay turns on at 90 Vrms within 10 ms and turns off at 10 Vrms within 40 ms. Ensure the relay has physical

characteristics as shown in the wiring detail in Figure 1. Provide 4 terminal screws with saddle clamps.

Provide fuses F1 and F2 as a UL Listed ¼" x 1-1/4" glass tube rated at 250 volts with a 10kA interrupting rating. Ensure F1 non-delay (fast-acting) and F2 slow-blow (time-delay) fuses have a maximum opening times of 60 minutes and 120 seconds for currents of 135 and 200 percent of the ampere rating, respectively. Ensure F2 slow-blow (time-delay) fuses have a minimum opening times of 12 seconds at 200 percent of the ampere rating. Provide fuse holders that are UL Recognized panel-mounted holders rated 250V, 15 ampere minimum with bayonet-type knobs which accept ¼" x 1-1/4" glass tube fuses.

Provide terminal blocks that are rated for 300V and are made of electrical grade thermoplastic or thermosetting plastic. Ensure each terminal block is of closed back design and has recessed-screw terminals with molded barriers between terminals. Ensure each terminal block is labeled with a block designation. Ensure each terminal is labeled with the function and a number.

Provide 3/4-inch diameter radial lead UL-recognized metal oxide varistors (MOVs) that have electrical performance as outlined below.

PROPERTIES OF MOV SURGE PROTECTOR	
Maximum Continuous Applied Voltage at 185° F	150 VAC (RMS) 200 VDC
Maximum Peak 8x20µs Current at 185° F	6500 A
Maximum Energy Rating at 185° F	80 J
Voltage Range 1 mA DC Test at 77° F	212-268 V
Max. Clamping Voltage 8x20µs, 100A at 77° F	395 V
Typical Capacitance (1 MHz) at 77° F	1600 pF

Provide resistor R1 as a 2K ohm, 12 watt, wirewound resistor with tinned terminals and attaching leads. Ensure the resistor is spaced apart from surrounding wires.

Provide a LED or incandescent lamp that has a voltage rating of 120 VAC with a minimum life rating at 50,000 hours.

Wire the preemption and sign control box as shown in Figure 1.



**RAILROAD PREEMPTION WIRING DETAIL**

(wire as shown below)

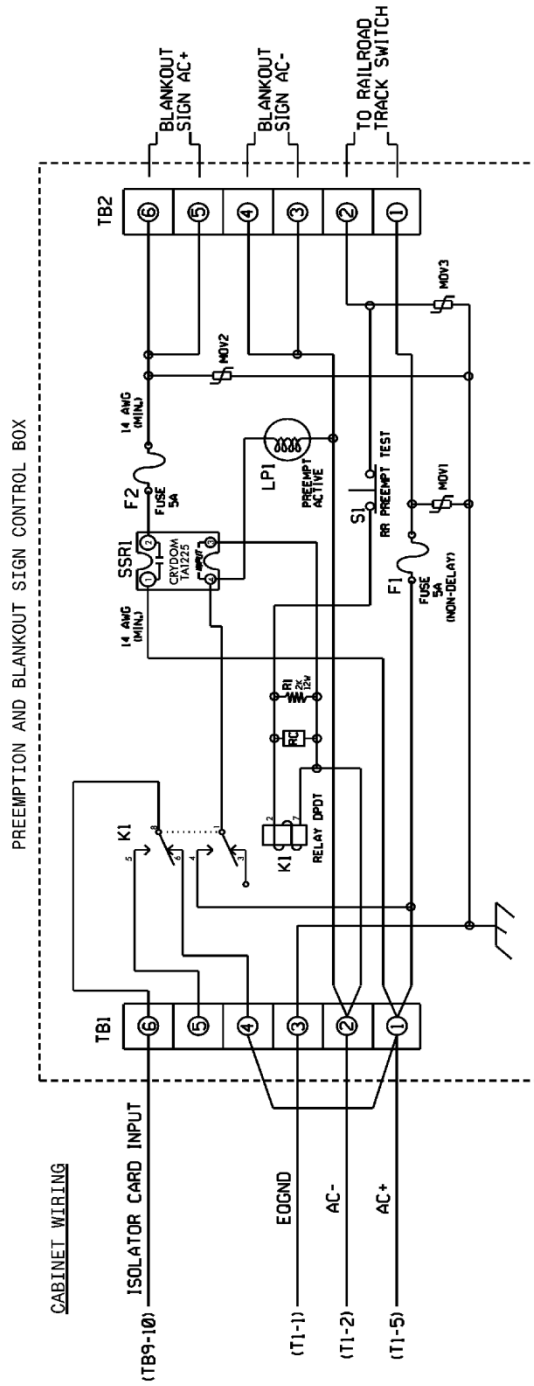

**NOTES**

1. RELAY K1 IS SHOWN IN THE ENERGIZED (PREEMPT NO1 ACTIVE) NORMAL OPERATION STATE.
2. AC ISOLATOR CARD SHALL ACTIVATE PREEMPTION UPON REMOVAL OF AC+ FROM INPUT (AS SHOWN ABOVE). THIS IS ACCOMPLISHED BY SETTING TYPE 252 AC ISOLATOR CARD TO INVERTED OPERATION.

**FRONT VIEW**

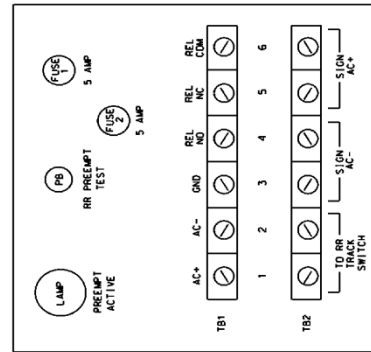

Figure 1

### 3.3. MATERIALS – TYPE 170 DETECTOR SENSOR UNITS

Furnish detector sensor units that comply with Chapter 5 Section 1, “General Requirements,” and Chapter 5 Section 2, “Model 222 & 224 Loop Detector Sensor Unit Requirements,” of the CALTRANS “Transportation Electrical Equipment Specifications” dated March 12, 2009 with Erratum 1.

### 3.4. MATERIALS – TYPE 2070E CONTROLLERS

Furnish model 2070E controller units that conform to CALTRANS *Transportation Electrical Equipment Specifications* (TEES) (dated March 12, 2009, plus Errata 1 dated January 21, 2010 and Errata 2 dated December 5, 2014) except as required herein.

The Department will provide software at the beginning of the burning-in period. Contractor shall give 5 working days notice before needing software. Program software provided by the Department.

Provide model 2070E controllers with OS-9 release 1.3.1 or later with kernel edition #380 or later operating software and device drivers, composed of the unit chassis and at a minimum the following modules and assemblies:

- MODEL 2070-1E, CPU Module, Single Board, with 8Mb Datakey (blue in color)
- MODEL 2070-2E+, Field I/O Module (FI/O)
  - Note: Configure the Field I/O Module to disable both the External WDT Shunt/Toggle Switch and SP3 (SP3 active indicator is “off”)
- MODEL 2070-3B, Front Panel Module (FP), Display B (8x40)
- MODEL 2070-4A, Power Supply Module, 10 AMP
- MODEL 2070-7A, Async Serial Com Module (9-pin RS-232)

## 4. ETHERNET EDGE SWITCH

Furnish and install a managed Ethernet edge switch as specified below that is fully compatible, interoperable, and completely interchangeable and functional within the existing City or Division traffic signal system communications network.

### 4.1. DESCRIPTION

#### A. Ethernet Edge Switch:

Furnish and install a hardened, field Ethernet edge switch (hereafter “edge switch”) for traffic signal controllers as specified below. Ensure that the edge switch provides wire-speed, fast Ethernet connectivity at transmission rates of 100 megabits per second from each remote ITS device location to the routing switches.

Contact the City or Division to arrange for the programming of the new Field Ethernet Switches with the necessary network configuration data, including but not limited to, the Project IP Address, Default Gateway, Subnet Mask and VLAN ID information. Provide a minimum five (5) days working notice to allow the City or Division to program the new devices.

#### B. Network Management:

Ensure that the edge switch is fully compatible with the City’s or Division’s existing Network Management Software.

## 4.2. MATERIALS

### A. General:

Ensure that the edge switch is fully compatible and interoperable with the trunk Ethernet network interface and that the edge switch supports half and full duplex Ethernet communications.

Furnish an edge switch that provide 99.999% error-free operation, and that complies with the Electronic Industries Alliance (EIA) Ethernet data communication requirements using single-mode fiber-optic transmission medium and copper transmission medium. Ensure that the edge switch has a minimum mean time between failures (MTBF) of 10 years, or 87,600 hours, as calculated using the Bellcore/Telcordia SR-332 standard for reliability prediction.

### B. Compatibility Acceptance

The Engineer has the authority to require the Contractor to submit a sample Field Ethernet Switch and Field Ethernet Transceiver along with all supporting documentation, software and testing procedures to allow a compatibility acceptance test be performed prior to approving the proposed Field Ethernet Switch and Field Ethernet Transceiver for deployment. **The Compatibility Acceptance testing will ensure that the proposed device is 100% compatible and interoperable with the existing City Signal System network, monitoring software and Traffic Operations Center network hardware.** Allow fifteen (15) working days for the Compatibility Acceptance Testing to be performed

### C. Standards:

Ensure that the edge switch complies with all applicable IEEE networking standards for Ethernet communications, including but not limited to:

- IEEE 802.1D standard for media access control (MAC) bridges used with the Spanning Tree Protocol (STP);
- IEEE 802.1Q standard for port-based virtual local area networks (VLANs);
- IEEE 802.1P standard for Quality of Service (QoS);
- IEEE 802.1w standard for MAC bridges used with the Rapid Spanning Tree Protocol (RSTP);
- IEEE 802.1s standard for MAC bridges used with the Multiple Spanning Tree Protocol;
- IEEE 802.1x standard for port based network access control, including RADIUS;
- IEEE 802.3 standard for local area network (LAN) and metropolitan area network (MAN) access and physical layer specifications;
- IEEE 802.3u supplement standard regarding 100 Base TX/100 Base FX;
- IEEE 802.3x standard regarding flow control with full duplex operation; and
- IFC 2236 regarding IGMP v2 compliance.
  
- IEEE 802.1AB Link Layer Discovery Protocol (LLDP)
- IEEE 802.3ad Ethernet Link Aggregation
- IEEE 802.3i for 10BASE-T (10 Mbit/s over Fiber-Optic)
- IEEE 802.3ab for 1000BASE-T (1Gbit/s over Ethernet)
- IEEE 802.3z for 1000BASE-X (1 Gbit/s Ethernet over Fiber-Optic)

**D. Functional:**

Ensure that the edge switch supports all Layer 2 management features and certain Layer 3 features related to multicast data transmission and routing. These features shall include, but not be limited to:

- An STP healing/convergence rate that meets or exceeds specifications published in the IEEE 802.1D standard.
- An RSTP healing/convergence rate that meets or exceeds specifications published in the IEEE 802.1w standard.
- An Ethernet edge switch that is a port-based VLAN and supports VLAN tagging that meets or exceeds specifications as published in the IEEE 802.1Q standard, and has a minimum 4-kilobit VLAN address table (254 simultaneous).
- A forwarding/filtering rate that is a minimum of 14,880 packets per second for 10 megabits per second and 148,800 packets per second for 100 megabits per second.
- A minimum 4-kilobit MAC address table.
- Support of Traffic Class Expediting and Dynamic Multicast Filtering.
- Support of, at a minimum, snooping of Version 2 & 3 of the Internet Group Management Protocol (IGMP).
- Support of remote and local setup and management via telnet or secure Web-based GUI and command line interfaces.
- Support of the Simple Network Management Protocol version 3 (SNMPv3). Verify that the Ethernet edge switch can be accessed using the resident EIA-232 management port, a telecommunication network, or the Trivial File Transfer Protocol (TFTP).
- Port security through controlling access by the users. Ensure that the Ethernet edge switch has the capability to generate an alarm and shut down ports when an unauthorized user accesses the network.
- Support of remote monitoring (RMON-1 & RMON-2) of the Ethernet agent.
- Support of the TFTP and SNTP. Ensure that the Ethernet edge switch supports port mirroring for troubleshooting purposes when combined with a network analyzer.

**E. Physical Features:**

*Ports:* Provide 10/100/1000 Mbps auto-negotiating ports (RJ-45) copper Fast Ethernet ports for all edge switches. Provide auto-negotiation circuitry that will automatically negotiate the highest possible data rate and duplex operation possible with attached devices supporting the IEEE 802.3 Clause 28 auto-negotiation standard.

*Optical Ports:* Ensure that all fiber-optic link ports operate at 1310 or 1550 nanometers in single mode. Provide Type LC connectors for the optical ports, as specified in the Plans or by the Engineer. Do not use mechanical transfer registered jack (MTRJ) type connectors.

Provide an edge switch having a minimum of two optical 100/1000 Base X ports capable of transmitting data at 100/1000 megabits per second. Ensure that each optical port consists of a pair of fibers; one fiber will transmit (TX) data and one fiber will receive (RX) data. Ensure that the optical ports have an optical power budget of at least 15 dB.

*Copper Ports:* Provide an edge switch that includes a minimum of four copper ports. Provide Type RJ-45 copper ports and that auto-negotiate speed (i.e., 10/100/1000 Base) and duplex (i.e., full or half). Ensure that all 10/100/1000 Base TX ports meet the specifications detailed in this section

and are compliant with the IEEE 802.3 standard pinouts. Ensure that all Category 5E unshielded twisted pair/shielded twisted pair network cables are compliant with the EIA/TIA-568-B standard.

*Port Security:* Ensure that the edge switch supports/complies with the following (remotely) minimum requirements:

- Ability to configure static MAC addresses access;
- Ability to disable automatic address learning per ports; know hereafter as Secure Port. Secure Ports only forward; and
- Trap and alarm upon any unauthorized MAC address and shutdown for programmable duration. Port shutdown requires administrator to manually reset the port before communications are allowed.

#### **F. Management Capabilities:**

Ensure that the edge switch supports all Layer 2 management features and certain Layer 3 features related to multicast data transmission and routing. These features shall include, but not be limited to:

- An STP healing/convergence rate that meets or exceeds specifications published in the IEEE 802.1 D standards;
- An RSTP healing/convergence rate that meets or exceeds specifications published in the IEEE 802.1w standard;
- An Ethernet edge switch that is a port-based VLAN and supports VLAN tagging that meets or exceeds specifications as published in the IEEE 802.1Q standard, and has a minimum 4-kilobit VLAN address table (254 simultaneous);
- A forwarding/filtering rate that is a minimum of 14,880 packets per second for 10 megabits per second, 148,800 packets per second for 100 megabits per second and 1,488,000 packets per second for 1000 megabits per second;
- A minimum 4-kilobit MAC address table;
- Support of Traffic Class Expediting and Dynamic Multicast Filtering.
- Support of, at a minimum, snooping of Version 2 & 3 of the Internet Group Management Protocol (IGMP);
- Support of remote and local setup and management via telnet or secure Web-based GUI and command line interfaces; and
- Support of the Simple Network Management Protocol (SNMP). Verify that the Ethernet edge switch can be accessed using the resident EIA-232 management port, a telecommunication network, or the Trivial File Transfer Protocol (TFTP).

*Network Capabilities:* Provide an edge switch that supports/complies with the following minimum requirements:

- Provide full implementation of IGMPv2 snooping (RFC 2236);
- Provide full implementation of SNMPv1, SNMPv2c, and/or SNMPv3;
- Provide support for the following RMON–I groups, at a minimum:
  - Part 1: Statistics
  - Part 2: History
  - Part 3: Alarm
  - Part 9: Event
- Provide support for the following RMON–2 groups, at a minimum:
  - Part 13: Address Map
  - Part 17: Layer Matrix

- Part 16: Layer Host - Part 18:User History

- Capable of mirroring any port to any other port within the switch;
- Meet the IEEE 802.1Q (VLAN) standard per port for up to four VLANs;
- Meet the IEEE 802.3ad (Port Trunking) standard for a minimum of two groups of four ports;
- Password manageable;
- Telnet/CLI;
- HTTP (Embedded Web Server) with Secure Sockets Layer (SSL); and
- Full implementation of RFC 783 (TFTP) to allow remote firmware upgrades.

*Network Security:* Provide an edge switch that supports/complies with the following (remotely) minimum network security requirements:

- Multi-level user passwords;
- RADIUS centralized password management (IEEE 802.1X);
- SNMPv3 encrypted authentication and access security;
- Port security through controlling access by the users: ensure that the Ethernet edge switch has the capability to generate an alarm and shut down ports when an unauthorized user accesses the network;
- Support of remote monitoring (RMON-1&2) of the Ethernet agent; and
- Support of the TFTP and SNTP. Ensure that the Ethernet edge switch supports port mirroring for troubleshooting purposes when combined with a network analyzer.

### **G. Electrical Specifications:**

Ensure that the edge switch operates and power is supplied with 115 volts of alternating current (VAC). Ensure that the edge switch has a minimum operating input of 110 VAC and a maximum operating input of 130 VAC. Ensure that if the device requires operating voltages other than 120 VAC, supply the required voltage converter. Ensure that the maximum power consumption does not exceed 50 watts. Ensure that the edge switch has diagnostic light emitting diodes (LEDs), including link, TX, RX, speed (for Category 5E ports only), and power LEDs.

### **H. Environmental Specifications:**

Ensure that the edge switch performs all of the required functions during and after being subjected to an ambient operating temperature range of -30 degrees to 165 degrees Fahrenheit as defined in the environmental requirements section of the NEMA TS 2 standard, with a noncondensing humidity of 0 to 95%.

Provide certification that the device has successfully completed environmental testing as defined in the environmental requirements section of the NEMA TS 2 standard. Provide certification that the device meets the vibration and shock resistance requirements of Sections 2.1.9 and 2.1.10, respectively, of the NEMA TS 2 standard. Ensure that the edge switch is protected from rain, dust, corrosive elements, and typical conditions found in a roadside environment.

The edge switch shall meet or exceed the following environmental standards:

- IEEE 1613 (electric utility substations)
- IEC 61850-3 (electric utility substations)
- IEEE 61800-3 (variable speed drive systems)
- IEC 61000-6-2 (generic industrial)

- EMF – FCC Part 15 CISPR (EN5502) Class A

#### I. Ethernet Patch Cable:

Furnish a factory pre-terminated/pre-connectorized Ethernet patch cable with each edge switch. Furnish Ethernet patch cables meeting the following physical requirements:

- Five (5)-foot length
- Category 5e or better
- Factory-installed RJ-45 connectors on both ends
- Molded anti-snag hoods over connectors
- Gold plated connectors

Furnish Fast Ethernet patch cords meeting the following minimum performance requirements:

- TIA/EIA-568-B-5, Additional Transmission Performance Specifications for 4-pair 100  $\Omega$  Enhanced Category 5 Cabling
- Frequency Range: 1-100 MHz
- Near-End Crosstalk (NEXT): 30.1 dB
- Power-sum NEXT: 27.1 dB
- Attenuation to Crosstalk Ratio (ACR): 6.1 dB
- Power-sum ACR: 3.1 dB
- Return Loss: 10dB
- Propagation Delay: 548 nsec

### 4.3. CONSTRUCTION METHODS

#### A. General:

Ensure that the edge switch is UL listed.

Verify that network/field/data patch cords meet all ANSI/EIA/TIA requirements for Category 5E and Category 6 four-pair unshielded twisted pair cabling with stranded conductors and RJ45 connectors.

Contact the Signal Shop a minimum of 5 days prior to installation for the most current edge switch IP Address, VLAN, subnet mask, default gateway and configuration files.

#### B. Edge Switch:

Mount the edge switch inside each field cabinet by securely fastening the edge switch to the upper end of the right rear vertical rail of the equipment rack using manufacturer-recommended or Engineer-approved attachment methods, attachment hardware and fasteners.

Ensure that the edge switch is mounted securely in the cabinet and is fully accessible by field technicians without blocking access to other equipment. Verify that fiber-optic jumpers consist of a length of cable that has connectors on both ends, primarily used for interconnecting termination or patching facilities and/or equipment.

### 4.4. MEASUREMENT AND PAYMENT

*Ethernet edge switch* will be measured and paid as the actual number of Ethernet edge switches furnished, installed, and accepted.

No separate measurement will be made for Ethernet patch cable, power cord, mounting hardware, nuts, bolts, brackets, or edge switch programming as these will be considered incidental to furnishing and installing the edge switch.

Payment will be made under:

Ethernet Edge Switch.....Each

**5. MODIFY SPREAD SPECTRUM WIRELESS RADIO**

**5.1. DESCRIPTION**

Make modifications to existing Spread Spectrum Radio installations.

**5.2. MATERIALS**

Material, equipment, and hardware furnished under this section shall be pre-approved on the Departments’ QPL.

Reference Article 1098-18 “Spread Spectrum Wireless Radio” of the Standard Specifications for Roads and Structures.

**5.1.CONSTRUCTION METHODS**

This item of work involves making modifications to existing wireless installations which include relocating an existing radio from an existing cabinet to a new cabinet, and/or relocating existing components of the radio system from an existing pole to new poles (wood poles, metal strain poles, metal poles with mast arms, etc.). This item of work includes, but may not be limited to, the following:

- Relocating existing radio from an existing cabinet to a new cabinet
- Relocating or installing new Coaxial Cable
- Furnishing and installing new N-Type Connectors
- Furnishing new Coaxial Cable and Shield Grounding Kits
- Relocating Antenna Mounting Hardware
- Relocating Antennas

This item of work may also involve converting an existing standalone radio site to a repeater site. This item of work includes, but may not be limited to, the following:

- Furnishing and installing new antenna(s)
- Furnishing and installing new antenna mounting hardware kits
- Furnishing and installing new 6 foot coaxial cable jumpers with N-Type Connectors
- Furnishing and installing new coaxial cable – power divider (Splitters)

**5.1.MEASUREMENT AND PAYMENT**

*Modify Radio Installation* will be measured as the actual number of modified radio installations that are modified and accepted.

This item includes relocating the radio, and furnishing and/or relocating and installing coaxial cable, N-Type Connectors, coaxial cable shield grounding kits, antenna mounting hardware, antennas,



coaxial cable and power dividers. This item of work may also involve furnishing and installing new decals and furnishing or relocating signs. This item of work may also involve re-programming the radio.

Payment for new risers will be covered separately.

Payment will be made under:

Modify Radio Installation .....Each

**SOUND BARRIER WALL****(8-29-19)****1.0 DESCRIPTION**

This work consists of furnishing precast panels with an architectural surface treatment, structural steel, concrete, handling, transporting, fabricating, galvanizing, storing materials, furnishing erection drawings, pile excavation, backfilling, erecting and installing the sound barrier wall members and all other materials as required by the plans, Standard Specifications and this Special Provision.

Precast panels with an architectural surface treatment shall be constructed using form lining materials and patterns to match the appearance (size, shape, color, texture, pattern, and relief) of the textured finish as specified on the plans and approved by the Engineer.

The contractor is required to use the same form liner and coloration contractor to construct the precast panels with an architectural surface treatment.

The Standard Plans allow pile spacing of 10, 15 or 20 feet. Pile spacing greater than 15 feet will not be allowed for the precast concrete panels detailed in the standard plans. Provide consistent pile spacing for the entire length of the wall. Use odd pile spacing, if necessary, only at the ends of the wall and at turning points as approved by the Engineer. Architectural surface treatment shall not be applied to piles. Piles shall have a smooth, non-textured finish, and remain unstained in their natural color.

A maximum one foot drop or rise in elevation between wall sections is permitted. Elevation changes greater than one foot, if necessary, will be allowed only at the end of the wall. Top of wall elevation changes that result in a jagged appearance will not be allowed.

**2.0 QUALIFICATIONS**

Prior to beginning work the contractor shall submit the following qualifications to the Engineer for approval:

**A. Architectural Surface Treatment Construction**

The Contractor shall have a minimum of three years of experience in architectural concrete surface treatment construction on similar types of projects. The Contractor shall furnish to the Engineer 3 references who were responsible for supervision of similar projects. Include name, address, telephone number, and specific type of application.

**B. Form Liners and Coloring System**

The manufacturer of form liners for the standard textured finishes and coloring system shall have at least five years of experience making molds and color stains to create formed concrete surfaces to match the specified textured finish and colors. The Contractor shall schedule a pre-installation conference with a form liner manufacturer representative and the Engineer to assure understanding of simulated textured finish form liner use, color

application, requirements for construction of sample panel(s), and to coordinate the work. The Contractor shall be required to disclose their source of form liner manufacturer and final coloration contractor prior to the Preconstruction Conference.

### **3.0 ALTERNATE PILE SPACING FOR STANDARD PRECAST PANELS**

As an alternate, the Contractor may submit plans for pile spacings greater than 10 feet and less than 15 feet for review and approval. The pile excavation diameter, excavation depth and reinforcing steel shall be equal to the amount shown on the existing plans for the 15 feet pile spacing. A variance in the reinforcing steel will be allowed for the length of horizontal and number of vertical reinforcement bars in the precast panel for the alternate pile spacing.

Submit two sets of detailed plans for review. Include all details in the plans, including the size and spacing of required reinforcement necessary to fabricate the precast panels. Have a North Carolina registered Professional Engineer check, seal and date the plans. After the plans are reviewed and, if necessary, corrections made, submit one set of reproducible tracings on 22" x 34" sheets to become part of the contract plans.

### **4.0 ALTERNATE WALL TYPE**

Walls that have been assigned "Approved" or "Approved for Provisional Use" status by the Product Evaluation Program will be considered for substitution to the detailed Standard Sound Barrier Wall only when noted on the plans. Alternate wall types, piles and pile spacing must meet the design and construction requirements of the project. Pile spacing greater than 20 feet will not be permitted. Alternate pile and wall structural stability and connection details shall conform to the current edition of the AASHTO LRFD Bridge Design Specifications.

Prior to submittal of Working Drawings, as described herein, submit a copy of the signed NCDOT Product Status Notification Letter and two sets of preliminary plans for review and approval. Include material specifications for all components. Once preliminary plans are approved, submit Working Drawings in accordance with all applicable portions of the requirements herein, including details necessary to fabricate and construct the proposed alternate.

Have a North Carolina registered Professional Engineer check, seal and date the plans and, when requested, provide calculations. After the plans are reviewed and, if necessary, corrections made, submit one set of reproducible tracings on 22" x 34" sheets to become part of the contract plans.

### **5.0 WORKING DRAWINGS**

Submit precast panel casting drawings in accordance with Article 1077-2 of the Standard Specifications prior to casting. Show the inserts, method of handling, and support details used for transportation on the casting drawings. Submit fabrication drawings for approval prior to fabrication of wall components. Submit an erection plan and precast panel placing

plan, including location of various heights of panels, for review and acceptance prior to fabrication of forms. Submit five sets of detail drawings on 22" x 34" sheets.

Submit for review and acceptance, wall plan and elevation views and details showing overall simulated textured pattern, joint locations, and end, edge or other special conditions. The drawings should include typical cross sections of precast panels, joints, corners, texture relief, texture size, pitch/working line, mortar joint and bed depths. If necessary, the Contractor shall revise the working drawings until the proposed form liner patterns and arrangement have been accepted by the Engineer. Working drawings should be of sufficient scale to show the detail of all textured finishes and joint patterns. Shop drawings shall be reviewed and approved prior to fabrication of form liners.

## **6.0 MATERIALS AND FABRICATION OF STANDARD PRECAST PANELS**

Provide materials and fabricate members in accordance with the requirements of Division 10 of the Standard Specifications for Roads and Structures. Provide precast panels 4 inches  $\pm$  1/4 inch thick, excluding relief for a textured finish. Architectural surface treatment shall consist of a standard textured finish and a single color of stain applied to both faces of the precast panels as specified on the plans and approved by the Engineer. Relief of any texture is not to exceed an average depth of 1 inch. No textured finish or stain shall be applied on the uppermost foot of each wall segment and along the vertical edges of the panels. These areas shall have a smooth, non-textured finish, and remain in its natural concrete color.

Furnish three 12" x 12" samples for approval which establish the acceptable variations in color, texture, and uniformity. After the color, texture, and uniformity of the furnished samples are approved, produce a full scale panel unit meeting design requirements. This mock-up and the furnished samples establish the standard quality for determining acceptance of the panels. When producing the final installed panels, use fine and coarse aggregate, retarder, and cement from the same source as those used in the approved sample panels.

The standard textured finish shall be constructed using form lining materials. The form liner shall be a high quality, re-useable product manufactured of high strength urethane rubber or other approved material which attaches easily to the form work system, and shall not compress more than 1/4 inch when concrete is poured at a rate of 10 vertical feet per hour. The form liners shall be removable without causing deterioration of the surface or underlying concrete.

The form liner shall be patterned such that long continuous horizontal or vertical lines do not occur on the finished exposed surface. The line pattern shall be random in nature and shall conceal construction joint lines.

Prior to each concrete pour, the form liners shall be clean and free of build-up. Each liner shall be visually inspected for blemishes and tears. Repairs shall be made in accordance with the manufacturer's recommendations. Repairs shall be accepted by the Engineer before being used. Form liner panels that do not perform as intended or are no longer repairable shall be replaced.

Form liners shall be securely attached to forms in accordance with the manufacturer's recommendations, with less than a ¼ inch seam. Blend form liner butt joints into the textured surface pattern and finish off the final concrete surface. Create no visible vertical or horizontal seams or conspicuous form liner butt joint marks. At locations where the form liners are joined, carefully blend to match the balance of the textured finish.

Form liners shall be installed to withstand anticipated concrete placement pressures without leakage and without causing physical or visual defects.

When the approved textured finish requires simulated grout pattern joints, construct grout pattern joints to simulate the appearance of mortared joints produced in laid up masonry work. Grout pattern joints shall be produced in accordance with the form liner / concrete color system manufacturer.

The Contractor shall have a technical representative from the form liner manufacturer on site for technical supervision during the installation and removal of form liners. Unless directed by the Engineer, installation and removal of form liners shall not be permitted if the technical representative is not present.

Form release agent shall be a non-staining petroleum distillate free from water, asphaltic, and other insoluble residue, or an equivalent product and shall be applied in accordance with the manufacturer's recommendations. The form release agent shall be compatible with the form liner material, the concrete coloring system, any special surface finish and in accordance with this Special Provision. Form release agent should be worked into all areas, especially pattern recesses.

All form defects in finished uncolored surface shall be filled or repaired within 48 hours of form removal. Use patching materials and procedures in accordance with the manufacturer's recommendations.

Precast concrete shall be finished in accordance with the Standard Specifications, except that curing of concrete should be done to accommodate the application of coloring and surface finish treatment.

## **7.0 SURFACE COLORING**

All surfaces that are to receive coloring agent application shall be free of all laitance, dirt, dust, grease, efflorescence, paint or any other foreign material prior to the application of coloring agent. Cleaning of surfaces to be accomplished by pressure washing with water set at 3,000 psi to remove laitance. The fan nozzle shall be held perpendicular to the surface at a distance of 1 to 2 feet. Sandblasting will not be permitted.

Surface coloring shall be achieved using an approved stain suitable for the purpose intended and applied in a manner consistent with the design intent of the project. Color system shall be a single color of stain in brown or gray tones as specified on the plans and approved by the Engineer. The approved sample panel shall be the basis for determining the appropriate stain application.

The coloring agent shall be a penetrating stain mix or other approved coloring system designed for exterior application on old or new concrete with field evidence of resistance to moisture, acid or alkali, mildew, mold or fungus discoloration or degradation. The coloring agent shall be breathable, allowing moisture and vapor transmission. Final coloring system and color of stain are subject to approval by the Engineer.

Application of coloring/staining agent to finished precast concrete and patches shall occur at a minimum of 30 days after form liners are removed. Maintain the concrete temperature between 40°F and 85°F during color/stain application and for 48 hours after color/stain application. Consult the manufacturer's recommendations for preparation, application, curing, and storage of coloring agents/stains. The contractor shall provide a Color Application Artist who is experienced in producing realistic surface appearances. Treated surfaces located adjacent to exposed soil or pavement shall be temporarily covered to prevent dirt or soil splatter from rain.

Final surface shall be free of blemishes, discolorations, surface voids, and other irregularities. All patterns should be continuous without visual disruption. Linear butt joints shall be carefully blended into the approved pattern and finished off the final concrete surface. No visible vertical or horizontal seams or conspicuous form marks created by butt joining will be permitted.

Following the completion of all work, repairs of any damage made by other construction operations shall be made to the form lined and colored surfaces as directed by the Engineer.

## **8.0 CONSTRUCTION METHODS**

Complete the final survey of existing ground profile after clearing the wall area but prior to submitting any working drawings. Submit the final groundline survey with the working drawings.

If the Department is responsible for the survey, the Engineer field verifies the existing ground profile along the sound barrier wall. Contact the Engineer to obtain the survey information. Otherwise, complete the existing ground survey prior to submittal of working drawings.

Excavate holes with the diameters shown on the plans. Perform pile excavation to the depths shown on the plans and install piles as shown on the plans or in the accepted submittals with a tolerance of ½ inch per foot from vertical. Backfill excavations with concrete after placing piles.

### Pile Excavation

Use equipment of adequate capacity and capable of drilling through soil and non-soil including rock, boulders, debris, man-made objects and any other materials encountered. Blasting is not permitted to advance the excavation. Blasting for core removal is only permitted when approved by the Engineer. Dispose of drilling spoils in accordance with Section 802 of the Standard Specifications and as directed by the Engineer. Drilling spoils consist of all excavated material including water removed from the excavation either by pumping or drilling tools.

If unstable, caving or sloughing soils are anticipated or encountered, stabilize excavations with either slurry or steel casing. When using slurry, submit slurry details including product information, manufacturer's recommendations for use, slurry equipment information and written approval from the slurry supplier that the mixing water is acceptable before beginning drilling. When using steel casing, use either the sectional type or one continuous corrugated or non-corrugated piece. Steel casings should consist of clean watertight steel of ample strength to withstand handling and driving stresses and the pressures imposed by concrete, earth or backfill. Use steel casings with an outside diameter equal to the hole size and a minimum wall thickness of ¼ inch.

### Concrete Placement

Before placing concrete, center and support the pile in the excavation and check the water inflow rate in the excavation after any pumps have been removed. If the inflow rate is less than 6 inches per half hour, remove any water and free fall the concrete into the excavation. Ensure that concrete flows completely around the pile. If the water inflow rate is greater than 6 inches per half hour, propose a concrete placement procedure to the Engineer. The Engineer shall approve the concrete placement procedure before placing concrete.

Fill the excavation with Class A concrete in accordance with Section 1000 of the Standard Specifications except as modified herein. Provide concrete with a slump of 6 to 8 inches. Use an approved high-range water reducer to achieve this slump. Place concrete in a continuous manner and remove all casings.

## **9.0 METHOD OF MEASUREMENT**

The quantity of form liner textured finish and coloring stain to be paid for will be the actual square feet of architectural surface treatment that has been incorporated into the completed and accepted work. The area of architectural surface treatment will be measured by the area of treated panels. Do not include the uppermost foot of each wall segment, panel vertical edges without architectural surface treatment, or piles in the measurement. Area of sample panels shall not be included in the measurement of architectural surface treatment.

The quantity of sound barrier wall to be paid for will be the actual square feet of completed and accepted wall. In any individual section of sound barrier wall or in comparably dimensioned sections, the wall height is from the bottom of the bottom panel to the top of

the top panel and the width is the distance between the centerline of the piles at the ends of the section. Include the full width of the piles at the ends of the wall.

**10.0 BASIS OF PAYMENT**

The quantity of sound barrier wall and architectural surface treatment, measured as provided above, will be paid for at the contract unit price bid per square foot.

The unit price bid per square foot for “Sound Barrier Wall” will be full compensation for work covered by this Special Provision including, but not limited to, furnishing precast panels, steel or concrete piles, miscellaneous structural steel, concrete, and all other materials; handling, transporting, fabricating, galvanizing, and storing materials; furnishing erection drawings, backfilling, pile excavation including any casing or slurry, and erecting and installing the sound barrier wall members.

The unit price bid per square foot for “Architectural Surface Treatment” will be full compensation for the architectural treatment covered by this Special Provision including, but not limited to, furnishing architectural detail drawings, sample panels; the construction, finishing, and removal of all equipment, materials, labor, and incidentals necessary for furnishing and use of all form liners to produce approved textured finish and application of approved surface coloring.

Payment will be made under:

Sound Barrier Wall.....	Square Foot
Architectural Surface Treatment (Sound Barrier Wall) .....	Square Foot





**PROJECT SPECIAL PROVISION**

(10-18-95) (Rev. 3-21-17)

Z-1a

**PERMITS**

The Contractor's attention is directed to the following permits, which have been issued to the Department of Transportation by the authority granting the permit.

<b><u>PERMIT</u></b>	<b><u>AUTHORITY GRANTING THE PERMIT</u></b>
Dredge and Fill and/or Work in Navigable Waters (404)	U. S. Army Corps of Engineers
Water Quality (401)	Division of Environmental Management, DEQ State of North Carolina
Buffer Certification	Division of Environmental Management, DEQ State of North Carolina

The Contractor shall comply with all applicable permit conditions during construction of this project. Those conditions marked by \* are the responsibility of the Department and the Contractor has no responsibility in accomplishing those conditions.

Agents of the permitting authority will periodically inspect the project for adherence to the permits.

The Contractor's attention is also directed to Articles 107-10 and 107-13 of the *2018 Standard Specifications* and the following:

Should the Contractor propose to utilize construction methods (such as temporary structures or fill in waters and/or wetlands for haul roads, work platforms, cofferdams, etc.) not specifically identified in the permit (individual, general, or nationwide) authorizing the project it shall be the Contractor's responsibility to coordinate with the Engineer to determine what, if any, additional permit action is required. The Contractor shall also be responsible for initiating the request for the authorization of such construction method by the permitting agency. The request shall be submitted through the Engineer. The Contractor shall not utilize the construction method until it is approved by the permitting agency. The request normally takes approximately 60 days to process; however, no extensions of time or additional compensation will be granted for delays resulting from the Contractor's request for approval of construction methods not specifically identified in the permit.

**Where construction moratoriums are contained in a permit condition which restricts the Contractor's activities to certain times of the year, those moratoriums will apply only to the portions of the work taking place in the restricted waters, wetlands or buffer zones, provided that activities outside those areas is done in such a manner as to not affect the restricted waters, wetlands or buffer zones.**

U.S. ARMY CORPS OF ENGINEERS  
WILMINGTON DISTRICT

Action Id. SAW-2019-00962

County: Johnston County U.S.G.S. Quad: Powhatan

**GENERAL PERMIT (REGIONAL AND NATIONWIDE) VERIFICATION**

Permittee: Chad Coggins  
NCDOT/ Division 4 Environmental Officer  
Address: PO Box 3165  
Wilson NC, 27895  
Cell Phone 252.717.8699  
Size (acres) N/A Nearest Town  
Nearest Waterway Little Creek River Basin Neuse  
USGS HUC 03020201 Coordinates Latitude: 35.6315; Longitude: -78.4455  
Location description: Proposed new location extension of NC 42, southwest of US 70 Business, and intersection of SR1563, Little Creek Church Road and SR 1560, Ranch Road, southeast of Clayton, NC

Description of projects area and activity: TIP U-6223; Road improvement impacting 0.70 acre of wetlands (including 0.06 acre of non-404 hand clearing), and 270 linear feet of tributary.

Applicable Law:  Section 404 (Clean Water Act, 33 USC 1344);  Section 10 (Rivers and Harbors Act, 33 USC 403)

Authorization: Nationwide Permit Number: NWP 23 Approved Categorical Exclusions  
**SEE ATTACHED NWP GENERAL, REGIONAL AND SPECIAL CONDITIONS**

**Your work is authorized by the above referenced permit provided it is accomplished in strict accordance with the attached conditions and your submitted application and attached information dated September 21, 2021. Any violation of the attached conditions or deviation from your submitted plans may subject the permittee to a stop work order, a restoration order, a Class I administrative penalty, and/or appropriate legal action.**

This verification will remain valid until the expiration date identified below unless the nationwide and/or regional general permit authorization is modified, suspended or revoked. If, prior to the expiration date identified below, the nationwide and/or regional general permit authorization is reissued and/or modified, this verification will remain valid until the expiration date identified below, provided it complies with all requirements of the modified nationwide permit. If the nationwide and/or regional general permit authorization expires or is suspended, revoked, or is modified, such that the activity would no longer comply with the terms and conditions of the nationwide permit, activities which have commenced (i.e., are under construction) or are under contract to commence in reliance upon the nationwide and/or regional general permit, will remain authorized provided the activity is completed within twelve months of the date of the nationwide and/or regional general permit's expiration, modification or revocation, unless discretionary authority has been exercised on a case-by-case basis to modify, suspend or revoke the authorization.

This Department of the Army verification does not relieve the permittee of the responsibility to obtain any other required Federal, State or local approvals/permits.

If there are any questions regarding this verification, any of the conditions of the Permit, or the Corps of Engineers regulatory program, please contact Eric Alsmeyer at (919) 554-4884 X 23 or Eric.C.Alsmeyer@usace.army.mil.

Monte Matthews Date: 2022.03.02  
08:34:14 -05'00'

Corps Regulatory Official: \_\_\_\_\_ Date: March 1, 2022  
Expiration Date of Verification: March 14, 2026

The Wilmington District is committed to providing the highest level of support to the public. To help us ensure we continue to do so, please complete our Customer Satisfaction Survey, located online at [http://corpsmapu.usace.army.mil/cm\\_apex/f?p=136:4:0](http://corpsmapu.usace.army.mil/cm_apex/f?p=136:4:0).

Copy furnished (by email): Beth Harmon; NCDMS;

**SPECIAL CONDITION**

In order to compensate for impacts associated with this permit, mitigation shall be provided in accordance with the provisions outlined on the most recent version of the attached Compensatory Mitigation Responsibility Transfer Form. The requirements of this form, including any special conditions listed on this form, are hereby incorporated as special conditions of this permit.

Action ID Number: SAW-2019-00962

County: Johnston County

Permittee: Chad Coggins  
NCDOT/ Division 4 Environmental Officer

Project Name: NCDOT U-6223 NC42 extension SR1563 LittleCreekChurchRd SR1560, RanchRd; ImproveIntersection; Johnston Div4

Date Verification Issued: March 1, 2022

Project Manager: Eric Alsmeyer

Upon completion of the activity authorized by this permit and any mitigation required by the permit, sign this certification and return it to the following address:

**US ARMY CORPS OF ENGINEERS  
WILMINGTON DISTRICT  
Attn: Eric Alsmeyer  
Raleigh Regulatory Field Office  
3331 Heritage Trade Drive, Suite 105  
Wake Forest, NC 27587  
919.554.4884, Ext. 23**

Please note that your permitted activity is subject to a compliance inspection by a U. S. Army Corps of Engineers representative. Failure to comply with any terms or conditions of this authorization may result in the Corps suspending, modifying or revoking the authorization and/or issuing a Class I administrative penalty, or initiating other appropriate legal action.

I hereby certify that the work authorized by the above referenced permit has been completed in accordance with the terms and condition of the said permit, and required mitigation was completed in accordance with the permit conditions.

\_\_\_\_\_  
Signature of Permittee

\_\_\_\_\_  
Date

# P-5

## **Nationwide Permit 23** **Approved Categorical Exclusions**

Effective Date: February 25, 2022 / Expiration Date: March 14, 2026

Authority: Sections 10 and 404

Activities undertaken, assisted, authorized, regulated, funded, or financed, in whole or in part, by another Federal agency or department where:

(a) That agency or department has determined, pursuant to the Council on Environmental Quality's implementing regulations for the National Environmental Policy Act (40 CFR part 1500 et seq.), that the activity is categorically excluded from the requirement to prepare an environmental impact statement or environmental assessment analysis, because it is included within a category of actions which neither individually nor cumulatively have a significant effect on the human environment; and

(b) The Office of the Chief of Engineers (Attn: CECW-CO) has concurred with that agency's or department's determination that the activity is categorically excluded and approved the activity for authorization under NWP 23.

The Office of the Chief of Engineers may require additional conditions, including pre-construction notification, for authorization of an agency's categorical exclusions under this NWP.

*Notification:* Certain categorical exclusions approved for authorization under this NWP require the permittee to submit a pre-construction notification to the district engineer prior to commencing the activity (see general condition 32). The activities that require pre-construction notification are listed in the appropriate Regulatory Guidance Letter(s).

\* *Note:* The agency or department may submit an application for an activity believed to be categorically excluded to the Office of the Chief of Engineers (Attn: CECW-CO). Prior to approval for authorization under this NWP of any agency's activity, the Office of the Chief of Engineers will solicit public comment. As of the date of issuance of this NWP, agencies with approved categorical exclusions are: the Bureau of Reclamation, Federal Highway Administration, and U.S. Coast Guard. Activities approved for authorization under this NWP as of the date of this notice are found in Corps Regulatory Guidance Letter 05-07. Any future approved categorical exclusions will be announced in Regulatory Guidance Letters and posted on this same web site.

### **GENERAL CONDITIONS**

Note: To qualify for NWP authorization, the prospective permittee must comply with the following general conditions, as applicable, in addition to any regional or case-specific conditions imposed by the division engineer or district engineer. Prospective permittees should contact the appropriate Corps district office to determine if regional conditions have been imposed on an NWP. Prospective permittees should also contact the appropriate Corps district office to determine the status of Clean Water Act Section 401 water quality certification and/or Coastal Zone Management Act consistency for an NWP. Every person who may wish to obtain permit authorization under one or more NWPs, or who is currently relying on an existing or prior permit authorization under one or more NWPs, has been and is on notice that all of the provisions of 33 CFR 330.1 through 330.6 apply to every NWP authorization. Note especially 33 CFR 330.5 relating to the modification, suspension, or revocation of any NWP authorization.

## 1. Navigation.

(a) No activity may cause more than a minimal adverse effect on navigation.

(b) Any safety lights and signals prescribed by the U.S. Coast Guard, through regulations or otherwise, must be installed and maintained at the permittee's expense on authorized facilities in navigable waters of the United States.

(c) The permittee understands and agrees that, if future operations by the United States require the removal, relocation, or other alteration, of the structure or work herein authorized, or if, in the opinion of the Secretary of the Army or his authorized representative, said structure or work shall cause unreasonable obstruction to the free navigation of the navigable waters, the permittee will be required, upon due notice from the Corps of Engineers, to remove, relocate, or alter the structural work or obstructions caused thereby, without expense to the United States. No claim shall be made against the United States on account of any such removal or alteration.

2. Aquatic Life Movements. No activity may substantially disrupt the necessary life cycle movements of those species of aquatic life indigenous to the waterbody, including those species that normally migrate through the area, unless the activity's primary purpose is to impound water. All permanent and temporary crossings of waterbodies shall be suitably culverted, bridged, or otherwise designed and constructed to maintain low flows to sustain the movement of those aquatic species. If a bottomless culvert cannot be used, then the crossing should be designed and constructed to minimize adverse effects to aquatic life movements.

3. Spawning Areas. Activities in spawning areas during spawning seasons must be avoided to the maximum extent practicable. Activities that result in the physical destruction (e.g., through excavation, fill, or downstream smothering by substantial turbidity) of an important spawning area are not authorized.

4. Migratory Bird Breeding Areas. Activities in waters of the United States that serve as breeding areas for migratory birds must be avoided to the maximum extent practicable.

5. Shellfish Beds. No activity may occur in areas of concentrated shellfish populations, unless the activity is directly related to a shellfish harvesting activity authorized by NWP 4 and 48, or is a shellfish seeding or habitat restoration activity authorized by NWP 27.

6. Suitable Material. No activity may use unsuitable material (e.g., trash, debris, car bodies, asphalt, etc.). Material used for construction or discharged must be free from toxic pollutants in toxic amounts (see section 307 of the Clean Water Act).

7. Water Supply Intakes. No activity may occur in the proximity of a public water supply intake, except where the activity is for the repair or improvement of public water supply intake structures or adjacent bank stabilization.

8. Adverse Effects from Impoundments. If the activity creates an impoundment of water, adverse effects to the aquatic system due to accelerating the passage of water, and/or restricting its flow must be minimized to the maximum extent practicable.

9. Management of Water Flows. To the maximum extent practicable, the pre-construction course, condition, capacity, and location of open waters must be maintained for each activity,

including stream channelization, storm water management activities, and temporary and permanent road crossings, except as provided below. The activity must be constructed to withstand expected high flows. The activity must not restrict or impede the passage of normal or high flows unless the primary purpose of the activity is to impound water or manage high flows. The activity may alter the pre-construction course, condition, capacity, and location of open waters if it benefits the aquatic environment (e.g., stream restoration or relocation activities).

10. **Fills Within 100-Year Floodplains.** The activity must comply with applicable FEMA-approved state or local floodplain management requirements.
11. **Equipment.** Heavy equipment working in wetlands or mudflats must be placed on mats, or other measures must be taken to minimize soil disturbance.
12. **Soil Erosion and Sediment Controls.** Appropriate soil erosion and sediment controls must be used and maintained in effective operating condition during construction, and all exposed soil and other fills, as well as any work below the ordinary high water mark or high tide line, must be permanently stabilized at the earliest practicable date. Permittees are encouraged to perform work within waters of the United States during periods of low-flow or no-flow, or during low tides.
13. **Removal of Structures and Fills.** Temporary structures must be removed, to the maximum extent practicable, after their use has been discontinued. Temporary fills must be removed in their entirety and the affected areas returned to pre-construction elevations. The affected areas must be revegetated, as appropriate.
14. **Proper Maintenance.** Any authorized structure or fill shall be properly maintained, including maintenance to ensure public safety and compliance with applicable NWP general conditions, as well as any activity-specific conditions added by the district engineer to an NWP authorization.
15. **Single and Complete Project.** The activity must be a single and complete project. The same NWP cannot be used more than once for the same single and complete project.
16. **Wild and Scenic Rivers.**
  - (a) No NWP activity may occur in a component of the National Wild and Scenic River System, or in a river officially designated by Congress as a “study river” for possible inclusion in the system while the river is in an official study status, unless the appropriate Federal agency with direct management responsibility for such river, has determined in writing that the proposed activity will not adversely affect the Wild and Scenic River designation or study status.
  - (b) If a proposed NWP activity will occur in a component of the National Wild and Scenic River System, or in a river officially designated by Congress as a “study river” for possible inclusion in the system while the river is in an official study status, the permittee must submit a pre-construction notification (see general condition 32). The district engineer will coordinate the PCN with the Federal agency with direct management responsibility for that river. Permittees shall not begin the NWP activity until notified by the district engineer that the Federal agency with direct management responsibility for that river has determined in writing that the proposed NWP activity will not adversely affect the Wild and Scenic River designation or study status.

(c) Information on Wild and Scenic Rivers may be obtained from the appropriate Federal land management agency responsible for the designated Wild and Scenic River or study river (e.g., National Park Service, U.S. Forest Service, Bureau of Land Management, U.S. Fish and Wildlife Service). Information on these rivers is also available at: <http://www.rivers.gov/>.

17. **Tribal Rights.** No activity or its operation may impair reserved tribal rights, including, but not limited to, reserved water rights and treaty fishing and hunting rights.

18. **Endangered Species.**

(a) No activity is authorized under any NWP which is likely to directly or indirectly jeopardize the continued existence of a threatened or endangered species or a species proposed for such designation, as identified under the Federal Endangered Species Act (ESA), or which will directly or indirectly destroy or adversely modify the critical habitat of such species. No activity is authorized under any NWP which “may affect” a listed species or critical habitat unless ESA section 7 consultation addressing the consequences of the proposed activity on listed species or critical habitat has been completed. See 50 CFR 402.02 for the definition of “effects of the action” for the purposes of ESA section 7 consultation, as well as 50 CFR 402.17, which provides further explanation under ESA section 7 regarding “activities that are reasonably certain to occur” and “consequences caused by the proposed action.”

(b) Federal agencies should follow their own procedures for complying with the requirements of the ESA (see 33 CFR 330.4(f)(1)). If pre-construction notification is required for the proposed activity, the Federal permittee must provide the district engineer with the appropriate documentation to demonstrate compliance with those requirements. The district engineer will verify that the appropriate documentation has been submitted. If the appropriate documentation has not been submitted, additional ESA section 7 consultation may be necessary for the activity and the respective federal agency would be responsible for fulfilling its obligation under section 7 of the ESA.

\* (c) Non-federal permittees must submit a pre-construction notification to the district engineer if any listed species or designated critical habitat might be affected or is in the vicinity of the activity, or if the activity is located in designated critical habitat, and shall not begin work on the activity until notified by the district engineer that the requirements of the ESA have been satisfied and that the activity is authorized. For activities that might affect Federally-listed endangered or threatened species or designated critical habitat, the pre-construction notification must include the name(s) of the endangered or threatened species that might be affected by the proposed activity or that utilize the designated critical habitat that might be affected by the proposed activity. The district engineer will determine whether the proposed activity “may affect” or will have “no effect” to listed species and designated critical habitat and will notify the non-Federal applicant of the Corps’ determination within 45 days of receipt of a complete pre-construction notification. For activities where the non-Federal applicant has identified listed species or critical habitat that might be affected or is in the vicinity of the activity, and has so notified the Corps, the applicant shall not begin work until the Corps has provided notification that the proposed activity will have “no effect” on listed species or critical habitat, or until ESA section 7 consultation has been completed. If the non-Federal applicant has not heard back from the Corps within 45 days, the applicant must still wait for notification from the Corps.

(d) As a result of formal or informal consultation with the FWS or NMFS the district engineer may add species specific permit conditions to the NWPs.



(e) Authorization of an activity by an NWP does not authorize the “take” of a threatened or endangered species as defined under the ESA. In the absence of separate authorization (e.g., an ESA Section 10 Permit, a Biological Opinion with “incidental take” provisions, etc.) from the FWS or the NMFS, the Endangered Species Act prohibits any person subject to the jurisdiction of the United States to take a listed species, where “take” means to harass, harm, pursue, hunt, shoot, wound, kill, trap, capture, or collect, or to attempt to engage in any such conduct. The word “harm” in the definition of “take” means an act which actually kills or injures wildlife. Such an act may include significant habitat modification or degradation where it actually kills or injures wildlife by significantly impairing essential behavioral patterns, including breeding, feeding or sheltering.

(f) If the non-federal permittee has a valid ESA section 10(a)(1)(B) incidental take permit with an approved Habitat Conservation Plan for a project or a group of projects that includes the proposed NWP activity, the non-federal applicant should provide a copy of that ESA section 10(a)(1)(B) permit with the PCN required by paragraph (c) of this general condition. The district engineer will coordinate with the agency that issued the ESA section 10(a)(1)(B) permit to determine whether the proposed NWP activity and the associated incidental take were considered in the internal ESA section 7 consultation conducted for the ESA section 10(a)(1)(B) permit. If that coordination results in concurrence from the agency that the proposed NWP activity and the associated incidental take were considered in the internal ESA section 7 consultation for the ESA section 10(a)(1)(B) permit, the district engineer does not need to conduct a separate ESA section 7 consultation for the proposed NWP activity. The district engineer will notify the non-federal applicant within 45 days of receipt of a complete pre- construction notification whether the ESA section 10(a)(1)(B) permit covers the proposed NWP activity or whether additional ESA section 7 consultation is required.

(g) Information on the location of threatened and endangered species and their critical habitat can be obtained directly from the offices of the FWS and NMFS or their worldwide Web pages at <http://www.fws.gov/> or <http://www.fws.gov/ipac> and <http://www.nmfs.noaa.gov/pr/species/esa/> respectively.

19. **Migratory Birds and Bald and Golden Eagles.** The permittee is responsible for ensuring that an action authorized by NWP complies with the Migratory Bird Treaty Act and the Bald and Golden Eagle Protection Act. The permittee is responsible for contacting the appropriate local office of the U.S. Fish and Wildlife Service to determine what measures, if any, are necessary or appropriate to reduce adverse effects to migratory birds or eagles, including whether “incidental take” permits are necessary and available under the Migratory Bird Treaty Act or Bald and Golden Eagle Protection Act for a particular activity.

20. **Historic Properties.**

(a) No activity is authorized under any NWP which may have the potential to cause effects to properties listed, or eligible for listing, in the National Register of Historic Places until the requirements of Section 106 of the National Historic Preservation Act (NHPA) have been satisfied.

(b) Federal permittees should follow their own procedures for complying with the requirements of section 106 of the National Historic Preservation Act (see 33 CFR 330.4(g)(1)). If pre- construction notification is required for the proposed NWP activity, the Federal permittee must provide the district engineer with the appropriate documentation to demonstrate compliance with those requirements. The district engineer will verify that the appropriate documentation has been submitted. If the appropriate documentation is not submitted, then additional

## P-10

consultation under section 106 may be necessary. The respective federal agency is responsible for fulfilling its obligation to comply with section 106.

- \* (c) Non-federal permittees must submit a pre-construction notification to the district engineer if the NWP activity might have the potential to cause effects to any historic properties listed on, determined to be eligible for listing on, or potentially eligible for listing on the National Register of Historic Places, including previously unidentified properties. For such activities, the pre-construction notification must state which historic properties might have the potential to be affected by the proposed NWP activity or include a vicinity map indicating the location of the historic properties or the potential for the presence of historic properties. Assistance regarding information on the location of, or potential for, the presence of historic properties can be sought from the State Historic Preservation Officer, Tribal Historic Preservation Officer, or designated tribal representative, as appropriate, and the National Register of Historic Places (see 33 CFR 330.4(g)). When reviewing pre-construction notifications, district engineers will comply with the current procedures for addressing the requirements of section 106 of the National Historic Preservation Act. The district engineer shall make a reasonable and good faith effort to carry out appropriate identification efforts commensurate with potential impacts, which may include background research, consultation, oral history interviews, sample field investigation, and/or field survey. Based on the information submitted in the PCN and these identification efforts, the district engineer shall determine whether the proposed NWP activity has the potential to cause effects on the historic properties. Section 106 consultation is not required when the district engineer determines that the activity does not have the potential to cause effects on historic properties (see 36 CFR 800.3(a)). Section 106 consultation is required when the district engineer determines that the activity has the potential to cause effects on historic properties. The district engineer will conduct consultation with consulting parties identified under 36 CFR 800.2(c) when he or she makes any of the following effect determinations for the purposes of section 106 of the NHPA: no historic properties affected, no adverse effect, or adverse effect.

(d) Where the non-Federal applicant has identified historic properties on which the proposed NWP activity might have the potential to cause effects and has so notified the Corps, the non-Federal applicant shall not begin the activity until notified by the district engineer either that the activity has no potential to cause effects to historic properties or that NHPA section 106 consultation has been completed. For non-federal permittees, the district engineer will notify the prospective permittee within 45 days of receipt of a complete pre-construction notification whether NHPA section 106 consultation is required. If NHPA section 106 consultation is required, the district engineer will notify the non-Federal applicant that he or she cannot begin the activity until section 106 consultation is completed. If the non-Federal applicant has not heard back from the Corps within 45 days, the applicant must still wait for notification from the Corps.

(e) Prospective permittees should be aware that section 110k of the NHPA (54 U.S.C. 306113) prevents the Corps from granting a permit or other assistance to an applicant who, with intent to avoid the requirements of section 106 of the NHPA, has intentionally significantly adversely affected a historic property to which the permit would relate, or having legal power to prevent it, allowed such significant adverse effect to occur, unless the Corps, after consultation with the Advisory Council on Historic Preservation (ACHP), determines that circumstances justify granting such assistance despite the adverse effect created or permitted by the applicant. If circumstances justify granting the assistance, the Corps is required to notify the ACHP and provide documentation specifying the circumstances, the degree of damage to the integrity of any historic properties affected, and proposed mitigation. This documentation must include any views obtained from the applicant, SHPO/THPO, appropriate Indian tribes if the undertaking occurs on or affects historic properties on tribal lands or affects properties of

# P-11

interest to those tribes, and other parties known to have a legitimate interest in the impacts to the permitted activity on historic properties.

21. **Discovery of Previously Unknown Remains and Artifacts.** Permittees that discover any previously unknown historic, cultural or archeological remains and artifacts while accomplishing the activity authorized by NWP, they must immediately notify the district engineer of what they have found, and to the maximum extent practicable, avoid construction activities that may affect the remains and artifacts until the required coordination has been completed. The district engineer will initiate the Federal, Tribal, and state coordination required to determine if the items or remains warrant a recovery effort or if the site is eligible for listing in the National Register of Historic Places.

22. **Designated Critical Resource Waters.** Critical resource waters include, NOAA-managed marine sanctuaries and marine monuments, and National Estuarine Research Reserves. The district engineer may designate, after notice and opportunity for public comment, additional waters officially designated by a state as having particular environmental or ecological significance, such as outstanding national resource waters or state natural heritage sites. The district engineer may also designate additional critical resource waters after notice and opportunity for public comment.

(a) Discharges of dredged or fill material into waters of the United States are not authorized by NWPs 7, 12, 14, 16, 17, 21, 29, 31, 35, 39, 40, 42, 43, 44, 49, 50, 51, 52, 57 and 5258 for any activity within, or directly affecting, critical resource waters, including wetlands adjacent to such waters.

(b) For NWPs 3, 8, 10, 13, 15, 18, 19, 22, 23, 25, 27, 28, 30, 33, 34, 36, 37, 38, and 54, notification is required in accordance with general condition 32, for any activity proposed by permittees in the designated critical resource waters including wetlands adjacent to those waters. The district engineer may authorize activities under these NWPs only after she or he determines that the impacts to the critical resource waters will be no more than minimal.

23. **Mitigation.** The district engineer will consider the following factors when determining appropriate and practicable mitigation necessary to ensure that the individual and cumulative adverse environmental effects are no more than minimal:

(a) The activity must be designed and constructed to avoid and minimize adverse effects, both temporary and permanent, to waters of the United States to the maximum extent practicable at the project site (*i.e.*, on site).

(b) Mitigation in all its forms (avoiding, minimizing, rectifying, reducing, or compensating for resource losses) will be required to the extent necessary to ensure that the individual and cumulative adverse environmental effects are no more than minimal.

(c) Compensatory mitigation at a minimum one-for-one ratio will be required for all wetland losses that exceed 1/10-acre and require pre-construction notification, unless the district engineer determines in writing that either some other form of mitigation would be more environmentally appropriate or the adverse environmental effects of the proposed activity are no more than minimal, and provides an activity-specific waiver of this requirement. For wetland losses of 1/10-acre or less that require pre-construction notification, the district engineer may determine on a case-by-case basis that compensatory mitigation is required to ensure that the activity results in only minimal adverse environmental effects.

(d) Compensatory mitigation at a minimum one-for-one ratio will be required for all losses of stream bed that exceed 1/103/100-acre and require pre-construction notification, unless the district engineer determines in writing that either some other form of mitigation would be more environmentally appropriate or the adverse environmental effects of the proposed activity are no more than minimal, and provides an activity-specific waiver of this requirement. This compensatory mitigation requirement may be satisfied through the restoration or enhancement of riparian areas next to streams in accordance with paragraph (e) of this general condition. For losses of stream bed of 1/103/100-acre or less that require pre-construction notification, the district engineer may determine on a case-by-case basis that compensatory mitigation is required to ensure that the activity results in only minimal adverse environmental effects. Compensatory mitigation for losses of streams should be provided, if practicable, through stream rehabilitation, enhancement, or preservation since streams are difficult-to-replace resources (see 33 CFR 332.3(e)(3)).

(e) Compensatory mitigation plans for NWP activities in or near streams or other open waters will normally include a requirement for the restoration or enhancement, maintenance, and legal protection (e.g., conservation easements) of riparian areas next to open waters. In some cases, the restoration or maintenance/protection of riparian areas may be the only compensatory mitigation required. If restoring riparian areas involves planting vegetation, only native species should be planted. The width of the required riparian area will address documented water quality or aquatic habitat loss concerns. Normally, the riparian area will be 25 to 50 feet wide on each side of the stream, but the district engineer may require slightly wider riparian areas to address documented water quality or habitat loss concerns. If it is not possible to restore or maintain/protect a riparian area on both sides of a stream, or if the waterbody is a lake or coastal waters, then restoring or maintaining/protecting a riparian area along a single bank or shoreline may be sufficient. Where both wetlands and open waters exist on the project site, the district engineer will determine the appropriate compensatory mitigation (e.g., riparian areas and/or wetlands compensation) based on what is best for the aquatic environment on a watershed basis. In cases where riparian areas are determined to be the most appropriate form of minimization or compensatory mitigation, the district engineer may waive or reduce the requirement to provide wetland compensatory mitigation for wetland losses.

(f) Compensatory mitigation projects provided to offset losses of aquatic resources must comply with the applicable provisions of 33 CFR part 332.

(1) The prospective permittee is responsible for proposing an appropriate compensatory mitigation option if compensatory mitigation is necessary to ensure that the activity results in no more than minimal adverse environmental effects. For the NWPs, the preferred mechanism for providing compensatory mitigation is mitigation bank credits or in-lieu fee program credits (see 33 CFR 332.3(b)(2) and (3)). However, if an appropriate number and type of mitigation bank or in-lieu credits are not available at the time the PCN is submitted to the district engineer, the district engineer may approve the use of permittee-responsible mitigation.

(2) The amount of compensatory mitigation required by the district engineer must be sufficient to ensure that the authorized activity results in no more than minimal individual and cumulative adverse environmental effects (see 33 CFR 330.1(e)(3)). (See also 33 CFR 332.3(f)).

## P-13

- (3) Since the likelihood of success is greater and the impacts to potentially valuable uplands are reduced, aquatic resource restoration should be the first compensatory mitigation option considered for permittee-responsible mitigation.
- (4) If permittee-responsible mitigation is the proposed option, the prospective permittee is responsible for submitting a mitigation plan. A conceptual or detailed mitigation plan may be used by the district engineer to make the decision on the NWP verification request, but a final mitigation plan that addresses the applicable requirements of 33 CFR 332.4(c)(2) through (14) must be approved by the district engineer before the permittee begins work in waters of the United States, unless the district engineer determines that prior approval of the final mitigation plan is not practicable or not necessary to ensure timely completion of the required compensatory mitigation (see 33 CFR 332.3(k)(3)). If permittee-responsible mitigation is the proposed option, and the proposed compensatory mitigation site is located on land in which another federal agency holds an easement, the district engineer will coordinate with that federal agency to determine if proposed compensatory mitigation project is compatible with the terms of the easement.
- (5) If mitigation bank or in-lieu fee program credits are the proposed option, the mitigation plan needs to address only the baseline conditions at the impact site and the number of credits to be provided (see 33 CFR 332.4(c)(1)(ii)).
- (6) Compensatory mitigation requirements (e.g., resource type and amount to be provided as compensatory mitigation, site protection, ecological performance standards, monitoring requirements) may be addressed through conditions added to the NWP authorization, instead of components of a compensatory mitigation plan (see 33 CFR 332.4(c)(1)(ii)).
- (g) Compensatory mitigation will not be used to increase the acreage losses allowed by the acreage limits of the NWPs. For example, if an NWP has an acreage limit of 1/2-acre, it cannot be used to authorize any NWP activity resulting in the loss of greater than 1/2-acre of waters of the United States, even if compensatory mitigation is provided that replaces or restores some of the lost waters. However, compensatory mitigation can and should be used, as necessary, to ensure that an NWP activity already meeting the established acreage limits also satisfies the no more than minimal impact requirement for the NWPs.
- (h) Permittees may propose the use of mitigation banks, in-lieu fee programs, or permittee-responsible mitigation. When developing a compensatory mitigation proposal, the permittee must consider appropriate and practicable options consistent with the framework at 33 CFR 332.3(b). For activities resulting in the loss of marine or estuarine resources, permittee-responsible mitigation may be environmentally preferable if there are no mitigation banks or in-lieu fee programs in the area that have marine or estuarine credits available for sale or transfer to the permittee. For permittee-responsible mitigation, the special conditions of the NWP verification must clearly indicate the party or parties responsible for the implementation and performance of the compensatory mitigation project, and, if required, its long-term management.
- (i) Where certain functions and services of waters of the United States are permanently adversely affected by a regulated activity, such as discharges of dredged or fill material into waters of the United States that will convert a forested or scrub-shrub wetland to an herbaceous wetland in a permanently maintained utility line right-of-way, mitigation may be required to reduce the adverse environmental effects of the activity to the no more than minimal level.

24. **Safety of Impoundment Structures.** To ensure that all impoundment structures are safely designed, the district engineer may require non-Federal applicants to demonstrate that the structures comply with established state or federal, dam safety criteria or have been designed by qualified persons. The district engineer may also require documentation that the design has been independently reviewed by similarly qualified persons, and appropriate modifications made to ensure safety.

25. **Water Quality.**

(a) Where the certifying authority (state, authorized tribe, or EPA, as appropriate) has not previously certified compliance of an NWP with CWA section 401, a CWA section 401 water quality certification for the proposed discharge must be obtained or waived (see 33 CFF 330.4(c)). If the permittee cannot comply with all of the conditions of a water quality certification previously issued by certifying authority for the issuance of the NWP, then the permittee must obtain a water quality certification or waiver for the proposed discharge in order for the activity to be authorized by an NWP.

(b) If the NWP activity requires pre-construction notification and the certifying authority has not previously certified compliance of an NWP with CWA section 401, the proposed discharge is not authorized by an NWP until water quality certification is obtained or waived. If the certifying authority issues a water quality certification for the proposed discharge, the permittee must submit a copy of the certification to the district engineer. The discharge is not authorized by an NWP until the district engineer has notified the permittee that the water quality certification requirement has been satisfied by the issuance of a water quality certification or a waiver.

(c) The district engineer or certifying authority may require additional water quality management measures to ensure that the authorized activity does not result in more than minimal degradation of water quality.

26. **Coastal Zone Management.** In coastal states where an NWP has not previously received a state coastal zone management consistency concurrence, an individual state coastal zone management consistency concurrence must be obtained, or a presumption of concurrence must occur (see 33 CFR 330.4(d)). If the permittee cannot comply with all of the conditions of a coastal zone management consistency concurrence previously issued by the state, then the permittee must obtain an individual coastal zone management consistency concurrence or presumption of concurrence in order for the activity to be authorized by an NWP. The district engineer or a state may require additional measures to ensure that the authorized activity is consistent with state coastal zone management requirements.

27. **Regional and Case-By-Case Conditions.** The activity must comply with any regional conditions that may have been added by the Division Engineer (see 33 CFR 330.4(e)) and with any case specific conditions added by the Corps or by the state, Indian Tribe, or U.S. EPA in its CWA section 401 Water Quality Certification, or by the state in its Coastal Zone Management Act consistency determination.

28. **Use of Multiple Nationwide Permits.** The use of more than one NWP for a single and complete project is authorized, subject to the following restrictions:

(a) If only one of the NWPs used to authorize the single and complete project has a specified acreage limit, the acreage loss of waters of the United States cannot exceed the acreage limit of the NWP with the highest specified acreage limit. For example, if a road crossing over tidal

waters is constructed under NWP 14, with associated bank stabilization authorized by NWP 13, the maximum acreage loss of waters of the United States for the total project cannot exceed 1/3-acre.

(b) If one or more of the NWPs used to authorize the single and complete project has specified acreage limits, the acreage loss of waters of the United States authorized by those NWPs cannot exceed their respective specified acreage limits. For example, if a commercial development is constructed under NWP 39, and the single and complete project includes the filling of an upland ditch authorized by NWP 46, the maximum acreage loss of waters of the United States for the commercial development under NWP 39 cannot exceed 1/2-acre, and the total acreage loss of waters of United States due to the NWP 39 and 46 activities cannot exceed 1 acre.

**29. Transfer of Nationwide Permit Verifications.** If the permittee sells the property associated with a nationwide permit verification, the permittee may transfer the nationwide permit verification to the new owner by submitting a letter to the appropriate Corps district office to validate the transfer. A copy of the nationwide permit verification must be attached to the letter, and the letter must contain the following statement and signature:

*“When the structures or work authorized by this nationwide permit are still in existence at the time the property is transferred, the terms and conditions of this nationwide permit, including any special conditions, will continue to be binding on the new owner(s) of the property. To validate the transfer of this nationwide permit and the associated liabilities associated with compliance with its terms and conditions, have the transferee sign and date below.”*

---

(Transferee)

---

(Date)

\* **30. Compliance Certification.** Each permittee who receives an NWP verification letter from the Corps must provide a signed certification documenting completion of the authorized activity and implementation of any required compensatory mitigation. The success of any required permittee-responsible mitigation, including the achievement of ecological performance standards, will be addressed separately by the district engineer. The Corps will provide the permittee the certification document with the NWP verification letter. The certification document will include:

(a) A statement that the authorized activity was done in accordance with the NWP authorization, including any general, regional, or activity-specific conditions;

(b) A statement that the implementation of any required compensatory mitigation was completed in accordance with the permit conditions. If credits from a mitigation bank or in-lieu fee program are used to satisfy the compensatory mitigation requirements, the certification must include the documentation required by 33 CFR 332.3(l)(3) to confirm that the permittee secured the appropriate number and resource type of credits; and

(c) The signature of the permittee certifying the completion of the activity and mitigation. The completed certification document must be submitted to the district engineer within 30 days of completion of the authorized activity or the implementation of any required compensatory mitigation, whichever occurs later.

# P-16

- \* 31. **Activities Affecting Structures or Works Built by the United States.** If an NWP activity also requires permission from the Corps pursuant to 33 U.S.C. 408 because it will alter or temporarily or permanently occupy or use a U.S. Army Corps of Engineers (USACE) federally authorized Civil Works project (a “USACE project”), the prospective permittee must submit a pre-construction notification. See paragraph (b)(10) of general condition 32. An activity that requires section 408 permission and/or review is not authorized by an NWP until the appropriate Corps office issues the section 408 permission or completes its review to alter, occupy, or use the USACE project, and the district engineer issues a written NWP verification.
- \* 32. **Pre-Construction Notification.**

(a) *Timing.* Where required by the terms of the NWP, the permittee must notify the district engineer by submitting a pre-construction notification (PCN) as early as possible. The district engineer must determine if the PCN is complete within 30 calendar days of the date of receipt and, if the PCN is determined to be incomplete, notify the prospective permittee within that 30 day period to request the additional information necessary to make the PCN complete. The request must specify the information needed to make the PCN complete. As a general rule, district engineers will request additional information necessary to make the PCN complete only once. However, if the prospective permittee does not provide all of the requested information, then the district engineer will notify the prospective permittee that the PCN is still incomplete and the PCN review process will not commence until all of the requested information has been received by the district engineer. The prospective permittee shall not begin the activity until either:

(1) He or she is notified in writing by the district engineer that the activity may proceed under the NWP with any special conditions imposed by the district or division engineer; or

(2) 45 calendar days have passed from the district engineer’s receipt of the complete PCN and the prospective permittee has not received written notice from the district or division engineer. However, if the permittee was required to notify the Corps pursuant to general condition 18 that listed species or critical habitat might be affected or are in the vicinity of the activity, or to notify the Corps pursuant to general condition 20 that the activity might have the potential to cause effects to historic properties, the permittee cannot begin the activity until receiving written notification from the Corps that there is “no effect” on listed species or “no potential to cause effects” on historic properties, or that any consultation required under Section 7 of the Endangered Species Act (see 33 CFR 330.4(f)) and/or section 106 of the National Historic Preservation Act (see 33 CFR 330.4(g)) has been completed. If the proposed activity requires a written waiver to exceed specified limits of an NWP, the permittee may not begin the activity until the district engineer issues the waiver. If the district or division engineer notifies the permittee in writing that an individual permit is required within 45 calendar days of receipt of a complete PCN, the permittee cannot begin the activity until an individual permit has been obtained. Subsequently, the permittee’s right to proceed under the NWP may be modified, suspended, or revoked only in accordance with the pr set forth in 33 CFR 330.5(d)(2).

(b) *Contents of Pre-Construction Notification:* The PCN must be in writing and include the following information:

- (1) Name, address and telephone numbers of the prospective permittee;
- (2) Location of the proposed activity;



- (3) Identify the specific NWP or NWP(s) the prospective permittee wants to use to authorize the proposed activity;
- (4)
  - (i) A description of the proposed activity; the activity's purpose; direct and indirect adverse environmental effects the activity would cause, including the anticipated amount of loss of wetlands, other special aquatic sites, and other waters expected to result from the NWP activity, in acres, linear feet, or other appropriate unit of measure; a description of any proposed mitigation measures intended to reduce the adverse environmental effects caused by the proposed activity; and any other NWP(s), regional general permit(s), or individual permit(s) used or intended to be used to authorize any part of the proposed project or any related activity, including other separate and distant crossings for linear projects that require Department of the Army authorization but do not require pre-construction notification. The description of the proposed activity and any proposed mitigation measures should be sufficiently detailed to allow the district engineer to determine that the adverse environmental effects of the activity will be no more than minimal and to determine the need for compensatory mitigation or other mitigation measures.
  - (ii) For linear projects where one or more single and complete crossings require pre-construction notification, the PCN must include the quantity of anticipated losses of wetlands, other special aquatic sites, and other waters for each single and complete crossing of those wetlands, other special aquatic sites, and other waters (including those single and complete crossings authorized by an NWP but do not require PCNs). This information will be used by the district engineer to evaluate the cumulative adverse environmental effects of the proposed linear project and does not change those non-PCN NWP activities into NWP PCNs.
  - (iii) Sketches should be provided when necessary to show that the activity complies with the terms of the NWP. (Sketches usually clarify the activity and when provided results in a quicker decision. Sketches should contain sufficient detail to provide an illustrative description of the proposed activity (e.g., a conceptual plan), but do not need to be detailed engineering plans).
- (5) The PCN must include a delineation of wetlands, other special aquatic sites, and other waters, such as lakes and ponds, and perennial and intermittent streams, on the project site. Wetland delineations must be prepared in accordance with the current method required by the Corps. The permittee may ask the Corps to delineate the special aquatic sites and other waters on the project site, but there may be a delay if the Corps does the delineation, especially if the project site is large or contains many wetlands, other special aquatic sites, and other waters. Furthermore, the 45-day period will not start until the delineation has been submitted to or completed by the Corps, as appropriate.
- (6) If the proposed activity will result in the loss of greater than 1/10-acre of wetlands or 3/100-acre of stream bed and a PCN is required, the prospective permittee must submit a statement describing how the mitigation requirement will be satisfied, or explaining why the adverse environmental effects are no more than minimal and why compensatory mitigation should not be required. As an alternative, the prospective permittee may submit a conceptual or detailed mitigation plan.
- (7) For non-federal permittees, if any listed species (or species proposed for listing) or designated critical habitat (or critical habitat proposed for such designation) might be

# P-18

affected or is in the vicinity of the activity, or if the activity is located in designated critical habitat (or critical habitat proposed for such designation), the PCN must include the name(s) of those endangered or threatened species (or species proposed for listing) that might be affected by the proposed activity or utilize the designated critical habitat (or critical habitat proposed for such designation) that might be affected by the proposed activity. For NWP activities that require pre-construction notification, Federal permittees must provide documentation demonstrating compliance with the Endangered Species Act.

(8) For non-federal permittees, if the NWP activity might have the potential to cause effects to a historic property listed on, determined to be eligible for listing on, or potentially eligible for listing on, the National Register of Historic Places, the PCN must state which historic property might have the potential to be affected by the proposed activity or include a vicinity map indicating the location of the historic property. For NWP activities that require pre-construction notification, Federal permittees must provide documentation demonstrating compliance with section 106 of the National Historic Preservation Act.

(9) For an activity that will occur in a component of the National Wild and Scenic River System, or in a river officially designated by Congress as a “study river” for possible inclusion in the system while the river is in an official study status, the PCN must identify the Wild and Scenic River or the “study river” (see general condition 16); and

(10) For an NWP activity that requires permission from, or review by, the Corps pursuant to 33 U.S.C. 408 because it will alter or temporarily or permanently occupy or use a U.S. Army Corps of Engineers federally authorized civil works project, the pre-construction notification must include a statement confirming that the project proponent has submitted a written request for section 408 permission from, or review by, the Corps office having jurisdiction over that USACE project.

(c) *Form of Pre-Construction Notification:* The nationwide permit pre-construction notification form (Form ENG 6082) should be used for NWP PCNs. A letter containing the required information may also be used. Applicants may provide electronic files of PCNs and supporting materials if the district engineer has established tools and procedures for electronic submittals.

(d) *Agency Coordination:*

(1) The district engineer will consider any comments from Federal and state agencies concerning the proposed activity’s compliance with the terms and conditions of the NWPs and the need for mitigation to reduce the activity’s adverse environmental effects so that they are no more than minimal.

(2) Agency coordination is required for:

(i) All NWP activities that require pre-construction notification and result in the loss of greater than 1/2-acre of waters of the United States;

(ii) NWP 13 activities in excess of 500 linear feet, fills greater than one cubic yard per running foot, or involve discharges of dredged or fill material into special aquatic sites; and

(iii) NWP 54 activities in excess of 500 linear feet, or that extend into the waterbody more than 30 feet from the mean low water line in tidal waters or the ordinary high water mark in the Great Lakes.

(3) When agency coordination is required, the district engineer will immediately provide (e.g., via email, facsimile transmission, overnight mail, or other expeditious manner) a copy of the complete PCN to the appropriate Federal or state offices (FWS, state natural resource or water quality agency, EPA, and, if appropriate, the NMFS). With the exception of NWP 37, these agencies will have 10 calendar days from the date the material is transmitted to notify the district engineer via telephone, facsimile transmission, or email that they intend to provide substantive, site-specific comments. The comments must explain why the agency believes the adverse environmental effects will be more than minimal. If so, contacted by an agency, the district engineer will wait an additional 15 calendar days before making a decision on the pre- construction notification. The district engineer will fully consider agency comments received within the specified time frame concerning the proposed activity's compliance with the terms and conditions of the NWPs, including the need for mitigation to ensure that the net adverse environmental effects of the proposed activity are no more than minimal. The district engineer will provide no response to the resource agency, except as provided below. The district engineer will indicate in the administrative record associated with each pre-construction notification that the resource agencies' concerns were considered. For NWP 37, the emergency watershed protection and rehabilitation activity may proceed immediately in cases where there is an unacceptable hazard to life or a significant loss of property or economic hardship will occur. The district engineer will consider any comments received to decide whether the NWP 37 authorization should be modified, suspended, or revoked in accordance with the procedures at 33 CFR 330.5.

(4) In cases of where the prospective permittee is not a Federal agency, the district engineer will provide a response to NMFS within 30 calendar days of receipt of any Essential Fish Habitat conservation recommendations, as required by section 305(b)(4)(B) of the Magnuson-Stevens Fishery Conservation and Management Act.

(5) Applicants are encouraged to provide the Corps with either electronic files or multiple copies of pre-construction notifications to expedite agency coordination.

## **DISTRICT ENGINEER'S DECISION**

1. In reviewing the PCN for the proposed activity, the district engineer will determine whether the activity authorized by the NWP will result in more than minimal individual or cumulative adverse environmental effects or may be contrary to the public interest. If a project proponent requests authorization by a specific NWP, the district engineer should issue the NWP verification for that activity if it meets the terms and conditions of that NWP, unless he or she determines, after considering mitigation, that the proposed activity will result in more than minimal individual and cumulative adverse effects on the aquatic environment and other aspects of the public interest and exercises discretionary authority to require an individual permit for the proposed activity. For a linear project, this determination will include an evaluation of the single and complete crossings of waters of the United States that require PCNs to determine whether they individually satisfy the terms and conditions of the NWP(s), as well as the cumulative effects caused by all of the crossings of waters of the United States authorized by an NWP. If an applicant requests a waiver of an applicable limit, as provided for in NWPs 13, 36, or 54, the district engineer will only grant the waiver upon a written determination that the NWP activity will result in only minimal individual and cumulative adverse environmental effects.

2. When making minimal adverse environmental effects determinations the district engineer will consider the direct and indirect effects caused by the NWP activity. He or she will also consider the cumulative adverse environmental effects caused by activities authorized by an NWP and whether those cumulative adverse environmental effects are no more than minimal. The district engineer will also consider site specific factors, such as the environmental setting in the vicinity of the NWP activity, the type of resource that will be affected by the NWP activity, the functions provided by the aquatic resources that will be affected by the NWP activity, the degree or magnitude to which the aquatic resources perform those functions, the extent that aquatic resource functions will be lost as a result of the NWP activity (e.g., partial or complete loss), the duration of the adverse effects (temporary or permanent), the importance of the aquatic resource functions to the region (e.g., watershed or ecoregion), and mitigation required by the district engineer. If an appropriate functional or condition assessment method is available and practicable to use, that assessment method may be used by the district engineer to assist in the minimal adverse environmental effects determination. The district engineer may add case-specific special conditions to the NWP authorization to address site-specific environmental concerns.

3. If the proposed activity requires a PCN and will result in a loss of greater than 1/10-acre of wetlands or 3/100-acre of stream bed, the prospective permittee should submit a mitigation proposal with the PCN. Applicants may also propose compensatory mitigation for NWP activities with smaller impacts, or for impacts to other types of waters. The district engineer will consider any proposed compensatory mitigation or other mitigation measures the applicant has included in the proposal in determining whether the net adverse environmental effects of the proposed activity are no more than minimal. The compensatory mitigation proposal may be either conceptual or detailed. If the district engineer determines that the activity complies with the terms and conditions of the NWP and that the adverse environmental effects are no more than minimal, after considering mitigation, the district engineer will notify the permittee and include any activity-specific conditions in the NWP verification the district engineer deems necessary. Conditions for compensatory mitigation requirements must comply with the appropriate provisions at 33 CFR 332.3(k). The district engineer must approve the final mitigation plan before the permittee commences work in waters of the United States, unless the district engineer determines that prior approval of the final mitigation plan is not practicable or not necessary to ensure timely completion of the required compensatory mitigation. If the prospective permittee elects to submit a compensatory mitigation plan with the PCN, the district engineer will expeditiously review the proposed compensatory mitigation plan. The district engineer must review the proposed compensatory mitigation plan within 45 calendar days of receiving a complete PCN and determine whether the proposed mitigation would ensure that the NWP activity results in no more than minimal adverse environmental effects. If the net adverse environmental effects of the NWP activity (after consideration of the mitigation proposal) are determined by the district engineer to be no more than minimal, the district engineer will provide a timely written response to the applicant. The response will state that the NWP activity can proceed under the terms and conditions of the NWP, including any activity-specific conditions added to the NWP authorization by the district engineer.

4. If the district engineer determines that the adverse environmental effects of the proposed activity are more than minimal, then the district engineer will notify the applicant either:

(a) That the activity does not qualify for authorization under the NWP and instruct the applicant on the procedures to seek authorization under an individual permit;

# P-21

(b) that the activity is authorized under the NWP subject to the applicant's submission of a mitigation plan that would reduce the adverse environmental effects so that they are no more than minimal; or

(c) that the activity is authorized under the NWP with specific modifications or conditions. Where the district engineer determines that mitigation is required to ensure no more than minimal adverse environmental effects, the activity will be authorized within the 45-day PCN period (unless additional time is required to comply with general conditions 18, 20, and/or 31), with activity-specific conditions that state the mitigation requirements. The authorization will include the necessary conceptual or detailed mitigation plan or a requirement that the applicant submit a mitigation plan that would reduce the adverse environmental effects so that they are no more than minimal. When compensatory mitigation is required, no work in waters of the United States may occur until the district engineer has approved a specific mitigation plan or has determined that prior approval of a final mitigation plan is not practicable or not necessary to ensure timely completion of the required compensatory mitigation.

## FURTHER INFORMATION

1. District engineers have authority to determine if an activity complies with the terms and conditions of an NWP.
2. NWPs do not obviate the need to obtain other federal, state, or local permits, approvals, or authorizations required by law.
3. NWPs do not grant any property rights or exclusive privileges.
4. NWPs do not authorize any injury to the property or rights of others.
5. NWPs do not authorize interference with any existing or proposed Federal project (see general condition 31).

## DEFINITIONS

**Best management practices (BMPs):** Policies, practices, procedures, or structures implemented to mitigate the adverse environmental effects on surface water quality resulting from development. BMPs are categorized as structural or non-structural.

**Compensatory mitigation:** The restoration (re-establishment or rehabilitation), establishment (creation), enhancement, and/or in certain circumstances preservation of aquatic resources for the purposes of offsetting unavoidable adverse impacts which remain after all appropriate and practicable avoidance and minimization has been achieved.

**Currently serviceable:** Useable as is or with some maintenance, but not so degraded as to essentially require reconstruction.

**Direct effects:** Effects that are caused by the activity and occur at the same time and place.

**Discharge:** The term "discharge" means any discharge of dredged or fill material into waters of the United States.

**Ecological reference:** A model used to plan and design an aquatic habitat and riparian area restoration, enhancement, or establishment activity under NWP 27. An ecological reference may be based on the structure, functions, and dynamics of an aquatic habitat type or a riparian area type that currently exists in the region where the proposed NWP 27 activity is located. Alternatively, an ecological reference may be based on a conceptual model for the aquatic habitat type or riparian area type to be restored, enhanced, or established as a result of the

proposed NWP 27 activity. An ecological reference takes into account the range of variation of the aquatic habitat type or riparian area type in the region.

Enhancement: The manipulation of the physical, chemical, or biological characteristics of an aquatic resource to heighten, intensify, or improve a specific aquatic resource function(s). Enhancement results in the gain of selected aquatic resource function(s), but may also lead to a decline in other aquatic resource function(s). Enhancement does not result in a gain in aquatic resource area.

Establishment (creation): The manipulation of the physical, chemical, or biological characteristics present to develop an aquatic resource that did not previously exist at an upland site. Establishment results in a gain in aquatic resource area.

High Tide Line: The line of intersection of the land with the water's surface at the maximum height reached by a rising tide. The high tide line may be determined, in the absence of actual data, by a line of oil or scum along shore objects, a more or less continuous deposit of fine shell or debris on the foreshore or berm, other physical markings or characteristics, vegetation lines, tidal gages, or other suitable means that delineate the general height reached by a rising tide. The line encompasses spring high tides and other high tides that occur with periodic frequency but does not include storm surges in which there is a departure from the normal or predicted reach of the tide due to the piling up of water against a coast by strong winds such as those accompanying a hurricane or other intense storm.

Historic Property: Any prehistoric or historic district, site (including archaeological site), building, structure, or other object included in, or eligible for inclusion in, the National Register of Historic Places maintained by the Secretary of the Interior. This term includes artifacts, records, and remains that are related to and located within such properties. The term includes properties of traditional religious and cultural importance to an Indian tribe or Native Hawaiian organization and that meet the National Register criteria (36 CFR part 60).

Independent utility: A test to determine what constitutes a single and complete non-linear project in the Corps Regulatory Program. A project is considered to have independent utility if it would be constructed absent the construction of other projects in the project area. Portions of a multi-phase project that depend upon other phases of the project do not have independent utility. Phases of a project that would be constructed even if the other phases were not built can be considered as separate single and complete projects with independent utility.

Indirect effects: Effects that are caused by the activity and are later in time or farther removed in distance but are still reasonably foreseeable.

Loss of waters of the United States: Waters of the United States that are permanently adversely affected by filling, flooding, excavation, or drainage because of the regulated activity. The loss of stream bed includes the acres of stream bed that are permanently adversely affected by filling or excavation because of the regulated activity. Permanent adverse effects include permanent discharges of dredged or fill material that change an aquatic area to dry land, increase the bottom elevation of a waterbody, or change the use of a waterbody. The acreage of loss of waters of the United States is a threshold measurement of the impact to jurisdictional waters or wetlands for determining whether a project may qualify for an NWP; it is not a net threshold that is calculated after considering compensatory mitigation that may be used to offset losses of aquatic functions and services. Waters of the United States temporarily filled, flooded, excavated, or drained, but restored to pre-construction contours and elevations after construction, are not included in the measurement of loss of waters of the United States.

## P-23

Nationwide Permit 23 - Activities, Regional Conditions, General Conditions, and Definitions

Impacts resulting from activities that do not require Department of the Army authorization, such as activities eligible for exemptions under section 404(f) of the Clean Water Act, are not considered when calculating the loss of waters of the United States.

Navigable waters: Waters subject to section 10 of the Rivers and Harbors Act of 1899. These waters are defined at 33 CFR part 329.

Non-tidal wetland: A non-tidal wetland is a wetland that is not subject to the ebb and flow of tidal waters. Non-tidal wetlands contiguous to tidal waters are located landward of the high tide line (i.e., spring high tide line).

Open water: For purposes of the NWP, an open water is any area that in a year with normal patterns of precipitation has water flowing or standing above ground to the extent that an ordinary high water mark can be determined. Aquatic vegetation within the area of flowing or standing water is either non-emergent, sparse, or absent. Vegetated shallows are considered to be open waters. Examples of “open waters” include rivers, streams, lakes, and ponds.

Ordinary High Water Mark: The term ordinary high water mark means that line on the shore established by the fluctuations of water and indicated by physical characteristics such as a clear, natural line impressed on the bank, shelving, changes in the character of soil, destruction of terrestrial vegetation, the presence of litter and debris, or other appropriate means that consider the characteristics of the surrounding areas.

Perennial stream: A perennial stream has surface water flowing continuously year-round during a typical year.

Practicable: Available and capable of being done after taking into consideration cost, existing technology, and logistics in light of overall project purposes.

Pre-construction notification: A request submitted by the project proponent to the Corps for confirmation that a particular activity is authorized by nationwide permit. The request may be a permit application, letter, or similar document that includes information about the proposed work and its anticipated environmental effects. Pre-construction notification may be required by the terms and conditions of a nationwide permit, or by regional conditions. A pre-construction notification may be voluntarily submitted in cases where pre-construction notification is not required and the project proponent wants confirmation that the activity is authorized by nationwide permit.

Preservation: The removal of a threat to, or preventing the decline of, aquatic resources by an action in or near those aquatic resources. This term includes activities commonly associated with the protection and maintenance of aquatic resources through the implementation of appropriate legal and physical mechanisms. Preservation does not result in a gain of aquatic resource area or functions.

Re-establishment: The manipulation of the physical, chemical, or biological characteristics of a site with the goal of returning natural/historic functions to a former aquatic resource. Re-establishment results in rebuilding a former aquatic resource and results in a gain in aquatic resource area and functions.

Rehabilitation: The manipulation of the physical, chemical, or biological characteristics of a site with the goal of repairing natural/historic functions to a degraded aquatic resource.

## P-24

Nationwide Permit 23 - Activities, Regional Conditions, General Conditions, and Definitions

Rehabilitation results in a gain in aquatic resource function but does not result in a gain in aquatic resource area.

Restoration: The manipulation of the physical, chemical, or biological characteristics of a site with the goal of returning natural/historic functions to a former or degraded aquatic resource. For the purpose of tracking net gains in aquatic resource area, restoration is divided into two categories: Re-establishment and rehabilitation.

Riffle and pool complex: Riffle and pool complexes are special aquatic sites under the 404(b)(1) Guidelines. Riffle and pool complexes sometimes characterize steep gradient sections of streams. Such stream sections are recognizable by their hydraulic characteristics. The rapid movement of water over a coarse substrate in riffles results in a rough flow, a turbulent surface, and high dissolved oxygen levels in the water. Pools are deeper areas associated with riffles. A slower stream velocity, a streaming flow, a smooth surface, and a finer substrate characterize pools.

Riparian areas: Riparian areas are lands next to streams, lakes, and estuarine-marine shorelines. Riparian areas are transitional between terrestrial and aquatic ecosystems, through which surface and subsurface hydrology connects riverine, lacustrine, estuarine, and marine waters with their adjacent wetlands, non-wetland waters, or uplands. Riparian areas provide a variety of ecological functions and services and help improve or maintain local water quality. (See general condition 23.)

Shellfish seeding: The placement of shellfish seed and/or suitable substrate to increase shellfish production. Shellfish seed consists of immature individual shellfish or individual shellfish attached to shells or shell fragments (i.e., spat on shell). Suitable substrate may consist of shellfish shells, shell fragments, or other appropriate materials placed into waters for shellfish habitat.

Single and complete linear project: A linear project is a project constructed for the purpose of getting people, goods, or services from a point of origin to a terminal point, which often involves multiple crossings of one or more waterbodies at separate and distant locations. The term “single and complete project” is defined as that portion of the total linear project proposed or accomplished by one owner/developer or partnership or other association of owners/developers that includes all crossings of a single water of the United States (i.e., a single waterbody) at a specific location. For linear projects crossing a single or multiple waterbodies several times at separate and distant locations, each crossing is considered a single and complete project for purposes of NWP authorization. However, individual channels in a braided stream or river, or individual arms of a large, irregularly shaped wetland or lake, etc., are not separate waterbodies, and crossings of such features cannot be considered separately.

Single and complete non-linear project: For non-linear projects, the term “single and complete project” is defined at 33 CFR 330.2(i) as the total project proposed or accomplished by one owner/developer or partnership or other association of owners/developers. A single and complete non-linear project must have independent utility (see definition of “independent utility”). Single and complete non-linear projects may not be “piecemealed” to avoid the limits in an NWP authorization.

Stormwater management: Stormwater management is the mechanism for controlling stormwater runoff for the purposes of reducing downstream erosion, water quality degradation,



and flooding and mitigating the adverse effects of changes in land use on the aquatic environment.

Stormwater management facilities: Stormwater management facilities are those facilities, including but not limited to, stormwater retention and detention ponds and best management practices, which retain water for a period of time to control runoff and/or improve the quality (i.e., by reducing the concentration of nutrients, sediments, hazardous substances and other pollutants) of stormwater runoff.

Stream bed: The substrate of the stream channel between the ordinary high water marks. The substrate may be bedrock or inorganic particles that range in size from clay to boulders. Wetlands contiguous to the stream bed, but outside of the ordinary high water marks, are not considered part of the stream bed.

Stream channelization: The manipulation of a stream's course, condition, capacity, or location that causes more than minimal interruption of normal stream processes. A channelized jurisdictional stream remains a water of the United States.

Structure: An object that is arranged in a definite pattern of organization. Examples of structures include, without limitation, any pier, boat dock, boat ramp, wharf, dolphin, weir, boom, breakwater, bulkhead, revetment, riprap, jetty, artificial island, artificial reef, permanent mooring structure, power transmission line, permanently moored floating vessel, piling, aid to navigation, or any other manmade obstacle or obstruction.

Tidal wetland: A tidal wetland is a jurisdictional wetland that is inundated by tidal waters. Tidal waters rise and fall in a predictable and measurable rhythm or cycle due to the gravitational pulls of the moon and sun. Tidal waters end where the rise and fall of the water surface can no longer be practically measured in a predictable rhythm due to masking by other waters, wind, or other effects. Tidal wetlands are located channelward of the high tide line.

Tribal lands: Any lands title to which is either: (1) Held in trust by the United States for the benefit of any Indian tribe or individual; or (2) held by any Indian tribe or individual subject to restrictions by the United States against alienation.

Tribal rights: Those rights legally accruing to a tribe or tribes by virtue of inherent sovereign authority, unextinguished aboriginal title, treaty, statute, judicial decisions, executive order or agreement, and that give rise to legally enforceable remedies.

Vegetated shallows: Vegetated shallows are special aquatic sites under the 404(b)(1) Guidelines. They are areas that are permanently inundated and under normal circumstances have rooted aquatic vegetation, such as seagrasses in marine and estuarine systems and a variety of vascular rooted plants in freshwater systems.

Waterbody: For purposes of the NWP, a waterbody is a "water of the United States." If a wetland is adjacent to a waterbody determined to be a water of the United States, that waterbody and any adjacent wetlands are considered together as a single aquatic unit (see 33 CFR 328.4(c)(2)).

## REGIONAL CONDITIONS:

The following Regional Conditions have been approved by the Wilmington District for the Nationwide Permits (NWP) published in the January 13, 2021, and December 27, 2021, *Federal Register* (86 FR 2744 and 86 FR 73522) announcing the reissuance of 52 existing (NWP) and five new NWP, as well as the reissuance of NWP general conditions and definitions with some modifications.

### A. EXCLUDED WATER AND/OR AREAS

The Corps has identified waters that will be excluded from the use of all NWP's during certain timeframes. These waters are:

1. **Anadromous Fish Spawning Areas.** Work in waters of the U.S. designated by either the North Carolina Division of Marine Fisheries (NCDMF) or the North Carolina Wildlife Resources Commission (NCWRC) as anadromous fish spawning areas are prohibited from February 15th through June 30th, without prior written approval from the Corps and the appropriate wildlife agencies (NCDMF, NCWRC and/or the National Marine Fisheries Service (NMFS)). Work in waters of the U.S. designated by NCWRC as primary nursery areas in inland waters are prohibited from February 15th through September 30th, without prior written approval from the Corps and the appropriate wildlife agencies. Work in waters of the U.S. designated by NCDMF as primary nursery areas shall be coordinated with NCDMF prior to being authorized by this NWP. Coordination with NCDMF may result in a required construction moratorium during periods of significant biological productivity or critical life stages.
2. **Trout Waters Moratorium.** Work in waters of the U.S. in the designated trout watersheds of North Carolina are prohibited from October 15th through April 15th without prior written approval from the NCWRC, or from the Eastern Band of Cherokee Indians (EBCI) Fisheries and Wildlife Management (FWM) office if the project is located on EBCI trust land. (See Section C.3. below for information on the designated trout watersheds).
3. **Sturgeon Spawning Areas.** No in-water work shall be conducted in waters of the U.S. designated by the National Marine Fisheries Service as Atlantic sturgeon critical habitat from February 1st through June 30th. No in-water work shall be conducted in waters of the U.S. in the Roanoke River designated as Atlantic sturgeon critical habitat from February 1st through June 30th, and August 1st through October 31st, without prior written approval from NMFS.
4. **Submerged Aquatic Vegetation.** Impacts to Submerged Aquatic Vegetation (SAV) are not authorized by any NWP, except NWP 48, NWP 55 and NWP 56, unless Essential Fish Habitat (EFH) consultation has been completed pursuant to the Magnuson-Stevens Fisheries Conservation and Management Act (Magnuson-Stevens Act). Permittees shall submit a PCN (See NWP General Condition 32) to the District Engineer prior to commencing the activity if the project would affect SAV. The permittee may not begin work until notified by the Corps that the requirements of the Magnuson-Stevens Act have been satisfied and that the activity is verified.

### B. REGIONAL CONDITIONS APPLICABLE TO ALL NWP's

- \* 1. **Critical Habitat in Western NC.** For proposed activities within waters of the U.S. that require a Pre-Construction Notification (PCN) and are located in the thirteen counties listed below, permittees must provide a copy of the PCN to the U.S. Fish and Wildlife Service (USFWS), 160 Zillicoa Street, Asheville, North Carolina 28801 and the Corps Asheville Regulatory Field Office. Please see General Condition 18 for specific PCN requirements

## P-27

Nationwide Permit 23 - Activities, Regional Conditions, General Conditions, and Definitions

related to the Endangered Species Act and the below website for information on the location of designated critical habitat.

Counties with tributaries that drain to designated critical habitat that require notification to the Asheville U.S. Fish and Wildlife Service: Avery, Cherokee, Graham, Haywood, Henderson, Jackson, Macon, Mecklenburg, Mitchell, Swain, Transylvania, Union and Yancey.

Website and office addresses for Endangered Species Act Information:

The Wilmington District has developed the following website for permittees which provides guidelines on how to review linked websites and maps in order to fulfill NWP General Condition 18 (Endangered Species) requirements:

<http://www.saw.usace.army.mil/Missions/RegulatoryPermitProgram/AgencyCoordination/ESA.aspx>.

Permittees who do not have internet access may contact the appropriate U.S. Fish and Wildlife Service offices listed below or Corps at (910) 251-4850.

Below is a map of the USFWS Field Office Boundaries:

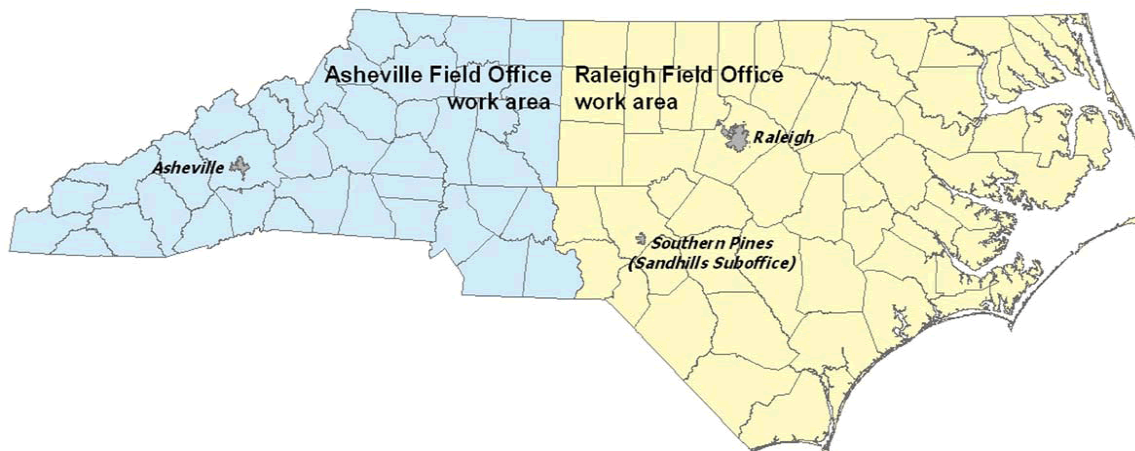

Asheville U.S. Fish and Wildlife Service Office counties: All counties west of and including Anson, Stanly, Davidson, Forsythe and Stokes Counties.

U.S. Fish and Wildlife Service  
Asheville Field Office  
160 Zillicoa Street  
Asheville, NC 28801  
Telephone: (828) 258-3939

Raleigh U.S. Fish and Wildlife Service Office counties: All counties east of and including Richmond, Montgomery, Randolph, Guilford, and Rockingham Counties.

U.S. Fish and Wildlife Service  
Raleigh Field Office  
Post Office Box 33726  
Raleigh, NC 27636-3726  
Telephone: (919) 856-4520

# P-28

- \* 2. **Special Designation Waters.** Prior to the use of any NWP that involves a discharge of dredged or fill material in any of the following identified waters and/or adjacent wetlands in North Carolina, permittees shall submit a PCN to the District Engineer prior to commencing the activity (see General Condition 32). The North Carolina waters and wetlands that require additional PCN requirements are:

“Primary Nursery Areas” (PNA), including inland PNA, as designated by the North Carolina Marine Fisheries Commission and/or the North Carolina Wildlife Resources Commission. The definition of and designated PNA waters can be found in the North Carolina State Administrative Code at Title 15A, Subchapters 3R and 10C (15A NCAC 03R .0103; 15A NCAC 10C .0502; and 15A NCAC 10C .0503) and at the following web pages:

- <http://reports.oah.state.nc.us/ncac/title%2015a%20-%20environmental%20quality/chapter%2003%20-%20marine%20fisheries/subchapter%20r/15a%20ncac%2003r%20.0103.pdf>
- <http://reports.oah.state.nc.us/ncac/title%2015a%20-%20environmental%20quality/chapter%2010%20-%20wildlife%20resources%20and%20water%20safety/subchapter%20c/15a%20ncac%2010c%20.0502.pdf>
- <http://reports.oah.state.nc.us/ncac/title%2015a%20-%20environmental%20quality/chapter%2010%20-%20wildlife%20resources%20and%20water%20safety/subchapter%20c/15a%20ncac%2010c%20.0503.pdf>

- \* 3. **Trout Waters.** Prior to any discharge of dredge or fill material into streams, waterbodies or wetlands within the 294 designated trout watersheds of North Carolina, the permittee shall submit a PCN (see General Condition 32) to the District Engineer prior to commencing the activity. The permittee shall also provide a copy of the PCN to the appropriate NCWRC office, or to the EBCI FWM Office (if the project is located on EBCI trust land), to facilitate the determination of any potential impacts to designated Trout Waters.

NCWRC and NC Trout Watersheds:

NCWRC Contact**	Counties that are entirely within Trout Watersheds*	Counties that are partially within Trout Watersheds*
-----------------	---	--

# P-29

Nationwide Permit 23 - Activities, Regional Conditions, General Conditions, and Definitions

Mountain Coordinator 645 Fish Hatchery Rd., Building B Marion, NC 28752 828-803- 6054  For NCDOT Projects:  NCDOT Coordinator 12275 Swift Rd. Oakboro, NC 28129 704-984- 1070	Alleghany Ashe Avery Graham Haywood	Jackson Macon Swain Transylvania Watauga	Burke Buncombe Caldwell Cherokee Clay Henderson Madison	McDowell Mitchell Polk Rutherford Surry Wilkes Yancey
<b>EBCI Contact**</b>	<b>Counties that are within Trout Watersheds*</b>			
Office of Natural Resources P.O. Box 1747, Cherokee, NC 28719 (828) 359-6113	Qualla Boundary and non- contiguous tracts of trust land located in portions of Swain, Jackson, Haywood, Graham and Cherokee Counties.			

\*NOTE: To determine PCN requirements, contact the Corps Asheville Regulatory Field Office at (828) 271-7980 or view maps showing trout watersheds in each County at the following webpage: <http://www.saw.usace.army.mil/Missions/Regulatory-Permit-Program/Agency-Coordination/Trout/>.

\*\*If a project is located on EBCI trust land, submit the PCN in accordance with Regional Condition C.16. Contact the Corps Asheville Regulatory Field Office at (828) 271-7980 with questions.

- \* 4. **Western NC Waters and Corridors.** The permittee shall submit a PCN (see General Condition 32) to the District Engineer prior to commencing the activity in waters of the U.S. if the activity will occur within any of the following identified waters in western North Carolina, within 0.5 mile on either side of these waters, or within 0.75 mile of the Little Tennessee River, as measured from the top of the bank of the respective water (i.e., river, stream, or creek):

Brasstown Creek  
Burningtown Creek

Cane River  
Caney Fork  
Cartoogechaye Creek  
Chattooga River  
Cheoah River  
Cowee Creek  
Cullasaja River  
Deep Creek  
Ellijay Creek  
French Broad River  
Garden Creek  
Hiwassee River  
Hominy Creek  
Iotla Creek  
Little Tennessee River (within the river or within 0.75 mile on either side of this river)  
Nantahala River  
Nolichucky River  
North Fork French Broad River  
North Toe River  
Nottley River  
Oconaluftee River (portion not located on trust/EBCI land)  
Peachtree Creek  
Shooting Creek  
Snowbird Creek  
South Toe River  
Stecoah Creek  
Swannanoa River  
Sweetwater Creek  
Tuckasegee River (also spelled Tuckaseegee or Tuckaseigee)  
Valley River  
Watauga Creek  
Watauga River  
Wayah Creek  
West Fork French Broad River

To determine PCN requirements, contact the Corps Asheville Regulatory Field Office at (828) 271-7980 or view maps for all corridors at the following webpage:

<http://www.saw.usace.army.mil/Missions/Regulatory-Permit-Program/Agency-Coordination/Designated-Special-Waters.aspx>.

5. **Limitation of Loss of Stream Bed.** NWP's may not be used for activities that may result in the loss of more than 0.05 acres of stream bed, except for NWP 32.

6. **Pre-Construction Notification for Loss of Stream Bed Exceeding 0.02 acres.** The permittee shall submit a PCN to the District Engineer prior to commencing the activity (see General Condition 32) prior to the use of any NWP for any activity that results in the loss of more than 0.02 acres of stream bed. This applies to NWP's that do not have PCN requirements as well as those NWP's that require a PCN.

7. **Mitigation for Loss of Stream Bed.** For any NWP that results in a loss of more than 0.02 acres of stream bed, the permittee shall provide a mitigation proposal to compensate for more than minimal individual and cumulative adverse impacts to the aquatic environment, unless the

District Engineer determines in writing that either some other form of mitigation would be more environmentally appropriate or the adverse effects of the proposed activity are minimal. For stream bed losses of 0.02 acres or less that require a PCN, the District Engineer may determine, on a case-by-case basis, that compensatory mitigation is required to ensure that the activity results in minimal adverse effect on the aquatic environment.

8. **Riprap.** For all NWP's that allow for the use of riprap material for bank stabilization, the following conditions shall be applied:

a. Filter cloth must be placed underneath the riprap as an additional requirement of its use in North Carolina waters. The placement of filter fabric is not required if the riprap will be pushed or "keyed" into the bank of the waterbody. A waiver from the specifications in this Regional Condition must be requested in writing.

b. Riprap shall be placed only on the stream banks, or, if it is necessary to be placed in the stream bed, the finished top elevation of the riprap should not exceed that of the original stream bed.

9. **Culvert Placement.** For all NWP's that allow for culvert placement, the following conditions shall be applied:

a. For all NWP's that involve the construction/installation of culverts, measures shall be included in the construction/installation that will promote the safe passage of fish and other aquatic organisms

Placement of culverts and other structures in streams shall be below the elevation of the streambed by one foot for all culverts with a diameter greater than 48 inches, and 20% of the culvert diameter for culverts having a diameter less than or equal to 48 inches. If the culvert outlet is submerged within a pool or scour hole and designed to provide for aquatic passage, then culvert burial into the streambed is not required.

Culvert burial is not required for structures less than 72 inch diameter/width, where the slope of the culvert will be greater than 2.5%, provided that all alternative options for flattening the slope have been investigated and aquatic life movement/connectivity has been provided when possible (e.g., rock ladders, cross vanes, sills, baffles etc.). Culvert burial is not required when bedrock is present in culvert locations.

Installation of culverts in wetlands shall ensure continuity of water movement and be designed to adequately accommodate high water or flood conditions. When roadways, causeways, or other fill projects are constructed across FEMA-designated floodways or wetlands, openings such as culverts or bridges shall be provided to maintain the natural hydrology of the system as well as prevent constriction of the floodway that may result in destabilization of streams or wetlands.

## P-32

Nationwide Permit 23 - Activities, Regional Conditions, General Conditions, and Definitions

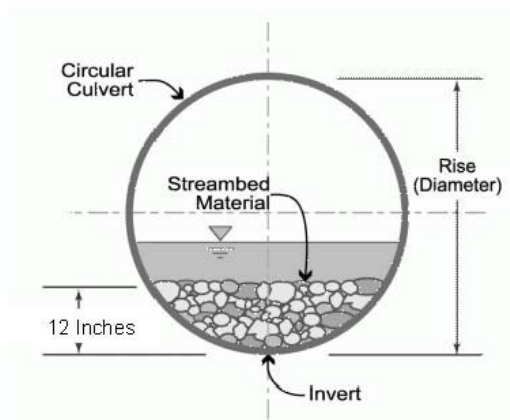

A waiver from the depth specifications in this condition may be requested, in writing, by the permittee and issued by the Corp. This waiver request must be specific as to the reason(s) for the request. The waiver will be issued if it can be demonstrated that the proposed design would result in less impacts to the aquatic environment. Culverts placed across wetland fills purely for the purposes of equalizing surface water do not have to be buried, but the culverts must be of adequate size and/or number to ensure unrestricted transmission of water.

b. Bank-full flows (or less) shall be accommodated through maintenance of the existing bank-full channel cross sectional area. Additional culverts or culvert barrels at such crossings shall be allowed only to receive bank-full flows.

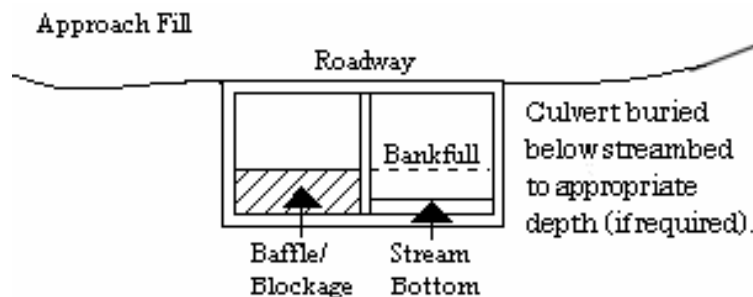

c. Culverts shall be designed and installed in such a manner that the original stream profiles are not altered and allow for aquatic life movement during low flows. The dimension, pattern, and profile of the stream above and below a pipe or culvert shall not be modified by widening the stream channel or by reducing the depth of the stream in connection with the construction activity. The width, height, and gradient of a proposed culvert shall be such as to pass the average historical low flow and spring flow without adversely altering flow velocity. If the width of the culvert is wider than the stream channel, the culvert shall include multiple boxes/pipes, baffles, benches and/or sills to maintain the natural width of the stream channel. If multiple culverts/pipes/barrels are used, low flows shall be accommodated in one culvert/pipe and additional culverts/pipes shall be installed such that they receive only flows above bankfull.

10. **Utility Lines.** For all NWP that allow for the construction and installation of utility lines, the following conditions shall be applied:

a. Utility lines consisting of aerial electric power transmission lines crossing navigable waters of the U.S. (which are defined at 33 CFR part 329) must comply with the applicable minimum clearances specified in 33 CFR 322.5(i).



b. The work area authorized by this permit, including temporary and/or permanent fills, will be minimized to the greatest extent practicable. Justification for work corridors exceeding forty (40) feet in width is required and will be based on pipeline diameter and length, size of equipment required to construct the utility line, and other construction information deemed necessary to support the request. The permittee is required to provide this information to the Corps with the initial PCN package.

c. A plan to restore and re-vegetate wetland areas cleared for construction must be submitted with the required PCN. Cleared wetland areas shall be re-vegetated, as appropriate, with species of canopy, shrub, and herbaceous species. The permittee shall not use fescue grass or any other species identified as invasive or exotic species by the NC Native Plant Society (NCNPS): <https://ncwildflower.org/invasive-exotic-species-list/>.

d. Any permanently maintained corridor along the utility right of way within forested wetlands shall be considered a loss of aquatic function. A compensatory mitigation plan will be required for all such impacts associated with the requested activity if the activity requires a PCN and the cumulative total of permanent conversion of forested wetlands exceeds 0.1 acres, unless the District Engineer determines in writing that either some other form of mitigation would be more environmentally appropriate or the adverse effects of the proposed activity are minimal.

Where permanently maintained corridor within forested wetlands is 0.1 acres or less, the District Engineer may determine, on a case-by-case basis, that compensatory mitigation is required to ensure that the activity results in minimal adverse effects on the aquatic environment.

e. When directional boring or horizontal directional drilling (HDD) under waters of the U.S., including wetlands, permittees shall closely monitor the project for hydraulic fracturing or “fracking.” Any discharge from hydraulic fracturing or “fracking” into waters of the U.S., including wetlands, shall be reported to the appropriate Corps Regulatory Field Office within 48 hours. Restoration and/or compensatory mitigation may be required as a result of any unintended discharges.

11. **Temporary Access Fills.** The permittee shall submit a PCN to the District Engineer prior to commencing the activity if the activity will involve the discharge of dredged or fill material into more than 0.1 acres of wetlands or 0.02 acres of stream channel for the construction of temporary access fills and/or temporary road crossings. The PCN must include a restoration plan that thoroughly describes how all temporary fills will be removed, how pre-project conditions will be restored, and include a timetable for all restoration activities.

12. **Federal Navigation Channel Setbacks.** Authorized structures and fills located in or adjacent to Federally authorized waterways must be constructed in accordance with the latest setback criteria established by the Wilmington District Engineer. You may review the setback policy at <http://www.saw.usace.army.mil/Missions/Navigation/Setbacks.aspx>. This general permit does not authorize the construction of hardened or permanently fixed structures within the Federally Authorized Channel Setback, unless the activity is approved by the Corps. The permittee shall submit a PCN (see General Condition 32) to the District Engineer to obtain a written verification prior to the construction of any structures or fills within the Federally Authorized Channel Setback.

13. **Northern Long-eared Bat – Endangered Species Act Compliance.** The Wilmington District, U.S. Army Corps of Engineers has consulted with the United States Fish and Wildlife

## P-34

Nationwide Permit 23 - Activities, Regional Conditions, General Conditions, and Definitions

Service (USFWS) in regard to the threatened northern long-eared bat (NLEB) (*Myotis septentrionalis*) and Standard Local Operating Procedures for Endangered Species (SLOPES) have been approved by the Corps and the USFWS. This condition concerns effects to the NLEB only and does not address effects to other federally listed species and/or federally designated critical habitat.

a. Procedures when the Corps is the lead federal\* agency for a project:

The permittee must comply with (1) and (2) below when:

- the project is located in the western 41 counties of North Carolina, to include non-federal aid North Carolina Department of Transportation (NCDOT) projects, OR;
- the project is located in the 59 eastern counties of North Carolina and is a non-NCDOT project.

\*Generally, if a project is located on private property or on non-federal land, and the project is not being funded by a federal entity, the Corps will be the lead federal agency due to the requirement to obtain Department of the Army authorization to impact waters of the U.S. If the project is located on federal land, contact the Corps to determine the lead federal agency.

(1) A permittee using an NWP must check to see if their project is located in the range of the NLEB by using the following website:

<http://www.fws.gov/midwest/endangered/mammals/nleb/pdf/WNSZone.pdf>. If the project is within the range of the NLEB, or if the project includes percussive activities (e.g., blasting, pile driving, etc.), the permittee is then required to check the appropriate website in the paragraph below to discover if their project:

- is located in a 12-digit Hydrologic Unit Code area ("red HUC" - shown as red areas on the map), AND/OR;
- involves percussive activities within 0.25 mile of a red HUC.

Red HUC maps - for the western 41 counties in NC (covered by the Asheville Ecological Services Field Office), check the project location against the electronic maps found at: [http://www.fws.gov/asheville/htmls/project\\_review/NLEB\\_in\\_WNC.html](http://www.fws.gov/asheville/htmls/project_review/NLEB_in_WNC.html). For the eastern 59 counties in NC (covered by the Raleigh Ecological Services Field Office), check the project location against the electronic maps found at: [https://www.fws.gov/raleigh/NLEB\\_RFO.html](https://www.fws.gov/raleigh/NLEB_RFO.html).

(2) A permittee must submit a PCN to the District Engineer, and receive written verification from the District Engineer, prior to commencing the activity, if the activity will involve any of the following:

- tree clearing/removal and/or, construction/installation of wind turbines in a red HUC, AND/OR;
- bridge removal or maintenance, unless the bridge has been inspected and there is no evidence of bat use, (applies anywhere in the range of the NLEB), AND/OR;
- percussive activities in a red HUC, or within 0.25 mile of a red HUC.

The permittee may proceed with the activity without submitting a PCN to either the Corps or the USFWS, provided the activity complies with all applicable NWP terms and general and regional conditions, if the permittee's review under A.(1) and A.(2) above shows that the project is:

- located outside of a red HUC (and there are no percussive activities), and the activity will NOT include bridge removal or maintenance, unless the bridge has been inspected and there is no evidence of bat use, OR;
- located outside of a red HUC and there are percussive activities, but the percussive activities will not occur within 0.25-mile of a red HUC boundary, and the activity will NOT include bridge removal or maintenance, unless the bridge has been inspected and there is no evidence of bat use, OR;
- located in a red HUC, but the activity will NOT include tree clearing/removal; construction/installation of wind turbines; bridge removal or maintenance, unless the bridge has been inspected and there is no evidence of bat use, and/or; any percussive activities.

b. Procedures when the USACE is not the lead federal agency:

For projects where another federal agency is the lead federal agency - if that other federal agency has completed project-specific ESA Section 7(a)(2) consultation for the NLEB, and has (1) determined that the project would not cause prohibited incidental take of the NLEB, and (2) completed coordination/consultation that is required by the USFWS (per the directions on the respective USFWS office's website), that project may proceed without PCN to either the USACE or the USFWS, provided all General and Regional Permit Conditions are met.

The NLEB SLOPES can be viewed on the USACE website at:

<http://www.saw.usace.army.mil/Missions/Regulatory-Permit-Program/Agency-Coordination/ESA/>. Permittees who do not have internet access may contact the USACE at (910) 251- 4633.

14. **West Indian Manatee Protection.** In order to protect the endangered West Indian manatee (*Trichechus manatus*) the Permittee shall implement the USFWS' Manatee Guidelines, and strictly adhere to all requirements therein. The guidelines can be found at <https://www.fws.gov/raleigh/pdfs/ManateeGuidelines2017.pdf>.

15. **ESA Programmatic Biological Opinions.** The Wilmington District, USFWS, NCDOT, and the FHWA have conducted programmatic Section 7(a)(2) consultation for a number of federally listed species and designated critical habitat (DCH), and programmatic consultation concerning other federally listed species and/or DCH may occur in the future. The result of completed programmatic consultation is a Programmatic Biological Opinion (PBO) issued by the USFWS. These PBOs contain mandatory terms and conditions to implement the reasonable and prudent measures that are associated with "incidental take" of whichever species or critical habitat is covered by a specific PBO. Authorization under NWPs is conditional upon the permittee's compliance with all the mandatory terms and conditions associated with incidental take of the applicable PBO (or PBOs), which are incorporated by reference in the NWPs. Failure to comply with the terms and conditions associated with incidental take of an applicable PBO, where a take of the federally listed species occurs, would constitute an unauthorized take by the permittee, and would also constitute permittee non-compliance with the authorization under the NWPs. If the terms and conditions of a specific PBO (or PBOs) apply to a project, the Corps will include this/these requirements in any NWP verification that may be issued for a project. For an activity/project that does not require a PCN, the terms and conditions of the applicable PBO(s) also apply to that non-notifying

activity/project. The USFWS is the appropriate authority to determine compliance with the terms and conditions of its PBO and the ESA. All PBOs can be found on our website at: <https://www.saw.usace.army.mil/Missions/Regulatory-Permit-Program/Agency-Coordination/ESA/>.

## 16. Work on Eastern Band of Cherokee Indian Land.

Notifying NWPs - All PCNs submitted for activities in waters of the U.S. on Eastern Band of Cherokee Indians (EBCI) trust land (i.e., Qualla Boundary and non-contiguous tracts of trust land located in portions of Swain, Jackson, Haywood, Graham and Cherokee Counties), must comply with the requirements of the latest MOU between the Wilmington District and the EBCI.

Non-notifying NWPs - Prior to the use of any non-notifying NWP for activities in waters of the U.S. on EBCI trust land (i.e., Qualla Boundary and non-contiguous tracts of trust land located in portions of Swain, Jackson, Haywood, Graham and Cherokee Counties), all prospective permittees must comply with the requirements of the latest MOU between the Wilmington District and the EBCI; this includes coordinating the proposed project with the EBCI Natural Resources Program and obtaining a Tribal Approval Letter from the Tribe.

The EBCI MOU can be found at the following URL: <http://saw-reg.usace.army.mil/FO/Final-MOU-EBCI-USACE.pdf>

## 17. Sedimentation and Erosion Control Structures and Measures.

All PCNs will identify and describe sedimentation and erosion control structures and measures proposed for placement in waters of the U.S. The structures and measures should be depicted on maps, surveys or drawings showing location and impacts to jurisdictional wetlands and streams.

### **C. REGIONAL CONDITIONS APPLICABLE TO NWP 23**

1. The discharge of dredged or fill material associated with this NWP must not cause the loss of greater than 1 acre of waters of the United States or .06 acres of stream bed for each single and complete project.

### **D. SECTION 401 WATER QUALITY CERTIFICATION (WQC) AND/OR COASTAL ZONE MANAGEMENT ACT (CZMA) CONSISTENCY DETERMINATION SUMMARY AND APPLICABLE CONDITIONS**

The CZMA Consistency Determination and all Water Quality Certifications for the NWP's can be found at: <https://www.saw.usace.army.mil/Missions/Regulatory-Permit-Program/Permits/2017-Nationwide-Permits/>

ROY COOPER  
Governor  
ELIZABETH S. BISER  
Secretary  
S. DANIEL SMITH  
Director



September 28, 2021

DWR # 20211409  
Johnston County

Mr. Kevin Bowen, PE  
NCDOT Division 4  
PO Box 3165  
Wilson, NC 27895

**Subject: APPROVAL OF 401 WATER QUALITY CERTIFICATION WITH ADDITIONAL CONDITIONS  
NCDOT TIP #U-6223: NC 42/Ranch Rd Extension, Johnston County, Neuse Basin**

Dear Mr. Bowen:

You have our approval for the impacts listed below for the purpose described in your application received by the Division of Water Resources (Division) on September 21, 2021. These impacts are covered by the attached Water Quality General Certification Number **4140**, and the conditions listed below. This certification is associated with the use of Nationwide Permit Number 23 once it is issued to you by the U.S. Army Corps of Engineers. Please note that you should get any other federal, state or local permits before proceeding with your project, including those required by (but not limited to) Sediment and Erosion Control, Non-Discharge, and Water Supply Watershed regulations. The Division has determined that the proposed project will comply with water quality requirements provided that you adhere to the conditions listed in the general certification and to the additional conditions below.

The following proposed impacts are hereby approved. No other impacts are approved, including incidental impacts. [15A NCAC 02H .0506(b)]

**Stream Impacts in the Neuse River Basin**

Site	Permanent Fill in Perennial Stream (linear ft)	Bank Stabilization to Perennial Stream (linear ft)	Temporary Dewatering to Perennial Stream (linear ft)	Total Stream Impact (linear ft)
1	207	37	26	270
<b>Total</b>	<b>207</b>	<b>37</b>	<b>26</b>	<b>270</b>

**Total Stream Impact for Project: 270 linear feet.**



### Wetland Impacts in the Neuse River Basin

Site	Permanent Fill (ac)	Mechanized Clearing (ac)	Hand Clearing (ac)	Total Wetland Impact (ac)
1	0.474	0.114	0.024	0.612
2	0.014	0.033	0.041	0.088
<b>Total</b>	<b>0.488</b>	<b>0.147</b>	<b>0.065</b>	<b>0.700</b>

**Total Wetland Impact for Project: 0.7 acres.**

This approval is for the purpose and design described in your application. The plans and specifications for this project are incorporated by reference as part of this Certification. If you change your project, you must notify the Division and you may be required to submit a new application package with the appropriate fee. If the property is sold, the new owner must be given a copy of this Certification and is responsible for complying with all conditions. [15A NCAC 02H .0507(d)(2)].

If you are unable to comply with any of the conditions of the Water Quality General Certification or with the additional conditions below, you must notify the DWR Transportation Permitting Branch within 24 hours (or the next business day if a weekend or holiday) from the time the permittee becomes aware of the circumstances.

The permittee shall report to the DWR Transportation Permitting Branch any noncompliance with, and/or any violation of, stream or wetland standards [15A NCAC 2B.0200] including but not limited to sediment impacts to streams or wetlands. Information shall be provided orally within 24 hours (or the next business day if a weekend or holiday) from the time the permittee became aware of the non-compliance circumstances.

**Additional Conditions:**

1. Compensatory mitigation for impacts to wetlands is required. We understand that you have chosen to perform compensatory mitigation for impacts to 0.49 acres of wetlands through the North Carolina Division of Mitigation Services (DMS), and that the DMS has agreed to implement the mitigation for the project. DMS has indicated in a letter dated September 20, 2021 that they will assume responsibility for satisfying the federal Clean Water Act compensatory mitigation requirements for the above-referenced project, in accordance with DMS's Mitigation Banking Instrument signed July 28, 2010.

2. Unless otherwise approved in this certification, placement of culverts and other structures in open waters and streams, shall be placed below the elevation of the streambed by one foot for all culverts with a diameter greater than 48 inches, and 20 percent of the culvert diameter for culverts having a diameter less than 48 inches, to allow low flow passage of water and aquatic life. Design and placement of culverts and other structures including temporary erosion control measures shall not be conducted in a manner that may result in dis-equilibrium of wetlands or streambeds or banks, adjacent to or upstream and down stream of the above structures. The applicant is required to provide evidence that the equilibrium is being maintained if requested in writing by the NCDWR. If this condition is unable to be met due to bedrock or other limiting features encountered during construction, please contact the NCDWR for guidance on how to proceed and to determine whether or not a permit modification will be required. [15A NCAC 02H.0506(b)(2)]

3. Riprap shall not be placed in the active thalweg channel or placed in the streambed in a manner that precludes aquatic life passage. Bioengineering boulders or structures should be properly designed, sized and installed. [15A NCAC 02H.0506(b)(2)]



4. For all streams being impacted due to site dewatering activities, the site shall be graded to its preconstruction contours and revegetated with appropriate native species. [15A NCAC 02H.0506(b)(2)]
5. The stream channel shall be excavated no deeper than the natural bed material of the stream, to the maximum extent practicable. Efforts must be made to minimize impacts to the stream banks, as well as to vegetation responsible for maintaining the stream bank stability. Any applicable riparian buffer impact for access to stream channel shall be temporary and be revegetated with native riparian species. [15A NCAC 02H.0506(b)(2)]
6. Pipes and culverts used exclusively to maintain equilibrium in wetlands, where aquatic life passage is not a concern, shall not be buried. These pipes shall be installed at natural ground elevation. [15A NCAC 2H.0506(b)]
7. All portions of the proposed project draining to 303(d) listed impaired watersheds shall be designed, constructed, and operated with sediment and erosion control measures that meet *Design Standards in Sensitive Watersheds* (15A NCAC 4B .0124). However, due to the size of the project, NC DOT shall not be required to meet 15A NCAC 4B .0124(a) regarding the maximum amount of uncovered acres. All portions of the project draining to 303(d) listed watersheds shall not discharge stormwater directly to surface waters. Stormwater shall be treated using appropriate best management practices prior to discharging to surface waters.
8. Wetland areas impacted by temporary clearing shall be stabilized and reseeded with native wetland seed. [15A NCAC 2H0506(b)]
9. If concrete is used during construction, a dry work area shall be maintained to prevent direct contact between curing concrete and stream water. Water that inadvertently contacts uncured concrete shall not be discharged to surface waters due to the potential for elevated pH and possible aquatic life and fish kills. [15A NCAC 02B.0200]
10. During the construction of the project, no staging of equipment of any kind is permitted in waters of the U.S., or protected riparian buffers. [15A NCAC 02H.0506(b)(2)]
11. The dimension, pattern and profile of the stream above and below the crossing shall not be modified. Disturbed floodplains and streams shall be restored to natural geomorphic conditions. [15A NCAC 02H.0506(b)(2)]
12. The use of rip-rap above the Normal High Water Mark shall be minimized. Any rip-rap placed for stream stabilization shall be placed in stream channels in such a manner that it does not impede aquatic life passage. [15A NCAC 02H.0506(b)(2)]
- \* 13. The Permittee shall ensure that the final design drawings adhere to the permit and to the permit drawings submitted for approval. [15A NCAC 02H .0507 (c) and 15A NCAC 02H .0506 (b)(2) and (c)(2)]
14. All work in or adjacent to stream waters shall be conducted in a dry work area. Approved BMP measures from the most current version of NCDOT Construction and Maintenance Activities manual such as sandbags, rock berms, cofferdams and other diversion structures shall be used to prevent excavation in flowing water. [15A NCAC 02H.0506(b)(3) and (c)(3)]



15. Heavy equipment shall be operated from the banks rather than in the stream channel in order to minimize sedimentation and reduce the introduction of other pollutants into the stream. [15A NCAC 02H.0506(b)(3)]
16. All mechanized equipment operated near surface waters must be regularly inspected and maintained to prevent contamination of stream waters from fuels, lubricants, hydraulic fluids, or other toxic materials. [15A NCAC 02H.0506(b)(3)]
17. No rock, sand or other materials shall be dredged from the stream channel except where authorized by this certification. [15A NCAC 02H.0506(b)(3)]
18. Discharging hydroseed mixtures and washing out hydroseeders and other equipment in or adjacent to surface waters is prohibited. [15A NCAC 02H.0506(b)(3)]
19. The permittee and its authorized agents shall conduct its activities in a manner consistent with State water quality standards (including any requirements resulting from compliance with §303(d) of the Clean Water Act) and any other appropriate requirements of State and Federal law. If the NCDWR determines that such standards or laws are not being met (including the failure to sustain a designated or achieved use) or that State or federal law is being violated, or that further conditions are necessary to assure compliance, the NCDWR may reevaluate and modify this certification. [15A NCAC 02B.0200]
20. All fill slopes located in jurisdictional wetlands shall be placed at slopes no flatter than 3:1, unless otherwise authorized by this certification. [15A NCAC 02H.0506(b)(2)]
21. A copy of this Water Quality Certification shall be maintained on the construction site at all times. In addition, the Water Quality Certification and all subsequent modifications, if any, shall be maintained with the Division Engineer and the on-site project manager. [15A NCAC 02H .0507(c) and 15A NCAC 02H .0506 (b)(2) and (c)(2)]
22. The outside buffer, wetland or water boundary located within the construction corridor approved by this authorization, including all non-commercial borrow and waste sites associated with the project, shall be clearly marked by highly visible fencing prior to any land disturbing activities. Impacts to areas within the fencing are prohibited unless otherwise authorized by this certification. [15A NCAC 02H.0501 and .0502]
23. The issuance of this certification does not exempt the Permittee from complying with any and all statutes, rules, regulations, or ordinances that may be imposed by other government agencies (i.e. local, state, and federal) having jurisdiction, including but not limited to applicable buffer rules, stormwater management rules, soil erosion and sedimentation control requirements, etc.
24. The Permittee shall report any violations of this certification to the Division of Water Resources within 24 hours of discovery. [15A NCAC 02B.0506(b)(2)]
- \* 25. Upon completion of the project (including any impacts at associated borrow or waste sites), the NCDOT Division Engineer shall complete and return the enclosed "Certification of Completion Form" to notify the NCDWR when all work included in the 401 Certification has been completed. [15A NCAC 02H.0502(f)]





26. Native riparian vegetation must be reestablished in the riparian areas within the construction limits of the project by the end of the growing season following completion of construction. [15A NCAC 02B.0506(b)(2)]

27. There shall be no excavation from, or waste disposal into, jurisdictional wetlands or waters associated with this permit without appropriate modification. Should waste or borrow sites, or access roads to waste or borrow sites, be located in wetlands or streams, compensatory mitigation will be required since that is a direct impact from road construction activities. [15A NCAC 02H.0506(b)(3) and (c)(3)]

28. Erosion and sediment control practices must be in full compliance with all specifications governing the proper design, installation and operation and maintenance of such Best Management Practices in order to protect surface waters standards [15A NCAC 02H.0506(b)(3) and (c)(3)]:

- a. The erosion and sediment control measures for the project must be designed, installed, operated, and maintained in accordance with the most recent version of the *North Carolina Sediment and Erosion Control Planning and Design Manual*.
- b. The design, installation, operation, and maintenance of the sediment and erosion control measures must be such that they equal, or exceed, the requirements specified in the most recent version of the *North Carolina Sediment and Erosion Control Manual*. The devices shall be maintained on all construction sites, borrow sites, and waste pile (spoil) projects, including contractor-owned or leased borrow pits associated with the project.
- c. For borrow pit sites, the erosion and sediment control measures must be designed, installed, operated, and maintained in accordance with the most recent version of the *North Carolina Surface Mining Manual*.
- d. The reclamation measures and implementation must comply with the reclamation in accordance with the requirements of the Sedimentation Pollution Control Act.

29. Sediment and erosion control measures shall not be placed in wetlands or surface waters, or within 5 feet of the top of bank, without prior approval from DWR. [15A NCAC 02H.0506(b)(3) and (c)(3)]

30. When applicable, all construction activities shall be performed and maintained in full compliance with G.S. Chapter 113A Article 4 (Sediment and Pollution Control Act of 1973). Regardless of applicability of the Sediment and Pollution Control Act, all projects shall incorporate appropriate Best Management Practices for the control of sediment and erosion so that no violations of state water quality standards, statutes, or rules occur. [15A NCAC 02H .0506(b)(3) and (c)(3) and 15A NCAC 02B .0200]

31. Design, installation, operation, and maintenance of all sediment and erosion control measures shall be equal to or exceed the requirements specified in the most recent version of the *North Carolina Sediment and Erosion Control Manual*, or for linear transportation projects, the *NCDOT Sediment and Erosion Control Manual*.

All devices shall be maintained on all construction sites, borrow sites, and waste pile (spoil) sites, including contractor-owned or leased borrow pits associated with the project. Sufficient materials required for stabilization and/or repair of erosion control measures and stormwater routing and treatment shall be on site at all times.

For borrow pit sites, the erosion and sediment control measures shall be designed, installed, operated, and maintained in accordance with the most recent version of the *North Carolina Surface Mining*



*Manual.* Reclamation measures and implementation shall comply with the reclamation in accordance with the requirements of the Sedimentation Pollution Control Act and the Mining Act of 1971. If the project occurs in waters or watersheds classified 303(d) Impaired Waters, then the sedimentation and erosion control designs shall comply with the requirements set forth in 15A NCAC 04B .0124, *Design Standards in Sensitive Watershed*. [15A NCAC 02H.0506(b)(3) and (c)(3); GC 4135]

This approval and its conditions are final and binding unless contested. [G.S. 143-215.5] Please be aware that by having impacted waters without first applying for and securing the issuance of a 401 Water Quality Certification, you have violated Title 15A of the North Carolina Administrative Code (NCAC) 2H .0500. Title 15A NCAC 2H .0500 requires certifications pursuant to Section 401 of the Clean Water Act whenever construction or operation of facilities will result in a discharge into navigable waters, including wetlands, as described in 33 Code of Federal Regulations (CFR) Part 323. It also states any person desiring issuance of the State certification or coverage under a general certification required by Section 401 of the Federal Water Pollution Control Act shall file with the Director of the North Carolina Division of Water Quality. Pursuant to G.S. 143-215.6A, these violations and any future violations are subject to a civil penalty assessment of up to a maximum of \$25,000.00 per day for each violation. This Certification can be contested as provided in Chapter 150B of the North Carolina General Statutes by filing a Petition for a Contested Case Hearing (Petition) with the North Carolina Office of Administrative Hearings (OAH) **within sixty (60) calendar days**. Requirements for filing a Petition are set forth in Chapter 150B of the North Carolina General Statutes and Title 26 of the North Carolina Administrative Code. Additional information regarding requirements for filing a Petition and Petition forms may be accessed at <http://www.ncoah.com/> or by calling the OAH Clerk's Office at (919) 431-3000. One (1) copy of the Petition must also be served to the North Carolina Department of Environmental Quality:

William F. Lane, General Counsel  
Department of Environmental Quality  
1601 Mail Service Center  
Raleigh, NC 27699-1601

This letter completes the review of the Division under section 401 of the Clean Water Act and 15A NCAC 02H .0500. Please contact Rob Ridings at [rob.ridings@ncdenr.gov](mailto:rob.ridings@ncdenr.gov) if you have any questions or concerns.

Sincerely,

DocuSigned by:

*Amy Chapman*

9C9886312DCD474...

S. Daniel Smith, Director  
Division of Water Resources

cc:

Tom Steffens, USACE Washington Regulatory Field Office  
Byron Bateman, Division 4 Environmental Officer  
Beth Harmon, Division of Mitigation Services  
File Copy



ROY COOPER  
Governor  
ELIZABETH S. BISER  
Secretary  
S. DANIEL SMITH  
Director



September 28, 2021

DWR # 20211409  
Johnston County

Mr. Kevin Bowen, PE  
NCDOT Division 4  
PO Box 3165  
Wilson, NC 27895

**Subject: APPROVAL of NEUSE RIPARIAN BUFFER AUTHORIZATION WITH ADDITIONAL CONDITIONS  
NCDOT TIP #U-6223: NC 42/Ranch Rd Extension, Johnston County, Neuse Basin**

Dear Mr. Bowen:

You have our approval for the impacts listed below for the purpose described in your application received by the Division of Water Resources (Division) on September 21, 2021. These impacts are covered by the Neuse Buffer Rules and the conditions listed below. Please note that you should get any other federal, state or local permits before proceeding with your project, including those required by (but not limited to) Sediment and Erosion Control, Non-Discharge, and Water Supply Watershed regulations.

The following impacts are hereby approved, provided that all of the Conditions listed below and all of the conditions of the Neuse Buffer Rules are met. No other impacts are approved, including incidental impacts. [15A NCAC 02B.0611(b)(2)]

**Neuse Riparian Buffer Impacts**

Site	Zone 1 Impact (sq ft)	minus Wetlands in Zone 1 (sq ft)	= Zone 1 Buffers (not wetlands) (sq ft)	Zone 1 Buffer Mitigation Required (using 3:1 ratio)	Zone 2 Impact (sq ft)	minus Wetlands in Zone 2 (sq ft)	= Zone 2 Buffers (not wetlands) (sq ft)	Zone 2 Buffer Mitigation Required (using 1.5:1 ratio)
1	14904	13707	1197	3591	9077	5318	3759	5639
<b>Totals</b>	<b>14904</b>	<b>13707</b>	<b>1197</b>	<b>3591</b>	<b>9077</b>	<b>5318</b>	<b>3759</b>	<b>5639</b>

\* n/a = Total for Site is less than 1/3 acre and 150 linear feet of impact, no mitigation required

**Total Buffer Impact for Project: 23981 square feet.**

This approval is for the purpose and design described in your application. The plans and specifications for this project are incorporated by reference as part of this Authorization Certificate. If you change your project, you must notify the Division and you may be required to submit a new application package. If the property is sold, the new owner must be given a copy of this Authorization Certificate and is responsible for complying with all conditions. [15A NCAC 02B.0611(b)(2)]



If you are unable to comply with any of the conditions below, you must notify the DWR Transportation Permitting Branch within 24 hours (or the next business day if a weekend or holiday) from the time the permittee becomes aware of the circumstances.

The permittee shall report to the Transportation Permitting Branch any noncompliance with the conditions of this Authorization Certificate and/or any violation of state regulated riparian buffer rules [15A NCAC 2B.0714]. Information shall be provided orally within 24 hours (or the next business day if a weekend or holiday) from the time the applicant became aware of the circumstances.

### **Additional Conditions:**

1. Compensatory mitigation for impacts to 1197 square feet of protected riparian buffers in Zone 1 and 3759 square feet of protected riparian buffers in Zone 2 shall be required. We understand that you have chosen to perform compensatory mitigation for impacts to protected buffers through use of the North Carolina Division of Mitigation Services (DMS). Mitigation for unavoidable impacts to Neuse Riparian Buffers shall be provided in the Neuse River Basin and done in accordance with 15A NCAC .02B .0295. The DMS has indicated in a letter dated September 20, 2021 that they will assume responsibility for satisfying the compensatory mitigation requirements for the above-referenced project, in accordance with DMS's Mitigation Banking Instrument signed June 14, 2016.
2. All stormwater runoff shall be directed as sheetflow through stream buffers at non-erosive velocities, unless otherwise approved by this certification. [15A NCAC 2B.0714].
3. All riparian buffers impacted by the placement of temporary fill or clearing activities shall be restored to the preconstruction contours and revegetated. Maintained buffers shall be permanently revegetated with non-woody species by the end of the growing season following completion of construction. For the purpose of this condition, maintained buffer areas are defined as areas within the transportation corridor that will be subject to regular NCDOT maintenance activities including mowing. The area with non-maintained buffers shall be permanently revegetated with native woody species before the next growing season following completion of construction. [15A NCAC 2B.0714].
4. Pursuant to 15A NCAC 2B.0714, sediment and erosion control devices shall not be placed in Zone 1 of any Neuse Buffer without prior approval by the NCDWR. At this time, the NCDWR has approved no sediment and erosion control devices in Zone 1, outside of the approved project impacts, anywhere on this project. Moreover, sediment and erosion control devices shall be allowed in Zone 2 of the buffers provided that Zone 1 is not compromised and that discharge is released as diffuse flow.
5. Native riparian vegetation (ie, trees and shrubs native to your geographic region) must be reestablished in the riparian areas within the construction limits of the project by the end of the growing season following completion of construction. [15A NCAC 2B.0714]

This approval and its conditions are final and binding unless contested. [G.S. 143-215.5]

This Authorization Certificate can be contested as provided in Chapter 150B of the North Carolina General Statutes by filing a Petition for a Contested Case Hearing (Petition) with the North Carolina Office of Administrative Hearings (OAH) **within sixty (60) calendar days**. Requirements for filing a Petition are set forth in Chapter 150B of the North Carolina General Statutes and Title 26 of the North Carolina Administrative Code. Additional information regarding requirements for filing a Petition and Petition forms may be accessed at <http://www.ncoah.com/> or by calling the OAH Clerk's Office at (919) 431-3000.

One (1) copy of the Petition must also be served to the North Carolina Department of Environmental Quality:

William F. Lane, General Counsel  
Department of Environmental Quality  
1601 Mail Service Center  
Raleigh, NC 27699-1601



**This Authorization shall expire five (5) years from the date of this letter.**

This letter completes the review of the Division under the Neuse Riparian Buffer Rules as described in 15A NCAC 02B.0714. Please contact Rob Ridings at [rob.ridings@ncdenr.gov](mailto:rob.ridings@ncdenr.gov) if you have any questions or concerns.

Sincerely,

DocuSigned by:  
*Amy Chapman*  
9C9886312DCC474...

S. Daniel Smith, Director  
Division of Water Resources

CC:

Tom Steffens, USACE Washington Regulatory Field Office  
Byron Bateman, Division 4 Environmental Officer  
Beth Harmon, Division of Mitigation Services  
File Copy



STATE OF NORTH CAROLINA  
DEPARTMENT OF ENVIRONMENTAL QUALITY  
DIVISION OF WATER RESOURCES

**WATER QUALITY GENERAL CERTIFICATION NO. 4140**

**GENERAL CERTIFICATION FOR PROJECTS ELIGIBLE FOR US ARMY CORPS OF ENGINEERS**

- **NATIONWIDE PERMIT NUMBER 23 (APPROVED CATEGORICAL EXCLUSIONS)**

Water Quality Certification Number 4140 is issued in conformity with the requirements of Section 401, Public Laws 92-500 and 95-217 of the United States and subject to the North Carolina Regulations in 15A NCAC 02H .0500 and 15A NCAC 02B .0200 for the discharge of fill material to surface waters and wetland areas as described in 33 CFR 330 Appendix A (B) (23) of the US Army Corps of Engineers regulations.

The State of North Carolina certifies that the specified category of activity will not violate applicable portions of Sections 301, 302, 303, 306 and 307 of the Public Laws 92-500 and 95-217 if conducted in accordance with the conditions hereinafter set forth.

Effective date: December 1, 2017

Signed this day: December 1, 2017

By

  
*for* Linda Culpepper  
Interim Director

GC4140

**Activities meeting any one (1) of the following thresholds or circumstances require written approval for a 401 Water Quality Certification from the Division of Water Resources (DWR):**

- a) If any of the conditions of this Certification (listed below) cannot be met; or
- b) Total permanent impacts to streams equal or greater than 40 linear feet; or
- c) Any stream relocation or stream restoration; or
- d) Any impacts to streams from excavation or dredging other than excavation that is conducted as preparation for installing permanent fill or structures; or
- e) Total temporary or permanent impacts to wetlands and/or open waters equal to or greater than one-tenth (1/10) acre; or
- f) Any high-density project, as defined in 15A NCAC 02H .1003(2)(a) and by the density thresholds specified in 15A NCAC 02H .1017, which:
  - i. Disturbs one acre or more of land (including a project that disturbs less than one acre of land that is part of a larger common plan of development or sale); and
  - ii. Has permanent wetland, stream or open water impacts; and
  - iii. Is proposing new built-upon area; and
  - iv. Does not have a stormwater management plan reviewed and approved under a state stormwater program<sup>1</sup> or a state-approved local government stormwater program<sup>2</sup>.

Projects that have vested rights, exemptions, or grandfathering from state or locally-implemented stormwater programs and projects that satisfy state or locally-implemented stormwater programs through use of community in-lieu programs **require written approval**; or

- g) Any permanent impacts to waters, or wetlands adjacent to waters, designated as: ORW (including SAV), HQW (including PNA), SA, WS-I, WS-II, Trout, or a North Carolina or National Wild and Scenic River; or
- h) Any permanent impacts to coastal wetlands [15A NCAC 7H .0205], or Unique Wetlands (UWL) [15A NCAC 2H .0506]; or
- i) Any impact associated with a Notice of Violation or an enforcement action for violation(s) of NC Wetland Rules (15A NCAC 02H .0500), NC Isolated Wetland Rules (15A NCAC 02H .1300), NC Surface Water or Wetland Standards (15A NCAC 02B .0200), or State Regulated Riparian Buffer Rules (15A NCAC 02B .0200); or
- \* j) Any impacts to subject water bodies and/or state regulated riparian buffers along subject water bodies in the Neuse, Tar-Pamlico, or Catawba River Basins or in the Randleman Lake, Jordan Lake or Goose Creek Watersheds (or any other basin or watershed with State Regulated Riparian Area Protection Rules [Buffer Rules] in effect at the time of application) *unless*:
  - i. The activities are listed as “EXEMPT” from these rules; or
  - ii. A Buffer Authorization Certificate is issued by the NC Division of Coastal Management (DCM); or

---

<sup>1</sup> e.g. Coastal Counties, HQW, ORW, or state-implemented Phase II NPDES

<sup>2</sup> e.g. Delegated Phase II NPDES, Water Supply Watershed, Nutrient-Sensitive Waters, or Universal Stormwater Management Program

GC4140

- iii. A Buffer Authorization Certificate or a Minor Variance is issued by a delegated or designated local government implementing a state riparian buffer program pursuant to 143-215.23.

**Activities included in this General Certification that do not meet one of the thresholds listed above do not require written approval.**

**I. ACTIVITY SPECIFIC CONDITIONS:**

1. For the North Carolina Department of Transportation, compliance with the NCDOT's individual NPDES permit NCS000250 shall serve to satisfy this condition. All other high-density projects that trigger threshold Item (f) above shall comply with the following requirements [15A NCAC 02H .0506 (b)(5) and (c)(5)]:
  - \* a. Provide a completed Stormwater Management Plan (SMP) for review and approval, including all appropriate stormwater control measure (SCM) supplemental forms and associated items, that complies with the high-density development requirements of 15A NCAC 02H .1003. Stormwater management shall be provided throughout the entire project area in accordance with 15A NCAC 02H .1003. For the purposes of 15A NCAC 02H .1003(2)(a), density thresholds shall be determined in accordance with 15A NCAC 02H .1017.
  - \* b. Provide documentation (including calculations, photos, etc.) that the project will not cause degradation of downstream surface waters. Documentation shall include a detailed analysis of the hydrological impacts from stormwater runoff when considering the volume and velocity of stormwater runoff from the project built upon area and the size and existing condition of the receiving stream(s).

Exceptions to this condition require application to and written approval from DWR.

**II. GENERAL CONDITIONS:**

1. When written authorization is required, the plans and specifications for the project are incorporated into the authorization by reference and are an enforceable part of the Certification. Any modifications to the project require notification to DWR and may require an application submittal to DWR with the appropriate fee. [15A NCAC 02H .0501 and .0502]
2. No waste, spoil, solids, or fill of any kind shall occur in wetlands or waters, beyond the footprint of the impacts (including temporary impacts) as authorized in the written approval from DWR; or beyond the thresholds established for use of this Certification without written authorization. [15A NCAC 02H .0501 and .0502]

No removal of vegetation or other impacts of any kind shall occur to state regulated riparian buffers beyond the footprint of impacts approved in a Buffer Authorization or Variance or as listed as an exempt activity in the applicable riparian buffer rules. [15A NCAC 02B .0200]



GC4140

3. In accordance with 15A NCAC 02H .0506(h) and Session Law 2017-10, compensatory mitigation may be required for losses of greater than 300 linear feet of perennial streams and/or greater than one (1) acre of wetlands. Impacts associated with the removal of a dam shall not require mitigation when the removal complies with the requirements of Part 3 of Article 21 in Chapter 143 of the North Carolina General Statutes. Impacts to isolated and other non-404 jurisdictional wetlands shall not be combined with 404 jurisdictional wetlands for the purpose of determining when impact thresholds trigger a mitigation requirement. For linear publicly owned and maintained transportation projects that are not determined to be part of a larger common plan of development by the US Army Corps of Engineers, compensatory mitigation may be required for losses of greater than 300 linear feet per perennial stream.

Compensatory stream and/or wetland mitigation shall be proposed and completed in compliance with G.S. 143-214.11. For applicants proposing to conduct mitigation within a project site, a complete mitigation proposal developed in accordance with the most recent guidance issued by the US Army Corps of Engineers Wilmington District shall be submitted for review and approval with the application for impacts.

4. All activities shall be in compliance with any applicable State Regulated Riparian Buffer Rules in Chapter 2 of Title 15A.
5. When applicable, all construction activities shall be performed and maintained in full compliance with G.S. Chapter 113A Article 4 (Sediment and Pollution Control Act of 1973). Regardless of applicability of the Sediment and Pollution Control Act, all projects shall incorporate appropriate Best Management Practices for the control of sediment and erosion so that no violations of state water quality standards, statutes, or rules occur. [15A NCAC 02H .0506(b)(3) and (c)(3) and 15A NCAC 02B .0200]

Design, installation, operation, and maintenance of all sediment and erosion control measures shall be equal to or exceed the requirements specified in the most recent version of the *North Carolina Sediment and Erosion Control Manual*, or for linear transportation projects, the *NCDOT Sediment and Erosion Control Manual*.

All devices shall be maintained on all construction sites, borrow sites, and waste pile (spoil) sites, including contractor-owned or leased borrow pits associated with the project. Sufficient materials required for stabilization and/or repair of erosion control measures and stormwater routing and treatment shall be on site at all times.

For borrow pit sites, the erosion and sediment control measures shall be designed, installed, operated, and maintained in accordance with the most recent version of the *North Carolina Surface Mining Manual*. Reclamation measures and implementation shall comply with the reclamation in accordance with the requirements of the Sedimentation Pollution Control Act and the Mining Act of 1971.

GC4140

If the project occurs in waters or watersheds classified as Primary Nursery Areas (PNAs), SA, WS-I, WS-II, High Quality Waters (HQW), or Outstanding Resource Waters (ORW), then the sedimentation and erosion control designs shall comply with the requirements set forth in 15A NCAC 04B .0124, *Design Standards in Sensitive Watersheds*.

6. Sediment and erosion control measures shall not be placed in wetlands or waters except within the footprint of temporary or permanent impacts authorized under this Certification. Exceptions to this condition require application to and written approval from DWR. [15A NCAC 02H .0501 and .0502]
7. Erosion control matting that incorporates plastic mesh and/or plastic twine shall not be used along streambanks or within wetlands. Exceptions to this condition require application to and written approval from DWR. [15A NCAC 02B .0201]
8. An NPDES Construction Stormwater Permit (NCG010000) is required for construction projects that disturb one (1) or more acres of land. The NCG010000 Permit allows stormwater to be discharged during land disturbing construction activities as stipulated in the conditions of the permit. If the project is covered by this permit, full compliance with permit conditions including the erosion & sedimentation control plan, inspections and maintenance, self-monitoring, record keeping and reporting requirements is required. [15A NCAC 02H .0506(b)(5) and (c)(5)]

The North Carolina Department of Transportation (NCDOT) shall be required to be in full compliance with the conditions related to construction activities within the most recent version of their individual NPDES (NCS000250) stormwater permit. [15A NCAC 02H .0506(b)(5) and (c)(5)]

9. All work in or adjacent to streams shall be conducted so that the flowing stream does not come in contact with the disturbed area. Approved best management practices from the most current version of the *NC Sediment and Erosion Control Manual*, or the *NC DOT Construction and Maintenance Activities Manual*, such as sandbags, rock berms, cofferdams, and other diversion structures shall be used to minimize excavation in flowing water. Exceptions to this condition require application to and written approval from DWR. [15A NCAC 02H .0506(b)(3) and (c)(3)]
10. If activities must occur during periods of high biological activity (e.g. sea turtle nesting, fish spawning, or bird nesting), then biological monitoring may be required at the request of other state or federal agencies and coordinated with these activities. [15A NCAC 02H .0506 (b)(2) and 15A NCAC 04B .0125]

All moratoriums on construction activities established by the NC Wildlife Resources Commission (WRC), US Fish and Wildlife Service (USFWS), NC Division of Marine Fisheries (DMF), or National Marine Fisheries Service (NMFS) shall be implemented. Exceptions to this condition require written approval by the resource agency responsible for the given moratorium. A copy of the approval from the resource agency shall be forwarded to DWR.

## GC4140

Work within a designated trout watershed of North Carolina (as identified by the Wilmington District of the US Army Corps of Engineers), or identified state or federal endangered or threatened species habitat, shall be coordinated with the appropriate WRC, USFWS, NMFS, and/or DMF personnel.

11. Culverts shall be designed and installed in such a manner that the original stream profiles are not altered and allow for aquatic life movement during low flows. The dimension, pattern, and profile of the stream above and below a pipe or culvert shall not be modified by widening the stream channel or by reducing the depth of the stream in connection with the construction activity. The width, height, and gradient of a proposed culvert shall be such as to pass the average historical low flow and spring flow without adversely altering flow velocity. [15A NCAC 02H .0506(b)(2) and (c)(2)]

Placement of culverts and other structures in streams shall be below the elevation of the streambed by one foot for all culverts with a diameter greater than 48 inches, and 20% of the culvert diameter for culverts having a diameter less than or equal to 48 inches, to allow low flow passage of water and aquatic life.

If multiple pipes or barrels are required, they shall be designed to mimic the existing stream cross section as closely as possible including pipes or barrels at flood plain elevation and/or sills where appropriate. Widening the stream channel shall be avoided.

When topographic constraints indicate culvert slopes of greater than 5%, culvert burial is not required, provided that all alternative options for flattening the slope have been investigated and aquatic life movement/connectivity has been provided when possible (e.g. rock ladders, cross vanes, etc.). Notification, including supporting documentation to include a location map of the culvert, culvert profile drawings, and slope calculations, shall be provided to DWR 60 calendar days prior to the installation of the culvert.

When bedrock is present in culvert locations, culvert burial is not required provided that there is sufficient documentation of the presence of bedrock. Notification, including supporting documentation such as, a location map of the culvert, geotechnical reports, photographs, etc. shall be provided to DWR a minimum of 60 calendar days prior to the installation of the culvert. If bedrock is discovered during construction, then DWR shall be notified by phone or email within 24 hours of discovery.

If other site-specific topographic constraints preclude the ability to bury the culverts as described above and/or it can be demonstrated that burying the culvert would result in destabilization of the channel, then exceptions to this condition require application to and written approval from DWR.

GC4140

Installation of culverts in wetlands shall ensure continuity of water movement and be designed to adequately accommodate high water or flood conditions. When roadways, causeways, or other fill projects are constructed across FEMA-designated floodways or wetlands, openings such as culverts or bridges shall be provided to maintain the natural hydrology of the system as well as prevent constriction of the floodway that may result in destabilization of streams or wetlands.

The establishment of native woody vegetation and other soft stream bank stabilization techniques shall be used where practicable instead of rip-rap or other bank hardening methods.

12. Bridge deck drains shall not discharge directly into the stream. Stormwater shall be directed across the bridge and pre-treated through site-appropriate means to the maximum extent practicable (e.g. grassed swales, pre-formed scour holes, vegetated buffers, etc.) before entering the stream. Exceptions to this condition require application to and written approval from DWR. [15A NCAC 02H .0506(b)(5)]
13. Application of fertilizer to establish planted/seeded vegetation within disturbed riparian areas and/or wetlands shall be conducted at agronomic rates and shall comply with all other Federal, State and Local regulations. Fertilizer application shall be accomplished in a manner that minimizes the risk of contact between the fertilizer and surface waters. [15A NCAC 02B .0200 and 15A NCAC 02B .0231]
14. If concrete is used during construction, then all necessary measures shall be taken to prevent direct contact between uncured or curing concrete and waters of the state. Water that inadvertently contacts uncured concrete shall not be discharged to waters of the state. [15A NCAC 02B .0200]
15. All proposed and approved temporary fill and culverts shall be removed and the impacted area shall be returned to natural conditions within 60 calendar days after the temporary impact is no longer necessary. The impacted areas shall be restored to original grade, including each stream's original cross sectional dimensions, planform pattern, and longitudinal bed profile. For projects that receive written approval, no temporary impacts are allowed beyond those included in the application and authorization. All temporarily impacted sites shall be restored and stabilized with native vegetation. [15A NCAC 02H .0506(b)(2) and (c)(2)]
16. All proposed and approved temporary pipes/culverts/rip-rap pads etc. in streams shall be installed as outlined in the most recent edition of the *North Carolina Sediment and Erosion Control Planning and Design Manual* or the *North Carolina Surface Mining Manual* or the *North Carolina Department of Transportation Best Management Practices for Construction and Maintenance Activities* so as not to restrict stream flow or cause dis-equilibrium during use of this Certification. [15A NCAC 02H .0506(b)(2) and (c)(2)]

GC4140

17. Any rip-rap required for proper culvert placement, stream stabilization, or restoration of temporarily disturbed areas shall be restricted to the area directly impacted by the approved construction activity. All rip-rap shall be placed such that the original stream elevation and streambank contours are restored and maintained. Placement of rip-rap or other approved materials shall not result in de-stabilization of the stream bed or banks upstream or downstream of the area or in a manner that precludes aquatic life passage. [15A NCAC 02H .0506(b)(2)]
18. Any rip-rap used for stream or shoreline stabilization shall be of a size and density to prevent movement by wave, current action, or stream flows and shall consist of clean rock or masonry material free of debris or toxic pollutants. Rip-rap shall not be installed in the streambed except in specific areas required for velocity control and to ensure structural integrity of bank stabilization measures. [15A NCAC 02H .0506(b)(2)]
19. Applications for rip-rap groins proposed in accordance with 15A NCAC 07H .1401 (NC Division of Coastal Management General Permit for construction of Wooden and Rip-rap Groins in Estuarine and Public Trust Waters) shall meet all the specific conditions for design and construction specified in 15A NCAC 07H .1405.
20. All mechanized equipment operated near surface waters shall be inspected and maintained regularly to prevent contamination of surface waters from fuels, lubricants, hydraulic fluids, or other toxic materials. Construction shall be staged in order to minimize the exposure of equipment to surface waters to the maximum extent practicable. Fueling, lubrication and general equipment maintenance shall be performed in a manner to prevent, to the maximum extent practicable, contamination of surface waters by fuels and oils. [15A NCAC 02H .0506(b)(3) and (c)(3) and 15A NCAC 02B .0211 (12)]
21. Heavy equipment working in wetlands shall be placed on mats or other measures shall be taken to minimize soil disturbance. [15A NCAC 02H .0506(b)(3) and (c)(3)]
22. In accordance with 143-215.85(b), the applicant shall report any petroleum spill of 25 gallons or more; any spill regardless of amount that causes a sheen on surface waters; any petroleum spill regardless of amount occurring within 100 feet of surface waters; and any petroleum spill less than 25 gallons that cannot be cleaned up within 24 hours.
- \* 23. If an environmental document is required under the State Environmental Policy Act (SEPA), then this General Certification is not valid until a Finding of No Significant Impact (FONSI) or Record of Decision (ROD) is issued by the State Clearinghouse. If an environmental document is required under the National Environmental Policy Act (NEPA), then this General Certification is not valid until a Categorical Exclusion, the Final Environmental Assessment, or Final Environmental Impact Statement is published by the lead agency. [15A NCAC 01C .0107(a)]

GC4140

24. This General Certification does not relieve the applicant of the responsibility to obtain all other required Federal, State, or Local approvals before proceeding with the project, including those required by, but not limited to, Sediment and Erosion Control, Non-Discharge, Water Supply Watershed, and Trout Buffer regulations.
25. The applicant and their authorized agents shall conduct all activities in a manner consistent with State water quality standards (including any requirements resulting from compliance with §303(d) of the Clean Water Act), and any other appropriate requirements of State and Federal Law. If DWR determines that such standards or laws are not being met, including failure to sustain a designated or achieved use, or that State or Federal law is being violated, or that further conditions are necessary to assure compliance, then DWR may revoke or modify a written authorization associated with this General Water Quality Certification. [15A NCAC 02H .0507(d)]
26. The permittee shall require its contractors and/or agents to comply with the terms and conditions of this permit in the construction and maintenance of this project, and shall provide each of its contractors and/or agents associated with the construction or maintenance of this project with a copy of this Certification. A copy of this Certification, including all conditions shall be available at the project site during the construction and maintenance of this project. [15A NCAC 02H .0507 (c) and 15A NCAC 02H .0506 (b)(2) and (c)(2)]
- \* 27. When written authorization is required for use of this Certification, upon completion of all permitted impacts included within the approval and any subsequent modifications, the applicant shall be required to return a certificate of completion (available on the DWR website <https://edocs.deq.nc.gov/Forms/Certificate-of-Completion>). [15A NCAC 02H .0502(f)]
28. Additional site-specific conditions, including monitoring and/or modeling requirements, may be added to the written approval letter for projects proposed under this Water Quality Certification in order to ensure compliance with all applicable water quality and effluent standards. [15A NCAC 02H .0507(c)]
29. If the property or project is sold or transferred, the new permittee shall be given a copy of this Certification (and written authorization if applicable) and is responsible for complying with all conditions. [15A NCAC 02H .0501 and .0502]

**III. GENERAL CERTIFICATION ADMINISTRATION:**

- \* 1. In accordance with North Carolina General Statute 143-215.3D(e), written approval for a 401 Water Quality General Certification must include the appropriate fee. An applicant for a CAMA permit under Article 7 of Chapter 113A of the General Statutes for which a Water Quality Certification is required shall only make one payment to satisfy both agencies; the fee shall be as established by the Secretary in accordance with 143-215.3D(e)(7).

GC4140

2. This Certification neither grants nor affirms any property right, license, or privilege in any waters, or any right of use in any waters. This Certification does not authorize any person to interfere with the riparian rights, littoral rights, or water use rights of any other person and this Certification does not create any prescriptive right or any right of priority regarding any usage of water. This Certification shall not be interposed as a defense in any action respecting the determination of riparian or littoral rights or other rights to water use. No consumptive user is deemed by virtue of this Certification to possess any prescriptive or other right of priority with respect to any other consumptive user regardless of the quantity of the withdrawal or the date on which the withdrawal was initiated or expanded.
3. This Certification grants permission to the Director, an authorized representative of the Director, or DWR staff, upon the presentation of proper credentials, to enter the property during normal business hours. [15A NCAC 02H .0502(e)]
4. This General Certification shall expire on the same day as the expiration date of the corresponding Nationwide Permit and/or Regional General Permit. The conditions in effect on the date of issuance of Certification for a specific project shall remain in effect for the life of the project, regardless of the expiration date of this Certification. This General Certification is rescinded when the US Army Corps of Engineers reauthorizes any of the corresponding Nationwide Permits and/or Regional General Permits or when deemed appropriate by the Director of the Division of Water Resources.
5. Non-compliance with or violation of the conditions herein set forth by a specific project may result in revocation of this General Certification for the project and may also result in criminal and/or civil penalties.
- \*6. The Director of the North Carolina Division of Water Resources may require submission of a formal application for Individual Certification for any project in this category of activity if it is deemed in the public's best interest or determined that the project is likely to have a significant adverse effect upon water quality, including state or federally listed endangered or threatened aquatic species, or degrade the waters so that existing uses of the water or downstream waters are precluded.

*History Note: Water Quality Certification (WQC) Number 4140 issued December 1, 2017 replaces WQC4093 issued March 3, 2017; WQC 3891 issued March 19, 2012; WQC 3701 issued November 1, 2007; WQC Number 3632 issued March 2007; WQC Number 3403 issued March 2003; WQC Number 3361 issued March 18, 2002; WQC Number 3107 issued February 11, 1997; WQC Number 2734 issued May 1 1993; and WQC Number 2670 issued on January 21, 1992.*

See Sheet 1-A For Index of Sheets

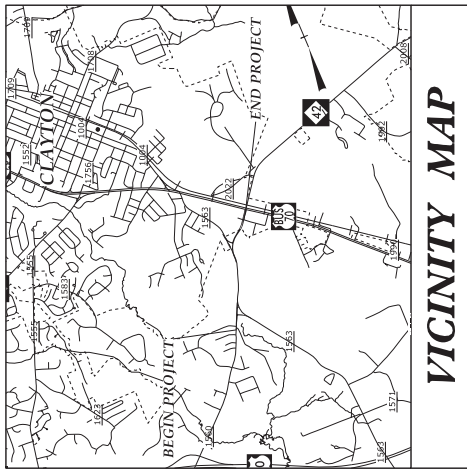

STATE OF NORTH CAROLINA  
DIVISION OF HIGHWAYS  
**JOHNSTON COUNTY**

LOCATION: NEW LOCATION FROM SR-1560 (RANCH ROAD) TO THE US-70 BUS & NC-42 INTERSECTION.

TYPE OF WORK: GRADING, DRAINAGE AND PAVING

WETLAND AND SURFACE WATER IMPACTS PERMIT

STATE	N.C.	PROJECT NUMBER	U-6223
COUNTY	JOHNSTON	CONTRACT NUMBER	1560004
DATE	4/8/2023	DESIGNER	PE

PERMIT DRAWING  
SHEET 1 OF 7



**SITE 1**

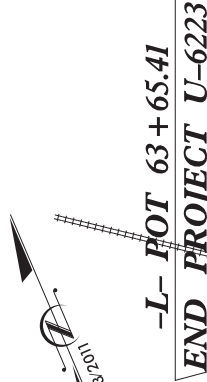

-L- POC 40+10.00  
BEGIN CONST

-L- POT 12+00.00  
BEGIN PROJECT U-6223

LINE -L- SR-1560 RANCH RD  
LINE -L- SR-1563 LITTLE CREEK CHURCH RD  
-L- POC 25+00.00  
END CONST

-Y1- POT 16+50.00  
END CONST



-L- POT 63+65.41  
END PROJECT U-6223

**SITE 2**

INCOMPLETE PLANS  
DO NOT USE FOR ACQUISITION  
PRELIMINARY PLANS  
DO NOT USE FOR CONSTRUCTION  
UNLESS ALL SIGNATURES COMPLETED

CLEARING ON THIS PROJECT SHALL BE PERFORMED TO THE LIMITS ESTABLISHED BY METHOD .  
A PORTION OF THIS PROJECT IS WITHIN THE MUNICIPAL BOUNDARIES OF CLAYTON.

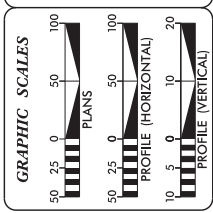

DESIGN DATA

ADT 2022	= 6300
ADT 2045	= 25800
K	= 9 %
D	= 55 %
T	= 3 % *
V	= 50 MPH
* TTST	= 1% DUAL=2%
FUNCTIONAL CLASS	= ?

PROJECT LENGTH

LENGTH ROADWAY TIP PROJECT U-6223 = 0.692 MILES  
TOTAL LENGTH TIP PROJECT U-6223 = 0.692 MILES

Prepared in the Office of:  
**DIVISION OF HIGHWAYS**  
SOP, Per. Div., Wilson, NC, 27155

RIGHT OF WAY DATE: JANUARY 20, 2023  
LETTING DATE: JULY 16, 2024

PROJECT ENGINEER: KEVIN BOWEN, PE  
PROJECT DESIGN ENGINEER: D.R. ETHRIDGE

HYDRAULICS ENGINEER: \_\_\_\_\_ P.E.  
ROADWAY DESIGN ENGINEER: \_\_\_\_\_ P.E.

TIP PROJECT: U-6223 CONTRACT:



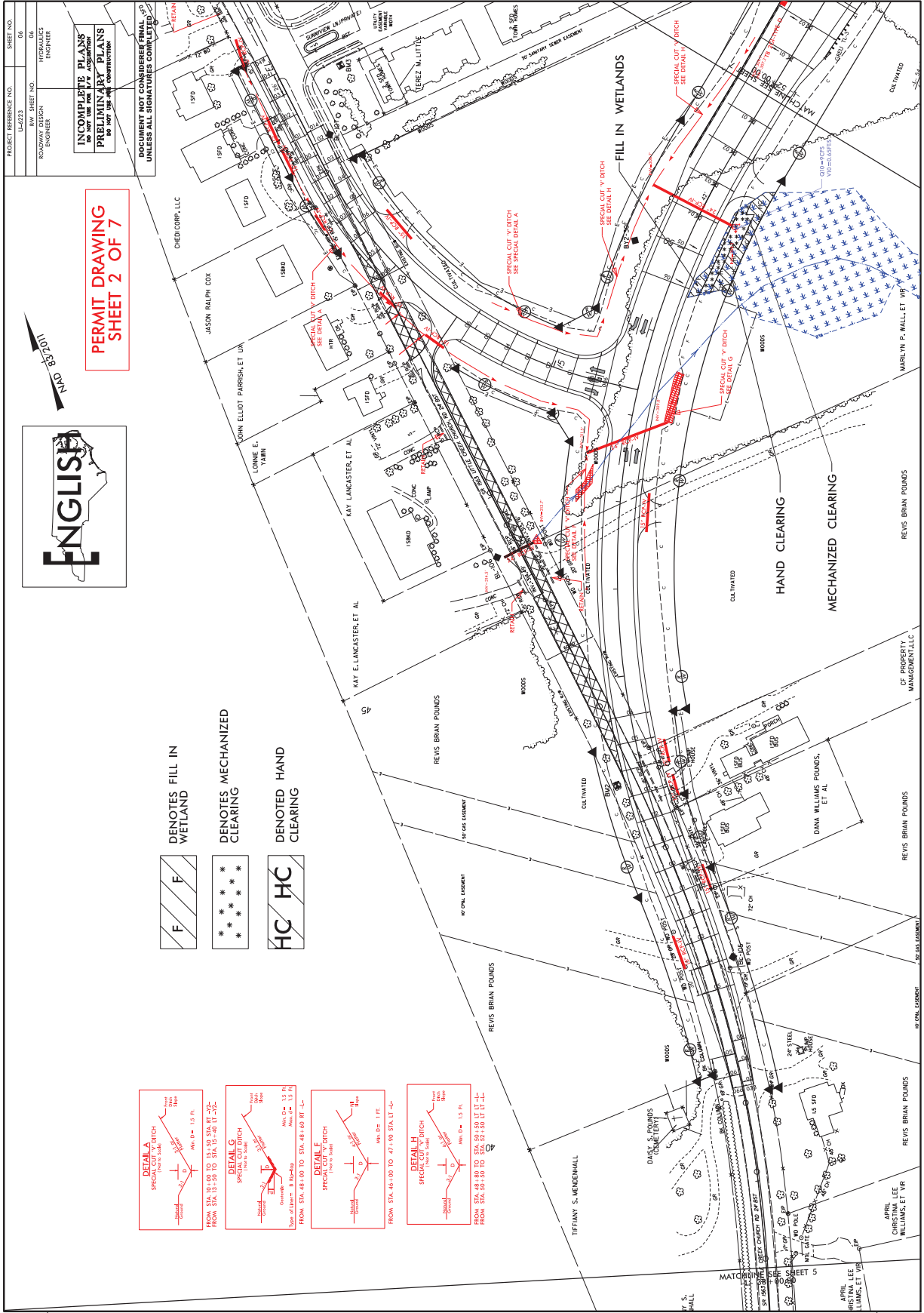

PROJECT REFERENCE NO. 14-223  
 SHEET NO. 06  
 REV. SHEET NO. 06  
 PROJECT DESIGN ENGINEER  
 INCOMPLETE PLANS  
 THIS DRAWING IS NOT VALID FOR PERMITS  
 UNLESS ALL SIGNATURES ARE COMPLETED  
 DOCUMENT NOT CONSIDERED FINAL  
 UNLESS ALL SIGNATURES COMPLETED

1100.29' DIA  
**PERMIT DRAWING  
 SHEET 2 OF 7**



- F F** DENOTES FILL IN WETLAND
- \*\*\*\*\*** DENOTES MECHANIZED CLEARING
- HC HC** DENOTES HAND CLEARING

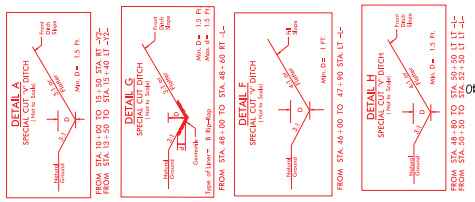

7/2/99

REGIONS  
 1



PROJECT REFERENCE NO. U6223  
 ROW SHEET NO. 07  
 ROADWAY DESIGN ENGINEER  
 HYDRAULICS ENGINEER  
**INCOMPLETE PLANS  
 DO NOT BE USED FOR CONSTRUCTION**  
**DOCUMENT NOT CONSIDERED FINAL  
 UNLESS ALL SIGNATURES COMPLETED**

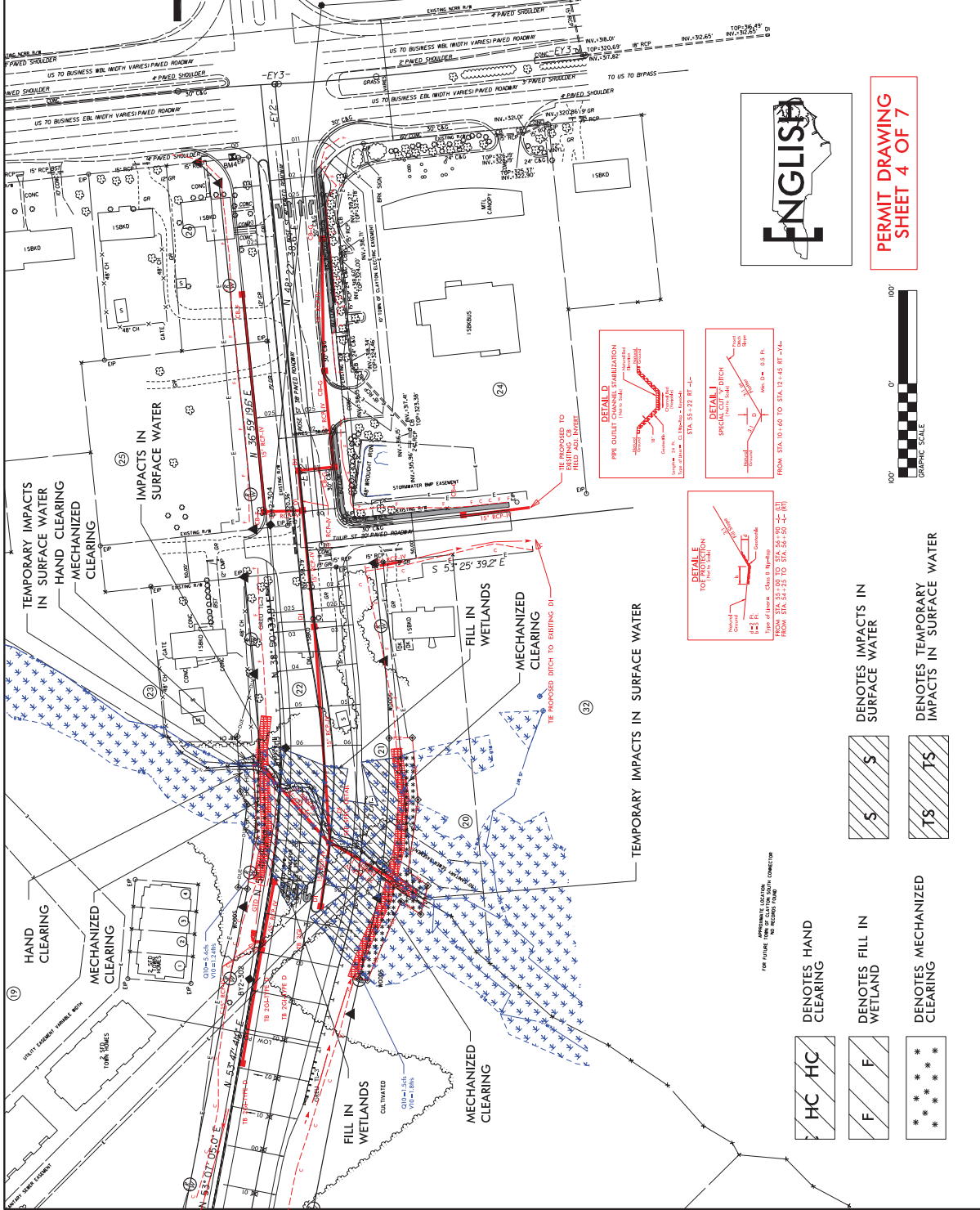

**ENGLISH**

**PERMIT DRAWING  
 SHEET 4 OF 7**

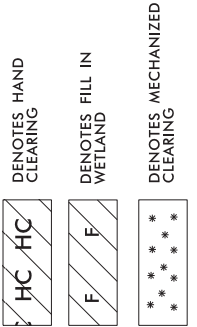
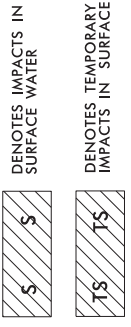
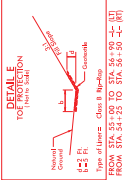
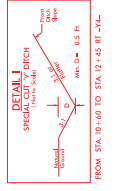
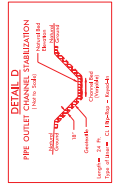

REVISIONS

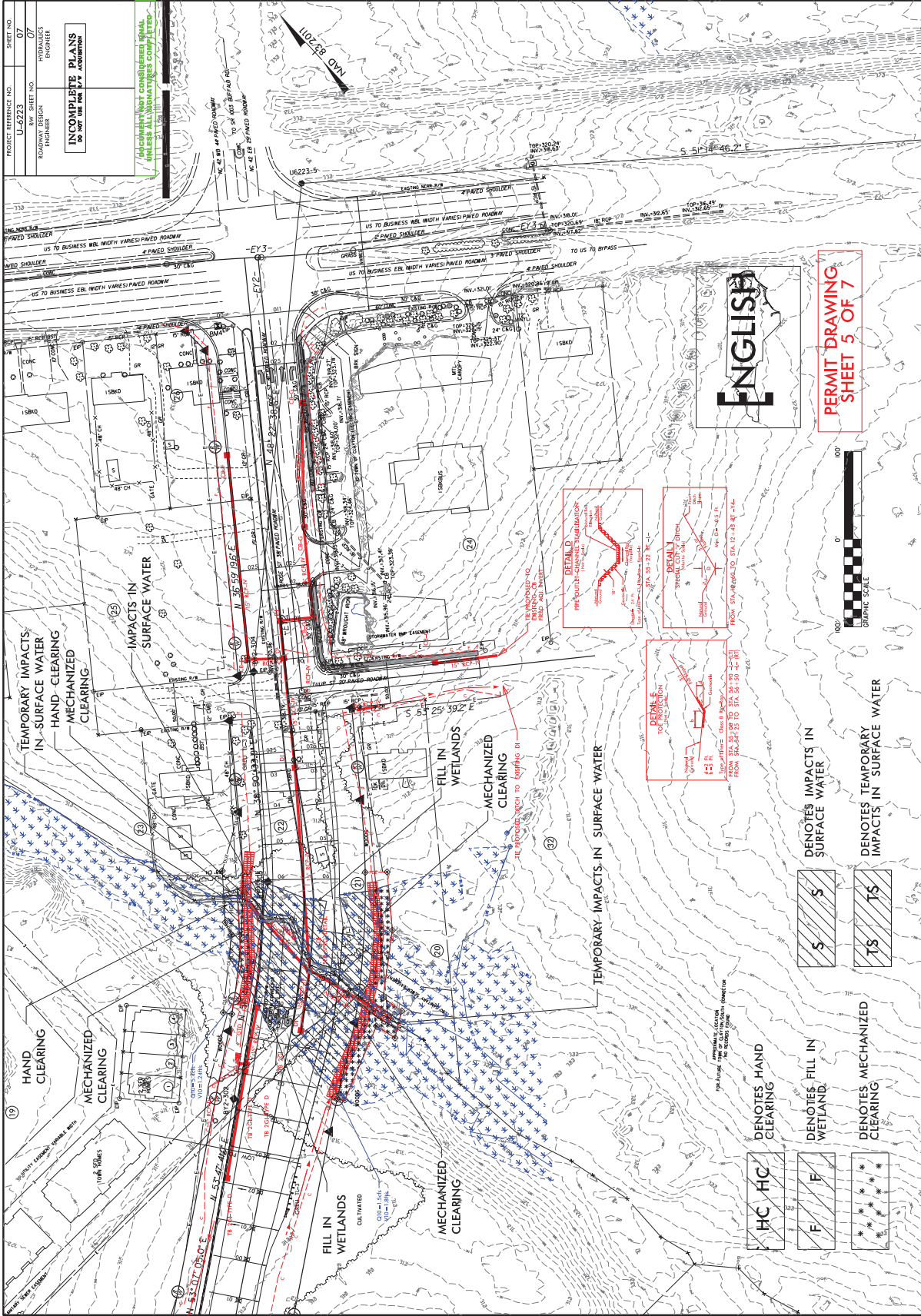

PROJECT REFERENCE NO. LL-9223  
 DRAWING NO. 07  
 HYDRAULICS ENGINEER  
 ROADWAY DESIGN ENGINEER  
 INCOMPLETION PLANS  
 TO BE USED FOR PERMITTING

DOCUMENT NOT COMPLETED  
 UNLESS ALL SIGNATURES COMPLETED

ENGLISH

PERMIT DRAWING  
 SHEET 5 OF 7



DENOTES IMPACTS IN SURFACE WATER  
 DENOTES TEMPORARY IMPACTS IN SURFACE WATER

HC HC DENOTES HAND CLEARING  
 F F DENOTES FILL IN WETLAND  
 TS TS DENOTES MECHANIZED CLEARING

REVISIONS

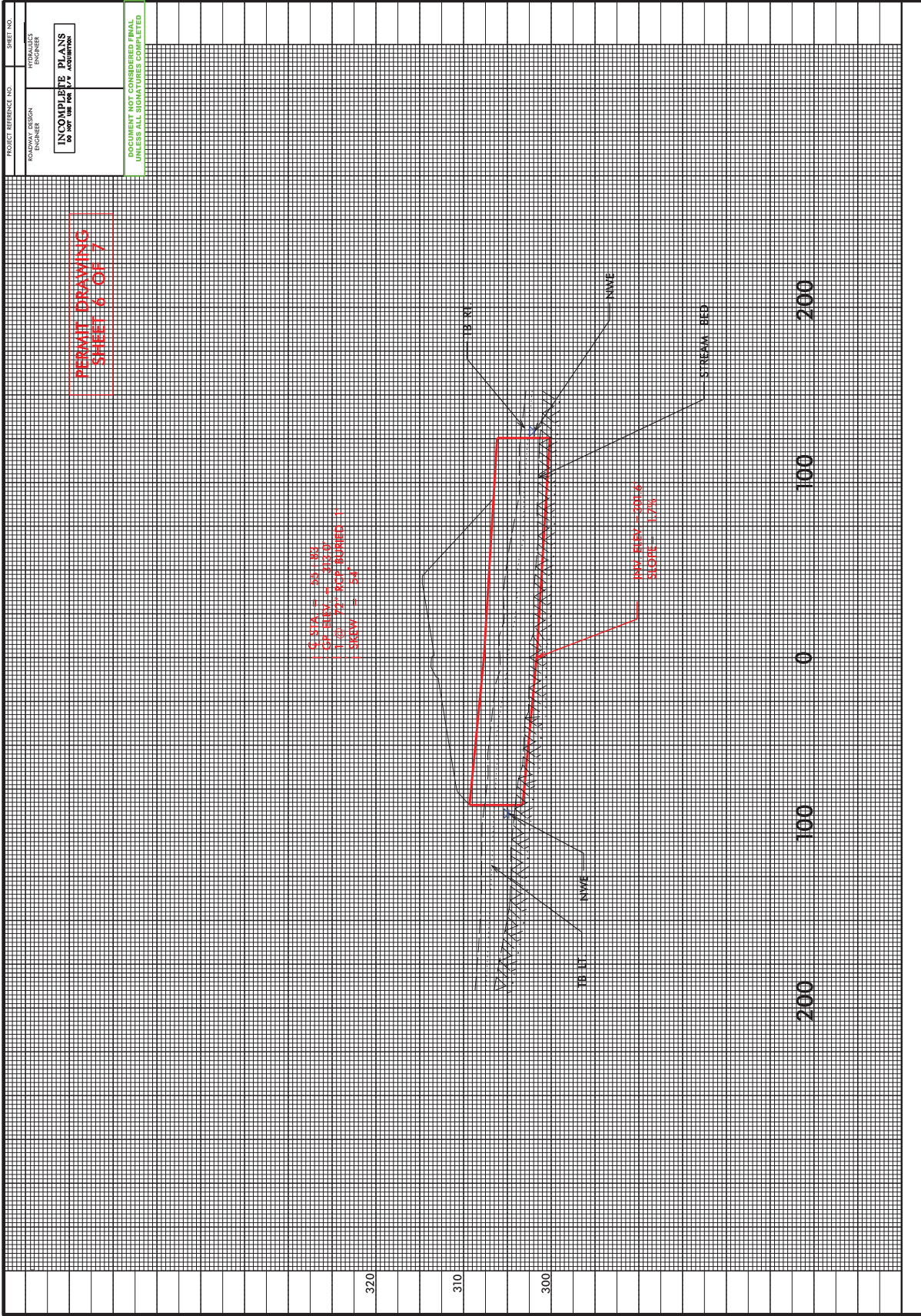



See Sheet T-A For Index of Sheets

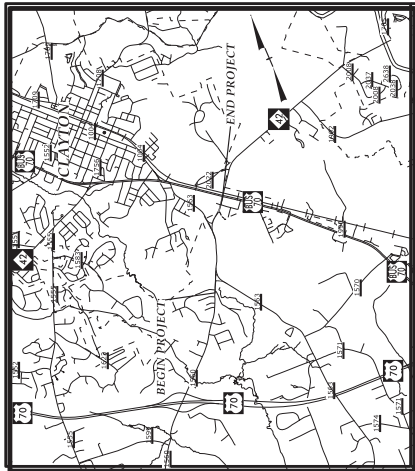

**VICINITY MAP**

STATE OF NORTH CAROLINA  
DIVISION OF HIGHWAYS

**JOHNSTON COUNTY**

LOCATION: NEW LOCATION FROM SR-1560 (RANCH ROAD)  
TO THE US-70 BUS & NC-42 INTERSECTION.

TYPE OF WORK: GRADING, DRAINAGE AND PAVING

**BUFFER IMPACTS PERMIT**

STATE	N.C.	PROJECT NUMBER	U-6223
COUNTY	JOHNSTON	PROJECT NO.	1560004
PROJECT NO.	48811.11	DESIGNER	PE

**PERMIT DRAWING  
SHEET 1 OF 4**

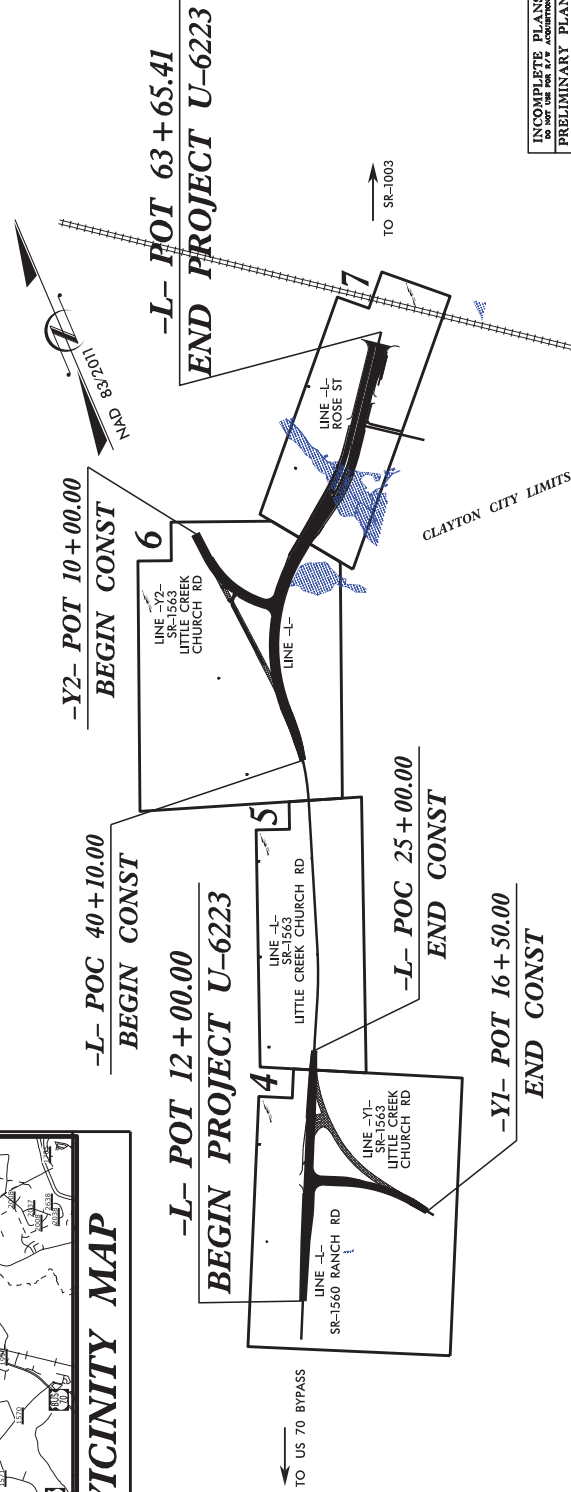

INCOMPLETE PLANS  
DO NOT USE FOR P.P. LOCATION  
PRELIMINARY PLANS  
DO NOT USE FOR CONSTRUCTION  
UNLESS ALL SIGNATURES COMPLETED

CLEARING ON THIS PROJECT SHALL BE PERFORMED TO THE LIMITS ESTABLISHED BY METHOD .  
A PORTION OF THIS PROJECT IS WITHIN THE MUNICIPAL BOUNDARIES OF CLAYTON.

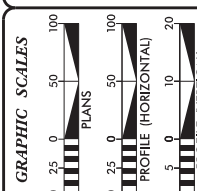

DESIGN DATA

ADT 2022	= 6300
ADT 2045	= 25800
K	= 9 %
D	= 55'
T	= 3 % *
V	= 50 MPH
* TTST=1% DUAL=2% FUNCTIONAL CLASS	

PROJECT LENGTH  
LENGTH ROADWAY TIP PROJECT U-6223 = 0.692 MILES  
TOTAL LENGTH TIP PROJECT U-6223 = 0.692 MILES

Prepared in the Office of:  
**DIVISION OF HIGHWAYS**  
300 West Block, Wilson, NC, 27395

RIGHT OF WAY DATE: KEVIN BOWEN, PE  
PROJECT ENGINEER  
JANUARY 20, 2023

LETTING DATE: D.R. ETHRIDGE  
PROJECT DESIGN ENGINEER  
JULY 16, 2024

HYDRAULICS ENGINEER  
SIGNATURE: \_\_\_\_\_ P.E.  
ROADWAY DESIGN ENGINEER  
SIGNATURE: \_\_\_\_\_ P.E.



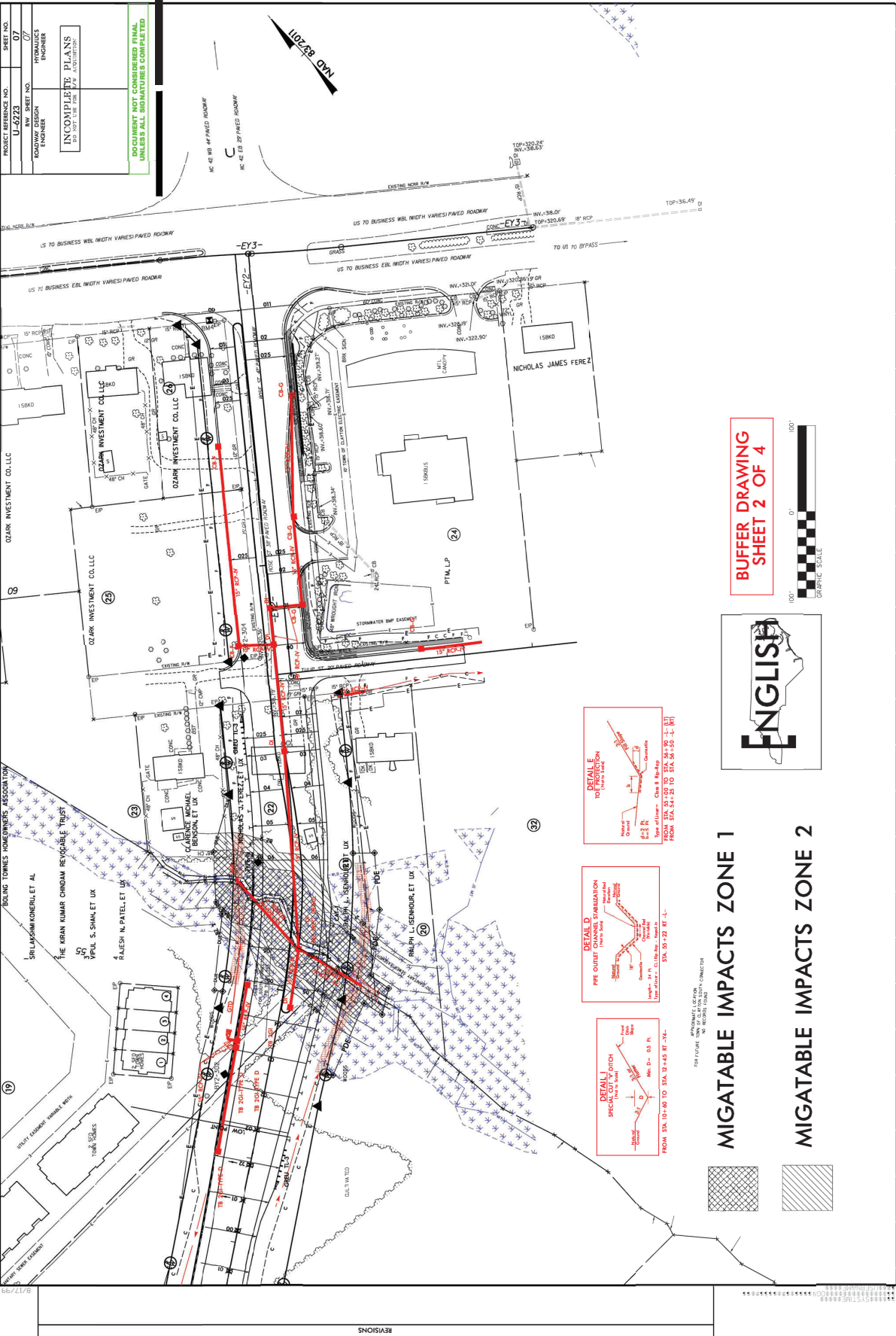

PROJECT REFERENCE NO.	U-6223	SHEET NO.	07
ROADWAY DESIGN ENGINEER	HYDRAULICS ENGINEER		

**INCOMPLETE PLANS**  
DO NOT CONSIDER FOR CONSTRUCTION

**DOCUMENT NOT CONSIDERED FINAL UNLESS ALL SIGNATURES COMPLETED**

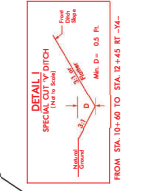
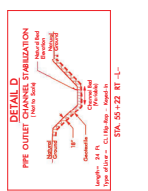
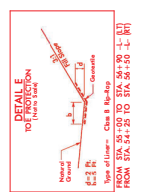

**MIGATABLE IMPACTS ZONE 1**

**MIGATABLE IMPACTS ZONE 2**

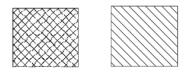

REVISIONS

NO.	DESCRIPTION



**RIPARIAN BUFFER IMPACTS SUMMARY**

Site No.	Station (From/To)	Structure Size / Type	IMPACTS				MITIGABLE				BUFFER REPLACEMENT		
			TYPE		ALLOWABLE		ZONE 1 (ft <sup>2</sup> )		ZONE 2 (ft <sup>2</sup> )		ZONE 1 (ft <sup>2</sup> )	ZONE 2 (ft <sup>2</sup> )	
			ROAD CROSSING	BRIDGE	PARALLEL IMPACT	ZONE 1 (ft <sup>2</sup> )	ZONE 2 (ft <sup>2</sup> )	TOTAL (ft <sup>2</sup> )	ZONE 1 (ft <sup>2</sup> )	ZONE 2 (ft <sup>2</sup> )	TOTAL (ft <sup>2</sup> )	ZONE 1 (ft <sup>2</sup> )	ZONE 2 (ft <sup>2</sup> )
1	-L- 54+63 TO -L- 56+89	72" RCP-IV, BURIED 1'	X				14904	9077	23981				
<b>TOTALS*:</b>						<b>0</b>	<b>14904</b>	<b>9077</b>	<b>23981</b>	<b>0</b>	<b>0</b>	<b>0</b>	<b>0</b>

NC DEPARTMENT OF TRANSPORTATION  
 DIVISION OF HIGHWAYS  
 8/26/2021  
 JOHNSTON  
 U-6223  
 49502  
 SHEET 3 OF 4

Revised 2018 Feb



County: JOHNSTON

Line #	Item Number	Sec #	Description	Quantity	Unit Cost	Amount
ROADWAY ITEMS						
0001	0000100000-N	800	MOBILIZATION	Lump Sum	L.S.	
0002	0000400000-N	801	CONSTRUCTION SURVEYING	Lump Sum	L.S.	
0003	0001000000-E	200	CLEARING & GRUBBING .. ACRE(S)	Lump Sum	L.S.	
0004	0008000000-E	200	SUPPLEMENTARY CLEARING & GRUBBING	1 ACR		
0005	0015000000-N	205	SEALING ABANDONED WELLS	3 EA		
0006	0022000000-E	225	UNCLASSIFIED EXCAVATION	8,600 CY		
0007	0036000000-E	225	UNDERCUT EXCAVATION	6,400 CY		
0008	0106000000-E	230	BORROW EXCAVATION	17,700 CY		
0009	0134000000-E	240	DRAINAGE DITCH EXCAVATION	30 CY		
0010	0156000000-E	250	REMOVAL OF EXISTING ASPHALT PAVEMENT	3,800 SY		
0011	0195000000-E	265	SELECT GRANULAR MATERIAL	6,400 CY		
0012	0196000000-E	270	GEOTEXTILE FOR SOIL STABILIZATION	10,400 SY		
0013	0318000000-E	300	FOUNDATION CONDITIONING MATERIAL, MINOR STRUCTURES	350 TON		
0014	0320000000-E	300	FOUNDATION CONDITIONING GEOTEXTILE	1,080 SY		
0015	0354000000-E	310	**** RC PIPE CULVERTS, CLASS ***** (18",V)	160 LF		
0016	0354000000-E	310	**** RC PIPE CULVERTS, CLASS ***** (24",V)	84 LF		
0017	0448000000-E	310	***** RC PIPE CULVERTS, CLASS IV (72")	192 LF		

County: JOHNSTON

Line #	Item Number	Sec #	Description	Quantity	Unit Cost	Amount
0018	0448200000-E	310	15" RC PIPE CULVERTS, CLASS IV	1,892 LF		
0019	0448300000-E	310	18" RC PIPE CULVERTS, CLASS IV	568 LF		
0020	0448400000-E	310	24" RC PIPE CULVERTS, CLASS IV	280 LF		
0021	0448600000-E	310	36" RC PIPE CULVERTS, CLASS IV	40 LF		
0022	0995000000-E	340	PIPE REMOVAL	828 LF		
0023	1011000000-N	500	FINE GRADING	Lump Sum	L.S.	
0024	1099500000-E	505	SHALLOW UNDERCUT	1,300 CY		
0025	1099700000-E	505	CLASS IV SUBGRADE STABILIZATION	2,650 TON		
0026	1220000000-E	545	INCIDENTAL STONE BASE	1,000 TON		
0027	1264000000-E	SP	DITCHING	72 LF		
0028	1330000000-E	607	INCIDENTAL MILLING	2,700 SY		
0029	1491000000-E	610	ASPHALT CONC BASE COURSE, TYPE B25.0C	6,100 TON		
0030	1503000000-E	610	ASPHALT CONC INTERMEDIATE COURSE, TYPE I19.0C	5,400 TON		
0031	1523000000-E	610	ASPHALT CONC SURFACE COURSE, TYPE S9.5C	4,900 TON		
0032	1575000000-E	620	ASPHALT BINDER FOR PLANT MIX	825 TON		
0033	1693000000-E	654	ASPHALT PLANT MIX, PAVEMENT REPAIR	320 TON		
0034	2022000000-E	815	SUBDRAIN EXCAVATION	958 CY		

County: JOHNSTON

Line #	Item Number	Sec #	Description	Quantity	Unit Cost	Amount
0035	2026000000-E	815	GEOTEXTILE FOR SUBSURFACE DRAINS	4,275 SY		
0036	2036000000-E	815	SUBDRAIN COARSE AGGREGATE	719 CY		
0037	2044000000-E	815	6" PERFORATED SUBDRAIN PIPE	4,275 LF		
0038	2070000000-N	815	SUBDRAIN PIPE OUTLET	9 EA		
0039	2077000000-E	815	6" OUTLET PIPE	54 LF		
0040	2220000000-E	838	REINFORCED ENDWALLS	9.4 CY		
0041	2253000000-E	840	PIPE COLLARS	1 CY		
0042	2264000000-E	840	PIPE PLUGS	1 CY		
0043	2286000000-N	840	MASONRY DRAINAGE STRUCTURES	19 EA		
0044	2297000000-E	840	MASONRY DRAINAGE STRUCTURES	7.5 CY		
0045	2364000000-N	840	FRAME WITH TWO GRATES, STD 840.16	6 EA		
0046	2364200000-N	840	FRAME WITH TWO GRATES, STD 840.20	2 EA		
0047	2365000000-N	840	FRAME WITH TWO GRATES, STD 840.22	2 EA		
0048	2366000000-N	840	FRAME WITH TWO GRATES, STD 840.24	1 EA		
0049	2374000000-N	840	FRAME WITH GRATE & HOOD, STD 840.03, TYPE ** (E)	2 EA		
0050	2374000000-N	840	FRAME WITH GRATE & HOOD, STD 840.03, TYPE ** (F)	3 EA		
0051	2374000000-N	840	FRAME WITH GRATE & HOOD, STD 840.03, TYPE ** (G)	4 EA		

County: JOHNSTON

Line #	Item Number	Sec #	Description	Quantity	Unit Cost	Amount
0052	2451000000-N	852	CONCRETE TRANSITIONAL SECTION FOR DROP INLET	5 EA		
0053	2542000000-E	846	1'-6" CONCRETE CURB & GUTTER	1,550 LF		
0054	2549000000-E	846	2'-6" CONCRETE CURB & GUTTER	1,450 LF		
0055	2591000000-E	848	4" CONCRETE SIDEWALK	260 SY		
0056	2605000000-N	848	CONCRETE CURB RAMPS	3 EA		
0057	2612000000-E	848	6" CONCRETE DRIVEWAY	40 SY		
0058	2724000000-E	857	PRECAST REINFORCED CONCRETE BARRIER, SINGLE FACED	547.59 LF		
0059	2830000000-N	858	ADJUSTMENT OF MANHOLES	4 EA		
0060	2845000000-N	858	ADJUSTMENT OF METER BOXES OR VALVE BOXES	15 EA		
0061	3030000000-E	862	STEEL BEAM GUARDRAIL	387.5 LF		
0062	3150000000-N	862	ADDITIONAL GUARDRAIL POSTS	10 EA		
0063	3210000000-N	862	GUARDRAIL END UNITS, TYPE CAT-1	1 EA		
0064	3215000000-N	SP	GUARDRAIL ANCHOR UNITS, TYPE III	1 EA		
0065	3287000000-N	SP	GUARDRAIL END UNITS, TYPE TL-3	2 EA		
0066	3575000000-E	SP	GENERIC FENCING ITEM PEDESTRIAN SAFETY RAIL	130 LF		
0067	3628000000-E	876	RIP RAP, CLASS I	50 TON		
0068	3649000000-E	876	RIP RAP, CLASS B	310 TON		

County: JOHNSTON

Line #	Item Number	Sec #	Description	Quantity	Unit Cost	Amount
0069	3656000000-E	876	GEOTEXTILE FOR DRAINAGE	1,220 SY		
0070	4072000000-E	903	SUPPORTS, 3-LB STEEL U-CHANNEL	479 LF		
0071	4096000000-N	904	SIGN ERECTION, TYPE D	2 EA		
0072	4102000000-N	904	SIGN ERECTION, TYPE E	22 EA		
0073	4108000000-N	904	SIGN ERECTION, TYPE F	28 EA		
0074	4155000000-N	907	DISPOSAL OF SIGN SYSTEM, U-CHANNEL	21 EA		
0075	4400000000-E	1110	WORK ZONE SIGNS (STATIONARY)	216 SF		
0076	4405000000-E	1110	WORK ZONE SIGNS (PORTABLE)	384 SF		
0077	4410000000-E	1110	WORK ZONE SIGNS (BARRICADE MOUNTED)	59 SF		
0078	4415000000-N	1115	FLASHING ARROW BOARD	2 EA		
0079	4420000000-N	1120	PORTABLE CHANGEABLE MESSAGE SIGN	2 EA		
0080	4430000000-N	1130	DRUMS	350 EA		
0081	4445000000-E	1145	BARRICADES (TYPE III)	104 LF		
0082	4447000000-E	SP	PEDESTRIAN CHANNELIZING DEVICES	8 LF		
0083	4455000000-N	1150	FLAGGER	330 DAY		
0084	4480000000-N	1165	TMA	2 EA		
0085	4520000000-N	1266	TUBULAR MARKERS (FIXED)	6 EA		

County: JOHNSTON

Line #	Item Number	Sec #	Description	Quantity	Unit Cost	Amount
0086	4650000000-N	1251	TEMPORARY RAISED PAVEMENT MARKERS	145 EA		
0087	4685000000-E	1205	THERMOPLASTIC PAVEMENT MARKING LINES (4", 90 MILS)	19,446 LF		
0088	4695000000-E	1205	THERMOPLASTIC PAVEMENT MARKING LINES (8", 90 MILS)	1,018 LF		
0089	4709000000-E	1205	THERMOPLASTIC PAVEMENT MARKING LINES (24", 90 MILS)	281 LF		
0090	4720000000-E	1205	THERMOPLASTIC PAVEMENT MARKING CHARACTER (90 MILS)	8 EA		
0091	4725000000-E	1205	THERMOPLASTIC PAVEMENT MARKING SYMBOL (90 MILS)	51 EA		
0092	4810000000-E	1205	PAINT PAVEMENT MARKING LINES (4")	22,090 LF		
0093	4815000000-E	1205	PAINT PAVEMENT MARKING LINES (6")	118 LF		
0094	4820000000-E	1205	PAINT PAVEMENT MARKING LINES (8")	930 LF		
0095	4835000000-E	1205	PAINT PAVEMENT MARKING LINES (24")	300 LF		
0096	4840000000-N	1205	PAINT PAVEMENT MARKING CHARACTER	8 EA		
0097	4845000000-N	1205	PAINT PAVEMENT MARKING SYMBOL	38 EA		
0098	4850000000-E	1205	REMOVAL OF PAVEMENT MARKING LINES (4")	8,059 LF		
0099	4860000000-E	1205	REMOVAL OF PAVEMENT MARKING LINES (8")	36 LF		
0100	4870000000-E	1205	REMOVAL OF PAVEMENT MARKING LINES (24")	39 LF		
0101	4875000000-N	1205	REMOVAL OF PAVEMENT MARKING SYMBOLS & CHARACTERS	4 EA		
0102	4900000000-N	1251	PERMANENT RAISED PAVEMENT MARKERS	120 EA		



County: JOHNSTON

Line #	Item Number	Sec #	Description	Quantity	Unit Cost	Amount
0103	5255000000-N	1413	PORTABLE LIGHTING	Lump Sum	L.S.	
0104	5325200000-E	1510	2" WATER LINE	30 LF		
0105	5325600000-E	1510	6" WATER LINE	308 LF		
0106	5325800000-E	1510	8" WATER LINE	1,472 LF		
0107	5326200000-E	1510	12" WATER LINE	1,783 LF		
0108	5329000000-E	1510	DUCTILE IRON WATER PIPE FITTINGS	7,285 LB		
0109	5536000000-E	1515	2" VALVE	1 EA		
0110	5540000000-E	1515	6" VALVE	7 EA		
0111	5546000000-E	1515	8" VALVE	9 EA		
0112	5558000000-E	1515	12" VALVE	5 EA		
0113	5571800000-E	1515	8" TAPPING SLEEVE & VALVE	1 EA		
0114	5606000000-E	1515	2" BLOW OFF	1 EA		
0115	5648000000-N	1515	RELOCATE WATER METER	5 EA		
0116	5666000000-N	1515	FIRE HYDRANT	1 EA		
0117	5672000000-N	1515	RELOCATE FIRE HYDRANT	2 EA		
0118	5673000000-E	1515	FIRE HYDRANT LEG	20 LF		
0119	5686500000-E	1515	WATER SERVICE LINE	20 LF		

County: JOHNSTON

Line #	Item Number	Sec #	Description	Quantity	Unit Cost	Amount
0120	5691300000-E	1520	8" SANITARY GRAVITY SEWER	435 LF		
0121	5691500000-E	1520	12" SANITARY GRAVITY SEWER	368 LF		
0122	5709200000-E	1520	4" FORCE MAIN SEWER	230 LF		
0123	5776000000-E	1525	5' DIA UTILITY MANHOLE	3 EA		
0124	5782000000-E	1525	UTILITY MANHOLE WALL 5' DIA	28 LF		
0125	5798000000-E	1530	ABANDON *** UTILITY PIPE (2")	175 LF		
0126	5798000000-E	1530	ABANDON *** UTILITY PIPE (4")	219 LF		
0127	5800000000-E	1530	ABANDON 6" UTILITY PIPE	523 LF		
0128	5801000000-E	1530	ABANDON 8" UTILITY PIPE	1,590 LF		
0129	5804000000-E	1530	ABANDON 12" UTILITY PIPE	345 LF		
0130	5815000000-N	1530	REMOVE WATER METER	1 EA		
0131	5816000000-N	1530	ABANDON UTILITY MANHOLE	1 EA		
0132	5828000000-N	1530	REMOVE UTILITY MANHOLE	1 EA		
0133	5835600000-E	1540	12" ENCASEMENT PIPE	105 LF		
0134	5835900000-E	1540	20" ENCASEMENT PIPE	124 LF		
0135	5836000000-E	1540	24" ENCASEMENT PIPE	91 LF		
0136	5872500000-E	1550	BORE AND JACK OF *** (20")	84 LF		

County: JOHNSTON

Line #	Item Number	Sec #	Description	Quantity	Unit Cost	Amount
0137	6000000000-E	1605	TEMPORARY SILT FENCE	5,800 LF		
0138	6006000000-E	1610	STONE FOR EROSION CONTROL, CLASS A	300 TON		
0139	6009000000-E	1610	STONE FOR EROSION CONTROL, CLASS B	650 TON		
0140	6012000000-E	1610	SEDIMENT CONTROL STONE	440 TON		
0141	6015000000-E	1615	TEMPORARY MULCHING	15.5 ACR		
0142	6018000000-E	1620	SEED FOR TEMPORARY SEEDING	1,000 LB		
0143	6021000000-E	1620	FERTILIZER FOR TEMPORARY SEEDING	6 TON		
0144	6024000000-E	1622	TEMPORARY SLOPE DRAINS	200 LF		
0145	6029000000-E	SP	SAFETY FENCE	450 LF		
0146	6030000000-E	1630	SILT EXCAVATION	2,450 CY		
0147	6036000000-E	1631	MATTING FOR EROSION CONTROL	7,550 SY		
0148	6037000000-E	SP	COIR FIBER MAT	100 SY		
0149	6042000000-E	1632	1/4" HARDWARE CLOTH	1,200 LF		
0150	6043000000-E	SP	LOW PERMEABILITY GEOTEXTILE	100 SY		
0151	6070000000-N	1639	SPECIAL STILLING BASINS	2 EA		
0152	6071010000-E	SP	WATTLE	800 LF		
0153	6071020000-E	SP	POLYACRYLAMIDE (PAM)	325 LB		

County: JOHNSTON

Line #	Item Number	Sec #	Description	Quantity	Unit Cost	Amount
0154	6071030000-E	1640	COIR FIBER BAFFLE	750 LF		
0155	6071050000-E	SP	*** SKIMMER (1-1/2")	2 EA		
0156	6071050000-E	SP	*** SKIMMER (2")	2 EA		
0157	6084000000-E	1660	SEEDING & MULCHING	15 ACR		
0158	6087000000-E	1660	MOWING	9 ACR		
0159	6090000000-E	1661	SEED FOR REPAIR SEEDING	200 LB		
0160	6093000000-E	1661	FERTILIZER FOR REPAIR SEEDING	0.5 TON		
0161	6096000000-E	1662	SEED FOR SUPPLEMENTAL SEEDING	375 LB		
0162	6108000000-E	1665	FERTILIZER TOPDRESSING	11.25 TON		
0163	6111000000-E	SP	IMPERVIOUS DIKE	100 LF		
0164	6114500000-N	1667	SPECIALIZED HAND MOWING	10 MHR		
0165	6117000000-N	SP	RESPONSE FOR EROSION CONTROL	25 EA		
0166	6117500000-N	SP	CONCRETE WASHOUT STRUCTURE	4 EA		
0167	6123000000-E	1670	REFORESTATION	0.1 ACR		
0168	7060000000-E	1705	SIGNAL CABLE	3,360 LF		
0169	7120000000-E	1705	VEHICLE SIGNAL HEAD (12", 3 SECTION)	29 EA		
0170	7132000000-E	1705	VEHICLE SIGNAL HEAD (12", 4 SECTION)	2 EA		

County: JOHNSTON

Line #	Item Number	Sec #	Description	Quantity	Unit Cost	Amount
0171	7204000000-N	1705	LOUVER	1 EA		
0172	7264000000-E	1710	MESSENGER CABLE (3/8")	1,180 LF		
0173	7279000000-E	1715	TRACER WIRE	4,480 LF		
0174	7300000000-E	1715	UNPAVED TRENCHING (***** (1, 2")	1,370 LF		
0175	7300000000-E	1715	UNPAVED TRENCHING (***** (2, 2")	3,000 LF		
0176	7301000000-E	1715	DIRECTIONAL DRILL (***** (1, 2")	260 LF		
0177	7301000000-E	1715	DIRECTIONAL DRILL (***** (2, 2")	1,480 LF		
0178	7324000000-N	1716	JUNCTION BOX (STANDARD SIZE)	19 EA		
0179	7348000000-N	1716	JUNCTION BOX (OVER-SIZED, HEAVY DUTY)	11 EA		
0180	7360000000-N	1720	WOOD POLE	10 EA		
0181	7372000000-N	1721	GUY ASSEMBLY	19 EA		
0182	7408000000-E	1722	1" RISER WITH WEATHERHEAD	2 EA		
0183	7420000000-E	1722	2" RISER WITH WEATHERHEAD	11 EA		
0184	7444000000-E	1725	INDUCTIVE LOOP SAWCUT	2,560 LF		
0185	7456000000-E	1726	LEAD-IN CABLE (***** (14-2)	6,670 LF		
0186	7516000000-E	1730	COMMUNICATIONS CABLE (** FIBER) (24)	5,030 LF		
0187	7528000000-E	1730	DROP CABLE	400 LF		

County: JOHNSTON

Line #	Item Number	Sec #	Description	Quantity	Unit Cost	Amount
0188	7540000000-N	1731	SPLICE ENCLOSURE	3 EA		
0189	7552000000-N	1731	INTERCONNECT CENTER	3 EA		
0190	7566000000-N	1733	DELINEATOR MARKER	11 EA		
0191	7575142060-N	SP	MODIFY RADIO INSTALLATION	1 EA		
0192	7684000000-N	1750	SIGNAL CABINET FOUNDATION	3 EA		
0193	7744000000-N	1751	DETECTOR CARD (TYPE 170)	19 EA		
0194	7756000000-N	1751	CONTROLLER WITH CABINET (TYPE 2070L, BASE MOUNTED)	3 EA		
0195	7901000000-N	1753	CABINET BASE EXTENDER	3 EA		
0196	7980000000-N	SP	GENERIC SIGNAL ITEM ETHERNET EDGE SWITCH	3 EA		
WALL ITEMS						
0197	8801000000-E	SP	MSE RETAINING WALL NO **** (1)	760 SF		
0198	8847000000-E	SP	GENERIC RETAINING WALL ITEM ARCHITECTURAL SURFACE TREATMENT (SOUND BARRIER WALL)	12,324 SF		
0199	8847000000-E	SP	GENERIC RETAINING WALL ITEM SOUND BARRIER WALL	7,650 SF		

0855/June14/Q243962.34/D887648802060/E199

Total Amount Of Bid For Entire Project :

Vendor 1 of 3: FSC II LLC (5072)  
Call Order 005 (Proposal: C204729)

### Bid Information

---

<b>Proposal County:</b> JOHNSTON	<b>Bid Checksum:</b> E49CF01597
<b>Vendor Address:</b> 701 CORPORATE CENTER DRIVE STE 101 RALEIGH , NC , 27607	<b>Bid Total:</b> \$9,742,469.45
<b>Signature Check:</b> Thomas Tyree Johnson Jr.	<b>Items Total:</b> \$9,742,469.45
<b>Time Bid Received:</b> July 19, 2022 01:43 PM	<b>Time Total:</b> \$0.00
<b>Amendment Count:</b> 0	

**Bidding Errors:**  
None.

**DBE Goal: 6.0% (\$584,548.17)**  
**Participation Submitted 6.02% (\$586,666.41)**

**Vendor 1 of 3: FSC II LLC (5072)**  
**Call Order 005 (Proposal: C204729)**

### Bid Bond Information

---

<b>Projects:</b>	<b>Bond Maximum:</b>
<b>Counties:</b>	<b>State of Incorporation:</b>
<b>Bond ID:</b> SNC07141185	<b>Agency Execution Date:</b> 07/14/2022 07
<b>Paid by Check:</b> No	<b>Surety Name:</b> Surety2000
<b>Bond Percent:</b> 5%	<b>Bond Agency Name:</b> Western Surety Company



### DBE Load Information

Letting ID: L220719  
Letting Date: 07/19/2022  
Call Order: 005  
Contract ID: C204729  
Project: 1560005156000515600051560005  
Bid Total: \$9,742,469.45  
DBE Goal: 6.00% (\$584,548.17)

Vendor ID: 5072  
Vendor Name: FSC II LLC dba Fred Smith Company  
DBE Entered: 6.02% (\$586,666.41)

<u>Vendor ID</u>	<u>DBE Name</u>	<u>Is Supplier?</u>	<u>City/State</u>	<u>Goods/Service</u>	<u>Amount</u>
12536	ARBOREX TREE SERVICES LLC	False	4605 WINDY KNOLL ROAD RALEIGH, NC 27616	SubContractor	53,000.00
11816	MARTINEZ COMPANY INC	False	813 E. PARKER STREET GRAHAM, NC 27253	SubContractor	174,557.16
4247	SEAL BROTHERS CONTRACTING LLC	False	3618 WEST PINE ST MOUNT AIRY, NC 27030	SubContractor	249,309.25
7294	STRATCON CONTRACTING CORP	False	P.O. Box 14189 RALEIGH, NC 27620	SubContractor	109,800.00

**DBE Entry: ARBOREX TREE SERVICES LLC**

Vendor ID: 12536  
Supplier: No  
Used As: SubContractor  
Amount Entered: 53,000.00  
Total: 53,000.00  
Is Entry Complete?:  
Error: None

Line Number	Item Number	Quantity	Unit	Unit Price	Extension Price
Section 0001 ROADWAY ITEMS					
0001	0000100000-N MOBILIZATION	1.000	LS	\$486,000.0000	\$486,000.00
0002	0000400000-N CONSTRUCTION SURVEYING	1.000	LS	\$130,000.0000	\$130,000.00
0003	0001000000-E CLEARING & GRUBBING .. ACRE(S)	1.000	LS	\$784,000.0000	\$784,000.00
0004	0008000000-E SUPPLEMENTARY CLEARING & GRUBBING	1.000	ACR	\$1.0000	\$1.00
0005	0015000000-N SEALING ABANDONED WELLS	3.000	EA	\$3,000.0000	\$9,000.00
0006	0022000000-E UNCLASSIFIED EXCAVATION	8600.000	CY	\$30.0000	\$258,000.00
0007	0036000000-E UNDERCUT EXCAVATION	6400.000	CY	\$40.0000	\$256,000.00
0008	0106000000-E BORROW EXCAVATION	17700.000	CY	\$26.0000	\$460,200.00
0009	0134000000-E DRAINAGE DITCH EXCAVATION	30.000	CY	\$35.0000	\$1,050.00
0010	0156000000-E REMOVAL OF EXISTING ASPHALT PAVEMENT	3800.000	SY	\$10.0000	\$38,000.00
0011	0195000000-E SELECT GRANULAR MATERIAL	6400.000	CY	\$40.0000	\$256,000.00
0012	0196000000-E GEOTEXTILE FOR SOIL STABILIZATION	10400.000	SY	\$3.0000	\$31,200.00
0013	0318000000-E FOUNDATION CONDITIONING MATERIAL, MINOR STRUCTURES	350.000	TON	\$55.0000	\$19,250.00
0014	0320000000-E FOUNDATION CONDITIONING GEOTEXTILE	1080.000	SY	\$3.0000	\$3,240.00
0015	0354000000-E **** RC PIPE CULVERTS, CLASS ***** (18",V)	160.000	LF	\$95.0000	\$15,200.00
0016	0354000000-E **** RC PIPE CULVERTS, CLASS ***** (24",V)	84.000	LF	\$190.0000	\$15,960.00
0017	0448000000-E ***** RC PIPE CULVERTS, CLASS IV (72")	192.000	LF	\$825.0000	\$158,400.00
0018	0448200000-E 15" RC PIPE CULVERTS, CLASS IV	1892.000	LF	\$85.0000	\$160,820.00
0019	0448300000-E 18" RC PIPE CULVERTS, CLASS IV	568.000	LF	\$120.0000	\$68,160.00
0020	0448400000-E 24" RC PIPE CULVERTS, CLASS IV	280.000	LF	\$130.0000	\$36,400.00
0021	0448600000-E 36" RC PIPE CULVERTS, CLASS IV	40.000	LF	\$260.0000	\$10,400.00
0022	0995000000-E PIPE REMOVAL	828.000	LF	\$25.0000	\$20,700.00
0023	1011000000-N FINE GRADING	1.000	LS	\$725,000.0000	\$725,000.00

0024	1099500000-E	1300.000	CY	\$50.0000	\$65,000.00
	SHALLOW UNDERCUT				
0025	1099700000-E	2650.000	TON	\$35.0000	\$92,750.00
	CLASS IV SUBGRADE STABILIZATION				
0026	1220000000-E	1000.000	TON	\$50.0000	\$50,000.00
	INCIDENTAL STONE BASE				
0027	1264000000-E	72.000	LF	\$50.0000	\$3,600.00
	DITCHING				
0028	1330000000-E	2700.000	SY	\$12.0000	\$32,400.00
	INCIDENTAL MILLING				
0029	1491000000-E	6100.000	TON	\$66.0000	\$402,600.00
	ASPHALT CONC BASE COURSE, TYPE B25.0C				
0030	1503000000-E	5400.000	TON	\$63.0000	\$340,200.00
	ASPHALT CONC INTERMEDIATE COURSE, TYPE I19.0C				
0031	1523000000-E	4900.000	TON	\$74.0000	\$362,600.00
	ASPHALT CONC SURFACE COURSE, TYPE S9.5C				
0032	1575000000-E	825.000	TON	\$900.0000	\$742,500.00
	ASPHALT BINDER FOR PLANT MIX				
0033	1693000000-E	320.000	TON	\$275.0000	\$88,000.00
	ASPHALT PLANT MIX, PAVEMENT REPAIR				
0034	2022000000-E	958.000	CY	\$42.0000	\$40,236.00
	SUBDRAIN EXCAVATION				
0035	2026000000-E	4275.000	SY	\$12.0000	\$51,300.00
	GEOTEXTILE FOR SUBSURFACE DRAINS				
0036	2036000000-E	719.000	CY	\$75.0000	\$53,925.00
	SUBDRAIN COARSE AGGREGATE				
0037	2044000000-E	4275.000	LF	\$16.7500	\$71,606.25
	6" PERFORATED SUBDRAIN PIPE				
0038	2070000000-N	9.000	EA	\$450.0000	\$4,050.00
	SUBDRAIN PIPE OUTLET				
0039	2077000000-E	54.000	LF	\$48.0000	\$2,592.00
	6" OUTLET PIPE				
0040	2220000000-E	9.400	CY	\$2,500.0000	\$23,500.00
	REINFORCED ENDWALLS				
0041	2253000000-E	1.000	CY	\$2,600.0000	\$2,600.00
	PIPE COLLARS				
0042	2264000000-E	1.000	CY	\$2,600.0000	\$2,600.00
	PIPE PLUGS				
0043	2286000000-N	19.000	EA	\$3,900.0000	\$74,100.00
	MASONRY DRAINAGE STRUCTURES				
0044	2297000000-E	7.500	CY	\$8,200.0000	\$61,500.00
	MASONRY DRAINAGE STRUCTURES				
0045	2364000000-N	6.000	EA	\$1,100.0000	\$6,600.00
	FRAME WITH TWO GRATES, STD 840.16				
0046	2364200000-N	2.000	EA	\$1,100.0000	\$2,200.00
	FRAME WITH TWO GRATES, STD 840.20				
0047	2365000000-N	2.000	EA	\$1,100.0000	\$2,200.00
	FRAME WITH TWO GRATES, STD 840.22				
0048	2366000000-N	1.000	EA	\$1,100.0000	\$1,100.00

FRAME WITH TWO GRATES, STD 840.24					
0049	2374000000-N	2.000 EA		\$1,100.0000	\$2,200.00
	FRAME WITH GRATE & HOOD, STD 840.03, TYPE ** (E)				
0050	2374000000-N	3.000 EA		\$1,200.0000	\$3,600.00
	FRAME WITH GRATE & HOOD, STD 840.03, TYPE ** (F)				
0051	2374000000-N	4.000 EA		\$1,200.0000	\$4,800.00
	FRAME WITH GRATE & HOOD, STD 840.03, TYPE ** (G)				
0052	2451000000-N	5.000 EA		\$1,350.0000	\$6,750.00
	CONCRETE TRANSITIONAL SECTION FOR DROP INLET				
0053	2542000000-E	1550.000 LF		\$24.0000	\$37,200.00
	1'-6" CONCRETE CURB & GUTTER				
0054	2549000000-E	1450.000 LF		\$25.6500	\$37,192.50
	2'-6" CONCRETE CURB & GUTTER				
0055	2591000000-E	260.000 SY		\$53.1000	\$13,806.00
	4" CONCRETE SIDEWALK				
0056	2605000000-N	3.000 EA		\$1,950.0000	\$5,850.00
	CONCRETE CURB RAMPS				
0057	2612000000-E	40.000 SY		\$72.0000	\$2,880.00
	6" CONCRETE DRIVEWAY				
0058	2724000000-E	547.590 LF		\$135.0000	\$73,924.65
	PRECAST REINFORCED CONCRETE BARRIER, SINGLE FACED				
0059	2830000000-N	4.000 EA		\$450.0000	\$1,800.00
	ADJUSTMENT OF MANHOLES				
0060	2845000000-N	15.000 EA		\$400.0000	\$6,000.00
	ADJUSTMENT OF METER BOXES OR VALVE BOXES				
0061	3030000000-E	387.500 LF		\$27.0000	\$10,462.50
	STEEL BEAM GUARDRAIL				
0062	3150000000-N	10.000 EA		\$55.0000	\$550.00
	ADDITIONAL GUARDRAIL POSTS				
0063	3210000000-N	1.000 EA		\$950.0000	\$950.00
	GUARDRAIL END UNITS, TYPE CAT-1				
0064	3215000000-N	1.000 EA		\$2,450.0000	\$2,450.00
	GUARDRAIL ANCHOR UNITS, TYPE III				
0065	3287000000-N	2.000 EA		\$3,600.0000	\$7,200.00
	GUARDRAIL END UNITS, TYPE TL-3				
0066	3575000000-E	130.000 LF		\$225.0000	\$29,250.00
	GENERIC FENCING ITEM PEDESTRIAN SAFETY RAIL				
0067	3628000000-E	50.000 TON		\$80.0000	\$4,000.00
	RIP RAP, CLASS I				
0068	3649000000-E	310.000 TON		\$75.0000	\$23,250.00
	RIP RAP, CLASS B				
0069	3656000000-E	1220.000 SY		\$3.0000	\$3,660.00
	GEOTEXTILE FOR DRAINAGE				
0070	4072000000-E	479.000 LF		\$11.7000	\$5,604.30
	SUPPORTS, 3-LB STEEL U-CHANNEL				
0071	4096000000-N	2.000 EA		\$150.0000	\$300.00
	SIGN ERECTION, TYPE D				
0072	4102000000-N	22.000 EA		\$150.0000	\$3,300.00
	SIGN ERECTION, TYPE E				

0073	4108000000-N	28.000	EA	\$150.0000	\$4,200.00
	SIGN ERECTION, TYPE F				
0074	4155000000-N	21.000	EA	\$5.0000	\$105.00
	DISPOSAL OF SIGN SYSTEM, U-CHANNEL				
0075	4400000000-E	216.000	SF	\$16.0000	\$3,456.00
	WORK ZONE SIGNS (STATIONARY)				
0076	4405000000-E	384.000	SF	\$20.0000	\$7,680.00
	WORK ZONE SIGNS (PORTABLE)				
0077	4410000000-E	59.000	SF	\$9.0000	\$531.00
	WORK ZONE SIGNS (BARRICADE MOUNTED)				
0078	4415000000-N	2.000	EA	\$3,000.0000	\$6,000.00
	FLASHING ARROW BOARD				
0079	4420000000-N	2.000	EA	\$8,500.0000	\$17,000.00
	PORTABLE CHANGEABLE MESSAGE SIGN				
0080	4430000000-N	350.000	EA	\$50.0000	\$17,500.00
	DRUMS				
0081	4445000000-E	104.000	LF	\$28.0000	\$2,912.00
	BARRICADES (TYPE III)				
0082	4447000000-E	8.000	LF	\$110.0000	\$880.00
	PEDESTRIAN CHANNELIZING DEVICES				
0083	4455000000-N	330.000	DAY	\$650.0000	\$214,500.00
	FLAGGER				
0084	4480000000-N	2.000	EA	\$2,500.0000	\$5,000.00
	TMA				
0085	4520000000-N	6.000	EA	\$85.0000	\$510.00
	TUBULAR MARKERS (FIXED)				
0086	4650000000-N	145.000	EA	\$10.0000	\$1,450.00
	TEMPORARY RAISED PAVEMENT MARKERS				
0087	4685000000-E	19446.000	LF	\$1.5000	\$29,169.00
	THERMOPLASTIC PAVEMENT MARKING LINES (4", 90 MILS)				
0088	4695000000-E	1018.000	LF	\$2.5000	\$2,545.00
	THERMOPLASTIC PAVEMENT MARKING LINES (8", 90 MILS)				
0089	4709000000-E	281.000	LF	\$12.0000	\$3,372.00
	THERMOPLASTIC PAVEMENT MARKING LINES (24", 90 MILS)				
0090	4720000000-E	8.000	EA	\$125.0000	\$1,000.00
	THERMOPLASTIC PAVEMENT MARKING CHARACTER (90 MILS)				
0091	4725000000-E	51.000	EA	\$150.0000	\$7,650.00
	THERMOPLASTIC PAVEMENT MARKING SYMBOL (90 MILS)				
0092	4810000000-E	22090.000	LF	\$0.6000	\$13,254.00
	PAINT PAVEMENT MARKING LINES (4")				
0093	4815000000-E	118.000	LF	\$0.7500	\$88.50
	PAINT PAVEMENT MARKING LINES (6")				
0094	4820000000-E	930.000	LF	\$0.7500	\$697.50
	PAINT PAVEMENT MARKING LINES (8")				
0095	4835000000-E	300.000	LF	\$3.0000	\$900.00
	PAINT PAVEMENT MARKING LINES (24")				
0096	4840000000-N	8.000	EA	\$25.0000	\$200.00
	PAINT PAVEMENT MARKING CHARACTER				
0097	4845000000-N	38.000	EA	\$25.0000	\$950.00

PAINT PAVEMENT MARKING SYMBOL

0098	4850000000-E	8059.000	LF	\$0.7500	\$6,044.25
	REMOVAL OF PAVEMENT MARKING LINES (4")				
0099	4860000000-E	36.000	LF	\$5.0000	\$180.00
	REMOVAL OF PAVEMENT MARKING LINES (8")				
0100	4870000000-E	39.000	LF	\$10.0000	\$390.00
	REMOVAL OF PAVEMENT MARKING LINES (24")				
0101	4875000000-N	4.000	EA	\$50.0000	\$200.00
	REMOVAL OF PAVEMENT MARKING SYMBOLS & CHARACTERS				
0102	4900000000-N	120.000	EA	\$10.0000	\$1,200.00
	PERMANENT RAISED PAVEMENT MARKERS				
0103	5255000000-N	1.000	LS	\$50,000.0000	\$50,000.00
	PORTABLE LIGHTING				
0104	5325200000-E	30.000	LF	\$85.0000	\$2,550.00
	2" WATER LINE				
0105	5325600000-E	308.000	LF	\$205.0000	\$63,140.00
	6" WATER LINE				
0106	5325800000-E	1472.000	LF	\$150.0000	\$220,800.00
	8" WATER LINE				
0107	5326200000-E	1783.000	LF	\$165.0000	\$294,195.00
	12" WATER LINE				
0108	5329000000-E	7285.000	LB	\$17.5000	\$127,487.50
	DUCTILE IRON WATER PIPE FITTINGS				
0109	5536000000-E	1.000	EA	\$2,040.0000	\$2,040.00
	2" VALVE				
0110	5540000000-E	7.000	EA	\$3,200.0000	\$22,400.00
	6" VALVE				
0111	5546000000-E	9.000	EA	\$4,000.0000	\$36,000.00
	8" VALVE				
0112	5558000000-E	5.000	EA	\$6,300.0000	\$31,500.00
	12" VALVE				
0113	5571800000-E	1.000	EA	\$14,800.0000	\$14,800.00
	8" TAPPING SLEEVE & VALVE				
0114	5606000000-E	1.000	EA	\$4,400.0000	\$4,400.00
	2" BLOW OFF				
0115	5648000000-N	5.000	EA	\$2,010.0000	\$10,050.00
	RELOCATE WATER METER				
0116	5666000000-N	1.000	EA	\$7,600.0000	\$7,600.00
	FIRE HYDRANT				
0117	5672000000-N	2.000	EA	\$5,400.0000	\$10,800.00
	RELOCATE FIRE HYDRANT				
0118	5673000000-E	20.000	LF	\$145.0000	\$2,900.00
	FIRE HYDRANT LEG				
0119	5686500000-E	20.000	LF	\$110.0000	\$2,200.00
	WATER SERVICE LINE				
0120	5691300000-E	435.000	LF	\$290.0000	\$126,150.00
	8" SANITARY GRAVITY SEWER				
0121	5691500000-E	368.000	LF	\$320.0000	\$117,760.00
	12" SANITARY GRAVITY SEWER				

0122	5709200000-E	230.000	LF	\$295.0000	\$67,850.00
	4" FORCE MAIN SEWER				
0123	5776000000-E	3.000	EA	\$8,400.0000	\$25,200.00
	5' DIA UTILITY MANHOLE				
0124	5782000000-E	28.000	LF	\$1,200.0000	\$33,600.00
	UTILITY MANHOLE WALL 5' DIA				
0125	5798000000-E	175.000	LF	\$18.0000	\$3,150.00
	ABANDON *** UTILITY PIPE (2")				
0126	5798000000-E	219.000	LF	\$22.0000	\$4,818.00
	ABANDON *** UTILITY PIPE (4")				
0127	5800000000-E	523.000	LF	\$23.0000	\$12,029.00
	ABANDON 6" UTILITY PIPE				
0128	5801000000-E	1590.000	LF	\$24.0000	\$38,160.00
	ABANDON 8" UTILITY PIPE				
0129	5804000000-E	345.000	LF	\$33.0000	\$11,385.00
	ABANDON 12" UTILITY PIPE				
0130	5815000000-N	1.000	EA	\$2,200.0000	\$2,200.00
	REMOVE WATER METER				
0131	5816000000-N	1.000	EA	\$4,300.0000	\$4,300.00
	ABANDON UTILITY MANHOLE				
0132	5828000000-N	1.000	EA	\$4,300.0000	\$4,300.00
	REMOVE UTILITY MANHOLE				
0133	5835600000-E	105.000	LF	\$230.0000	\$24,150.00
	12" ENCASEMENT PIPE				
0134	5835900000-E	124.000	LF	\$260.0000	\$32,240.00
	20" ENCASEMENT PIPE				
0135	5836000000-E	91.000	LF	\$320.0000	\$29,120.00
	24" ENCASEMENT PIPE				
0136	5872500000-E	84.000	LF	\$400.0000	\$33,600.00
	BORE AND JACK OF *** (20")				
0137	6000000000-E	5800.000	LF	\$3.7500	\$21,750.00
	TEMPORARY SILT FENCE				
0138	6006000000-E	300.000	TON	\$70.0000	\$21,000.00
	STONE FOR EROSION CONTROL, CLASS A				
0139	6009000000-E	650.000	TON	\$45.0000	\$29,250.00
	STONE FOR EROSION CONTROL, CLASS B				
0140	6012000000-E	440.000	TON	\$40.0000	\$17,600.00
	SEDIMENT CONTROL STONE				
0141	6015000000-E	15.500	ACR	\$650.0000	\$10,075.00
	TEMPORARY MULCHING				
0142	6018000000-E	1000.000	LB	\$5.5000	\$5,500.00
	SEED FOR TEMPORARY SEEDING				
0143	6021000000-E	6.000	TON	\$1,100.0000	\$6,600.00
	FERTILIZER FOR TEMPORARY SEEDING				
0144	6024000000-E	200.000	LF	\$20.0000	\$4,000.00
	TEMPORARY SLOPE DRAINS				
0145	6029000000-E	450.000	LF	\$3.0000	\$1,350.00
	SAFETY FENCE				
0146	6030000000-E	2450.000	CY	\$5.0000	\$12,250.00



SILT EXCAVATION

0147	6036000000-E	7550.000	SY	\$1.9000	\$14,345.00
	MATTING FOR EROSION CONTROL				
0148	6037000000-E	100.000	SY	\$8.0000	\$800.00
	COIR FIBER MAT				
0149	6042000000-E	1200.000	LF	\$6.0000	\$7,200.00
	1/4" HARDWARE CLOTH				
0150	6043000000-E	100.000	SY	\$20.0000	\$2,000.00
	LOW PERMEABILITY GEOTEXTILE				
0151	6070000000-N	2.000	EA	\$500.0000	\$1,000.00
	SPECIAL STILLING BASINS				
0152	6071010000-E	800.000	LF	\$12.0000	\$9,600.00
	WATTLE				
0153	6071020000-E	325.000	LB	\$12.0000	\$3,900.00
	POLYACRYLAMIDE (PAM)				
0154	6071030000-E	750.000	LF	\$8.0000	\$6,000.00
	COIR FIBER BAFFLE				
0155	6071050000-E	2.000	EA	\$2,000.0000	\$4,000.00
	**" SKIMMER (1-1/2")				
0156	6071050000-E	2.000	EA	\$2,500.0000	\$5,000.00
	**" SKIMMER (2")				
0157	6084000000-E	15.000	ACR	\$1,250.0000	\$18,750.00
	SEEDING & MULCHING				
0158	6087000000-E	9.000	ACR	\$100.0000	\$900.00
	MOWING				
0159	6090000000-E	200.000	LB	\$8.5000	\$1,700.00
	SEED FOR REPAIR SEEDING				
0160	6093000000-E	0.500	TON	\$2,000.0000	\$1,000.00
	FERTILIZER FOR REPAIR SEEDING				
0161	6096000000-E	375.000	LB	\$4.5000	\$1,687.50
	SEED FOR SUPPLEMENTAL SEEDING				
0162	6108000000-E	11.250	TON	\$500.0000	\$5,625.00
	FERTILIZER TOPDRESSING				
0163	6111000000-E	100.000	LF	\$100.0000	\$10,000.00
	IMPERVIOUS DIKE				
0164	6114500000-N	10.000	MHR	\$150.0000	\$1,500.00
	SPECIALIZED HAND MOWING				
0165	6117000000-N	25.000	EA	\$225.0000	\$5,625.00
	RESPONSE FOR EROSION CONTROL				
0166	6117500000-N	4.000	EA	\$1,500.0000	\$6,000.00
	CONCRETE WASHOUT STRUCTURE				
0167	6123000000-E	0.100	ACR	\$10,000.0000	\$1,000.00
	REFORESTATION				
0168	7060000000-E	3360.000	LF	\$2.6000	\$8,736.00
	SIGNAL CABLE				
0169	7120000000-E	29.000	EA	\$940.0000	\$27,260.00
	VEHICLE SIGNAL HEAD (12", 3 SECTION)				
0170	7132000000-E	2.000	EA	\$1,101.0000	\$2,202.00
	VEHICLE SIGNAL HEAD (12", 4 SECTION)				

0171	7204000000-N LOUVER	1.000 EA	\$376.0000	\$376.00
0172	7264000000-E MESSENGER CABLE (3/8")	1180.000 LF	\$2.3000	\$2,714.00
0173	7279000000-E TRACER WIRE	4480.000 LF	\$1.3000	\$5,824.00
0174	7300000000-E UNPAVED TRENCHING (***** (1, 2"))	1370.000 LF	\$10.4000	\$14,248.00
0175	7300000000-E UNPAVED TRENCHING (***** (2, 2"))	3000.000 LF	\$14.9000	\$44,700.00
0176	7301000000-E DIRECTIONAL DRILL (***** (1, 2"))	260.000 LF	\$18.2000	\$4,732.00
0177	7301000000-E DIRECTIONAL DRILL (***** (2, 2"))	1480.000 LF	\$20.8000	\$30,784.00
0178	7324000000-N JUNCTION BOX (STANDARD SIZE)	19.000 EA	\$365.0000	\$6,935.00
0179	7348000000-N JUNCTION BOX (OVER-SIZED, HEAVY DUTY)	11.000 EA	\$828.0000	\$9,108.00
0180	7360000000-N WOOD POLE	10.000 EA	\$863.0000	\$8,630.00
0181	7372000000-N GUY ASSEMBLY	19.000 EA	\$415.0000	\$7,885.00
0182	7408000000-E 1" RISER WITH WEATHERHEAD	2.000 EA	\$461.0000	\$922.00
0183	7420000000-E 2" RISER WITH WEATHERHEAD	11.000 EA	\$751.0000	\$8,261.00
0184	7444000000-E INDUCTIVE LOOP SAWCUT	2560.000 LF	\$7.4000	\$18,944.00
0185	7456000000-E LEAD-IN CABLE (***** (14-2)	6670.000 LF	\$1.8000	\$12,006.00
0186	7516000000-E COMMUNICATIONS CABLE (** FIBER) (24)	5030.000 LF	\$3.2000	\$16,096.00
0187	7528000000-E DROP CABLE	400.000 LF	\$3.2000	\$1,280.00
0188	7540000000-N SPLICE ENCLOSURE	3.000 EA	\$2,205.0000	\$6,615.00
0189	7552000000-N INTERCONNECT CENTER	3.000 EA	\$2,244.0000	\$6,732.00
0190	7566000000-N DELINEATOR MARKER	11.000 EA	\$150.0000	\$1,650.00
0191	7575142060-N MODIFY RADIO INSTALLATION	1.000 EA	\$1,663.0000	\$1,663.00
0192	7684000000-N SIGNAL CABINET FOUNDATION	3.000 EA	\$817.0000	\$2,451.00
0193	7744000000-N DETECTOR CARD (TYPE 170)	19.000 EA	\$220.0000	\$4,180.00
0194	7756000000-N CONTROLLER WITH CABINET (TYPE 2070L, BASE MOUNTED)	3.000 EA	\$17,425.0000	\$52,275.00
0195	7901000000-N	3.000 EA	\$392.0000	\$1,176.00

CABINET BASE EXTENDER

---

0196	7980000000-N	3.000 EA	\$4,716.0000	\$14,148.00
	GENERIC SIGNAL ITEM ETHERNET EDGE SWITCH			

---

Section 0001 Total \$9,191,699.45

---

Section 0003  
WALL ITEMS

---

0197	8801000000-E	760.000 SF	\$90.0000	\$68,400.00
	MSE RETAINING WALL NO **** (1)			

---

---

0198	8847000000-E	12324.000 SF	\$5.0000	\$61,620.00
	GENERIC RETAINING WALL ITEM ARCHITECTURAL SURFACE TREATMENT (SOUND BARRIER WALL)			

---

---

0199	8847000000-E	7650.000 SF	\$55.0000	\$420,750.00
	GENERIC RETAINING WALL ITEM SOUND BARRIER WALL			

---

Section 0003 Total \$550,770.00

---

---

Item Total \$9,742,469.45

---

**ELECTRONIC BID SUBMISSION**

By submitting this bid electronically, I hereby acknowledge that all requirements included in the hard copy proposal, addendum, amendments, plans, standard specifications, supplemental specifications and special provisions are part of the bid and contract. Further, I acknowledge that I have read, understand, accept, acknowledge and agree to comply with all statements in this electronic bid.

=====

**NON-COLLUSION, DEBARMENT AND GIFT BAN CERTIFICATION**

The prequalified bidder declares (or certifies, verifies, or states) under penalty of perjury under the laws of the United States that neither he, nor any official, agent or employee has entered into any agreement, participated in any collusion, or otherwise taken any action which is in restraint of free competitive bidding in connection with any bid or contract, that the prequalified bidder has not been convicted of violating N.C.G.S. §133-24 within the last three years, and that the prequalified bidder intends to do the work with his own bonafide employees or subcontractors and will not bid for the benefit of another contractor.

By submitting this non-collusion, debarment and gift ban certification, the Contractor is attesting his status under penalty of perjury under the laws of the United States in accordance with the Debarment Certification attached, provided that the Debarment Certification also includes any required statements concerning exceptions that are applicable.

N.C.G.S. §133-32 and Executive Order 24 prohibit the offer to, or acceptance by, any State Employee of any gift from anyone with a contract with the State, or from any person seeking to do business with the State. By execution of any response in this procurement, you attest, for your entire organization and its employees or agents, that you are not aware that any such gift has been offered, accepted, or promised by any employees of your organization.

**DEBARMENT CERTIFICATION OF PREQUALIFIED BIDDER**

Conditions for certification:

1. The prequalified bidder shall provide immediate written notice to the Department if at any time the bidder learns that his certification was erroneous when he submitted his debarment certification or explanation that is file with the Department, or has become erroneous because of changed circumstances.
2. The terms covered transaction, debarred, suspended, ineligible, lower tier

covered transaction, participant, person, primary covered transaction, principal, proposal, and voluntarily excluded, as used in this provision, have the meanings set out in the Definitions and Coverage sections of the rules implementing Executive Order 12549. A copy of the Federal Rules requiring this certification and detailing the definitions and coverages may be obtained from the Contract Officer of the Department.

3. The prequalified bidder agrees by submitting this form, that he will not knowingly enter into any lower tier covered transaction with a person who is debarred, suspended, declared ineligible, or voluntarily excluded from participation in NCDOT contracts, unless authorized by the Department.

4. For Federal Aid projects, the prequalified bidder further agrees that by submitting this form he will include the Federal- Aid Provision titled Required Contract Provisions Federal-Aid Construction Contract (Form FHWA PR 1273) provided by the Department, without subsequent modification, in all lower tier covered transactions.

5. The prequalified bidder may rely upon a certification of a participant in a lower tier covered transaction that he is not debarred, suspended, ineligible, or voluntarily excluded from the covered transaction, unless he knows that the certification is erroneous. The bidder may decide the method and frequency by which he will determine the eligibility of his subcontractors.

6. Nothing contained in the foregoing shall be construed to require establishment of a system of records in order to render in good faith the certification required by this provision. The knowledge and information of a participant is not required to exceed that which is normally possessed by a prudent person in the ordinary course of business dealings.

7. Except as authorized in paragraph 6 herein, the Department may terminate any contract if the bidder knowingly enters into a lower tier covered transaction with a person who is suspended, debarred, ineligible, or voluntarily excluded from participation in this transaction, in addition to other remedies available by the Federal Government.

### **DEBARMENT CERTIFICATION**

The prequalified bidder certifies to the best of his knowledge and belief, that he and his principals:

a. Are not presently debarred, suspended, proposed for debarment, declared ineligible, or voluntarily excluded from covered transactions by any Federal department or agency;

b. Have not within a three-year period preceding this proposal been convicted of or had a civil judgment rendered against them for commission of fraud or a criminal offense in connection with obtaining, attempting to obtain, or performing a public (Federal, State or local) transaction or contract under a public transaction; violation of Federal or State antitrust statutes or

commission of embezzlement, theft, forgery, bribery, falsification or destruction of records; making false statements; or receiving stolen property;

c. Are not presently indicted for or otherwise criminally or civilly charged by a governmental entity (Federal, State or local) with commission of any of the offenses enumerated in paragraph b. of this certification; and

d. Have not within a three-year period preceding this proposal had one or more public transactions (Federal, State or local) terminated for cause or default.

e. Will submit a revised Debarment Certification immediately if his status changes and will show in his bid proposal an explanation for the change in status.

If the prequalified bidder cannot certify that he is not debarred, he shall provide an explanation with this submittal. An explanation will not necessarily result in denial of participation in a contract.

Failure to submit a non-collusion and debarment certification will result in the prequalified bidder's bid being considered non-responsive.

**EXPLANATION:**

=====

### Award Limits on Multiple Projects

By answering YES to this statement, the bidder acknowledges that they are using the award limits on multiple projects? **Yes**  **No**

A bidder who desires to bid on more than one project on which bids are to be opened on the same date, and who also desires to avoid receiving an award of more projects than he is equipped to handle, may bid on any number of projects but may limit the total amount of work awarded to him on selected projects by completing the AWARD LIMITS ON MULTIPLE PROJECTS.

The Award Limits on Multiple Projects must be filled in on each project bid for which the Bidder desires protection.

It is the desire of the Bidder to be awarded contracts, the value of which will not exceed a total of     for those

projects indicated herein, for which bids will be opened on     (MM/DD/YY)

The Award Limits shall apply to the following projects:

Contract Number  
County

Contract Number  
County

Contract Number  
County

Contract Number  
County

Contract Number  
County

Contract Number  
County

It is agreed that if I am (we are) the low Bidder(s) on indicated projects, the total value of which is more than the above stipulated award limits, the Board of Transportation will award me (us) projects from among those indicated

that have a total value not to exceed the award limit and will result in the lowest total bids to the Department of Transportation.



## DBE List Summary

Project: 1560005

Bidder ID: 5072

Bid Total: 9,742,469.45

Business Name: FSC II LLC dba Fred Smith  
Company

Goal: 6.00% (584,548.17)

Total Entered: 6.02% (586,666.41)

<b>ID</b>	<b>Name</b>	<b>Is Supplier?</b>	<b>Item Count</b>	<b>Amount</b>	<b>Is Complete?</b>
12536	ARBOREX TREE SERVICES LLC	False	2	53,000.00	True
11816	MARTINEZ COMPANY INC	False	2	174,557.16	True
4247	SEAL BROTHERS CONTRACTING LLC	False	9	249,309.25	True
7294	STRATCON CONTRACTING CORP	False	1	109,800.00	True

Name: ARBOREX TREE SERVICES LLC ID: 12536

Address: 4605 WINDY KNOLL ROAD RALEIGH, NC 27616

Used As: SubContractor DBE Items Total:\$53,000.00

**Items for ARBOREX TREE SERVICES LLC**

---

0001	ROADWAY ITEMS				
0001	0000100000-N MOBILIZATION	1.000	LS	\$8,000.0000	\$8,000.00
0003	0001000000-E CLEARING & GRUBBING .. ACRE(S)	1.000	LS	\$45,000.0000	\$45,000.00
Section 0001 Total					\$53,000.00
Item Total					\$53,000.00

---

Name: MARTINEZ COMPANY INC ID: 11816

Address: 813 E. PARKER STREET GRAHAM, NC 27253

Used As: SubContractor DBE Items Total:\$174,557.16

**Items for MARTINEZ COMPANY INC**

---

0001	ROADWAY ITEMS			
0058	2724000000-E	547.590 LF	\$24.0000	\$13,142.16
	PRECAST REINFORCED CONCRETE BARRIER, SINGLE FACED			
Section 0001 Total				\$13,142.16
<hr/>				
0003	WALL ITEMS			
0199	8847000000-E	7650.000 SF	\$21.1000	\$161,415.00
	GENERIC RETAINING WALL ITEM SOUND BARRIER WALL			
Section 0003 Total				\$161,415.00
<hr/>				
Item Total				\$174,557.16

---

Name: SEAL BROTHERS CONTRACTING LLC ID: 4247

Address: 3618 WEST PINE ST MOUNT AIRY, NC 27030

Used As: SubContractor DBE Items Total:\$249,309.25

**Items for SEAL BROTHERS CONTRACTING LLC**

0001 ROADWAY ITEMS					
0001	0000100000-N	1.000	LS	\$2,500.0000	\$2,500.00
	MOBILIZATION				
0034	2022000000-E	958.000	CY	\$42.0000	\$40,236.00
	SUBDRAIN EXCAVATION				
0035	2026000000-E	4275.000	SY	\$12.0000	\$51,300.00
	GEOTEXTILE FOR SUBSURFACE DRAINS				
0036	2036000000-E	719.000	CY	\$75.0000	\$53,925.00
	SUBDRAIN COARSE AGGREGATE				
0037	2044000000-E	4275.000	LF	\$16.7500	\$71,606.25
	6" PERFORATED SUBDRAIN PIPE				
0038	2070000000-N	9.000	EA	\$450.0000	\$4,050.00
	SUBDRAIN PIPE OUTLET				
0039	2077000000-E	54.000	LF	\$48.0000	\$2,592.00
	6" OUTLET PIPE				
0137	6000000000-E	5800.000	LF	\$3.7500	\$21,750.00
	TEMPORARY SILT FENCE				
0145	6029000000-E	450.000	LF	\$3.0000	\$1,350.00
	SAFETY FENCE				
Section 0001 Total					\$249,309.25
Item Total					\$249,309.25

Name: STRATCON CONTRACTING CORP ID: 7294

Address: P.O. Box 14189 RALEIGH, NC 27620

Used As: SubContractor DBE Items Total:\$109,800.00

**Items for STRATCON CONTRACTING CORP**

---

0001				
ROADWAY ITEMS				
0008	0106000000-E	7200 CY	\$15.2500	\$109,800.00
	BORROW EXCAVATION			
Section 0001 Total				\$109,800.00
Item Total				\$109,800.00

---

THIS PROPOSAL CONTAINS THE FOLLOWING ERRORS/WARNINGS (IF ANY)

This Bid contains 0 amendment files

### Electronic Bid Submission

By submitting this bid electronically, I hereby acknowledge that all requirements included in the hard copy proposal, addendum, amendments, plans, standard specifications, supplemental specifications and special provisions are part of the bid and contract. Further, I acknowledge that I have read, understand, accept, acknowledge and agree to comply with all statements in this electronic bid.

I hereby certify that I have the authority to submit this bid.

Signature \_\_\_\_\_

Agency \_\_\_\_\_

Date \_\_\_\_\_

Signature \_\_\_\_\_

Agency \_\_\_\_\_

Date \_\_\_\_\_

Signature \_\_\_\_\_

Agency \_\_\_\_\_

Date \_\_\_\_\_

## Attachments

Failure to complete and attach the Fuel Usage Factor Adjustment Form will result in using 2.90 gallons per ton as the Fuel Usage Factor for Diesel for the asphalt items included on the form. The contractor will not be permitted to change the option after the bids are submitted.

NOTE: The maximum upload limit is 5 MB. Fuel Usage Factor Adjustment Form.pdf  
 Verify

Line #	ItemNumber	Sec #	Description	Quantity Unit	Unit Bid Price	Amount Bid
ROADWAY ITEMS						
0001	0000100000-N	800	MOBILIZATION	LUMP SUM	486,000.00	486,000.00
0002	0000400000-N	801	CONSTRUCTION SURVEYING	LUMP SUM	130,000.00	130,000.00
0003	0001000000-E	200	CLEARING & GRUBBING .. ACRE(S)	LUMP SUM LS	784,000.00	784,000.00
0004	0008000000-E	200	SUPPLEMENTARY CLEARING & GRUBBING	1 ACR	1.00	1.00
0005	0015000000-N	205	SEALING ABANDONED WELLS	3 EA	3,000.00	9,000.00
0006	0022000000-E	225	UNCLASSIFIED EXCAVATION	8,600 CY	30.00	258,000.00
0007	0036000000-E	225	UNDERCUT EXCAVATION	6,400 CY	40.00	256,000.00
0008	0106000000-E	230	BORROW EXCAVATION	17,700 CY	26.00	460,200.00
0009	0134000000-E	240	DRAINAGE DITCH EXCAVATION	30 CY	35.00	1,050.00
0010	0156000000-E	250	REMOVAL OF EXISTING ASPHALT PAVEMENT	3,800 SY	10.00	38,000.00
0011	0195000000-E	265	SELECT GRANULAR MATERIAL	6,400 CY	40.00	256,000.00
0012	0196000000-E	270	GEOTEXTILE FOR SOIL STABILIZATION	10,400 SY	3.00	31,200.00
0013	0318000000-E	300	FOUNDATION CONDITIONING MATERIAL, MINOR STRUCTURES	350 TON	55.00	19,250.00
0014	0320000000-E	300	FOUNDATION CONDITIONING GEOTEXTILE	1,080 SY	3.00	3,240.00
0015	0354000000-E	310	**** RC PIPE CULVERTS, CLASS **** (18",V)	160 LF	95.00	15,200.00
0016	0354000000-E	310	**** RC PIPE CULVERTS, CLASS **** (24",V)	84 LF	190.00	15,960.00
0017	0448000000-E	310	***** RC PIPE CULVERTS, CLASS IV (72")	192 LF	825.00	158,400.00
0018	0448200000-E	310	15" RC PIPE CULVERTS, CLASS IV	1,892 LF	85.00	160,820.00
0019	0448300000-E	310	18" RC PIPE CULVERTS, CLASS IV	568 LF	120.00	68,160.00
0020	0448400000-E	310	24" RC PIPE CULVERTS, CLASS IV	280 LF	130.00	36,400.00
0021	0448600000-E	310	36" RC PIPE CULVERTS, CLASS IV	40 LF	260.00	10,400.00
0022	0995000000-E	340	PIPE REMOVAL	828 LF	25.00	20,700.00



Line #	ItemNumber	Sec #	Description	Quantity Unit	Unit Bid Price	Amount Bid
0023	1011000000-N	500	FINE GRADING	LUMP SUM	725,000.00	725,000.00
0024	1099500000-E	505	SHALLOW UNDERCUT	1,300 CY	50.00	65,000.00
0025	1099700000-E	505	CLASS IV SUBGRADE STABILIZATION	2,650 TON	35.00	92,750.00
0026	1220000000-E	545	INCIDENTAL STONE BASE	1,000 TON	50.00	50,000.00
0027	1264000000-E	SP	DITCHING	72 LF	50.00	3,600.00
0028	1330000000-E	607	INCIDENTAL MILLING	2,700 SY	12.00	32,400.00
0029	1491000000-E	610	ASPHALT CONC BASE COURSE, TYPE B25.0C	6,100 TON	66.00	402,600.00
0030	1503000000-E	610	ASPHALT CONC INTERMEDIATE COURSE, TYPE I19.0C	5,400 TON	63.00	340,200.00
0031	1523000000-E	610	ASPHALT CONC SURFACE COURSE, TYPE S9.5C	4,900 TON	74.00	362,600.00
0032	1575000000-E	620	ASPHALT BINDER FOR PLANT MIX	825 TON	900.00	742,500.00
0033	1693000000-E	654	ASPHALT PLANT MIX, PAVEMENT REPAIR	320 TON	275.00	88,000.00
0034	2022000000-E	815	SUBDRAIN EXCAVATION	958 CY	42.00	40,236.00
0035	2026000000-E	815	GEOTEXTILE FOR SUBSURFACE DRAINS	4,275 SY	12.00	51,300.00
0036	2036000000-E	815	SUBDRAIN COARSE AGGREGATE	719 CY	75.00	53,925.00
0037	2044000000-E	815	6" PERFORATED SUBDRAIN PIPE	4,275 LF	16.75	71,606.25
0038	2070000000-N	815	SUBDRAIN PIPE OUTLET	9 EA	450.00	4,050.00
0039	2077000000-E	815	6" OUTLET PIPE	54 LF	48.00	2,592.00
0040	2220000000-E	838	REINFORCED ENDWALLS	9.4 CY	2,500.00	23,500.00
0041	2253000000-E	840	PIPE COLLARS	1 CY	2,600.00	2,600.00
0042	2264000000-E	840	PIPE PLUGS	1 CY	2,600.00	2,600.00
0043	2286000000-N	840	MASONRY DRAINAGE STRUCTURES	19 EA	3,900.00	74,100.00
0044	2297000000-E	840	MASONRY DRAINAGE STRUCTURES	7.5 CY	8,200.00	61,500.00
0045	2364000000-N	840	FRAME WITH TWO GRATES, STD 840.16	6 EA	1,100.00	6,600.00

Line #	ItemNumber	Sec #	Description	Quantity Unit	Unit Bid Price	Amount Bid
0046	2364200000-N	840	FRAME WITH TWO GRATES, STD 840.20	2 EA	1,100.00	2,200.00
0047	2365000000-N	840	FRAME WITH TWO GRATES, STD 840.22	2 EA	1,100.00	2,200.00
0048	2366000000-N	840	FRAME WITH TWO GRATES, STD 840.24	1 EA	1,100.00	1,100.00
0049	2374000000-N	840	FRAME WITH GRATE & HOOD, STD 840.03, TYPE ** (E)	2 EA	1,100.00	2,200.00
0050	2374000000-N	840	FRAME WITH GRATE & HOOD, STD 840.03, TYPE ** (F)	3 EA	1,200.00	3,600.00
0051	2374000000-N	840	FRAME WITH GRATE & HOOD, STD 840.03, TYPE ** (G)	4 EA	1,200.00	4,800.00
0052	2451000000-N	852	CONCRETE TRANSITIONAL SECTION FOR DROP INLET	5 EA	1,350.00	6,750.00
0053	2542000000-E	846	1'-6" CONCRETE CURB & GUTTER	1,550 LF	24.00	37,200.00
0054	2549000000-E	846	2'-6" CONCRETE CURB & GUTTER	1,450 LF	25.65	37,192.50
0055	2591000000-E	848	4" CONCRETE SIDEWALK	260 SY	53.10	13,806.00
0056	2605000000-N	848	CONCRETE CURB RAMPS	3 EA	1,950.00	5,850.00
0057	2612000000-E	848	6" CONCRETE DRIVEWAY	40 SY	72.00	2,880.00
0058	2724000000-E	857	PRECAST REINFORCED CONCRETE BARRIER, SINGLE FACED	547.59 LF	135.00	73,924.65
0059	2830000000-N	858	ADJUSTMENT OF MANHOLES	4 EA	450.00	1,800.00
0060	2845000000-N	858	ADJUSTMENT OF METER BOXES OR VALVE BOXES	15 EA	400.00	6,000.00
0061	3030000000-E	862	STEEL BEAM GUARDRAIL	387.5 LF	27.00	10,462.50
0062	3150000000-N	862	ADDITIONAL GUARDRAIL POSTS	10 EA	55.00	550.00
0063	3210000000-N	862	GUARDRAIL END UNITS, TYPE CAT-1	1 EA	950.00	950.00
0064	3215000000-N	SP	GUARDRAIL ANCHOR UNITS, TYPE III	1 EA	2,450.00	2,450.00
0065	3287000000-N	SP	GUARDRAIL END UNITS, TYPE TL-3	2 EA	3,600.00	7,200.00
0066	3575000000-E	SP	GENERIC FENCING ITEM PEDESTRIAN SAFETY RAIL	130 LF	225.00	29,250.00

Line #	ItemNumber	Sec #	Description	Quantity Unit	Unit Bid Price	Amount Bid
0067	3628000000-E	876	RIP RAP, CLASS I	50 TON	80.00	4,000.00
0068	3649000000-E	876	RIP RAP, CLASS B	310 TON	75.00	23,250.00
0069	3656000000-E	876	GEOTEXTILE FOR DRAINAGE	1,220 SY	3.00	3,660.00
0070	4072000000-E	903	SUPPORTS, 3-LB STEEL U-CHANNEL	479 LF	11.70	5,604.30
0071	4096000000-N	904	SIGN ERECTION, TYPE D	2 EA	150.00	300.00
0072	4102000000-N	904	SIGN ERECTION, TYPE E	22 EA	150.00	3,300.00
0073	4108000000-N	904	SIGN ERECTION, TYPE F	28 EA	150.00	4,200.00
0074	4155000000-N	907	DISPOSAL OF SIGN SYSTEM, U-CHANNEL	21 EA	5.00	105.00
0075	4400000000-E	1110	WORK ZONE SIGNS (STATIONARY)	216 SF	16.00	3,456.00
0076	4405000000-E	1110	WORK ZONE SIGNS (PORTABLE)	384 SF	20.00	7,680.00
0077	4410000000-E	1110	WORK ZONE SIGNS (BARRICADE MOUNTED)	59 SF	9.00	531.00
0078	4415000000-N	1115	FLASHING ARROW BOARD	2 EA	3,000.00	6,000.00
0079	4420000000-N	1120	PORTABLE CHANGEABLE MESSAGE SIGN	2 EA	8,500.00	17,000.00
0080	4430000000-N	1130	DRUMS	350 EA	50.00	17,500.00
0081	4445000000-E	1145	BARRICADES (TYPE III)	104 LF	28.00	2,912.00
0082	4447000000-E	SP	PEDESTRIAN CHANNELIZING DEVICES	8 LF	110.00	880.00
0083	4455000000-N	1150	FLAGGER	330 DAY	650.00	214,500.00
0084	4480000000-N	1165	TMA	2 EA	2,500.00	5,000.00
0085	4520000000-N	1266	TUBULAR MARKERS (FIXED)	6 EA	85.00	510.00
0086	4650000000-N	1251	TEMPORARY RAISED PAVEMENT MARKERS	145 EA	10.00	1,450.00
0087	4685000000-E	1205	THERMOPLASTIC PAVEMENT MARKING LINES (4", 90 MILS)	19,446 LF	1.50	29,169.00
0088	4695000000-E	1205	THERMOPLASTIC PAVEMENT MARKING LINES (8", 90 MILS)	1,018 LF	2.50	2,545.00
0089	4709000000-E	1205	THERMOPLASTIC PAVEMENT MARKING LINES (24", 90 MILS)	281 LF	12.00	3,372.00

Line #	ItemNumber	Sec #	Description	Quantity Unit	Unit Bid Price	Amount Bid
0090	4720000000-E	1205	THERMOPLASTIC PAVEMENT MARKING CHARACTER (90 MILS)	8 EA	125.00	1,000.00
0091	4725000000-E	1205	THERMOPLASTIC PAVEMENT MARKING SYMBOL (90 MILS)	51 EA	150.00	7,650.00
0092	4810000000-E	1205	PAINT PAVEMENT MARKING LINES (4")	22,090 LF	0.60	13,254.00
0093	4815000000-E	1205	PAINT PAVEMENT MARKING LINES (6")	118 LF	0.75	88.50
0094	4820000000-E	1205	PAINT PAVEMENT MARKING LINES (8")	930 LF	0.75	697.50
0095	4835000000-E	1205	PAINT PAVEMENT MARKING LINES (24")	300 LF	3.00	900.00
0096	4840000000-N	1205	PAINT PAVEMENT MARKING CHARACTER	8 EA	25.00	200.00
0097	4845000000-N	1205	PAINT PAVEMENT MARKING SYMBOL	38 EA	25.00	950.00
0098	4850000000-E	1205	REMOVAL OF PAVEMENT MARKING LINES (4")	8,059 LF	0.75	6,044.25
0099	4860000000-E	1205	REMOVAL OF PAVEMENT MARKING LINES (8")	36 LF	5.00	180.00
0100	4870000000-E	1205	REMOVAL OF PAVEMENT MARKING LINES (24")	39 LF	10.00	390.00
0101	4875000000-N	1205	REMOVAL OF PAVEMENT MARKING SYMBOLS & CHARACTERS	4 EA	50.00	200.00
0102	4900000000-N	1251	PERMANENT RAISED PAVEMENT MARKERS	120 EA	10.00	1,200.00
0103	5255000000-N	1413	PORTABLE LIGHTING	LUMP SUM	50,000.00	50,000.00
0104	5325200000-E	1510	2" WATER LINE	30 LF	85.00	2,550.00
0105	5325600000-E	1510	6" WATER LINE	308 LF	205.00	63,140.00
0106	5325800000-E	1510	8" WATER LINE	1,472 LF	150.00	220,800.00
0107	5326200000-E	1510	12" WATER LINE	1,783 LF	165.00	294,195.00
0108	5329000000-E	1510	DUCTILE IRON WATER PIPE FITTINGS	7,285 LB	17.50	127,487.50
0109	5536000000-E	1515	2" VALVE	1 EA	2,040.00	2,040.00
0110	5540000000-E	1515	6" VALVE	7 EA	3,200.00	22,400.00
0111	5546000000-E	1515	8" VALVE	9 EA	4,000.00	36,000.00
0112	5558000000-E	1515	12" VALVE	5 EA	6,300.00	31,500.00

Line #	ItemNumber	Sec #	Description	Quantity Unit	Unit Bid Price	Amount Bid
0113	5571800000-E	1515	8" TAPPING SLEEVE & VALVE	1 EA	14,800.00	14,800.00
0114	5606000000-E	1515	2" BLOW OFF	1 EA	4,400.00	4,400.00
0115	5648000000-N	1515	RELOCATE WATER METER	5 EA	2,010.00	10,050.00
0116	5666000000-N	1515	FIRE HYDRANT	1 EA	7,600.00	7,600.00
0117	5672000000-N	1515	RELOCATE FIRE HYDRANT	2 EA	5,400.00	10,800.00
0118	5673000000-E	1515	FIRE HYDRANT LEG	20 LF	145.00	2,900.00
0119	5686500000-E	1515	WATER SERVICE LINE	20 LF	110.00	2,200.00
0120	5691300000-E	1520	8" SANITARY GRAVITY SEWER	435 LF	290.00	126,150.00
0121	5691500000-E	1520	12" SANITARY GRAVITY SEWER	368 LF	320.00	117,760.00
0122	5709200000-E	1520	4" FORCE MAIN SEWER	230 LF	295.00	67,850.00
0123	5776000000-E	1525	5' DIA UTILITY MANHOLE	3 EA	8,400.00	25,200.00
0124	5782000000-E	1525	UTILITY MANHOLE WALL 5' DIA	28 LF	1,200.00	33,600.00
0125	5798000000-E	1530	ABANDON *** UTILITY PIPE (2")	175 LF	18.00	3,150.00
0126	5798000000-E	1530	ABANDON *** UTILITY PIPE (4")	219 LF	22.00	4,818.00
0127	5800000000-E	1530	ABANDON 6" UTILITY PIPE	523 LF	23.00	12,029.00
0128	5801000000-E	1530	ABANDON 8" UTILITY PIPE	1,590 LF	24.00	38,160.00
0129	5804000000-E	1530	ABANDON 12" UTILITY PIPE	345 LF	33.00	11,385.00
0130	5815000000-N	1530	REMOVE WATER METER	1 EA	2,200.00	2,200.00
0131	5816000000-N	1530	ABANDON UTILITY MANHOLE	1 EA	4,300.00	4,300.00
0132	5828000000-N	1530	REMOVE UTILITY MANHOLE	1 EA	4,300.00	4,300.00
0133	5835600000-E	1540	12" ENCASEMENT PIPE	105 LF	230.00	24,150.00
0134	5835900000-E	1540	20" ENCASEMENT PIPE	124 LF	260.00	32,240.00
0135	5836000000-E	1540	24" ENCASEMENT PIPE	91 LF	320.00	29,120.00

Line #	ItemNumber	Sec #	Description	Quantity Unit	Unit Bid Price	Amount Bid
0136	5872500000-E	1550	BORE AND JACK OF *** (20")	84 LF	400.00	33,600.00
0137	6000000000-E	1605	TEMPORARY SILT FENCE	5,800 LF	3.75	21,750.00
0138	6006000000-E	1610	STONE FOR EROSION CONTROL, CLASS A	300 TON	70.00	21,000.00
0139	6009000000-E	1610	STONE FOR EROSION CONTROL, CLASS B	650 TON	45.00	29,250.00
0140	6012000000-E	1610	SEDIMENT CONTROL STONE	440 TON	40.00	17,600.00
0141	6015000000-E	1615	TEMPORARY MULCHING	15.5 ACR	650.00	10,075.00
0142	6018000000-E	1620	SEED FOR TEMPORARY SEEDING	1,000 LB	5.50	5,500.00
0143	6021000000-E	1620	FERTILIZER FOR TEMPORARY SEEDING	6 TON	1,100.00	6,600.00
0144	6024000000-E	1622	TEMPORARY SLOPE DRAINS	200 LF	20.00	4,000.00
0145	6029000000-E	SP	SAFETY FENCE	450 LF	3.00	1,350.00
0146	6030000000-E	1630	SILT EXCAVATION	2,450 CY	5.00	12,250.00
0147	6036000000-E	1631	MATTING FOR EROSION CONTROL	7,550 SY	1.90	14,345.00
0148	6037000000-E	SP	COIR FIBER MAT	100 SY	8.00	800.00
0149	6042000000-E	1632	1/4" HARDWARE CLOTH	1,200 LF	6.00	7,200.00
0150	6043000000-E	SP	LOW PERMEABILITY GEOTEXTILE	100 SY	20.00	2,000.00
0151	6070000000-N	1639	SPECIAL STILLING BASINS	2 EA	500.00	1,000.00
0152	6071010000-E	SP	WATTLE	800 LF	12.00	9,600.00
0153	6071020000-E	SP	POLYACRYLAMIDE (PAM)	325 LB	12.00	3,900.00
0154	6071030000-E	1640	COIR FIBER BAFFLE	750 LF	8.00	6,000.00
0155	6071050000-E	SP	*** SKIMMER (1-1/2")	2 EA	2,000.00	4,000.00
0156	6071050000-E	SP	*** SKIMMER (2")	2 EA	2,500.00	5,000.00
0157	6084000000-E	1660	SEEDING & MULCHING	15 ACR	1,250.00	18,750.00
0158	6087000000-E	1660	MOWING	9 ACR	100.00	900.00

Line #	ItemNumber	Sec #	Description	Quantity Unit	Unit Bid Price	Amount Bid
0159	6090000000-E	1661	SEED FOR REPAIR SEEDING	200 LB	8.50	1,700.00
0160	6093000000-E	1661	FERTILIZER FOR REPAIR SEEDING	0.5 TON	2,000.00	1,000.00
0161	6096000000-E	1662	SEED FOR SUPPLEMENTAL SEEDING	375 LB	4.50	1,687.50
0162	6108000000-E	1665	FERTILIZER TOPDRESSING	11.25 TON	500.00	5,625.00
0163	6111000000-E	SP	IMPERVIOUS DIKE	100 LF	100.00	10,000.00
0164	6114500000-N	1667	SPECIALIZED HAND MOWING	10 MHR	150.00	1,500.00
0165	6117000000-N	SP	RESPONSE FOR EROSION CONTROL	25 EA	225.00	5,625.00
0166	6117500000-N	SP	CONCRETE WASHOUT STRUCTURE	4 EA	1,500.00	6,000.00
0167	6123000000-E	1670	REFORESTATION	0.1 ACR	10,000.00	1,000.00
0168	7060000000-E	1705	SIGNAL CABLE	3,360 LF	2.60	8,736.00
0169	7120000000-E	1705	VEHICLE SIGNAL HEAD (12", 3 SECTION)	29 EA	940.00	27,260.00
0170	7132000000-E	1705	VEHICLE SIGNAL HEAD (12", 4 SECTION)	2 EA	1,101.00	2,202.00
0171	7204000000-N	1705	LOUVER	1 EA	376.00	376.00
0172	7264000000-E	1710	MESSENGER CABLE (3/8")	1,180 LF	2.30	2,714.00
0173	7279000000-E	1715	TRACER WIRE	4,480 LF	1.30	5,824.00
0174	7300000000-E	1715	UNPAVED TRENCHING (*****) (1, 2")	1,370 LF	10.40	14,248.00
0175	7300000000-E	1715	UNPAVED TRENCHING (*****) (2, 2")	3,000 LF	14.90	44,700.00
0176	7301000000-E	1715	DIRECTIONAL DRILL (*****) (1, 2")	260 LF	18.20	4,732.00
0177	7301000000-E	1715	DIRECTIONAL DRILL (*****) (2, 2")	1,480 LF	20.80	30,784.00
0178	7324000000-N	1716	JUNCTION BOX (STANDARD SIZE)	19 EA	365.00	6,935.00
0179	7348000000-N	1716	JUNCTION BOX (OVER-SIZED, HEAVY DUTY)	11 EA	828.00	9,108.00
0180	7360000000-N	1720	WOOD POLE	10 EA	863.00	8,630.00
0181	7372000000-N	1721	GUY ASSEMBLY	19 EA	415.00	7,885.00

Line #	ItemNumber	Sec #	Description	Quantity Unit	Unit Bid Price	Amount Bid
0182	7408000000-E	1722	1" RISER WITH WEATHERHEAD	2 EA	461.00	922.00
0183	7420000000-E	1722	2" RISER WITH WEATHERHEAD	11 EA	751.00	8,261.00
0184	7444000000-E	1725	INDUCTIVE LOOP SAWCUT	2,560 LF	7.40	18,944.00
0185	7456000000-E	1726	LEAD-IN CABLE (***** (14-2)	6,670 LF	1.80	12,006.00
0186	7516000000-E	1730	COMMUNICATIONS CABLE (** FIBER) (24)	5,030 LF	3.20	16,096.00
0187	7528000000-E	1730	DROP CABLE	400 LF	3.20	1,280.00
0188	7540000000-N	1731	SPLICE ENCLOSURE	3 EA	2,205.00	6,615.00
0189	7552000000-N	1731	INTERCONNECT CENTER	3 EA	2,244.00	6,732.00
0190	7566000000-N	1733	DELINEATOR MARKER	11 EA	150.00	1,650.00
0191	7575142060-N	SP	MODIFY RADIO INSTALLATION	1 EA	1,663.00	1,663.00
0192	7684000000-N	1750	SIGNAL CABINET FOUNDATION	3 EA	817.00	2,451.00
0193	7744000000-N	1751	DETECTOR CARD (TYPE 170)	19 EA	220.00	4,180.00
0194	7756000000-N	1751	CONTROLLER WITH CABINET (TYPE 2070L, BASE MOUNTED)	3 EA	17,425.00	52,275.00
0195	7901000000-N	1753	CABINET BASE EXTENDER	3 EA	392.00	1,176.00
0196	7980000000-N	SP	GENERIC SIGNAL ITEM ETHERNET EDGE SWITCH	3 EA	4,716.00	14,148.00



Contract Item Sheets For C204729

Line #	ItemNumber	Sec #	Description	Quantity Unit	Unit Bid Price	Amount Bid
WALL ITEMS						
0197	8801000000-E	SP	MSE RETAINING WALL NO **** (1)	760 SF	90.00	68,400.00
0198	8847000000-E	SP	GENERIC RETAINING WALL ITEM ARCHITECTURAL SURFACE TREATMENT (SOUND BARRIER WALL)	12,324 SF	5.00	61,620.00
0199	8847000000-E	SP	GENERIC RETAINING WALL ITEM SOUND BARRIER WALL	7,650 SF	55.00	420,750.00
TOTAL AMOUNT OF BID FOR ENTIRE PROJECT						\$9,742,469.45

## Fuel Usage Factor Adjustment Form

Contract Number	C204729
County	Johnston County
Contractor Name	FSC II, LLC dba Fred Smith Company
HiCAMS Vendor Number	5072

Select a Fuel Usage Factor for each of the Asphalt Material Descriptions to be used on the project. Within the Selected Fuel Usage Factor column, choose either 2.90 or 0.90 Gallons per Ton for the corresponding asphalt material description.

The Selected Fuel Usage Factor chosen will be used for the entire contract duration.

Description	Unit	Selected Fuel Usage Factor	
		0.90	2.90
Asphalt Concrete Base Course, Type B25.0C	Gal/Ton	<input checked="" type="checkbox"/>	<input type="checkbox"/>
Asphalt Concrete Intermediate Course, Type I19.0C	Gal/Ton	<input checked="" type="checkbox"/>	<input type="checkbox"/>
Asphalt Concrete Surface Course, Type SA-1	Gal/Ton	<input checked="" type="checkbox"/>	<input type="checkbox"/>
Asphalt Concrete Surface Course, Type SA-1 (Leveling Course)	Gal/Ton	<input checked="" type="checkbox"/>	<input type="checkbox"/>
Asphalt Concrete Surface Course, Type S4.75	Gal/Ton	<input checked="" type="checkbox"/>	<input type="checkbox"/>
Asphalt Concrete Surface Course, Type S4.75 (Leveling Course)	Gal/Ton	<input checked="" type="checkbox"/>	<input type="checkbox"/>
Asphalt Concrete Surface Course, Type S9.5B	Gal/Ton	<input checked="" type="checkbox"/>	<input type="checkbox"/>
Asphalt Concrete Surface Course, Type S9.5B (Leveling Course)	Gal/Ton	<input checked="" type="checkbox"/>	<input type="checkbox"/>
Asphalt Concrete Surface Course, Type S9.5C	Gal/Ton	<input checked="" type="checkbox"/>	<input type="checkbox"/>
Asphalt Concrete Surface Course, Type S9.5C (Leveling Course)	Gal/Ton	<input checked="" type="checkbox"/>	<input type="checkbox"/>
Asphalt Concrete Surface Course, Type S9.5D	Gal/Ton	<input checked="" type="checkbox"/>	<input type="checkbox"/>
Asphalt Concrete Surface Course, Type S9.5D (Leveling Course)	Gal/Ton	<input checked="" type="checkbox"/>	<input type="checkbox"/>
Open-Graded Asphalt Friction Course	Gal/Ton	<input checked="" type="checkbox"/>	<input type="checkbox"/>
Permeable Asphalt Drainage Course, Type _____	Gal/Ton	<input checked="" type="checkbox"/>	<input type="checkbox"/>
Sand Asphalt Surface Course, Type _____	Gal/Ton	<input checked="" type="checkbox"/>	<input type="checkbox"/>

If the Contractor does not mark either Fuel Usage Factor or marks both Fuel Usage Factors for an asphalt item description, the 2.90 Fuel Usage Factor shall be used for that asphalt line item.



Contract No. C204729  
County Johnston

Rev. 1-16-18

**EXECUTION OF CONTRACT  
NON-COLLUSION, DEBARMENT AND GIFT BAN CERTIFICATION**

**LIMITED LIABILITY COMPANY**

The Contractor declares (or certifies, verifies, or states) under penalty of perjury under the laws of the United States that neither he, nor any official, agent or employee has entered into any agreement, participated in any collusion, or otherwise taken any action which is in restraint of free competitive bidding in connection with this Contract, that the Contractor has not been convicted of violating *N.C.G.S. § 133-24* within the last three years, and that the Contractor intends to do the work with its own bonafide employees or subcontractors and did not bid for the benefit of another contractor.

By submitting this Execution of Contract, Non-Collusion and Debarment Certification, the Contractor is certifying his status under penalty of perjury under the laws of the United States in accordance with the Debarment Certification attached, provided that the Debarment Certification also includes any required statements concerning exceptions that are applicable.

*N.C.G.S. § 133-32* and Executive Order 24 prohibit the offer to, or acceptance by, any State Employee of any gift from anyone with a contract with the State, or from any person seeking to do business with the State. By execution of any response in this procurement, you attest, for your entire organization and its employees or agents, that you are not aware that any such gift has been offered, accepted, or promised by any employees of your organization.

**SIGNATURE OF CONTRACTOR**

FSC II, LLC dba Fred Smith Company

Full Name of Firm

701 Corporate Center Drive, Suite 101, Raleigh, NC 27607

Address as Prequalified



Signature of Witness

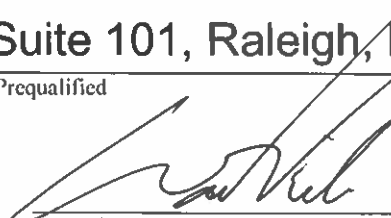

Signature of ~~Member~~ ~~Manager~~ / Authorized Agent  
Select appropriate title

Carl E. Collie

Print or type Signer's name

Walter Viele

Print or type Signer's Name

## DEBARMENT CERTIFICATION

### Conditions for certification:

1. The prequalified bidder shall provide immediate written notice to the Department if at any time the bidder learns that his certification was erroneous when he submitted his debarment certification or explanation filed with the Department, or has become erroneous because of changed circumstances.
2. The terms *covered transaction, debarred, suspended, ineligible, lower tier covered transaction, participant, person, primary covered transaction, principal, proposal, and voluntarily excluded*, as used in this provision, have the meanings set out in the Definitions and Coverage sections of the rules implementing Executive Order 12549. A copy of the Federal Rules requiring this certification and detailing the definitions and coverages may be obtained from the Contract Officer of the Department.
3. The prequalified bidder agrees by submitting this form, that he will not knowingly enter into any lower tier covered transaction with a person who is debarred, suspended, declared ineligible, or voluntarily excluded from participation in NCDOT contracts, unless authorized by the Department.
4. For Federal Aid projects, the prequalified bidder further agrees that by submitting this form he will include the Federal-Aid Provision titled *Required Contract Provisions Federal-Aid Construction Contract (Form FHWA PR 1273)* provided by the Department, without subsequent modification, in all lower tier covered transactions.
5. The prequalified bidder may rely upon a certification of a participant in a lower tier covered transaction that he is not debarred, suspended, ineligible, or voluntarily excluded from the covered transaction, unless he knows that the certification is erroneous. The bidder may decide the method and frequency by which he will determine the eligibility of his subcontractors.
6. Nothing contained in the foregoing shall be construed to require establishment of a system of records in order to render in good faith the certification required by this provision. The knowledge and information of a participant is not required to exceed that which is normally possessed by a prudent person in the ordinary course of business dealings.
7. Except as authorized in paragraph 6 herein, the Department may terminate any contract if the bidder knowingly enters into a lower tier covered transaction with a person who is suspended, debarred, ineligible, or voluntarily excluded from participation in this transaction, in addition to other remedies available by the Federal Government.

### DEBARMENT CERTIFICATION

The prequalified bidder certifies to the best of his knowledge and belief, that he and his principals:

- a. Are not presently debarred, suspended, proposed for debarment, declared ineligible, or voluntarily excluded from covered transactions by any Federal department or agency;
- b. Have not within a three-year period preceding this proposal been convicted of or had a civil judgment rendered against them for commission of fraud or a criminal offense in connection with obtaining, attempting to obtain, or performing a public (Federal, State or local) transaction or contract under a public transaction; violation of Federal or State antitrust statutes or commission of embezzlement, theft, forgery, bribery, falsification or destruction of records; making false statements; or receiving stolen property;
- c. Are not presently indicted for or otherwise criminally or civilly charged by a governmental entity (Federal, State or local) with commission of any of the offenses enumerated in paragraph b. of this certification; and
- d. Have not within a three-year period preceding this proposal had one or more public transactions (Federal, State or local) terminated for cause or default.
- e. Will submit a revised Debarment Certification immediately if his status changes and will show in his bid proposal an explanation for the change in status.

If the prequalified bidder cannot certify that he is not debarred, he shall provide an explanation with this submittal. An explanation will not necessarily result in denial of participation in a contract.

Failure to submit a non-collusion and debarment certification will result in the prequalified bidder's bid being considered non-responsive.

Check here if an explanation is attached to this certification.

**Contract No.**     **C204729**

**County (ies):**     **Johnston**

ACCEPTED BY THE  
DEPARTMENT OF TRANSPORTATION

DocuSigned by:

*Ronald E. Davenport, Jr.*

F81B6038A47A442...

Contract Officer

09/28/2022

Date

Execution of Contract and Bonds  
Approved as to Form:

DocuSigned by:

*Scott Slusser*

06A61E7CD374498...

Attorney General

09/28/2022

Date

Contract No.  
County

**C204729**

Johnston

Rev 5-17-11

**CONTRACT PAYMENT BOND**

Date of Payment Bond Execution September 20, 2022

Name of Principal Contractor FSC II, LLC dba Fred Smith Company

Name of Surety: Western Surety Company and Liberty Mutual Insurance Company

Name of Contracting Body: North Carolina Department of Transportation

Raleigh, North Carolina

Amount of Bond: \$9,742,469.45

Contract ID No.: C204729

County Name: Johnston

KNOW ALL MEN BY THESE PRESENTS, That we, the PRINCIPAL CONTRACTOR (hereafter, PRINCIPAL) and SURETY above named, are held and firmly bound unto the above named Contracting Body, hereinafter called the Contracting Body, in the penal sum of the amount stated above for the payment of which sum well and truly to be made, we bind ourselves, our heirs, executors, administrators, and successors, jointly and severally, firmly by these presents.

THE CONDITION OF THIS OBLIGATION IS SUCH, that whereas the principal entered into a certain contract with the Contracting Body, numbered as shown above and hereto attached:

NOW THEREFORE, if the principal shall promptly make payment to all persons supplying labor and material in the prosecution of the work provided for in said contract, and any and all duly authorized modifications of said contract that may hereafter be made, notice of which modifications to the surety being hereby waived, then this obligation to be void; otherwise to remain in full force and virtue.

IN WITNESS WHEREOF, the above-bound parties have executed this instrument under their several seals on the date indicated above, the name and corporate seal of each corporate party being hereto affixed and these presents duly signed by its undersigned representative, pursuant to authority of its governing body.



Contract No.  
County

C204729

Johnston

Rev 5-17-11

**CONTRACT PAYMENT BOND**

*Affix Seal of Surety Company*

Western Surety Company and Liberty Mutual Insurance Company

Print or type Surety Company Name



By **Renee Ellis**

Print, stamp or type name of Attorney-in-Fact



*Renee Ellis*

Signature of Attorney-in-Fact

*Abigail Foster*

Signature of Witness

**Abigail Foster**

Print or type Signer's name

2601 Bell Road, Montgomery, Alabama 36117

Address of Attorney-in-Fact

Contract No.  
County

C204729

Johnston

Rev 5-17-11

**CONTRACT PAYMENT BOND**

**LIMITED LIABILITY COMPANY**

SIGNATURE OF CONTRACTOR (Principal)

Name of Contractor

**FSC II, LLC dba Fred Smith Company**

Full name of Firm

701 Corporate Center Drive, Suite 101, Raleigh, NC 27607

Address as prequalified

By:

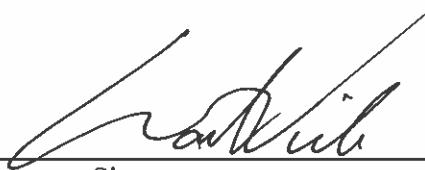

Signature of ~~Member, Manager, Authorized Agent~~  
Select appropriate title

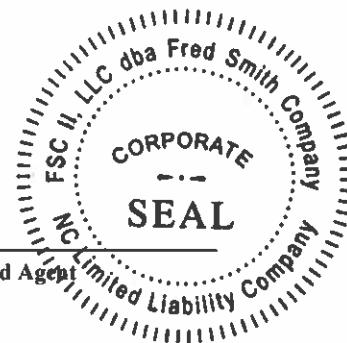

*Walter VIELE*

Print or type Signer's name

Contract No.  
County

**C204729**

**JOHNSTON**

Rev 5-17-11

**CONTRACT PERFORMANCE BOND**

Date of Performance Bond Execution: **September 20, 2022**

Name of Principal Contractor: **FSC II, LLC dba Fred Smith Company**

Name of Surety: **Western Surety Company and Liberty Mutual Insurance Company**

Name of Contracting Body: **North Carolina Department of Transportation**  
**Raleigh, North Carolina**

Amount of Bond: **\$9,742,469.45**

Contract ID No.: **C204729**

County Name: **Johnston**

KNOW ALL MEN BY THESE PRESENTS, That we, the PRINCIPAL CONTRACTOR (hereafter, PRINCIPAL) and SURETY above named, are held and firmly bound unto the above named Contracting Body, hereinafter called the Contracting Body, in the penal sum of the amount stated above for the payment of which sum well and truly to be made, we bind ourselves, our heirs, executors, administrators, and successors, jointly and severally, firmly by these presents.

THE CONDITION OF THIS OBLIGATION IS SUCH, that whereas the principal entered into a certain contract with the Contracting Body, numbered as shown above and hereto attached:

NOW THEREFORE, if the principal shall well and truly perform and fulfill all the undertakings, covenants, terms, conditions, and agreements of said contract during the original term of said contract and any extensions thereof that may be granted by the Contracting Body, with or without notice to the Surety, and during the life of any guaranty required under the contract, and shall also well and truly perform and fulfill all the undertakings, covenants, terms, conditions, and agreements of any and all duly authorized modifications of said contract that may hereafter be made, notice of which modifications to the surety being hereby waived, then this obligation to be void; otherwise to remain in full force and virtue.

IN WITNESS WHEREOF, the above-bound parties have executed this instrument under their several seals on the date indicated above, the name and corporate seal of each corporate party being hereto affixed and these presents duly signed by its undersigned representative, pursuant to authority of its governing body.

Contract No.  
County

C204729

Johnston

Rev 5-17-11

**CONTRACT PERFORMANCE BOND**

*Affix Seal of Surety Company*

Western Surety Company and Liberty Mutual Insurance Company

Print or type Surety Company Name



By **Renee Ellis**

Print, stamp or type name of Attorney-in-Fact

Signature of Attorney-in-Fact



Signature of Witness

Abigail Foster

Print or type Signer's name

2601 Bell Road, Montgomery, Alabama 36117

Address of Attorney-in-Fact

**CONTRACT PERFORMANCE BOND**

**LIMITED LIABILITY COMPANY**

SIGNATURE OF CONTRACTOR (Principal)

Name of Contractor

**FSC II, LLC dba Fred Smith Company**

Full name of Firm

701 Corporate Center Drive, Suite 101, Raleigh, NC 27607

Address as prequalified

By:



Signature of ~~Member~~, ~~Manager~~, Authorized Agent  
Select appropriate title

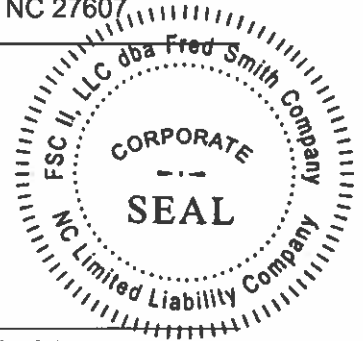

**WALTER VIELE**

Print or type Signer's name

# Western Surety Company

## POWER OF ATTORNEY APPOINTING INDIVIDUAL ATTORNEY-IN-FACT

Know All Men By These Presents, That WESTERN SURETY COMPANY, a South Dakota corporation, is a duly organized and existing corporation having its principal office in the City of Sioux Falls, and State of South Dakota, and that it does by virtue of the signature and seal herein affixed hereby make, constitute and appoint

**Thomas J Gentile, Billie Jo Sanders, Renee Ellis, Paul B Scott Jr., David J Durden, Milton A Kopf III, Joshua Price, Individually**

of Montgomery, AL, its true and lawful Attorney(s)-in-Fact with full power and authority hereby conferred to sign, seal and execute for and on its behalf bonds, undertakings and other obligatory instruments of similar nature

### - In Unlimited Amounts -

and to bind it thereby as fully and to the same extent as if such instruments were signed by a duly authorized officer of the corporation and all the acts of said Attorney, pursuant to the authority hereby given, are hereby ratified and confirmed.

This Power of Attorney is made and executed pursuant to and by authority of the By-Law printed on the reverse hereof, duly adopted, as indicated, by the shareholders of the corporation.

In Witness Whereof, WESTERN SURETY COMPANY has caused these presents to be signed by its Vice President and its corporate seal to be hereto affixed on this 6th day of January, 2022.



WESTERN SURETY COMPANY

Paul T. Bruflat, Vice President

State of South Dakota }  
County of Minnehaha } ss

On this 6th day of January, 2022, before me personally came Paul T. Bruflat, to me known, who, being by me duly sworn, did depose and say: that he resides in the City of Sioux Falls, State of South Dakota; that he is the Vice President of WESTERN SURETY COMPANY described in and which executed the above instrument; that he knows the seal of said corporation; that the seal affixed to the said instrument is such corporate seal; that it was so affixed pursuant to authority given by the Board of Directors of said corporation and that he signed his name thereto pursuant to like authority, and acknowledges same to be the act and deed of said corporation.

My commission expires

March 2, 2026

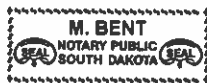

M. Bent, Notary Public

### CERTIFICATE

I, L. Nelson, Assistant Secretary of WESTERN SURETY COMPANY do hereby certify that the Power of Attorney hereinabove set forth is still in force, and further certify that the By-Law of the corporation printed on the reverse hereof is still in force. In testimony whereof I have hereunto subscribed my name and affixed the seal of the said corporation this 20th day of September, 2022.



WESTERN SURETY COMPANY

L. Nelson, Assistant Secretary

Form F4280-7-2012

Go to [www.cnasurety.com](http://www.cnasurety.com) > Owner / Oblige Services > Validate Bond Coverage, if you want to verify bond authenticity.



This Power of Attorney limits the acts of those named herein, and they have no authority to bind the Company except in the manner and to the extent herein stated.

Liberty Mutual Insurance Company
The Ohio Casualty Insurance Company
West American Insurance Company

Certificate No: 8206786-016010

POWER OF ATTORNEY

KNOWN ALL PERSONS BY THESE PRESENTS: That The Ohio Casualty Insurance Company is a corporation duly organized under the laws of the State of New Hampshire, that Liberty Mutual Insurance Company is a corporation duly organized under the laws of the State of Massachusetts, and West American Insurance Company is a corporation duly organized under the laws of the State of Indiana (herein collectively called the "Companies"), pursuant to and by authority herein set forth, does hereby name, constitute and appoint, Billie Jo Sanders; David J. Durden; Joshua Price; Milton A. Kopf, Paul B. Scott Jr.; Renee Ellis; Thomas J. Gentile

all of the city of Montgomery state of AL each individually if there be more than one named, its true and lawful attorney-in-fact to make, execute, seal, acknowledge and deliver, for and on its behalf as surety and as its act and deed, any and all undertakings, bonds, recognizances and other surety obligations, in pursuance of these presents and shall be as binding upon the Companies as if they have been duly signed by the president and attested by the secretary of the Companies in their own proper persons.

IN WITNESS WHEREOF, this Power of Attorney has been subscribed by an authorized officer or official of the Companies and the corporate seals of the Companies have been affixed thereto this 10th day of November, 2021.



Liberty Mutual Insurance Company
The Ohio Casualty Insurance Company
West American Insurance Company

By: David M. Carey, Assistant Secretary

State of PENNSYLVANIA
County of MONTGOMERY ss

On this 10th day of November, 2021 before me personally appeared David M. Carey, who acknowledged himself to be the Assistant Secretary of Liberty Mutual Insurance Company, The Ohio Casualty Company, and West American Insurance Company, and that he, as such, being authorized so to do, execute the foregoing instrument for the purposes therein contained by signing on behalf of the corporations by himself as a duly authorized officer.

IN WITNESS WHEREOF, I have hereunto subscribed my name and affixed my notarial seal at King of Prussia, Pennsylvania, on the day and year first above written.



Commonwealth of Pennsylvania - Notary Seal
Teresa Pastella, Notary Public
Montgomery County
My commission expires March 28, 2025
Commission number 1126044
Member, Pennsylvania Association of Notaries

By: Teresa Pastella, Notary Public

This Power of Attorney is made and executed pursuant to and by authority of the following By-laws and Authorizations of The Ohio Casualty Insurance Company, Liberty Mutual Insurance Company, and West American Insurance Company which resolutions are now in full force and effect reading as follows:

ARTICLE IV - OFFICERS: Section 12. Power of Attorney.

Any officer or other official of the Corporation authorized for that purpose in writing by the Chairman or the President, and subject to such limitation as the Chairman or the President may prescribe, shall appoint such attorneys-in-fact, as may be necessary to act in behalf of the Corporation to make, execute, seal, acknowledge and deliver as surety any and all undertakings, bonds, recognizances and other surety obligations. Such attorneys-in-fact, subject to the limitations set forth in their respective powers of attorney, shall have full power to bind the Corporation by their signature and execution of any such instruments and to attach thereto the seal of the Corporation. When so executed, such instruments shall be as binding as if signed by the President and attested to by the Secretary. Any power or authority granted to any representative or attorney-in-fact under the provisions of this article may be revoked at any time by the Board, the Chairman, the President or by the officer or officers granting such power or authority.

ARTICLE XIII - Execution of Contracts: Section 5. Surety Bonds and Undertakings.

Any officer of the Company authorized for that purpose in writing by the chairman or the president, and subject to such limitations as the chairman or the president may prescribe, shall appoint such attorneys-in-fact, as may be necessary to act in behalf of the Company to make, execute, seal, acknowledge and deliver as surety any and all undertakings, bonds, recognizances and other surety obligations. Such attorneys-in-fact subject to the limitations set forth in their respective powers of attorney, shall have full power to bind the Company by their signature and execution of any such instruments and to attach thereto the seal of the Company. When so executed such instruments shall be as binding as if signed by the president and attested by the secretary.

Certificate of Designation - The President of the Company, acting pursuant to the Bylaws of the Company, authorizes David M. Carey, Assistant Secretary to appoint such attorneys-in-fact as may be necessary to act on behalf of the Company to make, execute, seal, acknowledge and deliver as surety any and all undertakings, bonds, recognizances and other surety obligations.

Authorization - By unanimous consent of the Company's Board of Directors, the Company consents that facsimile or mechanically reproduced signature of any assistant secretary of the Company, wherever appearing upon a certified copy of any power of attorney issued by the Company in connection with surety bonds, shall be valid and binding upon the Company with the same force and effect as though manually affixed.

I, Renee C. Llewellyn, the undersigned, Assistant Secretary, The Ohio Casualty Insurance Company, Liberty Mutual Insurance Company, and West American Insurance Company do hereby certify that the original power of attorney of which the foregoing is a full, true and correct copy of the Power of Attorney executed by said Companies, is in full force and effect and has not been revoked.

IN TESTIMONY WHEREOF, I have hereunto set my hand and affixed the seals of said Companies this 20th day of September, 2022.



By: Renee C. Llewellyn, Assistant Secretary

Not valid for mortgage, note, loan, letter of credit, currency rate, interest rate or residual value guarantees.

For bond and/or Power of Attorney (POA) verification inquiries, please call 610-832-8240 or email HOSUR@libertymutual.com.

**Certificate Of Completion**

Envelope Id: 1B0892565F734D559C0C820ADE44CFB2	Status: Completed
Subject: Please DocuSign: Johnston, C204729	
Source Envelope:	
Document Pages: 327	Signatures: 2
Certificate Pages: 5	Initials: 0
AutoNav: Enabled	Envelope Originator:
Envelopeld Stamping: Disabled	Michelle Taylor
Time Zone: (UTC-05:00) Eastern Time (US & Canada)	1020 Birch Ridge Dr
	Raleigh, NC 27610-4328
	mataylor@ncdot.gov
	IP Address: 152.22.36.25

**Record Tracking**

Status: Original	Holder: Michelle Taylor	Location: DocuSign
9/28/2022 1:32:53 PM	mataylor@ncdot.gov	
Security Appliance Status: Connected	Pool: StateLocal	
Storage Appliance Status: Connected	Pool: North Carolina Department of Transportation	Location: DocuSign

**Signer Events**

Scott Slusser  
 sslusser@ncdoj.gov  
 Security Level: Email, Account Authentication (None)

**Signature**

DocuSigned by:  
  
 06A61E7CD374498...  
 Signature Adoption: Pre-selected Style  
 Using IP Address: 149.168.150.6

**Timestamp**

Sent: 9/28/2022 2:11:59 PM  
 Viewed: 9/28/2022 2:12:19 PM  
 Signed: 9/28/2022 2:13:06 PM

**Electronic Record and Signature Disclosure:**  
 Accepted: 9/28/2022 2:12:19 PM  
 ID: 17a0f7eb-9ad1-4d72-8169-cb206bef930b

Ronald E. Davenport, Jr.  
 rondavenport@ncdot.gov  
 Contract Officer  
 North Carolina Department of Transportation  
 Security Level: Email, Account Authentication (None)

DocuSigned by:  
  
 F81B6038A47A442...  
 Signature Adoption: Pre-selected Style  
 Using IP Address: 152.22.36.27

Sent: 9/28/2022 2:13:14 PM  
 Viewed: 9/28/2022 2:32:28 PM  
 Signed: 9/28/2022 2:32:34 PM

**Electronic Record and Signature Disclosure:**  
 Not Offered via DocuSign

In Person Signer Events	Signature	Timestamp
Editor Delivery Events	Status	Timestamp
Agent Delivery Events	Status	Timestamp
Intermediary Delivery Events	Status	Timestamp
Certified Delivery Events	Status	Timestamp
Carbon Copy Events	Status	Timestamp

Beth Mckay  
 agodotcontractreview@ncdoj.gov  
 North Carolina Department of Transportation  
 Security Level: Email, Account Authentication (None)

**COPIED**

Sent: 9/28/2022 2:12:01 PM

**Electronic Record and Signature Disclosure:**  
 Not Offered via DocuSign



Carbon Copy Events	Status	Timestamp
<p>Lori Strickland  lstrickland@ncdot.gov  Administrative Specialist I  North Carolina Department of Transportation  Security Level: Email, Account Authentication (None)</p> <p><b>Electronic Record and Signature Disclosure:</b>  Not Offered via DocuSign</p>	<div style="border: 2px solid blue; padding: 5px; display: inline-block; font-weight: bold; color: blue;">COPIED</div>	<p>Sent: 9/28/2022 2:32:41 PM  Viewed: 9/28/2022 2:34:13 PM</p>
<p>Michelle Taylor  mataylor@ncdot.gov  North Carolina Department of Transportation  Security Level: Email, Account Authentication (None)</p> <p><b>Electronic Record and Signature Disclosure:</b>  Not Offered via DocuSign</p>	<div style="border: 2px solid blue; padding: 5px; display: inline-block; font-weight: bold; color: blue;">COPIED</div>	<p>Sent: 9/28/2022 2:32:42 PM  Resent: 9/28/2022 2:32:48 PM  Viewed: 9/29/2022 7:30:07 AM</p>
<p>Malcolm J Bell  mjbell1@ncdot.gov  Security Level: Email, Account Authentication (None)</p> <p><b>Electronic Record and Signature Disclosure:</b>  Not Offered via DocuSign</p>	<div style="border: 2px solid blue; padding: 5px; display: inline-block; font-weight: bold; color: blue;">COPIED</div>	<p>Sent: 9/28/2022 2:32:43 PM</p>
<p>Mike Gwyn  wmgwyn@ncdot.gov  Administration Officer I  North Carolina Department of Transportation  Security Level: Email, Account Authentication (None)</p> <p><b>Electronic Record and Signature Disclosure:</b>  Not Offered via DocuSign</p>	<div style="border: 2px solid blue; padding: 5px; display: inline-block; font-weight: bold; color: blue;">COPIED</div>	<p>Sent: 9/28/2022 2:32:44 PM  Viewed: 9/29/2022 10:52:08 AM</p>
<p>Nancy L Gay  nlgay@ncdot.gov  CC+Contract Standards and Development Unit  Security Level: Email, Account Authentication (None)</p> <p><b>Electronic Record and Signature Disclosure:</b>  Not Offered via DocuSign</p>	<div style="border: 2px solid blue; padding: 5px; display: inline-block; font-weight: bold; color: blue;">COPIED</div>	<p>Sent: 9/28/2022 2:32:45 PM</p>

Witness Events	Signature	Timestamp
----------------	-----------	-----------

Notary Events	Signature	Timestamp
---------------	-----------	-----------

Envelope Summary Events	Status	Timestamps
-------------------------	--------	------------

Envelope Sent	Hashed/Encrypted	9/28/2022 1:49:30 PM
Certified Delivered	Security Checked	9/28/2022 2:32:28 PM
Signing Complete	Security Checked	9/28/2022 2:32:34 PM
Completed	Security Checked	9/28/2022 2:32:46 PM

Payment Events	Status	Timestamps
----------------	--------	------------

Electronic Record and Signature Disclosure
--

## **CONSUMER DISCLOSURE**

From time to time, North Carolina Department of Transportation (we, us or Company) may be required by law to provide to you certain written notices or disclosures. Described below are the terms and conditions for providing to you such notices and disclosures electronically through your DocuSign, Inc. (DocuSign) Express user account. Please read the information below carefully and thoroughly, and if you can access this information electronically to your satisfaction and agree to these terms and conditions, please confirm your agreement by clicking the "I agree" button at the bottom of this document.

### **Getting paper copies**

At any time, you may request from us a paper copy of any record provided or made available electronically to you by us. For such copies, as long as you are an authorized user of the DocuSign system you will have the ability to download and print any documents we send to you through your DocuSign user account for a limited period of time (usually 30 days) after such documents are first sent to you. After such time, if you wish for us to send you paper copies of any such documents from our office to you, you will be charged a \$0.00 per-page fee. You may request delivery of such paper copies from us by following the procedure described below.

### **Withdrawing your consent**

If you decide to receive notices and disclosures from us electronically, you may at any time change your mind and tell us that thereafter you want to receive required notices and disclosures only in paper format. How you must inform us of your decision to receive future notices and disclosure in paper format and withdraw your consent to receive notices and disclosures electronically is described below.

### **Consequences of changing your mind**

If you elect to receive required notices and disclosures only in paper format, it will slow the speed at which we can complete certain steps in transactions with you and delivering services to you because we will need first to send the required notices or disclosures to you in paper format, and then wait until we receive back from you your acknowledgment of your receipt of such paper notices or disclosures. To indicate to us that you are changing your mind, you must withdraw your consent using the DocuSign "Withdraw Consent" form on the signing page of your DocuSign account. This will indicate to us that you have withdrawn your consent to receive required notices and disclosures electronically from us and you will no longer be able to use your DocuSign Express user account to receive required notices and consents electronically from us or to sign electronically documents from us.

### **All notices and disclosures will be sent to you electronically**

Unless you tell us otherwise in accordance with the procedures described herein, we will provide electronically to you through your DocuSign user account all required notices, disclosures, authorizations, acknowledgements, and other documents that are required to be provided or made available to you during the course of our relationship with you. To reduce the chance of you inadvertently not receiving any notice or disclosure, we prefer to provide all of the required notices and disclosures to you by the same method and to the same address that you have given us. Thus, you can receive all the disclosures and notices electronically or in paper format through the paper mail delivery system. If you do not agree with this process, please let us know as described below. Please also see the paragraph immediately above that describes the consequences of your electing not to receive delivery of the notices and disclosures electronically from us.

### **How to contact North Carolina Department of Transportation:**

You may contact us to let us know of your changes as to how we may contact you electronically, to request paper copies of certain information from us, and to withdraw your prior consent to receive notices and disclosures electronically as follows:

To contact us by email send messages to: [bledwards1@ncdot.gov](mailto:bledwards1@ncdot.gov)

**To advise North Carolina Department of Transportation of your new e-mail address**

To let us know of a change in your e-mail address where we should send notices and disclosures electronically to you, you must send an email message to us at [bledwards1@ncdot.gov](mailto:bledwards1@ncdot.gov) and in the body of such request you must state: your previous e-mail address, your new e-mail address. We do not require any other information from you to change your email address..

In addition, you must notify DocuSign, Inc to arrange for your new email address to be reflected in your DocuSign account by following the process for changing e-mail in DocuSign.

**To request paper copies from North Carolina Department of Transportation**

To request delivery from us of paper copies of the notices and disclosures previously provided by us to you electronically, you must send us an e-mail to [bledwards1@ncdot.gov](mailto:bledwards1@ncdot.gov) and in the body of such request you must state your e-mail address, full name, US Postal address, and telephone number. We will bill you for any fees at that time, if any.

**To withdraw your consent with North Carolina Department of Transportation**

To inform us that you no longer want to receive future notices and disclosures in electronic format you may:

- i. decline to sign a document from within your DocuSign account, and on the subsequent page, select the check-box indicating you wish to withdraw your consent, or you may;
- ii. send us an e-mail to [bledwards1@ncdot.gov](mailto:bledwards1@ncdot.gov) and in the body of such request you must state your e-mail, full name, IS Postal Address, telephone number, and account number. We do not need any other information from you to withdraw consent.. The consequences of your withdrawing consent for online documents will be that transactions may take a longer time to process..

**Required hardware and software**

Operating Systems:	Windows2000 or WindowsXP
Browsers (for SENDERS):	Internet Explorer 6.0 or above
Browsers (for SIGNERS):	Internet Explorer 6.0, Mozilla FireFox 1.0, NetScape 7.2 (or above)
Email:	Access to a valid email account
Screen Resolution:	800 x 600 minimum

Enabled Security Settings:	<ul style="list-style-type: none"><li>ò Allow per session cookies</li><li>ò Users accessing the internet behind a Proxy Server must enable HTTP 1.1 settings via proxy connection</li></ul>
----------------------------	---

\*\* These minimum requirements are subject to change. If these requirements change, we will provide you with an email message at the email address we have on file for you at that time providing you with the revised hardware and software requirements, at which time you will have the right to withdraw your consent.

**Acknowledging your access and consent to receive materials electronically**

To confirm to us that you can access this information electronically, which will be similar to other electronic notices and disclosures that we will provide to you, please verify that you were able to read this electronic disclosure and that you also were able to print on paper or electronically save this page for your future reference and access or that you were able to e-mail this disclosure and consent to an address where you will be able to print on paper or save it for your future reference and access. Further, if you consent to receiving notices and disclosures exclusively in electronic format on the terms and conditions described above, please let us know by clicking the "I agree" button below.

By checking the "I Agree" box, I confirm that:

- I can access and read this Electronic CONSENT TO ELECTRONIC RECEIPT OF ELECTRONIC CONSUMER DISCLOSURES document; and
- I can print on paper the disclosure or save or send the disclosure to a place where I can print it, for future reference and access; and
- Until or unless I notify North Carolina Department of Transportation as described above, I consent to receive from exclusively through electronic means all notices, disclosures, authorizations, acknowledgements, and other documents that are required to be provided or made available to me by North Carolina Department of Transportation during the course of my relationship with you.