

STATE OF NORTH CAROLINA
DEPARTMENT OF TRANSPORTATION
RALEIGH, N.C.

C203565

CONTRACT AND
CONTRACT BONDS

FOR CONTRACT NO. C203565

WBS 42295.3.FR1 BRSTP-0029(43)

T.I.P NO. B-5136

COUNTY OF CABARRUS

THIS IS THE ROADWAY & STRUCTURE CONTRACT

ROUTE NUMBER US 29 LENGTH 0.345 MILES

LOCATION BRIDGES #66 AND 69 OVER NORFOLK SOUTHERN RAILROAD ON US-29.

CONTRACTOR HRI INC DBA HRI BRIDGE COMPANY

ADDRESS 1750 WEST COLLEGE AVENUE

STATE COLLEGE, PA 16801

BIDS OPENED AUGUST 18, 2015

CONTRACT EXECUTION 9/21/2015

STATE OF NORTH CAROLINA
DEPARTMENT OF TRANSPORTATION
RALEIGH, N.C.

PROPOSAL

INCLUDES ADDENDUM No. 1 DATED 08-06-15

DATE AND TIME OF BID OPENING: **AUGUST 18, 2015 AT 2:00 PM**

CONTRACT ID C203565
WBS 42295.3.FR1

FEDERAL-AID NO. BRSTP-0029(43)
COUNTY CABARRUS
T.I.P. NO. B-5136
MILES 0.345
ROUTE NO. US 29
LOCATION BRIDGES #66 AND 69 OVER NORFOLK SOUTHERN RAILROAD ON US-29.

TYPE OF WORK GRADING, DRAINAGE, PAVING, AND STRUCTURES.

NOTICE:

ALL BIDDERS SHALL COMPLY WITH ALL APPLICABLE LAWS REGULATING THE PRACTICE OF GENERAL CONTRACTING AS CONTAINED IN CHAPTER 87 OF THE GENERAL STATUTES OF NORTH CAROLINA WHICH REQUIRES THE BIDDER TO BE LICENSED BY THE N.C. LICENSING BOARD FOR CONTRACTORS WHEN BIDDING ON ANY NON-FEDERAL AID PROJECT WHERE THE BID IS \$30,000 OR MORE, EXCEPT FOR CERTAIN SPECIALTY WORK AS DETERMINED BY THE LICENSING BOARD. BIDDERS SHALL ALSO COMPLY WITH ALL OTHER APPLICABLE LAWS REGULATING THE PRACTICES OF ELECTRICAL, PLUMBING, HEATING AND AIR CONDITIONING AND REFRIGERATION CONTRACTING AS CONTAINED IN CHAPTER 87 OF THE GENERAL STATUTES OF NORTH CAROLINA. NOTWITHSTANDING THESE LIMITATIONS ON BIDDING, THE BIDDER WHO IS AWARDED ANY FEDERAL - AID FUNDED PROJECT SHALL COMPLY WITH CHAPTER 87 OF THE GENERAL STATUTES OF NORTH CAROLINA FOR LICENSING REQUIREMENTS WITHIN 60 CALENDAR DAYS OF BID OPENING.

BIDS WILL BE RECEIVED AS SHOWN BELOW:

THIS IS A ROADWAY & STRUCTURE PROPOSAL

5% BID BOND OR BID DEPOSIT REQUIRED

**PROPOSAL FOR THE CONSTRUCTION OF
CONTRACT No. C203565 IN CABARRUS COUNTY, NORTH CAROLINA**

Date _____ 20 _____

**DEPARTMENT OF TRANSPORTATION,
RALEIGH, NORTH CAROLINA**

The Bidder has carefully examined the location of the proposed work to be known as Contract No. C203565; has carefully examined the plans and specifications, which are acknowledged to be part of the proposal, the special provisions, the proposal, the form of contract, and the forms of contract payment bond and contract performance bond; and thoroughly understands the stipulations, requirements and provisions. The undersigned bidder agrees to be bound upon his execution of the bid and subsequent award to him by the Board of Transportation in accordance with this proposal to provide the necessary contract payment bond and contract performance bond within fourteen days after the written notice of award is received by him. The undersigned Bidder further agrees to provide all necessary machinery, tools, labor, and other means of construction; and to do all the work and to furnish all materials, except as otherwise noted, necessary to perform and complete the said contract in accordance with *the 2012 Standard Specifications for Roads and Structures* by the dates(s) specified in the Project Special Provisions and in accordance with the requirements of the Engineer, and at the unit or lump sum prices, as the case may be, for the various items given on the sheets contained herein.

The Bidder shall provide and furnish all the materials, machinery, implements, appliances and tools, and perform the work and required labor to construct and complete State Highway Contract No. C203565 in Cabarrus County, for the unit or lump sum prices, as the case may be, bid by the Bidder in his bid and according to the proposal, plans, and specifications prepared by said Department, which proposal, plans, and specifications show the details covering this project, and hereby become a part of this contract.

The published volume entitled *North Carolina Department of Transportation, Raleigh, Standard Specifications for Roads and Structures, January 2012* with all amendments and supplements thereto, is by reference incorporated into and made a part of this contract; that, except as herein modified, all the construction and work included in this contract is to be done in accordance with the specifications contained in said volume, and amendments and supplements thereto, under the direction of the Engineer.

If the proposal is accepted and the award is made, the contract is valid only when signed either by the Contract Officer or such other person as may be designated by the Secretary to sign for the Department of Transportation. The conditions and provisions herein cannot be changed except over the signature of the said Contract Officer.

The quantities shown in the itemized proposal for the project are considered to be approximate only and are given as the basis for comparison of bids. The Department of Transportation may increase or decrease the quantity of any item or portion of the work as may be deemed necessary or expedient.

An increase or decrease in the quantity of an item will not be regarded as sufficient ground for an increase or decrease in the unit prices, nor in the time allowed for the completion of the work, except as provided for the contract.

Accompanying this bid is a bid bond secured by a corporate surety, or certified check payable to the order of the Department of Transportation, for five percent of the total bid price, which deposit is to be forfeited as liquidated damages in case this bid is accepted and the Bidder shall fail to provide the required payment and performance bonds with the Department of Transportation, under the condition of this proposal, within 14 calendar days after the written notice of award is received by him, as provided in the *Standard Specifications*; otherwise said deposit will be returned to the Bidder.



State Contract Officer

DocuSigned by:
Randy A. Garris
A7079FC32A09478...

8/6/2015

TABLE OF CONTENTS

**COVER SHEET
PROPOSAL SHEET**

PROJECT SPECIAL PROVISIONS

CONTRACT TIME AND LIQUIDATED DAMAGES: G-1
 INTERMEDIATE CONTRACT TIME NUMBER 1 AND LIQUIDATED DAMAGES: G-1
 INTERMEDIATE CONTRACT TIME NUMBER 2 AND LIQUIDATED DAMAGES: G-2
 INTERMEDIATE CONTRACT TIME NUMBER 3 AND LIQUIDATED DAMAGES: G-3
 INTERMEDIATE CONTRACT TIME NUMBER 4 AND LIQUIDATED DAMAGES: G-3
 PERMANENT VEGETATION ESTABLISHMENT:..... G-4
 MAJOR CONTRACT ITEMS: G-4
 SPECIALTY ITEMS:..... G-5
 FUEL PRICE ADJUSTMENT:..... G-5
 SCHEDULE OF ESTIMATED COMPLETION PROGRESS:..... G-6
 DISADVANTAGED BUSINESS ENTERPRISE: G-6
 CERTIFICATION FOR FEDERAL-AID CONTRACTS: G-20
 CONTRACTOR'S LICENSE REQUIREMENTS:..... G-20
 U.S. DEPARTMENT OF TRANSPORTATION HOTLINE: G-20
 SUBSURFACE INFORMATION:..... G-21
 LOCATING EXISTING UNDERGROUND UTILITIES:..... G-21
 VALUE ENGINEERING PROPOSAL: G-21
 RESOURCE CONSERVATION AND ENV. SUSTAINABLE PRACTICES:..... G-22
 DOMESTIC STEEL: G-23
 PORTABLE CONCRETE BARRIER - (Partial Payments for Materials):..... G-23
 REMOVABLE PAVEMENT MARKINGS - (Partial Payments for Materials):..... G-24
 MAINTENANCE OF THE PROJECT: G-24
 TWELVE MONTH GUARANTEE:..... G-25
 GIFTS FROM VENDORS AND CONTRACTORS: G-25
 LIABILITY INSURANCE:..... G-26
 EROSION AND SEDIMENT CONTROL/STORMWATER CERTIFICATION: G-26
 PROCEDURE FOR MONITORING BORROW PIT DISCHARGE:..... G-31
 EMPLOYMENT:..... G-33
 STATE HIGHWAY ADMINISTRATOR TITLE CHANGE:..... G-33
 SUBLETTING OF CONTRACT: G-34
 NOTE TO CONTRACTOR: G-34

 ROADWAY..... R-1

STANDARD SPECIAL PROVISIONS

AVAILABILITY FUNDS – TERMINATION OF CONTRACTSSSP-1
 NCDOT GENERAL SEED SPECIFICATION FOR SEED QUALITYSSP-2
 ERRATA.....SSP-5

PLANT AND PEST QUARANTINESSSP-7
 AWARD OF CONTRACT.....SSP-8
 MINORITY AND FEMALE EMPLOYMENT REQUIREMENTSSSP-9
 REQUIRED CONTRACT PROVISIONS FEDERAL-AID CONST. CONTRACTS.....SSP-12
 ON-THE-JOB TRAINING.....SSP-21
 MINIMUM WAGESSSP-24

UNIT PROJECT SPECIAL PROVISIONS

GEOTECHNICAL.....GT-0.1
 GEOENVIRONMENTAL.....GV-1
 TRAFFIC CONTROLTC-1
 UTILITY CONSTRUCTION.....UC-1
 UTILITY BY OTHERS.....UBO-1
 EROSION CONTROLEC-1
 TRAFFIC SIGNALSTS-1
 STRUCTURE / CULVERTSST-1
 RAILROAD INSURANCE (Structures)ST-28

PROPOSAL ITEM SHEET

ITEM SHEET(S) (TAN SHEETS)

PROJECT SPECIAL PROVISIONS**GENERAL****CONTRACT TIME AND LIQUIDATED DAMAGES:**

(4-17-12)

108

SP1 G07 C

The date of availability for this contract is **December 15, 2015**.

The completion date for this contract is **March 30, 2020**.

Except where otherwise provided by the contract, observation periods required by the contract will not be a part of the work to be completed by the completion date and/or intermediate contract times stated in the contract. The acceptable completion of the observation periods that extend beyond the final completion date shall be a part of the work covered by the performance and payment bonds.

The liquidated damages for this contract are **Two Hundred Dollars (\$ 200.00)** per calendar day. These liquidated damages will not be cumulative with any liquidated damages which may become chargeable under Intermediate Contract Time Number 1.

INTERMEDIATE CONTRACT TIME NUMBER 1 AND LIQUIDATED DAMAGES:

(7-1-95) (Rev. 2-21-12)

108

SP1 G13 A

Except for that work required under the Project Special Provisions entitled *Planting, Reforestation* and/or *Permanent Vegetation Establishment*, included elsewhere in this proposal, the Contractor will be required to complete all work included in this contract and shall place and maintain traffic on same.

The date of availability for this intermediate contract time is **December 15, 2015**.

The completion date for this intermediate contract time is **October 1, 2019**.

The liquidated damages for this intermediate contract time are **Two Thousand Dollars (\$ 2,000.00)** per calendar day.

Upon apparent completion of all the work required to be completed by this intermediate date, a final inspection will be held in accordance with Article 105-17 and upon acceptance, the Department will assume responsibility for the maintenance of all work except *Planting, Reforestation* and/or *Permanent Vegetation Establishment*. The Contractor will be responsible for and shall make corrections of all damages to the completed roadway caused by his planting operations, whether occurring prior to or after placing traffic through the project.

INTERMEDIATE CONTRACT TIME NUMBER 2 AND LIQUIDATED DAMAGES:

(2-20-07)

108

SPI G14 A

The Contractor shall complete the required work of installing, maintaining, and removing the traffic control devices for lane closures and restoring traffic to the existing traffic pattern. The Contractor shall not close or narrow a lane of traffic on **US 29 / US 601** during the following time restrictions:

DAY AND TIME RESTRICTIONS

**Monday thru Friday
7:00 AM to 9:00 AM &
4:00 PM to 6:00 PM**

In addition, the Contractor shall not close or narrow a lane of traffic on **US 29 / US 601**, detain and/or alter the traffic flow on or during holidays, holiday weekends, special events, or any other time when traffic is unusually heavy, including the following schedules:

HOLIDAY AND HOLIDAY WEEKEND LANE CLOSURE RESTRICTIONS

1. For **unexpected occurrence** that creates unusually high traffic volumes, as directed by the Engineer.
2. For **New Year's Day**, between the hours of **7:00 AM** December 31st and **6:00 PM** January 2nd. If New Year's Day is on a Friday, Saturday, Sunday or Monday, then until **6:00 PM** the following Tuesday.
3. For **Easter**, between the hours of **7:00 AM** Thursday and **6:00 PM** Monday.
4. For **Memorial Day**, between the hours of **7:00 AM** Friday and **6:00 PM** Tuesday.
5. For **Independence Day**, between the hours of **7:00 AM** the day before Independence Day and **6:00 PM** the day after Independence Day.

If **Independence Day** is on a Friday, Saturday, Sunday or Monday, then between the hours of **7:00 AM** the Thursday before Independence Day and **6:00 PM** the Tuesday after Independence Day.
6. For **Labor Day**, between the hours of **7:00 AM** Friday and **6:00 PM** Tuesday.
7. For **Thanksgiving Day**, between the hours of **7:00 AM** Tuesday and **6:00 PM** Monday.
8. For **Christmas**, between the hours of **7:00 AM** the Friday before the week of Christmas Day and **6:00 PM** the following Tuesday after the week of Christmas Day.
9. For any **NASCAR event at the Charlotte Motor Speedway**, between the hours of **7:00 A.M. the Wednesday before the 1st track event until 6:00 P.M. the day after the last track event.**

Holidays and holiday weekends shall include New Year's, Easter, Memorial Day, Independence Day, Labor Day, Thanksgiving, and Christmas. The Contractor shall schedule his work so that lane closures will not be required during these periods, unless otherwise directed by the Engineer.

The time of availability for this intermediate contract work shall be the time the Contractor begins to install all traffic control devices for lane closures according to the time restrictions listed herein.

The completion time for this intermediate contract work shall be the time the Contractor is required to complete the removal of all traffic control devices for lane closures according to the time restrictions stated above and place traffic in the existing traffic pattern.

The liquidated damages are **Five Hundred Dollars (\$ 500.00)** per 15 minute time period.

INTERMEDIATE CONTRACT TIME NUMBER 3 AND LIQUIDATED DAMAGES:

(2-20-07) (Rev. 6-18-13)

108

SPI G14 F

The Contractor shall complete the work required of **Phase III, Step 3** as shown on Sheet(s) **TMP-3** and shall place and maintain traffic on same.

The time of availability for this intermediate contract time is the **Friday at 10:00 PM** that the Contractor elects to begin the work.

The completion time for this intermediate contract time is the following **Monday at 6:00 AM** after the time of availability.

The liquidated damages are **Five Hundred Dollars (\$500.00)** per 15 minute time period.

INTERMEDIATE CONTRACT TIME NUMBER 4 AND LIQUIDATED DAMAGES:

(2-20-07) (Rev. 6-18-13)

108

SPI G14 F

The Contractor shall complete the work required of **Phase IV, Steps 4 and 5** as shown on Sheet(s) **TMP-3** and shall place and maintain traffic on same.

The time of availability for this intermediate contract time is the **Friday at 10:00 PM** that the Contractor elects to begin the work.

The completion time for this intermediate contract time is the following **Monday at 6:00 AM** after the time of availability.

The liquidated damages are **Five Hundred Dollars (\$500.00)** per 15 minute time period.

PERMANENT VEGETATION ESTABLISHMENT:

(2-16-12) (Rev. 10-15-13)

104

SP1 G16

Establish a permanent stand of the vegetation mixture shown in the contract. During the period between initial vegetation planting and final project acceptance, perform all work necessary to establish permanent vegetation on all erodible areas within the project limits, as well as, in borrow and waste pits. This work shall include erosion control device maintenance and installation, repair seeding and mulching, supplemental seeding and mulching, mowing, and fertilizer topdressing, as directed. All work shall be performed in accordance with the applicable section of the *2012 Standard Specifications*. All work required for initial vegetation planting shall be performed as a part of the work necessary for the completion and acceptance of the Intermediate Contract Time (ICT). Between the time of ICT and Final Project acceptance, or otherwise referred to as the vegetation establishment period, the Department will be responsible for preparing the required National Pollutant Discharge Elimination System (NPDES) inspection records.

Once the Engineer has determined that the permanent vegetation establishment requirement has been achieved at an 80% vegetation density (the amount of established vegetation per given area to stabilize the soil) and no erodible areas exist within the project limits, the Contractor will be notified to remove the remaining erosion control devices that are no longer needed. The Contractor will be responsible for, and shall correct any areas disturbed by operations performed in permanent vegetation establishment and the removal of temporary erosion control measures, whether occurring prior to or after placing traffic on the project.

Payment for *Response for Erosion Control, Seeding and Mulching, Repair Seeding, Supplemental Seeding, Mowing, Fertilizer Topdressing, Silt Excavation, and Stone for Erosion Control* will be made at contract unit prices for the affected items. Work required that is not represented by contract line items will be paid in accordance with Articles 104-7 or 104-3 of the *2012 Standard Specifications*. No additional compensation will be made for maintenance and removal of temporary erosion control items.

MAJOR CONTRACT ITEMS:

(2-19-02)

104

SP1 G28

The following listed items are the major contract items for this contract (see Article 104-5 of the *2012 Standard Specifications*):

Line #	Description
23	Asphalt Concrete Base Course, Type B25.0C
191	Reinforced Concrete Deck Slab
193	Class A Concrete (Bridge)

SPECIALTY ITEMS:

(7-1-95)(Rev. 1-17-12)

108-6

SP1 G37

Items listed below will be the specialty items for this contract (see Article 108-6 of the 2012 *Standard Specifications*).

Line #	Description
56 thru 70	Guardrail
71 thru 76, 78	Fencing
81 thru 86	Signing
103 thru 109, 111	Long-Life Pavement Markings
110	Removable Tape
118	Permanent Pavement Markers
119 thru 135	Utility Construction
136 thru 158	Erosion Control
159 thru 180	Signals/ITS System

FUEL PRICE ADJUSTMENT:

(11-15-05)(Rev. 2-18-14)

109-8

SP1 G43

Revise the 2012 *Standard Specifications* as follows:

Page 1-83, Article 109-8, Fuel Price Adjustments, add the following:

The base index price for DIESEL #2 FUEL is \$ **1.9859** per gallon. Where any of the following are included as pay items in the contract, they will be eligible for fuel price adjustment.

The pay items and the fuel factor used in calculating adjustments to be made will be as follows:

Description	Units	Fuel Usage
		Factor Diesel
Unclassified Excavation	Gal/CY	0.29
Borrow Excavation	Gal/CY	0.29
Class IV Subgrade Stabilization	Gal/Ton	0.55
Aggregate Base Course	Gal/Ton	0.55
Sub-Ballast	Gal/Ton	0.55
Asphalt Concrete Base Course, Type _____	Gal/Ton	2.90
Asphalt Concrete Intermediate Course, Type _____	Gal/Ton	2.90
Asphalt Concrete Surface Course, Type _____	Gal/Ton	2.90
Open-Graded Asphalt Friction Course	Gal/Ton	2.90
Permeable Asphalt Drainage Course, Type _____	Gal/Ton	2.90
Sand Asphalt Surface Course, Type _____	Gal/Ton	2.90
Aggregate for Cement Treated Base Course	Gal/Ton	0.55
Portland Cement for Cement Treated Base Course	Gal/Ton	0.55
___" Portland Cement Concrete Pavement	Gal/SY	0.245
Concrete Shoulders Adjacent to ___" Pavement	Gal/SY	0.245

SCHEDULE OF ESTIMATED COMPLETION PROGRESS:

(7-15-08) (Rev. 5-19-15)

108-2

SP1 G58

The Contractor's attention is directed to the Standard Special Provision entitled *Availability of Funds Termination of Contracts* included elsewhere in this proposal. The Department of Transportation's schedule of estimated completion progress for this project as required by that Standard Special Provision is as follows:

2016	(7/01/15 - 6/30/16)	20	% of Total Amount Bid
2017	(7/01/16 - 6/30/17)	34	% of Total Amount Bid
2018	(7/01/17 - 6/30/18)	25	% of Total Amount Bid
2019	(7/01/18 - 6/30/19)	17	% of Total Amount Bid
2020	(7/01/19 - 6/30/20)	4	% of Total Amount Bid

The Contractor shall also furnish his own progress schedule in accordance with Article 108-2 of the *2012 Standard Specifications*. Any acceleration of the progress as shown by the Contractor's progress schedule over the progress as shown above shall be subject to the approval of the Engineer.

DISADVANTAGED BUSINESS ENTERPRISE:

(10-16-07)(Rev. 12-17-13)

102-15(J)

SP1 G61

Description

The purpose of this Special Provision is to carry out the U.S. Department of Transportation's policy of ensuring nondiscrimination in the award and administration of contracts financed in whole or in part with Federal funds. This provision is guided by 49 CFR Part 26.

Definitions

Additional DBE Subcontractors - Any DBE submitted at the time of bid that will not be used to meet the DBE goal. No submittal of a Letter of Intent is required.

Committed DBE Subcontractor - Any DBE submitted at the time of bid that is being used to meet the DBE goal by submission of a Letter of Intent. Or any DBE used as a replacement for a previously committed DBE firm.

Contract Goal Requirement - The approved DBE participation at time of award, but not greater than the advertised contract goal.

DBE Goal - A portion of the total contract, expressed as a percentage, that is to be performed by committed DBE subcontractor(s).

Disadvantaged Business Enterprise (DBE) - A firm certified as a Disadvantaged Business Enterprise through the North Carolina Unified Certification Program.

Goal Confirmation Letter - Written documentation from the Department to the bidder confirming the Contractor's approved, committed DBE participation along with a listing of the committed DBE firms.

Manufacturer - A firm that operates or maintains a factory or establishment that produces on the premises, the materials or supplies obtained by the Contractor.

Regular Dealer - A firm that owns, operates, or maintains a store, warehouse, or other establishment in which the materials or supplies required for the performance of the contract are bought, kept in stock, and regularly sold to the public in the usual course of business. A regular dealer engages in, as its principal business and in its own name, the purchase and sale or lease of the products in question. A regular dealer in such bulk items as steel, cement, gravel, stone, and petroleum products need not keep such products in stock, if it owns and operates distribution equipment for the products. Brokers and packagers are not regarded as manufacturers or regular dealers within the meaning of this section.

North Carolina Unified Certification Program (NCUCP) - A program that provides comprehensive services and information to applicants for DBE certification, such that an applicant is required to apply only once for a DBE certification that will be honored by all recipients of USDOT funds in the state and not limited to the Department of Transportation only. The Certification Program is in accordance with 49 CFR Part 26.

United States Department of Transportation (USDOT) - Federal agency responsible for issuing regulations (49 CFR Part 26) and official guidance for the DBE program.

Forms and Websites Referenced in this Provision

DBE Payment Tracking System - On-line system in which the Contractor enters the payments made to DBE subcontractors who have performed work on the project.
<https://apps.dot.state.nc.us/Vendor/PaymentTracking/>

DBE-IS Subcontractor Payment Information - Form for reporting the payments made to all DBE firms working on the project. This form is for paper bid projects only.
<http://www.ncdot.org/doh/forms/files/DBE-IS.xls>

RF-1 DBE Replacement Request Form - Form for replacing a committed DBE.
<http://connect.ncdot.gov/projects/construction/Construction%20Forms/DBE%20MBE%20WBE%20Replacement%20Request%20Form.pdf>

SAF Subcontract Approval Form - Form required for approval to sublet the contract.
<http://connect.ncdot.gov/projects/construction/Construction%20Forms/Subcontract%20Approval%20Form%20Rev.%202012.zip>

JC-1 Joint Check Notification Form - Form and procedures for joint check notification. The form acts as a written joint check agreement among the parties providing full and prompt disclosure of the expected use of joint checks.

<http://connect.ncdot.gov/projects/construction/Construction%20Forms/Joint%20Check%20Notification%20Form.pdf>

Letter of Intent - Form signed by the Contractor and the DBE subcontractor, manufacturer or regular dealer that affirms that a portion of said contract is going to be performed by the signed DBE for the amount listed at the time of bid.

<http://connect.ncdot.gov/letting/LetCentral/Letter%20of%20Intent%20to%20Perform%20as%20a%20Subcontractor.pdf>

Listing of DBE Subcontractors Form - Form for entering DBE subcontractors on a project that will meet this DBE goal. This form is for paper bids only.

[http://connect.ncdot.gov/municipalities/Bid%20Proposals%20for%20LGA%20Content/08%20DBE%20Subcontractors%20\(Federal\).docx](http://connect.ncdot.gov/municipalities/Bid%20Proposals%20for%20LGA%20Content/08%20DBE%20Subcontractors%20(Federal).docx)

Subcontractor Quote Comparison Sheet - Spreadsheet for showing all subcontractor quotes in the work areas where DBEs quoted on the project. This sheet is submitted with good faith effort packages.

<http://connect.ncdot.gov/business/SmallBusiness/Documents/DBE%20Subcontractor%20Quote%20Comparison%20Example.xls>

DBE Goal

The following DBE goal for participation by Disadvantaged Business Enterprises is established for this contract:

Disadvantaged Business Enterprises **10.0%**

- (A) *If the DBE goal is more than zero*, the Contractor shall exercise all necessary and reasonable steps to ensure that DBEs participate in at least the percent of the contract as set forth above as the DBE goal.
- (B) *If the DBE goal is zero*, the Contractor shall make an effort to recruit and use DBEs during the performance of the contract. Any DBE participation obtained shall be reported to the Department.

Directory of Transportation Firms (Directory)

Real-time information is available about firms doing business with the Department and firms that are certified through NCUCP in the Directory of Transportation Firms. Only firms identified in the Directory as DBE certified shall be used to meet the DBE goal. The Directory can be found at the following link. <https://partner.ncdot.gov/VendorDirectory/default.html>

The listing of an individual firm in the directory shall not be construed as an endorsement of the firm's capability to perform certain work.

Listing of DBE Subcontractors

At the time of bid, bidders shall submit all DBE participation that they anticipate to use during the life of the contract. Only those identified to meet the DBE goal will be considered committed, even though the listing shall include both committed DBE subcontractors and additional DBE subcontractors. Additional DBE subcontractor participation submitted at the time of bid will be used toward the Department's overall race-neutral goal. Only those firms with current DBE certification at the time of bid opening will be acceptable for listing in the bidder's submittal of DBE participation. The Contractor shall indicate the following required information:

(A) Electronic Bids

Bidders shall submit a listing of DBE participation in the appropriate section of Expedite, the bidding software of Bid Express[®].

- (1) Submit the names and addresses of DBE firms identified to participate in the contract. If the bidder uses the updated listing of DBE firms shown in Expedite, the bidder may use the dropdown menu to access the name and address of the DBE firm.
- (2) Submit the contract line numbers of work to be performed by each DBE firm. When no figures or firms are entered, the bidder will be considered to have no DBE participation.
- (3) The bidder shall be responsible for ensuring that the DBE is certified at the time of bid by checking the Directory of Transportation Firms. If the firm is not certified at the time of the bid-letting, that DBE's participation will not count towards achieving the DBE goal.

(B) Paper Bids

- (1) *If the DBE goal is more than zero,*
 - (a) Bidders, at the time the bid proposal is submitted, shall submit a listing of DBE participation, including the names and addresses on *Listing of DBE Subcontractors* contained elsewhere in the contract documents in order for the bid to be considered responsive. Bidders shall indicate the total dollar value of the DBE participation for the contract.
 - (b) If bidders have no DBE participation, they shall indicate this on the *Listing of DBE Subcontractors* by entering the word "None" or the number "0." This form shall be completed in its entirety. **Blank forms will not be deemed to represent zero participation.** Bids submitted that do not have DBE participation indicated on the appropriate form will not

be read publicly during the opening of bids. The Department will not consider these bids for award and the proposal will be rejected.

- (c) The bidder shall be responsible for ensuring that the DBE is certified at the time of bid by checking the Directory of Transportation Firms. If the firm is not certified at the time of the bid-letting, that DBE's participation will not count towards achieving the corresponding goal.
- (2) *If the DBE goal is zero, entries on the Listing of DBE Subcontractors are not required for the zero goal, however any DBE participation that is achieved during the project shall be reported in accordance with requirements contained elsewhere in the special provision.*

DBE Prime Contractor

When a certified DBE firm bids on a contract that contains a DBE goal, the DBE firm is responsible for meeting the goal or making good faith efforts to meet the goal, just like any other bidder. In most cases, a DBE bidder on a contract will meet the DBE goal by virtue of the work it performs on the contract with its own forces. However, all the work that is performed by the DBE bidder and any other DBE subcontractors will count toward the DBE goal. The DBE bidder shall list itself along with any DBE subcontractors, if any, in order to receive credit toward the DBE goal.

For example, if the DBE goal is 45% and the DBE bidder will only perform 40% of the contract work, the prime will list itself at 40%, and the additional 5% shall be obtained through additional DBE participation with DBE subcontractors or documented through a good faith effort.

DBE prime contractors shall also follow Sections A and B listed under *Listing of DBE Subcontractor* just as a non-DBE bidder would.

Written Documentation – Letter of Intent

The bidder shall submit written documentation for each DBE that will be used to meet the DBE goal of the contract, indicating the bidder's commitment to use the DBE in the contract. This documentation shall be submitted on the Department's form titled *Letter of Intent*.

The documentation shall be received in the office of the State Contractor Utilization Engineer or at DBE@ncdot.gov no later than 12:00 noon of the sixth calendar day following opening of bids, unless the sixth day falls on an official state holiday. In that situation, it is due in the office of the State Contractor Utilization Engineer no later than 12:00 noon on the next official state business day.

If the bidder fails to submit the Letter of Intent from each committed DBE to be used toward the DBE goal, or if the form is incomplete (i.e. both signatures are not present), the DBE participation will not count toward meeting the DBE goal. If the lack of this participation drops the commitment below the DBE goal, the Contractor shall submit evidence of good faith

efforts, completed in its entirety, to the State Contractor Utilization Engineer or DBE@ncdot.gov no later than 12:00 noon on the eighth calendar day following opening of bids, unless the eighth day falls on an official state holiday. In that situation, it is due in the office of the State Contractor Utilization Engineer no later than 12:00 noon on the next official state business day.

Submission of Good Faith Effort

If the bidder fails to meet or exceed the DBE goal, the apparent lowest responsive bidder shall submit to the Department documentation of adequate good faith efforts made to reach the DBE goal.

A hard copy and an electronic copy of this information shall be received in the office of the State Contractor Utilization Engineer or at DBE@ncdot.gov no later than 12:00 noon of the sixth calendar day following opening of bids unless the sixth day falls on an official state holiday. In that situation, it is due in the office of the State Contractor Utilization Engineer the next official state business day. If the contractor cannot send the information electronically, then one complete set and 9 copies of this information shall be received under the same time constraints above.

Note: Where the information submitted includes repetitious solicitation letters, it will be acceptable to submit a representative letter along with a distribution list of the firms that were solicited. Documentation of DBE quotations shall be a part of the good faith effort submittal. This documentation may include written subcontractor quotations, telephone log notations of verbal quotations, or other types of quotation documentation.

Consideration of Good Faith Effort for Projects with DBE Goals More Than Zero

Adequate good faith efforts mean that the bidder took all necessary and reasonable steps to achieve the goal which, by their scope, intensity, and appropriateness, could reasonably be expected to obtain sufficient DBE participation. Adequate good faith efforts also mean that the bidder actively and aggressively sought DBE participation. Mere *pro forma* efforts are not considered good faith efforts.

The Department will consider the quality, quantity, and intensity of the different kinds of efforts a bidder has made. Listed below are examples of the types of actions a bidder will take in making a good faith effort to meet the goal and are not intended to be exclusive or exhaustive, nor is it intended to be a mandatory checklist.

- (A) Soliciting through all reasonable and available means (e.g. attendance at pre-bid meetings, advertising, written notices, use of verifiable electronic means through the use of the NCDOT Directory of Transportation Firms) the interest of all certified DBEs who have the capability to perform the work of the contract. The bidder must solicit this interest within at least 10 days prior to bid opening to allow the DBEs to respond to the solicitation. Solicitation shall provide the opportunity to DBEs within the Division and surrounding Divisions where the project is located. The bidder must determine with

certainty if the DBEs are interested by taking appropriate steps to follow up initial solicitations.

- (B) Selecting portions of the work to be performed by DBEs in order to increase the likelihood that the DBE goals will be achieved.
 - (1) Where appropriate, break out contract work items into economically feasible units to facilitate DBE participation, even when the prime contractor might otherwise prefer to perform these work items with its own forces.
 - (2) Negotiate with subcontractors to assume part of the responsibility to meet the contract DBE goal when the work to be sublet includes potential for DBE participation (2nd and 3rd tier subcontractors).
- (C) Providing interested DBEs with adequate information about the plans, specifications, and requirements of the contract in a timely manner to assist them in responding to a solicitation.
- (D)
 - (1) Negotiating in good faith with interested DBEs. It is the bidder's responsibility to make a portion of the work available to DBE subcontractors and suppliers and to select those portions of the work or material needs consistent with the available DBE subcontractors and suppliers, so as to facilitate DBE participation. Evidence of such negotiation includes the names, addresses, and telephone numbers of DBEs that were considered; a description of the information provided regarding the plans and specifications for the work selected for subcontracting; and evidence as to why additional agreements could not be reached for DBEs to perform the work.
 - (2) A bidder using good business judgment would consider a number of factors in negotiating with subcontractors, including DBE subcontractors, and would take a firm's price and capabilities as well as contract goals into consideration. However, the fact that there may be some additional costs involved in finding and using DBEs is not in itself sufficient reason for a bidder's failure to meet the contract DBE goal, as long as such costs are reasonable. Also, the ability or desire of a prime contractor to perform the work of a contract with its own organization does not relieve the bidder of the responsibility to make good faith efforts. Bidding contractors are not, however, required to accept higher quotes from DBEs if the price difference is excessive or unreasonable.
- (E) Not rejecting DBEs as being unqualified without sound reasons based on a thorough investigation of their capabilities. The bidder's standing within its industry, membership in specific groups, organizations, or associates and political or social affiliations (for example, union vs. non-union employee status) are not legitimate causes for the rejection or non-solicitation of bids in the bidder's efforts to meet the project goal.

- (F) Making efforts to assist interested DBEs in obtaining bonding, lines of credit, or insurance as required by the recipient or bidder.
- (G) Making efforts to assist interested DBEs in obtaining necessary equipment, supplies, materials, or related assistance or services.
- (H) Effectively using the services of available minority/women community organizations; minority/women contractors' groups; Federal, State, and local minority/women business assistance offices; and other organizations as allowed on a case-by-case basis to provide assistance in the recruitment and placement of DBEs. Contact within 7 days from the bid opening the Business Development Manager in the Business Opportunity and Work Force Development Unit to give notification of the bidder's inability to get DBE quotes.
- (I) Any other evidence that the bidder submits which shows that the bidder has made reasonable good faith efforts to meet the DBE goal.

In addition, the Department may take into account the following:

- (1) Whether the bidder's documentation reflects a clear and realistic plan for achieving the DBE goal.
- (2) The bidders' past performance in meeting the DBE goals.
- (3) The performance of other bidders in meeting the DBE goal. For example, when the apparent successful bidder fails to meet the DBE goal, but others meet it, you may reasonably raise the question of whether, with additional reasonable efforts the apparent successful bidder could have met the goal. If the apparent successful bidder fails to meet the DBE goal, but meets or exceeds the average DBE participation obtained by other bidders, the Department may view this, in conjunction with other factors, as evidence of the apparent successful bidder having made a good faith effort.

If the Department does not award the contract to the apparent lowest responsive bidder, the Department reserves the right to award the contract to the next lowest responsive bidder that can satisfy to the Department that the DBE goal can be met or that an adequate good faith effort has been made to meet the DBE goal.

Non-Good Faith Appeal

The State Contractor Utilization Engineer will notify the contractor verbally and in writing of non-good faith. A contractor may appeal a determination of non-good faith made by the Goal Compliance Committee. If a contractor wishes to appeal the determination made by the Committee, they shall provide written notification to the State Contractual Services Engineer or at DBE@ncdot.gov. The appeal shall be made within 2 business days of notification of the determination of non-good faith.

Counting DBE Participation Toward Meeting DBE Goal

(A) Participation

The total dollar value of the participation by a committed DBE will be counted toward the contract goal requirement. The total dollar value of participation by a committed DBE will be based upon the value of work actually performed by the DBE and the actual payments to DBE firms by the Contractor.

(B) Joint Checks

Prior notification of joint check use shall be required when counting DBE participation for services or purchases that involves the use of a joint check. Notification shall be through submission of Form JC-1 (*Joint Check Notification Form*) and the use of joint checks shall be in accordance with the Department's Joint Check Procedures.

(C) Subcontracts (Non-Trucking)

A DBE may enter into subcontracts. Work that a DBE subcontracts to another DBE firm may be counted toward the contract goal requirement. Work that a DBE subcontracts to a non-DBE firm does not count toward the contract goal requirement. If a DBE contractor or subcontractor subcontracts a significantly greater portion of the work of the contract than would be expected on the basis of standard industry practices, it shall be presumed that the DBE is not performing a commercially useful function. The DBE may present evidence to rebut this presumption to the Department. The Department's decision on the rebuttal of this presumption is subject to review by the Federal Highway Administration but is not administratively appealable to USDOT.

(D) Joint Venture

When a DBE performs as a participant in a joint venture, the Contractor may count toward its contract goal requirement a portion of the total value of participation with the DBE in the joint venture, that portion of the total dollar value being a distinct clearly defined portion of work that the DBE performs with its forces.

(E) Suppliers

A contractor may count toward its DBE requirement 60 percent of its expenditures for materials and supplies required to complete the contract and obtained from a DBE regular dealer and 100 percent of such expenditures from a DBE manufacturer.

(F) Manufacturers and Regular Dealers

A contractor may count toward its DBE requirement the following expenditures to DBE firms that are not manufacturers or regular dealers:

- (1) The fees or commissions charged by a DBE firm for providing a *bona fide* service, such as professional, technical, consultant, or managerial services, or for providing bonds or insurance specifically required for the performance of a DOT-assisted contract, provided the fees or commissions are determined to be reasonable and not excessive as compared with fees and commissions customarily allowed for similar services.
- (2) With respect to materials or supplies purchased from a DBE, which is neither a manufacturer nor a regular dealer, count the entire amount of fees or commissions charged for assistance in the procurement of the materials and supplies, or fees or transportation charges for the delivery of materials or supplies required on a job site (but not the cost of the materials and supplies themselves), provided the fees are determined to be reasonable and not excessive as compared with fees customarily allowed for similar services.

Commercially Useful Function

(A) DBE Utilization

The Contractor may count toward its contract goal requirement only expenditures to DBEs that perform a commercially useful function in the work of a contract. A DBE performs a commercially useful function when it is responsible for execution of the work of the contract and is carrying out its responsibilities by actually performing, managing, and supervising the work involved. To perform a commercially useful function, the DBE shall also be responsible with respect to materials and supplies used on the contract, for negotiating price, determining quality and quantity, ordering the material and installing (where applicable) and paying for the material itself. To determine whether a DBE is performing a commercially useful function, the Department will evaluate the amount of work subcontracted, industry practices, whether the amount the firm is to be paid under the contract is commensurate with the work it is actually performing and the DBE credit claimed for its performance of the work, and any other relevant factors.

(B) DBE Utilization in Trucking

The following factors will be used to determine if a DBE trucking firm is performing a commercially useful function:

- (1) The DBE shall be responsible for the management and supervision of the entire trucking operation for which it is responsible on a particular contract, and there shall not be a contrived arrangement for the purpose of meeting DBE goals.

- (2) The DBE shall itself own and operate at least one fully licensed, insured, and operational truck used on the contract.
- (3) The DBE receives credit for the total value of the transportation services it provides on the contract using trucks it owns, insures, and operates using drivers it employs.
- (4) The DBE may subcontract the work to another DBE firm, including an owner-operator who is certified as a DBE. The DBE who subcontracts work to another DBE receives credit for the total value of the transportation services the subcontracted DBE provides on the contract.
- (5) The DBE may also subcontract the work to a non-DBE firm, including from an owner-operator. The DBE who subcontracts the work to a non-DBE is entitled to credit for the total value of transportation services provided by the non-DBE subcontractor not to exceed the value of transportation services provided by DBE-owned trucks on the contract. Additional participation by non-DBE subcontractors receives credit only for the fee or commission it receives as a result of the subcontract arrangement. The value of services performed under subcontract agreements between the DBE and the Contractor will not count towards the DBE contract requirement.
- (6) A DBE may lease truck(s) from an established equipment leasing business open to the general public. The lease must indicate that the DBE has exclusive use of and control over the truck. This requirement does not preclude the leased truck from working for others during the term of the lease with the consent of the DBE, so long as the lease gives the DBE absolute priority for use of the leased truck. This type of lease may count toward the DBE's credit as long as the driver is under the DBE's payroll.
- (7) Subcontracted/leased trucks shall display clearly on the dashboard the name of the DBE that they are subcontracted/leased to and their own company name if it is not identified on the truck itself. Magnetic door signs are not permitted.

DBE Replacement

When a Contractor has relied on a commitment to a DBE firm (or an approved substitute DBE firm) to meet all or part of a contract goal requirement, the contractor shall not terminate the DBE for convenience. This includes, but is not limited to, instances in which the Contractor seeks to perform the work of the terminated subcontractor with another DBE subcontractor, a non-DBE subcontractor, or with the Contractor's own forces or those of an affiliate. A DBE may only be terminated after receiving the Engineer's written approval based upon a finding of good cause for the termination.

All requests for replacement of a committed DBE firm shall be submitted to the Engineer for approval on Form RF-1 (*DBE Replacement Request*). If the Contractor fails to follow this procedure, the Contractor may be disqualified from further bidding for a period of up to 6 months.

The Contractor shall comply with the following for replacement of a committed DBE:

(A) Performance Related Replacement

When a committed DBE is terminated for good cause as stated above, an additional DBE that was submitted at the time of bid may be used to fulfill the DBE commitment. A good faith effort will only be required for removing a committed DBE if there were no additional DBEs submitted at the time of bid to cover the same amount of work as the DBE that was terminated.

If a replacement DBE is not found that can perform at least the same amount of work as the terminated DBE, the Contractor shall submit a good faith effort documenting the steps taken. Such documentation shall include, but not be limited to, the following:

- (1) Copies of written notification to DBEs that their interest is solicited in contracting the work defaulted by the previous DBE or in subcontracting other items of work in the contract.
- (2) Efforts to negotiate with DBEs for specific subbids including, at a minimum:
 - (a) The names, addresses, and telephone numbers of DBEs who were contacted.
 - (b) A description of the information provided to DBEs regarding the plans and specifications for portions of the work to be performed.
- (3) A list of reasons why DBE quotes were not accepted.
- (4) Efforts made to assist the DBEs contacted, if needed, in obtaining bonding or insurance required by the Contractor.

(B) Decertification Replacement

- (1) When a committed DBE is decertified by the Department after the SAF (*Subcontract Approval Form*) has been received by the Department, the Department will not require the Contractor to solicit replacement DBE participation equal to the remaining work to be performed by the decertified firm. The participation equal to the remaining work performed by the decertified firm will count toward the contract goal requirement.
- (2) When a committed DBE is decertified prior to the Department receiving the SAF (*Subcontract Approval Form*) for the named DBE firm, the Contractor shall

take all necessary and reasonable steps to replace the DBE subcontractor with another DBE subcontractor to perform at least the same amount of work to meet the DBE goal requirement. If a DBE firm is not found to do the same amount of work, a good faith effort must be submitted to NCDOT (see A herein for required documentation).

Changes in the Work

When the Engineer makes changes that result in the reduction or elimination of work to be performed by a committed DBE, the Contractor will not be required to seek additional participation. When the Engineer makes changes that result in additional work to be performed by a DBE based upon the Contractor's commitment, the DBE shall participate in additional work to the same extent as the DBE participated in the original contract work.

When the Engineer makes changes that result in extra work, which has more than a minimal impact on the contract amount, the Contractor shall seek additional participation by DBEs unless otherwise approved by the Engineer.

When the Engineer makes changes that result in an alteration of plans or details of construction, and a portion or all of the work had been expected to be performed by a committed DBE, the Contractor shall seek participation by DBEs unless otherwise approved by the Engineer.

When the Contractor requests changes in the work that result in the reduction or elimination of work that the Contractor committed to be performed by a DBE, the Contractor shall seek additional participation by DBEs equal to the reduced DBE participation caused by the changes.

Reports and Documentation

A SAF (*Subcontract Approval Form*) shall be submitted for all work which is to be performed by a DBE subcontractor. The Department reserves the right to require copies of actual subcontract agreements involving DBE subcontractors.

When using transportation services to meet the contract commitment, the Contractor shall submit a proposed trucking plan in addition to the SAF. The plan shall be submitted prior to beginning construction on the project. The plan shall include the names of all trucking firms proposed for use, their certification type(s), the number of trucks owned by the firm, as well as the individual truck identification numbers, and the line item(s) being performed.

Within 30 calendar days of entering into an agreement with a DBE for materials, supplies or services, not otherwise documented by the SAF as specified above, the Contractor shall furnish the Engineer a copy of the agreement. The documentation shall also indicate the percentage (60% or 100%) of expenditures claimed for DBE credit.

Reporting Disadvantaged Business Enterprise Participation

The Contractor shall provide the Engineer with an accounting of payments made to all DBE firms, including material suppliers and contractors at all levels (prime, subcontractor, or second tier subcontractor). This accounting shall be furnished to the Engineer for any given month by the end of the following month. Failure to submit this information accordingly may result in the following action:

- (A) Withholding of money due in the next partial pay estimate; or
- (B) Removal of an approved contractor from the prequalified bidders' list or the removal of other entities from the approved subcontractors list.

While each contractor (prime, subcontractor, 2nd tier subcontractor) is responsible for accurate accounting of payments to DBEs, it shall be the prime contractor's responsibility to report all monthly and final payment information in the correct reporting manner.

Failure on the part of the Contractor to submit the required information in the time frame specified may result in the disqualification of that contractor and any affiliate companies from further bidding until the required information is submitted.

Failure on the part of any subcontractor to submit the required information in the time frame specified may result in the disqualification of that contractor and any affiliate companies from being approved for work on future DOT projects until the required information is submitted.

Contractors reporting transportation services provided by non-DBE lessees shall evaluate the value of services provided during the month of the reporting period only.

At any time, the Engineer can request written verification of subcontractor payments.

- (A) Electronic Bids Reporting

The Contractor shall report the accounting of payments through the Department's DBE Payment Tracking System.

- (B) Paper Bids Reporting

The Contractor shall report the accounting of payments on the Department's DBE-IS (*Subcontractor Payment Information*) with each invoice. Invoices will not be processed for payment until the DBE-IS is received.

Failure to Meet Contract Requirements

Failure to meet contract requirements in accordance with Subarticle 102-15(J) of the *2012 Standard Specifications* may be cause to disqualify the Contractor.

CERTIFICATION FOR FEDERAL-AID CONTRACTS:

(3-21-90)

SP1 G85

The prospective participant certifies, by signing and submitting this bid or proposal, to the best of his or her knowledge and belief, that:

- (A) No Federal appropriated funds have been paid or will be paid, by or on behalf of the undersigned, to any person for influencing or attempting to influence an officer or employee of any Federal agency, a Member of Congress, an officer or employee of Congress, or an employee of a Member of Congress in connection with the awarding of any Federal contract, the making of any Federal grant, the making of any Federal loan, the entering into of any cooperative agreement, and the extension, continuation, renewal, amendment, or modification of any Federal contract, grant, loan, or cooperative agreement.
- (B) If any funds other than Federal appropriated funds have been paid or will be paid to any person for influencing or attempting to influence an officer or employee of any Federal agency, a Member of Congress, an officer or employee of Congress, or an employee of a Member of Congress in connection with this Federal contract, grant, loan, or cooperative agreement, the undersigned shall complete and submit Standard Form-LLL, *Disclosure Form to Report Lobbying*, in accordance with its instructions.

This certification is a material representation of fact upon which reliance was placed when this transaction was made or entered into. Submission of this certification is a prerequisite for making or entering into this transaction imposed by *Section 1352, Title 31, U.S. Code*. Any person who fails to file the required certification shall be subject to a civil penalty of not less than \$10,000 and not more than \$100,000 for each such failure.

The prospective participant also agrees by submitting his or her bid or proposal that he or she shall require that the language of this certification be included in all lower tier subcontracts, which exceed \$100,000 and that all such subrecipients shall certify and disclose accordingly.

CONTRACTOR'S LICENSE REQUIREMENTS:

(7-1-95)

102-14

SP1 G88

If the successful bidder does not hold the proper license to perform any plumbing, heating, air conditioning, or electrical work in this contract, he will be required to sublet such work to a contractor properly licensed in accordance with *Article 2 of Chapter 87 of the General Statutes* (licensing of heating, plumbing, and air conditioning contractors) and *Article 4 of Chapter 87 of the General Statutes* (licensing of electrical contractors).

U.S. DEPARTMENT OF TRANSPORTATION HOTLINE:

(11-22-94)

108-5

SP1 G100

To report bid rigging activities call: **1-800-424-9071**

The U.S. Department of Transportation (DOT) operates the above toll-free hotline Monday through Friday, 8:00 a.m. to 5:00 p.m. eastern time. Anyone with knowledge of possible bid

rigging, bidder collusion, or other fraudulent activities should use the hotline to report such activities.

The hotline is part of the DOT's continuing effort to identify and investigate highway construction contract fraud and abuse is operated under the direction of the DOT Inspector General. All information will be treated confidentially and caller anonymity will be respected.

SUBSURFACE INFORMATION:

(7-1-95)

450

SPI G112 C

Subsurface information is available on the structure portion of this project only.

LOCATING EXISTING UNDERGROUND UTILITIES:

(3-20-12)

105

SPI G115

Revise the *2012 Standard Specifications* as follows:

Page 1-43, Article 105-8, line 28, after the first sentence, add the following:

Identify excavation locations by means of pre-marking with white paint, flags, or stakes or provide a specific written description of the location in the locate request.

VALUE ENGINEERING PROPOSAL:

(05-19-15)

104

SP01 G116

Revise the *2012 Standard Specifications* as follows:

Page 1-36, Subarticle 104-12(B) Evaluation of Proposals, lines 42-44, replace the fourth sentence of the second paragraph with the following:

Pending execution of a formal supplemental agreement implementing an approved VEP and transfer of final plans (hard copy and electronic) sealed by an engineer licensed in the State of North Carolina incorporating an approved VEP to the Resident Engineer and the State Value Management Engineer, the Contractor shall remain obligated to perform the work in accordance with the terms of the existing contract.

Page 1-37, Subarticle 104-12(D) Preliminary Review, lines 9-12, replace the first sentence of the first paragraph with the following:

Should the Contractor desire a preliminary review of a possible VEP, before expending considerable time and expense in full development, a copy of the Preliminary VEP shall be submitted to the Resident Engineer and the State Value Management Engineer at ValueManagementUnit@ncdot.gov.

Page 1-37, Subarticle 104-12(E) Final Proposal, lines 22-23, replace the first sentence of the first paragraph with the following:

A copy of the Final VEP shall be submitted by the Contractor to the Resident Engineer and the State Value Management Engineer at ValueManagementUnit@ncdot.gov.

Page 1-38, Subarticle 104-12(F) Modifications, lines 2-8, replace the first paragraph with the following:

To facilitate the preparation of revisions to contract drawings, the Contractor may purchase reproducible copies of drawings for his use through the Department's Value Management Unit. The preparation of new design drawings by or for the Contractor shall be coordinated with the appropriate Design Branch through the State Value Management Engineer. The Contractor shall provide, at no charge to the Department, one set of reproducible drawings of the approved design needed to implement the VEP. Drawings (hard copy and electronic) which are sealed by an engineer licensed in the State of North Carolina shall be submitted to the State Value Management Engineer no later than ten (10) business days after acceptance of a VEP unless otherwise permitted.

Page 1-38, Subarticle 104-12(F) Modifications, line 17, add the following at the end of the third paragraph:

Supplemental agreements executed for design-bid-build contracts shall reflect any realized savings in the corresponding line items. Supplemental agreements executed for design-build contracts shall add one line item deducting the full savings from the total contract price and one line item crediting the Contractor with 50% of the total VEP savings.

Page 1-38, Subarticle 104-12(F) Modifications, lines 45-47, replace the eighth paragraph with the following:

Unless and until a supplemental agreement is executed and issued by the Department and final plans (hard copy and electronic) sealed by an engineer licensed in the State of North Carolina incorporating an approved VEP have been provided to the Resident Engineer and the State Value Management Engineer, the Contractor shall remain obligated to perform the work in accordance with the terms of the existing contract.

RESOURCE CONSERVATION AND ENV. SUSTAINABLE PRACTICES:

(5-21-13) (Rev. 5-19-15)

104-13

SPI G118

In accordance with North Carolina Executive Order 156, NCGS 130A-309.14(3), and NCGS 136-28.8, it is the objective of the Department to aid in the reduction of materials that become a part of our solid waste stream, to divert materials from landfills, to find ways to recycle and reuse materials, to consider and minimize, where economically feasible, the environmental impacts associated with agency land use and acquisition, construction, maintenance and facility management for the benefit of the Citizens of North Carolina.

To achieve the mission of reducing environmental impacts across the state, the Department is committed to supporting the efforts to initiate, develop and use products and construction methods that incorporate the use of recycled, solid waste products and environmentally sustainable practices in accordance with Article 104-13 of the *Standard Specifications*.

Report the quantities of reused or recycled materials either incorporated in the project or diverted from landfills and any practice that minimizes the environmental impact on the project annually on the Project Construction Reuse and Recycling Reporting Form. The Project Construction Reuse and Recycling Reporting Form and a location tool for local recycling facilities are available at:

<http://connect.ncdot.gov/resources/Environmental/Pages/North-Carolina-Recycling-Locations.aspx>.

Submit the Project Construction Reuse and Recycling Reporting Form by August 1 annually to valuemanagementunit@ncdot.gov. For questions regarding the form or reporting, please contact the State Value Management Engineer at 919-707-4810.

DOMESTIC STEEL:

(4-16-13)

106

SP1 G120

Revise the *2012 Standard Specifications* as follows:

Page 1-49, Subarticle 106-1(B) Domestic Steel, lines 2-7, replace the first paragraph with the following:

All steel and iron products that are permanently incorporated into this project shall be produced in the United States except minimal amounts of foreign steel and iron products may be used provided the combined material cost of the items involved does not exceed 0.1% of the total amount bid for the entire project or \$2,500, whichever is greater. If invoices showing the cost of the material are not provided, the amount of the bid item involving the foreign material will be used for calculations. This minimal amount of foreign produced steel and iron products permitted for use is not applicable to high strength fasteners. Domestically produced high strength fasteners are required.

PORTABLE CONCRETE BARRIER - (Partial Payments for Materials):

(7-1-95) (Rev. 8-16-11)

1170-4

SP1 G121

When so authorized by the Engineer, partial materials payments will be made up to 95 percent of the delivered cost of portable concrete barrier, provided that these materials have been delivered on the project and stored in an acceptable manner, and further provided the documents listed in Subarticle 109-5(C) of the *2012 Standard Specifications* have been furnished to the Engineer.

The provisions of Subarticle 109-5(B) of the *2012 Standard Specifications* will apply to the portable concrete barrier.

REMOVABLE PAVEMENT MARKINGS - (Partial Payments for Materials):

(7-1-95) (Rev. 8-16-11)

1205-10

SP1 G124

When so authorized by the Engineer, partial materials payments will be made up to 95 percent of the delivered cost of pavement marking tape, provided that these materials have been delivered on or in the vicinity of the project, stored in an acceptable manner, not to exceed the shelf life recommended by the manufacturer, and further provided the documents listed in Subarticle 109-5(C) of the *2012 Standard Specifications* have been furnished to the Engineer.

The Contractor shall be responsible for the material and the satisfactory performance of the material when used in the work.

The provisions of Article 109-6 of the *2012 Standard Specifications* will not apply to removable pavement marking materials.

MAINTENANCE OF THE PROJECT:

(11-20-07) (Rev. 1-17-12)

104-10

SP1 G125

Revise the *2012 Standard Specifications* as follows:

Page 1-35, Article 104-10 Maintenance of the Project, line 25, add the following after the first sentence of the first paragraph:

All guardrail/guiderail within the project limits shall be included in this maintenance.

Page 1-35, Article 104-10 Maintenance of the Project, line 30, add the following as the last sentence of the first paragraph:

The Contractor shall perform weekly inspections of guardrail and guiderail and shall report damages to the Engineer on the same day of the weekly inspection. *Where damaged guardrail or guiderail is repaired or replaced as a result of maintaining the project* in accordance with this article, such repair or replacement shall be performed within 7 consecutive calendar days of such inspection report.

Page 1-35, Article 104-10 Maintenance of the Project, lines 42-44, replace the last sentence of the last paragraph with the following:

The Contractor will not be directly compensated for any maintenance operations necessary, except for maintenance of guardrail/guiderail, as this work will be considered incidental to the work covered by the various contract items. The provisions of Article 104-7, Extra Work, and Article 104-8, Compensation and Record Keeping will apply to authorized maintenance of guardrail/guiderail. Performance of weekly inspections of guardrail/guiderail, and the damage reports required as described above, will be considered to be an incidental part of the work being paid for by the various contract items.

TWELVE MONTH GUARANTEE:

(7-15-03)

108

SPI G145

- (A) The Contractor shall guarantee materials and workmanship against latent and patent defects arising from faulty materials, faulty workmanship or negligence for a period of twelve months following the date of final acceptance of the work for maintenance and shall replace such defective materials and workmanship without cost to the Department. The Contractor will not be responsible for damage due to faulty design, normal wear and tear, for negligence on the part of the Department, and/or for use in excess of the design.
- (B) Where items of equipment or material carry a manufacturer's guarantee for any period in excess of twelve months, then the manufacturer's guarantee shall apply for that particular piece of equipment or material. The Department's first remedy shall be through the manufacturer although the Contractor is responsible for invoking the warranted repair work with the manufacturer. The Contractor's responsibility shall be limited to the term of the manufacturer's guarantee. NCDOT would be afforded the same warranty as provided by the Manufacturer.

This guarantee provision shall be invoked only for major components of work in which the Contractor would be wholly responsible for under the terms of the contract. Examples would include pavement structures, bridge components, and sign structures. This provision will not be used as a mechanism to force the Contractor to return to the project to make repairs or perform additional work that the Department would normally compensate the Contractor for. In addition, routine maintenance activities (i.e. mowing grass, debris removal, ruts in earth shoulders,) are not parts of this guarantee.

Appropriate provisions of the payment and/or performance bonds shall cover this guarantee for the project.

To ensure uniform application statewide the Division Engineer will forward details regarding the circumstances surrounding any proposed guarantee repairs to the Chief Engineer for review and approval prior to the work being performed.

GIFTS FROM VENDORS AND CONTRACTORS:

(12-15-09)

107-1

SPI G152

By Executive Order 24, issued by Governor Perdue, and *N.C.G.S. § 133-32*, it is unlawful for any vendor or contractor (i.e. architect, bidder, contractor, construction manager, design professional, engineer, landlord, offeror, seller, subcontractor, supplier, or vendor), to make gifts or to give favors to any State employee of the Governor's Cabinet Agencies (i.e. Administration, Commerce, Correction, Crime Control and Public Safety, Cultural Resources, Environment and Natural Resources, Health and Human Services, Juvenile Justice and Delinquency Prevention, Revenue, Transportation, and the Office of the Governor). This prohibition covers those vendors and contractors who:

- (A) Have a contract with a governmental agency; or
 (B) Have performed under such a contract within the past year; or
 (C) Anticipate bidding on such a contract in the future.

For additional information regarding the specific requirements and exemptions, vendors and contractors are encouraged to review Executive Order 24 and *N.C.G.S. § 133-32*.

Executive Order 24 also encouraged and invited other State Agencies to implement the requirements and prohibitions of the Executive Order to their agencies. Vendors and contractors should contact other State Agencies to determine if those agencies have adopted Executive Order 24.

LIABILITY INSURANCE:

(5-20-14)

SPI G160

Revise the *2012 Standard Specifications* as follows:

Page 1-60, Article 107-15 LIABILITY INSURANCE, line 16, add the following as the second sentence of the third paragraph:

Prior to beginning services, all contractors shall provide proof of coverage issued by a workers' compensation insurance carrier, or a certificate of compliance issued by the Department of Insurance for self-insured subcontractors, irrespective of whether having regularly in service fewer than three employees.

EROSION AND SEDIMENT CONTROL/STORMWATER CERTIFICATION:

(1-16-07) (Rev 9-18-12)

105-16, 225-2, 16

SPI G180

General

Schedule and conduct construction activities in a manner that will minimize soil erosion and the resulting sedimentation and turbidity of surface waters. Comply with the requirements herein regardless of whether or not a National Pollution discharge Elimination System (NPDES) permit for the work is required.

Establish a chain of responsibility for operations and subcontractors' operations to ensure that the *Erosion and Sediment Control/Stormwater Pollution Prevention Plan* is implemented and maintained over the life of the contract.

- (A) *Certified Supervisor* - Provide a certified Erosion and Sediment Control/Stormwater Supervisor to manage the Contractor and subcontractor operations, insure compliance with Federal, State and Local ordinances and regulations, and manage the Quality Control Program.
- (B) *Certified Foreman* - Provide a certified, trained foreman for each construction operation that increases the potential for soil erosion or the possible sedimentation and turbidity of surface waters.
- (C) *Certified Installer* - Provide a certified installer to install or direct the installation for erosion or sediment/stormwater control practices.

- (D) *Certified Designer* - Provide a certified designer for the design of the erosion and sediment control/stormwater component of reclamation plans and, if applicable, for the design of the project erosion and sediment control/stormwater plan.

Roles and Responsibilities

- (A) *Certified Erosion and Sediment Control/Stormwater Supervisor* - The Certified Supervisor shall be Level II and responsible for ensuring the erosion and sediment control/stormwater plan is adequately implemented and maintained on the project and for conducting the quality control program. The Certified Supervisor shall be on the project within 24 hours notice from initial exposure of an erodible surface to the project's final acceptance. Perform the following duties:
- (1) **Manage Operations** - Coordinate and schedule the work of subcontractors so that erosion and sediment control/stormwater measures are fully executed for each operation and in a timely manner over the duration of the contract.
 - (a) Oversee the work of subcontractors so that appropriate erosion and sediment control/stormwater preventive measures are conformed to at each stage of the work.
 - (b) Prepare the required National Pollutant Discharge Elimination System (NPDES) Inspection Record and submit to the Engineer.
 - (c) Attend all weekly or monthly construction meetings to discuss the findings of the NPDES inspection and other related issues.
 - (d) Implement the erosion and sediment control/stormwater site plans requested.
 - (e) Provide any needed erosion and sediment control/stormwater practices for the Contractor's temporary work not shown on the plans, such as, but not limited to work platforms, temporary construction, pumping operations, plant and storage yards, and cofferdams.
 - (f) Acquire applicable permits and comply with requirements for borrow pits, dewatering, and any temporary work conducted by the Contractor in jurisdictional areas.
 - (g) Conduct all erosion and sediment control/stormwater work in a timely and workmanlike manner.
 - (h) Fully perform and install erosion and sediment control/stormwater work prior to any suspension of the work.
 - (i) Coordinate with Department, Federal, State and Local Regulatory agencies on resolution of erosion and sediment control/stormwater issues due to the Contractor's operations.
 - (j) Ensure that proper cleanup occurs from vehicle tracking on paved surfaces or any location where sediment leaves the Right-of-Way.
 - (k) Have available a set of erosion and sediment control/stormwater plans that are initialed and include the installation date of Best Management Practices. These practices shall include temporary and permanent groundcover and be properly updated to reflect necessary plan and field

changes for use and review by Department personnel as well as regulatory agencies.

- (2) Requirements set forth under the NPDES Permit - The Department's NPDES Stormwater permit (NCS000250) outlines certain objectives and management measures pertaining to construction activities. The permit references *NCG010000, General Permit to Discharge Stormwater* under the NPDES, and states that the Department shall incorporate the applicable requirements into its delegated Erosion and Sediment Control Program for construction activities disturbing one or more acres of land. The Department further incorporates these requirements on all contracted bridge and culvert work at jurisdictional waters, regardless of size. Some of the requirements are, but are not limited to:
 - (a) Control project site waste to prevent contamination of surface or ground waters of the state, i.e. from equipment operation/maintenance, construction materials, concrete washout, chemicals, litter, fuels, lubricants, coolants, hydraulic fluids, any other petroleum products, and sanitary waste.
 - (b) Inspect erosion and sediment control/stormwater devices and stormwater discharge outfalls at least once every 7 calendar days, twice weekly for construction related *Federal Clean Water Act, Section 303(d)* impaired streams with turbidity violations, and within 24 hours after a significant rainfall event of 0.5 inch that occurs within a 24 hour period.
 - (c) Maintain an onsite rain gauge or use the Department's Multi-Sensor Precipitation Estimate website to maintain a daily record of rainfall amounts and dates.
 - (d) Maintain erosion and sediment control/stormwater inspection records for review by Department and Regulatory personnel upon request.
 - (e) Implement approved reclamation plans on all borrow pits, waste sites and staging areas.
 - (f) Maintain a log of turbidity test results as outlined in the Department's Procedure for Monitoring Borrow Pit Discharge.
 - (g) Provide secondary containment for bulk storage of liquid materials.
 - (h) Provide training for employees concerning general erosion and sediment control/stormwater awareness, the Department's NPDES Stormwater Permit NCS000250 requirements, and the applicable requirements of the *General Permit, NCG010000*.
 - (i) Report violations of the NPDES permit to the Engineer immediately who will notify the Division of Water Quality Regional Office within 24 hours of becoming aware of the violation.
- (3) Quality Control Program - Maintain a quality control program to control erosion, prevent sedimentation and follow provisions/conditions of permits. The quality control program shall:

- (a) Follow permit requirements related to the Contractor and subcontractors' construction activities.
 - (b) Ensure that all operators and subcontractors on site have the proper erosion and sediment control/stormwater certification.
 - (c) Notify the Engineer when the required certified erosion and sediment control/stormwater personnel are not available on the job site when needed.
 - (d) Conduct the inspections required by the NPDES permit.
 - (e) Take corrective actions in the proper timeframe as required by the NPDES permit for problem areas identified during the NPDES inspections.
 - (f) Incorporate erosion control into the work in a timely manner and stabilize disturbed areas with mulch/seed or vegetative cover on a section-by-section basis.
 - (g) Use flocculants approved by state regulatory authorities where appropriate and where required for turbidity and sedimentation reduction.
 - (h) Ensure proper installation and maintenance of temporary erosion and sediment control devices.
 - (i) Remove temporary erosion or sediment control devices when they are no longer necessary as agreed upon by the Engineer.
 - (j) The Contractor's quality control and inspection procedures shall be subject to review by the Engineer. Maintain NPDES inspection records and make records available at all times for verification by the Engineer.
- (B) *Certified Foreman* - At least one Certified Foreman shall be onsite for each type of work listed herein during the respective construction activities to control erosion, prevent sedimentation and follow permit provisions:
- (1) Foreman in charge of grading activities
 - (2) Foreman in charge of bridge or culvert construction over jurisdictional areas
 - (3) Foreman in charge of utility activities
- The Contractor may request to use the same person as the Level II Supervisor and Level II Foreman. This person shall be onsite whenever construction activities as described above are taking place. This request shall be approved by the Engineer prior to work beginning.
- The Contractor may request to name a single Level II Foreman to oversee multiple construction activities on small bridge or culvert replacement projects. This request shall be approved by the Engineer prior to work beginning.
- (C) *Certified Installers* - Provide at least one onsite, Level I Certified Installer for each of the following erosion and sediment control/stormwater crew:
- (1) Seeding and Mulching
 - (2) Temporary Seeding
 - (3) Temporary Mulching

- (4) Sodding
- (5) Silt fence or other perimeter erosion/sediment control device installations
- (6) Erosion control blanket installation
- (7) Hydraulic tackifier installation
- (8) Turbidity curtain installation
- (9) Rock ditch check/sediment dam installation
- (10) Ditch liner/matting installation
- (11) Inlet protection
- (12) Riprap placement
- (13) Stormwater BMP installations (such as but not limited to level spreaders, retention/detention devices)
- (14) Pipe installations within jurisdictional areas

If a Level I *Certified Installer* is not onsite, the Contractor may substitute a Level II Foreman for a Level I Installer, provided the Level II Foreman is not tasked to another crew requiring Level II Foreman oversight.

- (D) *Certified Designer* - Include the certification number of the Level III Certified Designer on the erosion and sediment control/stormwater component of all reclamation plans and if applicable, the certification number of the Level III Certified Designer on the design of the project erosion and sediment control/stormwater plan.

Preconstruction Meeting

Furnish the names of the *Certified Erosion and Sediment Control/Stormwater Supervisor*, *Certified Foremen*, *Certified Installers* and *Certified Designer* and notify the Engineer of changes in certified personnel over the life of the contract within 2 days of change.

Ethical Responsibility

Any company performing work for the North Carolina Department of Transportation has the ethical responsibility to fully disclose any reprimand or dismissal of an employee resulting from improper testing or falsification of records.

Revocation or Suspension of Certification

Upon recommendation of the Chief Engineer to the certification entity, certification for *Supervisor*, *Certified Foremen*, *Certified Installers* and *Certified Designer* may be revoked or suspended with the issuance of an *Immediate Corrective Action (ICA)*, *Notice of Violation (NOV)*, or *Cease and Desist Order* for erosion and sediment control/stormwater related issues.

The Chief Engineer may recommend suspension or permanent revocation of certification due to the following:

- (A) Failure to adequately perform the duties as defined within this certification provision.

- (B) Issuance of an ICA, NOV, or Cease and Desist Order.
- (C) Failure to fully perform environmental commitments as detailed within the permit conditions and specifications.
- (D) Demonstration of erroneous documentation or reporting techniques.
- (E) Cheating or copying another candidate's work on an examination.
- (F) Intentional falsification of records.
- (G) Directing a subordinate under direct or indirect supervision to perform any of the above actions.
- (H) Dismissal from a company for any of the above reasons.
- (I) Suspension or revocation of one's certification by another entity.

Suspension or revocation of a certification will be sent by certified mail to the certificant and the Corporate Head of the company that employs the certificant.

A certificant has the right to appeal any adverse action which results in suspension or permanent revocation of certification by responding, in writing, to the Chief Engineer within 10 calendar days after receiving notice of the proposed adverse action.

Chief Engineer
1536 Mail Service Center
Raleigh, NC 27699-1536

Failure to appeal within 10 calendar days will result in the proposed adverse action becoming effective on the date specified on the certified notice. Failure to appeal within the time specified will result in a waiver of all future appeal rights regarding the adverse action taken. The certificant will not be allowed to perform duties associated with the certification during the appeal process.

The Chief Engineer will hear the appeal and make a decision within 7 days of hearing the appeal. Decision of the Chief Engineer will be final and will be made in writing to the certificant.

If a certification is temporarily suspended, the certificant shall pass any applicable written examination and any proficiency examination, at the conclusion of the specified suspension period, prior to having the certification reinstated.

Measurement and Payment

Certified Erosion and Sediment Control/Stormwater Supervisor, Certified Foremen, Certified Installers and Certified Designer will be incidental to the project for which no direct compensation will be made.

PROCEDURE FOR MONITORING BORROW PIT DISCHARGE:

(2-20-07) (Rev. 3-19-13)

105-16, 230, 801

SP1 G181

Water discharge from borrow pit sites shall not cause surface waters to exceed 50 NTUs (nephelometric turbidity unit) in streams not designated as trout waters and 10 NTUs in streams, lakes or reservoirs designated as trout waters. For lakes and reservoirs not designated as trout

waters, the turbidity shall not exceed 25 NTUs. If the turbidity exceeds these levels due to natural background conditions, the existing turbidity level shall not be increased.

If during any operating day, the downstream water quality exceeds the standard, the Contractor shall do all of the following:

- (A) Either cease discharge or modify the discharge volume or turbidity levels to bring the downstream turbidity levels into compliance, or
- (B) Evaluate the upstream conditions to determine if the exceedance of the standard is due to natural background conditions. If the background turbidity measurements exceed the standard, operation of the pit and discharge can continue as long as the stream turbidity levels are not increased due to the discharge.
- (C) Measure and record the turbidity test results (time, date and sampler) at all defined sampling locations 30 minutes after startup and at a minimum, one additional sampling of all sampling locations during that 24-hour period in which the borrow pit is discharging.
- (D) Notify DWQ within 24 hours of any stream turbidity standard exceedances that are not brought into compliance.

During the Environmental Assessment required by Article 230-4 of the *2012 Standard Specifications*, the Contractor shall define the point at which the discharge enters into the State's surface waters and the appropriate sampling locations. Sampling locations shall include points upstream and downstream from the point at which the discharge enters these waters. Upstream sampling location shall be located so that it is not influenced by backwater conditions and represents natural background conditions. Downstream sampling location shall be located at the point where complete mixing of the discharge and receiving water has occurred.

The discharge shall be closely monitored when water from the dewatering activities is introduced into jurisdictional wetlands. Any time visible sedimentation (deposition of sediment) on the wetland surface is observed, the dewatering activity will be suspended until turbidity levels in the stilling basin can be reduced to a level where sediment deposition does not occur. Staining of wetland surfaces from suspended clay particles, occurring after evaporation or infiltration, does not constitute sedimentation. No activities shall occur in wetlands that adversely affect the functioning of a wetland. Visible sedimentation will be considered an indication of possible adverse impacts on wetland use.

The Engineer will perform independent turbidity tests on a random basis. These results will be maintained in a log within the project records. Records will include, at a minimum, turbidity test results, time, date and name of sampler. Should the Department's test results exceed those of the Contractor's test results, an immediate test shall be performed jointly with the results superseding the previous test results of both the Department and the Contractor.

The Contractor shall use the *NCDOT Turbidity Reduction Options for Borrow Pits Matrix*, available at http://www.ncdot.gov/doh/operations/dp_chief_eng/roadside/fieldops/downloads/

Files/TurbidityReductionOptionSheet.pdf to plan, design, construct, and maintain BMPs to address water quality standards. Tier I Methods include stilling basins which are standard compensatory BMPs. Other Tier I methods are noncompensatory and shall be used when needed to meet the stream turbidity standards. Tier II Methods are also noncompensatory and are options that may be needed for protection of rare or unique resources or where special environmental conditions exist at the site which have led to additional requirements being placed in the DWQ's 401 Certifications and approval letters, Isolated Wetland Permits, Riparian Buffer Authorization or a DOT Reclamation Plan's Environmental Assessment for the specific site. Should the Contractor exhaust all Tier I Methods on a site exclusive of rare or unique resources or special environmental conditions, Tier II Methods may be required by regulators on a case by case basis per supplemental agreement.

The Contractor may use cation exchange capacity (CEC) values from proposed site borings to plan and develop the bid for the project. CEC values exceeding 15 milliequivalents per 100 grams of soil may indicate a high potential for turbidity and should be avoided when dewatering into surface water is proposed.

No additional compensation for monitoring borrow pit discharge will be paid.

EMPLOYMENT:

(11-15-11) (Rev. 1-17-12)

108, 102

SPI G184

Revise the *2012 Standard Specifications* as follows:

Page 1-20, Subarticle 102-15(O), delete and replace with the following:

(O) Failure to restrict a former Department employee as prohibited by Article 108-5.

Page 1-65, Article 108-5 Character of Workmen, Methods, and Equipment, line 32, delete all of line 32, the first sentence of the second paragraph and the first word of the second sentence of the second paragraph.

STATE HIGHWAY ADMINISTRATOR TITLE CHANGE:

(9-18-12)

SPI G185

Revise the *2012 Standard Specifications* as follows:

Replace all references to "State Highway Administrator" with "Chief Engineer".

SUBLETTING OF CONTRACT:

(11-18-2014)

108-6

SPI G186

Revise the *2012 Standard Specifications* as follows:

Page 1-66, Article 108-6 Subletting of Contract, line 37, add the following as the second sentence of the first paragraph:

All requests to sublet work shall be submitted within 30 days of the date of availability or prior to expiration of 20% of the contract time, whichever date is later, unless otherwise approved by the Engineer.

Page 1-67, Article 108-6 Subletting of Contract, line 7, add the following as the second sentence of the fourth paragraph:

Purchasing materials for subcontractors is not included in the percentage of work required to be performed by the Contractor. If the Contractor sublets items of work but elects to purchase material for the subcontractor, the value of the material purchased will be included in the total dollar amount considered to have been sublet.

NOTE TO CONTRACTOR:

Security fencing shall be maintained at all times. Proposed security fence shall be erected immediately upon removal of existing fencing on Parcels 005 and 007.

PROJECT SPECIAL PROVISIONS**ROADWAY****CLEARING AND GRUBBING - METHOD III:**

(4-6-06) (Rev.8-18-15)

200

SP2 R02B

Perform clearing on this project to the limits established by Method "III" shown on Standard Drawing No. 200.03 of the *2012 Roadway Standard Drawings*. Conventional clearing methods may be used except where permit drawings or conditions have been included in the proposal which require certain areas to be cleared by hand methods.

BURNING RESTRICTIONS:

(7-1-95)

200, 210, 215

SP2 R05

Open burning is not permitted on any portion of the right-of-way limits established for this project. Do not burn the clearing, grubbing or demolition debris designated for disposal and generated from the project at locations within the project limits, off the project limits or at any waste or borrow sites in this county. Dispose of the clearing, grubbing and demolition debris by means other than burning, according to state or local rules and regulations.

LUMP SUM GRADING:

(8-17-10)

226

SP2 R16

Lump sum grading shall be performed in accordance with Section 226 Comprehensive Grading of the *2012 Standard Specifications* except as follows:

Delete all references to:
Section 230 Borrow Excavation (Item 0106)

TEMPORARY DETOURS:

(8-15-00) (Rev. 4-21-15)

1101

SP2 R30A

Construct the temporary detours required on this project in accordance with the typical sections in the plans or as directed by the Engineer.

After the detours have served their purpose, remove the portions deemed unsuitable for use as a permanent part of the project as directed by the Engineer. Salvage and stockpile the aggregate base course removed from the detours at locations within the right of way, as directed by the Engineer, for removal by State Forces. Place pavement and earth material removed from the detour in embankments or dispose of in waste areas furnished by the Contractor.

Pipe culverts removed from the detours remain the property of the Contractor. Pipe culverts that are removed will be measured and will be paid at the contract unit price per linear foot for *Pipe Removal*. Payment for the construction of the detours will be made at the contract unit prices for the various items involved.

No direct payment will be made for removing the aggregate base course, earth material and pavement, as the cost of same shall be included in the lump sum price bid for *Grading*. Such

prices and payments will be full compensation for the work of removing, salvaging, and stockpiling aggregate base course; and for placing earth material and pavement in embankments or disposing of earth material and pavement in waste areas.

SHOULDER AND FILL SLOPE MATERIAL:

(5-21-02)

235, 560

SP2 R45 A

Description

Perform the required shoulder and slope construction for this project in accordance with the applicable requirements of Section 560 and Section 235 of the *2012 Standard Specifications*.

Measurement and Payment

Where the material has been obtained from an authorized stockpile or from a borrow source and *Borrow Excavation* is not included in the contract, no direct payment will be made for this work, as the cost of this work will be part of the work being paid at the contract lump sum price for *Grading*. If *Borrow Excavation* is included in this contract and the material has been obtained from an authorized stockpile or from a borrow source, measurement and payment will be as provided in Section 230 of the *2012 Standard Specifications for Borrow Excavation*.

COAL COMBUSTION PRODUCTS IN EMBANKMENTS:

(4-16-02) (Rev. 5-19-15)

235

SP02 R70

Description

This specification allows the Contractor an option, with the approval of the Engineer, to use coal combustion products (CCPs) in embankments as a substitute for conventional borrow material. The amount of CCPs allowed to be used for this project will be less than 80,000 tons total and less than 8,000 tons per acre.

Materials

Supply coal combustion products from the Department list of potential suppliers maintained by the Value Management Unit. Site specific approval of CCP material will be required prior to beginning construction.

The following CCPs are unacceptable:

- (A) Frozen material,
- (B) Ash from boilers fired with both coal and petroleum coke, and
- (C) Material with a maximum dry unit weight of less than 65 pounds per cubic foot when tested in accordance with AASHTO T-99 Method A or C.

Collect and transport CCPs in a manner that will prevent nuisances and hazards to public health and safety. Moisture condition the CCPs as needed and transport in covered trucks to prevent dusting.

Preconstruction Requirements

When CCPs are to be used as a substitute for earth borrow material, request written approval from the Engineer at least ninety (90) days in advance of the intent to use CCPs and include the following details using the NCDOT Form #CCP-2015-V1 in accordance with NCGS § 130A-309.215(b)(1):

- (A) Description, purpose and location of project.
- (B) Estimated start and completion dates of project.
- (C) Estimated volume of CCPs to be used on project with specific locations and construction details of the placement.
- (D) Toxicity Characteristic Leaching Procedure analysis from a representative sample of each different CCP source to be used in the project for, at minimum, all of the following constituents: arsenic, barium, cadmium, lead, chromium, mercury, selenium, and silver.
- (E) The names, address, and contact information for the generator of the CCPs.
- (F) Physical location of the project at which the CCPs were generated.

Submit the form to the Engineer and the State Value Management Engineer at valuemanagement@ncdot.gov for review. The Engineer and the State Value Management Engineer will coordinate the requirements of NCGS § 130A-309.215(a)(1) and notify the Contractor that all the necessary requirements have been met before the placement of structural fill using coal combustion products is allowed.

Construction Methods

In accordance with the detail in the plans, place CCPs in the core of the embankment section with at least 4 feet of earth cover to the outside limits of the embankments or subgrade and at least 5 feet above the seasonal high ground-water table. CCPs used in embankments shall not be placed as follows:

- (A) Within 50 feet of any property boundary.
- (B) Within 300 horizontal feet of a private dwelling or well.
- (C) Within 50 horizontal feet of the top of the bank of a perennial stream or other surface water body.
- (D) Within a 100-year floodplain except as authorized under NCGS § 143-215.54A(b). A site located in a floodplain shall not restrict the flow of the 100-year floodplain or result in washout of solid waste so as to pose a hazard to human life, wildlife or land and water resources.
- (E) Within 50 horizontal feet of a wetland, unless, after consideration of the chemical and physical impact on the wetland, the United States Army Corps of Engineers issues a permit or waiver for the fill.

Construct embankments by placing CCPs in level uniform lifts with no more than a lift of 10 inches and compacted to at least a density of 95 percent as determined by test methods in AASHTO T-99, Determination of Maximum Dry Density and Optimum Moisture Content, Method A or C depending upon particle size of the product. Provide a moisture content at the

time of compaction of within 4 percent of optimum but not greater than one percent above optimum as determined by AASHTO T-99, Method A or C.

Divert surface waters resulting from precipitation from the CCPs placement area during filling and construction activities. Construct embankments such that rainfall will not run directly off of the CCPs. Provide dust control to minimize airborne emissions. Construct fill in a manner that prevents water from accumulating and ponding and do not pump nor discharge waters from CCP's filling and construction areas.

Measurement and Payment

Borrow Excavation will be measured by truck volume and paid in cubic yards in accordance with Article 230-5 of the *2012 Standard Specifications*.

PIPE INSTALLATION:

(11-20-12) (Rev. 8-18-15)

300

SP3 R01

Revise the *2012 Standard Specifications* as follows:

Page 3-1, Article 300-2, Materials, line 15, in the materials table, replace “Flowable Fill” and “Geotextiles” with the following:

Item	Section
Flowable Fill, Excavatable	1000-6
Grout, Type 2	1003
Geotextiles, Type 4	1056

Page 3-1, Article 300-2, Materials, lines 23-24, replace sentence with the following:

Provide foundation conditioning geotextile and geotextile to wrap pipe joints in accordance with Section 1056 for Type 4 geotextile.

Page 3-3, Subarticle 300-6(A), Rigid Pipe, line 2, in the first paragraph, replace “an approved non-shrink grout.” with “grout.” and line 4, in the second paragraph, replace “filtration geotextile” with “geotextile”.

Page 3-3, Article 300-7, Backfilling, lines 37-38, in the first and second sentences of the fifth paragraph, replace “Excavatable flowable fill” with “Flowable fill”.

FLOWABLE FILL:

(9-17-02) (Rev 1-17-12)

300, 340, 450, 1000, 1530, 1540, 1550

SP3 R30

Description

This work consists of all work necessary to place flowable fill in accordance with these provisions, the plans, and as directed.

Materials

Refer to Division 10 of the *2012 Standard Specifications*.

Item	Section
Flowable Fill	1000-6

Construction Methods

Discharge flowable fill material directly from the truck into the space to be filled, or by other approved methods. The mix may be placed full depth or in lifts as site conditions dictate. The Contractor shall provide a method to plug the ends of the existing pipe in order to contain the flowable fill.

Measurement and Payment

At locations where flowable fill is called for on the plans and a pay item for flowable fill is included in the contract, *Flowable Fill* will be measured in cubic yards and paid as the actual number of cubic yards that have been satisfactorily placed and accepted. Such price and payment will be full compensation for all work covered by this provision including, but not limited to, the mix design, furnishing, hauling, placing and containing the flowable fill.

Payment will be made under:

Pay Item	Pay Unit
Flowable Fill	Cubic Yard

BRIDGE APPROACH FILLS:

(10-19-10) (Rev. 1-17-12)

422

SP4 R02

Description

Bridge approach fills include bridge approach fills for sub regional tier bridges and reinforced bridge approach fills. Construct bridge approach fills in accordance with the contract and Standard Drawing No. 422.10 or 422.11 of the *2012 Roadway Standard Drawings*. Define “geosynthetics” as geotextiles or geomembranes.

Materials

Refer to Division 10 of the *2012 Standard Specifications*.

Item	Section
Anchor Pins	1056-2
Geotextiles	1056
Portland Cement Concrete	1000
Select Material	1016
Subsurface Drainage Materials	1044
Wire Staples	1060-8(D)

For bridge approach fills for sub regional tier bridges, provide Type 1 geotextile for filtration geotextiles. For reinforced bridge approach fills, provide Type 5 geotextile for geotextile reinforcement and Type 1 geotextile and No. 78M stone for drains. Use Class B concrete for concrete pads.

Use Class III or V select material for reinforced bridge approach fills and only Class V select material (standard size No. 78M stone) for bridge approach fills for sub regional tier bridges. Provide PVC pipes, fittings and outlet pipes for subsurface drainage materials. For drains and PVC pipes behind end bents, use pipes with perforations that meet AASHTO M 278.

Use PVC, HDPE or linear low density polyethylene (LLDPE) geomembranes for reinforced bridge approach fills. For PVC geomembranes, provide grade PVC30 geomembranes that meet ASTM D7176. For HDPE and LLDPE geomembranes, use geomembranes with a nominal thickness of at least 30 mils that meet Geosynthetic Research Institute Standard Specifications GM13 or GM17, respectively. Handle and store geomembranes in accordance with Article 1056-2 of the *2012 Standard Specifications*. Provide material certifications for geomembranes in accordance with Article 1056-3 of the *2012 Standard Specifications*.

Construction Methods

Excavate as necessary for bridge approach fills in accordance with the contract. Notify the Engineer when foundation excavation is complete. Do not place geomembranes or filtration geotextiles until excavation dimensions and foundation material are approved. Attach geomembranes and filtration geotextiles to end bent cap back and wing walls with adhesives, tapes or other approved methods. Glue or weld geomembrane seams to prevent leakage.

For reinforced bridge approach fills, place geotextile reinforcement within 3" of locations shown in Standard Drawing No. 422.10 of the *2012 Roadway Standard Drawings* and in slight tension free of kinks, folds, wrinkles or creases. Install geotextile reinforcement with the orientation, dimensions and number of layers shown in Standard Drawing No. 422.10 of the *2012 Roadway Standard Drawings*. Place first layer of geotextile reinforcement directly on geomembranes with no void or material in between. Install geotextile reinforcement with the machine direction (MD) parallel to the roadway centerline. The MD is the direction of the length or long dimension of the geotextile roll. Do not splice or overlap geotextile reinforcement in the MD so

seams are perpendicular to the roadway centerline. Wrap geotextile reinforcement at end bent cap back and wing walls as shown in Standard Drawing No. 422.10 of the *2012 Roadway Standard Drawings* and directed by the Engineer. Extend geotextile reinforcement at least 4 ft back behind end bent cap back and wing walls into select material.

Overlap adjacent geotextiles at least 18" with seams oriented parallel to the roadway centerline. Hold geotextiles in place with wire staples or anchor pins as needed. Contact the Engineer when existing or future obstructions such as foundations, pavements, pipes, inlets or utilities will interfere with geosynthetics.

For reinforced bridge approach fills, construct one foot square drains consisting of 4" diameter continuous perforated PVC pipes surrounded by No. 78M stone wrapped in Type 1 geotextiles. Install drains in accordance with Standard Drawing No. 422.10 of the *2012 Roadway Standard Drawings*. For bridge approach fills for sub regional tier bridges, install 4" diameter continuous perforated PVC drain pipes in accordance with Standard Drawing No. 422.11 of the *2012 Roadway Standard Drawings*.

Use solvent cement to connect PVC pipes so joints do not leak. Connect perforated pipes to outlet pipes just behind wing walls. Provide drain pipes and drains with positive drainage towards outlets. Place pipe sleeves in or under wing walls for outlet pipes so positive drainage is maintained. Use sleeves that can withstand wing wall loads.

Place select material in 8" to 10" thick lifts. Use only hand operated compaction equipment to compact select material for bridge approach fills. Compact Class III select material in accordance with Subarticle 235-3(C) of the *2012 Standard Specifications*. Compact No. 78M stone with a vibratory compactor to the satisfaction of the Engineer. Do not displace or damage geosynthetics, drain pipes or drains when placing and compacting select material. End dumping directly on geosynthetics is not permitted. Do not operate heavy equipment on geosynthetics, drain pipes or drains until they are covered with at least 8" of select material. Replace any damaged geosynthetics, drain pipes or drains to the satisfaction of the Engineer.

Cover open ends of outlet pipes with rodent screens as shown in Standard Drawing No. 815.03 of the *2012 Roadway Standard Drawings*. Connect ends of outlet pipes to concrete pads or existing drainage structures as directed by the Engineer. Construct concrete pads with an Ordinary surface finish that meets Subarticle 825-6(B) of the *2012 Standard Specifications*.

Measurement and Payment

Reinforced Bridge Approach Fill, Station ____ will be paid at the contract lump sum price. The contract lump sum price for *Reinforced Bridge Approach Fill, Station ____* will be full compensation for labor, tools, equipment and reinforced bridge approach fill materials, excavating, backfilling, hauling and removing excavated materials, compacting select material, connecting outlet pipes to existing drainage structures and supplying select materials, geosynthetics, drains, pipe sleeves and outlet components and any incidentals necessary to construct all reinforced bridge approach fills at each bridge.

Bridge Approach Fill - Sub Regional Tier, Station _____ will be paid at the contract lump sum price. The contract lump sum price for *Bridge Approach Fill - Sub Regional Tier, Station _____* will be full compensation for labor, tools, equipment and bridge approach fill materials, excavating, backfilling, hauling and removing excavated materials, compacting No. 78M stone, connecting outlet pipes to existing drainage structures and supplying No. 78M stone, filtration geotextiles, drain pipes, pipe sleeves and outlet components and any incidentals necessary to construct all bridge approach fills at each sub regional tier bridge.

Payment will be made under:

Pay Item	Pay Unit
Reinforced Bridge Approach Fill, Station _____	Lump Sum
Bridge Approach Fill - Sub Regional Tier, Station _____	Lump Sum

ASPHALT PAVEMENTS - SUPERPAVE:

(6-19-12) (Rev. 4-21-15)

605, 609, 610, 650

SP6 R01

Revise the *2012 Standard Specifications* as follows:

Page 6-3, Article 605-7 APPLICATION RATES AND TEMPERATURES, replace this article, including Table 601-1, with the following:

Apply tack coat uniformly across the existing surface at target application rates shown in Table 605-1.

TABLE 605-1 APPLICATION RATES FOR TACK COAT	
Existing Surface	Target Rate (gal/sy)
	Emulsified Asphalt
New Asphalt	0.04 ± 0.01
Oxidized or Milled Asphalt	0.06 ± 0.01
Concrete	0.08 ± 0.01

Apply tack coat at a temperature within the ranges shown in Table 605-2. Tack coat shall not be overheated during storage, transport or at application.

TABLE 605-2 APPLICATION TEMPERATURE FOR TACK COAT	
Asphalt Material	Temperature Range
Asphalt Binder, Grade PG 64-22	350 - 400°F
Emulsified Asphalt, Grade RS-1H	130 - 160°F
Emulsified Asphalt, Grade CRS-1	130 - 160°F
Emulsified Asphalt, Grade CRS-1H	130 - 160°F
Emulsified Asphalt, Grade HFMS-1	130 - 160°F
Emulsified Asphalt, Grade CRS-2	130 - 160°F

Page 6-7, Article 609-3 FIELD VERIFICATION OF MIXTURE AND JOB MIX FORMULA ADJUSTMENTS, lines 35-37, delete the second sentence of the second paragraph.

Page 6-18, Article 610-1 DESCRIPTION, lines 40-41, delete the last sentence of the last paragraph.

Page 6-19, Subarticle 610-3(A) Mix Design-General, line 5, add the following as the first paragraph:

Warm mix asphalt (WMA) is allowed for use at the Contractor's option in accordance with the NCDOT Approved Products List for WMA Technologies available at:

<https://connect.ncdot.gov/resources/Materials/MaterialsResources/Warm%20Mix%20Asphalt%20Approved%20List.pdf>

Page 6-21, Subarticle 610-3(C) Job Mix Formula (JMF), replace Table 610-1 with the following:

TABLE 610-1 DESIGN MIXING TEMPERATURE AT THE ASPHALT PLANT^A		
Binder Grade	HMA JMF Temperature	WMA JMF Temperature Range
PG 64-22	300°F	225 - 275°F
PG 70-22	315°F	240 - 290°F
PG 76-22	335°F	260 - 310°F

A. The mix temperature, when checked in the truck at the roadway, shall be within plus 15° and minus 25° of the temperature specified on the JMF.

Page 6-21, Subarticle 610-3(C) Job Mix Formula (JMF), lines 4-6, delete first sentence of the second paragraph. Line 7, in the second sentence of the second paragraph, replace "275°F" with "275°F or greater."

Page 6-22, Article 610-4 WEATHER, TEMPERATURE AND SEASONAL LIMITATIONS FOR PRODUCING AND PLACING ASPHALT MIXTURES, lines 15-17, replace the second sentence of the first paragraph with the following:

Do not place asphalt material when the air or surface temperatures, measured at the location of the paving operation away from artificial heat, do not meet Table 610-5.

Page 6-23, Article 610-4 WEATHER, TEMPERATURE AND SEASONAL LIMITATIONS FOR PRODUCING AND PLACING ASPHALT MIXTURES, replace Table 610-5 with the following:

**TABLE 610-5
PLACEMENT TEMPERATURES FOR ASPHALT**

Asphalt Concrete Mix Type	Minimum Surface and Air Temperature
B25.0B, C	35°F
I19.0B, C, D	35°F
SF9.5A, S9.5B	40°F ^A
S9.5C, S12.5C	45°F ^A
S9.5D, S12.5D	50°F

A. For the final layer of surface mixes containing recycled asphalt shingles (RAS), the minimum surface and air temperature shall be 50°F.

Page 6-26, Article 610-7 HAULING OF ASPHALT MIXTURE, lines 22-23, in the fourth sentence of the first paragraph replace “so as to overlap the top of the truck bed and” with “to”.

Page 6-41, Subarticle 650-3(B) Mix Design Criteria, replace Table 650-1 with the following:

TABLE 650-1 OGAFC GRADATION CRITERIA			
<i>Sieve Size (mm)</i>	<i>Type FC-1</i>	<i>Type FC-1 Modified</i>	<i>Type FC-2 Modified</i>
19.0	-	-	100
12.5	100	100	80 - 100
9.50	75 - 100	75 - 100	55 - 80
4.75	25 - 45	25 - 45	15 - 30
2.36	5 - 15	5 - 15	5 - 15
0.075	1.0 - 3.0	1.0 - 3.0	2.0 - 4.0

ASPHALT BINDER CONTENT OF ASPHALT PLANT MIXES:

(11-21-00) (Rev. 7-17-12)

609

SP6 R15

The approximate asphalt binder content of the asphalt concrete plant mixtures used on this project will be as follows:

Asphalt Concrete Base Course	Type B 25.0	4.4%
Asphalt Concrete Intermediate Course	Type I 19.0	4.8%
Asphalt Concrete Surface Course	Type S 4.75A	6.8%
Asphalt Concrete Surface Course	Type SA-1	6.8%
Asphalt Concrete Surface Course	Type SF 9.5A	6.7%
Asphalt Concrete Surface Course	Type S 9.5	6.0%
Asphalt Concrete Surface Course	Type S 12.5	5.6%

The actual asphalt binder content will be established during construction by the Engineer within the limits established in the *2012 Standard Specifications*.

ASPHALT PLANT MIXTURES:

(7-1-95)

609

SP6 R20

Place asphalt concrete base course material in trench sections with asphalt pavement spreaders made for the purpose or with other equipment approved by the Engineer.

PRICE ADJUSTMENT - ASPHALT BINDER FOR PLANT MIX:

(11-21-00)

620

SP6 R25

Price adjustments for asphalt binder for plant mix will be made in accordance with Section 620 of the *2012 Standard Specifications*.

The base price index for asphalt binder for plant mix is \$ **473.08** per ton.

This base price index represents an average of F.O.B. selling prices of asphalt binder at supplier's terminals on **July 1, 2015**.

FINAL SURFACE TESTING NOT REQUIRED:

(5-18-04) (Rev. 5-15-12)

610

SP6 R45

Final surface testing is not required on this project.

8" X 6" TEMPORARY ASPHALT CURB:

The Contractor shall construct the asphalt curb in accordance with the detail in the plans and as directed by the Engineer.

The quantity of 8" x 6" *Temporary Asphalt Curb* to be paid for will be the actual number of linear feet of 8" x 6" *Temporary Asphalt Curb*, measured in place along the center of the curb. Such price and payment shall be full compensation for furnishing, hauling and placing all materials, disposal of surplus materials, furnishing all equipment, tools, labor, and incidentals necessary to complete the work.

GUARDRAIL ANCHOR UNITS, TYPE 350 (TL-3):

(4-20-04) (Rev. 7-21-15)

862

SP08 R065

Description

Furnish and install guardrail anchor units in accordance with the details in the plans, the applicable requirements of Section 862 of the *2012 Standard Specifications*, and at locations shown in the plans.

Materials

Furnish guardrail anchor units listed on the NCDOT [Approved Products List](https://apps.dot.state.nc.us/vendor/approvedproducts/) at <https://apps.dot.state.nc.us/vendor/approvedproducts/> or approved equal.

Prior to installation the Contractor shall submit to the Engineer:

- (A) FHWA acceptance letter for each guardrail anchor unit certifying it meets the requirements of NCHRP Report 350, Test Level 3, in accordance with Article 106-2 of the *2012 Standard Specifications*.
- (B) Certified working drawings and assembling instructions from the manufacturer for each guardrail anchor unit in accordance with Article 105-2 of the *2012 Standard Specifications*.

No modifications shall be made to the guardrail anchor unit without the express written permission from the manufacturer. Perform installation in accordance with the details in the plans, and details and assembling instructions furnished by the manufacturer.

Construction Methods

Guardrail end delineation is required on all approach and trailing end sections for both temporary and permanent installations. Guardrail end delineation consists of yellow reflective sheeting applied to the entire end section of the guardrail in accordance with Article 1088-3 of the *2012 Standard Specifications* and is incidental to the cost of the guardrail anchor unit.

Measurement and Payment

Measurement and payment will be made in accordance with Article 862-6 of the *2012 Standard Specifications*.

Payment will be made under:

Pay Item	Pay Unit
Guardrail Anchor Units, Type 350	Each

IMPACT ATTENUATOR UNITS, TYPE 350:

(4-20-04) (Rev. 7-21-15)

SP08 R075

Description

Furnish and install impact attenuator units and any components necessary to connect the impact attenuator units in accordance with the manufacturer's requirement, the details in the plans and at locations shown in the plans.

Materials

Furnish impact attenuator units listed on the Approved Products List at <https://apps.dot.state.nc.us/vendor/approvedproducts/> or approved equal. Prior to installation the Contractor shall submit to the Engineer:

- (A) FHWA acceptance letter for each impact attenuator unit certifying it meets the requirements of NCHRP Report 350, Test Level 3, in accordance with Article 106-2 of the *2012 Standard Specifications*.

- (B) Certified working drawings and assembling instructions from the manufacturer for each impact attenuator unit in accordance with Article 105-2 of the *2012 Standard Specifications*.

No modifications shall be made to the impact attenuator unit without the express written permission from the manufacturer. Perform installation in accordance with the details in the plans and details and assembling instructions furnished by the manufacturer.

Construction Methods

If the median width is 40 feet or less, the Contractor shall supply NON-GATING Impact Attenuator Units.

If the median width is greater than 40 feet, the Contractor may use GATING or NON-GATING Impact Attenuator Units.

Measurement and Payment

Impact Attenuator Unit, Type 350 will be measured and paid at the contract unit price per each. Such prices and payment will be full compensation for all work covered by this provision including, but not limited to, furnishing, installing and all incidentals necessary to complete the work.

Payment will be made under:

Pay Item	Pay Unit
Impact Attenuator Units, Type 350	Each

PEDESTRIAN SAFETY RAIL:

Description

Furnish and install pedestrian safety rail at the locations shown in the plans, in accordance with the detail in the plans and as directed by the Engineer.

Measurement and Payment

Pedestrian Safety Rail will be measured and paid for as the actual number of linear feet of safety rail measured along the top of the rail to the nearest 0.1 of a foot. Such price and payment shall be full compensation for fabricating, furnishing, installing, painting, footings and all incidentals necessary to satisfactorily construct the safety rail.

Payment will be made under:

Pay Item	Pay Unit
Pedestrian Safety Rail	Linear Foot

DARK GREEN VINYL COATED CHAIN LINK FENCE, 48" FABRIC:

(7-1-95) (Rev. 7-18-06)

SP8 R80(Rev)

Description

The work covered by this provision consists of constructing a dark green vinyl coated galvanized steel chain link fence mounted on steel posts in accordance with the *Standard Specifications*, plans, and these provisions and as directed by the Engineer. Apply the dark green vinyl coating over the galvanizing on the chain link fence fabric.

Materials

Provide steel pipe posts meeting the requirement of Subarticle 1050-3 of the *Standard Specifications* for steel pipe posts.

Provide vinyl coated chain link fabric that complies with the plans and Article 1050-6 of the *Standard Specifications*.

Provide vinyl coated fittings and accessories meeting the requirements of Article 1050-7 of the *Standard Specifications* except where otherwise required by the plans.

Provide vinyl coated tension wire, hog rings, and tie wire meeting the requirements of Article 1050-7 of the *Standard Specifications*.

Construction Methods

Erect the vinyl coated chain link fence as indicated on the plans, in accordance with the applicable provisions of Article 866-3 of the *Standard Specifications*, or as directed by the Engineer.

Measurement and Payment

Dark Green Vinyl Coated Chain Link Fence, 48" Fabric will be measured and paid for as the actual number of linear feet of vinyl coated chain link fence fabric, measured in place from center of end post to center of end posts, that has been completed and accepted. Such price and payment will be full compensation for all work covered by this provision including but not limited to furnishing and installing all posts, fittings, hardware, fabric, tie wires, and tension wire, and all other materials, labor, tools, equipment, and incidentals necessary to complete the work.

Payment will be made under:

Pay Item

Dark Green Vinyl Coated Chain Link Fence, 48" Fabric

Pay Unit

Linear Foot

CHAIN LINK FENCING WITH BARBED WIRE ON EXTENSION ARMS:

(7-1-95)

866

SP8 R100

Description

Provide 72" chain link fencing with barbed wire on extension arms in accordance with the plans, Section 866 of the *2012 Standard Specifications*, and the provisions herein.

Construction Methods

On all permanent 72" chain link fencing on this project, place three strands of barbed wire placed at the top of the fence fabric. Attach the barbed wire to extension arms that are to be fitted to the post tops.

Provide extension arms constructed to locate the top most strand of barbed wire approximately 12 inches above and approximately 12 inches out from the top rail. Space all strands of barbed wire at an approximately equal distance from each other. Make provisions for supporting the top rail. The arm shall make a 45 degree angle with the post, and be an item of standard manufacture. Have samples of extension arms to be used on the project approved prior to their installation.

Fabricate the extension arms from pressed steel or malleable wrought iron, or either of these materials in conjunction with a cast base. Provide a minimum weight of the arm material of 14 gauge. Provide a complete arm assembly of sufficient strength to support the barbed wire when stretched to proper tension. Galvanize all arms in accordance with ASTM A153.

Erect extension arms so as to point away from the pavement. Splicing of barbed wire between the arms will not be permitted. Use a method of attaching barbed wire to the arms acceptable to the Engineer.

Measurement and Payment

No direct payment will be made for furnishing and installing the barbed wire and extension arms as such work will be considered incidental to other work being paid by the various fencing items in the contract.

TEMPORARY 72" CHAIN LINK FENCE WITH POSTS:**Description**

Construct temporary 72" chain link fence in accordance with the plans, the *2012 Standard Specifications*, Roadway Standard Drawing No. 866.01, and as directed by the Engineer.

Materials

Refer to Article 866-2 of the *Standard Specifications*.

Construction Methods

Construct the temporary 72" chain link fence in accordance with the applicable requirements of Section 866 of the *2012 Standard Specifications*, Roadway Standard Drawing No. 866.01, and as directed by the Engineer. After the fence has served its purpose and is no longer needed, as determined by the Engineer, it will become the property of the Contractor and shall be removed.

Measurement and Payment

Temporary 72" Chain Link Fence With Posts will be measured and paid for as the actual number of linear feet of fence constructed and accepted, measured in place from center of end post to center of end post. All posts used for the chain link fence are included in the price of the fence and will not be paid for separately. Such price and payment will be full compensation for all materials, labor, fence maintenance, removal, and incidentals, necessary to satisfactorily complete the work.

Work includes, but is not limited to, clearing and grading; and furnishing and installing fence fabric, barbed wire, tie wires, tie rods, stretcher bars, top rails, tension wire, posts and post braces, concrete, fittings and any other materials, and removal of the fence.

Payment will be made under:

Pay Item	Pay Unit
Temporary 72" Chain Link Fence With Posts	Linear Foot

DETECTABLE WARNINGS FOR PROPOSED CURB RAMPS:

(6-15-10) (Rev. 8-16-11)

848

SP8 R126

Description

Construct detectable warnings consisting of integrated raised truncated domes on proposed concrete curb ramps in accordance with the *2012 Standard Specifications*, plan details, the requirements of the *28 CFR Part 36 ADA Standards for Accessible Design* and this provision.

Materials

Detectable warning for proposed curb ramps shall consist of integrated raised truncated domes. The description, size and spacing shall conform to Section 848 of the *2012 Standard Specifications*.

Use material for detectable warning systems as shown herein. Material and coating specifications must be stated in the Manufacturers Type 3 Certification and all Detectable Warning systems must be on the NCDOT Approved Products List.

Install detectable warnings created from one of the following materials: precast concrete blocks or bricks, clay paving brick, gray or ductile iron castings, mild steel, stainless steel, and

engineered plastics, rubber or composite tile. Only one material type for detectable warning will be permitted per project, unless otherwise approved by the Engineer.

- (A) Detectable Warnings shall consist of a base with integrated raised truncated domes, and when constructed of precast concrete they shall conform to the material requirements of Article 848-2 of the *2012 Standard Specifications*.
- (B) Detectable Warnings shall consist of a base with integrated raised truncated domes, and may be comprised of other materials including, but not limited, to clay paving brick, gray iron or ductile iron castings, mild steel, stainless steel, and engineered plastics, rubber or composite tile, which are cast into the concrete of the curb ramps. The material shall have an integral color throughout the thickness of the material. The detectable warning shall include fasteners or anchors for attachment in the concrete and shall be furnished as a system from the manufacturer.

Prior to installation, the Contractor shall submit to the Engineer assembling instructions from the manufacturer for each type of system used in accordance with Article 105-2 of the *2012 Standard Specifications*. The system shall be furnished as a kit containing all consumable materials and consumable tools, required for the application. They shall be capable of being affixed to or anchored in the concrete curb ramp, including green concrete (concrete that has set but not appreciably hardened). The system shall be solvent free and contain no volatile organic compounds (VOC). The static coefficient of friction shall be 0.8 or greater when measured on top of the truncated domes and when measured between the domes in accordance with ASTM C1028 (dry and wet). The system shall be resistant to deterioration due to exposure to sunlight, water, salt or adverse weather conditions and impervious to degradation by motor fuels, lubricants and antifreeze.

- (C) When steel or gray iron or ductile iron casting products are provided, only products that meet the requirements of Subarticle 106-1(B) of the *2012 Standard Specifications* may be used. Submit to the Engineer a Type 6 Certification, catalog cuts and installation procedures at least 30 days prior to installation for all.

Construction Methods

- (A) Prior to placing detectable warnings in proposed concrete curb ramps, adjust the existing subgrade to the proper grade and in accordance with Article 848-3 of the *2012 Standard Specifications*.
- (B) Install all detectable warning in proposed concrete curb ramps in accordance with the manufacturer's recommendations.

Measurement and Payment

Detectable Warnings installed for construction of proposed curb ramps will not be paid for separately. Such payment will be included in the price bid for *Concrete Curb Ramps*.

STREET SIGNS AND MARKERS AND ROUTE MARKERS:

(7-1-95)

900

SP9 R02

Move any existing street signs, markers, and route markers out of the construction limits of the project and install the street signs and markers and route markers so that they will be visible to the traveling public if there is sufficient right of way for these signs and markers outside of the construction limits.

Near the completion of the project and when so directed by the Engineer, move the signs and markers and install them in their proper location in regard to the finished pavement of the project.

Stockpile any signs or markers that cannot be relocated due to lack of right of way, or any signs and markers that will no longer be applicable after the construction of the project, at locations directed by the Engineer for removal by others.

The Contractor shall be responsible to the owners for any damage to any street signs and markers or route markers during the above described operations.

No direct payment will be made for relocating, reinstalling, and/or stockpiling the street signs and markers and route markers as such work shall be considered incidental to other work being paid for by the various items in the contract.

MATERIALS:

(2-21-12) (Rev. 5-19-15)

1000, 1002, 1005, 1018, 1024, 1050, 1056, 1074, 1078, 1080, 1081, 1086, 1084, 1087, 1092

SP10 R01

Revise the *2012 Standard Specifications* as follows:

Page 10-1, Article 1000-1, DESCRIPTION, lines 9-10, replace the last sentence of the first paragraph with the following:

Type IL, IP, IS or IT blended cement may be used instead of Portland cement.

Page 10-1, Article 1000-1, DESCRIPTION, line 14, add the following:

If any change is made to the mix design, submit a new mix design (with the exception of an approved pozzolan source change).

If any major change is made to the mix design, also submit new test results showing the mix design conforms to the criteria. Define a major change to the mix design as:

- (1) A source change in coarse aggregate, fine aggregate or cement.
- (2) A pozzolan class or type change (e.g. Class F fly ash to Class C fly ash).
- (3) A quantitative change in coarse aggregate (applies to an increase or decrease greater than 5%), fine aggregate (applies to an increase or decrease greater than 5%), water (applies to an increase only), cement (applies to a decrease only), or pozzolan (applies to an increase or decrease greater than 5%).

Use materials which do not produce a mottled appearance through rusting or other staining of the finished concrete surface.

Page 10-1, Article 1000-2, MATERIALS, line 16; Page 10-8, Subarticle 1000-7(A), Materials, line 8; and Page 10-18, Article 1002-2, MATERIALS, line 9, add the following to the table of item references:

Item	Section
Type IL Blended Cement	1024-1

Page 10-1, Subarticle 1000-3(A), Composition and Design, lines 25-27, replace the second paragraph with the following:

Fly ash may be substituted for cement in the mix design up to 30% at a rate of 1.0 lb of fly ash to each pound of cement replaced.

Page 10-2, Subarticle 1000-3(A), Composition and Design, lines 12-21, delete the third paragraph through the sixth paragraph beginning with “If any change is made to the mix design, submit...” through “...(applies to a decrease only).”

Page 10-5, Table 1000-1, REQUIREMENTS FOR CONCRETE, replace with the following:

TABLE 1000-1 REQUIREMENTS FOR CONCRETE											
Class of Concrete	Min. Comp. Strength at 28 days	Maximum Water-Cement Ratio				Consistency Max. Slump		Cement Content			
		Air-Entrained Concrete		Non Air-Entrained Concrete		Vibrated	Non-Vibrated	Vibrated		Non-Vibrated	
		Rounded Aggregate	Angular Aggregate	Rounded Aggregate	Angular Aggregate			Min.	Max.	Min.	Max.
Units	psi					inch	inch	lb/cy	lb/cy	lb/cy	lb/cy
AA	4,500	0.381	0.426	-	-	3.5	-	639	715	-	-
AA Slip Form	4,500	0.381	0.426	-	-	1.5	-	639	715	-	-
Drilled Pier	4,500	-	-	0.450	0.450	-	5-7 dry	-	-	640	800
A	3,000	0.488	0.532	0.550	0.594	3.5	7-9 wet	564	-	602	-
B	2,500	0.488	0.567	0.559	0.630	1.5 machine-placed 2.5 hand-placed	4	508	-	545	-
Sand Light-weight	4,500	-	0.420	-	-	4	-	715	-	-	-
Latex Modified	3,000 7 day	0.400	0.400	-	-	6	-	658	-	-	-
Flowable Fill excavatable	150 max. at 56 days	as needed	as needed	as needed	as needed	-	Flow-able	-	-	40	100
Flowable Fill non-excavatable	125	as needed	as needed	as needed	as needed	-	Flow-able	-	-	100	as needed
Pavement	4,500 design, field 650 flexural, design only	0.559	0.559	-	-	1.5 slip form 3.0 hand place	-	526	-	-	-
Precast	See Table 1077-1	as needed	as needed	-	-	6	as needed	as needed	as needed	as needed	as needed
Prestress	per contract	See Table 1078-1	See Table 1078-1	-	-	8	-	564	as needed	-	-

Page 10-6, Subarticle 1000-4(I), Use of Fly Ash, lines 36-2, replace the first paragraph with the following:

Fly ash may be substituted for cement in the mix design up to 30% at a rate of 1.0 lb of fly ash to each pound of cement replaced. Use Table 1000-1 to determine the maximum allowable water-cementitious material (cement + fly ash) ratio for the classes of concrete listed.

Page 10-7, Table 1000-3, MAXIMUM WATER-CEMENTITIOUS MATERIAL RATIO, delete the table.

Page 10-7, Article 1000-5, HIGH EARLY STRENGTH PORTLAND CEMENT CONCRETE, lines 30-31, delete the second sentence of the third paragraph.

Page 10-19, Article 1002-3, SHOTCRETE FOR TEMPORARY SUPPORT OF EXCAVATIONS, line 30, add the following at the end of Section 1002:

(H) Handling and Storing Test Panels

Notify the Area Materials Engineer when preconstruction or production test panels are made within 24 hours of shooting the panels. Field cure and protect test panels from damage in accordance with ASTM C1140 until the Department transports panels to the Materials and Tests Regional Laboratory for coring.

Page 10-23, Table 1005-1, AGGREGATE GRADATION-COARSE AGGREGATE, replace with the following:

**TABLE 1005-1
AGGREGATE GRADATION - COARSE AGGREGATE**

Std. Size #	Percentage of Total by Weight Passing													Remarks
	2"	1 1/2"	1"	3/4"	1/2"	3/8"	#4	#8	#10	#16	#40	#200		
4	100	90-100	20-55	0-15	-	0-5	-	-	-	-	-	-	A	Asphalt Plant Mix
	100	95-100	-	35-70	-	0-30	0-5	-	-	-	-	-	A	Asphalt Plant Mix
5	-	100	90-100	20-55	0-10	0-5	-	-	-	-	-	-	A	AST, Sediment Control Stone
	-	100	95-100	-	25-60	-	0-10	0-5	-	-	-	-	A	AST, Str. Concrete, Shoulder Drain, Sediment Control Stone
57M	-	100	95-100	-	25-45	-	0-10	0-5	-	-	-	-	A	AST, Concrete Pavement
	-	100	100	90-100	20-55	0-20	0-8	-	-	-	-	-	A	AST
67	-	-	100	90-100	-	20-55	0-10	0-5	-	-	-	-	A	AST, Str. Concrete, Asphalt Plant Mix
	-	-	-	100	98-100	75-100	20-45	0-15	-	-	-	-	A	Asphalt Plant Mix, AST, Str. Conc, Weep Hole Drains
14M	-	-	-	-	-	100	35-70	5-20	-	0-8	-	-	A	Asphalt Plant Mix, AST, Weep Hole Drains, Str. Concrete
	9	-	-	-	-	100	85-100	10-40	-	0-10	-	-	A	AST
ABC	-	100	75-97	-	55-80	-	35-55	-	25-45	-	14-30	4-12 ^B	-	Aggregate Base Course, Aggregate Stabilization
	ABC (M)	-	100	75-100	-	45-79	-	20-40	0-25	-	-	0-12 ^B	-	Maintenance Stabilization
Light-weight C	-	-	-	-	100	80-100	5-40	0-20	-	0-10	-	0-2.5	-	AST

A. See Subarticle 1005-4(A).
 B. See Subarticle 1005-4(B).
 C. For Lightweight Aggregate used in Structural Concrete, see Subarticle 1014-2(E)(6).

Page 10-40, Tables 1018-1 and 1018-2, PIEDMONT, WESTERN AND COASTAL AREA CRITERIA FOR ACCEPTANCE OF BORROW MATERIAL, under second column in both tables, replace second row with the following:

Acceptable, but not to be used in the top 3 ft of embankment or backfill

Page 10-46, Article 1024-1, PORTLAND CEMENT, line 33, add the following as the ninth paragraph:

Use Type IL blended cement that meets AASHTO M 240, except that the limestone content is limited to between 5 and 12% by weight and the constituents shall be interground. Class F fly ash can replace a portion of Type IL blended cement and shall be replaced as outlined in Subarticle 1000-4(I) for Portland cement. For mixes that contain cement with alkali content between 0.6% and 1.0% and for mixes that contain a reactive aggregate documented by the Department, use a pozzolan in the amount shown in Table 1024-1.

Page 10-46, Table 1024-1, POZZOLANS FOR USE IN PORTLAND CEMENT CONCRETE, replace with the following:

TABLE 1024-1 POZZOLANS FOR USE IN PORTLAND CEMENT CONCRETE	
Pozzolan	Rate
Class F Fly Ash	20% - 30% by weight of required cement content with 1.0 lb Class F fly ash per lb of cement replaced
Ground Granulated Blast Furnace Slag	35%-50% by weight of required cement content with 1.0 lb slag per lb of cement replaced
Microsilica	4%-8% by weight of required cement content with 1.0 lb microsilica per lb of cement replaced

Page 10-47, Subarticle 1024-3(B), Approved Sources, lines 16-18, replace the second sentence of the second paragraph with the following:

Tests shall be performed by AASHTO’s designated National Transportation Product Evaluation Program (NTPEP) laboratory for concrete admixture testing.

Page 10-65, Article 1050-1, GENERAL, line 41, replace the first sentence with the following:

All fencing material and accessories shall meet Section 106.

Page 10-73, Article 1056-1, DESCRIPTION, lines 7-8, delete the first sentence of the second paragraph and replace with the following:

Use geotextile fabrics that are on the NCDOT Approved Products List.

Page 10-73, Article 1056-2, HANDLING AND STORING, line 17, replace “mechanically stabilized earth (MSE) wall faces” with “temporary wall faces”.

Page 10-73, Article 1056-4, GEOTEXTILES, line 33, add the following after the first sentence in the second paragraph:

Geotextiles will be identified by the product name printed directly on the geotextile. When geotextiles are not marked with a product name or marked with only a manufacturing plant identification code, geotextiles will be identified by product labels attached to the geotextile wrapping. When identification is based on labels instead of markings, unwrap geotextiles just before use in the presence of the Engineer to confirm that the product labels on both ends of the outside of the geotextile outer wrapping match the labels affixed to both ends of the inside of the geotextile roll core. Partial geotextile roles without the product name printed on the geotextile or product labels affixed to the geotextile roll core may not be used.

Page 10-74, Table 1056-1, GEOTEXTILE REQUIREMENTS, replace with the following:

TABLE 1056-1 GEOTEXTILE REQUIREMENTS						
Property <i>Typical Application</i>	Requirement					Test Method
	Type 1 <i>Shoulder Drains</i>	Type 2 <i>Under Rip Rap</i>	Type 3 ^A <i>Temporary Silt Fence</i>	Type 4 <i>Soil Stabilization</i>	Type 5 ^B <i>Temporary Walls</i>	
Elongation (MD & CD)	≥ 50%	≥ 50%	≤ 25%	< 50%	< 50%	ASTM D4632
Grab Strength (MD & CD)			100 lb ^C			ASTM D4632
Tear Strength (MD & CD)	Table 1 ^D , Class 3	Table 1 ^D , Class 1	-	Table 1 ^D , Class 3	-	ASTM D4533
Puncture Strength			-			ASTM D6241
Ultimate Tensile Strength (MD & CD)	-	-	-	-	2,400 lb/ft ^C (unless required otherwise in the contract)	ASTM D4595
Permittivity	Table 2 ^D , 15% to 50% <i>in Situ</i> Soil				0.20 sec ^{-1,C}	ASTM D4491
Apparent Opening Size	Passing No. 200 ^E		Table 7 ^D	Table 5 ^D	0.60 mm ^F	ASTM D4751
UV Stability (Retained Strength)					70% ^{C, G}	ASTM D4355

- A. Minimum roll width of 36" required.
 B. Minimum roll width of 13 ft required.
 C. MARV per Article 1056-3.
 D. AASHTO M 288.
 E. US Sieve No. per AASHTO M 92.
 F. Maximum average roll value.
 G. After 500 hours of exposure.

Page 10-74, Article 1056-5, GEOCOMPOSITES, lines 7-8, replace the first sentence with the following:

Provide geocomposite drain strips with a width of at least 12" and Type 1 geotextiles attached to drainage cores that meet Table 1056-2.

Page 10-115, Subarticle 1074-7(B), Gray Iron Castings, lines 10-11, replace the first two sentences with the following:

Supply gray iron castings meeting all facets of AASHTO M 306 excluding proof load. Proof load testing will only be required for new casting designs during the design process, and conformance to M306 loading (40,000 lbs.) will be required only when noted on the design documents.

Page 10-126, Table 1078-1, REQUIREMENTS FOR CONCRETE, replace with the following:

Property	28 Day Design Compressive Strength 6,000 psi or less	28 Day Design Compressive Strength greater than 6,000 psi
Maximum Water/Cementitious Material Ratio	0.45	0.40
Maximum Slump without HRWR	3.5"	3.5"
Maximum Slump with HRWR	8"	8"
Air Content (upon discharge into forms)	5 + 2%	5 + 2%

Page 10-151, Article 1080-4, INSPECTION AND SAMPLING, lines 18-22, replace (B), (C) and (D) with the following:

- (B) At least 3 panels prepared as specified in 5.5.10 of AASHTO M 300, Bullet Hole Immersion Test.
- (C) At least 3 panels of 4"x6"x1/4" for the Elcometer Adhesion Pull Off Test, ASTM D4541.
- (D) A certified test report from an approved independent testing laboratory for the Salt Fog Resistance Test, Cyclic Weathering Resistance Test, and Bullet Hole Immersion Test as specified in AASHTO M 300.
- (E) A certified test report from an approved independent testing laboratory that the product has been tested for slip coefficient and meets AASHTO M253, Class B.

Page 10-161, Subarticle 1081-1(A), Classifications, lines 29-33, delete first 3 sentences of the description for Type 2 and replace with the following:

Type 2 - A low-modulus, general-purpose adhesive used in epoxy mortar repairs. It may be used to patch spalled, cracked or broken concrete where vibration, shock or expansion and contraction are expected.

Page 10-162, Subarticle 1081-1(A), Classifications, lines 4-7, delete the second and third sentences of the description for Type 3A. **Lines 16-22**, delete Types 6A, 6B and 6C.

Page 10-162, Subarticle 1081-1(B), Requirements, lines 26-30, replace the second paragraph with the following:

For epoxy resin systems used for embedding dowel bars, threaded rods, rebar, anchor bolts and other fixtures in hardened concrete, the manufacturer shall submit test results showing that the bonding system will obtain 125% of the specified required yield strength of the fixture. Furnish certification that, for the particular bolt grade, diameter and embedment depth required, the anchor system will not fail by adhesive failure and that there is no movement of the anchor bolt. For certification and anchorage, use 3,000 psi as the minimum Portland cement concrete compressive strength used in this test. Use adhesives that meet Section 1081.

List the properties of the adhesive on the container and include density, minimum and maximum temperature application, setting time, shelf life, pot life, shear strength and compressive strength.

Page 10-163, Table 1081-1, PROPERTIES OF MIXED EPOXY RESIN SYSTEMS, replace with the following:

Property	Type 1	Type 2	Type 3	Type 3A	Type 4A	Type 4B	Type 5
	Viscosity-Poises at 77°F ± 2°F	Gel	10-30	25-75	Gel	40-150	40-150
Spindle No.	-	3	4	--	4	4	2
Speed (RPM)	-	20	20	--	10	10	50
Pot Life (Minutes)	20-50	30-60	20-50	5-50	40-80	40-80	20-60
Minimum Tensile Strength at 7 days (psi)	1,500	2,000	4,000	4,000	1,500	1,500	4,000
Tensile Elongation at 7 days (%)	30 min.	30 min.	2-5	2-5	5-15	5-15	2-5
Min. Compressive Strength of 2" mortar cubes at 24 hours	3,000 (Neat)	4,000-	6,000-	6,000 (Neat)	3,000	3,000	6,000
Min. Compressive Strength of 2" mortar cubes at 7 days	5,000 (Neat)	-	-	-	-	5,000	-
Maximum Water Absorption (%)	1.5	1.0	1.0	1.5	1.0	1.0	1.0
Min. Bond Strength Slant Shear Test at 14 days (psi)	1,500	1,500	2,000	2,000	1,500	1,500	1,500

Page 10-164, Subarticle 1081-1(E), Prequalification, lines 31-33, replace the second sentence of the first paragraph with the following:

Manufacturers choosing to supply material for Department jobs must submit an application through the Value Management Unit with the following information for each type and brand name:

Page 10-164, Subarticle 1081-1(E)(3), line 37, replace with the following:

(3) Type of the material in accordance with Articles 1081-1 and 1081-4,

Page 10-165, Subarticle 1081-1(E)(6), line 1, in the first sentence of the first paragraph replace “AASHTO M 237” with “the specifications”.

Page 10-165, Subarticle 1081-1(E), Prequalification, line 9-10, delete the second sentence of the last paragraph.

Page 10-165, Subarticle 1081-1(F), Acceptance, line 14, in the first sentence of the first paragraph replace “Type 1” with “Type 3”.

Page 10-169, Subarticle 1081-3(G), Anchor Bolt Adhesives, delete this subarticle.

Page 10-170, Article 1081-3, HOT BITUMEN, line 9, add the following at the end of Section 1081:

1081-4 EPOXY RESIN ADHESIVE FOR BONDING TRAFFIC MARKINGS

(A) General

This section covers epoxy resin adhesive for bonding traffic markers to pavement surfaces.

(B) Classification

The types of epoxies and their uses are as shown below:

Type I – Rapid Setting, High Viscosity, Epoxy Adhesive. This type of adhesive provides rapid adherence to traffic markers to the surface of pavement.

Type II – Standard Setting, High Viscosity, Epoxy Adhesive. This type of adhesive is recommended for adherence of traffic markers to pavement surfaces when rapid set is not required.

Type III – Rapid Setting, Low Viscosity, Water Resistant, Epoxy Adhesive. This type of rapid setting adhesive, due to its low viscosity, is appropriate only for use with embedded traffic markers.

Type IV – Standard Set Epoxy for Blade Deflecting-Type Plowable Markers.

(C) Requirements

Epoxies shall conform to the requirements set forth in AASHTO M 237.

(D) Prequalification

Refer to Subarticle 1081-1(E).

(E) Acceptance

Refer to Subarticle 1081-1(F).

Page 10-173, Article 1084-2, STEEL SHEET PILES, lines 37-38, replace first paragraph with the following:

Steel sheet piles detailed for permanent applications shall be hot rolled and meet ASTM A572 or ASTM A690 unless otherwise required by the plans. Steel sheet piles shall be coated as required

by the plans. Galvanized sheet piles shall be coated in accordance with Section 1076. Metallized sheet piles shall be metallized in accordance to the Project Special Provision “Thermal Sprayed Coatings (Metallization)” with an 8 mil, 99.9% aluminum alloy coating and a 0.5 mil seal coating. Any portion of the metallized sheet piling encased in concrete shall receive a barrier coat. The barrier coat shall be an approved waterborne coating with a low-viscosity which readily absorbs into the pores of the aluminum thermal sprayed coating. The waterborne coating shall be applied at a spreading rate that results in a theoretical 1.5 mil dry film thickness. The manufacturer shall issue a letter of certification that the resin chemistry of the waterborne coating is compatible with the 99.9% aluminum thermal sprayed alloy and suitable for tidal water applications.

Page 10-174, Subarticle 1086-1(B)(1), Epoxy, lines 18-24, replace with the following:

The epoxy shall meet Article 1081-4.

The 2 types of epoxy adhesive which may be used are Type I, Rapid Setting, and Type II, Standard Setting. Use Type II when the pavement temperature is above 60°F or per the manufacturer’s recommendations whichever is more stringent. Use Type I when the pavement temperature is between 50°F and 60°F or per the manufacturer’s recommendations whichever is more stringent. Epoxy adhesive Type I, Cold Set, may be used to attach temporary pavement markers to the pavement surface when the pavement temperature is between 32°F and 50°F or per the manufacturer’s recommendations whichever is more stringent.

Page 10-175, Subarticle 1086-2(E), Epoxy Adhesives, line 27, replace “Section 1081” with “Article 1081-4”.

Page 10-177, Subarticle 1086-3(E), Epoxy Adhesives, line 22, replace “Section 1081” with “Article 1081-4”.

Page 10-179, Subarticle 1087-4(A), Composition, lines 39-41, replace the third paragraph with the following:

All intermixed and drop-on glass beads shall not contain more than 75 ppm arsenic or 200 ppm lead.

Page 10-180, Subarticle 1087-4(B), Physical Characteristics, line 8, replace the second paragraph with the following:

All intermixed and drop-on glass beads shall comply with NCGS § 136-30.2 and 23 USC § 109(r).

Page 10-181, Subarticle 1087-7(A), Intermixed and Drop-on Glass Beads, line 24, add the following after the first paragraph:

Use X-ray Fluorescence for the normal sampling procedure for intermixed and drop-on beads, without crushing, to check for any levels of arsenic and lead. If any arsenic or lead is detected, the sample shall be crushed and repeat the test using X-ray Fluorescence. If the X-ray Fluorescence test shows more than a LOD of 5 ppm, test the beads using United States Environmental Protection Agency Method 6010B, 6010C or 3052 for no more than 75 ppm arsenic or 200 ppm lead.

Page 10-204, Table 1092-3 MINIMUM COEFFICIENT OF RETROREFLECTION FOR NC GRADE A, replace with the following:

TABLE 1092-3 MINIMUM COEFFICIENT OF RETROREFLECTION FOR NC GRADE A (Candelas Per Lux Per Square Meter)								
Observation Angle, degrees	Entrance Angle, degrees	White	Yellow	Green	Red	Blue	Fluorescent Yellow Green	Fluorescent Yellow
0.2	-4.0	525	395	52	95	30	420	315
0.2	30.0	215	162	22	43	10	170	130
0.5	-4.0	310	230	31	56	18	245	185
0.5	30.0	135	100	14	27	6	110	81
1.0	-4.0	120	60	8	16	3.6	64	48
1.0	30.0	45	34	4.5	9	2	36	27

HIGH STRENGTH CONCRETE FOR DRIVEWAYS:

(11-21-00) (Rev. 1-17-12)

848

SP10 R02

Use high early strength concrete for all driveways shown in the plans and as directed by the Engineer. Provide high early strength concrete that meets the requirements of Article 1000-5 of the *2012 Standard Specifications*.

Measurement and payment will be in accordance with Section 848 of the *2012 Standard Specifications*.

SELECT MATERIAL, CLASS III, TYPE 3:

(1-17-12)

1016, 1044

SP10 R05

Revise the *2012 Standard Specifications* as follows:

Page 10-39, Article 1016-3, CLASS III, add the following after line 14:

Type 3 Select Material

Type 3 select material is a natural or manufactured fine aggregate material meeting the following gradation requirements and as described in Sections 1005 and 1006:

		Percentage of Total by Weight Passing					
3/8"	#4	#8	#16	#30	#50	#100	#200
100	95-100	65-100	35-95	15-75	5-35	0-25	0-8

Page 10-39, Article 1016-3, CLASS III, line 15, replace “either type” with “Type 1, Type 2 or Type 3”.

Page 10-62, Article 1044-1, line 36, delete the sentence and replace with the following:

Subdrain fine aggregate shall meet Class III select material, Type 1 or Type 3.

Page 10-63, Article 1044-2, line 2, delete the sentence and replace with the following:

Subdrain coarse aggregate shall meet Class V select material.

SHOULDER AND SLOPE BORROW:

(3-19-13)

1019

SP10 R10

Use soil in accordance with Section 1019 of the *2012 Standard Specifications*. Use soil consisting of loose, friable, sandy material with a PI greater than 6 and less than 25 and a pH ranging from 5.5 to 7.0.

Soil with a pH ranging from 4.0 to 5.5 will be accepted without further testing if additional limestone is provided in accordance with the application rates shown in Table 1019-1A. Soil type is identified during the soil analysis. Soils with a pH above 7.0 require acidic amendments to be added. Submit proposed acidic amendments to the Engineer for review and approval. Soils with a pH below 4.0 or that do not meet the PI requirements shall not be used.

pH TEST RESULT	Sandy Soils Additional Rate (lbs. / Acre)	Silt Loam Soils Additional Rate (lbs. / Acre)	Clay Loam Soils Additional Rate (lbs. / Acre)
4.0 - 4.4	1,000	4,000	6,000
4.5 - 4.9	500	3,000	5,000
5.0 - 5.4	NA	2,000	4,000

Note: Limestone application rates shown in this table are in addition to the standard rate of 4000 lbs. / acre required for seeding and mulching.

No direct payment will be made for providing additional lime or acidic amendments for Ph adjustment.

GROUT PRODUCTION AND DELIVERY:

(3-17-15)

1003

SP10 R20

Revise the *2012 Standard Specifications* as follows:

Replace Section 1003 with the following:

**SECTION 1003
GROUT PRODUCTION AND DELIVERY**

1003-1 DESCRIPTION

This section addresses cement grout to be used for structures, foundations, retaining walls, concrete barriers, embankments, pavements and other applications in accordance with the contract. Produce non-metallic grout composed of Portland cement and water and at the

Contractor's option or as required, aggregate and pozzolans. Include chemical admixtures as required or needed. Provide sand cement or neat cement grout as required. Define "sand cement grout" as grout with only fine aggregate and "neat cement grout" as grout without aggregate.

The types of grout with their typical uses are as shown below:

Type 1 – A cement grout with only a 3-day strength requirement and a fluid consistency that is typically used for filling subsurface voids.

Type 2 – A nonshrink grout with strength, height change and flow conforming to ASTM C1107 that is typically used for foundations, ground anchors and soil nails.

Type 3 – A nonshrink grout with high early strength and freeze-thaw durability requirements that is typically used in pile blockouts, grout pockets, shear keys, dowel holes and recesses for concrete barriers and structures.

Type 4 – A neat cement grout with low strength, a fluid consistency and high fly ash content that is typically used for slab jacking.

Type 5 – A low slump, low mobility sand cement grout with minimal strength that is typically used for compaction grouting.

1003-2 MATERIALS

Refer to Division 10.

Item	Section
Chemical Admixtures	1024-3
Fine Aggregate	1014-1
Fly Ash	1024-5
Ground Granulated Blast Furnace Slag	1024-6
Portland Cement	1024-1
Silica Fume	1024-7
Water	1024-4

Do not use grout that contains soluble chlorides or more than 1% soluble sulfate. At the Contractor's option, use an approved packaged grout instead of the materials above except for water. Use packaged grouts that are on the NCDOT Approved Products List.

Use admixtures for grout that are on the NCDOT Approved Products List or other admixtures in accordance with Subarticle 1024-3(E) except do not use concrete additives or unclassified or other admixtures in Type 4 or 5 grout. Use Class F fly ash for Type 4 grout and Type II Portland cement for Type 5 grout.

Use well graded rounded aggregate with a gradation, liquid limit (LL) and plasticity index (PI) that meet Table 1003-1 for Type 5 grout. Fly ash may be substituted for a portion of the fines in the aggregate. Do not use any other pozzolans in Type 5 grout.

**TABLE 1003-1
AGGREGATE REQUIREMENTS FOR TYPE 5 GROUT**

Sieve Designation per AASHTO M 92	Gradation Percentage Passing (% by weight)	Maximum Liquid Limit	Maximum Plasticity Index
3/8"	100		
No. 4	70 – 95		
No. 8	50 – 90		
No. 16	30 – 80	N/A	N/A
No. 30	25 – 70		
No. 50	20 – 50		
No. 100	15 – 40		
No. 200	10 – 30	25	10

1003-3 COMPOSITION AND DESIGN

When using an approved packaged grout, a grout mix design submittal is not required. Otherwise, submit proposed grout mix designs for each grout mix to be used in the work. Mixes for all grout shall be designed by a Certified Concrete Mix Design Technician or an Engineer licensed by the State of North Carolina. Mix proportions shall be determined by a testing laboratory approved by the Department. Base grout mix designs on laboratory trial batches that meet Table 1003-2 and this section. With permission, the Contractor may use a quantity of chemical admixture within the range shown on the current list of approved admixtures maintained by the Materials and Tests Unit.

Submit grout mix designs in terms of saturated surface dry weights on Materials and Tests Form 312U at least 35 days before proposed use. Adjust batch proportions to compensate for surface moisture contained in the aggregates at the time of batching. Changes in the saturated surface dry mix proportions will not be permitted unless revised grout mix designs have been submitted to the Engineer and approved.

Accompany Materials and Tests Form 312U with a listing of laboratory test results of compressive strength, density and flow or slump and if applicable, aggregate gradation, durability and height change. List the compressive strength of at least three 2" cubes at the age of 3 and 28 days.

The Engineer will review the grout mix design for compliance with the contract and notify the Contractor as to its acceptability. Do not use a grout mix until written notice has been received. Acceptance of the grout mix design or use of approved packaged grouts does not relieve the Contractor of his responsibility to furnish a product that meets

the contract. Upon written request from the Contractor, a grout mix design accepted and used satisfactorily on any Department project may be accepted for use on other projects.

Perform laboratory tests in accordance with the following test procedures:

Property	Test Method
Aggregate Gradation ^A	AASHTO T 27
Compressive Strength	AASHTO T 106
Density (Unit Weight)	AASHTO T 121, AASHTO T 133 ^B , ANSI/API RP ^C 13B-1 ^B (Section 4, Mud Balance)
Durability	AASHTO T 161 ^D
Flow	ASTM C939 (Flow Cone)
Height Change	ASTM C1090 ^E
Slump	AASHTO T 119

A. Applicable to grout with aggregate.

B. Applicable to Neat Cement Grout.

C. American National Standards Institute/American Petroleum Institute Recommended Practice.

D. Procedure A (Rapid Freezing and Thawing in Water) required.

E. Moist room storage required.

1003-4 GROUT REQUIREMENTS

Provide grout types in accordance with the contract. Use grouts with properties that meet Table 1003-2. The compressive strength of the grout will be considered the average compressive strength test results of three 2" cubes at each age. Make cubes that meet AASHTO T 106 from the grout delivered for the work or mixed on-site. Make cubes at such frequencies as the Engineer may determine and cure them in accordance with AASHTO T 106.

**TABLE 1003-2
GROUT REQUIREMENTS**

Type of Grout	Minimum Compressive Strength at		Height Change at 28 days	Flow ^A /Slump ^B	Minimum Durability Factor
	3 days	28 days			
1	3,000 psi	—	—	10 – 30 sec	—
2		Table 1 ^C		Fluid Consistency ^C	—
3	5,000 psi	—	0 – 0.2%	Per Accepted Grout Mix Design/ Approved Packaged Grout	80
4 ^D	600 psi	1,500 psi	—	10 – 26 sec	—
5	—	500 psi	—	1 – 3"	—

A. Applicable to Type 1 through 4 grouts.

B. Applicable to Type 5 grout.

C. ASTM C1107.

D. Use Type 4 grout with proportions by volume of 1 part cement and 3 parts fly ash.

1003-5 TEMPERATURE REQUIREMENTS

When using an approved packaged grout, follow the manufacturer's instructions for grout and air temperature at the time of placement. Otherwise, the grout temperature at the time of placement shall be not less than 50°F nor more than 90°F. Do not place grout when the air temperature measured at the location of the grouting operation in the shade away from artificial heat is below 40°F.

1003-6 ELAPSED TIME FOR PLACING GROUT

Agitate grout continuously before placement. Regulate the delivery so the maximum interval between the placing of batches at the work site does not exceed 20 minutes. Place grout before exceeding the times in Table 1003-3. Measure the elapsed time as the time between adding the mixing water to the grout mix and placing the grout.

**TABLE 1003-3
ELAPSED TIME FOR PLACING GROUT
(with continuous agitation)**

Air or Grout Temperature, Whichever is Higher	Maximum Elapsed Time	
	No Retarding Admixture Used	Retarding Admixture Used
90°F or above	30 minutes	1 hr. 15 minutes
80°F through 89°F	45 minutes	1 hr. 30 minutes
79°F or below	60 minutes	1 hr. 45 minutes

1003-7 MIXING AND DELIVERY

Use grout free of any lumps and undispersed cement. When using an approved packaged grout, mix grout in accordance with the manufacturer's instructions. Otherwise, comply with Articles 1000-8 through 1000-12 to the extent applicable for grout instead of concrete.

TEMPORARY SHORING:

(2-20-07) (Rev. 3-17-15)

SP11 R02

Description

Temporary shoring includes cantilever, braced and anchored shoring and temporary mechanically stabilized earth (MSE) walls. Temporary shoring does not include trench boxes. At the Contractor's option, use any type of temporary shoring unless noted otherwise in the plans or as directed. Design and construct temporary shoring based on actual elevations and shoring dimensions in accordance with the contract and accepted submittals. Construct temporary shoring at locations shown in the plans and as directed. Temporary shoring is required to maintain traffic when a 2:1 (H:V) slope from the top of an embankment or bottom of an excavation will intersect the existing ground line less than 5 ft from the edge of pavement of an open travelway. This provision does not apply to pipe, inlet or utility installation unless noted otherwise in the plans.

Positive protection includes concrete barrier and temporary guardrail. Provide positive protection for temporary shoring at locations shown in the plans and as directed. Positive protection is required if temporary shoring is located in the clear zone in accordance with the *AASHTO Roadside Design Guide*.

(A) Cantilever and Braced Shoring

Cantilever shoring consists of steel sheet piles or H-piles with timber lagging. Braced shoring consists of sheet piles or H-piles with timber lagging and bracing such as beams, plates, walers, struts, rakers, etc. Define "piles" as sheet piles or H-piles.

(B) Anchored Shoring

Anchored shoring consists of sheet piles with walers or H-piles with timber lagging anchored with ground or helical anchors. Driven anchors may be accepted at the discretion of the Engineer. A ground anchor consists of a grouted steel bar or multi-strand tendon with an anchorage. A helical anchor consists of a lead section with a central steel shaft and at least one helix steel plate followed by extensions with only central shafts (no helixes) and an anchorage. Anchorages consist of steel bearing plates with washers and hex nuts for bars or steel wedge plates and wedges for strands. Use a prequalified Anchored Wall Contractor to install ground anchors. Define "anchors" as ground, helical or driven anchors.

(C) Temporary MSE Walls

Temporary MSE walls include temporary geosynthetic and wire walls. Define “temporary wall” as a temporary MSE wall. Define “reinforcement” as geotextile, geogrid, welded wire grid or metallic strip reinforcement.

Temporary geosynthetic walls consist of geotextile or geogrid reinforcement wrapped behind welded wire facing. Define “temporary geotextile wall” as a temporary geosynthetic wall with geotextile reinforcement and “temporary geogrid wall” as a temporary geosynthetic wall with geogrid reinforcement.

Temporary wire walls consist of welded wire grid or metallic strip reinforcement connected to welded wire facing. Define “Wire Wall Vendor” as the vendor supplying the temporary wire wall.

(D) Embedment

Define “embedment” for cantilever, braced and anchored shoring as the pile depth below the grade in front of shoring. Define “embedment” for temporary walls as the wall height below the grade in front of walls.

(E) Positive Protection

Define “unanchored or anchored portable concrete barrier” as portable concrete barrier (PCB) that meets Standard Drawing No. 1170.01 of the *2012 Roadway Standard Drawings*. Define “concrete barrier” as unanchored or anchored PCB or an approved equal. Define “temporary guardrail” as temporary steel beam guardrail that meets Standard Drawing No. 862.02 of the *2012 Roadway Standard Drawings*.

Materials

Refer to the *2012 Standard Specifications*.

Item	Section
Anchor Pins	1056-2
Concrete Barrier Materials	1170-2
Flowable Fill, Excavatable	1000-6
Geotextiles	1056
Grout	1003
Portland Cement Concrete	1000
Select Material	1016
Steel Beam Guardrail Materials	862-2
Steel Plates	1072-2
Steel Sheet Piles and H-Piles	1084
Untreated Timber	1082-2
Welded Wire Reinforcement	1070-3

Item

Wire Staples

Section

1060-8(D)

Provide Type 6 material certifications for shoring materials in accordance with Article 106-3 of the *2012 Standard Specifications*. Use Class IV select material (standard size No. ABC) for temporary guardrail. Use neat cement grout for Type 2 grout for ground anchors. Use Class A concrete that meets Article 450-2 of the *2012 Standard Specifications* or Type 1 grout for drilled-in piles. Provide untreated timber with a thickness of at least 3" and a bending stress of at least 1,000 psi for timber lagging. Provide steel bracing that meets ASTM A36.

(A) Shoring Backfill

Use Class II, Type 1, Class III, Class V or Class VI select material or material that meets AASHTO M 145 for soil classification A-2-4 with a maximum PI of 6 for shoring backfill except do not use A-2-4 soil for backfill around culverts.

(B) Anchors

Store anchor materials on blocking a minimum of 12" above the ground and protect it at all times from damage; and when placing in the work make sure it is free from dirt, dust, loose mill scale, loose rust, paint, oil or other foreign materials. Load, transport, unload and store anchor materials so materials are kept clean and free of damage. Bent, damaged or defective materials will be rejected.

(1) Ground Anchors

Use high-strength deformed steel bars that meet AASHTO M 275 or seven-wire strands that meet ASTM A886 or Article 1070-5 of the *2012 Standard Specifications*. Splice bars in accordance with Article 1070-9 of the *2012 Standard Specifications*. Do not splice strands. Use bondbreakers, spacers and centralizers that meet Article 6.3.5 of the *AASHTO LRFD Bridge Construction Specifications*.

(2) Helical Anchors

Use helical anchors with an ICC Evaluation Service, Inc. (ICC-ES) report. Helical anchors without an ICC-ES report may be approved at the discretion of the Engineer. Provide couplers, thread bar adapters and bolts recommended by the Anchor Manufacturer to connect helical anchors together and to piles.

(3) Anchorages

Provide steel plates for bearing plates and steel washers, hex nuts, wedge plates and wedges recommended by the Anchor Manufacturer.

(C) Temporary Walls

(1) Welded Wire Facing

Use welded wire reinforcement for welded wire facing, struts and wires. For temporary wire walls, provide welded wire facing supplied by the Wire Wall Vendor or a manufacturer approved or licensed by the vendor. For temporary wire walls with separate reinforcement and facing components, provide connectors (e.g., bars, clamps, plates, etc.) and fasteners (e.g., bolts, nuts, washers, etc.) required by the Wire Wall Vendor.

(2) Geotextiles

Provide Type 2 geotextile for separation and retention geotextiles. Provide Type 5 geotextile for geotextile reinforcement with ultimate tensile strengths in accordance with the accepted submittals.

(3) Geogrid Reinforcement

Handle and store geogrids in accordance with Article 1056-2 of the *2012 Standard Specifications*. Define “machine direction” (MD) and “cross-machine direction” (CD) for geogrids in accordance with ASTM D4439.

Use geogrids with a roll width of at least 4 ft and an “approved” or “approved for provisional use” status code. The list of approved geogrids is available from: connect.ncdot.gov/resources/Materials/Pages/SoilsLaboratory.aspx

Provide geogrids for geogrid reinforcement with design strengths in accordance with the accepted submittals. Geogrids are typically approved for ultimate tensile strengths in the MD and CD or short-term design strengths for a 3-year design life in the MD based on material type. Define material type from the website above for shoring backfill as follows:

Material Type	Shoring Backfill
Borrow	A-2-4 Soil
Fine Aggregate	Class II, Type 1 or Class III Select Material
Coarse Aggregate	Class V or VI Select Material

(4) Welded Wire Grid and Metallic Strip Reinforcement

Provide welded wire grid and metallic strip reinforcement supplied by the Wire Wall Vendor or a manufacturer approved or licensed by the vendor. Use welded wire grid reinforcement (“mesh”, “mats” and “ladders”) that meet Article 1070-3 of the *2012 Standard Specifications* and metallic strip reinforcement (“straps”) that meet ASTM A572 or A1011.

Preconstruction Requirements

(A) Concrete Barrier

Define “clear distance” behind concrete barrier as the horizontal distance between the barrier and edge of pavement. The minimum required clear distance for concrete barrier is shown in the plans. At the Contractor’s option or if the minimum required clear distance is not available, set concrete barrier next to and up against traffic side of temporary shoring except for barrier above temporary walls. Concrete barrier with the minimum required clear distance is required above temporary walls.

(B) Temporary Guardrail

Define “clear distance” behind temporary guardrail as the horizontal distance between guardrail posts and temporary shoring. At the Contractor’s option or if clear distance for cantilever, braced and anchored shoring is less than 4 ft, attach guardrail to traffic side of shoring as shown in the plans. Place ABC in clear distance and around guardrail posts instead of pavement. Do not use temporary guardrail above temporary walls.

(C) Temporary Shoring Designs

Before beginning temporary shoring design, survey existing ground elevations in the vicinity of shoring locations to determine actual design heights (H). Submit 8 copies of working drawings and 3 copies of design calculations and a PDF copy of each for temporary shoring designs in accordance with Article 105-2 of the *2012 Standard Specifications*. Submit working drawings showing plan views, shoring profiles, typical sections and details of temporary shoring design and construction sequence. Do not begin shoring construction until a design submittal is accepted.

Have cantilever and braced shoring designed, detailed and sealed by an engineer licensed in the state of North Carolina. Use a prequalified Anchored Wall Design Consultant to design anchored shoring. Provide anchored shoring designs sealed by a Design Engineer approved as a Geotechnical Engineer (key person) for an Anchored Wall Design Consultant. Include details in anchored shoring working drawings of anchor locations and lock-off loads, unit grout/ground bond strengths for ground anchors or minimum installation torque and torsional strength rating for helical anchors and if necessary, obstructions extending through shoring or interfering with anchors. Include details in the anchored shoring construction sequence of pile and anchor installation, excavation and anchor testing.

Use a prequalified MSE Wall Design Consultant to design temporary walls. Provide temporary wall designs sealed by a Design Engineer approved as a Geotechnical Engineer (key person) for the MSE Wall Design Consultant. Include details in temporary wall working drawings of geotextile and reinforcement types, locations and directions and obstructions extending through walls or interfering with reinforcement.

(1) Soil Parameters

Design temporary shoring for the assumed soil parameters and groundwater elevations shown in the plans. Assume the following soil parameters for shoring backfill:

(a) Unit weight (γ) = 120 lb/cf;

(b) **Friction Angle (ϕ)**

30°

34°

38°

(c) Cohesion (c) = 0 lb/sf.

Shoring Backfill	
	A-2-4 Soil
	Class II, Type 1 or Class III Select Material
	Class V or VI Select Material

(2) Traffic Surcharge

Design temporary shoring for a traffic surcharge of 250 lb/sf if traffic will be above and within H of shoring. This traffic surcharge does not apply to construction traffic. Design temporary shoring for any construction surcharge if construction traffic will be above and within H of shoring. For LRFD shoring designs, apply traffic (live load) surcharge in accordance with Figure C11.5.5-3 of the *AASHTO LRFD Bridge Design Specifications*.

(3) Cantilever, Braced and Anchored Shoring Designs

Use shoring backfill for fill sections and voids between cantilever, braced and anchored shoring and the critical failure surface. Use concrete or grout for embedded portions of drilled-in H-piles. Do not use drilled-in sheet piles.

Define “top of shoring” for cantilever, braced and anchored shoring as where the grade intersects the back of sheet piles or H-piles and timber lagging. Design cantilever, braced and anchored shoring for a traffic impact load of 2,000 lb/ft applied 18" above top of shoring if concrete barrier is above and next to shoring or temporary guardrail is above and attached to shoring. For anchored shoring designs, apply traffic impact load as horizontal load (P_{H1}) in accordance with Figure 3.11.6.3-2(a) of the *AASHTO LRFD specifications*.

Extend cantilever, braced and anchored shoring at least 32" above top of shoring if shoring is designed for traffic impact. Otherwise, extend shoring at least 6" above top of shoring.

Design cantilever, braced and anchored shoring for a maximum deflection of 3" if the horizontal distance to the closest edge of pavement or structure is less than H. Otherwise, design shoring for a maximum deflection of 6". Design cantilever and braced shoring in accordance with the plans and *AASHTO Guide Design Specifications for Bridge Temporary Works*.

Design anchored shoring in accordance with the plans and Article 11.9 of the *AASHTO LRFD Bridge Design Specifications*. Use a resistance factor of 0.80 for tensile resistance of anchors with bars, strands or shafts. Extend the unbonded length for ground anchors and the shallowest helix for helical anchors at least 5 ft behind the critical failure surface. Do not extend anchors beyond right-of-way or easement limits. If existing or future obstructions such as foundations, guardrail posts, pavements, pipes, inlets or utilities will interfere with anchors, maintain a clearance of at least 6" between obstructions and anchors.

(4) Temporary Wall Designs

Use shoring backfill in the reinforced zone of temporary walls. Separation geotextiles are required between shoring backfill and backfill, natural ground or culverts along the sides of the reinforced zone perpendicular to the wall face. For Class V or VI select material in the reinforced zone, separation geotextiles are also required between shoring backfill and backfill or natural ground on top of and at the back of the reinforced zone.

Design temporary walls in accordance with the plans and Article 11.10 of the *AASHTO LRFD Bridge Design Specifications*. Embed temporary walls at least 18" except for walls on structures or rock as determined by the Engineer. Use a uniform reinforcement length throughout the wall height of at least 0.7H or 6 ft, whichever is longer. Extend the reinforced zone at least 6" beyond end of reinforcement. Do not locate the reinforced zone outside right-of-way or easement limits.

Use the simplified method for determining maximum reinforcement loads in accordance with the AASHTO LRFD specifications. For geotextile reinforcement, use geotextile properties approved by the Department or default values in accordance with the AASHTO LRFD specifications. For geogrid reinforcement, use approved geogrid properties available from the website shown elsewhere in this provision. If the website does not list a short-term design strength for an approved geogrid, use a short-term design strength equal to the ultimate tensile strength divided by 3.5 for the geogrid reinforcement. Use geosynthetic properties for the direction reinforcement will be installed, a 3-year design life and shoring backfill to be used in the reinforced zone.

Do not use more than 4 different reinforcement strengths for each temporary geosynthetic wall. Design temporary geotextile walls for a reinforcement coverage ratio (R_c) of 1.0 and temporary geogrid walls for an R_c of at least 0.8. For geogrid reinforcement with an R_c of less than 1.0, use a maximum horizontal clearance between geogrids of 3 ft and stagger reinforcement so geogrids are centered over gaps in the reinforcement layer below.

For temporary geosynthetic walls, use "L" shaped welded wire facing with 18" to 24" long legs. Locate geotextile or geogrid reinforcement so reinforcement layers

are at the same level as the horizontal legs of welded wire facing. Use vertical reinforcement spacing equal to facing height. Wrap geotextile or geogrid reinforcement behind welded wire facing and extend reinforcement at least 3 ft back behind facing into shoring backfill.

For temporary wire walls with separate reinforcement and facing components, attach welded wire grid or metallic strip reinforcement to welded wire facing with a connection approved by the Department. For temporary geogrid and wire walls, retain shoring backfill at welded wire facing with retention geotextiles and extend geotextiles at least 3 ft back behind facing into backfill.

(D) Preconstruction Meeting

The Engineer may require a shoring preconstruction meeting to discuss the construction, inspection and testing of the temporary shoring. If required and if this meeting occurs before all shoring submittals have been accepted, additional preconstruction meetings may be required before beginning construction of temporary shoring without accepted submittals. The Resident, District or Bridge Maintenance Engineer, Bridge or Roadway Construction Engineer, Geotechnical Operations Engineer, Contractor and Shoring Contractor Superintendent will attend preconstruction meetings.

Construction Methods

Control drainage during construction in the vicinity of shoring. Direct run off away from shoring and shoring backfill. Contain and maintain backfill and protect material from erosion.

Install positive protection in accordance with the contract and accepted submittals. Use PCB in accordance with Section 1170 of the *2012 Standard Specifications* and Standard Drawing No. 1170.01 of the *2012 Roadway Standard Drawings*. Use temporary guardrail in accordance with Section 862 of the *2012 Standard Specifications* and Standard Drawing No. 862.01, 862.02 and 862.03 of the *2012 Roadway Standard Drawings*.

(A) Tolerances

Construct shoring with the following tolerances:

- (1) Horizontal wires of welded wire facing are level in all directions,
- (2) Shoring location is within 6" of horizontal and vertical alignment shown in the accepted submittals, and
- (3) Shoring plumbness (batter) is not negative and within 2° of vertical.

(B) Cantilever, Braced and Anchored Shoring Installation

If overexcavation behind cantilever, braced or anchored shoring is shown in the accepted submittals, excavate before installing piles. Otherwise, install piles before excavating for shoring. Install cantilever, braced or anchored shoring in accordance with the construction sequence shown in the accepted submittals. Remove piles and if applicable, timber lagging when shoring is no longer needed.

(1) Pile Installation

Install piles with the minimum required embedment and extension in accordance with Subarticles 450-3(D) and 450-3(E) of the *2012 Standard Specifications* except that a pile driving equipment data form is not required. Piles may be installed with a vibratory hammer as approved by the Engineer.

Do not splice sheet piles. Use pile excavation to install drilled-in H-piles. After filling holes with concrete or grout to the elevations shown in the accepted submittals, remove any fluids and fill remaining portions of holes with flowable fill. Cure concrete or grout at least 7 days before excavating.

Notify the Engineer if refusal is reached before pile excavation or driven piles attain the minimum required embedment. When this occurs, a revised design submittal may be required.

(2) Excavation

Excavate in front of piles from the top down in accordance with the accepted submittals. For H-piles with timber lagging and braced and anchored shoring, excavate in staged horizontal lifts with a maximum height of 5 ft. Remove flowable fill and material in between H-piles as needed to install timber lagging. Position lagging with at least 3" of contact in the horizontal direction between the lagging and pile flanges. Do not excavate the next lift until timber lagging for the current lift is installed and if applicable, bracing and anchors for the current lift are accepted. Backfill behind cantilever, braced or anchored shoring with shoring backfill.

(3) Anchor Installation

If applicable, install foundations located behind anchored shoring before installing anchors. Fabricate and install ground anchors in accordance with the accepted submittals, Articles 6.4 and 6.5 of the *AASHTO LRFD Bridge Construction Specifications* and the following unless otherwise approved:

- (a) Materials in accordance with this provision are required instead of materials conforming to Articles 6.4 and 6.5.3 of the AASHTO LRFD Specifications,
- (b) Encapsulation-protected ground anchors in accordance with Article 6.4.1.2 of the AASHTO LRFD specifications are not required, and
- (c) Corrosion protection for unbonded lengths of ground anchors and anchorage covers are not required.
- (d) Measure grout temperature, density and flow during grouting with at least the same frequency grout cubes are made for compressive strength. Perform density and flow field tests in the presence of the Engineer in accordance with American National Standards Institute/American Petroleum Institute Recommended Practice 13B-1 (Section 4, Mud Balance) and ASTM C939 (Flow Cone), respectively.

Install helical anchors in accordance with the accepted submittals and Anchor Manufacturer's instructions. Measure torque during installation and do not exceed the torsional strength rating of the helical anchor. Attain the minimum required installation torque and penetration before terminating anchor installation. When replacing a helical anchor, embed last helix of the replacement anchor at least 3 helix plate diameters past the location of the first helix of the previous anchor.

(4) Anchor Testing

Proof test and lock-off anchors in accordance with the accepted submittals and Article 6.5.5 of the *AASHTO LRFD Bridge Construction Specifications* except for the acceptance criteria in Article 6.5.5.5. For the AASHTO LRFD specifications, "ground anchor" refers to a ground or helical anchor and "tendon" refers to a bar, strand or shaft.

(a) Anchor Acceptance

Anchor acceptance is based in part on the following criteria.

- (i) For ground and helical anchors, total movement is less than 0.04" between the 1 and 10 minute readings or less than 0.08" between the 6 and 60 minute readings.
- (ii) For ground anchors, total movement at maximum test load exceeds 80% of the theoretical elastic elongation of the unbonded length.

(b) Anchor Test Results

Submit 2 copies of anchor test records including movement versus load plots for each load increment within 24 hours of completing each row of anchors. The Engineer will review the test records to determine if the anchors are acceptable.

If the Engineer determines an anchor is unacceptable, revise the anchor design or installation methods. Submit a revised anchored shoring design for acceptance and provide an acceptable anchor with the revised design or installation methods. If required, replace the anchor or provide additional anchors with the revised design or installation methods.

(C) Temporary Wall Installation

Excavate as necessary for temporary walls in accordance with the plans and accepted submittals. If applicable, install foundations located in the reinforced zone before placing shoring backfill or reinforcement unless otherwise approved. Notify the Engineer when foundation excavation is complete. Do not place shoring backfill or reinforcement until excavation dimensions and foundation material are approved.

Erect welded wire facing so the wall position is as shown in the plans and accepted submittals. Set welded wire facing adjacent to each other in the horizontal and vertical direction to completely cover the wall face with facing. Stagger welded wire facing to create a running bond by centering facing over joints in the row below.

Wrap geotextile reinforcement and retention geotextiles behind welded wire facing as shown in the plans and accepted submittals and cover geotextiles with at least 3" of shoring backfill. Overlap adjacent geotextile reinforcement and retention and separation geotextiles at least 18" with seams oriented perpendicular to the wall face. Hold geotextiles in place with wire staples or anchor pins as needed.

Place reinforcement within 3" of locations shown in the plans and accepted submittals and in slight tension free of kinks, folds, wrinkles or creases. Install reinforcement with the direction shown in the plans and accepted submittals. For temporary wire walls with separate reinforcement and facing components, attach welded wire grid or metallic strip

reinforcement to welded wire facing as shown in the accepted submittals. Do not splice or overlap reinforcement so seams are parallel to the wall face. Contact the Engineer when unanticipated existing or future obstructions such as foundations, pavements, pipes, inlets or utilities will interfere with reinforcement.

Place shoring backfill in the reinforced zone in 8" to 10" thick lifts. Compact A-2-4 soil and Class II, Type 1 and Class III select material in accordance with Subarticle 235-3(C) of the *2012 Standard Specifications*. Use only hand operated compaction equipment to compact backfill within 3 ft of welded wire facing. At a distance greater than 3 ft, compact shoring backfill with at least 4 passes of an 8 ton to 10 ton vibratory roller in a direction parallel to the wall face. Smooth wheeled or rubber tired rollers are also acceptable for compacting backfill. Do not use sheepsfoot, grid rollers or other types of compaction equipment with feet. Do not displace or damage reinforcement when placing and compacting shoring backfill. End dumping directly on geotextile or geogrid reinforcement is not permitted. Do not operate heavy equipment on reinforcement until it is covered with at least 8" of shoring backfill. Replace any damaged reinforcement to the satisfaction of the Engineer.

Backfill for temporary walls outside the reinforced zone in accordance with Article 410-8 of the *2012 Standard Specifications*. Bench temporary walls into the sides of excavations where applicable. For temporary geosynthetic walls with top of wall within 5 ft of finished grade, remove top facing and incorporate top reinforcement layer into fill when placing fill in front of wall. Temporary walls remain in place permanently unless otherwise required.

Measurement and Payment

Temporary Shoring will be measured and paid in square feet. Temporary walls will be measured as the square feet of exposed wall face area. Cantilever, braced or anchored shoring will be measured as the square feet of exposed shoring face area with the shoring height equal to the difference between the top and bottom of shoring elevations. Define "top of shoring" as where the grade intersects the back of sheet piles or H-piles and timber lagging. Define "bottom of shoring" as where the grade intersects front of sheet piles or H-piles and timber lagging. No measurement will be made for any embedment, shoring extension above top of shoring or pavement thickness above temporary walls.

The contract unit price for *Temporary Shoring* will be full compensation for providing shoring designs, submittals and materials, excavating, backfilling, hauling and removing excavated materials and supplying all labor, tools, equipment and incidentals necessary to construct temporary shoring.

No payment will be made for temporary shoring not shown in the plans or required by the Engineer including shoring for OSHA reasons or the Contractor's convenience. No value engineering proposals will be accepted based solely on revising or eliminating shoring locations shown in the plans or estimated quantities shown in the bid item sheets as a result of actual field measurements or site conditions.

PCB will be measured and paid in accordance with Section 1170 of the *2012 Standard Specifications*. No additional payment will be made for anchoring PCB for temporary shoring. Costs for anchoring PCB will be incidental to temporary shoring.

Temporary guardrail will be measured and paid for in accordance with Section 862 of the *2012 Standard Specifications*.

Payment will be made under:

Pay Item	Pay Unit
Temporary Shoring	Square Foot

TRUCK MOUNTED CHANGEABLE MESSAGE SIGNS:

(8-21-12)

1101.02

SP11 R10

Revise the *2012 Roadway Standard Drawings* as follows:

Drawing No. 1101.02, Sheet 12, TEMPORARY LANE CLOSURES, replace General Note #11 with the following:

11- TRUCK MOUNTED CHANGEABLE MESSAGE SIGNS (TMCMS) USED ON SHADOW VEHICLES FOR "IN LANE" ACTIVITIES SHALL BE A MINIMUM OF 43" X 73". THE DISPLAY PANEL SHALL HAVE FULL MATRIX CAPABILITY WITH THE CAPABILITY TO PROVIDE 2 MESSAGE LINES WITH 7 CHARACTERS PER LINE WITH A MINIMUM CHARACTER HEIGHT OF 18". FOR ADDITIONAL MESSAGING, CONTACT THE WORK ZONE TRAFFIC CONTROL SECTION.

12- TMCMS USED FOR ADVANCED WARNING ON VEHICLES LOCATED ON THE SHOULDER MAY BE SMALLER THAN 43" X 73". THE DISPLAY PANEL SHALL HAVE THE CAPABILITY TO PROVIDE 2 MESSAGE LINES WITH 7 CHARACTERS PER LINE WITH A MINIMUM CHARACTER HEIGHT OF 18". FOR ADDITIONAL MESSAGING, CONTACT THE WORK ZONE TRAFFIC CONTROL SECTION.

Drawing No. 1101.02, Sheet 13, TEMPORARY LANE CLOSURES, replace General Note #12 with the following:

12- TRUCK MOUNTED CHANGEABLE MESSAGE SIGNS (TMCMS) USED ON SHADOW VEHICLES FOR "IN LANE" ACTIVITIES SHALL BE A MINIMUM OF 43" X 73". THE DISPLAY PANEL SHALL HAVE FULL MATRIX CAPABILITY WITH THE CAPABILITY TO PROVIDE 2 MESSAGE LINES WITH 7 CHARACTERS PER LINE WITH A MINIMUM CHARACTER HEIGHT OF 18". FOR ADDITIONAL MESSAGING, CONTACT THE WORK ZONE TRAFFIC CONTROL SECTION.

13- TMCMS USED FOR ADVANCED WARNING ON VEHICLES LOCATED ON THE SHOULDER MAY BE SMALLER THAN 43" X 73". THE DISPLAY PANEL SHALL HAVE THE CAPABILITY TO PROVIDE 2 MESSAGE LINES WITH 7 CHARACTERS PER LINE

WITH A MINIMUM CHARACTER HEIGHT OF 18". FOR ADDITIONAL MESSAGING, CONTACT THE WORK ZONE TRAFFIC CONTROL SECTION.

GROUT REFERENCES FOR POSITIVE PROTECTION:

(5-19-15)

1170

SP11 R20

Revise the *2012 Standard Specifications* as follows:

Page 11-14, Article 1170-2, Materials, line 30, in the materials table, replace “Freeze-Thaw Durable Grout, Nonshrink” with “Grout, Type 3”.

Page 11-14, Article 1170-2, Materials, lines 31-32, delete the first paragraph after the materials table.

GROUT REFERENCES FOR UTILITY MANHOLES:

(8-18-15)

1525

SP15 R40

Revise the *2012 Standard Specifications* as follows:

Page 15-13, Article 1525-2, Materials, line 9, in the materials table, add the following:

Item	Section
Grout, Type 2	1003

Page 15-13, Article 1525-2, Materials, lines 20-21, replace the third paragraph after the materials table with the following:

Use Type 2 grout with properties that meet Table 1003-2 in the *Grout Production and Delivery* provision except provide grout with a plastic consistency in accordance with ASTM C1107.

Page 15-14, Subarticle 1525-3(B), Installation of Precast Units, line 22, in the second sentence of the first paragraph, replace “non-shrink grout.” with “grout.”

STANDARD SPECIAL PROVISION
AVAILABILITY OF FUNDS – TERMINATION OF CONTRACTS

(5-20-08)

Z-2

General Statute 143C-6-11. (h) Highway Appropriation is hereby incorporated verbatim in this contract as follows:

(h) Amounts Encumbered. – Transportation project appropriations may be encumbered in the amount of allotments made to the Department of Transportation by the Director for the estimated payments for transportation project contract work to be performed in the appropriation fiscal year. The allotments shall be multiyear allotments and shall be based on estimated revenues and shall be subject to the maximum contract authority contained in *General Statute 143C-6-11(c)*. Payment for transportation project work performed pursuant to contract in any fiscal year other than the current fiscal year is subject to appropriations by the General Assembly. Transportation project contracts shall contain a schedule of estimated completion progress, and any acceleration of this progress shall be subject to the approval of the Department of Transportation provided funds are available. The State reserves the right to terminate or suspend any transportation project contract, and any transportation project contract shall be so terminated or suspended if funds will not be available for payment of the work to be performed during that fiscal year pursuant to the contract. In the event of termination of any contract, the contractor shall be given a written notice of termination at least 60 days before completion of scheduled work for which funds are available. In the event of termination, the contractor shall be paid for the work already performed in accordance with the contract specifications.

Payment will be made on any contract terminated pursuant to the special provision in accordance with Subarticle 108-13(E) of the *2012 Standard Specifications*.

STANDARD SPECIAL PROVISION
NCDOT GENERAL SEED SPECIFICATION FOR SEED QUALITY

(5-17-11)

Z-3

Seed shall be sampled and tested by the North Carolina Department of Agriculture and Consumer Services, Seed Testing Laboratory. When said samples are collected, the vendor shall supply an independent laboratory report for each lot to be tested. Results from seed so sampled shall be final. Seed not meeting the specifications shall be rejected by the Department of Transportation and shall not be delivered to North Carolina Department of Transportation warehouses. If seed has been delivered it shall be available for pickup and replacement at the supplier's expense.

Any re-labeling required by the North Carolina Department of Agriculture and Consumer Services, Seed Testing Laboratory, that would cause the label to reflect as otherwise specified herein shall be rejected by the North Carolina Department of Transportation.

Seed shall be free from seeds of the noxious weeds Johnsongrass, Balloonvine, Jimsonweed, Witchweed, Itchgrass, Serrated Tussock, Showy Crotalaria, Smooth Crotalaria, Sicklepod, Sandbur, Wild Onion, and Wild Garlic. Seed shall not be labeled with the above weed species on the seed analysis label. Tolerances as applied by the Association of Official Seed Analysts will NOT be allowed for the above noxious weeds except for Wild Onion and Wild Garlic.

Tolerances established by the Association of Official Seed Analysts will generally be recognized. However, for the purpose of figuring pure live seed, the found pure seed and found germination percentages as reported by the North Carolina Department of Agriculture and Consumer Services, Seed Testing Laboratory will be used. Allowances, as established by the NCDOT, will be recognized for minimum pure live seed as listed on the following pages.

The specifications for restricted noxious weed seed refers to the number per pound as follows:

<u>Restricted Noxious Weed</u>	<u>Limitations per Lb. Of Seed</u>	<u>Restricted Noxious Weed</u>	<u>Limitations per Lb. of Seed</u>
Blessed Thistle	4 seeds	Cornflower (Ragged Robin)	27 seeds
Cocklebur	4 seeds	Texas Panicum	27 seeds
Spurred Anoda	4 seeds	Bracted Plantain	54 seeds
Velvetleaf	4 seeds	Buckhorn Plantain	54 seeds
Morning-glory	8 seeds	Broadleaf Dock	54 seeds
Corn Cockle	10 seeds	Curly Dock	54 seeds
Wild Radish	12 seeds	Dodder	54 seeds
Purple Nutsedge	27 seeds	Giant Foxtail	54 seeds
Yellow Nutsedge	27 seeds	Horsenettle	54 seeds
Canada Thistle	27 seeds	Quackgrass	54 seeds
Field Bindweed	27 seeds	Wild Mustard	54 seeds
Hedge Bindweed	27 seeds		

Seed of Pensacola Bahiagrass shall not contain more than 7% inert matter, Kentucky Bluegrass, Centipede and Fine or Hard Fescue shall not contain more than 5% inert matter whereas a maximum of 2% inert matter will be allowed on all other kinds of seed. In addition, all seed shall not contain more than 2% other crop seed nor more than 1% total weed seed. The germination rate as tested by the North Carolina Department of Agriculture shall not fall below 70%, which includes both dormant and hard seed. Seed shall be labeled with not more than 7%, 5% or 2% inert matter (according to above specifications), 2% other crop seed and 1% total weed seed.

Exceptions may be made for minimum pure live seed allowances when cases of seed variety shortages are verified. Pure live seed percentages will be applied in a verified shortage situation. Those purchase orders of deficient seed lots will be credited with the percentage that the seed is deficient.

FURTHER SPECIFICATIONS FOR EACH SEED GROUP ARE GIVEN BELOW:

Minimum 85% pure live seed; maximum 1% total weed seed; maximum 2% total other crop seed; maximum 144 restricted noxious weed seed per pound. Seed less than 83% pure live seed will not be approved.

Sericea Lespedeza
Oats (seeds)

Minimum 80% pure live seed; maximum 1% total weed seed; maximum 2% total other crop; maximum 144 restricted noxious weed seed per pound. Seed less than 78% pure live seed will not be approved.

Tall Fescue (all approved varieties)	Bermudagrass
Kobe Lespedeza	Browntop Millet
Korean Lespedeza	German Millet – Strain R
Weeping Lovegrass	Clover – Red/White/Crimson
Carpetgrass	

Minimum 78% pure live seed; maximum 1% total weed seed; maximum 2% total other crop seed; maximum 144 restricted noxious weed seed per pound. Seed less than 76% pure live seed will not be approved.

Common or Sweet Sundangrass

Minimum 76% pure live seed; maximum 1% total weed seed; maximum 2% total other crop seed; maximum 144 restricted noxious weed seed per pound. Seed less than 74% pure live seed will not be approved.

Rye (grain; all varieties)
Kentucky Bluegrass (all approved varieties)
Hard Fescue (all approved varieties)
Shrub (bicolor) Lespedeza

Minimum 70% pure live seed; maximum 1% total weed seed; maximum 2% total other crop seed; maximum 144 noxious weed seed per pound. Seed less than 70% pure live seed will not be approved.

Centipedegrass
Crownvetch
Pensacola Bahiagrass
Creeping Red Fescue

Japanese Millet
Reed Canary Grass
Zoysia

Minimum 70% pure live seed; maximum 1% total weed seed; maximum 2% total other crop seed; maximum 5% inert matter; maximum 144 restricted noxious weed seed per pound.

Barnyard Grass
Big Bluestem
Little Bluestem
Bristly Locust
Birdsfoot Trefoil
Indiangrass
Orchardgrass
Switchgrass
Yellow Blossom Sweet Clover

STANDARD SPECIAL PROVISION**ERRATA**

(1-17-12) (Rev. 04-21-15)

Z-4

Revise the *2012 Standard Specifications* as follows:

Division 2

Page 2-7, line 31, Article 215-2 Construction Methods, replace “Article 107-26” with “Article 107-25”.

Page 2-17, Article 226-3, Measurement and Payment, line 2, delete “pipe culverts,”.

Page 2-20, Subarticle 230-4(B), Contractor Furnished Sources, change references as follows: Line 1, replace “(4) Buffer Zone” with “(c) Buffer Zone”; **Line 12**, replace “(5) Evaluation for Potential Wetlands and Endangered Species” with “(d) Evaluation for Potential Wetlands and Endangered Species”; and **Line 33**, replace “(6) Approval” with “(4) Approval”.

Division 3

Page 3-1, after line 15, Article 300-2 Materials, replace “1032-9(F)” with “1032-6(F)”.

Division 4

Page 4-77, line 27, Subarticle 452-3(C) Concrete Coping, replace “sheet pile” with “reinforcement”.

Division 6

Page 6-7, line 31, Article 609-3 Field Verification of Mixture and Job Mix Formula Adjustments, replace “30” with “45”.

Page 6-10, line 42, Subarticle 609-6(C)(2), replace “Subarticle 609-6(E)” with “Subarticle 609-6(D)”.

Page 6-11, Table 609-1 Control Limits, replace “Max. Spec. Limit” for the Target Source of $P_{0.075}/P_{be}$ Ratio with “1.0”.

Page 6-40, Article 650-2 Materials, replace “Subarticle 1012-1(F)” with “Subarticle 1012-1(E)”

Division 7

Page 7-1, Article 700-3, CONCRETE HAULING EQUIPMENT, line 33, replace “competition” with “completion”.

Division 8

Page 8-23, line 10, Article 838-2 Materials, replace “Portland Cement Concrete, Class B” with “Portland Cement Concrete, Class A”.

Division 10

Page 10-166, Article 1081-3 Hot Bitumen, replace “Table 1081-16” with “Table 1081-2”, replace “Table 1081-17” with “Table 1081-3”, and replace “Table 1081-18” with “Table 1081-4”.

Division 12

Page 12-7, Table 1205-3, add “FOR THERMOPLASTIC” to the end of the title.

Page 12-8, Subarticle 1205-5(B), line 13, replace “Table 1205-2” with “Table 1205-4”.

Page 12-8, Table 1205-4 and 1205-5, replace “THERMOPLASTIC” in the title of these tables with “POLYUREA”.

Page 12-9, Subarticle 1205-6(B), line 21, replace “Table 1205-4” with “Table 1205-6”.

Page 12-11, Subarticle 1205-8(C), line 25, replace “Table 1205-5” with “Table 1205-7”.

Division 15

Page 15-4, Subarticle 1505-3(F) Backfilling, line 26, replace “Subarticle 235-4(C)” with “Subarticle 235-3(C)”.

Page 15-6, Subarticle 1510-3(B), after line 21, replace the allowable leakage formula with the following: $W=LD\sqrt{P} \div 148,000$

Page 15-6, Subarticle 1510-3(B), line 32, delete “may be performed concurrently or” and replace with “shall be performed”.

Page 15-17, Subarticle 1540-3(E), line 27, delete “Type 1”.

Division 17

Page 17-26, line 42, Subarticle 1731-3(D) Termination and Splicing within Interconnect Center, delete this subarticle.

Revise the *2012 Roadway Standard Drawings* as follows:

1633.01 Sheet 1 of 1, English Standard Drawing for Matting Installation, replace “1633.01” with “1631.01”.

STANDARD SPECIAL PROVISION**PLANT AND PEST QUARANTINES****(Imported Fire Ant, Gypsy Moth, Witchweed, And Other Noxious Weeds)**

(3-18-03) (Rev. 10-15-13)

Z-04a

Within Quarantined Area

This project may be within a county regulated for plant and/or pests. If the project or any part of the Contractor's operations is located within a quarantined area, thoroughly clean all equipment prior to moving out of the quarantined area. Comply with federal/state regulations by obtaining a certificate or limited permit for any regulated article moving from the quarantined area.

Originating in a Quarantined County

Obtain a certificate or limited permit issued by the N.C. Department of Agriculture/United States Department of Agriculture. Have the certificate or limited permit accompany the article when it arrives at the project site.

Contact

Contact the N.C. Department of Agriculture/United States Department of Agriculture at 1-800-206-9333, 919-733-6932, or <http://www.ncagr.gov/plantind/> to determine those specific project sites located in the quarantined area or for any regulated article used on this project originating in a quarantined county.

Regulated Articles Include

1. Soil, sand, gravel, compost, peat, humus, muck, and decomposed manure, separately or with other articles. This includes movement of articles listed above that may be associated with cut/waste, ditch pulling, and shoulder cutting.
2. Plants with roots including grass sod.
3. Plant crowns and roots.
4. Bulbs, corms, rhizomes, and tubers of ornamental plants.
5. Hay, straw, fodder, and plant litter of any kind.
6. Clearing and grubbing debris.
7. Used agricultural cultivating and harvesting equipment.
8. Used earth-moving equipment.
9. Any other products, articles, or means of conveyance, of any character, if determined by an inspector to present a hazard of spreading imported fire ant, gypsy moth, witchweed or other noxious weeds.

STANDARD SPECIAL PROVISION**AWARD OF CONTRACT**

(6-28-77)

Z-6

“The North Carolina Department of Transportation, in accordance with the provisions of *Title VI of the Civil Rights Act of 1964* (78 Stat. 252) and the Regulations of the Department of Transportation (*49 C.F.R., Part 21*), issued pursuant to such act, hereby notifies all bidders that it will affirmatively insure that the contract entered into pursuant to this advertisement will be awarded to the lowest responsible bidder without discrimination on the ground of race, color, or national origin”.

STANDARD SPECIAL PROVISION**MINORITY AND FEMALE EMPLOYMENT REQUIREMENTS**

Z-7

NOTICE OF REQUIREMENTS FOR AFFIRMATIVE ACTION TO ENSURE EQUAL EMPLOYMENT OPPORTUNITY (*EXECUTIVE NUMBER 11246*)

1. The goals and timetables for minority and female participation, expressed in percentage terms for the Contractor's aggregate workforce in each trade on all construction work in the covered area, see as shown on the attached sheet entitled "Employment Goals for Minority and Female participation".

These goals are applicable to all the Contractor's construction work (whether or not it is Federal or federally assisted) performed in the covered area. If the Contractor performs construction work in a geographical area located outside of the covered area, it shall apply the goals established for such geographical area where the work is actually performed. With regard to this second area, the Contractor also is subject to the goals for both its federally involved and nonfederally involved construction.

The Contractor's compliance with the Executive Order and the regulations in *41 CFR Part 60-4* shall be based on its implementation of the Equal Opportunity Clause, specific affirmative action obligations required by the specifications set forth in *41 CFR 60-4.3(a)*, and its effort to meet the goals. The hours of minority and female employment and training must be substantially uniform throughout the length of the contract, and in each trade and the Contractor shall make a good faith effort to employ minorities and women evenly on each of its projects. The transfer of minority or female employees or trainees from Contractor to Contractor or from project to project or the sole purpose of meeting the Contractor's goals shall be a violation of the contract, the executive Order and the regulations in *41 CFR Part 60-4*. Compliance with the goals will be measured against the total work hours performed.

2. As used in this Notice and in the contract resulting from this solicitation, the "covered area" is the county or counties shown on the cover sheet of the proposal form and contract.

**EMPLOYMENT GOALS FOR MINORITY
AND FEMALE PARTICIPATION**

Economic Areas

Area 023 29.7%

Bertie County
Camden County
Chowan County
Gates County
Hertford County
Pasquotank County
Perquimans County

Area 024 31.7%

Beaufort County
Carteret County
Craven County
Dare County
Edgecombe County
Green County
Halifax County
Hyde County
Jones County
Lenoir County
Martin County
Nash County
Northampton County
Pamlico County
Pitt County
Tyrrell County
Washington County
Wayne County
Wilson County

Area 025 23.5%

Columbus County
Duplin County
Onslow County
Pender County

Area 026 33.5%

Bladen County
Hoke County
Richmond County
Robeson County
Sampson County
Scotland County

Area 027 24.7%

Chatham County
Franklin County
Granville County
Harnett County
Johnston County
Lee County
Person County
Vance County
Warren County

Area 028 15.5%

Alleghany County
Ashe County
Caswell County
Davie County
Montgomery County
Moore County
Rockingham County
Surry County
Watauga County
Wilkes County

Area 029 15.7%

Alexander County
Anson County
Burke County
Cabarrus County
Caldwell County
Catawba County
Cleveland County
Iredell County
Lincoln County
Polk County
Rowan County
Rutherford County
Stanly County

Area 0480 8.5%

Buncombe County
Madison County

Area 030 6.3%

Avery County
Cherokee County
Clay County
Graham County
Haywood County
Henderson County
Jackson County
McDowell County
Macon County
Mitchell County
Swain County
Transylvania County
Yancey County

SMSA Areas

Area 5720 26.6%

Currituck County

Area 9200 20.7%

Brunswick County

New Hanover County

Area 2560 24.2%

Cumberland County

Area 6640 22.8%

Durham County

Orange County

Wake County

Area 1300 16.2%

Alamance County

Area 3120 16.4%

Davidson County

Forsyth County

Guilford County

Randolph County

Stokes County

Yadkin County

Area 1520 18.3%

Gaston County

Mecklenburg County

Union County

Goals for Female

Participation in Each Trade

(Statewide) 6.9%

STANDARD SPECIAL PROVISION**REQUIRED CONTRACT PROVISIONS FEDERAL - AID CONSTRUCTION CONTRACTS**

FHWA - 1273 Electronic Version - May 1, 2012

Z-8

- I. General
- II. Nondiscrimination
- III. Nonsegregated Facilities
- IV. Davis-Bacon and Related Act Provisions
- V. Contract Work Hours and Safety Standards Act Provisions
- VI. Subletting or Assigning the Contract
- VII. Safety: Accident Prevention
- VIII. False Statements Concerning Highway Projects
- IX. Implementation of Clean Air Act and Federal Water Pollution Control Act
- X. Compliance with Governmentwide Suspension and Debarment Requirements
- XI. Certification Regarding Use of Contract Funds for Lobbying

ATTACHMENTS

- A. Employment and Materials Preference for Appalachian Development Highway System or Appalachian Local Access Road Contracts (included in Appalachian contracts only)

I. GENERAL

1. Form FHWA-1273 must be physically incorporated in each construction contract funded under Title 23 (excluding emergency contracts solely intended for debris removal). The contractor (or subcontractor) must insert this form in each subcontract and further require its inclusion in all lower tier subcontracts (excluding purchase orders, rental agreements and other agreements for supplies or services).
The applicable requirements of Form FHWA-1273 are incorporated by reference for work done under any purchase order, rental agreement or agreement for other services. The prime contractor shall be responsible for compliance by any subcontractor, lower-tier subcontractor or service provider.
Form FHWA-1273 must be included in all Federal-aid design-build contracts, in all subcontracts and in lower tier subcontracts (excluding subcontracts for design services, purchase orders, rental agreements and other agreements for supplies or services). The design-builder shall be responsible for compliance by any subcontractor, lower-tier subcontractor or service provider.
Contracting agencies may reference Form FHWA-1273 in bid proposal or request for proposal documents, however, the Form FHWA-1273 must be physically incorporated (not referenced) in all contracts, subcontracts and lower-tier subcontracts (excluding purchase orders, rental agreements and other agreements for supplies or services related to a construction contract).
2. Subject to the applicability criteria noted in the following sections, these contract provisions shall apply to all work performed on the contract by the contractor's own organization and with the assistance of workers under the contractor's immediate superintendence and to all work performed on the contract by piecework, station work, or by subcontract.
3. A breach of any of the stipulations contained in these Required Contract Provisions may be sufficient grounds for withholding of progress payments, withholding of final payment, termination of the contract, suspension / debarment or any other action determined to be appropriate by the contracting agency and FHWA.
4. Selection of Labor: During the performance of this contract, the contractor shall not use convict labor for any purpose within the limits of a construction project on a Federal-aid highway unless it is labor performed by convicts who are on parole, supervised release, or probation. The term Federal-aid highway does not include roadways functionally classified as local roads or rural minor collectors.

II. NONDISCRIMINATION

The provisions of this section related to 23 CFR Part 230 are applicable to all Federal-aid construction contracts and to all related construction subcontracts of \$10,000 or more. The provisions of 23 CFR Part 230 are not applicable to material supply, engineering, or architectural service contracts.

In addition, the contractor and all subcontractors must comply with the following policies: Executive Order 11246, 41 CFR 60, 29 CFR 1625-1627, Title 23 USC Section 140, the Rehabilitation Act of 1973, as amended (29 USC 794), Title VI of the Civil Rights Act of 1964, as amended, and related regulations including 49 CFR Parts 21, 26 and 27; and 23 CFR Parts 200, 230, and 633.

The contractor and all subcontractors must comply with: the requirements of the Equal Opportunity Clause in 41 CFR 60-1.4(b) and, for all construction contracts exceeding \$10,000, the Standard Federal Equal Employment Opportunity Construction Contract Specifications in 41 CFR 60-4.3.

Note: The U.S. Department of Labor has exclusive authority to determine compliance with Executive Order 11246 and the policies of the Secretary of Labor including 41 CFR 60, and 29 CFR 1625-1627. The contracting agency and the FHWA have the authority and the responsibility to ensure compliance with Title 23 USC Section 140, the Rehabilitation Act of 1973, as amended (29 USC 794), and Title VI of the Civil Rights Act of 1964, as amended, and related regulations including 49 CFR Parts 21, 26 and 27; and 23 CFR Parts 200, 230, and 633.

The following provision is adopted from 23 CFR 230, Appendix A, with appropriate revisions to conform to the U.S. Department of Labor (US DOL) and FHWA requirements.

1. **Equal Employment Opportunity:** Equal employment opportunity (EEO) requirements not to discriminate and to take affirmative action to assure equal opportunity as set forth under laws, executive orders, rules, regulations (28 CFR 35, 29 CFR 1630, 29 CFR 1625-1627, 41 CFR 60 and 49 CFR 27) and orders of the Secretary of Labor as modified by the provisions prescribed herein, and imposed pursuant to 23 U.S.C. 140 shall constitute the EEO and specific affirmative action standards for the contractor's project activities under this contract. The provisions of the Americans with Disabilities Act of 1990 (42 U.S.C. 12101 et seq.) set forth under 28 CFR 35 and 29 CFR 1630 are

incorporated by reference in this contract. In the execution of this contract, the contractor agrees to comply with the following minimum specific requirement activities of EEO:

- a. The contractor will work with the contracting agency and the Federal Government to ensure that it has made every good faith effort to provide equal opportunity with respect to all of its terms and conditions of employment and in their review of activities under the contract.
 - b. The contractor will accept as its operating policy the following statement:
"It is the policy of this Company to assure that applicants are employed, and that employees are treated during employment, without regard to their race, religion, sex, color, national origin, age or disability. Such action shall include: employment, upgrading, demotion, or transfer; recruitment or recruitment advertising; layoff or termination; rates of pay or other forms of compensation; and selection for training, including apprenticeship, pre-apprenticeship, and/or on-the-job training."
2. **EEO Officer:** The contractor will designate and make known to the contracting officers an EEO Officer who will have the responsibility for and must be capable of effectively administering and promoting an active EEO program and who must be assigned adequate authority and responsibility to do so.
3. **Dissemination of Policy:** All members of the contractor's staff who are authorized to hire, supervise, promote, and discharge employees, or who recommend such action, or who are substantially involved in such action, will be made fully cognizant of, and will implement, the contractor's EEO policy and contractual responsibilities to provide EEO in each grade and classification of employment. To ensure that the above agreement will be met, the following actions will be taken as a minimum:
- a. Periodic meetings of supervisory and personnel office employees will be conducted before the start of work and then not less often than once every six months, at which time the contractor's EEO policy and its implementation will be reviewed and explained. The meetings will be conducted by the EEO Officer.
 - b. All new supervisory or personnel office employees will be given a thorough indoctrination by the EEO Officer, covering all major aspects of the contractor's EEO obligations within thirty days following their reporting for duty with the contractor.
 - c. All personnel who are engaged in direct recruitment for the project will be instructed by the EEO Officer in the contractor's procedures for locating and hiring minorities and women.
 - d. Notices and posters setting forth the contractor's EEO policy will be placed in areas readily accessible to employees, applicants for employment and potential employees.
 - e. The contractor's EEO policy and the procedures to implement such policy will be brought to the attention of employees by means of meetings, employee handbooks, or other appropriate means.
4. **Recruitment:** When advertising for employees, the contractor will include in all advertisements for employees the notation: "An Equal Opportunity Employer." All such advertisements will be placed in publications having a large circulation among minorities and women in the area from which the project work force would normally be derived.
- a. The contractor will, unless precluded by a valid bargaining agreement, conduct systematic and direct recruitment through public and private employee referral sources likely to yield qualified minorities and women. To meet this requirement, the contractor will identify sources of potential minority group employees, and establish with such identified sources procedures whereby minority and women applicants may be referred to the contractor for employment consideration.
 - b. In the event the contractor has a valid bargaining agreement providing for exclusive hiring hall referrals, the contractor is expected to observe the provisions of that agreement to the extent that the system meets the contractor's compliance with EEO contract provisions. Where implementation of such an agreement has the effect of discriminating against minorities or women, or obligates the contractor to do the same, such implementation violates Federal nondiscrimination provisions.
 - c. The contractor will encourage its present employees to refer minorities and women as applicants for employment. Information and procedures with regard to referring such applicants will be discussed with employees.
5. **Personnel Actions:** Wages, working conditions, and employee benefits shall be established and administered, and personnel actions of every type, including hiring, upgrading, promotion, transfer, demotion, layoff, and termination, shall be taken without regard to race, color, religion, sex, national origin, age or disability. The following procedures shall be followed:
- a. The contractor will conduct periodic inspections of project sites to insure that working conditions and employee facilities do not indicate discriminatory treatment of project site personnel.
 - b. The contractor will periodically evaluate the spread of wages paid within each classification to determine any evidence of discriminatory wage practices.
 - c. The contractor will periodically review selected personnel actions in depth to determine whether there is evidence of discrimination. Where evidence is found, the contractor will promptly take corrective action. If the review indicates that the discrimination may extend beyond the actions reviewed, such corrective action shall include all affected persons.
 - d. The contractor will promptly investigate all complaints of alleged discrimination made to the contractor in connection with its obligations under this contract, will attempt to resolve such complaints, and will take appropriate corrective action within a reasonable time. If the investigation indicates that the discrimination may affect persons other than the complainant, such corrective action shall include such other persons. Upon completion of each investigation, the contractor will inform every complainant of all of their avenues of appeal.
6. **Training and Promotion:**
- a. The contractor will assist in locating, qualifying, and increasing the skills of minorities and women who are applicants for employment or current employees. Such efforts should be aimed at developing full journey level status employees in the type of trade or job classification involved.
 - b. Consistent with the contractor's work force requirements and as permissible under Federal and State regulations, the contractor shall make full use of training programs, i.e., apprenticeship, and on-the-job training programs for the geographical area of contract performance. In the event a special provision for training is provided under this contract, this subparagraph will be superseded as indicated in the special provision. The contracting agency may reserve training positions for persons who receive welfare assistance in accordance with 23 U.S.C. 140(a).
 - c. The contractor will advise employees and applicants for employment of available training programs and entrance requirements for each.
 - d. The contractor will periodically review the training and promotion potential of employees who are minorities and women and will encourage eligible employees to apply for such training and promotion.

7. **Unions:** If the contractor relies in whole or in part upon unions as a source of employees, the contractor will use good faith efforts to obtain the cooperation of such unions to increase opportunities for minorities and women. Actions by the contractor, either directly or through a contractor's association acting as agent, will include the procedures set forth below:
 - a. The contractor will use good faith efforts to develop, in cooperation with the unions, joint training programs aimed toward qualifying more minorities and women for membership in the unions and increasing the skills of minorities and women so that they may qualify for higher paying employment.
 - b. The contractor will use good faith efforts to incorporate an EEO clause into each union agreement to the end that such union will be contractually bound to refer applicants without regard to their race, color, religion, sex, national origin, age or disability.
 - c. The contractor is to obtain information as to the referral practices and policies of the labor union except that to the extent such information is within the exclusive possession of the labor union and such labor union refuses to furnish such information to the contractor, the contractor shall so certify to the contracting agency and shall set forth what efforts have been made to obtain such information.
 - d. In the event the union is unable to provide the contractor with a reasonable flow of referrals within the time limit set forth in the collective bargaining agreement, the contractor will, through independent recruitment efforts, fill the employment vacancies without regard to race, color, religion, sex, national origin, age or disability; making full efforts to obtain qualified and/or qualifiable minorities and women. The failure of a union to provide sufficient referrals (even though it is obligated to provide exclusive referrals under the terms of a collective bargaining agreement) does not relieve the contractor from the requirements of this paragraph. In the event the union referral practice prevents the contractor from meeting the obligations pursuant to Executive Order 11246, as amended, and these special provisions, such contractor shall immediately notify the contracting agency.
8. **Reasonable Accommodation for Applicants / Employees with Disabilities:** The contractor must be familiar with the requirements for and comply with the Americans with Disabilities Act and all rules and regulations established there under. Employers must provide reasonable accommodation in all employment activities unless to do so would cause an undue hardship.
9. **Selection of Subcontractors, Procurement of Materials and Leasing of Equipment:** The contractor shall not discriminate on the grounds of race, color, religion, sex, national origin, age or disability in the selection and retention of subcontractors, including procurement of materials and leases of equipment. The contractor shall take all necessary and reasonable steps to ensure nondiscrimination in the administration of this contract.
 - a. The contractor shall notify all potential subcontractors and suppliers and lessors of their EEO obligations under this contract.
 - b. The contractor will use good faith efforts to ensure subcontractor compliance with their EEO obligations.
10. **Assurance Required by 49 CFR 26.13(b):**
 - a. The requirements of 49 CFR Part 26 and the State DOT's U.S. DOT-approved DBE program are incorporated by reference.
 - b. The contractor or subcontractor shall not discriminate on the basis of race, color, national origin, or sex in the performance of this contract. The contractor shall carry out applicable requirements of 49 CFR Part 26 in the award and administration of DOT-assisted contracts. Failure by the contractor to carry out these requirements is a material breach of this contract, which may result in the termination of this contract or such other remedy as the contracting agency deems appropriate.
11. **Records and Reports:** The contractor shall keep such records as necessary to document compliance with the EEO requirements. Such records shall be retained for a period of three years following the date of the final payment to the contractor for all contract work and shall be available at reasonable times and places for inspection by authorized representatives of the contracting agency and the FHWA.
 - a. The records kept by the contractor shall document the following:
 - (1) The number and work hours of minority and non-minority group members and women employed in each work classification on the project;
 - (2) The progress and efforts being made in cooperation with unions, when applicable, to increase employment opportunities for minorities and women; and
 - (3) The progress and efforts being made in locating, hiring, training, qualifying, and upgrading minorities and women;
 - b. The contractors and subcontractors will submit an annual report to the contracting agency each July for the duration of the project, indicating the number of minority, women, and non-minority group employees currently engaged in each work classification required by the contract work. This information is to be reported on Form FHWA-1391. The staffing data should represent the project work force on board in all or any part of the last payroll period preceding the end of July. If on-the-job training is being required by special provision, the contractor will be required to collect and report training data. The employment data should reflect the work force on board during all or any part of the last payroll period preceding the end of July.

III. NONSEGREGATED FACILITIES

This provision is applicable to all Federal-aid construction contracts and to all related construction subcontracts of \$10,000 or more.

The contractor must ensure that facilities provided for employees are provided in such a manner that segregation on the basis of race, color, religion, sex, or national origin cannot result. The contractor may neither require such segregated use by written or oral policies nor tolerate such use by employee custom. The contractor's obligation extends further to ensure that its employees are not assigned to perform their services at any location, under the contractor's control, where the facilities are segregated. The term "facilities" includes waiting rooms, work areas, restaurants and other eating areas, time clocks, restrooms, washrooms, locker rooms, and other storage or dressing areas, parking lots, drinking fountains, recreation or entertainment areas, transportation, and housing provided for employees. The contractor shall provide separate or single-user restrooms and necessary dressing or sleeping areas to assure privacy between sexes.

IV. DAVIS-BACON AND RELATED ACT PROVISIONS

This section is applicable to all Federal-aid construction projects exceeding \$2,000 and to all related subcontracts and lower-tier subcontracts (regardless of subcontract size). The requirements apply to all projects located within the right-of-way of a roadway that is functionally classified as Federal-aid highway. This excludes roadways functionally classified as local roads or rural minor collectors, which are exempt. Contracting agencies may elect to apply these requirements to other projects.

The following provisions are from the U.S. Department of Labor regulations in 29 CFR 5.5 "Contract provisions and related matters" with minor revisions to conform to the FHWA-1273 format and FHWA program requirements.

1. Minimum wages

- a. All laborers and mechanics employed or working upon the site of the work, will be paid unconditionally and not less often than once a week, and without subsequent deduction or rebate on any account (except such payroll deductions as are permitted by regulations issued by the

Secretary of Labor under the Copeland Act (29 CFR part 3)), the full amount of wages and bona fide fringe benefits (or cash equivalents thereof) due at time of payment computed at rates not less than those contained in the wage determination of the Secretary of Labor which is attached hereto and made a part hereof, regardless of any contractual relationship which may be alleged to exist between the contractor and such laborers and mechanics.

Contributions made or costs reasonably anticipated for bona fide fringe benefits under section 1(b)(2) of the Davis-Bacon Act on behalf of laborers or mechanics are considered wages paid to such laborers or mechanics, subject to the provisions of paragraph 1.d. of this section; also, regular contributions made or costs incurred for more than a weekly period (but not less often than quarterly) under plans, funds, or programs which cover the particular weekly period, are deemed to be constructively made or incurred during such weekly period. Such laborers and mechanics shall be paid the appropriate wage rate and fringe benefits on the wage determination for the classification of work actually performed, without regard to skill, except as provided in 29 CFR 5.5(a)(4). Laborers or mechanics performing work in more than one classification may be compensated at the rate specified for each classification for the time actually worked therein: Provided, That the employer's payroll records accurately set forth the time spent in each classification in which work is performed. The wage determination (including any additional classification and wage rates conformed under paragraph 1.b. of this section) and the Davis-Bacon poster (WH-1321) shall be posted at all times by the contractor and its subcontractors at the site of the work in a prominent and accessible place where it can be easily seen by the workers.

- b. (1) The contracting officer shall require that any class of laborers or mechanics, including helpers, which is not listed in the wage determination and which is to be employed under the contract shall be classified in conformance with the wage determination. The contracting officer shall approve an additional classification and wage rate and fringe benefits therefore only when the following criteria have been met:
 - (i) The work to be performed by the classification requested is not performed by a classification in the wage determination; and
 - (ii) The classification is utilized in the area by the construction industry; and
 - (iii) The proposed wage rate, including any bona fide fringe benefits, bears a reasonable relationship to the wage rates contained in the wage determination.
 - (2) If the contractor and the laborers and mechanics to be employed in the classification (if known), or their representatives, and the contracting officer agree on the classification and wage rate (including the amount designated for fringe benefits where appropriate), a report of the action taken shall be sent by the contracting officer to the Administrator of the Wage and Hour Division, Employment Standards Administration, U.S. Department of Labor, Washington, DC 20210. The Administrator, or an authorized representative, will approve, modify, or disapprove every additional classification action within 30 days of receipt and so advise the contracting officer or will notify the contracting officer within the 30-day period that additional time is necessary.
 - (3) In the event the contractor, the laborers or mechanics to be employed in the classification or their representatives, and the contracting officer do not agree on the proposed classification and wage rate (including the amount designated for fringe benefits, where appropriate), the contracting officer shall refer the questions, including the views of all interested parties and the recommendation of the contracting officer, to the Wage and Hour Administrator for determination. The Wage and Hour Administrator, or an authorized representative, will issue a determination within 30 days of receipt and so advise the contracting officer or will notify the contracting officer within the 30-day period that additional time is necessary.
 - (4) The wage rate (including fringe benefits where appropriate) determined pursuant to paragraphs 1.b.(2) or 1.b.(3) of this section, shall be paid to all workers performing work in the classification under this contract from the first day on which work is performed in the classification.
 - c. Whenever the minimum wage rate prescribed in the contract for a class of laborers or mechanics includes a fringe benefit which is not expressed as an hourly rate, the contractor shall either pay the benefit as stated in the wage determination or shall pay another bona fide fringe benefit or an hourly cash equivalent thereof.
 - d. If the contractor does not make payments to a trustee or other third person, the contractor may consider as part of the wages of any laborer or mechanic the amount of any costs reasonably anticipated in providing bona fide fringe benefits under a plan or program, Provided, That the Secretary of Labor has found, upon the written request of the contractor, that the applicable standards of the Davis-Bacon Act have been met. The Secretary of Labor may require the contractor to set aside in a separate account assets for the meeting of obligations under the plan or program.
2. **Withholding.** The contracting agency shall upon its own action or upon written request of an authorized representative of the Department of Labor, withhold or cause to be withheld from the contractor under this contract, or any other Federal contract with the same prime contractor, or any other federally-assisted contract subject to Davis-Bacon prevailing wage requirements, which is held by the same prime contractor, so much of the accrued payments or advances as may be considered necessary to pay laborers and mechanics, including apprentices, trainees, and helpers, employed by the contractor or any subcontractor the full amount of wages required by the contract. In the event of failure to pay any laborer or mechanic, including any apprentice, trainee, or helper, employed or working on the site of the work, all or part of the wages required by the contract, the contracting agency may, after written notice to the contractor, take such action as may be necessary to cause the suspension of any further payment, advance, or guarantee of funds until such violations have ceased.
 3. **Payrolls and basic records**
 - a. Payrolls and basic records relating thereto shall be maintained by the contractor during the course of the work and preserved for a period of three years thereafter for all laborers and mechanics working at the site of the work. Such records shall contain the name, address, and social security number of each such worker, his or her correct classification, hourly rates of wages paid (including rates of contributions or costs anticipated for bona fide fringe benefits or cash equivalents thereof of the types described in section 1(b)(2)(B) of the Davis-Bacon Act), daily and weekly number of hours worked, deductions made and actual wages paid. Whenever the Secretary of Labor has found under 29 CFR 5.5(a)(1)(iv) that the wages of any laborer or mechanic include the amount of any costs reasonably anticipated in providing benefits under a plan or program described in section 1(b)(2)(B) of the Davis-Bacon Act, the contractor shall maintain records which show that the commitment to provide such benefits is enforceable, that the plan or program is financially responsible, and that the plan or program has been communicated in writing to the laborers or mechanics affected, and records which show the costs anticipated or the actual cost incurred in providing such benefits. Contractors employing apprentices or trainees under approved programs shall maintain written evidence of the registration of apprenticeship programs and certification of trainee programs, the registration of the apprentices and trainees, and the ratios and wage rates prescribed in the applicable programs.
 - b. (1) The contractor shall submit weekly for each week in which any contract work is performed a copy of all payrolls to the contracting agency. The payrolls submitted shall set out accurately and completely all of the information required to be maintained under 29 CFR 5.5(a)(3)(i), except that full social security numbers and home addresses shall not be included on weekly transmittals. Instead the

payrolls shall only need to include an individually identifying number for each employee (e.g. , the last four digits of the employee's social security number). The required weekly payroll information may be submitted in any form desired. Optional Form WH-347 is available for this purpose from the Wage and Hour Division Web site at <http://www.dol.gov/esa/whd/forms/wh347instr.htm> or its successor site. The prime contractor is responsible for the submission of copies of payrolls by all subcontractors. Contractors and subcontractors shall maintain the full social security number and current address of each covered worker, and shall provide them upon request to the contracting agency for transmission to the State DOT, the FHWA or the Wage and Hour Division of the Department of Labor for purposes of an investigation or audit of compliance with prevailing wage requirements. It is not a violation of this section for a prime contractor to require a subcontractor to provide addresses and social security numbers to the prime contractor for its own records, without weekly submission to the contracting agency.

- (2) Each payroll submitted shall be accompanied by a "Statement of Compliance," signed by the contractor or subcontractor or his or her agent who pays or supervises the payment of the persons employed under the contract and shall certify the following:
 - (i) That the payroll for the payroll period contains the information required to be provided under §5.5 (a)(3)(ii) of Regulations, 29 CFR part 5, the appropriate information is being maintained under §5.5 (a)(3)(i) of Regulations, 29 CFR part 5, and that such information is correct and complete;
 - (ii) That each laborer or mechanic (including each helper, apprentice, and trainee) employed on the contract during the payroll period has been paid the full weekly wages earned, without rebate, either directly or indirectly, and that no deductions have been made either directly or indirectly from the full wages earned, other than permissible deductions as set forth in Regulations, 29 CFR part 3;
 - (iii) That each laborer or mechanic has been paid not less than the applicable wage rates and fringe benefits or cash equivalents for the classification of work performed, as specified in the applicable wage determination incorporated into the contract.
 - (3) The weekly submission of a properly executed certification set forth on the reverse side of Optional Form WH-347 shall satisfy the requirement for submission of the "Statement of Compliance" required by paragraph 3.b.(2) of this section.
 - (4) The falsification of any of the above certifications may subject the contractor or subcontractor to civil or criminal prosecution under section 1001 of title 18 and section 231 of title 31 of the United States Code.
- c. The contractor or subcontractor shall make the records required under paragraph 3.a. of this section available for inspection, copying, or transcription by authorized representatives of the contracting agency, the State DOT, the FHWA, or the Department of Labor, and shall permit such representatives to interview employees during working hours on the job. If the contractor or subcontractor fails to submit the required records or to make them available, the FHWA may, after written notice to the contractor, the contracting agency or the State DOT, take such action as may be necessary to cause the suspension of any further payment, advance, or guarantee of funds. Furthermore, failure to submit the required records upon request or to make such records available may be grounds for debarment action pursuant to 29 CFR 5.12.

4. Apprentices and trainees

- a. Apprentices (programs of the USDOL). Apprentices will be permitted to work at less than the predetermined rate for the work they performed when they are employed pursuant to and individually registered in a bona fide apprenticeship program registered with the U.S. Department of Labor, Employment and Training Administration, Office of Apprenticeship Training, Employer and Labor Services, or with a State Apprenticeship Agency recognized by the Office, or if a person is employed in his or her first 90 days of probationary employment as an apprentice in such an apprenticeship program, who is not individually registered in the program, but who has been certified by the Office of Apprenticeship Training, Employer and Labor Services or a State Apprenticeship Agency (where appropriate) to be eligible for probationary employment as an apprentice.

The allowable ratio of apprentices to journeymen on the job site in any craft classification shall not be greater than the ratio permitted to the contractor as to the entire work force under the registered program. Any worker listed on a payroll at an apprentice wage rate, who is not registered or otherwise employed as stated above, shall be paid not less than the applicable wage rate on the wage determination for the classification of work actually performed. In addition, any apprentice performing work on the job site in excess of the ratio permitted under the registered program shall be paid not less than the applicable wage rate on the wage determination for the work actually performed. Where a contractor is performing construction on a project in a locality other than that in which its program is registered, the ratios and wage rates (expressed in percentages of the journeyman's hourly rate) specified in the contractor's or subcontractor's registered program shall be observed.

Every apprentice must be paid at not less than the rate specified in the registered program for the apprentice's level of progress, expressed as a percentage of the journeymen hourly rate specified in the applicable wage determination. Apprentices shall be paid fringe benefits in accordance with the provisions of the apprenticeship program. If the apprenticeship program does not specify fringe benefits, apprentices must be paid the full amount of fringe benefits listed on the wage determination for the applicable classification. If the Administrator determines that a different practice prevails for the applicable apprentice classification, fringes shall be paid in accordance with that determination.

In the event the Office of Apprenticeship Training, Employer and Labor Services, or a State Apprenticeship Agency recognized by the Office, withdraws approval of an apprenticeship program, the contractor will no longer be permitted to utilize apprentices at less than the applicable predetermined rate for the work performed until an acceptable program is approved.

- b. Trainees (programs of the USDOL). Except as provided in 29 CFR 5.16, trainees will not be permitted to work at less than the predetermined rate for the work performed unless they are employed pursuant to and individually registered in a program which has received prior approval, evidenced by formal certification by the U.S. Department of Labor, Employment and Training Administration.

The ratio of trainees to journeymen on the job site shall not be greater than permitted under the plan approved by the Employment and Training Administration.

Every trainee must be paid at not less than the rate specified in the approved program for the trainee's level of progress, expressed as a percentage of the journeyman hourly rate specified in the applicable wage determination. Trainees shall be paid fringe benefits in accordance with the provisions of the trainee program. If the trainee program does not mention fringe benefits, trainees shall be paid the full amount of fringe benefits listed on the wage determination unless the Administrator of the Wage and Hour Division determines that there is an apprenticeship program associated with the corresponding journeyman wage rate on the wage determination which provides for less than full fringe benefits for apprentices. Any employee listed on the payroll at a trainee rate who is not registered and participating in a training plan approved by the Employment and Training Administration shall be paid not less than the applicable wage rate on the wage determination for the classification of work actually performed. In addition, any trainee performing work on the job site in excess of the ratio permitted under the registered program shall be paid not less than the applicable wage rate on the wage determination for the work actually performed.

- In the event the Employment and Training Administration withdraws approval of a training program, the contractor will no longer be permitted to utilize trainees at less than the applicable predetermined rate for the work performed until an acceptable program is approved.
- c. Equal employment opportunity. The utilization of apprentices, trainees and journeymen under this part shall be in conformity with the equal employment opportunity requirements of Executive Order 11246, as amended, and 29 CFR part 30.
 - d. Apprentices and Trainees (programs of the U.S. DOT). Apprentices and trainees working under apprenticeship and skill training programs which have been certified by the Secretary of Transportation as promoting EEO in connection with Federal-aid highway construction programs are not subject to the requirements of paragraph 4 of this Section IV. The straight time hourly wage rates for apprentices and trainees under such programs will be established by the particular programs. The ratio of apprentices and trainees to journeymen shall not be greater than permitted by the terms of the particular program.
5. **Compliance with Copeland Act requirements.** The contractor shall comply with the requirements of 29 CFR part 3, which are incorporated by reference in this contract.
 6. **Subcontracts.** The contractor or subcontractor shall insert Form FHWA-1273 in any subcontracts and also require the subcontractors to include Form FHWA-1273 in any lower tier subcontracts. The prime contractor shall be responsible for the compliance by any subcontractor or lower tier subcontractor with all the contract clauses in 29 CFR 5.5.
 7. **Contract termination: debarment.** A breach of the contract clauses in 29 CFR 5.5 may be grounds for termination of the contract, and for debarment as a contractor and a subcontractor as provided in 29 CFR 5.12.
 8. **Compliance with Davis-Bacon and Related Act requirements.** All rulings and interpretations of the Davis-Bacon and Related Acts contained in 29 CFR parts 1, 3, and 5 are herein incorporated by reference in this contract.
 9. **Disputes concerning labor standards.** Disputes arising out of the labor standards provisions of this contract shall not be subject to the general disputes clause of this contract. Such disputes shall be resolved in accordance with the procedures of the Department of Labor set forth in 29 CFR parts 5, 6, and 7. Disputes within the meaning of this clause include disputes between the contractor (or any of its subcontractors) and the contracting agency, the U.S. Department of Labor, or the employees or their representatives.
 10. **Certification of eligibility.**
 - a. By entering into this contract, the contractor certifies that neither it (nor he or she) nor any person or firm who has an interest in the contractor's firm is a person or firm ineligible to be awarded Government contracts by virtue of section 3(a) of the Davis-Bacon Act or 29 CFR 5.12(a)(1).
 - b. No part of this contract shall be subcontracted to any person or firm ineligible for award of a Government contract by virtue of section 3(a) of the Davis-Bacon Act or 29 CFR 5.12(a)(1).
 - c. The penalty for making false statements is prescribed in the U.S. Criminal Code, 18 U.S.C. 1001.

V. CONTRACT WORK HOURS AND SAFETY STANDARDS ACT

The following clauses apply to any Federal-aid construction contract in an amount in excess of \$100,000 and subject to the overtime provisions of the Contract Work Hours and Safety Standards Act. These clauses shall be inserted in addition to the clauses required by 29 CFR 5.5(a) or 29 CFR 4.6. As used in this paragraph, the terms laborers and mechanics include watchmen and guards.

1. **Overtime requirements.** No contractor or subcontractor contracting for any part of the contract work which may require or involve the employment of laborers or mechanics shall require or permit any such laborer or mechanic in any workweek in which he or she is employed on such work to work in excess of forty hours in such workweek unless such laborer or mechanic receives compensation at a rate not less than one and one-half times the basic rate of pay for all hours worked in excess of forty hours in such workweek.
2. **Violation; liability for unpaid wages; liquidated damages.** In the event of any violation of the clause set forth in paragraph (1.) of this section, the contractor and any subcontractor responsible therefor shall be liable for the unpaid wages. In addition, such contractor and subcontractor shall be liable to the United States (in the case of work done under contract for the District of Columbia or a territory, to such District or to such territory), for liquidated damages. Such liquidated damages shall be computed with respect to each individual laborer or mechanic, including watchmen and guards, employed in violation of the clause set forth in paragraph (1.) of this section, in the sum of \$10 for each calendar day on which such individual was required or permitted to work in excess of the standard workweek of forty hours without payment of the overtime wages required by the clause set forth in paragraph (1.) of this section.
3. **Withholding for unpaid wages and liquidated damages.** The FHWA or the contacting agency shall upon its own action or upon written request of an authorized representative of the Department of Labor withhold or cause to be withheld, from any moneys payable on account of work performed by the contractor or subcontractor under any such contract or any other Federal contract with the same prime contractor, or any other federally-assisted contract subject to the Contract Work Hours and Safety Standards Act, which is held by the same prime contractor, such sums as may be determined to be necessary to satisfy any liabilities of such contractor or subcontractor for unpaid wages and liquidated damages as provided in the clause set forth in paragraph (2.) of this section.
4. **Subcontracts.** The contractor or subcontractor shall insert in any subcontracts the clauses set forth in paragraph (1.) through (4.) of this section and also a clause requiring the subcontractors to include these clauses in any lower tier subcontracts. The prime contractor shall be responsible for compliance by any subcontractor or lower tier subcontractor with the clauses set forth in paragraphs (1.) through (4.) of this section.

VI. SUBLETTING OR ASSIGNING THE CONTRACT

This provision is applicable to all Federal-aid construction contracts on the National Highway System.

1. The contractor shall perform with its own organization contract work amounting to not less than 30 percent (or a greater percentage if specified elsewhere in the contract) of the total original contract price, excluding any specialty items designated by the contracting agency. Specialty items may be performed by subcontract and the amount of any such specialty items performed may be deducted from the total original contract price before computing the amount of work required to be performed by the contractor's own organization (23 CFR 635.116).
 - a. The term "perform work with its own organization" refers to workers employed or leased by the prime contractor, and equipment owned or rented by the prime contractor, with or without operators. Such term does not include employees or equipment of a subcontractor or lower tier subcontractor, agents of the prime contractor, or any other assignees. The term may include payments for the costs of hiring leased employees from an employee leasing firm meeting all relevant Federal and State regulatory requirements. Leased employees may only be included in this term if the prime contractor meets all of the following conditions:
 - (1) the prime contractor maintains control over the supervision of the day-to-day activities of the leased employees;

- (2) the prime contractor remains responsible for the quality of the work of the leased employees;
 - (3) the prime contractor retains all power to accept or exclude individual employees from work on the project; and
 - (4) the prime contractor remains ultimately responsible for the payment of predetermined minimum wages, the submission of payrolls, statements of compliance and all other Federal regulatory requirements.
- b. "Specialty Items" shall be construed to be limited to work that requires highly specialized knowledge, abilities, or equipment not ordinarily available in the type of contracting organizations qualified and expected to bid or propose on the contract as a whole and in general are to be limited to minor components of the overall contract.
2. The contract amount upon which the requirements set forth in paragraph (1) of Section VI is computed includes the cost of material and manufactured products which are to be purchased or produced by the contractor under the contract provisions.
 3. The contractor shall furnish (a) a competent superintendent or supervisor who is employed by the firm, has full authority to direct performance of the work in accordance with the contract requirements, and is in charge of all construction operations (regardless of who performs the work) and (b) such other of its own organizational resources (supervision, management, and engineering services) as the contracting officer determines is necessary to assure the performance of the contract.
 4. No portion of the contract shall be sublet, assigned or otherwise disposed of except with the written consent of the contracting officer, or authorized representative, and such consent when given shall not be construed to relieve the contractor of any responsibility for the fulfillment of the contract. Written consent will be given only after the contracting agency has assured that each subcontract is evidenced in writing and that it contains all pertinent provisions and requirements of the prime contract.
 5. The 30% self-performance requirement of paragraph (1) is not applicable to design-build contracts; however, contracting agencies may establish their own self-performance requirements.

VII. SAFETY: ACCIDENT PREVENTION

This provision is applicable to all Federal-aid construction contracts and to all related subcontracts.

1. In the performance of this contract the contractor shall comply with all applicable Federal, State, and local laws governing safety, health, and sanitation (23 CFR 635). The contractor shall provide all safeguards, safety devices and protective equipment and take any other needed actions as it determines, or as the contracting officer may determine, to be reasonably necessary to protect the life and health of employees on the job and the safety of the public and to protect property in connection with the performance of the work covered by the contract.
2. It is a condition of this contract, and shall be made a condition of each subcontract, which the contractor enters into pursuant to this contract, that the contractor and any subcontractor shall not permit any employee, in performance of the contract, to work in surroundings or under conditions which are unsanitary, hazardous or dangerous to his/her health or safety, as determined under construction safety and health standards (29 CFR 1926) promulgated by the Secretary of Labor, in accordance with Section 107 of the Contract Work Hours and Safety Standards Act (40 U.S.C. 3704).
3. Pursuant to 29 CFR 1926.3, it is a condition of this contract that the Secretary of Labor or authorized representative thereof, shall have right of entry to any site of contract performance to inspect or investigate the matter of compliance with the construction safety and health standards and to carry out the duties of the Secretary under Section 107 of the Contract Work Hours and Safety Standards Act (40 U.S.C.3704).

VIII. FALSE STATEMENTS CONCERNING HIGHWAY PROJECTS

This provision is applicable to all Federal-aid construction contracts and to all related subcontracts.

In order to assure high quality and durable construction in conformity with approved plans and specifications and a high degree of reliability on statements and representations made by engineers, contractors, suppliers, and workers on Federal-aid highway projects, it is essential that all persons concerned with the project perform their functions as carefully, thoroughly, and honestly as possible. Willful falsification, distortion, or misrepresentation with respect to any facts related to the project is a violation of Federal law. To prevent any misunderstanding regarding the seriousness of these and similar acts, Form FHWA-1022 shall be posted on each Federal-aid highway project (23 CFR 635) in one or more places where it is readily available to all persons concerned with the project:

18 U.S.C. 1020 reads as follows:

"Whoever, being an officer, agent, or employee of the United States, or of any State or Territory, or whoever, whether a person, association, firm, or corporation, knowingly makes any false statement, false representation, or false report as to the character, quality, quantity, or cost of the material used or to be used, or the quantity or quality of the work performed or to be performed, or the cost thereof in connection with the submission of plans, maps, specifications, contracts, or costs of construction on any highway or related project submitted for approval to the Secretary of Transportation; or

Whoever knowingly makes any false statement, false representation, false report or false claim with respect to the character, quality, quantity, or cost of any work performed or to be performed, or materials furnished or to be furnished, in connection with the construction of any highway or related project approved by the Secretary of Transportation; or

Whoever knowingly makes any false statement or false representation as to material fact in any statement, certificate, or report submitted pursuant to provisions of the Federal-aid Roads Act approved July 1, 1916, (39 Stat. 355), as amended and supplemented;

Shall be fined under this title or imprisoned not more than 5 years or both."

IX. IMPLEMENTATION OF CLEAN AIR ACT AND FEDERAL WATER POLLUTION CONTROL ACT

This provision is applicable to all Federal-aid construction contracts and to all related subcontracts.

By submission of this bid/proposal or the execution of this contract, or subcontract, as appropriate, the bidder, proposer, Federal-aid construction contractor, or subcontractor, as appropriate, will be deemed to have stipulated as follows:

1. That any person who is or will be utilized in the performance of this contract is not prohibited from receiving an award due to a violation of Section 508 of the Clean Water Act or Section 306 of the Clean Air Act.
2. That the contractor agrees to include or cause to be included the requirements of paragraph (1) of this Section X in every subcontract, and further agrees to take such action as the contracting agency may direct as a means of enforcing such requirements.

X. CERTIFICATION REGARDING DEBARMENT, SUSPENSION, INELIGIBILITY AND VOLUNTARY EXCLUSION

This provision is applicable to all Federal-aid construction contracts, design-build contracts, subcontracts, lower-tier subcontracts, purchase orders, lease agreements, consultant contracts or any other covered transaction requiring FHWA approval or that is estimated to cost \$25,000 or more – as defined in 2 CFR Parts 180 and 1200.

1. Instructions for Certification – First Tier Participants:

- a. By signing and submitting this proposal, the prospective first tier participant is providing the certification set out below.
- b. The inability of a person to provide the certification set out below will not necessarily result in denial of participation in this covered transaction. The prospective first tier participant shall submit an explanation of why it cannot provide the certification set out below. The certification or explanation will be considered in connection with the department or agency's determination whether to enter into this transaction. However, failure of the prospective first tier participant to furnish a certification or an explanation shall disqualify such a person from participation in this transaction.
- c. The certification in this clause is a material representation of fact upon which reliance was placed when the contracting agency determined to enter into this transaction. If it is later determined that the prospective participant knowingly rendered an erroneous certification, in addition to other remedies available to the Federal Government, the contracting agency may terminate this transaction for cause of default.
- d. The prospective first tier participant shall provide immediate written notice to the contracting agency to whom this proposal is submitted if any time the prospective first tier participant learns that its certification was erroneous when submitted or has become erroneous by reason of changed circumstances.
- e. The terms "covered transaction," "debarred," "suspended," "ineligible," "participant," "person," "principal," and "voluntarily excluded," as used in this clause, are defined in 2 CFR Parts 180 and 1200. "First Tier Covered Transactions" refers to any covered transaction between a grantee or subgrantee of Federal funds and a participant (such as the prime or general contract). "Lower Tier Covered Transactions" refers to any covered transaction under a First Tier Covered Transaction (such as subcontracts). "First Tier Participant" refers to the participant who has entered into a covered transaction with a grantee or subgrantee of Federal funds (such as the prime or general contractor). "Lower Tier Participant" refers any participant who has entered into a covered transaction with a First Tier Participant or other Lower Tier Participants (such as subcontractors and suppliers).
- f. The prospective first tier participant agrees by submitting this proposal that, should the proposed covered transaction be entered into, it shall not knowingly enter into any lower tier covered transaction with a person who is debarred, suspended, declared ineligible, or voluntarily excluded from participation in this covered transaction, unless authorized by the department or agency entering into this transaction.
- g. The prospective first tier participant further agrees by submitting this proposal that it will include the clause titled "Certification Regarding Debarment, Suspension, Ineligibility and Voluntary Exclusion-Lower Tier Covered Transactions," provided by the department or contracting agency, entering into this covered transaction, without modification, in all lower tier covered transactions and in all solicitations for lower tier covered transactions exceeding the \$25,000 threshold.
- h. A participant in a covered transaction may rely upon a certification of a prospective participant in a lower tier covered transaction that is not debarred, suspended, ineligible, or voluntarily excluded from the covered transaction, unless it knows that the certification is erroneous. A participant is responsible for ensuring that its principals are not suspended, debarred, or otherwise ineligible to participate in covered transactions. To verify the eligibility of its principals, as well as the eligibility of any lower tier prospective participants, each participant may, but is not required to, check the Excluded Parties List System website (<https://www.epls.gov/>), which is compiled by the General Services Administration.
- i. Nothing contained in the foregoing shall be construed to require the establishment of a system of records in order to render in good faith the certification required by this clause. The knowledge and information of the prospective participant is not required to exceed that which is normally possessed by a prudent person in the ordinary course of business dealings.
- j. Except for transactions authorized under paragraph (f) of these instructions, if a participant in a covered transaction knowingly enters into a lower tier covered transaction with a person who is suspended, debarred, ineligible, or voluntarily excluded from participation in this transaction, in addition to other remedies available to the Federal Government, the department or agency may terminate this transaction for cause or default.

* * * * *

2. Certification Regarding Debarment, Suspension, Ineligibility and Voluntary Exclusion – First Tier Participants:

- a. The prospective first tier participant certifies to the best of its knowledge and belief, that it and its principals:
 - (1) Are not presently debarred, suspended, proposed for debarment, declared ineligible, or voluntarily excluded from participating in covered transactions by any Federal department or agency;
 - (2) Have not within a three-year period preceding this proposal been convicted of or had a civil judgment rendered against them for commission of fraud or a criminal offense in connection with obtaining, attempting to obtain, or performing a public (Federal, State or local) transaction or contract under a public transaction; violation of Federal or State antitrust statutes or commission of embezzlement, theft, forgery, bribery, falsification or destruction of records, making false statements, or receiving stolen property;
 - (3) Are not presently indicted for or otherwise criminally or civilly charged by a governmental entity (Federal, State or local) with commission of any of the offenses enumerated in paragraph (a)(2) of this certification; and
 - (4) Have not within a three-year period preceding this application/proposal had one or more public transactions (Federal, State or local) terminated for cause or default.
- b. Where the prospective participant is unable to certify to any of the statements in this certification, such prospective participant shall attach an explanation to this proposal.

2. Instructions for Certification - Lower Tier Participants:

(Applicable to all subcontracts, purchase orders and other lower tier transactions requiring prior FHWA approval or estimated to cost \$25,000 or more - 2 CFR Parts 180 and 1200)

- a. By signing and submitting this proposal, the prospective lower tier is providing the certification set out below.
- b. The certification in this clause is a material representation of fact upon which reliance was placed when this transaction was entered into. If it is later determined that the prospective lower tier participant knowingly rendered an erroneous certification, in addition to other remedies available to the Federal Government, the department, or agency with which this transaction originated may pursue available remedies, including suspension and/or debarment.

- c. The prospective lower tier participant shall provide immediate written notice to the person to which this proposal is submitted if at any time the prospective lower tier participant learns that its certification was erroneous by reason of changed circumstances.
- d. The terms "covered transaction," "debarred," "suspended," "ineligible," "participant," "person," "principal," and "voluntarily excluded," as used in this clause, are defined in 2 CFR Parts 180 and 1200. You may contact the person to which this proposal is submitted for assistance in obtaining a copy of those regulations. "First Tier Covered Transactions" refers to any covered transaction between a grantee or subgrantee of Federal funds and a participant (such as the prime or general contract). "Lower Tier Covered Transactions" refers to any covered transaction under a First Tier Covered Transaction (such as subcontracts). "First Tier Participant" refers to the participant who has entered into a covered transaction with a grantee or subgrantee of Federal funds (such as the prime or general contractor). "Lower Tier Participant" refers any participant who has entered into a covered transaction with a First Tier Participant or other Lower Tier Participants (such as subcontractors and suppliers).
- e. The prospective lower tier participant agrees by submitting this proposal that, should the proposed covered transaction be entered into, it shall not knowingly enter into any lower tier covered transaction with a person who is debarred, suspended, declared ineligible, or voluntarily excluded from participation in this covered transaction, unless authorized by the department or agency with which this transaction originated.
- f. The prospective lower tier participant further agrees by submitting this proposal that it will include this clause titled "Certification Regarding Debarment, Suspension, Ineligibility and Voluntary Exclusion-Lower Tier Covered Transaction," without modification, in all lower tier covered transactions and in all solicitations for lower tier covered transactions exceeding the \$25,000 threshold.
- g. A participant in a covered transaction may rely upon a certification of a prospective participant in a lower tier covered transaction that is not debarred, suspended, ineligible, or voluntarily excluded from the covered transaction, unless it knows that the certification is erroneous. A participant is responsible for ensuring that its principals are not suspended, debarred, or otherwise ineligible to participate in covered transactions. To verify the eligibility of its principals, as well as the eligibility of any lower tier prospective participants, each participant may, but is not required to, check the Excluded Parties List System website (<https://www.epls.gov/>), which is compiled by the General Services Administration.
- h. Nothing contained in the foregoing shall be construed to require establishment of a system of records in order to render in good faith the certification required by this clause. The knowledge and information of participant is not required to exceed that which is normally possessed by a prudent person in the ordinary course of business dealings.
- i. Except for transactions authorized under paragraph e of these instructions, if a participant in a covered transaction knowingly enters into a lower tier covered transaction with a person who is suspended, debarred, ineligible, or voluntarily excluded from participation in this transaction, in addition to other remedies available to the Federal Government, the department or agency with which this transaction originated may pursue available remedies, including suspension and/or debarment.

* * * * *

Certification Regarding Debarment, Suspension, Ineligibility and Voluntary Exclusion--Lower Tier Participants:

1. The prospective lower tier participant certifies, by submission of this proposal, that neither it nor its principals is presently debarred, suspended, proposed for debarment, declared ineligible, or voluntarily excluded from participating in covered transactions by any Federal department or agency.
2. Where the prospective lower tier participant is unable to certify to any of the statements in this certification, such prospective participant shall attach an explanation to this proposal.

* * * * *

XI. CERTIFICATION REGARDING USE OF CONTRACT FUNDS FOR LOBBYING

This provision is applicable to all Federal-aid construction contracts and to all related subcontracts which exceed \$100,000 (49 CFR 20).

1. The prospective participant certifies, by signing and submitting this bid or proposal, to the best of his or her knowledge and belief, that:
 - a. No Federal appropriated funds have been paid or will be paid, by or on behalf of the undersigned, to any person for influencing or attempting to influence an officer or employee of any Federal agency, a Member of Congress, an officer or employee of Congress, or an employee of a Member of Congress in connection with the awarding of any Federal contract, the making of any Federal grant, the making of any Federal loan, the entering into of any cooperative agreement, and the extension, continuation, renewal, amendment, or modification of any Federal contract, grant, loan, or cooperative agreement.
 - b. If any funds other than Federal appropriated funds have been paid or will be paid to any person for influencing or attempting to influence an officer or employee of any Federal agency, a Member of Congress, an officer or employee of Congress, or an employee of a Member of Congress in connection with this Federal contract, grant, loan, or cooperative agreement, the undersigned shall complete and submit Standard Form-LLL, "Disclosure Form to Report Lobbying," in accordance with its instructions.
2. This certification is a material representation of fact upon which reliance was placed when this transaction was made or entered into. Submission of this certification is a prerequisite for making or entering into this transaction imposed by 31 U.S.C. 1352. Any person who fails to file the required certification shall be subject to a civil penalty of not less than \$10,000 and not more than \$100,000 for each such failure.
3. The prospective participant also agrees by submitting its bid or proposal that the participant shall require that the language of this certification be included in all lower tier subcontracts, which exceed \$100,000 and that all such recipients shall certify and disclose accordingly.

STANDARD SPECIAL PROVISION**ON-THE-JOB TRAINING**

(10-16-07) (Rev. 4-21-15)

Z-10

Description

The North Carolina Department of Transportation will administer a custom version of the Federal On-the-Job Training (OJT) Program, commonly referred to as the Alternate OJT Program. All contractors (existing and newcomers) will be automatically placed in the Alternate Program. Standard OJT requirements typically associated with individual projects will no longer be applied at the project level. Instead, these requirements will be applicable on an annual basis for each contractor administered by the OJT Program Manager.

On the Job Training shall meet the requirements of 23 CFR 230.107 (b), 23 USC – Section 140, this provision and the On-the-Job Training Program Manual.

The Alternate OJT Program will allow a contractor to train employees on Federal, State and privately funded projects located in North Carolina. However, priority shall be given to training employees on NCDOT Federal-Aid funded projects.

Minorities and Women

Developing, training and upgrading of minorities and women toward journeyman level status is a primary objective of this special training provision. Accordingly, the Contractor shall make every effort to enroll minority and women as trainees to the extent that such persons are available within a reasonable area of recruitment. This training commitment is not intended, and shall not be used, to discriminate against any applicant for training, whether a member of a minority group or not.

Assigning Training Goals

The Department, through the OJT Program Manager, will assign training goals for a calendar year based on the contractors' past three years' activity and the contractors' anticipated upcoming year's activity with the Department. At the beginning of each year, all contractors eligible will be contacted by the Department to determine the number of trainees that will be assigned for the upcoming calendar year. At that time the Contractor shall enter into an agreement with the Department to provide a self-imposed on-the-job training program for the calendar year. This agreement will include a specific number of annual training goals agreed to by both parties. The number of training assignments may range from 1 to 15 per contractor per calendar year. The Contractor shall sign an agreement to fulfill their annual goal for the year.\

Training Classifications

The Contractor shall provide on-the-job training aimed at developing full journeyman level workers in the construction craft/operator positions. Preference shall be given to providing training in the following skilled work classifications:

Equipment Operators	Office Engineers
Truck Drivers	Estimators
Carpenters	Iron / Reinforcing Steel Workers
Concrete Finishers	Mechanics
Pipe Layers	Welders

The Department has established common training classifications and their respective training requirements that may be used by the contractors. However, the classifications established are not all-inclusive. Where the training is oriented toward construction applications, training will be allowed in lower-level management positions such as office engineers and estimators. Contractors shall submit new classifications for specific job functions that their employees are performing. The Department will review and recommend for acceptance to FHWA the new classifications proposed by contractors, if applicable. New classifications shall meet the following requirements:

Proposed training classifications are reasonable and realistic based on the job skill classification needs, and

The number of training hours specified in the training classification is consistent with common practices and provides enough time for the trainee to obtain journeyman level status.

The Contractor may allow trainees to be trained by a subcontractor provided that the Contractor retains primary responsibility for meeting the training and this provision is made applicable to the subcontract. However, only the Contractor will receive credit towards the annual goal for the trainee.

Where feasible, 25 percent of apprentices or trainees in each occupation shall be in their first year of apprenticeship or training. The number of trainees shall be distributed among the work classifications on the basis of the contractor's needs and the availability of journeymen in the various classifications within a reasonable area of recruitment.

No employee shall be employed as a trainee in any classification in which they have successfully completed a training course leading to journeyman level status or in which they have been employed as a journeyman.

Records and Reports

The Contractor shall maintain enrollment, monthly and completion reports documenting company compliance under these contract documents. These documents and any other information as requested shall be submitted to the OJT Program Manager.

Upon completion and graduation of the program, the Contractor shall provide each trainee with a certification Certificate showing the type and length of training satisfactorily completed.

Trainee Interviews

All trainees enrolled in the program will receive an initial and Trainee/Post graduate interview conducted by the OJT program staff.

Trainee Wages

Contractors shall compensate trainees on a graduating pay scale based upon a percentage of the prevailing minimum journeyman wages (Davis-Bacon Act). Minimum pay shall be as follows:

60 percent	of the journeyman wage for the first half of the training period
75 percent	of the journeyman wage for the third quarter of the training period
90 percent	of the journeyman wage for the last quarter of the training period

In no instance shall a trainee be paid less than the local minimum wage. The Contractor shall adhere to the minimum hourly wage rate that will satisfy both the NC Department of Labor (NCDOL) and the Department.

Achieving or Failing to Meet Training Goals

The Contractor will be credited for each trainee employed by him on the contract work who is currently enrolled or becomes enrolled in an approved program and who receives training for at least 50 percent of the specific program requirement. Trainees will be allowed to be transferred between projects if required by the Contractor's scheduled workload to meet training goals.

If a contractor fails to attain their training assignments for the calendar year, they may be taken off the NCDOT's Bidders List.

Measurement and Payment

No compensation will be made for providing required training in accordance with these contract documents.

STANDARD SPECIAL PROVISION
MINIMUM WAGES
GENERAL DECISION NC150101 01/23/2015 NC101

Z-101

Date: January 23, 2015

General Decision Number: NC150101 01/23/2015 NC101

Superseded General Decision Numbers: NC20140101

State: North Carolina

Construction Type: HIGHWAY

COUNTIES:

Alamance	Forsyth	Randolph
Anson	Gaston	Rockingham
Cabarrus	Guilford	Stokes
Chatham	Mecklenburg	Union
Davie	Orange	Yadkin
Durham	Person	

HIGHWAY CONSTRUCTION PROJECTS (excluding tunnels, building structures in rest area projects & railroad construction; bascule, suspension & spandrel arch bridges designed for commercial navigation, bridges involving marine construction; and other major bridges).

Note: Executive Order (EO) 13658 establishes an hourly minimum wage of \$10.10 for 2015 that applies to all contracts subject to the Davis-Bacon Act for which the solicitation is issued on or after January 1, 2015. If this contract is covered by the EO, the contractor must pay all workers in any classification listed on this wage determination at least \$10.10 (or the applicable wage rate listed on this wage determination, if it is higher) for all hours spent performing on the contract. The EO minimum wage rate will be adjusted annually. Additional information on contractor requirements and worker protections under the EO is available at www.dol.gov/whd/govcontracts.

Modification Number

0

1

Publication Date

01/02/2015

01/23/2015

SUNC2014-003 11/14/2014

	Rates	Fringes
BLASTER	18.64	
CARPENTER	13.68	.05
CEMENT MASON/CONCRETE FINISHER	13.93	
ELECTRICIAN		
Electrician	18.79	2.72
Telecommunications Technician	15.19	1.25
IRONWORKER	13.30	
LABORER		
Asphalt Raker and Spreader	12.78	

	Rates	Fringes
Asphalt Screed/Jackman	14.50	
Carpenter Tender	12.51	.27
Cement Mason/Concrete Finisher Tender	11.04	
Common or General	10.40	.01
Guardrail/Fence Installer	13.22	
Pipelayer	12.43	
Traffic Signal/Lighting Installer	15.65	.24
PAINTER		
Bridge	23.77	
POWER EQUIPMENT OPERATORS		
Asphalt Broom Tractor	10.00	
Bulldozer Fine	16.13	
Bulldozer Rough	14.36	
Concrete Grinder/Groover	17.92	
Crane Boom Trucks	18.19	
Crane Other	19.83	
Crane Rough/All-Terrain	19.10	
Drill Operator Rock	14.28	
Drill Operator Structure	20.89	
Excavator Fine	16.95	
Excavator Rough	13.63	
Grader/Blade Fine	19.84	
Grader/Blade Rough	15.47	
Loader 2 Cubic Yards or Less	13.31	
Loader Greater Than 2 Cubic Yards	16.19	
Material Transfer Vehicle (Shuttle Buggy)	15.44	
Mechanic	17.51	
Milling Machine	15.22	
Off-Road Hauler/Water Tanker	11.83	
Oiler/Greaser	14.16	
Pavement Marking Equipment	12.05	
Paver Asphalt	15.97	
Paver Concrete	18.20	
Roller Asphalt Breakdown	12.79	
Roller Asphalt Finish	13.76	
Roller Other	12.08	
Scraper Finish	12.65	
Scraper Rough	11.50	
Slip Form Machine	19.60	
Tack Truck/Distributor Operator	14.82	
TRUCK DRIVER		
GVWR of 26,000 Lbs or Greater	11.45	
GVWR of 26,000 Lbs or Less	13.57	.03

Welders – Receive rate prescribed for craft performing operation to which welding is incidental.

Unlisted classifications needed for work not included within the scope of the classifications listed may be added after award only as provided in the labor standards contract clauses (29 CFR 5.5(a)(1)(ii)).

The body of each wage determination lists the classification and wage rates that have been found to be prevailing for the cited type(s) of construction in the area covered by the wage determination. The classifications are listed in alphabetical order of "identifiers" that indicate whether the particular rate is a union rate (current union negotiated rate for local), a survey rate (weighted average rate) or a union average rate (weighted union average rate).

Union Rate Identifiers

A four letter classification abbreviation identifier enclosed in dotted lines beginning with characters other than "SU" or "UAVG" denotes that the union classification and rate were prevailing for that classification in the survey. Example: PLUM0198-005 07/01/2014. PLUM is an abbreviation identifier of the union which prevailed in the survey for this classification, which in this example would be Plumbers. 0198 indicates the local union number or district council number where applicable, i.e., Plumbers Local 0198. The next number, 005 in the example, is an internal number used in processing the wage determination. 07/01/2014 is the effective date of the most current negotiated rate, which in this example is July 1, 2014.

Union prevailing wage rates are updated to reflect all rate changes in the collective bargaining agreement (CBA) governing this classification and rate.

Survey Rate Identifiers

Classifications listed under the "SU" identifier indicate that no one rate prevailed for this classification in the survey and the published rate is derived by computing a weighted average rate based on all the rates reported in the survey for that classification. As this weighted average rate includes all rates reported in the survey, it may include both union and non-union rates. Example: SULA2012-007 5/13/2014. SU indicates the rates are survey rates based on a weighted average calculation of rates and are not majority rates. LA indicates the State of Louisiana. 2012 is the year of survey on which these classifications and rates are based. The next number, 007 in the example, is an internal number used in producing the wage determination. 5/13/2014 indicates the survey completion date for the classifications and rates under that identifier.

Survey wage rates are not updated and remain in effect until a new survey is conducted.

Union Average Rate Identifiers

Classification(s) listed under the UAVG identifier indicate that no single majority rate prevailed for those classifications; however, 100% of the data reported for the classifications was union data. EXAMPLE: UAVG-OH-0010 08/29/2014. UAVG indicates that the rate is a weighted union average rate. OH indicates the state. The next number, 0010 in the example, is an internal number used in producing the wage determination. 08/29/2014 indicates the survey completion date for the classifications and rates under that identifier.

A UAVG rate will be updated once a year, usually in January of each year, to reflect a weighted average of the current negotiated/CBA rate of the union locals from which the rate is based.

WAGE DETERMINATION APPEALS PROCESS

1.) Has there been an initial decision in the matter? This can be:

- * an existing published wage determination
- * a survey underlying a wage determination
- * a Wage and Hour Division letter setting forth a position on a wage determination matter
- * a conformance (additional classification and rate) ruling

On survey related matters, initial contact, including requests for summaries of surveys, should be with the Wage and Hour Regional Office for the area in which the survey was conducted because those Regional Offices have responsibility for the Davis-Bacon survey program. If the response from this initial contact is not satisfactory, then the process described in 2.) and 3.) should be followed.

With regard to any other matter not yet ripe for the formal process described here, initial contact should be with the Branch of Construction Wage Determinations. Write to:

Branch of Construction Wage Determinations
Wage and Hour Division
U. S. Department of Labor
200 Constitution Avenue, N.W.
Washington, D.C. 20210

2.) If the answer to the question in 1.) is yes, then an interested party (those affected by the action) can request review and reconsideration from the Wage and Hour Administrator (See 29 CFR Part 1.8 and 29 CFR Part 7). Write to:

Wage and Hour Administrator
U.S. Department of Labor
200 Constitution Avenue, N.W.
Washington, D.C. 20210

The request should be accompanied by a full statement of the interested party's position and by any information (wage payment data, project description, area practice material, etc.) that the requestor considers relevant to the issue.

3.) If the decision of the Administrator is not favorable, an interested party may appeal directly to the Administrative Review Board (formerly the Wage Appeals Board). Write to:

Administrative Review Board
U.S. Department of Labor
200 Constitution Avenue, N.W.
Washington, D.C. 20210

4.) All decisions by the Administrative Review Board are final.

END OF GENERAL DECISION

PROJECT SPECIAL PROVISIONS

GEOTECHNICAL

MSE RETAINING WALLS (3/17/2015)

GT-1.1 - GT-1.11

STANDARD SHORING (3/17/2015)

GT-2.1 - GT-2.4

TEMPORARY SOIL NAIL WALLS (3/17/2015)

GT-3.1 - GT-3.9

DocuSigned by:
Geotechnical Engineering Unit
3288528EC798426...

1/28/2015

MECHANICALLY STABILIZED EARTH RETAINING WALLS**(3-17-15)****1.0 GENERAL**

Construct mechanically stabilized earth (MSE) retaining walls consisting of steel or geosynthetic reinforcement in the reinforced zone connected to vertical facing elements. Use precast concrete panels for vertical facing elements and coarse aggregate in the reinforced zone unless noted otherwise in the plans. Provide reinforced concrete coping as required. Design and construct MSE retaining walls based on actual elevations and wall dimensions in accordance with the contract and accepted submittals. Use a prequalified MSE Wall Installer to construct MSE retaining walls.

Define “reinforcement” as steel or geosynthetic reinforcement and “geosynthetics” as geosynthetic grids (geogrids) or strips (geostrips). Define “aggregate” as coarse or fine aggregate. Define “panel” as a precast concrete panel and “coping” as precast or cast-in-place concrete coping.

Define “MSE wall” as a mechanically stabilized earth retaining wall and “MSE Wall Vendor” as the vendor supplying the chosen MSE wall system. Define “MSE panel wall” as an MSE wall with panels and “MSE segmental wall” as an MSE wall with segmental retaining wall (SRW) units. Define “abutment wall” as an MSE wall with bridge foundations in any portion of the reinforced zone or an MSE wall connected to an abutment wall. Even if bridge foundations only penetrate a small part of the reinforced zone, the entire MSE wall is considered an abutment wall.

Use an approved MSE wall system in accordance with the plans and any NCDOT restrictions or exceptions for the chosen system. Value engineering proposals for other MSE wall systems will not be considered. Do not use MSE wall systems with an “approved for provisional use” status for abutment walls or MSE walls subject to scour, walls with design heights greater than 35 ft or walls supporting or adjacent to railroads or interstate highways. The list of approved MSE wall systems with approval status is available from:

connect.ncdot.gov/resources/Geological/Pages/Products.aspx

2.0 MATERIALS

Refer to the *Standard Specifications*.

Item	Section
Aggregate	1014
Anchor Pins	1056-2
Curing Agents	1026
Epoxy, Type 3A	1081
Geotextiles, Type 2	1056
Grout, Type 3	1003
Joint Materials	1028
Portland Cement Concrete, Class A	1000
Precast Retaining Wall Coping	1077

Reinforcing Steel	1070
Retaining Wall Panels	1077
Segmental Retaining Wall Units	1040-4
Shoulder Drain Materials	816-2
Wire Staples	1060-8(D)

Provide Type 2 geotextile for filtration and separation geotextiles. Use Class A concrete for cast-in-place coping, leveling concrete and pads.

Use panels and SRW units from producers approved by the Department and licensed by the MSE Wall Vendor. Unless required otherwise in the contract, produce panels with a smooth flat final finish that meets Article 1077-11 of the *Standard Specifications*. Accurately locate and secure reinforcement connectors in panels and maintain required concrete cover. Produce panels within 1/4" of the panel dimensions shown in the accepted submittals.

Damaged panels or SRW units with excessive discoloration, chips or cracks as determined by the Engineer will be rejected. Do not damage reinforcement connection devices or mechanisms in handling or storing panels and SRW units.

Store steel materials on blocking at least 12" above the ground and protect it at all times from damage; and when placing in the work make sure it is free from dirt, dust, loose mill scale, loose rust, paint, oil or other foreign materials. Handle and store geosynthetics in accordance with Article 1056-2 of the *Standard Specifications*. Load, transport, unload and store MSE wall materials so materials are kept clean and free of damage. Bent, damaged or defective materials will be rejected.

A. Aggregate

Use standard size No. 57, 57M, 67 or 78M that meets Table 1005-1 of the *Standard Specifications* for coarse aggregate except do not use No. 57 or 57M stone in the reinforced zone of MSE walls with geosynthetic reinforcement or connectors. Use the following for fine aggregate:

1. Standard size No. 1S, 2S, 2MS or 4S that meets Table 1005-2 of the *Standard Specifications* or
2. Gradation that meets Class III, Type 3 select material in accordance with Article 1016-3 of the *Standard Specifications*.

Fine aggregate is exempt from mortar strength in Subarticle 1014-1(E) of the *Standard Specifications*. Use fine aggregate with a maximum organic content of 1.0%. Provide aggregate with electrochemical properties that meet the following requirements:

AGGREGATE ELECTROCHEMICAL REQUIREMENTS					
Aggregate Type	Reinforcement or Connector Material	pH	Resistivity	Chlorides	Sulfates
Coarse	Steel				Not Required

Fine	Steel	5 – 10	$\geq 3,000 \Omega \cdot \text{cm}$	$\leq 100 \text{ ppm}$	$\leq 200 \text{ ppm}$
Coarse or Fine	Polyester Type (PET) Geogrid	5 – 8	N/A*	N/A*	N/A*
Coarse or Fine	Geostrip or Polyolefin Geogrid	4.5 – 9	N/A*	N/A*	N/A*

* Resistivity, chlorides and sulfates are not applicable to geosynthetics.

Use aggregate from a source that meets the *Mechanically Stabilized Earth Wall Aggregate Sampling and Testing Procedures*. Perform pH tests for coarse aggregate in accordance with Materials and Tests (M&T) Unit Chemical Procedure C-Elec. Perform organic content tests for fine aggregate in accordance with AASHTO T 267 instead of Subarticle 1014-1(D) of the *Standard Specifications*. Perform electrochemical tests for fine aggregate in accordance with the following test procedures:

Property	Test Method
pH	AASHTO T 289
Resistivity	AASHTO T 288
Chlorides	AASHTO T 291
Sulfates	AASHTO T 290

B. Reinforcement

Provide steel or geosynthetic reinforcement supplied by the MSE Wall Vendor or a manufacturer approved or licensed by the vendor. Use reinforcement approved for the chosen MSE wall system. The list of approved reinforcement for each MSE wall system is available from the website shown elsewhere in this provision.

1. Steel Reinforcement

Provide Type 1 material certifications in accordance with Article 106-3 of the *Standard Specifications* for steel reinforcement. Use welded wire grid reinforcement (“mesh”, “mats” and “ladders”) that meet Article 1070-3 of the *Standard Specifications* and metallic strip reinforcement (“straps”) that meet ASTM A572 or A1011. Galvanize steel reinforcement in accordance with Section 1076 of the *Standard Specifications*.

2. Geosynthetic Reinforcement

Define “machine direction” (MD) for geosynthetics in accordance with ASTM D4439. Provide Type 1 material certifications for geosynthetic strengths in the MD in accordance with Article 1056-3 of the *Standard Specifications*. Test geosynthetics in accordance with ASTM D6637.

C. Bearing Pads

For MSE panel walls, use bearing pads that meet Section 3.6.1.a of the *FHWA Design*

and Construction of Mechanically Stabilized Earth Walls and Reinforced Soil Slopes – Volume I (Publication No. FHWA-NHI-10-024). Provide bearing pads with thicknesses that meet the following:

BEARING PAD THICKNESS	
Facing Area per Panel (A)	Minimum Pad Thickness After Compression (based on 2 times panel weight above pads)
$A \leq 30$ sf	1/2"
$30 \text{ sf} < A \leq 75$ sf	3/4"

D. Miscellaneous Components

Miscellaneous components may include connectors (e.g., anchors, bars, clamps, pins, plates, ties, etc.), fasteners (e.g., bolts, nuts, washers, etc.) and any other MSE wall components not included above. Galvanize steel components in accordance with Section 1076 of the *Standard Specifications*. Provide miscellaneous components approved for the chosen MSE wall system. The list of approved miscellaneous components for each MSE wall system is available from the website shown elsewhere in this provision.

3.0 PRECONSTRUCTION REQUIREMENTS

A. MSE Wall Surveys

The Retaining Wall Plans show a plan view, typical sections, details, notes and an elevation or profile view (wall envelope) for each MSE wall. Before beginning MSE wall design, survey existing ground elevations shown in the plans and other elevations in the vicinity of MSE wall locations as needed. For proposed slopes above or below MSE walls, survey existing ground elevations to at least 10 ft beyond slope stake points. Based on these elevations, finished grades and actual MSE wall dimensions and details, submit revised wall envelopes for acceptance. Use accepted wall envelopes for design.

B. MSE Wall Designs

For MSE wall designs, submit 11 copies of working drawings and 3 copies of design calculations and a PDF copy of each at least 30 days before the preconstruction meeting. Note name and NCDOT ID number of the panel or SRW unit production facility on the working drawings. Do not begin MSE wall construction until a design submittal is accepted.

Use a prequalified MSE Wall Design Consultant to design MSE walls. Provide designs sealed by a Design Engineer approved as a Geotechnical Engineer (key person) for the MSE Wall Design Consultant.

Design MSE walls in accordance with the plans, *AASHTO LRFD Bridge Design Specifications* and any NCDOT restrictions for the chosen MSE wall system unless

otherwise required. Design MSE walls for seismic if walls are located in seismic zone 2 based on Figure 2-1 of the *Structure Design Manual*. Use a uniform reinforcement length throughout the wall height of at least 0.7H with H as shown in the plans or 6 ft, whichever is longer, unless noted otherwise in the plans. Extend the reinforced zone at least 6" beyond end of reinforcement. Do not locate drains, the reinforced zone or leveling pads outside right-of-way or easement limits.

Use the simplified method for determining maximum reinforcement loads and design parameters approved for the chosen MSE wall system or default values in accordance with the AASHTO LRFD specifications. Design steel components including reinforcement and connectors for the design life noted in the plans and aggregate type in the reinforced zone. Use corrosion loss rates for galvanizing in accordance with the AASHTO LRFD specifications for nonaggressive backfill and carbon steel corrosion rates in accordance with the following:

CARBON STEEL CORROSION RATES	
Aggregate Type (in reinforced zone)	Corrosion Loss Rate (after zinc depletion)
Coarse	0.47 mil/year
Fine (except abutment walls)	0.58 mil/year
Fine (abutment walls)	0.70 mil/year

For geosynthetic reinforcement and connectors, use approved geosynthetic properties for the design life noted in the plans and aggregate type in the reinforced zone.

When noted in the plans, design MSE walls for a live load (traffic) surcharge of 250 lb/sf in accordance with Figure C11.5.6-3(b) of the AASHTO LRFD specifications. For steel beam guardrail with 8 ft posts or concrete barrier rail above MSE walls, analyze top 2 reinforcement layers for traffic impact loads in accordance with Section 7.2 of the FHWA MSE wall manual shown elsewhere in this provision except use the following for geosynthetic reinforcement rupture:

$$\phi T_{al} R_c \geq T_{max} + (T_I / RF_{CR})$$

Where,

- ϕ = resistance factor for tensile resistance in accordance with Section 7.2.1 of the FHWA MSE wall manual,
- T_{al} = long-term geosynthetic design strength approved for chosen MSE wall system,
- R_c = reinforcement coverage ratio = 1 for continuous geosynthetic reinforcement,
- T_{max} = factored static load in accordance with Section 7.2 of the FHWA MSE wall manual,
- T_I = factored impact load in accordance with Section 7.2 of the FHWA MSE wall manual and
- RF_{CR} = creep reduction factor approved for chosen MSE wall system.

If existing or future obstructions such as foundations, guardrail, fence or handrail posts, moment slabs, pavements, pipes, inlets or utilities will interfere with reinforcement,

maintain a clearance of at least 3" between obstructions and reinforcement unless otherwise approved. Locate reinforcement layers so all of reinforcement length is within 3" of corresponding connection elevations.

Use 6" thick cast-in-place unreinforced concrete leveling pads beneath panels and SRW units that are continuous at steps and extend at least 6" in front of and behind bottom row of panels or SRW units. Unless required otherwise in the plans, embed top of leveling pads in accordance with the following requirements:

EMBEDMENT REQUIREMENTS		
Front Slope¹ (H:V)	Minimum Embedment Depth² (whichever is greater)	
6:1 or flatter (except abutment walls)	H/20	1 ft for H ≤ 10 ft 2 ft for H > 10 ft
6:1 or flatter (abutment walls)	H/10	2 ft
> 6:1 to < 3:1	H/10	2 ft
3:1 to 2:1	H/7	2 ft

1. Front slope is as shown in the plans.
2. Define "H" as the maximum design height plus embedment per wall with the design height and embedment as shown in the plans.

When noted in the plans, locate a continuous aggregate shoulder drain along the base of the reinforced zone behind the aggregate. Provide wall drainage systems consisting of drains and outlet components in accordance with Standard Drawing No. 816.02 of the *Roadway Standard Drawings*.

For MSE panel walls, cover joints at back of panels with filtration geotextiles at least 12" wide. If the approval of the chosen MSE wall system does not require a minimum number of bearing pads, provide the number of pads in accordance with the following:

NUMBER OF BEARING PADS		
Facing Area per Panel (A)	Maximum Wall Height Above Horizontal Panel Joint	Minimum Number of Pads per Horizontal Panel Joint
A ≤ 30 sf	25 ft	2
	35 ft ¹	3
30 sf < A ≤ 75 sf	25 ft	3
	35 ft ¹	4

1. Additional bearing pads per horizontal panel joint may be required for wall heights above joints greater than 35 ft.

For MSE segmental walls, coarse aggregate is required in any SRW unit core spaces and between and behind SRW units for a horizontal distance of at least 18". Separation geotextiles are required between the aggregate and overlying fill or pavement sections except when concrete pavement, full depth asphalt or cement treated base is placed

directly on aggregate. When noted in the plans, separation geotextiles are also required at the back of the reinforced zone between the aggregate and backfill or natural ground. Unless required otherwise in the plans, use reinforced concrete coping at top of walls that meets the following requirements:

1. Coping dimensions as shown in the plans,
2. At the Contractor's option, coping that is precast or cast-in-place concrete for MSE panel walls unless cast-in-place coping is required as shown in the plans,
3. Cast-in-place concrete coping for MSE segmental walls and
4. At the Contractor's option and when shown in the plans, cast-in-place concrete coping that extends down back of panels or SRW units or connects to panels or SRW units with dowels.

For MSE segmental walls with dowels, attach dowels to top courses of SRW units in accordance with the following:

1. Set dowels in core spaces of SRW units filled with grout instead of coarse aggregate or
2. Embed adhesively anchored dowels in holes of solid SRW units with epoxy.

For MSE panel walls with coping, connect cast-in-place concrete coping or leveling concrete for precast concrete coping to top row of panels with dowels cast into panels. When concrete barrier rail is required above MSE walls, use concrete barrier rail with moment slab as shown in the plans.

Submit working drawings and design calculations for acceptance in accordance with Article 105-2 of the *Standard Specifications*. Submit working drawings showing plan views, wall profiles with foundation pressures, typical sections with reinforcement and connection details, aggregate locations and types, geotextile locations and details of leveling pads, panels or SRW units, coping, bin walls, slip joints, etc. If necessary, include details on working drawings for concrete barrier rail with moment slab, reinforcement splices if allowed for the chosen MSE wall system, reinforcement connected to end bent caps and obstructions extending through walls or interfering with reinforcement, leveling pads, barriers or moment slabs. Submit design calculations for each wall section with different surcharge loads, geometry or material parameters. At least one analysis is required for each wall section with different reinforcement lengths. When designing MSE walls with computer software other than MSEW, use MSEW, version 3.0 with update 14.93 or later, manufactured by ADAMA Engineering, Inc. to verify the design. At least one MSEW analysis is required per 100 ft of wall length with at least one analysis for the wall section with the longest reinforcement. Submit electronic MSEW input files and PDF output files with design calculations.

C. Preconstruction Meeting

Before starting MSE wall construction, hold a preconstruction meeting to discuss the construction and inspection of the MSE walls. If this meeting occurs before all MSE wall submittals have been accepted, additional preconstruction meetings may be

required before beginning construction of MSE walls without accepted submittals. The Resident or Bridge Maintenance Engineer, Bridge Construction Engineer, Geotechnical Operations Engineer, Contractor and MSE Wall Installer Superintendent will attend preconstruction meetings.

4.0 CORROSION MONITORING

Corrosion monitoring is required for MSE walls with steel reinforcement. The Engineer will determine the number of monitoring locations and where to install the instrumentation. Contact M&T before beginning wall construction. M&T will provide the corrosion monitoring instrumentation kits and if necessary, assistance with installation.

5.0 SITE ASSISTANCE

Unless otherwise approved, provide an MSE Wall Vendor representative to assist and guide the MSE Wall Installer on-site for at least 8 hours when the first panels or SRW units and reinforcement layer are placed. If problems are encountered during construction, the Engineer may require the vendor representative to return to the site for a time period determined by the Engineer.

6.0 CONSTRUCTION METHODS

Control drainage during construction in the vicinity of MSE walls. Direct run off away from MSE walls, aggregate and backfill. Contain and maintain aggregate and backfill and protect material from erosion.

Excavate as necessary for MSE walls in accordance with the accepted submittals. If applicable and at the Contractor's option, use temporary shoring for wall construction instead of temporary slopes to construct MSE walls. Define "temporary shoring for wall construction" as temporary shoring not shown in the plans or required by the Engineer including shoring for OSHA reasons or the Contractor's convenience.

Unless required otherwise in the plans, install foundations located in the reinforced zone before placing aggregate or reinforcement. Brace piles in the reinforced zone to maintain alignment when placing and compacting aggregate. Secure piles together with steel members near top of piles. Clamp members to piles instead of welding if bracing is at or below pile cut-off elevations.

Notify the Engineer when foundation excavation is complete. Do not place leveling pad concrete, aggregate or reinforcement until excavation dimensions and foundation material are approved.

Construct cast-in-place concrete leveling pads at elevations and with dimensions shown in the accepted submittals and in accordance with Section 420 of the *Standard Specifications*. Cure leveling pads at least 24 hours before placing panels or SRW units.

Erect and support panels and stack SRW units so the final wall position is as shown in the accepted submittals. Stagger SRW units to create a running bond by centering SRW units

over joints in the row below as shown in the accepted submittals. Space bearing pads in horizontal panel joints as shown in the accepted submittals and cover all panel joints with filtration geotextiles as shown in the accepted submittals. Attach filtration geotextiles to back of panels with adhesives, tapes or other approved methods.

Construct MSE walls with the following tolerances:

- A. SRW units are level from front to back and between units when checked with a 4 ft long level,
- B. Vertical joint widths are 1/4" maximum for SRW units and 3/4", $\pm 1/4$ " for panels,
- C. Final wall face is within 3/4" of horizontal and vertical alignment shown in the accepted submittals when measured along a 10 ft straightedge and
- D. Final wall plumbness (batter) is not negative (wall face leaning forward) and within 0.5° of vertical unless otherwise approved.

Place reinforcement at locations and elevations shown in the accepted submittals and within 3" of corresponding connection elevations. Install reinforcement with the direction shown in the accepted submittals. Place reinforcement in slight tension free of kinks, folds, wrinkles or creases. Reinforcement may be spliced once per reinforcement length if shown in the accepted submittals. Use reinforcement pieces at least 6 ft long. Contact the Engineer when unanticipated existing or future obstructions such as foundations, guardrail, fence or handrail posts, pavements, pipes, inlets or utilities will interfere with reinforcement. To avoid obstructions, deflect, skew or modify reinforcement as shown in the accepted submittals.

Place aggregate in the reinforced zone in 8" to 10" thick lifts. Compact fine aggregate in accordance with Subarticle 235-3(C) of the *Standard Specifications*. Use only hand operated compaction equipment to compact aggregate within 3 ft of panels or SRW units. At a distance greater than 3 ft, compact aggregate with at least 4 passes of an 8 ton to 10 ton vibratory roller in a direction parallel to the wall face. Smooth wheeled or rubber tired rollers are also acceptable for compacting aggregate. Do not use sheepsfoot, grid rollers or other types of compaction equipment with feet. Do not displace or damage reinforcement when placing and compacting aggregate. End dumping directly on geosynthetics is not permitted. Do not operate heavy equipment on reinforcement until it is covered with at least 8" of aggregate. Replace any damaged reinforcement to the satisfaction of the Engineer.

Backfill for MSE walls outside the reinforced zone in accordance with Article 410-8 of the *Standard Specifications*. If a drain is required, install wall drainage systems as shown in the accepted submittals and in accordance with Section 816 of the *Standard Specifications*.

Install dowels as necessary for SRW units and place and construct coping and leveling concrete as shown in the accepted submittals. Construct leveling concrete in accordance with Section 420 of the *Standard Specifications*. Construct cast-in-place concrete coping in accordance with Subarticle 452-3(C) of the *Standard Specifications*. When single faced precast concrete barrier is required in front of and against MSE walls, stop coping just

above barrier so coping does not interfere with placing barrier up against wall faces.

When separation geotextiles are required, overlap adjacent geotextiles at least 18" and hold separation geotextiles in place with wire staples or anchor pins as needed. Seal joints above and behind MSE walls between coping and concrete slope protection with silicone sealant.

7.0 MEASUREMENT AND PAYMENT

MSE Retaining Wall No. ___ will be measured and paid in square feet. MSE walls will be measured as the square feet of wall face area with the pay height equal to the difference between top of wall and top of leveling pad elevations. Define "top of wall" as top of coping or top of panels or SRW units for MSE walls without coping.

The contract unit price for *MSE Retaining Wall No. ___* will be full compensation for providing designs, submittals, labor, tools, equipment and MSE wall materials, excavating, backfilling, hauling and removing excavated materials and supplying site assistance, leveling pads, panels, SRW units, reinforcement, aggregate, wall drainage systems, geotextiles, bearing pads, coping, miscellaneous components and any incidentals necessary to construct MSE walls. The contract unit price for *MSE Retaining Wall No. ___* will also be full compensation for reinforcement connected to and aggregate behind end bent caps in the reinforced zone, if required.

No separate payment will be made for temporary shoring for wall construction. Temporary shoring for wall construction will be incidental to the contract unit price for *MSE Retaining Wall No. ___*.

The contract unit price for *MSE Retaining Wall No. ___* does not include the cost for ditches, fences, handrails, barrier or guardrail associated with MSE walls as these items will be paid for elsewhere in the contract.

Where it is necessary to provide backfill material behind the reinforced zone from sources other than excavated areas or borrow sources used in connection with other work in the contract, payment for furnishing and hauling such backfill material will be paid as extra work in accordance with Article 104-7 of the *Standard Specifications*. Placing and compacting such backfill material is not considered extra work but is incidental to the work being performed.

Payment will be made under:

Pay Item

MSE Retaining Wall No. ___

Pay Unit

Square Foot

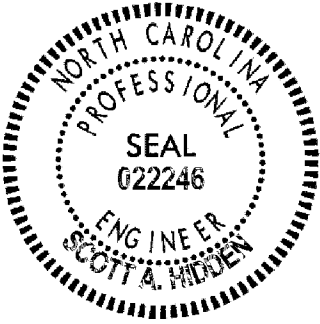

DocuSigned by:

Scott A. Hidden

1/28/2015

F760CAEB96FC4D3...

STANDARD SHORING:**(3-17-15)****Description**

Standard shoring includes standard temporary shoring and standard temporary mechanically stabilized earth (MSE) walls. At the Contractor's option, use standard shoring as noted in the plans or as directed. When using standard shoring, a temporary shoring design submittal is not required. Construct standard shoring based on actual elevations and shoring dimensions in accordance with the contract and Standard Detail No. 1801.01 or 1801.02.

Define "standard temporary shoring" as cantilever shoring that meets the standard temporary shoring detail (Standard Detail No. 1801.01). Define "standard temporary wall" as a temporary MSE wall with geotextile or geogrid reinforcement that meets the standard temporary wall detail (Standard Detail No. 1801.02). Define "standard temporary geotextile wall" as a standard temporary wall with geotextile reinforcement and "standard temporary geogrid wall" as a standard temporary wall with geogrid reinforcement. Define "geosynthetics" as geotextiles or geogrids.

Provide positive protection for standard shoring at locations shown in the plans and as directed. See *Temporary Shoring* provision for positive protection types and definitions.

Materials

Refer to the *Standard Specifications*.

Item	Section
Anchor Pins	1056-2
Concrete Barrier Materials	1170-2
Flowable Fill, Excavatable	1000-6
Geotextiles	1056
Grout, Type 1	1003
Portland Cement Concrete	1000
Select Material	1016
Steel Beam Guardrail Materials	862-2
Steel Sheet Piles and H-Piles	1084
Untreated Timber	1082-2
Welded Wire Reinforcement	1070-3
Wire Staples	1060-8(D)

Provide Type 6 material certifications for shoring materials. Use Class IV select material (standard size No. ABC) for temporary guardrail. Use Class A concrete that meets Article 450-2 of the *Standard Specifications* or grout for drilled-in piles.

Based on actual shoring height, positive protection, groundwater elevation, slope or surcharge case and traffic impact at each standard temporary shoring location, use sheet piles with the minimum required section modulus or H-piles with the sizes shown in Standard Detail No. 1801.01. Use untreated timber with a thickness of at least 3" and a bending stress of at least 1,000 psi for timber lagging.

(A) Shoring Backfill

Use Class II, Type 1, Class III, Class V or Class VI select material or material that meets AASHTO M 145 for soil classification A-2-4 with a maximum PI of 6 for shoring backfill except do not use the following:

- (1) A-2-4 soil for backfill around culverts,
- (2) A-2-4 soil in the reinforced zone of standard temporary walls with a back slope and
- (3) Class VI select material in the reinforced zone of standard temporary geotextile walls.

(B) Standard Temporary Walls

Use welded wire reinforcement for welded wire facing, struts and wires with the dimensions and minimum wire sizes shown in Standard Detail No. 1801.02. Provide Type 2 geotextile for separation and retention geotextiles. Define “machine direction” (MD) and “cross-machine direction” (CD) for geosynthetics in accordance with ASTM D4439. Do not use more than 4 different reinforcement strengths for each standard temporary wall.

(1) Geotextile Reinforcement

Provide Type 5 geotextile for geotextile reinforcement with a mass per unit area of at least 8 oz/sy in accordance with ASTM D5261. Based on actual wall height, groundwater elevation, slope or surcharge case and shoring backfill to be used in the reinforced zone at each standard temporary geotextile wall location, provide geotextiles with ultimate tensile strengths as shown in Standard Detail No. 1801.02.

(2) Geogrid Reinforcement

Handle and store geogrids in accordance with Article 1056-2 of the *Standard Specifications*. Use geogrids with a roll width of at least 4 ft and an “approved” or “approved for provisional use” status code. The list of approved geogrids is available from:

connect.ncdot.gov/resources/Materials/Pages/SoilsLaboratory.aspx

Based on actual wall height, groundwater elevation, slope or surcharge case and shoring backfill to be used in the reinforced zone at each standard temporary geogrid wall location, provide geogrids for geogrid reinforcement with short-term design strengths as shown in Standard Detail No. 1801.02. Geogrids are typically approved for ultimate tensile strengths in the MD and CD or short-term design strengths for a 3-year design life in the MD based on material type. Define material type from the website above for shoring backfill as follows:

Material Type	Shoring Backfill
Borrow	A-2-4 Soil
Fine Aggregate	Class II, Type 1 or Class III Select Material
Coarse Aggregate	Class V or VI Select Material

If the website does not list a short-term design strength for an approved geogrid, use a short-term design strength equal to the ultimate tensile strength divided by 3.5 for the geogrid reinforcement.

Preconstruction Requirements

(A) Concrete Barrier

Define “clear distance” behind concrete barrier as the horizontal distance between the barrier and edge of pavement. The minimum required clear distance for concrete barrier is shown in the plans. At the Contractor’s option or if the minimum required clear distance is not available, set concrete barrier next to and up against traffic side of standard shoring except for barrier above standard temporary walls. Concrete barrier with the minimum required clear distance is required above standard temporary walls.

(B) Temporary Guardrail

Define “clear distance” behind temporary guardrail as the horizontal distance between guardrail posts and standard shoring. At the Contractor’s option or if clear distance for standard temporary shoring is less than 4 ft, attach guardrail to traffic side of shoring as shown in the plans. Place ABC in clear distance and around guardrail posts instead of pavement. Do not use temporary guardrail above standard temporary walls.

(C) Standard Shoring Selection Forms

Before beginning standard shoring construction, survey existing ground elevations in the vicinity of standard shoring locations to determine actual shoring or wall heights (H). Submit a standard shoring selection form for each location at least 7 days before starting standard shoring construction. Standard shoring selection forms are available from: connect.ncdot.gov/resources/Geological/Pages/Geotech_Forms_Details.aspx

(D) Preconstruction Meeting

The Engineer may require a shoring preconstruction meeting to discuss the construction and inspection of the standard shoring. If required, schedule this meeting after all standard shoring selection forms have been submitted. The Resident, District or Bridge Maintenance Engineer, Bridge or Roadway Construction Engineer, Geotechnical Operations Engineer, Contractor and Shoring Contractor Superintendent will attend this preconstruction meeting.

Construction Methods

Construct standard shoring in accordance with the *Temporary Shoring* provision.

(A) Standard Temporary Shoring Installation

Based on actual shoring height, positive protection, groundwater elevation, slope or surcharge case and traffic impact at each standard temporary shoring location, install piles with the minimum required embedment and extension for each shoring section in accordance with Standard Detail No. 1801.01. For concrete barrier above and next to standard temporary shoring and temporary guardrail above and attached to standard temporary shoring, use “surcharge case with traffic impact” in accordance with Standard

Detail No. 1801.01. Otherwise, use “slope or surcharge case with no traffic impact” in accordance with Standard Detail No. 1801.01. If refusal is reached before driven piles attain the minimum required embedment, use drilled-in H-piles with timber lagging for standard temporary shoring.

(B) Standard Temporary Walls Installation

Based on actual wall height, groundwater elevation, slope or surcharge case, geotextile or geogrid reinforcement and shoring backfill in the reinforced zone at each standard temporary wall location, construct walls with the minimum required reinforcement length and number of reinforcement layers for each wall section in accordance with Standard Detail No. 1801.02. For standard temporary walls with pile foundations in the reinforced zone, drive piles through reinforcement after constructing temporary walls.

For standard temporary walls with interior angles less than 90°, wrap geosynthetics at acute corners as directed by the Engineer. Place geosynthetics as shown in Standard Detail No. 1801.02. Place separation geotextiles between shoring backfill and backfill, natural ground or culverts along the sides of the reinforced zone perpendicular to the wall face. For Class V or VI select material in the reinforced zone, place separation geotextiles between shoring backfill and backfill or natural ground on top of and at the back of the reinforced zone.

Measurement and Payment

Standard shoring will be measured and paid in accordance with the *Temporary Shoring* provision.

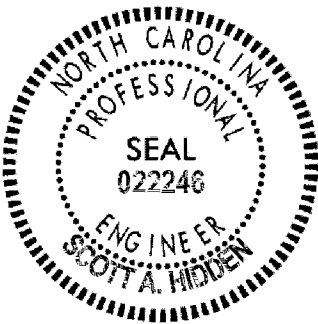

DocuSigned by:
Scott A. Hidden 1/28/2015
F760CAEB96FC4D3...

TEMPORARY SOIL NAIL WALLS:**(3-17-15)****Description**

Construct temporary soil nail walls consisting of soil nails spaced at a regular pattern and connected to a reinforced shotcrete face. A soil nail consists of a steel bar grouted in a drilled hole inclined at an angle below horizontal. At the Contractor's option, use temporary soil nail walls instead of temporary shoring for full cut sections. Design and construct temporary soil nail walls based on actual elevations and wall dimensions in accordance with the contract and accepted submittals. Use a prequalified Anchored Wall Contractor to construct temporary soil nail walls. Define "soil nail wall" as a temporary soil nail wall and "Soil Nail Wall Contractor" as the Anchored Wall Contractor installing soil nails and applying shotcrete. Define "nail" as a soil nail.

Provide positive protection for soil nail walls at locations shown in the plans and as directed. See *Temporary Shoring* provision for positive protection types and definitions.

Materials

Refer to Division 10 of the *Standard Specifications*.

Item	Section
Anchor Pins	1056-2
Geocomposites	1056
Grout, Type 2	1003
Reinforcing Steel	1070
Shotcrete	1002
Select Material, Class IV	1016
Steel Plates	1072-2

Use Class IV select material (standard size No. ABC) for temporary guardrail and neat cement grout for Type 2 grout.

Provide soil nails consisting of grouted steel bars and nail head assemblies. Use deformed steel bars that meet AASHTO M 275 or M 31, Grade 60 or 75. Splice bars in accordance with Article 1070-9 of the *Standard Specifications*.

Fabricate centralizers from schedule 40 PVC plastic pipe or tube, steel or other material not detrimental to steel bars (no wood). Size centralizers to position bars within 1" of drill hole centers and allow tremies to be inserted to ends of holes. Use centralizers that do not interfere with grout placement or flow around bars.

Provide nail head assemblies consisting of nuts, washers and bearing plates. Use steel plates for bearing plates and steel washers and hex nuts recommended by the Soil Nail Manufacturer.

Provide Type 6 material certifications for soil nail materials in accordance with Article 106-3 of the *Standard Specifications*. Store steel materials on blocking at least 12" above the ground and protect it at all times from damage; and when placing in the work make sure it is free from dirt, dust, loose mill scale, loose rust, paint, oil or other foreign materials. Load, transport, unload and store soil nail wall materials so materials are kept clean and free of damage. Bent, damaged or defective materials will be rejected.

Preconstruction Requirements

(A) Concrete Barrier

Define “clear distance” behind concrete barrier as the horizontal distance between the barrier and edge of pavement. The minimum required clear distance for concrete barrier is shown in the plans. At the Contractor’s option or if the minimum required clear distance is not available, set concrete barrier next to and up against traffic side of soil nail walls except for barrier above walls. Concrete barrier with the minimum required clear distance is required above soil nail walls.

(B) Temporary Guardrail

Define “clear distance” behind temporary guardrail as the horizontal distance between guardrail posts and soil nail walls. At the Contractor’s option or if clear distance for soil nail walls is less than 4 ft, use temporary guardrail with 8 ft posts and a clear distance of at least 2.5 ft. Place ABC in clear distance and around guardrail posts instead of pavement.

(C) Soil Nail Wall Designs

Before beginning soil nail wall design, survey existing ground elevations in the vicinity of wall locations to determine actual design heights (H). Use a prequalified Anchored Wall Design Consultant to design soil nail walls. Provide designs sealed by a Design Engineer approved as a Geotechnical Engineer (key person) for the Anchored Wall Design Consultant.

Submit 8 copies of working drawings and 3 copies of design calculations and a PDF copy of each for soil nail wall designs in accordance with Article 105-2 of the *Standard Specifications*. Submit working drawings showing plan views, wall profiles, typical sections and details of soil nail wall design and construction sequence. Include details in working drawings of soil nail locations, unit grout/ground bond strengths, shotcrete reinforcement and if necessary, obstructions extending through walls or interfering with nails. Include details in construction sequence of excavation, grouting, installing reinforcement, nail testing and shotcreting with mix designs and shotcrete nozzleman certifications. Do not begin soil nail wall construction until a design submittal is accepted.

Design soil nail walls in accordance with the plans and allowable stress design method in the *FHWA Geotechnical Engineering Circular No. 7 “Soil Nail Walls”* (Publication No. FHWA-IF-03-017) unless otherwise required.

Design soil nails that meet the following unless otherwise approved:

- (1) Horizontal and vertical spacing of at least 3 ft,
- (2) Inclination of at least 12° below horizontal and
- (3) Diameter of 4" to 10".

Do not extend nails beyond right-of-way or easement limits. If existing or future obstructions such as foundations, pavements, pipes, inlets or utilities will interfere with nails, maintain a clearance of at least 6" between obstructions and nails.

Design soil nail walls for a traffic surcharge of 250 lb/sf if traffic will be above and within H of walls. This traffic surcharge does not apply to construction traffic. Design

soil nail walls for any construction surcharge if construction traffic will be above and within H of walls. For temporary guardrail with 8 ft posts above soil nail walls, analyze walls for a horizontal load of 300 lb/ft of wall.

Place geocomposite drain strips with a horizontal spacing of no more than 10 ft and center strips between adjacent nails. Attach drain strips to excavation faces. Use shotcrete at least 4" thick and reinforce shotcrete with #4 waler bars around nail heads. Two waler bars (one on each side of nail head) in the horizontal and vertical directions are required for a total of 4 bars per nail.

(D) Preconstruction Meeting

Before starting soil nail wall construction, hold a preconstruction meeting to discuss the construction, inspection and testing of the soil nail walls. If this meeting occurs before all soil nail wall submittals have been accepted, additional preconstruction meetings may be required before beginning construction of soil nail walls without accepted submittals. The Resident, District or Bridge Maintenance Engineer, Bridge or Roadway Construction Engineer, Geotechnical Operations Engineer, Contractor and Soil Nail Wall Contractor Superintendent will attend preconstruction meetings.

Construction Methods

Control drainage during construction in the vicinity of soil nail walls. Direct run off away from soil nail walls and areas above and behind walls.

Install foundations located behind soil nail walls before beginning wall construction. Do not excavate behind soil nail walls. If overexcavation occurs, repair walls with an approved method and a revised soil nail wall design may be required.

Install positive protection in accordance with the contract and accepted submittals. Use PCB in accordance with Section 1170 of the *Standard Specifications* and Standard Drawing No. 1170.01 of the *Roadway Standard Drawings*. Use temporary guardrail in accordance with Section 862 of the *Standard Specifications* and Standard Drawing No. 862.01, 862.02 and 862.03 of the *Roadway Standard Drawings*.

(A) Excavation

Excavate for soil nail walls from the top down in accordance with the accepted submittals. Excavate in staged horizontal lifts with no negative batter (excavation face leaning forward). Excavate lifts in accordance with the following:

- (1) Heights not to exceed vertical nail spacing,
- (2) Bottom of lifts no more than 3 ft below nail locations for current lift and
- (3) Horizontal and vertical alignment within 6" of location shown in the accepted submittals.

Remove any cobbles, boulders, rubble or debris that will protrude more than 2" into the required shotcrete thickness. Rocky ground such as colluvium, boulder fills and weathered rock may be difficult to excavate without leaving voids.

Apply shotcrete to excavation faces within 24 hours of excavating each lift unless otherwise approved. Shotcreting may be delayed if it can be demonstrated that delays

will not adversely affect excavation stability. If excavation faces will be exposed for more than 24 hours, use polyethylene sheets anchored at top and bottom of lifts to protect excavation faces from changes in moisture content.

If an excavation becomes unstable at any time, suspend soil nail wall construction and temporarily stabilize the excavation by immediately placing an earth berm up against the unstable excavation face. When this occurs, repair walls with an approved method and a revised soil nail wall design may be required.

Do not excavate the next lift until nail installations and testing and shotcrete application for the current lift are accepted and grout and shotcrete for the current lift have cured at least 3 days and 1 day, respectively.

(B) Soil Nails

Drill and grout nails the same day and do not leave drill holes open overnight. Control drilling and grouting to prevent excessive ground movements, damaging structures and pavements or fracturing rock and soil formations. If ground heave or subsidence occurs, suspend soil nail wall construction and take corrective action to minimize movement. If property damage occurs, make repairs with an approved method and a revised soil nail wall design may be required.

(1) Drilling

Use drill rigs of the sizes necessary to install soil nails and with sufficient capacity to drill through whatever materials are encountered. Drill straight and clean holes with the dimensions and inclination shown in the accepted submittals. Drill holes within 6" of locations and 2° of inclination shown in the accepted submittals unless otherwise approved.

Stabilize drill holes with temporary casings if unstable, caving or sloughing material is anticipated or encountered. Do not use drilling fluids to stabilize drill holes or remove cuttings.

(2) Steel Bars

Center steel bars in drill holes with centralizers. Securely attach centralizers along bars at no more than 8 ft centers. Attach uppermost and lowermost centralizers 18" from excavation faces and ends of holes.

Do not insert steel bars into drill holes until hole locations, dimensions, inclination and cleanliness are approved. Do not vibrate, drive or otherwise force bars into holes. If a steel bar cannot be completely and easily inserted into a drill hole, remove the bar and clean or redrill the hole.

(3) Grouting

Remove oil, rust inhibitors, residual drilling fluids and similar foreign materials from holding tanks/hoppers, stirring devices, pumps, lines, tremie pipes and any other equipment in contact with grout before use. Measure grout temperature, density and flow during grouting with at least the same frequency grout cubes are made for compressive strength. Perform density and flow field tests in the presence of the Engineer in accordance with American National Standards

Institute/American Petroleum Institute Recommended Practice 13B-1 (Section 4, Mud Balance) and ASTM C939 (Flow Cone), respectively.

Inject grout at the lowest point of drill holes through tremies, e.g., grout tubes, casings, hollow-stem augers or drill rods, in one continuous operation. Fill drill holes progressively from ends of holes to excavation faces and withdraw tremies at a slow even rate as holes are filled to prevent voids in grout. Extend tremies into grout at least 5 ft at all times except when grout is initially placed in holes.

Provide grout free of segregation, intrusions, contamination, structural damage or inadequate consolidation (honeycombing). Cold joints in grout are not allowed except for test nails. Remove any temporary casings as grout is placed and record grout volume for each drill hole.

(4) Nail Heads

Install nail head assemblies after shotcreting. Before shotcrete reaches initial set, seat bearing plates and tighten nuts so plates contact shotcrete uniformly. If uniform contact is not possible, install nail head assemblies on mortar pads so nail heads are evenly loaded.

(C) Drain Strips

Install geocomposite drain strips as shown in the accepted submittals. Before installing shotcrete reinforcement, place drain strips with the geotextile side against excavation faces. For highly irregular faces and at the discretion of the Engineer, drain strips may be placed after shotcreting over weep holes through the shotcrete. Hold drain strips in place with anchor pins so strips are in continuous contact with surfaces to which they are attached and allow for full flow the entire height of soil nail walls. Discontinuous drain strips are not allowed. If splices are needed, overlap drain strips at least 12" so flow is not impeded. Cut off excess drain strip length and expose strip ends below shotcrete when soil nail wall construction is complete.

(D) Shotcrete

Clean ungrouted zones of drill holes and excavation faces of loose materials, mud, rebound and other foreign material. Moisten surfaces to receive shotcrete. Install shotcrete reinforcement in accordance with the contract and accepted submittals. Secure reinforcing steel so shooting does not displace or vibrate reinforcement. Install approved thickness gauges on 5 ft centers in the horizontal and vertical directions to measure shotcrete thickness.

Apply shotcrete in accordance with the contract, accepted submittals and Subarticle 1002-3(F) of the *Standard Specifications*. Use approved shotcrete nozzlemen who made satisfactory preconstruction test panels to apply shotcrete. Direct shotcrete at right angles to excavation faces except when shooting around reinforcing steel. Rotate nozzle steadily in small circular patterns and apply shotcrete from bottom of lifts up.

Make shotcrete surfaces uniform and free of sloughing or sagging. Completely fill ungrouted zones of drill holes and any other voids with shotcrete. Taper construction joints to a thin edge over a horizontal distance of at least the shotcrete thickness. Wet joint surfaces before shooting adjacent sections.

Repair surface defects as soon as possible after shooting. Remove any shotcrete which lacks uniformity, exhibits segregation, honeycombing or lamination or contains any voids or sand pockets and replace with fresh shotcrete to the satisfaction of the Engineer. Protect shotcrete from freezing and rain until shotcrete reaches initial set.

(E) Construction Records

Provide 2 copies of soil nail wall construction records within 24 hours of completing each lift. Include the following in construction records:

- (1) Names of Soil Nail Wall Contractor, Superintendent, Nozzleman, Drill Rig Operator, Project Manager and Design Engineer;
- (2) Wall description, county, Department's contract, TIP and WBS element number;
- (3) Wall station and number and lift location, dimensions, elevations and description;
- (4) Nail locations, dimensions and inclinations, bar types, sizes and grades and temporary casing information;
- (5) Date and time drilling begins and ends, steel bars are inserted into drill holes, grout and shotcrete are mixed and arrives on-site and grout placement and shotcrete application begins and ends;
- (6) Grout volume, temperature, flow and density records;
- (7) Ground and surface water conditions and elevations if applicable;
- (8) Weather conditions including air temperature at time of grout placement and shotcrete application; and
- (9) All other pertinent details related to soil nail wall construction.

After completing each soil nail wall or stage of a wall, provide a PDF copy of all corresponding construction records.

Nail Testing

“Proof tests” are performed on nails incorporated into walls, i.e., production nails. Define “test nail” as a nail tested with a proof test. Proof tests are typically required for at least one nail per nail row per soil nail wall or at least 5% of production nails, whichever is greater. More or less test nails may be required depending on subsurface conditions encountered. The Engineer will determine the number and locations of proof tests required. Do not test nails until grout and shotcrete attain the required 3 day compressive strength.

(A) Test Equipment

Use the following equipment to test nails:

- (1) Two dial gauges with rigid supports,
- (2) Hydraulic jack and pressure gauge and
- (3) Jacking block or reaction frame.

Provide dial gauges with enough range and precision to measure the maximum test nail movement to 0.001". Use pressure gauges graduated in 100 psi increments or less. Submit identification numbers and calibration records for load cells, jacks and pressure

gauges with the soil nail wall design. Calibrate each jack and pressure gauge as a unit.

Align test equipment to uniformly and evenly load test nails. Use a jacking block or reaction frame that does not damage or contact shotcrete within 3 ft of nail heads. Place dial gauges opposite each other on either side of test nails and align gauges within 5° of bar inclinations. Set up test equipment so resetting or repositioning equipment during nail testing is not needed.

(B) Test Nails

Test nails include both unbonded and bond lengths. Grout only bond lengths before nail testing. Provide unbonded and bond lengths of at least 3 ft and 10 ft, respectively.

Steel bars for production nails may be overstressed under higher test nail loads. If necessary, use larger size or higher grade bars with more capacity for test nails instead of shortening bond lengths to less than the minimum required.

(C) Proof Tests

Determine maximum bond length (L_B) using the following:

$$L_B \leq (C_{RT} \times A_t \times f_y) / (Q_{ALL} \times 1.5)$$

Where,

- L_B = bond length (ft),
 C_{RT} = reduction coefficient, 0.9 for Grade 60 and 75 bars or 0.8 for Grade 150 bars,
 A_t = bar area (in²),
 f_y = bar yield stress (ksi) and
 Q_{ALL} = allowable unit grout/ground bond strength (kips/ft).

Determine design test load (DTL) based on as-built bond length and allowable unit grout/ground bond strength using the following:

$$DTL = L_B \times Q_{ALL}$$

Where,

- DTL = design test load (kips).

Perform proof tests by incrementally loading nails to failure or a load of 150% of DTL based on the following schedule:

Load	Hold Time
AL*	Until movement stabilizes
0.25 DTL	Until movement stabilizes
0.50 DTL	Until movement stabilizes
0.75 DTL	Until movement stabilizes
1.00 DTL	Until movement stabilizes
1.25 DTL	Until movement stabilizes
1.50 DTL	10 or 60 minutes (creep test)
AL*	1 minute

* Alignment load (AL) is the minimum load needed to align test equipment and should not exceed 0.05 DTL.

Reset dial gauges to zero after applying alignment load. Record test nail movement at each load increment and monitor test nails for creep at the 1.5 DTL load increment. Measure and record movement during creep test at 1, 2, 3, 5, 6 and 10 minutes. If test nail movement between 1 and 10 minutes is greater than 0.04", maintain the 1.5 DTL load increment for an additional 50 minutes and record movement at 20, 30, 50 and 60 minutes. Repump jack as needed to maintain load during hold times.

(D) Test Nail Acceptance

Submit 2 copies of test nail records including load versus movement and time versus creep movement plots within 24 hours of completing each proof test. The Engineer will review the test nail records to determine if test nails are acceptable. Test nail acceptance is based in part on the following criteria.

- (1) Total movement during creep test is less than 0.04" between the 1 and 10 minute readings or less than 0.08" between the 6 and 60 minute readings and creep rate is linear or decreasing throughout hold time.
- (2) Total movement at maximum load exceeds 80% of the theoretical elastic elongation of the unbonded length.
- (3) Pullout failure does not occur at or before the 1.5 DTL load increment. Define "pullout failure" as the inability to increase load while movement continues. Record pullout failure load as part of test nail data.

Maintain stability of unbonded lengths for subsequent grouting. If a test nail is accepted but the unbonded length cannot be satisfactorily grouted, do not incorporate the test nail into the soil nail wall and add another production nail to replace the test nail.

If the Engineer determines a test nail is unacceptable, either perform additional proof tests on adjacent production nails or revise the soil nail design or installation methods for the production nails represented by the unacceptable test nail as determined by the Engineer. Submit a revised soil nail wall design for acceptance, provide an acceptable test nail with the revised design or installation methods and install additional production nails for the nails represented by the unacceptable test nail.

After completing nail testing for each soil nail wall or stage of a wall, provide a PDF copy of all corresponding test nail records.

Measurement and Payment

Temporary soil nail walls will be measured and paid in square feet. Temporary soil nail walls will be paid for at the contract unit price for *Temporary Shoring*. Temporary soil nail walls will be measured as the square feet of exposed wall face area. No measurement will be made for any embedment or pavement thickness above soil nail walls.

The contract unit price for *Temporary Shoring* will be full compensation for providing soil nail wall designs, submittals, labor, tools, equipment and soil nail wall materials, excavating, hauling and removing excavated materials, installing and testing soil nails, grouting, shotcreting and supplying drain strips and any incidentals necessary to construct soil nail walls. No additional payment will be made and no extension of completion date or time will be allowed for repairing property damage, overexcavations or unstable excavations, unacceptable test nails or thicker shotcrete.

No payment will be made for temporary shoring not shown in the plans or required by the Engineer including shoring for OSHA reasons or the Contractor's convenience. No value engineering proposals will be accepted based solely on revising or eliminating shoring locations shown in the plans or estimated quantities shown in the bid item sheets as a result of actual field measurements or site conditions.

PCB will be measured and paid in accordance with Section 1170 of the *Standard Specifications*. No additional payment will be made for anchoring PCB for soil nail walls. Costs for anchoring PCB will be incidental to soil nail walls.

Temporary guardrail will be measured and paid for in accordance with Section 862 of the *Standard Specifications*.

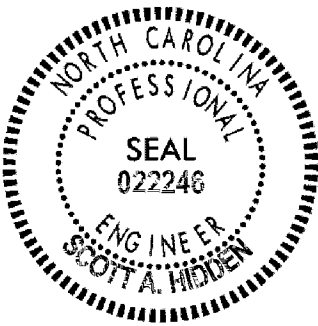

DocuSigned by:
Scott A. Hidden 1/28/2015
F760CAEB96FC4D3...

**PROJECT SPECIAL PROVISIONS
GEOENVIRONMENTAL**

CONTAMINATED SOIL (6/30/2015)

The Contractor's attention is directed to the fact that soil contaminated with petroleum hydrocarbon compounds may exist within the project area. The known areas of potential contamination are indicated on corresponding plans sheets. Information relating to these potentially contaminated areas and investigation reports will be available at the following web address by navigating to the correct letting year and month then selecting, "Plans and Proposals", "Cabarrus B-5136", "GeoEnvironmental":

<http://dotw-xfer01.dot.state.nc.us/dsplan/>

Petroleum contaminated soil may be encountered during any earthwork activities on the project. The Contractor shall only excavate those soils that the Engineer designates necessary to complete a particular task. The Engineer shall determine if soil is contaminated based on petroleum odors and unusual soil staining. Contaminated soil not required to be excavated is to remain in place and undisturbed. Undisturbed soil shall remain in place, whether contaminated or not. The Contractor shall stockpile all contaminated soil excavated from the project in a location approved by the Engineer.

The stockpile shall be created within the property boundaries of the source material and in accordance with the Stockpile Detail found in the plans. If the volume of contaminated material exceeds available space on site, the Contractor shall obtain a permit from the NCDENR UST Section's Regional Office for off-site temporary storage. The Engineer will notify the GeoEnvironmental Section of the stockpile and the GeoEnvironmental Section will arrange for the testing and disposal of the contaminated stockpile within two weeks of notification. Stockpiling petroleum contaminated soil will be incidental to the project.

DocuSigned by:
Cyrus Parker
C96492AF5E824DF...

6/30/2015



TC-1

(B-5136)

Cabarrus County

WORK ZONE TRAFFIC CONTROL Project Special Provisions

Law Enforcement:

(05/14/2013)

Description

Furnish Law Enforcement Officers and marked Law Enforcement vehicles to direct traffic in accordance with the contract.

Construction Methods

Use uniformed Law Enforcement Officers and marked Law Enforcement vehicles equipped with blue lights mounted on top of the vehicle, and Law Enforcement vehicle emblems to direct or control traffic as required by the plans or by the Engineer.

Measurement and Payment

Law Enforcement will be measured and paid for in the actual number of hours that each Law Enforcement Officer is provided during the life of the project as approved by the Engineer. There will be no direct payment for marked Law Enforcement vehicles as they are considered incidental to the pay item.

Payment will be made under:

Pay Item

Law Enforcement

Pay Unit

Hour

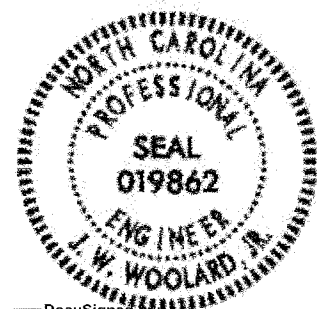

DocuSigned by
J. W. Woolard, Jr.

B79C18EBADB4427...

1/6/2015

PROJECT SPECIAL PROVISIONS
Utility Construction

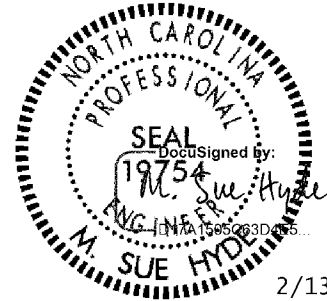

2/13/2015

City of Concord
PO Box 308
Concord, North Carolina 28026

Revise the 2012 Standard Specifications as follows:

Page 10-58, Sub-article 1036-1 General

add the following sentence:

All materials in contact with potable water shall be in conformance with Section 1417 of the Safe Drinking Water Act.

Page 15-1, Sub-article 1500-2 Cooperation with the Utility Owner, paragraph 2:

add the following sentences:

Water facilities are owned by the City of Concord. The contact person for the City is Ms. Sue Hyde, PE; she can be reached by phone at (704) 920-5401.

Prior to commencement of any water utility construction activity, contact the City of Concord Construction Manager, Mr. Phillip Kingsland, (704) 920-5425, to schedule and attend a Pre-Construction meeting with the owner’s representatives and DOT’s representatives. The contractor, the contractor’s superintendent, and representatives of subcontractors involved in water utility work shall attend.

Notify the City of Concord Construction Manager at least 24 hours prior to beginning any water or sewer construction activity.

Maintain water and sewer service to existing customers during construction. Minimize the duration of any service disruption. The 24” raw water line shall only be off line for a maximum of 72 hours. Notify the City of Concord Construction Manager at least 48 hours in advance of any scheduled service disruption. Provide notice on a City approved form to City of Concord customers specifying the day and duration of any scheduled disruption, including appropriate City contact numbers.

Provide temporary potable water supplies to City of Concord customers when the duration of water service disruption exceeds 4 hours. This work is considered incidental to the water line. No additional payment will be made.

Page 15-2, Sub-article 1500-7 Submittals and Records

add the following sentences:

Provide one set of sealed as-built drawings and 3 sets of complete and sealed record drawings to the owner in a 40':1" horizontal and 4':1" vertical scale on 24" by 36" paper and a complete digital copy of the record drawings in PDF and ACAD format on a CD, and the executed Engineer's Certification forms with original signatures, in accordance with the requirements established by the City of Concord Code of Ordinances, Chapter 62-Article 3. The Chapter 62, Article 3 Code of Ordinance can be obtained from the City at <http://www.ci.concord.nc.us/Government/CityOrdinances/tabid/207/Default.aspx>.

Page 15-2, Sub-article 1500-9 Placing Pipelines into Service

add the following sentence:

Obtain approval from the NCDENR-Public Water Supply Section prior to placing a new water line into service. Use backflow prevention assemblies for temporary connections to isolate new water lines from existing water line.

Materials:

Provide materials for the proposed water and sewer utilities construction meeting the applicable requirements (i.e. material specifications, standard details, testing, policies, etc.) of the Water and Sewer Authority of Cabarrus County (WSACC) Standard Specifications, dated August, 2006, applicable current City of Concord standard details as of Date of Advertisement, and the WSACC Standard Details, dated August, 2006. City of Concord details can be obtained from the City at <http://www.ci.concord.nc.us/Departments/Engineering/FormsDownloads/tabid/333/Default.aspx>. WSACC Standard Specifications and Details can be obtained from WSACC at http://www.wsacc.org/index.asp?Type=B_BASIC&SEC={56903D54-AD5E-4041-B06D-23D5BDC4DED4}.

Measurement and payment for work will be in accordance with the 2012 NCDOT Standard Specifications.

Page 15-3, Article 1505-3 Construction Methods:

Replace (c) Bedding with:

Refer to the Water and Sewer Authority of Cabarrus County (WSACC) Standard Specifications, dated August 2006 for bedding requirements.

Page 15-5, Article 1510-2 Materials:

Add the following sentence to line 19:

Refer to the Water and Sewer Authority of Cabarrus County (WSACC) Standard Specifications, dated August 2006.

Page 15-6, Sub-article 1510-3 (B), Testing and Sterilization
change the allowable leakage formula to:

$$W = LD\sqrt{P} \div 148,000$$

Replace line 33 with:

Dispose of waste water in accordance to the Water and Sewer Authority of Cabarrus County (WSACC) Standard Specifications, dated August 2006 and all environmental regulations. Refer to WSACC specifications for filling and venting.

Page 15-6, Sub-article 1510-3 (B), Testing and Sterilization, sixth paragraph:
Replace the paragraph with the following:

Sterilize water lines in accordance with Section 1003 of The Rules Governing Public Water supply and AWWA C651 Section 4.4.3, the Continuous Feed Method. Provide a chlorine solution with between 50 parts per million and 100 parts per million in the initial feed. If the chlorine level drops below 10 parts per million during a 24 hour period, then flush, refill with fresh chlorine solution, and repeat for 24 hours. Provide certified bacteriological and contaminant test results from a state-approved or state-certified laboratory. Operate all valves and controls to assure thorough sterilization.

Page 15-6, Sub-article 1510-3 (B), Testing and Sterilization, seventh paragraph:
delete the words “may be performed concurrently or consecutively.”
and replace with “shall be performed consecutively.”

Page 15-7, sub-article 1515-2 Materials,
Add the following sentence to line 17:

Refer to the Water and Sewer Authority of Cabarrus County (WSACC) Standard Specifications, dated August 2006.

replace paragraph beginning “Double check valves...” with the following:

Double Check valves (DCV) and Reduced Pressure Zone principal (RPZ) backflow prevention assemblies shall be listed on the University of Southern California Foundation for Cross-Connection Control and Hydraulic Research list of approved backflow devices.

Page 15-17, Sub-article 1540-3(C) Marker Posts:

Line 16-18: Replace with: “Mark encasements at right-of-way lines (on both sides of track for crossings) by durable, weatherproof signs located over the centerline of the pipe. Signs shall show the following:

1. City of Concord
2. Raw Water
3. Average pressure – 50 psi
4. X’ deep (contractor to fill in the depth based on as-built conditions)
5. Emergency number – 704-920-5555

Page 15-19, Sub-article 1550-3 Shoring:

Line 23: Delete “or use an engineered system for”
Line 24: Delete

Page 15-20, Sub-article 1550-4(A) Bore and Jack:

Line 4: Second sentence to read: Limit overbore to ½”.
Add after Line 5: Refer to the Specifications for Pipeline Occupancy of North Carolina Railroad Company Property, Revised January 2009 for additional construction requirements.

Revise the *WSACC Standard Specifications*, August, 2006, as follows:

Page 1, Section 15104 Resilient-Seated Gate Valves

1. **Scope** – Delete the second sentence.
2. **Acceptable Manufacturers** – Add Mueller Company

Measurement and Payment:

No direct payment will be made for utility construction work required by the preceding provisions, which are general requirements applying to utility construction, and all of the requirements stated will be considered incidental work, paid for at the contract unit prices of the various utility items included in the contract.

Page 15-8; Section 1515-3(F). The Contractor’s attention is directed to this section.

Measurement and Payment:

Payment for 3” combination air release valve shall be per each valve, and paid for under the contract price for “3” Combination Air Release Valve”. Such price and payments will be full compensation for all labor, materials, excavation, backfilling and any incidentals necessary to complete the work, as required.

Pay Item:

3” Combination Air Release Valve

Pay Unit

Each

PROJECT SPECIAL PROVISIONS

Utilities by Others

General:

The following utility companies have facilities that will be in conflict with the construction of this project:

- A) City of Concord – Transmission Power
- B) City of Concord – Distribution Power
- C) Windstream – Communications
- D) Duke Net – Communications
- E) Time Warner – Communications

The conflicting facilities of these concerns will be adjusted prior to the date of availability, unless otherwise noted and are therefore listed in these special provisions for the benefit of the Contractor. All utility work listed herein will be done by the utility owners. All utilities are shown on the plans from the best available information.

The Contractor's attention is directed to Article 105.8 of the 2012 Standard Specifications.

Utilities Requiring Adjustment:

Utility relocations are shown on the Utilities by Others Plans.

- A) City of Concord – Transmission Power
 - 1) The City of Concord will relocate the existing transmission power to a temporary location within the project limits. All temporary facilities will be in place by January 30, 2016.
 - 2) Contact person for City of Concord is Mr. John Russell at 704-920-5309.
- B) City of Concord – Distribution Power
 - 1) The City of Concord will relocate the existing distribution power to a temporary location within the project limits. All temporary facilities will be in place by January 30, 2016.
 - 2) Contact person for City of Concord is Mr. John Russell at 704-920-5309.
- C) Windstream – Communications
 - 1) Windstream will follow the temporary power relocation pole line to relocate its facilities within the project limits. All temporary facilities will be in place by January 30, 2016.
 - 3) Contact person for Windstream is Mr. Jim Foley at 704-722-2822.

PROJECT SPECIAL PROVISIONS

Utilities by Others

D) Duke Net – Communications

- 1) Duke Net will follow the temporary power relocation pole line to relocate its facilities within the project limits. All temporary facilities will be in place by January 30, 2016.
- 2) Contact person for Duke Net is Mr. Marc Osborne at 704-969-6160.

E) Time Warner – Communications

- 1) Time Warner will follow the temporary power relocation pole line to relocate its facilities within the project limits. All temporary facilities will be in place by January 30, 2016.
- 2) Contact person for Time Warner is Mr. Marc Osborne at 704-969-6160..

NOTE: All facilities listed above will return to a permanent location on the north side and parallel to US 29, once the bridge construction is complete and the detour road / bridge is removed. Ensure adequate clearances are maintained between permanent power location and new bridge.

**Project Special Provisions
Erosion Control**

STABILIZATION REQUIREMENTS:

Stabilization for this project shall comply with the time frame guidelines as specified by the NCG-010000 general construction permit effective August 3, 2011 issued by the North Carolina Department of Environment and Natural Resources Division of Water Quality. Temporary or permanent ground cover stabilization shall occur within 7 calendar days from the last land-disturbing activity, with the following exceptions in which temporary or permanent ground cover shall be provided in 14 calendar days from the last land-disturbing activity:

- Slopes between 2:1 and 3:1, with a slope length of 10 ft. or less
- Slopes 3:1 or flatter, with a slope of length of 50 ft. or less
- Slopes 4:1 or flatter

The stabilization timeframe for High Quality Water (HQW) Zones shall be 7 calendar days with no exceptions for slope grades or lengths. High Quality Water Zones (HQW) Zones are defined by North Carolina Administrative Code 15A NCAC 04A.0105 (25). Temporary and permanent ground cover stabilization shall be achieved in accordance with the provisions in this contract and as directed.

SEEDING AND MULCHING:

(West)

The kinds of seed and fertilizer, and the rates of application of seed, fertilizer, and limestone, shall be as stated below. During periods of overlapping dates, the kind of seed to be used shall be determined. All rates are in pounds per acre.

Shoulder and Median Areas

August 1 - June 1		May 1 - September 1	
20#	Kentucky Bluegrass	20#	Kentucky Bluegrass
75#	Hard Fescue	75#	Hard Fescue
25#	Rye Grain	10#	German or Browntop Millet
500#	Fertilizer	500#	Fertilizer
4000#	Limestone	4000#	Limestone

Areas Beyond the Mowing Pattern, Waste and Borrow Areas:

August 1 - June 1		May 1 - September 1	
100#	Tall Fescue	100#	Tall Fescue
15#	Kentucky Bluegrass	15#	Kentucky Bluegrass
30#	Hard Fescue	30#	Hard Fescue
25#	Rye Grain	10#	German or Browntop Millet
500#	Fertilizer	500#	Fertilizer
4000#	Limestone	4000#	Limestone

Approved Tall Fescue Cultivars

06 Dust	Escalade	Justice	Scorpion
2 nd Millennium	Essential	Kalahari	Serengeti
3 rd Millennium	Evergreen 2	Kentucky 31*	Shelby
Apache III	Falcon IV	Kitty Hawk 2000	Sheridan
Avenger	Falcon NG	Legitimate	Signia
Barlexas	Falcon V	Lexington	Silver Hawk
Barlexas II	Faith	LSD	Sliverstar
Bar Fa	Fat Cat	Magellan	Shenandoah Elite
Barrera	Festnova	Matador	Sidewinder
Barrington	Fidelity	Millennium SRP	Skyline
Barrobusto	Finelawn Elite	Monet	Solara
Barvado	Finelawn Xpress	Mustang 4	Southern Choice II
Biltmore	Finesse II	Ninja 2	Speedway
Bingo	Firebird	Ol' Glory	Spyder LS
Bizem	Firecracker LS	Olympic Gold	Sunset Gold
Blackwatch	Firenza	Padre	Taccoa
Blade Runner II	Five Point	Patagonia	Tanzania
Bonsai	Focus	Pedigree	Trio
Braveheart	Forte	Picasso	Tahoe II
Bravo	Garrison	Piedmont	Talladega
Bullseye	Gazelle II	Plantation	Tarheel
Cannavaro	Gold Medallion	Proseeds 5301	Terrano
Catalyst	Grande 3	Prospect	Titan ltd
Cayenne	Greenbrooks	Pure Gold	Titanium LS
Cessane Rz	Greenkeeper	Quest	Tracer
Chipper	Gremlin	Raptor II	Traverse SRP
Cochise IV	Greystone	Rebel Exeda	Tulsa Time
Constitution	Guardian 21	Rebel Sentry	Turbo
Corgi	Guardian 41	Rebel IV	Turbo RZ
Corona	Hemi	Regiment II	Tuxedo RZ
Coyote	Honky Tonk	Regenerate	Ultimate
Darlington	Hot Rod	Rendition	Venture
Davinci	Hunter	Rhambler 2 SRP	Umbrella
Desire	Inferno	Rembrandt	Van Gogh
Dominion	Innovator	Reunion	Watchdog
Dynamic	Integrity	Riverside	Wolfpack II
Dynasty	Jaguar 3	RNP	Xtremegreen
Endeavor	Jamboree	Rocket	

***Note: Kentucky 31 will no longer be an approved NCDOT Tall Fescue Cultivar after December 31, 2015.**

Approved Kentucky Bluegrass Cultivars:

4-Season	Blue Velvet	Gladstone	Quantum Leap
Alexa II	Blueberry	Granite	Rambo
America	Boomerang	Hampton	Rhapsody
Apollo	Brilliant	Harmonie	Rhythm
Arcadia	Cabernet	Impact	Rita
Aries	Champagne	Jefferson	Royce
Armada	Champlain	Juliet	Rubicon
Arrow	Chicago II	Jump Start	Rugby II
Arrowhead	Corsair	Keeneland	Shiraz
Aura	Courtyard	Langara	Showcase
Avid	Delight	Liberator	Skye
Award	Diva	Madison	Solar Eclipse
Awesome	Dynamo	Mercury	Sonoma
Bandera	Eagleton	Midnight	Sorbonne
Barduke	Emblem	Midnight II	Starburst
Barnique	Empire	Moon Shadow	Sudden Impact
Baroness	Envicta	Moonlight SLT	Total Eclipse
Barrister	Everest	Mystere	Touche
Barvette HGT	Everglade	Nu Destiny	Tsunami
Bedazzled	Excursion	NuChicago	Unique
Belissimo	Freedom II	NuGlade	Valor
Bewitched	Freedom III	Odyssey	Voyager II
Beyond	Front Page	Perfection	Washington
Blacksburg II	Futurity	Pinot	Zinfandel
Blackstone	Gaelic	Princeton 105	
Blue Note	Ginney II	Prosperity	

Approved Hard Fescue Cultivars:

Aurora II	Eureka II	Oxford	Scaldis II
Aurora Gold	Firefly	Reliant II	Spartan II
Berkshire	Granite	Reliant IV	Stonehenge
Bighorn GT	Heron	Rescue 911	
Chariot	Nordic	Rhino	

On cut and fill slopes 2:1 or steeper add 20# Sericea Lespedeza January 1 - December 31.

Fertilizer shall be 10-20-20 analysis. A different analysis of fertilizer may be used provided the 1-2-2 ratio is maintained and the rate of application adjusted to provide the same amount of plant food as a 10-20-20 analysis and as directed.

TEMPORARY SEEDING:

Fertilizer shall be the same analysis as specified for *Seeding and Mulching* and applied at the rate of 400 pounds and seeded at the rate of 50 pounds per acre. German Millet, or Browntop Millet shall be used in summer months and rye grain during the remainder of the year. The Engineer will determine the exact dates for using each kind of seed.

FERTILIZER TOPDRESSING:

Fertilizer used for topdressing shall be 16-8-8 grade and shall be applied at the rate of 500 pounds per acre. A different analysis of fertilizer may be used provided the 2-1-1 ratio is maintained and the rate of application adjusted to provide the same amount of plant food as 16-8-8 analysis and as directed.

SUPPLEMENTAL SEEDING:

The kinds of seed and proportions shall be the same as specified for *Seeding and Mulching*, and the rate of application may vary from 25# to 75# per acre. The actual rate per acre will be determined prior to the time of topdressing and the Contractor will be notified in writing of the rate per acre, total quantity needed, and areas on which to apply the supplemental seed. Minimum tillage equipment, consisting of a sod seeder shall be used for incorporating seed into the soil as to prevent disturbance of existing vegetation. A clodbuster (ball and chain) may be used where degree of slope prevents the use of a sod seeder.

MOWING:

The minimum mowing height on this project shall be six inches.

LAWN TYPE APPEARANCE:

All areas adjacent to lawns must be hand finished as directed to give a lawn type appearance. Remove all trash, debris, and stones $\frac{3}{4}$ " and larger in diameter or other obstructions that could interfere with providing a smooth lawn type appearance. These areas shall be reseeded to match their original vegetative conditions, unless directed otherwise by the Field Operations Engineer.

RESPONSE FOR EROSION CONTROL:**Description**

Furnish the labor, materials, tools and equipment necessary to move personnel, equipment, and supplies to the project necessary for the pursuit of any or all of the following work as shown herein, by an approved subcontractor.

Section	Erosion Control Item	Unit
1605	Temporary Silt Fence	LF
1606	Special Sediment Control Fence	LF/TON
1615	Temporary Mulching	ACR
1620	Seed - Temporary Seeding	LB
1620	Fertilizer - Temporary Seeding	TN
1631	Matting for Erosion Control	SY
SP	Coir Fiber Mat	SY
1640	Coir Fiber Baffles	LF
SP	Permanent Soil Reinforcement Mat	SY
1660	Seeding and Mulching	ACR
1661	Seed - Repair Seeding	LB
1661	Fertilizer - Repair Seeding	TON
1662	Seed - Supplemental Seeding	LB
1665	Fertilizer Topdressing	TON
SP	Safety/Highly Visible Fencing	LF
SP	Response for Erosion Control	EA

Construction Methods

Provide an approved subcontractor who performs an erosion control action as described in the NPDES Inspection Form SPPP30. Each erosion control action may include one or more of the above work items.

Measurement and Payment

Response for Erosion Control will be measured and paid for by counting the actual number of times the subcontractor moves onto the project, including borrow and waste sites, and satisfactorily completes an erosion control action described in Form 1675. The provisions of Article 104-5 of the *Standard Specifications* will not apply to this item of work.

Payment will be made under:

Pay Item

Response for Erosion Control

Pay Unit

Each

303(d) IMPAIRED WATERS LIST:

The Irish Buffalo Creek, which has been identified on the 303(d) list of impaired waters as impaired for sedimentation and/or turbidity, is within one mile of the project and receives drainage from the project. The Contractor shall adhere to all conditions and/or regulations required for impacts to these waters.

MINIMIZE REMOVAL OF VEGETATION:

The Contractor shall minimize removal of vegetation within project limits to the maximum extent practicable. Vegetation along stream banks and adjacent to other jurisdictional resources outside the construction limits shall only be removed upon approval of Engineer. No additional payment will be made for this minimization work.

STOCKPILE AREAS:

The Contractor shall install and maintain erosion control devices sufficient to contain sediment around any erodible material stockpile areas as directed.

ACCESS AND HAUL ROADS:

At the end of each working day, the Contractor shall install or re-establish temporary diversions or earth berms across access/haul roads to direct runoff into sediment devices. Silt fence sections that are temporarily removed shall be reinstalled across access/haul roads at the end of each working day.

WASTE AND BORROW SOURCES:

Payment for temporary erosion control measures, except those made necessary by the Contractor's own negligence or for his own convenience, will be paid for at the appropriate contract unit price for the devices or measures utilized in borrow sources and waste areas.

No additional payment will be made for erosion control devices or permanent seeding and mulching in any commercial borrow or waste pit. All erosion and sediment control practices that may be required on a commercial borrow or waste site will be done at the Contractor's expense.

All offsite Staging Areas, Borrow and Waste sites shall be in accordance with "Borrow and Waste Site Reclamation Procedures for Contracted Projects" located at:

http://www.ncdot.gov/doh/operations/dp_chief_eng/roadside/fieldops/downloads/Files/ContractedReclamationProcedures.pdf

All forms and documents referenced in the "Borrow and Waste Site Reclamation Procedures for Contracted Projects" shall be included with the reclamation plans for offsite staging areas, and borrow and waste sites.

SAFETY FENCE AND JURISDICTIONAL FLAGGING:**Description**

Safety Fence shall consist of furnishing materials, installing and maintaining polyethylene or polypropylene fence along the outside riparian buffer, wetland, or water boundary, or other boundaries located within the construction corridor to mark the areas that have been approved to infringe within the buffer, wetland, endangered vegetation, culturally sensitive areas or water. The fence shall be installed prior to any land disturbing activities.

Interior boundaries for jurisdictional areas noted above shall be delineated by stakes and highly visible flagging.

Jurisdictional boundaries at staging areas, waste sites, or borrow pits, whether considered outside or interior boundaries shall be delineated by stakes and highly visible flagging.

Materials**(A) Safety Fencing**

Polyethylene or polypropylene fence shall be a highly visible preconstructed safety fence approved by the Engineer. The fence material shall have an ultraviolet coating.

Either wood posts or steel posts may be used. Wood posts shall be hardwood with a wedge or pencil tip at one end, and shall be at least 5 ft. in length with a minimum nominal 2" x 2" cross section. Steel posts shall be at least 5 ft. in length, and have a minimum weight of 0.85 lb/ft of length.

(B) Boundary Flagging

Wooden stakes shall be 4 feet in length with a minimum nominal 3/4" x 1-3/4" cross section. The flagging shall be at least 1" in width. The flagging material shall be vinyl and shall be orange in color and highly visible.

Construction Methods

No additional clearing and grubbing is anticipated for the installation of this fence. The fence shall be erected to conform to the general contour of the ground.

(A) Safety Fencing

Posts shall be set at a maximum spacing of 10 ft., maintained in a vertical position and hand set or set with a post driver. If hand set, all backfill material shall be thoroughly tamped. Wood posts may be sharpened to a dull point if power driven. Posts damaged by power driving shall be removed and replaced prior to final acceptance. The tops of all wood posts shall be cut at a 30-

degree angle. The wood posts may, at the option of the Contractor, be cut at this angle either before or after the posts are erected.

The fence geotextile shall be attached to the wood posts with one 2" galvanized wire staple across each cable or to the steel posts with wire or other acceptable means.

Place construction stakes to establish the location of the safety fence in accordance with Article 105-9 or Article 801-1 of the *Standard Specifications*. No direct pay will be made for the staking of the safety fence. All stakeouts for safety fence shall be considered incidental to the work being paid for as "Construction Surveying", except that where there is no pay item for construction surveying, all safety fence stakeout will be performed by state forces.

The Contractor shall be required to maintain the safety fence in a satisfactory condition for the duration of the project as determined by the Engineer.

(B) Boundary Flagging

Boundary flagging delineation of interior boundaries shall consist of wooden stakes on 25 feet maximum intervals with highly visible orange flagging attached. Stakes shall be installed a minimum of 6" into the ground. Interior boundaries may be staked on a tangent that runs parallel to buffer but must not encroach on the buffer at any location. Interior boundaries of hand clearing shall be identified with a different colored flagging to distinguish it from mechanized clearing.

Boundary flagging delineation of interior boundaries will be placed in accordance with Article 105-9 or Article 801-1 of the *Standard Specifications*. No direct pay will be made for delineation of the interior boundaries. This delineation will be considered incidental to the work being paid for as *Construction Surveying*, except that where there is no pay item or construction surveying the cost of boundary flagging delineation shall be included in the unit prices bid for the various items in the contract. Installation for delineation of all jurisdictional boundaries at staging areas, waste sites, or borrow pits shall consist of wooden stakes on 25 feet maximum intervals with highly visible orange flagging attached. Stakes shall be installed a minimum of 6" into the ground. Additional flagging may be placed on overhanging vegetation to enhance visibility but does not substitute for installation of stakes.

Installation of boundary flagging for delineation of all jurisdictional boundaries at staging areas, waste sites, or borrow pits shall be performed in accordance with Subarticle 230-4(B)(5) or Subarticle 802-2(F) of the *Standard Specifications*. No direct pay will be made for this delineation, as the cost of same shall be included in the unit prices bid for the various items in the contract.

The Contractor shall be required to maintain alternative stakes and highly visible flagging in a satisfactory condition for the duration of the project as determined by the Engineer.

Measurement and Payment

Safety Fence will be measured and paid as the actual number of linear feet of polyethylene or polypropylene fence installed in place and accepted. Such payment will be full compensation including but not limited to furnishing and installing fence geotextile with necessary posts and post bracing, staples, tie wires, tools, equipment and incidentals necessary to complete this work.

Payment will be made under:

Pay Item	Pay Unit
Safety Fence	Linear Foot

WATTLES WITH POLYACRYLAMIDE (PAM):**Description**

Wattles are tubular products consisting of excelsior fibers encased in synthetic netting. Wattles are used on slopes or channels to intercept runoff and act as a velocity break. Wattles are to be placed at locations shown on the plans or as directed. Installation shall follow the detail provided in the plans and as directed. Work includes furnishing materials, installation of wattles, matting installation, PAM application, and removing wattles.

Materials

Wattle shall meet the following specifications:

100% Curled Wood (Excelsior) Fibers	
Minimum Diameter	12 in.
Minimum Density	2.5 lb/ft ³ +/- 10%
Net Material	Synthetic
Net Openings	1 in. x 1 in.
Net Configuration	Totally Encased
Minimum Weight	20 lb. +/- 10% per 10 ft. length

Anchors: Stakes shall be used as anchors.

Wooden Stakes:

Provide hardwood stakes a minimum of 2-ft. long with a 2 in. x 2 in. nominal square cross section. One end of the stake must be sharpened or beveled to facilitate driving down into the underlying soil.

Matting shall meet the requirements of Article 1060-8 of the *Standard Specifications*, or shall meet specifications provided elsewhere in this contract.

Provide staples made of 0.125" diameter new steel wire formed into a *u* shape not less than 12" in length with a throat of 1" in width.

Polyacrylamide (PAM) shall be applied in powder form and shall be anionic or neutrally charged. Soil samples shall be obtained in areas where the wattles will be placed, and from offsite material used to construct the roadway, and analyzed for the appropriate PAM flocculant to be utilized with each wattle. The PAM product used shall be listed on the North Carolina Department of Environment and Natural Resources (NCDENR) Division of Water Quality (DWQ) web site as an approved PAM product for use in North Carolina.

Construction Methods

Wattles shall be secured to the soil by wire staples approximately every 1 linear foot and at the end of each section of wattle. A minimum of 4 stakes shall be installed on the downstream side of the wattle with a maximum spacing of 2 linear feet along the wattle, and according to the detail. Install a minimum of 2 stakes on the upstream side of the wattle according to the detail provided in the plans. Stakes shall be driven into the ground a minimum of 10 in. with no more than 2 in. projecting from the top of the wattle. Drive stakes at an angle according to the detail provided in the plans.

Only install wattle(s) to a height in ditch so flow will not wash around wattle and scour ditch slopes and according to the detail provided in the plans and as directed. Overlap adjoining sections of wattles a minimum of 6 in.

Installation of matting shall be in accordance with the detail provided in the plans, and in accordance with Article 1631-3 of the *Standard Specifications*, or in accordance with specifications provided elsewhere in this contract.

Apply PAM over the lower center portion of the wattle where the water is going to flow over at a rate of 2 ounces per wattle, and 1 ounce of PAM on matting on each side of the wattle. PAM applications shall be done during construction activities after every rainfall event that is equal to or exceeds 0.50 in.

The Contractor shall maintain the wattles until the project is accepted or until the wattles are removed, and shall remove and dispose of silt accumulations at the wattles when so directed in accordance with the requirements of Section 1630 of the *Standard Specifications*.

Measurement and Payment

Wattles will be measured and paid for by the actual number of linear feet of wattles which are installed and accepted. Such price and payment will be full compensation for all work covered by this section, including, but not limited to, furnishing all materials, labor, equipment and incidentals necessary to install the *Wattles*.

Matting will be measured and paid for in accordance with Article 1631-4 of the *Standard Specifications*, or in accordance with specifications provided elsewhere in this contract.

Polyacrylamide(PAM) will be measured and paid for by the actual weight in pounds of PAM applied to the wattles. Such price and payment will be full compensation for all work covered by this section, including, but not limited to, furnishing all materials, labor, equipment and incidentals necessary to apply the *Polyacrylamide(PAM)*.

Payment will be made under:

Pay Item	Pay Unit
Polyacrylamide(PAM)	Pound
Wattle	Linear Foot

CONCRETE WASHOUT STRUCTURE:

Description

Concrete washout structures are watertight enclosures constructed above or below grade to contain concrete waste on construction sites. Concrete waste can include concrete waste water from washing out ready-mix trucks, drums, pumps, or other equipment. Concrete waste also includes concrete slurries from concrete saw cutting, coring, grinding, grooving operations, or hydro-concrete demolition. Concrete washouts must prevent the discharge of concrete waste materials to storm drainage systems, surface waters, wetlands, and buffers. Work for above grade washout structures includes gathering high cohesive and low infiltration soil to construct an above grade earthen berm basin. Work also includes preparing a rock and debris free soil base inside this earthen basin, installing a geomembrane liner in the basin, and then placing sandbags along the entire polypropylene liner basin perimeter. Work for below grade washout structures includes preparing a rock and debris free soil base, excavation of a basin with non-vertical side slopes, installing a geomembrane liner in the basin, and then placing sandbags along the entire polypropylene liner excavation perimeter. Construct a gravel pad with Class A stone and a geotextile under liner to provide a defined access path to the concrete washout structures. Install safety fence around the perimeter of the concrete washout structures.

Materials

Item	Section
Borrow Material	1018
Stone for Erosion Control, Class A	1042
Geotextile for Drainage, Type 2	1056

The geomembrane basin liner shall meet the following minimum physical properties for low permeability, polypropylene or polyethylene geomembranes:

Property	Test Method	Value	Unit
Thickness, nominal		10	mil
Weight		0.04	lbs./ft ²
*1" Tensile Strength	ASTM D-751	52	lbf.
Elongation at Break	ASTM D-751	600	%

*Grab Tensile	ASTM D-751	70	lbf.
*Trapezoid Tear	ASTM D-4533	55	lbf.
Hydrostatic Resistance	ASTM D-751	70	lb./in ²
Water Vapor Transmission Rate	ASTM E-96 Procedure B	0.03	gal/100in ² /day
Perm Rating	ASTM E-96 Procedure B	0.066	U.S. Perms

***Tests are an average of diagonal directions.**

Safety Fence shall meet the specifications as provided elsewhere in this contract.

Construction Methods

Above Grade Structures

Assemble high cohesive and low infiltration soil to build an enclosed earthen berm for an above grade concrete washout basin in accordance with the details and as directed. Construct the height, length, and width of the earthen berm according to the detail. Slope the interior and exterior walls of the earthen berm at 1:1 and then compact to provide structural stability and contain concrete washout liquids and solid materials until evaporation, curing, extraction, or final removal.

The geomembrane liner will be of sufficient width and length so there will be no seams. Install the geomembrane lining by overlaying it in the basin to completely cover any exposed soil to create a water tight concrete washout basin. Extend the geomembrane lining from inside the basin floor, up the earth slope of the basin and extend, overlay, and wrap outside the earthen berm. Trench the toe of the geomembrane lining into an eight inch depth trench and then backfill and tamper with soil.

Below Grade Structures

Excavate an area for concrete washout in accordance with the details and as directed. Excavate to a minimum depth of 3 feet. Slope the interior walls of the excavated area at 1:1 and then compact to provide structural stability and contain concrete washout liquids and solid materials until evaporation, curing, extraction, or final removal.

The geomembrane liner will be of sufficient width and length so there will be no seams. Install the geomembrane lining by overlaying it in the excavated area to completely cover any exposed soil to create a watertight impoundment. Extend the geomembrane lining from the excavation floor, up the interior slope of the excavated basin and beyond the outside perimeter of the excavation.

Prepare the soil base to be free of rocks or other debris that may cause holes or tears in the geomembrane lining.

Install safety fence around the perimeter of the concrete washout structures in accordance with the *Safety Fence and Jurisdictional Flagging* special provision.

Construct a stone gravel pad with Class A stone (or other approved aggregate material) and a geotextile liner to provide a defined access path to the concrete washout structure. Construct the stone gravel pad according to *Roadway Standard Drawings* No. 1607.01 and Section 1607 of the *Standard Specifications*. Post a sign with the words “Concrete Washout” in close proximity of the concrete washout area, so it is clearly visible to site personnel.

The construction details for the above grade and below grade concrete washout structures can be found on the following web page link:

http://www.ncdot.gov/doh/operations/dp_chief_eng/roadside/soil_water/details/

Maintenance and Removal

Maintain the concrete washout structure(s) to provide adequate holding capacity plus a minimum freeboard of 12 inches. Remove and dispose of hardened concrete and return the structure to a functional condition after reaching 75% capacity.

Inspect concrete washout structures for damage (i.e. tears in geomembrane liner, missing sand bags) and maintain for effectiveness.

Remove the concrete washout structures and sign upon project completion. If appropriate and possible, reuse the geomembrane liner, the sandbags, orange safety fence, the Class A stone, and the geotextile. Otherwise, properly dispose of items. Grade the earth material to match the existing contours and permanently seed and mulch area.

Measurement and Payment

Concrete Washout Structure will be measured and paid for by counting the actual number of washout structures installed and maintained on the project. Such price and payment will be full compensation for all work including but not limited to furnishing materials, construction, maintenance and removal of concrete washout structures, grading and seeding and mulching area. The provisions of Article 104-5 of the *Standard Specifications* will not apply to this item of work.

Payment will be made under:

Pay Item	Pay Unit
Concrete Washout Structure	Each

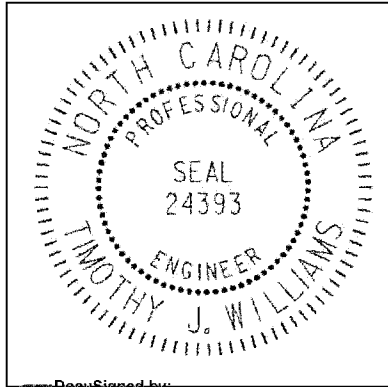

**Signals and Intelligent Transportation Systems
Project Special Provisions
(Version 12.4)**

Prepared By: M. Mahbooba
6-Jan-15

DocuSigned by:
T. J. Williams 1/6/2015
97AD792E8E934CA...

Contents

1. 2012 STANDARD SPECIFICATIONS FOR ROADS & STRUCTURES.....2

1.1. POLYMER CONCRETE (PC) JUNCTION BOXES (1091-5(B)).....2

1.2. SUBMITTAL REQUIREMENTS (1098-1(B))2

1.3. JUNCTION BOXES (1098-5).....2

1.4. CONTROLLERS WITH CABINETS – MATERIAL (1751-2)2

2. SIGNAL HEADS.....2

2.1. MATERIALS2

A. *General*:.....2

B. *Vehicle Signal Heads*:.....4

C. *Signal Cable*:.....7

3. MICROWAVE VEHICLE DETECTOR – SINGLE ZONE7

3.1. DESCRIPTION7

3.2. MATERIALS7

3.3. CONSTRUCTION METHODS8

3.4. MEASUREMENT AND PAYMENT8

4. CONTROLLERS WITH CABINETS8

4.1. MATERIALS – TYPE 2070L CONTROLLERS8

4.2. MATERIALS – GENERAL CABINETS9

4.3. MATERIALS – TYPE 170E CABINETS10

A. *Type 170 E Cabinets General*:.....10

B. *Type 170 E Cabinet Electrical Requirements*:.....10

C. *Type 170 E Cabinet Physical Requirements*:.....18

D. *Model 2018 Enhanced Conflict Monitor*:.....20

E. *Preemption and Sign Control Box*.....30

4.4. MATERIALS – TYPE 170 DETECTOR SENSOR UNITS33

4.5. MATERIALS – TYPE 2070E CONTROLLERS33

1. 2012 STANDARD SPECIFICATIONS FOR ROADS & STRUCTURES

The 2012 Standard Specifications are revised as follows:

1.1. Polymer Concrete (PC) Junction Boxes (1091-5(B))

Page 10-202, revise paragraph starting on line 9 to read “Provide polymer concrete (PC) boxes which have bolted covers and open bottoms. Provide vertical extensions of 6" to 12" as required by project special provisions.”

Page 10-202, revise sentence beginning on line 14 to read “Other thermoplastic materials may be used for components which are not normally exposed to sunlight.”

1.2. Submittal Requirements (1098-1(B))

Page 10-208, replace paragraph on line 34 with the following:

Submit for approval catalog cuts and/or shop drawings for materials proposed for use on the project. Allow 40 days for review of each submittal. Do not fabricate or order material until receipt of Engineer’s approval.

Submit 4 copies of each catalog cut and/or drawing and show for each component the material description, brand name, stock-number, size, rating, manufacturing specification and the intended use (identified by labeling all components with the corresponding contract line item number). Present the submittals neatly arranged in the same order as the contract bid items. Electronic submittals of catalog cuts and drawings may be accepted in lieu of hard copies.

One hard copy and an electronic (PDF) copy of reviewed submittals will be returned to the Engineer from the ITS and Signals Unit.

1.3. Junction Boxes (1098-5)

Page 10-212, sub-Section 1098-5(C) Oversized Junction Boxes

Revise sentence to read, “Provide oversized junction boxes and covers with minimum inside dimensions of 28"(l) x 15"(w) x 22"(h).”

1.4. Controllers with Cabinets – Material (1751-2)

Page 17-37, Section 1751-2 Material

Add the following paragraph:

When the plans or specifications require a Type 2070L controller, contractor may provide a Type 2070E controller. Unless otherwise allowed by the Engineer, provide controllers of only one type.

2. SIGNAL HEADS

2.1. MATERIALS

A. General:

Fabricate vehicle signal head housings and end caps from die-cast aluminum. Fabricate 12-inch and 16-inch pedestrian signal head housings and end caps from die-cast aluminum. Fabricate 9-inch pedestrian signal head housings, end caps, and visors from virgin polycarbonate material. Provide visor mounting screws, door latches, and hinge pins fabricated from stainless steel. Provide interior screws, fasteners, and metal parts fabricated from stainless steel or corrosion resistant material.

Fabricate tunnel and traditional visors from sheet aluminum.

Paint all surfaces inside and outside of signal housings and doors. Paint outside surfaces of tunnel and traditional visors, messenger cable mounting assemblies, pole and pedestal mounting assemblies, and pedestrian pushbutton housings. Have electrostatically-applied, fused-polyester paint in highway yellow (Federal Standard 595C, Color Chip Number 13538) a minimum of 2.5 to 3.5 mils thick. Do not apply paint to the latching hardware or rigid vehicle signal head mounting brackets for mast-arm attachments.

Have the interior surfaces of tunnel and traditional visors painted an alkyd urea black synthetic baking enamel with a minimum gloss reflectance and meeting the requirements of MIL-E-10169, "Enamel Heat Resisting, Instrument Black."

Where required, provide polycarbonate signal heads and visors that comply with the provisions pertaining to the aluminum signal heads listed on the QPL with the following exceptions:

Fabricate signal head housings, end caps, and visors from virgin polycarbonate material. Provide UV stabilized polycarbonate plastic with a minimum thickness of 0.1 ± 0.01 inches that is highway yellow (Federal Standard 595C, Color Chip 13538). Ensure the color is incorporated into the plastic material before molding the signal head housings and end caps. Ensure the plastic formulation provides the following physical properties in the assembly (tests may be performed on separately molded specimens):

Test	Required	Method
Specific Gravity	1.17 minimum	ASTM D 792
Flammability	Self-extinguishing	ASTM D 635
Tensile Strength, yield, PSI	8500 minimum	ASTM D 638
Izod impact strength, ft-lb/in [notched, 1/8 inch]	12 minimum	ASTM D 256

For pole mounting, provide side of pole mounting assemblies with framework and all other hardware necessary to make complete, watertight connections of the signal heads to the poles and pedestals. Fabricate the mounting assemblies and frames from aluminum with all necessary hardware, screws, washers, etc. to be stainless steel. Provide mounting fittings that match the positive locking device on the signal head with the serrations integrally cast into the brackets. Provide upper and lower pole plates that have a 1 ¼-inch vertical conduit entrance hubs with the hubs capped on the lower plate and 1 ½-inch horizontal hubs. Ensure that the assemblies provide rigid attachments to poles and pedestals so as to allow no twisting or swaying of the signal heads. Ensure that all raceways are free of sharp edges and protrusions, and can accommodate a minimum of ten Number 14 AWG conductors.

For pedestal mounting, provide a post-top slipfitter mounting assembly that matches the positive locking device on the signal head with serrations integrally cast into the slipfitter. Provide stainless steel hardware, screws, washers, etc. Provide a minimum of six 3/8 X 3/4-inch long square head bolts for attachment to pedestal. Provide a center post for multi-way slipfitters.

For light emitting diode (LED) traffic signal modules, provide the following requirements for inclusion on the Department's Qualified Products List for traffic signal equipment.

1. Sample submittal,
2. Third-party independent laboratory testing results for each submitted module with evidence of testing and conformance with all of the Design Qualification Testing specified in section 6.4 of each of the following Institute of Transportation Engineers (ITE) specifications:

- Vehicle Traffic Control Signal Heads – Light Emitting Diode (LED) Circular Signal Supplement
- Vehicle Traffic Control Signal Heads – Light Emitting Diode (LED) Vehicle Arrow Traffic Signal Supplement
- Pedestrian Traffic Control Signal Indications –Light Emitting Diode (LED) Signal Modules.

(Note: The Department currently recognizes two approved independent testing laboratories. They are Intertek ETL Semko and Light Metrics, Incorporated with Garwood Laboratories. Independent laboratory tests from other laboratories may be considered as part of the QPL submittal at the discretion of the Department,

3. Evidence of conformance with the requirements of these specifications,
4. A manufacturer's warranty statement in accordance with the required warranty, and
5. Submittal of manufacturer's design and production documentation for the model, including but not limited to, electrical schematics, electronic component values, proprietary part numbers, bill of materials, and production electrical and photometric test parameters.
6. Evidence of approval of the product to bear the Intertek ETL Verified product label for LED traffic signal modules.

In addition to meeting the performance requirements for the minimum period of 60 months, provide a written warranty against defects in materials and workmanship for the modules for a period of 60 months after installation of the modules. During the warranty period, the manufacturer must provide new replacement modules within 45 days of receipt of modules that have failed at no cost to the State. Repaired or refurbished modules may not be used to fulfill the manufacturer's warranty obligations. Provide manufacturer's warranty documentation to the Department during evaluation of product for inclusion on Qualified Products List (QPL).

B. Vehicle Signal Heads:

Comply with the ITE standard "Vehicle Traffic Control Signal Heads". Provide housings with provisions for attaching backplates.

Provide visors that are 8 inches in length for 8-inch vehicle signal head sections. Provide visors that are 10 inches in length for 12-inch vehicle signal heads.

Provide a termination block with one empty terminal for field wiring for each indication plus one empty terminal for the neutral conductor. Have all signal sections wired to the termination block. Provide barriers between the terminals that have terminal screws with a minimum Number 8 thread size and that will accommodate and secure spade lugs sized for a Number 10 terminal screw.

Mount termination blocks in the yellow signal head sections on all in-line vehicle signal heads. Mount the termination block in the red section on five-section vehicle signal heads.

Furnish vehicle signal head interconnecting brackets. Provide one-piece aluminum brackets less than 4.5 inches in height and with no threaded pipe connections. Provide hand holes on the bottom of the brackets to aid in installing wires to the signal heads. Lower brackets that carry no wires and are used only for connecting the bottom signal sections together may be flat in construction.

For messenger cable mounting, provide messenger cable hangers, wire outlet bodies, balance adjusters, bottom caps, wire entrance fitting brackets, and all other hardware necessary to make complete, watertight connections of the vehicle signal heads to the messenger cable. Fabricate mounting assemblies from malleable iron or steel and provide serrated rings made of aluminum. Provide messenger cable hangers and balance adjusters that are galvanized before being painted. Fabricate balance adjuster eyebolt and eyebolt nut from stainless steel or galvanized malleable iron. Provide messenger cable hangers with U-bolt clamps. Fabricate washers, screws, bolts, clevis pins, cotter pins, nuts, and U-bolt clamps from stainless steel.

For mast-arm mounting, provide rigid vehicle signal head mounting brackets and all other hardware necessary to make complete, watertight connections of the vehicle signal heads to the mast arms and to provide a means for vertically adjusting the vehicle signal heads to proper alignment. Fabricate the mounting assemblies from aluminum, and provide serrated rings made of aluminum. Provide stainless steel cable attachment assemblies to secure the brackets to the mast arms. Ensure all fastening hardware and fasteners are fabricated from stainless steel.

Provide LED vehicular traffic signal modules (hereafter referred to as modules) that consist of an assembly that uses LEDs as the light source in lieu of an incandescent lamp for use in traffic signal sections. Use LEDs that are aluminum indium gallium phosphorus (AlInGaP) technology for red and yellow indications and indium gallium nitride (InGaN) for green indications. Install the ultra bright type LEDs that are rated for 100,000 hours of continuous operation from -40°F to +165°F. Design modules to have a minimum useful life of 60 months and to meet all parameters of this specification during this period of useful life.

For the modules, provide spade terminals crimped to the lead wires and sized for a #10 screw connection to the existing terminal block in a standard signal head. Do not provide other types of crimped terminals with a spade adapter.

Ensure the power supply is integral to the module assembly. On the back of the module, permanently mark the date of manufacture (month & year) or some other method of identifying date of manufacture.

Tint the red, yellow and green lenses to correspond with the wavelength (chromaticity) of the LED. Transparent tinting films are unacceptable. Provide a lens that is integral to the unit with a smooth outer surface.

LED Circular Signal Modules:

Provide modules in the following configurations: 12-inch circular sections, and 8-inch circular sections. All makes and models of LED modules purchased for use on the State Highway System shall appear on the current NCDOT Traffic Signal Qualified Products List (QPL).

Provide the manufacturer's model number and the product number (assigned by the Department) for each module that appears on the 2012 or most recent Qualified Products List. In addition, provide manufacturer's certification in accordance with Article 106-3 of the *Standard Specifications*, that each module meets or exceeds the ITE "Vehicle Traffic Control Signal Heads – Light Emitting Diode (LED) Circular Signal Supplement" dated June 27, 2005 (hereafter referred to as VTCSH Circular Supplement) and other requirements stated in this specification.

Provide modules that meet the following requirements when tested under the procedures outlined in the VTCSH Circular Supplement:

Module Type	Max. Wattage at 165° F	Nominal Wattage at 77° F
12-inch red circular	17	11
8-inch red circular	13	8
12-inch green circular	15	15
8-inch green circular	12	12

For yellow circular signal modules, provide modules tested under the procedures outlined in the VTCSH Circular Supplement to insure power required at 77° F is 22 Watts or less for the 12-inch circular module and 13 Watts or less for the 8-inch circular module.

Note: Use a wattmeter having an accuracy of $\pm 1\%$ to measure the nominal wattage and maximum wattage of a circular traffic signal module. Power may also be derived from voltage, current and power factor measurements.

LED Arrow Signal Modules

Provide 12-inch omnidirectional arrow signal modules. All makes and models of LED modules purchased for use on the State Highway System shall appear on the current NCDOT Traffic Signal Qualified Products List (QPL).

Provide the manufacturer's model number and the product number (assigned by the Department) for each module that appears on the 2012 or most recent Qualified Products List. In addition, provide manufacturer's certification in accordance with Article 106-3 of the *Standard Specifications*, that each module meets or exceeds the requirements for 12-inch omnidirectional modules specified in the ITE "Vehicle Traffic Control Signal Heads – Light Emitting Diode (LED) Vehicle Arrow Traffic Signal Supplement" dated July 1, 2007 (hereafter referred to as VTCSH Arrow Supplement) and other requirements stated in this specification.

Provide modules that meet the following requirements when tested under the procedures outlined in the VTCSH Arrow Supplement:

Module Type	Max. Wattage at 165° F	Nominal Wattage at 77° F
12-inch red arrow	12	9
12-inch green arrow	11	11

For yellow arrow signal modules, provide modules tested under the procedures outlined in the VTCSH Arrow Supplement to insure power required at 77° F is 12 Watts or less.

Note: Use a wattmeter having an accuracy of $\pm 1\%$ to measure the nominal wattage and maximum wattage of an arrow traffic signal module. Power may also be derived from voltage, current and power factor measurements.

1. LED U-Turn Arrow Signal Modules:

Provide modules in the following configurations: 12-inch left u-turn arrow signal modules and 12-inch right u-turn arrow signal modules.

Modules are not required to be listed on the ITS and Signals Qualified Products List. Provide manufacturer's certification in accordance with Article 106-3 of the *Standard Specifications*, that each module meets or exceeds the ITE "Vehicle Traffic Control Signal Heads – Light Emitting

Diode (LED) Circular Signal Supplement” dated June 27, 2005 (hereafter referred to as VTCSH Circular Supplement) and other requirements stated in this specification.

Provide modules that have minimum maintained luminous intensity values that are not less than 16% of the values calculated using the method described in section 4.1 of the VTCSH Circular Supplement.

Provide modules that meet the following requirements when tested under the procedures outlined in the VTCSH Circular Supplement:

Module Type	Max. Wattage at 165° F	Nominal Wattage at 77° F
12-inch red u-turn arrow	17	11
12-inch green u-turn arrow	15	15

For yellow u-turn arrow signal modules, provide modules tested under the procedures outlined in the VTCSH Circular Supplement to ensure power required at 77° F is 22 Watts or less.

Note: Use a wattmeter having an accuracy of $\pm 1\%$ to measure the nominal wattage and maximum wattage of a circular traffic signal module. Power may also be derived from voltage, current and power factor measurements.

C. Signal Cable:

Furnish 16-4 and 16-7 signal cable that complies with IMSA specification 20-1 except provide the following conductor insulation colors:

- For 16-4 cable: white, yellow, red, and green
- For 16-7 cable: white, yellow, red, green, yellow with black stripe tracer, red with black stripe tracer, and green with black stripe tracer. Apply continuous stripe tracer on conductor insulation with a longitudinal or spiral pattern.

Provide a ripcord to allow the cable jacket to be opened without using a cutter. IMSA specification 19-1 will not be acceptable. Provide a cable jacket labeled with the IMSA specification number and provide conductors constructed of stranded copper.

3. MICROWAVE VEHICLE DETECTOR – SINGLE ZONE

3.1. DESCRIPTION

Furnish and install a microwave vehicle detection unit and manufacturer recommended cables and hardware in accordance with the plans and specifications.

3.2. MATERIALS

Furnish material, equipment, and hardware under this section that is pre-approved on the ITS and Signals QPL.

Provide a detector for either side-fire or forward-fire configuration. Ensure the detector will detect vehicle in sunny, cloudy, rainy, snowy, and foggy weather conditions with self-tuning to auto-adjust in changing environmental conditions. Ensure the detector can operate from the voltage supplied by a NEMA and Type-170 traffic signal cabinet. Ensure the detector can provide detection calls to the traffic signal controller within a NEMA and Type-170 cabinet. Ensure the detector will put out a constant call in the event of a component failure or loss of power. Ensure the detector has an operating temperature range of -20 to 150 degrees F. Ensure a water resistant housing for the detector.

For advance pulse detection, ensure the detector senses vehicles in motion at a range of 200 feet with an operating frequency of 10.525 GHz +/- 25MHz.

For stop bar presence detection, ensure the detector outputs a constant call while a vehicle is in the detection zone. Ensure the presence detection unit can cover a detection zone as shown on the plans and has an effective range of at least 75 feet from the detector unit to the aim point on the road surface.

For units without an integrated card rack interface, provide Form C output relay contacts rated a minimum of 3A, 24VDC.

If a laptop is used to adjust detector settings, ensure that software is licensed for use by the Department and by any other agency responsible for maintaining or operating the microwave detection system. Provide the Department with a license to duplicate and distribute the software as necessary for design and maintenance support.

3.3. CONSTRUCTION METHODS

Install the microwave vehicle detector in accordance with the manufacturer’s recommendations.

Monitor and maintain the detector unit during construction to ensure microwave vehicle detector is functioning properly and aimed for the detection zone shown in the plans. Refer to Subarticle 1700-3 (D) Maintenance and Repair of Materials of the *Standard Specifications* for failure to maintain the microwave detection system.

3.4. MEASUREMENT AND PAYMENT

Actual number of microwave vehicle detector units furnished, installed, and accepted.

No measurement will be made of cables or hardware, as these will be considered incidental to furnishing and installing microwave vehicle detectors.

Payment will be made under:

Microwave Vehicle Detector – Single Zone..... Each

4. CONTROLLERS WITH CABINETS

4.1. MATERIALS – TYPE 2070L CONTROLLERS

Conform to CALTRANS *Transportation Electrical Equipment Specifications* (TEES) (dated August 16, 2002, plus Errata 1 dated October 27, 2003 and Errata 2 dated June 08, 2004) except as required herein.

Furnish Model 2070L controllers. Ensure that removal of the CPU module from the controller will place the intersection into flash.

The Department will provide software at the beginning of the burning-in period. Contractor shall give 5 working days notice before needing software. Program software provided by the Department.

Provide model 2070L controllers with the latest version of OS9 operating software and device drivers, composed of the unit chassis and at a minimum the following modules and assemblies:

- MODEL 2070 1B, CPU Module, Single Board
- MODEL 2070-2A, Field I/O Module (FI/O)

- Note: Configure the Field I/O Module to disable both the External WDT Shunt/Toggle Switch and SP3 (SP3 active indicator is “off”)
- MODEL 2070-3B, Front Panel Module (FP), Display B (8x40)
- MODEL 2070-4A, Power Supply Module, 10 AMP
- MODEL 2070-7A, Async Serial Com Module (9-pin RS-232)

Furnish one additional MODEL 2070-7A, Async Serial Com Module (9-pin RS-232) for all master controller locations.

For each master location and central control center, furnish a U.S. Robotics V.92 or approved equivalent auto-dial/auto-answer external modem to accomplish the interface to the Department-furnished microcomputers. Include all necessary hardware to ensure telecommunications.

4.2.MATERIALS – GENERAL CABINETS

Provide a moisture resistant coating on all circuit boards.

Provide one 20 mm diameter radial lead UL-recognized metal oxide varistor (MOV) between each load switch field terminal and equipment ground. Electrical performance is outlined below.

PROPERTIES OF MOV SURGE PROTECTOR	
Maximum Continuous Applied Voltage at 185° F	150 VAC (RMS) 200 VDC
Maximum Peak 8x20µs Current at 185° F	6500 A
Maximum Energy Rating at 185° F	80 J
Voltage Range 1 mA DC Test at 77° F	212-268 V
Max. Clamping Voltage 8x20µs, 100A at 77° F	395 V
Typical Capacitance (1 MHz) at 77° F	1600 pF

Provide a power line surge protector that is a two-stage device that will allow connection of the radio frequency interference filter between the stages of the device. Ensure that a maximum continuous current is at least 10A at 120V. Ensure that the device can withstand a minimum of 20 peak surge current occurrences at 20,000A for an 8x20 microsecond waveform. Provide a maximum clamp voltage of 395V at 20,000A with a nominal series inductance of 200µh. Ensure that the voltage does not exceed 395V. Provide devices that comply with the following:

Frequency (Hz)	Minimum Insertion Loss (dB)
60	0
10,000	30
50,000	55
100,000	50
500,000	50
2,000,000	60
5,000,000	40
10,000,000	20
20,000,000	25

4.3. MATERIALS – TYPE 170E CABINETS

A. Type 170 E Cabinets General:

Conform to the city of Los Angeles' Specification No. 54-053-08, *Traffic Signal Cabinet Assembly Specification* (dated July 2008), except as required herein.

Furnish model 336S pole mounted cabinets configured for 8 vehicle phases, 4 pedestrian phases, and 6 overlaps. Do not reassign load switches to accommodate overlaps unless shown on electrical details. Provide 336S pole mounted cabinets that are 46" high with 40" high internal rack assemblies.

Furnish model 332 base mounted cabinets configured for 8 vehicle phases, 4 pedestrian phases, and 6 overlaps. When overlaps are required, provide auxiliary output files for the overlaps. Do not reassign load switches to accommodate overlaps unless shown on electrical details.

Provide model 200 load switches, model 222 loop detector sensors, model 252 AC isolators, and model 242 DC isolators according to the electrical details. As a minimum, provide one (1) model 2018 conflict monitor, one (1) model 206L power supply unit, two (2) model 204 flashers, one (1) DC isolator (located in slot I14), and four (4) model 430 flash transfer relays (provide seven (7) model 430 flash transfer relays if auxiliary output file is installed) with each cabinet.

B. Type 170 E Cabinet Electrical Requirements:

Provide a cabinet assembly designed to ensure that upon leaving any cabinet switch or conflict monitor initiated flashing operation, the controller starts up in the programmed start up phases and start up interval.

Furnish two sets of non-fading cabinet wiring diagrams and schematics in a paper envelope or container and placed in the cabinet drawer.

All AC+ power is subject to radio frequency signal suppression.

Provide surge suppression in the cabinet for each type of cabinet device. Provide surge protection for the full capacity of the cabinet input file. Provide surge suppression devices that

operate properly over a temperature range of -40° F to +185° F. Ensure the surge suppression devices provide both common and differential modes of protection.

Provide a pluggable power line surge protector that is installed on the back of the PDA (power distribution assembly) chassis to filter and absorb power line noise and switching transients. Ensure the device incorporates LEDs for failure indication and provides a dry relay contact closure for the purpose of remote sensing. Ensure the device meets the following specifications:

- Peak Surge Current (Single pulse, 8x20µs).....20,000A
- Occurrences (8x20µs waveform).....10 minimum @ 20,000A
- Maximum Clamp Voltage.....395VAC
- Operating Current.....15 amps
- Response Time.....< 5 nanoseconds

Provide a loop surge suppressor for each set of loop terminals in the cabinet. Ensure the device meets the following specifications:

- Peak Surge Current (6 times, 8x20µs)
 - (Differential Mode).....400A
 - (Common Mode).....1,000A
- Occurrences (8x20µs waveform).....500 min @ 200A
- Maximum Clamp Voltage
 - (Differential Mode @400A).....35V
 - (Common Mode @1,000A).....35V
- Response Time.....< 5 nanoseconds
- Maximum Capacitance.....35 pF

Provide a data communications surge suppressor for each communications line entering or leaving the cabinet. Ensure the device meets the following specifications:

- Peak Surge Current (Single pulse, 8x20µs).....10,000A
- Occurrences (8x20µs waveform).....100 min @ 2,000A
- Maximum Clamp Voltage.....Rated for equipment protected
- Response Time.....< 1 nanosecond
- Maximum Capacitance.....1,500 pF
- Maximum Series Resistance.....15Ω

Provide a DC signal surge suppressor for each DC input channel in the cabinet. Ensure the device meets the following specifications:

- Peak Surge Current (Single pulse, 8x20µs).....10,000A
- Occurrences (8x20µs waveform).....100 @ 2,000A
- Maximum Clamp Voltage.....30V
- Response Time.....< 1 nanosecond

Provide a 120 VAC signal surge suppressor for each AC+ interconnect signal input. Ensure the device meets the following specifications:

- Peak Surge Current (Single pulse, 8x20µs).....20,000A
- Maximum Clamp Voltage.....350VAC
- Response Time.....< 200 nanoseconds
- Discharge Voltage.....<200 Volts @ 1,000A
- Insulation Resistance.....≥100 MΩ

Provide conductors for surge protection wiring that are of sufficient size (ampacity) to withstand maximum overcurrents which could occur before protective device thresholds are attained and current flow is interrupted.

If additional surge protected power outlets are needed to accommodate fiber transceivers, modems, etc., install a UL listed, industrial, heavy-duty type power outlet strip with a minimum rating of 15 A / 125 VAC, 60 Hz. Provide a strip that has a minimum of 3 grounded outlets. Ensure the power outlet strip plugs into one of the controller unit receptacles located on the rear of the PDA. Ensure power outlet strip is mounted securely; provide strain relief if necessary.

Provide a door switch in the front and a door switch in the rear of the cabinet that will provide the controller unit with a Door Ajar alarm when either the front or the rear door is open. Ensure the door switches apply DC ground to the Input File when either the front door or the rear door is open.

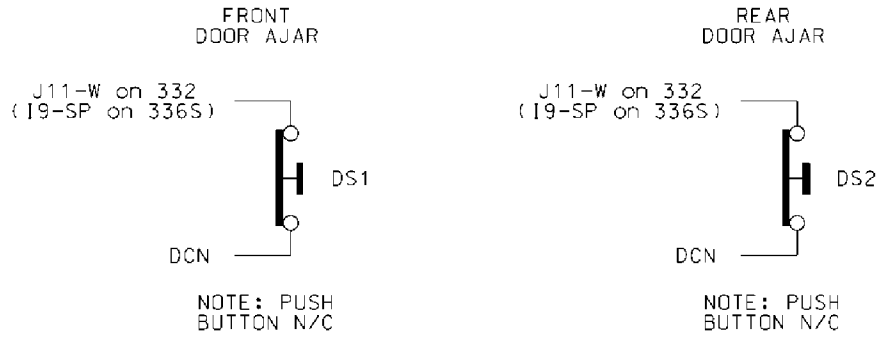

Furnish a fluorescent fixture in the rear across the top of the cabinet and another fluorescent fixture in the front across the top of the cabinet at a minimum. Ensure that the fixtures provide sufficient light to illuminate all terminals, labels, switches, and devices in the cabinet. Conveniently locate the fixtures so as not to interfere with a technician's ability to perform work on any devices or terminals in the cabinet. Provide a protective diffuser to cover exposed bulbs. Install 16 watt T-4 lamps in the fluorescent fixtures. Provide a door switch to provide power to each fixture when the respective door is open. Wire the fluorescent fixtures to the 15 amp ECB (equipment circuit breaker).

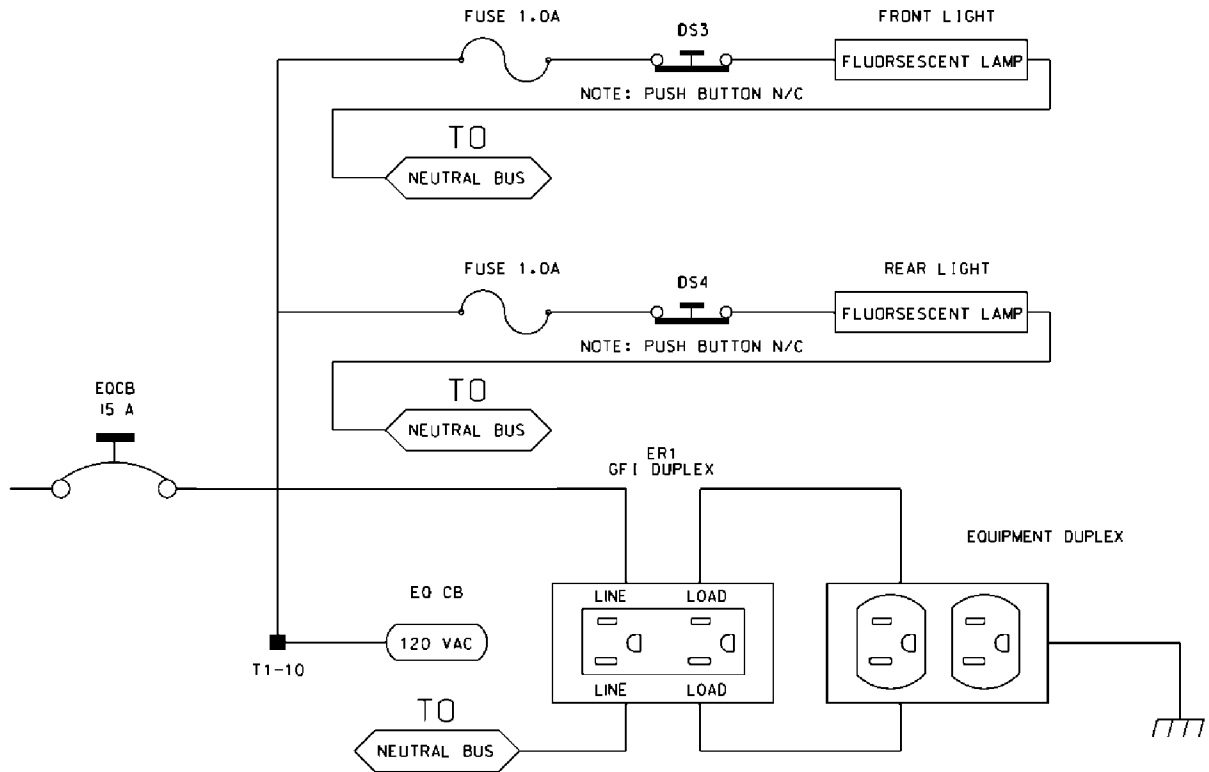

Furnish a police panel with a police panel door. For model 336S cabinets, mount the police panel on the rear door. Ensure that the police panel door permits access to the police panel when the main door is closed. Ensure that no rainwater can enter the cabinet even with the police panel door open. Provide a police panel door hinged on the right side as viewed from the front. Provide a police panel

door lock that is keyed to a standard police/fire call box key. In addition to the requirements of LA Specification No. 54-053-08, provide the police panel with a toggle switch connected to switch the intersection operation between normal stop-and-go operation (AUTO) and manual operation (MANUAL). Ensure that manual control can be implemented using inputs and software such that the controller provides full programmed clearance times for the yellow clearance and red clearance for each phase while under manual control.

Provide a 1/4-inch locking phone jack in the police panel for a hand control to manually control the intersection. Provide sufficient room in the police panel for storage of a hand control and cord.

Ensure the 336S cabinet Input File is wired as follows:

336S Cabinet														
Port-Bit/C-1 Pin Assignment														
Slot #	1	2	3	4	5	6	7	8	9	10	11	12	13	14
C-1 (Spares)	59	60	61	62	63	64	65	66	75	76	77	78	79	80
Port C-1	3-2	1-1	3-4	1-3	3-1	1-2	3-3	1-4	2-5	5-5	5-6	5-1	5-2	6-7
C-1	56	39	58	41	55	40	57	42	51	71	72	67	68	81
Port C-1	2-1	1-5	2-3	1-7	2-2	1-6	2-4	1-8	2-6	5-7	5-8	5-3	5-4	6-8
C-1	47	43	49	45	48	44	50	46	52	73	74	69	70	82

For model 332 base mounted cabinets, ensure terminals J14-E and J14-K are wired together on the rear of the Input File. Connect TB9-12 (J14 Common) on the Input Panel to T1-2 (AC-) on the rear of the PDA.

Provide detector test switches mounted at the top of the cabinet rack or other convenient location which may be used to place a call on each of eight phases based on the chart below. Provide three positions for each switch: On (place call), Off (normal detector operation), and Momentary On (place momentary call and return to normal detector operation after switch is released). Ensure that the switches are located such that the technician can read the controller display and observe the intersection.

Connect detector test switches for cabinets as follows:

336S Cabinet		332 Cabinet	
Detector Call Switches	Terminals	Detector Call Switches	Terminals
Phase 1	I1-F	Phase 1	I1-W
Phase 2	I2-F	Phase 2	I4-W
Phase 3	I3-F	Phase 3	I5-W
Phase 4	I4-F	Phase 4	I8-W
Phase 5	I5-F	Phase 5	J1-W
Phase 6	I6-F	Phase 6	J4-W
Phase 7	I7-F	Phase 7	J5-W
Phase 8	I8-F	Phase 8	J8-W

Provide the PCB 28/56 connector for the conflict monitor unit (CMU) with 28 independent contacts per side, dual-sided with 0.156 inch contact centers. Provide the PCB 28/56 connector contacts with solder eyelet terminations. Ensure all connections to the PCB 28/56 connector are soldered to the solder eyelet terminations.

Ensure that all cabinets have the CMU connector wired according to the 332 cabinet connector pin assignments (include all wires for auxiliary output file connection). Wire pins 13, 16, R, and U of the CMU connector to a separate 4 pin plug, P1, as shown below. Provide a second plug, P2, which will mate with P1 and is wired to the auxiliary output file as shown below. Provide an additional plug, P3, which will mate with P1 and is wired to the pedestrian yellow circuits as shown below. When no auxiliary output file is installed in the cabinet, provide wires for the green and yellow inputs for channels 11, 12, 17, and 18, the red inputs for channels 17 and 18, and the wires for the P2 plug. Terminate the two-foot wires with ring type lugs, insulated, and bundled for optional use.

PIN	P1		P2		P3	
	FUNCTION	CONN TO	FUNCTION	CONN TO	FUNCTION	CONN TO
1	CH-9G	CMU-13	OLA-GRN	A123	2P-YEL	114
2	CH-9Y	CMU-16	OLA-YEL	A122	4P-YEL	105
3	CH-10G	CMU-R	OLB-GRN	A126	6P-YEL	120
4	CH-10Y	CMU-U	OLB-YEL	A125	8P-YEL	111

Do not provide the P20 terminal assembly (red monitor board) or red interface ribbon cable as specified in LA Specification No. 54-053-08.

Provide a P20 connector that mates with and is compatible with the red interface connector mounted on the front of the conflict monitor. Ensure that the P20 connector and the red interface

connector on the conflict monitor are center polarized to ensure proper connection. Ensure that removal of the P20 connector will cause the conflict monitor to recognize a latching fault condition and place the cabinet into flashing operation.

Wire the P20 connector to the output file and auxiliary output file using 22 AWG stranded wires. Ensure the length of these wires is a minimum of 42 inches in length. Provide a durable braided sleeve around the wires to organize and protect the wires.

Wire the P20 connector to the traffic signal red displays to provide inputs to the conflict monitor as shown below. Ensure the pedestrian Don't Walk circuits are wired to channels 13 through 16 of the P20 connector. When no auxiliary output file is installed in the cabinet, provide wires for channels 9 through 12 reds. Provide a wire for special function 1. Terminate the unused wires with ring type lugs, insulated, and bundled for optional use.

P20 Connector					
PIN	FUNCTION	CONN TO	PIN	FUNCTION	CONN TO
1	Channel 15 Red	119	2	Channel 16 Red	110
3	Channel 14 Red	104	4	Chassis GND	01-9
5	Channel 13 Red	113	6	N/C	
7	Channel 12 Red	AUX 101	8	Spec Function 1	
9	Channel 10 Red	AUX 124	10	Channel 11 Red	AUX 114
11	Channel 9 Red	AUX 121	12	Channel 8 Red	107
13	Channel 7 Red	122	14	Channel 6 Red	134
15	Channel 5 Red	131	16	Channel 4 Red	101
17	Channel 3 Red	116	18	Channel 2 Red	128
19	Channel 1 Red	125	20	Red Enable	01-14

Ensure the controller unit outputs to the auxiliary output file are pre-wired to the C5 connector. When no auxiliary output file is installed in the cabinet, connect the C5 connector to a storage socket located on the Input Panel or on the rear of the PDA.

Do not wire pin 12 of the load switch sockets.

In addition to the requirements of LA Specification No. 54-053-08, ensure relay K1 on the Power Distribution Assembly (PDA) is a four pole relay and K2 on the PDA is a two pole relay.

Provide a two pole, ganged circuit breaker for the flash bus circuit. Ensure the flash bus circuit breaker is an inverse time circuit breaker rated for 10 amps at 120 VAC with a minimum of 10,000 RMS symmetrical amperes short circuit current rating. Do not provide the auxiliary switch feature on the flash bus circuit breaker. Ensure the ganged flash bus circuit breaker is certified by the circuit breaker manufacturer to provide gang tripping operation.

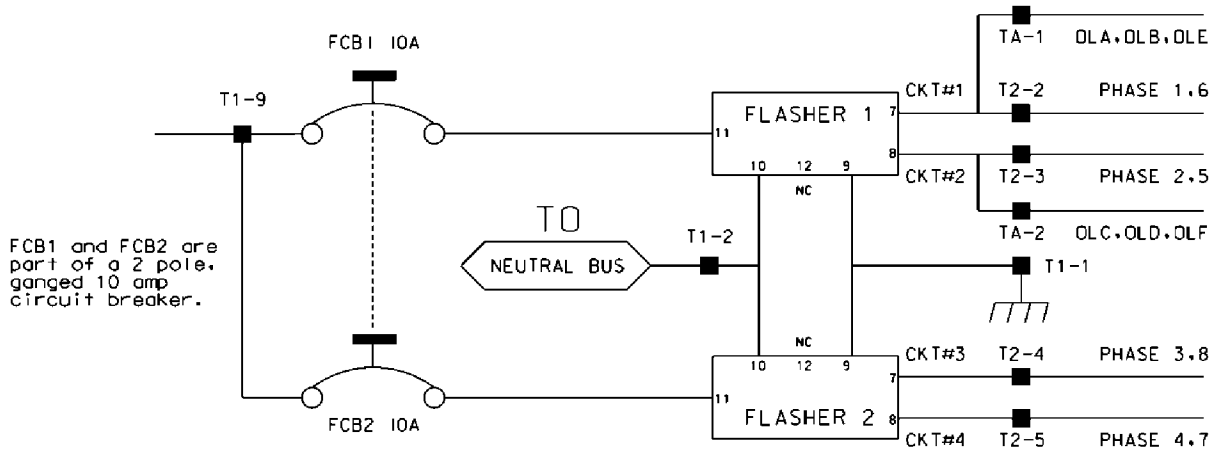

Ensure auxiliary output files are wired as follows:

AUXILIARY OUTPUT FILE	
TERMINAL BLOCK TA ASSIGNMENTS	
POSITION	FUNCTION
1	Flasher Unit #1, Circuit 1/FTR1 (OLA, OLB)/FTR3 (OLE)
2	Flasher Unit #1, Circuit 2/FTR2 (OLC, OLD)/FTR3 (OLF)
3	Flash Transfer Relay Coils
4	AC -
5	Power Circuit 5
6	Power Circuit 5
7	Equipment Ground Bus
8	NC

Provide four spare load resistors mounted in each cabinet. Ensure each load resistor is rated as shown in the table below. Wire one side of each load resistor to AC-. Connect the other side of each resistor to a separate terminal on a four (4) position terminal block. Mount the load resistors and terminal block either inside the back of Output File No. 1 or on the upper area of the Service Panel.

ACCEPTABLE LOAD RESISTOR VALUES	
VALUE (ohms)	WATTAGE
1.5K – 1.9 K	25W (min)
2.0K – 3.0K	10W (min)

Provide Model 200 load switches, Model 204 flashers, Model 242 DC isolators, Model 252 AC isolators, and Model 206L power supply units that conform to CALTRANS' *Transportation Electrical Equipment Specifications* dated March 12, 2009 with Erratum 1.

C. Type 170 E Cabinet Physical Requirements:

Do not mold, cast, or scribe the name "City of Los Angeles" on the outside of the cabinet door as specified in LA Specification No. 54-053-08. Do not provide a Communications Terminal Panel as specified in LA Specification No. 54-053-08. Do not provide terminal block TBB on the Service Panel. Do not provide Cabinet Verification Test Program software or associated test jigs as specified in LA Specification No. 54-053-08.

Furnish unpainted, natural, aluminum cabinet shells. Ensure that all non-aluminum hardware on the cabinet is stainless steel or a Department approved non-corrosive alternate.

Ensure the lifting eyes, gasket channels, police panel, and all supports welded to the enclosure and doors are fabricated from 0.125 inch minimum thickness aluminum sheet and meet the same standards as the cabinet and doors.

Provide front and rear doors with latching handles that allow padlocking in the closed position. Furnish 0.75 inch minimum diameter stainless steel handles with a minimum 0.5 inch shank. Place the padlocking attachment at 4.0 inches from the handle shank center to clear the lock and key. Provide an additional 4.0 inches minimum gripping length.

Provide Corbin #2 locks on the front and rear doors. Provide one (1) Corbin #2 and one (1) police master key with each cabinet. Ensure main door locks allow removal of keys in the locked position only.

Provide a surge protection panel with 16 loop surge protection devices and designed to allow sufficient free space for wire connection/disconnection and surge protection device replacement. For model 332 cabinets, provide an additional 20 loop surge protection devices. Provide an additional two AC+ interconnect surge devices to protect one slot and eight DC surge protection devices to protect four slots. Provide no protection devices on slot I14.

For pole mounted cabinets, mount surge protection devices for the AC+ interconnect inputs, inductive loop detector inputs, and low voltage DC inputs on a swing down panel assembly fabricated from sturdy aluminum. Attach the swing down panel to the bottom rear cabinet rack assembly using thumb screws. Ensure the swing down panel allows for easy removal of the input file without removing the surge protection panel assembly or its parts. Have the surge protection devices mounted horizontally on the panel and soldered to the feed through terminals of four 14 position terminal blocks with #8 screws mounted on the other side. Ensure the top row of terminals is connected to the upper slots and the bottom row of terminals is connected to the bottom slots. Provide a 15 position copper equipment ground bus attached to the field terminal side (outside) of

the swing down panel for termination of loop lead-in shield grounds. Ensure that a Number 4 AWG green wire connects the surge protection panel assembly ground bus to the main cabinet equipment ground.

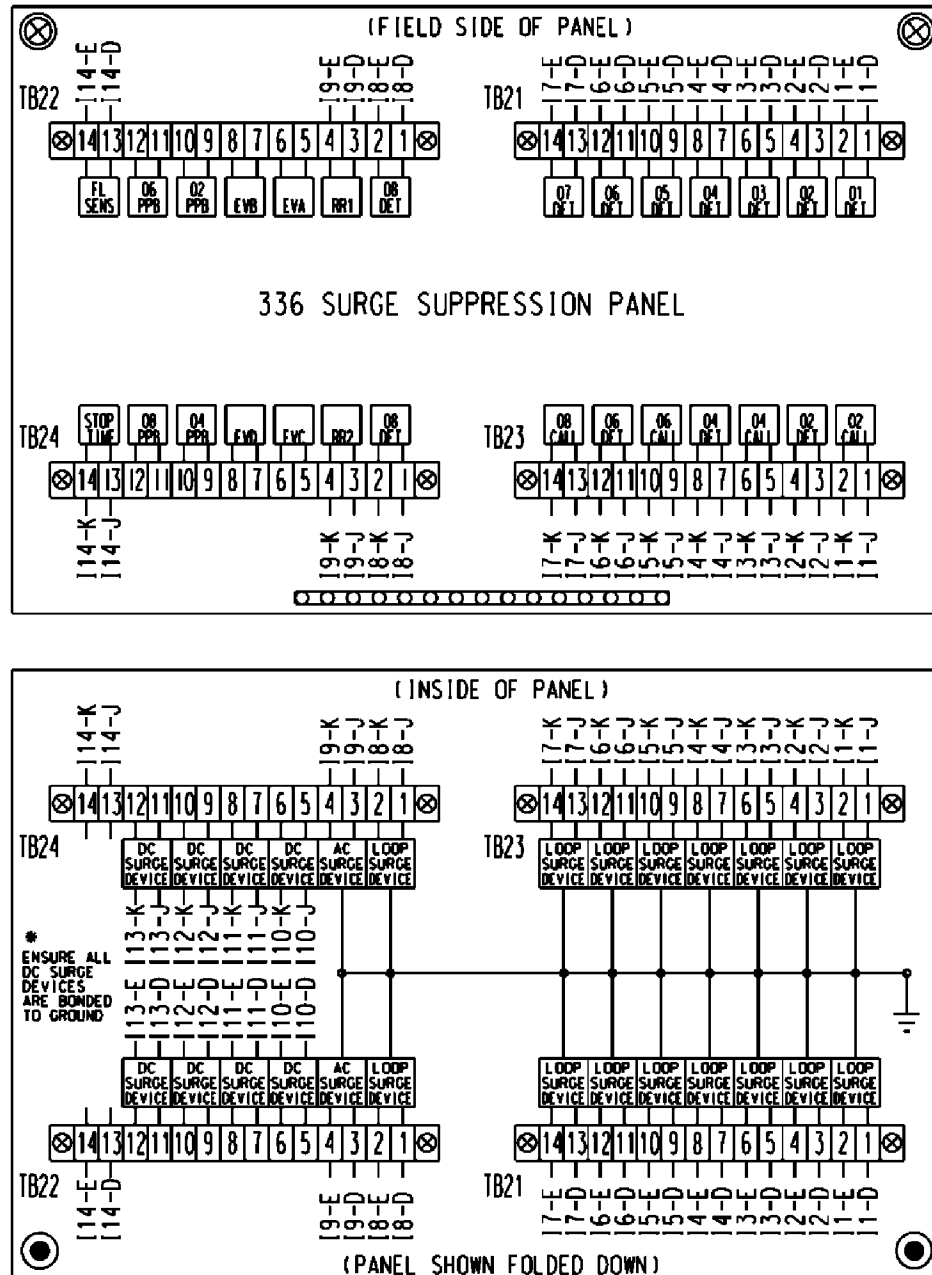

For base mounted cabinets, mount surge protection panels on the left side of the cabinet as viewed from the rear. Attach each panel to the cabinet rack assembly using bolts and make it easily removable. Mount the surge protection devices in vertical rows on each panel and connect the

devices to one side of 12 position, double row terminal blocks with #8 screws. For each surge protection panel, terminate all grounds from the surge protection devices on a copper equipment ground bus attached to the surge protection panel. Wire the terminals to the rear of a standard input file using spade lugs for input file protection.

Provide permanent labels that indicate the slot and the pins connected to each terminal that may be viewed from the rear cabinet door. Label and orient terminals so that each pair of inputs is next to each other. Indicate on the labeling the input file (I or J), the slot number (1-14) and the terminal pins of the input slots (either D & E for upper or J & K for lower).

Provide a minimum 14 x 16 inch pull out, hinged top shelf located immediately below controller mounting section of the cabinet. Ensure the shelf is designed to fully expose the table surface outside the controller at a height approximately even with the bottom of the controller. Ensure the shelf has a storage bin interior which is a minimum of 1 inch deep and approximately the same dimensions as the shelf. Provide an access to the storage area by lifting the hinged top of the shelf. Fabricate the shelf and slide from aluminum or stainless steel and ensure the assembly can support the 2070L controller plus 15 pounds of additional weight. Ensure shelf has a locking mechanism to secure it in the fully extended position and does not inhibit the removal of the 2070L controller or removal of cards inside the controller when fully extended. Provide a locking mechanism that is easily released when the shelf is to be returned to its non-use position directly under the controller.

D. Model 2018 Enhanced Conflict Monitor:

Furnish Model 2018 Enhanced Conflict Monitors that provide monitoring of 18 channels. Ensure each channel consists of a green, yellow, and red field signal input. Ensure that the conflict monitor meets or exceeds CALTRANS' Transportation Electrical Equipment Specifications dated March 12, 2009, with Erratum 1 (hereafter referred to as CALTRANS' 2009 TEES) for a model 210 monitor unit and other requirements stated in this specification.

Ensure the conflict monitor is provided with an 18 channel conflict programming card. Pin EE and Pin T of the conflict programming card shall be connected together. Pin 16 of the conflict programming card shall be floating. Ensure that the absence of the conflict programming card will cause the conflict monitor to trigger (enter into fault mode), and remain in the triggered state until the programming card is properly inserted and the conflict monitor is reset.

Provide a conflict monitor that incorporates LED indicators into the front panel to dynamically display the status of the monitor under normal conditions and to provide a comprehensive review of field inputs with monitor status under fault conditions. Ensure that the monitor indicates the channels that were active during a conflict condition and the channels that experienced a failure for all other per channel fault conditions detected. Ensure that these indications and the status of each channel are retained until the Conflict Monitor is reset. Furnish LED indicators for the following:

- AC Power (Green LED indicator)
- VDC Failed (Red LED indicator)
- WDT Error (Red LED indicator)
- Conflict (Red LED indicator)
- Red Fail (Red LED indicator)
- Dual Indication (Red LED indicator)

- Yellow/Clearance Failure (Red LED indicator)
- PCA/PC Ajar (Red LED indicator)
- Monitor Fail/Diagnostic Failure (Red LED indicator)
- 54 Channel Status Indicators (1 Red, 1 Yellow, and 1 Green LED indicator for each of the 18 channels)

Provide a switch to set the Red Fail fault timing. Ensure that when the switch is in the ON position the Red Fail fault timing value is set to 1350 +/- 150ms (2018 mode). Ensure that when the switch is in the OFF position the Red Fail fault timing value is set to 850 +/- 150ms (210 mode).

Provide a switch to set the Watchdog fault timing. Ensure that when the switch is in the ON position the Watchdog fault timing value is set to 1.0 +/- 0.1s (2018 mode). Ensure that when the switch is in the OFF position the Watchdog fault timing value is set to 1.5 +/- 0.1s (210 mode).

Provide a jumper or switch to set the AC line brown-out levels. Ensure that when the jumper is present or the switch is in the ON position the AC line dropout voltage threshold is 98 +/- 2 Vrms, the AC line restore voltage threshold is 103 +/- 2 Vrms, and the AC line brown-out timing value is set to 400 +/- 50ms (2018 mode). Ensure that when the jumper is not present or the switch is in the OFF position the AC line dropout voltage threshold is 92 +/- 2 Vrms, the AC line restore voltage threshold is 98 +/- 2 Vrms, and the AC line brown-out timing value is set to 80 +/- 17ms (210 mode).

Provide a jumper or switch that will enable and disable the Watchdog Latch function. Ensure that when the jumper is not present or the switch is in the OFF position the Watchdog Latch function is disabled. In this mode of operation, a Watchdog fault will be reset following a power loss, brownout, or power interruption. Ensure that when the jumper is present or the switch is in the ON position the Watchdog Latch function is enabled. In this mode of operation, a Watchdog fault will be retained until a Reset command is issued.

Provide a jumper that will reverse the active polarity for pin #EE (output relay common). Ensure that when the jumper is not present pin #EE (output relay common) will be considered 'Active' at a voltage greater than 70 Vrms and 'Not Active' at a voltage less than 50 Vrms (Caltrans mode). Ensure that when the jumper is present pin #EE (output relay common) will be considered 'Active' at a voltage less than 50 Vrms and 'Not Active' at a voltage greater than 70 Vrms (Failsafe mode).

In addition to the connectors required by CALTRANS' 2009 TEES, provide the conflict monitor with a red interface connector mounted on the front of the monitor. Ensure the connector is a 20 pin, right angle, center polarized, male connector with latching clip locks and polarizing keys. Ensure the right angle solder tails are designed for a 0.062" thick printed circuit board. Keying of the connector shall be between pins 3 and 5, and between 17 and 19. Ensure the connector has two rows of pins with the odd numbered pins on one row and the even pins on the other row. Ensure the connector pin row spacing is 0.10" and pitch is 0.10". Ensure the mating length of the connector pins is 0.24". Ensure the pins are finished with gold plating 30μ" thick.

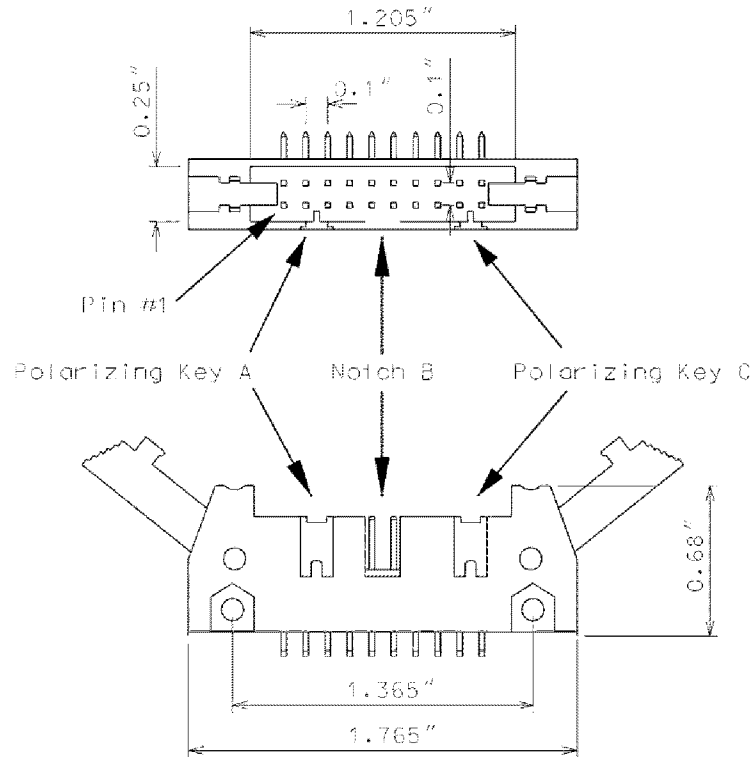

Ensure the red interface connector pins on the monitor have the following functions:

Pin #	Function	Pin #	Function
1	Channel 15 Red	2	Channel 16 Red
3	Channel 14 Red	4	Chassis Ground
5	Channel 13 Red	6	Special Function 2
7	Channel 12 Red	8	Special Function 1
9	Channel 10 Red	10	Channel 11 Red
11	Channel 9 Red	12	Channel 8 Red
13	Channel 7 Red	14	Channel 6 Red
15	Channel 5 Red	16	Channel 4 Red
17	Channel 3 Red	18	Channel 2 Red
19	Channel 1 Red	20	Red Enable

Ensure that removal of the P20 cable connector will cause the conflict monitor to recognize a latching fault condition and place the cabinet into flashing operation.

Provide Special Function 1 and Special Function 2 inputs to the unit which shall disable only Red Fail Monitoring when either input is sensed active. A Special Function input shall be sensed active when the input voltage exceeds 70 Vrms with a minimum duration of 550 ms. A Special Function input shall be sensed not active when the input voltage is less than 50 Vrms or the duration is less than 250 ms. A Special Function input is undefined by these specifications and may or may not be sensed active when the input voltage is between 50 Vrms and 70 Vrms or the duration is between 250 ms and 550 ms.

Ensure the conflict monitor recognizes field signal inputs for each channel that meet the following requirements:

- consider a Red input greater than 70 Vrms and with a duration of at least 500 ms as an “on” condition;
- consider a Red input less than 50 Vrms or with a duration of less than 200 ms as an “off” condition (no valid signal);
- consider a Red input between 50 Vrms and 70 Vrms or with a duration between 200 ms and 500 ms to be undefined by these specifications;
- consider a Green or Yellow input greater than 25 Vrms and with a duration of at least 500 ms as an “on” condition;
- consider a Green or Yellow input less than 15 Vrms or with a duration of less than 200 ms as an “off” condition; and
- consider a Green or Yellow input between 15 Vrms and 25 Vrms or with a duration between 200 ms and 500 ms to be undefined by these specifications.

Provide a conflict monitor that recognizes the faults specified by CALTRANS’ 2009 TEES and the following additional faults. Ensure the conflict monitor will trigger upon detection of a fault and will remain in the triggered (in fault mode) state until the unit is reset at the front panel or through the external remote reset input for the following failures:

1. **Red Monitoring or Absence of Any Indication (Red Failure):** A condition in which no “on” voltage signal is detected on any of the green, yellow, or red inputs to a given monitor channel. If a signal is not detected on at least one input (R, Y, or G) of a conflict monitor channel for a period greater than 1000 ms when used with a 170 controller and 1500 ms when used with a 2070L controller, ensure monitor will trigger and put the intersection into flash. If the absence of any indication condition lasts less than 750 ms when used with a 170 controller and 1200 ms when used with a 2070L controller, ensure conflict monitor will not trigger. Red fail monitoring shall be enabled on a per channel basis by the use of switches located on the conflict monitor. Have red monitoring occur when all of the following input conditions are in effect:
 - a) Red Enable input to monitor is active (Red Enable voltages are “on” at greater than 70 Vrms, off at less than 50 Vrms, undefined between 50 and 70 Vrms), and
 - b) Neither Special Function 1 nor Special Function 2 inputs are active.

- c) Pin #EE (output relay common) is not active
2. **Short/Missing Yellow Indication Fault (Clearance Error):** Yellow indication following a green is missing or shorter than 2.7 seconds (with ± 0.1 -second accuracy). If a channel fails to detect an “on” signal at the Yellow input for a minimum of 2.7 seconds (± 0.1 second) following the detection of an “on” signal at a Green input for that channel, ensure that the monitor triggers and generates a clearance/short yellow error fault indication. Short/missing yellow (clearance) monitoring shall be enabled on a per channel basis by the use of switches located on the conflict monitor. This fault shall not occur when the channel is programmed for Yellow Inhibit, when the Red Enable signal is inactive or pin #EE (output relay common) is active.
 3. **Dual Indications on the Same Channel:** In this condition, more than one indication (R,Y,G) is detected as “on” at the same time on the same channel. If dual indications are detected for a period greater than 500 ms, ensure that the conflict monitor triggers and displays the proper failure indication (Dual Ind fault). If this condition is detected for less than 200 ms, ensure that the monitor does not trigger. G-Y-R dual indication monitoring shall be enabled on a per channel basis by the use of switches located on the conflict monitor. G-Y dual indication monitoring shall be enabled for all channels by use of a switch located on the conflict monitor. This fault shall not occur when the Red Enable signal is inactive or pin #EE (output relay common) is active.
 4. **Configuration Settings Change:** The configuration settings are comprised of (as a minimum) the permissive diode matrix, dual indication switches, yellow disable jumpers, any option switches, any option jumpers, and the Watchdog Enable switch. Ensure the conflict monitor compares the current configuration settings with the previous stored configuration settings on power-up, on reset, and periodically during operation. If any of the configuration settings are changed, ensure that the conflict monitor triggers and causes the program card indicator to flash. Ensure that configuration change faults are only reset by depressing and holding the front panel reset button for a minimum of three seconds. Ensure the external remote reset input does not reset configuration change faults.

Ensure the conflict monitor will trigger and the AC Power indicator will flash at a rate of 2 Hz \pm 20% with a 50% duty cycle when the AC Line voltage falls below the “drop-out” level. Ensure the conflict monitor will resume normal operation when the AC Line voltage returns above the “restore” level. Ensure the AC Power indicator will remain illuminated when the AC voltage returns above the “restore” level. Should an AC Line power interruption occur while the monitor is in the fault mode, then upon restoration of AC Line power, the monitor will remain in the fault mode and the correct fault and channel indicators will be displayed.

Provide a flash interval of at least 6 seconds and at most 10 seconds in duration following a power-up, an AC Line interruption, or a brownout restore. Ensure the conflict monitor will suspend all fault monitoring functions, close the Output relay contacts, and flash the AC indicator at a rate of 4 Hz \pm 20% with a 50% duty cycle during this interval. Ensure the termination of the flash interval after at least 6 seconds if the Watchdog input has made 5 transitions between the True and False state and the AC Line voltage is greater than the “restore” level. If the watchdog input has not made

5 transitions between the True and False state within 10 ± 0.5 seconds, the monitor shall enter a WDT error fault condition.

Ensure the conflict monitor will monitor an intersection with a minimum of four approaches using the four-section Flashing Yellow Arrow (FYA) vehicle traffic signal as outlined by the NCHRP 3-54 research project for protected-permissive left turn signal displays. Ensure the conflict monitor will operate in the FYA mode and FYAc (Compact) mode as specified below to monitor each channel for the following fault conditions: Conflict, Red Fail, Dual Indication, and Clearance. Provide a switch to select between the FYA mode and FYAc mode. Provide a switch to select each FYA phase movement for monitoring.

FYA mode

FYA Signal Head	Phase 1	Phase 3	Phase 5	Phase 7
Red Arrow	Channel 9 Red	Channel 10 Red	Channel 11 Red	Channel 12 Red
Yellow Arrow	Channel 9 Yellow	Channel 10 Yellow	Channel 11 Yellow	Channel 12 Yellow
Flashing Yellow Arrow	Channel 9 Green	Channel 10 Green	Channel 11 Green	Channel 12 Green
Green Arrow	Channel 1 Green	Channel 3 Green	Channel 5 Green	Channel 7 Green

FYAc mode

FYA Signal Head	Phase 1	Phase 3	Phase 5	Phase 7
Red Arrow	Channel 1 Red	Channel 3 Red	Channel 5 Red	Channel 7 Red
Yellow Arrow	Channel 1 Yellow	Channel 3 Yellow	Channel 5 Yellow	Channel 7 Yellow
Flashing Yellow Arrow	Channel 1 Green	Channel 3 Green	Channel 5 Green	Channel 7 Green
Green Arrow	Channel 9 Green	Channel 9 Yellow	Channel 10 Green	Channel 10 Yellow

Ensure that the conflict monitor will log at least nine of the most recent events detected by the monitor in non-volatile EEPROM memory (or equivalent). For each event, record at a minimum the time, date, type of event, status of each field signal indication with RMS voltage, and specific channels involved with the event. Ensure the conflict monitor will log the following events: monitor reset, configuration, previous fault, and AC line. Furnish the signal sequence log that shows all channel states (Greens, Yellows, and Reds) and the Red Enable State for a minimum of 2 seconds prior to the current fault trigger point. Ensure the display resolution of the inputs for the signal sequence log is not greater than 50 ms.

For conflict monitors used within an Ethernet communications system, provide a conflict monitor with an Ethernet 10/100 Mbps, RJ-45 port for data communication access to the monitor by a local notebook computer and remotely via a workstation or notebook computer device connected to the signal system local area network. The Ethernet port shall be electrically isolated from the conflict monitor's electronics and shall provide a minimum of 1500 Vrms isolation. Integrate monitor with Ethernet network in cabinet. Provide software to retrieve the time and date from a network server in order to synchronize the on-board times between the conflict monitor and the controller. Furnish and install the following Windows based, graphic user interface software on workstations and notebook computers where the signal system client software is installed: 1) software to view and retrieve all event log information, 2) software that will search and display a list of conflict monitor IP addresses and IDs on the network, and 3) software to change the conflict monitor's network parameters such as IP address and subnet mask.

For non-Ethernet connected monitors, provide a RS-232C/D compliant port (DB-9 female connector) on the front panel of the conflict monitor in order to provide communications from the conflict monitor to the 170/2070L controller or to a Department-furnished laptop computer. Electrically isolate the port interface electronics from all monitor electronics, excluding Chassis Ground. Ensure that the controller can receive all event log information through a controller Asynchronous Communications Interface Adapter (Type 170E) or Async Serial Comm Module (2070). Furnish and connect a serial cable from the conflict monitor's DB-9 connector to Comm Port 1 of the 2070 controller. Ensure conflict monitor communicates with the controller. Provide a Windows based graphic user interface software to communicate directly through the same monitor RS-232C/D compliant port to retrieve and view all event log information to a Department-furnished laptop computer. The RS-232C/D compliant port on the monitor shall allow the monitor to function as a DCE device with pin connections as follows:

Conflict Monitor RS-232C/D (DB-9 Female) Pinout		
Pin Number	Function	I/O
1	DCD	O
2	TX Data	O
3	RX Data	I
4	DTR	I
5	Ground	-
6	DSR	O
7	CTS	I
8	RTS	O
9	NC	-

MONITOR BOARD EDGE CONNECTOR

Pin #	Function (Back Side)	Pin #	Function (Component Side)
1	Channel 2 Green	A	Channel 2 Yellow
2	Channel 13 Green	B	Channel 6 Green
3	Channel 6 Yellow	C	Channel 15 Green
4	Channel 4 Green	D	Channel 4 Yellow
5	Channel 14 Green	E	Channel 8 Green
6	Channel 8 Yellow	F	Channel 16 Green
7	Channel 5 Green	H	Channel 5 Yellow
8	Channel 13 Yellow	J	Channel 1 Green
9	Channel 1 Yellow	K	Channel 15 Yellow
10	Channel 7 Green	L	Channel 7 Yellow
11	Channel 14 Yellow	M	Channel 3 Green
12	Channel 3 Yellow	N	Channel 16 Yellow
13	Channel 9 Green	P	Channel 17 Yellow
14	Channel 17 Green	R	Channel 10 Green
15	Channel 11 Yellow	S	Channel 11 Green
16	Channel 9 Yellow	T	Channel 18 Yellow
17	Channel 18 Green	U	Channel 10 Yellow
--		--	
18	Channel 12 Yellow	V	Channel 12 Green
19	Channel 17 Red	W	Channel 18 Red
20	Chassis Ground	X	Not Assigned
21	AC-	Y	DC Common
22	Watchdog Timer	Z	External Test Reset
23	+24VDC	AA	+24VDC
24	Tied to Pin 25	BB	Stop Time (Output)
25	Tied to Pin 24	CC	Not Assigned
26	Not Assigned	DD	Not Assigned
27	Relay Output, Side #3, N.O.	EE	Relay Output, Side #2, Common
28	Relay Output, Side #1, N.C.	FF	AC+

-- Slotted for keying between Pins 17/U and 18/V

CONFLICT PROGRAM CARD PIN ASSIGNMENTS

Pin #	Function (Back Side)	Pin #	Function (Component Side)
1	Channel 2 Green	A	Channel 1 Green
2	Channel 3 Green	B	Channel 2 Green
3	Channel 4 Green	C	Channel 3 Green
4	Channel 5 Green	D	Channel 4 Green
5	Channel 6 Green	E	Channel 5 Green
6	Channel 7 Green	F	Channel 6 Green
7	Channel 8 Green	H	Channel 7 Green
8	Channel 9 Green	J	Channel 8 Green
9	Channel 10 Green	K	Channel 9 Green
10	Channel 11 Green	L	Channel 10 Green
11	Channel 12 Green	M	Channel 11 Green
12	Channel 13 Green	N	Channel 12 Green
13	Channel 14 Green	P	Channel 13 Green
14	Channel 15 Green	R	Channel 14 Green
15	Channel 16 Green	S	Channel 15 Green
16	N/C	T	PC AJAR
17	Channel 1 Yellow	U	Channel 9 Yellow
18	Channel 2 Yellow	V	Channel 10 Yellow
19	Channel 3 Yellow	W	Channel 11 Yellow
20	Channel 4 Yellow	X	Channel 12 Yellow
21	Channel 5 Yellow	Y	Channel 13 Yellow
22	Channel 6 Yellow	Z	Channel 14 Yellow
23	Channel 7 Yellow	AA	Channel 15 Yellow
24	Channel 8 Yellow	BB	Channel 16 Yellow
--		--	
25	Channel 17 Green	CC	Channel 17 Yellow
26	Channel 18 Green	DD	Channel 18 Yellow
27	Channel 16 Green	EE	PC AJAR (Program Card)
28	Yellow Inhibit Common	FF	Channel 17 Green

-- Slotted for keying between Pins 24/BB and 25/CC

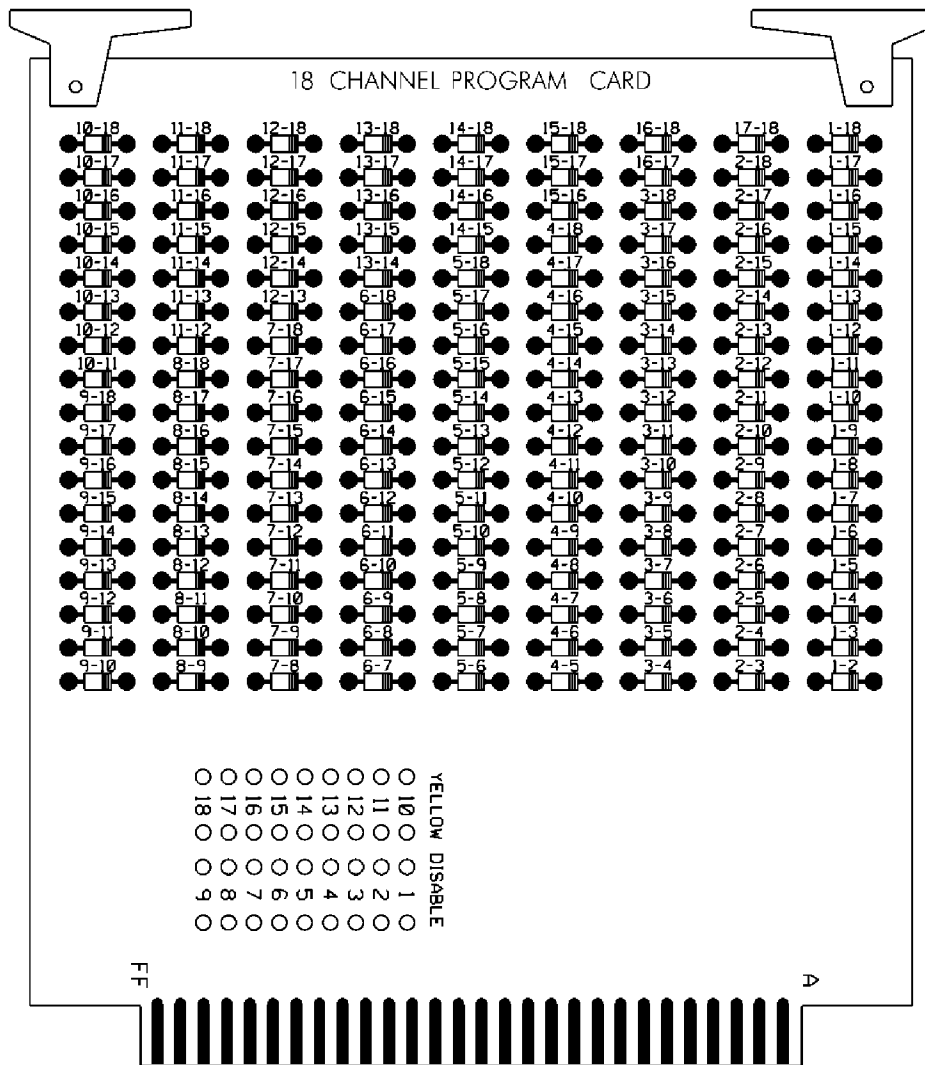

E. Preemption and Sign Control Box

Provide preemption and sign control box to operate in a Model 332 and Model 336S cabinet. Provide hardware to mount the box to the cage of the cabinet to ensure the front side is facing the opposite side of the cabinet. Furnish the material of the box from a durable finished metallic or thermoplastic case. Ensure the size of the box is not greater than 7(l) x 5(w) x 5(d) inches. Ensure that no modification is necessary to mount the box on the cabinet cage.

Provide the following components in the preemption and sign control box: relays, fuses, terminal blocks, MOVs, resistor, RC network, lamp, and push button switch.

Provide UL Listed or Recognized relay K1 as a DPDT enclosed relay (120 VAC, 60 Hz coil) with an 8-pin octal-style plug and associated octal base. Provide contact material made of AgCdO with a 10 amp, 240 VAC rating. Ensure the relay has a specified pickup voltage of 102 VAC.

Provide relay SSR1 as a Triac SPST normally open solid state relay that is rated for 120 VAC input and zero-crossing (resistive load) 25 amp @ 120 VAC output. Ensure the relay turns on at 90 Vrms within 10 ms and turns off at 10 Vrms within 40 ms. Ensure the relay has physical

characteristics as shown in the wiring detail in Figure 1. Provide 4 terminal screws with saddle clamps.

Provide fuses F1 and F2 as a UL Listed ¼" x 1-1/4" glass tube rated at 250 volts with a 10kA interrupting rating. Ensure F1 non-delay (fast-acting) and F2 slow-blow (time-delay) fuses have a maximum opening times of 60 minutes and 120 seconds for currents of 135 and 200 percent of the ampere rating, respectively. Ensure F2 slow-blow (time-delay) fuses have a minimum opening times of 12 seconds at 200 percent of the ampere rating. Provide fuse holders that are UL Recognized panel-mounted holders rated 250V, 15 ampere minimum with bayonet-type knobs which accept ¼" x 1-1/4" glass tube fuses.

Provide terminal blocks that are rated for 300V and are made of electrical grade thermoplastic or thermosetting plastic. Ensure each terminal block is of closed back design and has recessed-screw terminals with molded barriers between terminals. Ensure each terminal block is labeled with a block designation. Ensure each terminal is labeled with the function and a number.

Provide 3/4-inch diameter radial lead UL-recognized metal oxide varistors (MOVs) that have electrical performance as outlined below.

PROPERTIES OF MOV SURGE PROTECTOR	
Maximum Continuous Applied Voltage at 185° F	150 VAC (RMS) 200 VDC
Maximum Peak 8x20µs Current at 185° F	6500 A
Maximum Energy Rating at 185° F	80 J
Voltage Range 1 mA DC Test at 77° F	212-268 V
Max. Clamping Voltage 8x20µs, 100A at 77° F	395 V
Typical Capacitance (1 MHz) at 77° F	1600 pF

Provide resistor R1 as a 2K ohm, 12 watt, wirewound resistor with tinned terminals and attaching leads. Ensure the resistor is spaced apart from surrounding wires.

Provide a LED or incandescent lamp that has a voltage rating of 120 VAC with a minimum life rating at 50,000 hours.

Wire the preemption and sign control box as shown in Figure 1.

RAILROAD PREEMPTION WIRING DETAIL

(wire as shown below)

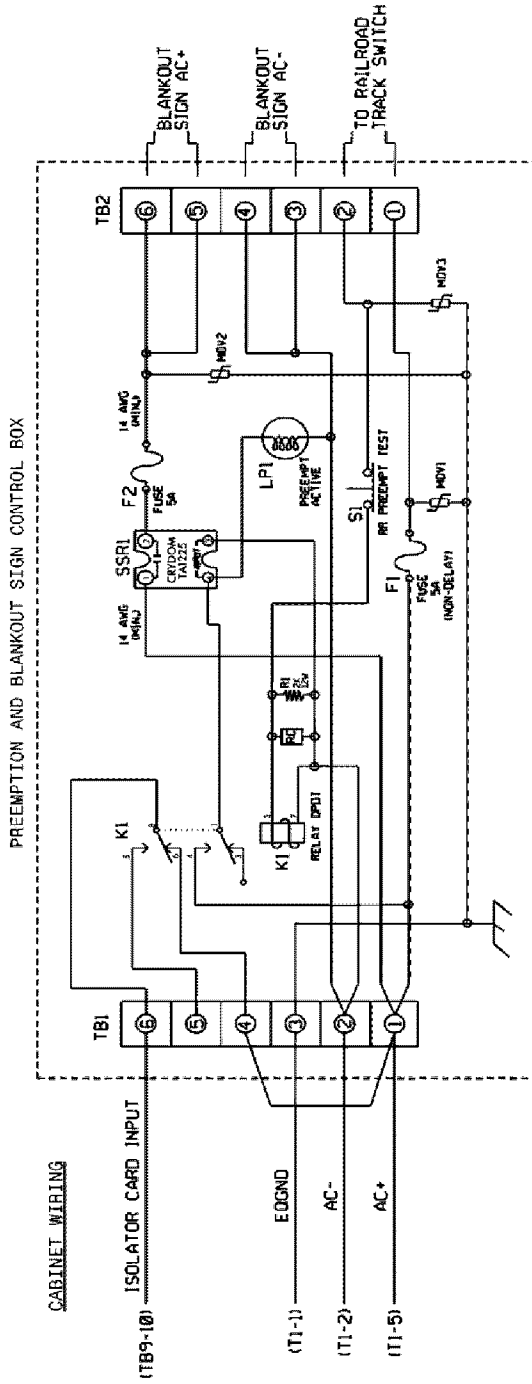

NOTES

1. RELAY K1 IS SHOWN IN THE ENERGIZED (PREEMPT NOT ACTIVE) NORMAL OPERATION STATE.
2. AC ISOLATOR CARD SHALL ACTIVATE PREEMPTION UPON REMOVAL OF AC+ FROM INPUT (AS SHOWN ABOVE). THIS IS ACCOMPLISHED BY SETTING TYPE 252 AC ISOLATOR CARD TO INVERTED OPERATION.

FRONT VIEW

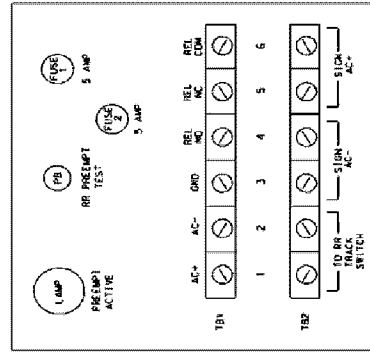

Figure 1

4.4. MATERIALS – TYPE 170 DETECTOR SENSOR UNITS

Furnish detector sensor units that comply with Chapter 5 Section 1, “General Requirements,” and Chapter 5 Section 2, “Model 222 & 224 Loop Detector Sensor Unit Requirements,” of the CALTRANS “Transportation Electrical Equipment Specifications” dated March 12, 2009 with Erratum 1.

4.5. MATERIALS – TYPE 2070E CONTROLLERS

Conform to CALTRANS *Transportation Electrical Equipment Specifications* (TEES) (dated March 12, 2009, plus Errata 1 dated January 21, 2010) except as required herein.

Furnish Model 2070E controllers. Ensure that removal of the CPU module from the controller will place the intersection into flash.

The Department will provide software at the beginning of the burning-in period. Contractor shall give 5 working days notice before needing software. Program software provided by the Department.

Provide Model 2070E controllers with the latest version of OS9 operating software and device drivers, composed of the unit chassis and at a minimum the following modules and assemblies:

- MODEL 2070-1E, CPU Module, Single Board, with 8Mb Datakey (blue in color)
- MODEL 2070-2A or approved MODEL 2070-2E, Field I/O Module (FI/O)
 - Note: Configure the Field I/O Module to disable both the External WDT Shunt/Toggle Switch and SP3 (SP3 active indicator is “off”)
- MODEL 2070-3B, Front Panel Module (FP), Display B (8x40)
- MODEL 2070-4, Power Supply Module, 10 AMP
- MODEL 2070-7A, Async Serial Com Module (9-pin RS-232)

Furnish one additional MODEL 2070-7A, Async Serial Com Module (9-pin RS-232) for all master controller locations.

For each master location and central control center, furnish a U.S. Robotics V.92 or approved equivalent auto-dial/auto-answer external modem to accomplish the interface to the Department-furnished microcomputers. Include all necessary hardware to ensure telecommunications.

ST-1

Project B-5136

Cabarrus County

Project Special Provisions Structure

Table of Contents

	Page #
Construction, Maintenance & Removal of Temporary Structure at Station 21+74.92 -L- (9-27-12)	----- ST-2
Placing Load on Structure Members (11-27-12)	----- ST-5
Steel Reinforced Elastomeric Bearings (11-27-12)	----- ST-5
Thermal Sprayed Coatings (Metallization) (9-30-11)	----- ST-5
Expansion Joint Seals (9-30-11)	----- ST-9
Falsework and Formwork (4-5-12)	----- ST-12
Submittal of Working Drawings (6-19-15)	----- ST-18
Crane Safety (8-15-05)	----- ST-25
Grout for Structures (9-30-11)	----- ST-25
Classic Concrete Bridge Rail (SPECIAL)	----- ST-27
Railroad Provisions	----- ST-28

7/29/2015

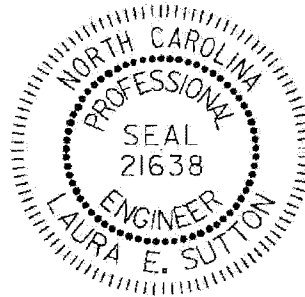

DocuSigned by:

Laura E. Sutton

excludes Railroad Provisions

AF35E3E6737640E

PROJECT SPECIAL PROVISIONS
STRUCTURE

PROJECT B-5136

CABARRUS COUNTY

CONSTRUCTION, MAINTENANCE AND REMOVAL
OF TEMPORARY STRUCTURE AT STATION 21+74.92 -L-

(9-27-12)

Construct, maintain and afterwards remove a temporary structure in accordance with the applicable parts of the Standard Specifications and this Special Provision (structure only; the approaches are not a part of this pay item). Provide a temporary structure with a minimum overall length of 167 feet. Center the length of the structure about Station 17+26.89 -DET- with the alignment, grade, and skew as indicated on the Roadway plans. If the skew is not 90°, then lengthening of the structure to accommodate a 90° skew is permitted. Provide a temporary structure with a minimum clear roadway width of 28 feet and a minimum underclearance of 22 feet, as required by the Railroad Provisions. Temporary structures over railroads shall maintain a minimum horizontal clearance of 25' from center of track to any temporary bent.

Design the temporary structure for HL-93 live load in accordance with the current edition of the AASHTO LRFD Bridge Design Specifications. The design of the temporary structure need not satisfy the Extreme Event I Load Combination of the AASHTO LRFD Bridge Design Specifications. Due to the expected issuance of overweight permits by the NCDOT for certain loads above legal limits, design the temporary structure to satisfy the requirements of AASHTO’s Manual for Bridge Evaluation for the following five vehicle configurations:

Truck #1			Truck #2			Truck #3		
Axle	P (k)	Distance (ft)	Axle	P (k)	Distance (ft)	Axle	P (k)	Distance (ft)
1	12.00	0.00	1	12.00	0.00	1	4.50	0.00
2	20.00	8.08	2	20.00	8.08	2	25.00	8.08
3	20.00	4.00	3	20.00	4.00	3	25.00	4.00
4	20.00	4.00	4	20.00	4.00	4	20.00	18.00
5	16.67	20.00	5	18.00	18.00	5	20.00	4.00
6	16.67	4.00	6	18.00	4.00			
7	16.66	4.00						

ST-3

B-5136

Cabarrus County

Truck #4			Truck #5		
Axle	P (k)	Distance (ft)	Axle	P (k)	Distance (ft)
1	12.00	0.00	1	14.00	0.00
2	20.00	15.00	2	25.00	15.00
3	20.00	4.00	3	25.00	4.00
4	20.00	4.00	4	17.00	20.00
5	20.00	20.00	5	17.00	4.00
6	20.00	4.00	6	17.00	4.00
7	20.00	4.00	7	17.00	4.00

As a minimum, design the bridge rails for the AASHTO LRFD Test Level 2 (TL-2) crash test criteria, except when the plans state that a Test Level 3 (TL-3) bridge rail is required. The bridge rail design criteria are defined in the current edition of the AASHTO LRFD Bridge Design Specifications. In addition, design structural elements to which the bridge rail is attached, or elements which may receive loads transmitted through the rail, to distribute and/or withstand these loads.

Attach the bridge rails in a way that permits the bridge approach railing system to transition from the guardrail system and attach to the rigid railing system on the temporary bridge.

Submit detailed sketches of the joint assembly for review and approval. The sketches shall provide an installation procedure and dimensions depicting adequate access to install welded or bolted connections. The maximum joint opening shall be limited to 3 inches.

Using timber floors or timber mat floors is not permitted due to anticipated high truck traffic. If timber piles are used, use piles that are new and conform to ASTM D25. Rough-peeled or clean-peeled untreated timber piles are permitted.

All wood and timber products shall be inspected in accordance with Article 1082-1 of the Standard Specifications. The use of ungraded timber and lumber is not permitted. Use material conforming to grading rules of SPIB, NELMA or other nationally recognized specification.

Submit design calculations to the Engineer for review and approval that, as a minimum, include stress calculations for the following structural components: railings, rail post, rail post connections, flooring, main girders or floor beam system, bent cap, pile bearing, pile as a structural member and longitudinal and lateral stability of pile bents if necessary. Indicate the condition of any used materials in the design calculations. Detailed drawings and design calculations of the structural components shall be signed and sealed by a North Carolina Registered Professional Engineer. For stream crossings, determine the pile stability assuming a scour depth equal to 250% of the pile diameter or width below the existing bed elevation. The Engineer may require a more detailed analysis of scour depth for pile bents containing more than a single row of piles.

ST-4

B-5136

Cabarrus County

Include material specifications for all new and used materials, including commercial grades and species of timber and lumber, in the detail drawings of the structure. In addition, show the location and a detailed sketch of the used materials indicating condition of the material, the location and geometry of existing but unused holes, attachments left over from previous use and any other irregularities in the material.

New and used material for temporary structures constructed by the Contractor, including systems intended for multiple usages, shall be inspected and approved prior to assembly.

Fabricators of temporary structures utilizing modular panels shall be AISC certified or equivalent. Submit proof of certification in accordance with Section 1072 of the Standard Specifications.

All critical bolted connections in the temporary structure require new high strength bolts. Indicate the location of the critical connections and recommended bolt size with tightening procedures in the detail drawings of the structure. The use of used high strength bolts is limited to non-critical connections and is subject to approval. For new high strength bolts, furnish the Engineer a copy of the manufacturer's test report for each component. Have the report indicate the testing date, the location where the components were manufactured, the lot number of the material represented, the rotational capacity tests lot number and the source identification marking used by the manufacturer of each component.

Before the temporary structure is loaded, the contractor shall inspect the structure and submit a written statement certifying that the erected structure complies with the approved detailed drawings. Temporary structures utilizing modular panels shall be inspected and certified by a manufacturer's representative. Any condition that does not comply with the accepted drawings, or any other condition deemed unsatisfactory by the Engineer, is cause for rejection.

Once vehicular traffic is allowed on a structure utilizing modular panels, routine inspection by the manufacturer will be required. The first inspection of the structure will be one month after opening the structure to vehicular traffic. Subsequent inspections shall be performed every six months. However, when ADTT exceeds 2000 inspection of the temporary structure shall occur every three months. An inspection report provided by the Department must be completed by the manufacturer and submitted to the Engineer within 3 days of each inspection. Any items documented in the report indicating safety or stability issues with the structure must be reported immediately. All safety and stability repairs will be performed promptly by the Contractor and approved by the Engineer.

The lump sum price bid for "Construction, Maintenance and Removal of Temporary Structure at Station 21+74.92 -L-" will be full compensation for the above work including all materials, equipment, tools, labor and incidentals necessary to complete and monitor the work.

PLACING LOAD ON STRUCTURE MEMBERS**(11-27-12)**

The 2012 Standard Specifications shall be revised as follows:

In **Section 420-20 – Placing Load on Structure Members** replace the first sentence of the fifth paragraph with the following:

Do not place vehicles or construction equipment on a bridge deck until the deck concrete develops the minimum specified 28 day compressive strength and attains an age of at least 7 curing days.

STEEL REINFORCED ELASTOMERIC BEARINGS**(11-27-12)**

The 2012 Standard Specifications shall be revised as follows:

In **Section 1079-1 – Preformed Bearing Pads** add the following after the second paragraph:

Internal holding pins are required for all shim plates when the contract plans indicate the structure contains the necessary corrosion protection for a corrosive site.

Repair laminated (reinforced) bearing pads utilizing external holding pins via vulcanization. Submit product data for repair material and a detailed application procedure to the Materials and Tests Unit for approval before use and annually thereafter.

THERMAL SPRAYED COATINGS (METALLIZATION)**(9-30-11)****1.0 DESCRIPTION**

Apply a thermal sprayed coating (TSC) and sealer to metal surfaces as specified herein when called for on the plans or by other Special Provisions, or when otherwise approved by the Engineer in accordance with the SSPC-CS 23.00/AWS C2.23/NACE No. 12 Specification. Only Arc Sprayed application methods are used to apply TSC coatings, the Engineer must approve other methods of application.

2.0 QUALIFICATIONS

Only use NCDOT approved TSC Contractors meeting the following requirements:

1. The capability of blast cleaning steel surfaces to SSPC SP-5 and SP-10 Finishes.
2. Employ Spray Operator(s) qualified in accordance with AWS C.16/C2.16M2002 and Quality Control Inspector(s) who have documented training in the applicable test procedures of ASTM D-3276 and SSPC-CS 23.00.

A summary of the contractor's related work experience and the documents verifying each Spray Operator's and Quality Control Inspector's qualifications are submitted to the Engineer before any work is performed.

3.0 MATERIALS

Provide wire in accordance with the metallizing equipment manufacturer’s recommendations. Use the wire alloy specified on the plans which meets the requirements in Annex C of the SSPC-CS 23.00 Specification. Have the contractor provide a certified analysis (NCDOT Type 2 Certification) for each lot of wire material.

Apply an approved sealer to all metallized surfaces in accordance with Section 9 of SSPC-CS 23. The sealer must either meet SSPC Paint 27 or is an alternate approved by the Engineer.

4.0 SURFACE PREPARATION AND TSC APPLICATION

Grind flame cut edges to remove the carbonized surface prior to blasting. Bevel all flame cut edges in accordance with Article 442-10(D) regardless of included angle. Blast clean surfaces to be metallized with grit or mineral abrasive in accordance with Steel Structures Painting Council SSPC SP-5/10(as specified) to impart an angular surface profile of 2.5 - 4.0 mils. Surface preparation hold times are in accordance with Section 7.32 of SSPC-CS 23. If flash rusting occurs prior to metallizing, blast clean the metal surface again. Apply the thermal sprayed coating only when the surface temperature of the steel is at least 5°F above the dew point.

At the beginning of each work period or shift, conduct bend tests in accordance with Section 6.5 of SSPC-CS 23.00. Any disbonding or delamination of the coating that exposes the substrate requires corrective action, additional testing, and the Engineer’s approval before resuming the metallizing process.

Apply TSC with the alloy to the thickness specified on the plans or as provided in the table below. All spot results (the average of 3 to 5 readings) must meet the minimum requirement. No additional tolerance (as allowed by SSPC PA-2) is permitted. (For Steel Beams: For pieces with less than 200 ft² measure 2 spots/surface per piece and for pieces greater than 200 ft² add 1 additional spots/surface for each 500 ft²).

Application	Thickness	Alloy	Seal Coat
Pot Bearings	8 mil	85/15 Zinc (W-Zn-Al-2)	0.5 mil
Armored Joint Angles	8 mil	85/15 Zinc (W-Zn-Al-2)	0.5 mil
Modular Joints	8 mil	99.99% Zn (W-Zn-1)	0.5 mil
Expansion Joint Seals	8 mil	99.99% Zn (W-Zn-1)	0.5 mil
Optional Disc Bearings	8 mil	85/15 Zinc (W-Zn-Al-2)	0.5 mil

When noted on the plans or as specified in the above chart, apply the sealer to all metallized surfaces in accordance with the manufacturer’s recommendations and these provisions. Apply the seal coat only when the air temperature is above 40°F and the surface temperature of the steel is at least 5°F above the dew point. If the sealer is not

applied within eight hours after the final application of TSC, the applicator verifies acceptable TSC surfaces and obtains approval from the Engineer before applying the sealer.

5.0 INSPECTION FREQUENCY

The TSC Contractor must conduct the following tests at the specified frequency and the results documented in a format approved by the Engineer.

Test/Standard	Location	Frequency	Specification
Ambient Conditions	Site	Each Process	5°F above the dew point
Abrasive Properties	Site	Each Day	Size, angularity, cleanliness
Surface Cleanliness SSPC Vis 1	All Surfaces	Visual All Surfaces	SSPC-SP-10 Atmospheric Service SSPC-SP - 5 Immersion Service
Surface Profile ASTM D-4417 Method C	Random Surfaces	3 per 500 ft ²	2.5 - 4.0 mils
Bend Test SSPC-CS 23.00	Site	5 per shift	Pass Visual
Thickness SSPC PA-2R SSPC-CS 23.00	Each Surface	Use the method in PA-2 Appendix 3 for Girders and Appendix 4 for frames and miscellaneous steel. See Note 1.	Zn - 8 mils minimum Al - 8 mils minimum Zn Al - 8 mils minimum Areas with more than twice the minimum thickness are inspected for compliance to the adhesion and cut testing requirements of this specification.
Adhesion ASTM 4541	Random Surfaces Splice Areas	1 set of 3 per 500 ft ²	Zn > 500 psi Al > 1000 psi Zn Al > 750 psi
Cut Test - SSPC-CS 23.00	Random Surfaces	3 sets of 3 per 500 ft ²	No peeling or delamination
Job Reference Std. SSPC-CS 23.00	Site	1 per job	Meets all the above requirements

6.0 REPAIRS

All Repairs are to be performed in accordance with the procedures below, depending on whether the repair surface is hidden or exposed. As an exception to the following, field welded splices on joint angles and field welding bearing plates to girders may be repaired in accordance with the procedures for hidden surfaces.

For hidden surfaces (including but not limited to interior girders, interior faces of exterior girders, and below-grade sections of piles):

1. Welding of metallized surfaces may be performed only if specifically permitted by the Engineer. Remove metallizing at the location of field welds by blast cleaning (SSPC SP-6 finish), or hand (SSPC SP-2 finish) or power tool cleaning (SSPC SP-3 finish) just prior to welding. Clean sufficiently to prevent contamination of the weld. All repairs to welded connections are metallized in accordance with SSPC CS 23.00.
2. Minor areas less than or equal to 0.1 ft² exposing the substrate are metallized in accordance with SSPC CS 23.00 or painted in accordance with ASTM A780, "Repair of Damaged and Uncoated Areas of Hot Dip Galvanized Coatings."
3. Large areas greater than 0.1 ft² exposing the substrate are metallized in accordance with SSPC CS 23.00.
4. Damaged (burnished) areas not exposing the substrate with less than the specified coating thickness are metallized in accordance with SSPC CS 23.00 or painted in accordance with ASTM A780, "Repair of Damaged and Uncoated Areas of Hot Dip Galvanized Coatings."
5. Damaged (burnished) areas not exposing the substrate with more than the specified coating thickness are not repaired.
6. Defective coating is repaired by either method 2 or 3 depending on the area of the defect.

For Exposed Surfaces (including but not limited to exterior faces of exterior girders and above-grade sections of piles):

1. Welding of metallized surfaces may be performed only if specifically permitted by the Engineer. Remove metallization at the location of field welds by blast cleaning (SSPC SP-6 finish), or hand (SSPC SP-2 finish) or power tool cleaning (SSPC SP-3 finish) just prior to welding. Clean sufficiently to prevent contamination of the weld. All repairs to welded connections are metallized in accordance with SSPC CS 23.00.
2. All areas exposing the substrate are metallized in accordance with SSPC CS 23.00
3. Defective coating is repaired by either method 2 or 3 depending on the area of the defect.

7.0 TWELVE MONTH OBSERVATION PERIOD

The contractor maintains responsibility for the coating system for a twelve (12) month observation period beginning upon the satisfactory completion of all the work required in the plans or as directed by the engineer. The contractor must guarantee the coating system under the payment and performance bond (refer to Article 109-10). To successfully

complete the observation period, the coating system must meet the following requirements after twelve (12) months service:

- No visible rust, contamination or application defect is observed in any coated area.
- Painted surfaces have a uniform color and gloss.
- Surfaces have an adhesion of no less than 500 psi when tested in accordance with ASTM D-4541.

8.0 BASIS OF PAYMENT

The contract price bid for the bridge component to which the coating is applied will be full compensation for the thermal sprayed coating.

EXPANSION JOINT SEALS

(9-30-11)

1.0 GENERAL

The work covered by this Special Provision consists of furnishing and installing the expansion joint seals as shown on the contract drawings. All materials, labor, equipment and incidentals necessary for the proper installation of the expansion joint seals are included.

2.0 MATERIAL

Provide expansion joint seals capable of accommodating a total movement measured parallel to the centerline of the roadway as shown on plans.

Provide an elastomeric component for each expansion joint seal that is a continuous unit for the entire length of the joint. Do not field splice the elastomeric component. Only vulcanized shop splicing of the elastomeric component is permitted. The minimum length of an elastomeric component before shop splicing is 20 feet. However, one piece shorter than 20 feet is permitted. Provide an elastomeric component that is clearly shop marked to indicate the top side and joint location of the elastomeric component. On skewed bridges, or under unsymmetrical conditions, clearly mark the left side of the elastomeric component. Left is defined as being on the left when facing in the direction of increasing station. Inspect the seals upon receipt to ensure that the marks are clearly visible upon installation.

Make sure the convolution of the gland does not project above the top of the hold-down plates when the joint opening is in the most compressed condition. Use either elastic polychloroprene (neoprene) or ethyl propylene diene monomer (EPDM) for the elastomer that meets the following minimum properties:

	ASTM TEST METHOD	REQUIREMENTS
Hardness, Durometer - Shore A	D2240	60 ± 5, Neoprene (upward corrugated shape - fabric reinforced) 75 ± 5, EPDM and Neoprene (upward non-corrugated shape) 80 ± 5, EPDM (upward corrugated shape-fabric reinforced)
Tensile Strength	D412	2000 psi (min.)
Elongation at Break	D412	250% (min.)
Width of Gland in Relaxed Condition	N/A	10" ± 0.25"
Thickness of Upturned portion of gland	N/A	0.25" non-corrugated shape, -0.032" to +0.032"
Thickness of Upturned portion of gland	N/A	0.1875" corrugated shape, -0.032" to +0.032"
Thickness of Flat portion of gland	N/A	0.1563", -0.032" to +0.032"

For fabric reinforced glands, submit one unreinforced sample per lot number, up to 500 feet of Expansion Joint Seal, to the Engineer for testing.

Only field splice hold-down plates at crown points, at abrupt changes in the deck slab cross slope, and on lane lines. Splicing within travel lanes is not permitted and splicing on edge lines is not required. Field splice hold-down plates between the edge line and gutter upturn and where necessary for proper installation and alignment is permitted. Show all splice locations on the working drawings for approval. For the location of lane markings at the expansion joint seal, see the Structure plans. At the splice locations, locate the hold-down bolts 3 inches from the end of the hold-down plate. At splice locations where changes in deck slab cross slope occur, cut the ends of hold-down plates parallel to the bridge centerline for skews less than 80° and greater than 100°.

Do not use welded shop splices in hold-down plates.

3.0 SHOP DRAWINGS

Submit nine sets of working drawings to the Engineer for review, comments and acceptance. Show complete details drawn to scale and include:

- The proposed template details including the makeup of the template
- The proposed method of holding the base angle assembly in place while concrete is cast around it

- The proposed procedure to correct for the effects of beam movement and rotation when setting width of joint opening
- The proposed chronology of installation including the sequence and direction of the concrete casting
- The details of cross connectors between base angles, such as steel bars with slots bolted to angles, to maintain evenness between the adjacent base angles while accommodating movement that occurs when concrete is cast. Indicate when bolts are loosened to allow movement.
- The proposed method for removing the hold-down plate
- A section detail through the joint showing horizontal offset dimensions of the base angles from the centerline joint. This detail is required when the vertical face of the joint opening is not perpendicular to the roadway surface (e.g. when the roadway grade is significant).

Have someone other than the one who prepares the drawing check all detailed drawings and include the signatures of both the drafter and checker on each sheet of the drawings. The Engineer returns unchecked drawings to the Contractor. Provide all completed drawings well in advance of the scheduled installation time for the expansion joint seal.

4.0 INSTALLATION

Provide supports for the base angle assembly at a maximum spacing of 9 feet. Place supports near field splices of base angles to ensure that field splices are straight and even. Provide base angles with ½" diameter weep holes at 12 inch centers to allow bleeding of trapped air and/or water. Do not obstruct the weep holes with falsework. Make the bottom of the trough parallel to grade and the sides parallel to the sides of the expansion joint seal.

For damaged areas, depressions, spalls, cracks, or irregularities of curbs or decks adjacent to the expansion joint, submit a proposed method of repair and repair material specifications for approval.

If the Engineer deems any aspects of the expansion joint seals unacceptable, make necessary corrections.

5.0 INSPECTION

When concrete is cast, use a non-aluminum, 10 foot, true to line straight edge to check and grade the top of the slab on each side of the joint to ensure smooth transition between spans.

Watertight Integrity Test

- Upon completion of an expansion joint seal, perform a water test on the top surface to detect any leakage. Cover the roadway section of the joint from curb to curb, or barrier rail to barrier rail, with water, either ponded or flowing, not less than 1 inch above the roadway surface at all points. Block sidewalk sections and secure an

unnozzled water hose delivering approximately 1 gallon of water per minute to the inside face of the bridge railing, trained in a downward position about 6 inches above the sidewalks, such that there is continuous flow of water across the sidewalk and down the curb face of the joint.

- Maintain the ponding or flowing of water on the roadway and continuous flow across sidewalks and curbs for a period of 5 hours. At the conclusion of the test, the underside of the joint is closely examined for leakage. The expansion joint seal is considered watertight if no obvious wetness is visible on the Engineer's finger after touching a number of underdeck areas. Damp concrete that does not impart wetness to the finger is not a sign of leakage.
- If the joint system leaks, locate the place(s) of leakage and take any repair measures necessary to stop the leakage at no additional cost to the Department. Use repair measures recommended by the manufacturer and approved by the Engineer prior to beginning corrective work.
- If measures to eliminate leakage are taken, perform a subsequent water integrity test subject to the same conditions as the original test. Subsequent tests carry the same responsibility as the original test and are performed at no extra cost to the Department.

6.0 BASIS OF PAYMENT

Basis of payment for all expansion joint seals will be at the lump sum contract price for "Expansion Joint Seals" which price and payment will be full compensation for furnishing all material, including any steel accessory plates for sidewalks, medians and rails, labor, tools, and incidentals necessary for installing the expansion joint seal in place and including all materials, labor, tools and incidentals for performing the original watertight integrity test.

FALSEWORK AND FORMWORK

(4-5-12)

1.0 DESCRIPTION

Use this Special Provision as a guide to develop temporary works submittals required by the Standard Specifications or other provisions; no additional submittals are required herein. Such temporary works include, but are not limited to, falsework and formwork.

Falsework is any temporary construction used to support the permanent structure until it becomes self-supporting. Formwork is the temporary structure or mold used to retain plastic or fluid concrete in its designated shape until it hardens. Access scaffolding is a temporary structure that functions as a work platform that supports construction personnel, materials, and tools, but is not intended to support the structure. Scaffolding systems that are used to temporarily support permanent structures (as opposed to functioning as work platforms) are considered to be falsework under the definitions given. Shoring is a component of falsework such as horizontal, vertical, or inclined support members. Where the term "temporary works" is used, it includes all of the temporary facilities used in bridge construction that do not become part of the permanent structure.

Design and construct safe and adequate temporary works that will support all loads imposed and provide the necessary rigidity to achieve the lines and grades shown on the plans in the final structure.

2.0 MATERIALS

Select materials suitable for temporary works; however, select materials that also ensure the safety and quality required by the design assumptions. The Engineer has authority to reject material on the basis of its condition, inappropriate use, safety, or nonconformance with the plans. Clearly identify allowable loads or stresses for all materials or manufactured devices on the plans. Revise the plan and notify the Engineer if any change to materials or material strengths is required.

3.0 DESIGN REQUIREMENTS

A. Working Drawings

Provide working drawings for items as specified in the contract, or as required by the Engineer, with design calculations and supporting data in sufficient detail to permit a structural and safety review of the proposed design of the temporary work.

On the drawings, show all information necessary to allow the design of any component to be checked independently as determined by the Engineer.

When concrete placement is involved, include data such as the drawings of proposed sequence, rate of placement, direction of placement, and location of all construction joints. Submit the number of copies as called for by the contract.

When required, have the drawings and calculations prepared under the guidance of, and sealed by, a North Carolina Registered Professional Engineer who is knowledgeable in temporary works design.

If requested by the Engineer, submit with the working drawings manufacturer's catalog data listing the weight of all construction equipment that will be supported on the temporary work. Show anticipated total settlements and/or deflections of falsework and forms on the working drawings. Include falsework footing settlements, joint take-up, and deflection of beams or girders.

As an option for the Contractor, overhang falsework hangers may be uniformly spaced, at a maximum of 36 inches, provided the following conditions are met:

ST-14

B-5136

Cabarrus County

Member Type (PCG)	Member Depth, (inches)	Max. Overhang Width, (inches)	Max. Slab Edge Thickness, (inches)	Max. Screenshot Wheel Weight, (lbs.)	Bracket Min. Vertical Leg Extension, (inches)
II	36	39	14	2000	26
III	45	42	14	2000	35
IV	54	45	14	2000	44
MBT	63	51	12	2000	50
MBT	72	55	12	1700	48

Overhang width is measured from the centerline of the girder to the edge of the deck slab.

For Type II, III & IV prestressed concrete girders (PCG), 45-degree cast-in-place half hangers and rods must have a minimum safe working load of 6,000 lbs.

For MBT prestressed concrete girders, 45-degree angle holes for falsework hanger rods shall be cast through the girder top flange and located, measuring along the top of the member, 1'-2½" from the edge of the top flange. Hanger hardware and rods must have a minimum safe working load of 6,000 lbs.

The overhang bracket provided for the diagonal leg shall have a minimum safe working load of 3,750 lbs. The vertical leg of the bracket shall extend to the point that the heel bears on the girder bottom flange, no closer than 4 inches from the bottom of the member. However, for 72-inch members, the heel of the bracket shall bear on the web, near the bottom flange transition.

Provide adequate overhang falsework and determine the appropriate adjustments for deck geometry, equipment, casting procedures and casting conditions.

If the optional overhang falsework spacing is used, indicate this on the falsework submittal and advise the girder producer of the proposed details. Failure to notify the Engineer of hanger type and hanger spacing on prestressed concrete girder casting drawings may delay the approval of those drawings.

Falsework hangers that support concentrated loads and are installed at the edge of thin top flange concrete girders (such as bulb tee girders) shall be spaced so as not to exceed 75% of the manufacturer's stated safe working load. Use of dual leg hangers (such as Meadow Burke HF-42 and HF-43) are not allowed on concrete girders with thin top flanges. Design the falsework and forms supporting deck slabs and overhangs on girder bridges so that there will be no differential settlement between the girders and the deck forms during placement of deck concrete.

When staged construction of the bridge deck is required, detail falsework and forms for screed and fluid concrete loads to be independent of any previous deck pour components when the mid-span girder deflection due to deck weight is greater than ¾".

Note on the working drawings any anchorages, connectors, inserts, steel sleeves or other such devices used as part of the falsework or formwork that remains in the permanent structure. If the plan notes indicate that the structure contains the necessary corrosion protection required for a Corrosive Site, epoxy coat, galvanize or metalize these devices. Electroplating will not be allowed. Any coating required by the Engineer will be considered incidental to the various pay items requiring temporary works.

Design falsework and formwork requiring submittals in accordance with the 1995 AASHTO *Guide Design Specifications for Bridge Temporary Works* except as noted herein.

1. Wind Loads

Table 2.2 of Article 2.2.5.1 is modified to include wind velocities up to 110 mph. In addition, Table 2.2A is included to provide the maximum wind speeds by county in North Carolina.

Table 2.2 - Wind Pressure Values

Height Zone feet above ground	Pressure, lb/ft ² for Indicated Wind Velocity, mph				
	70	80	90	100	110
0 to 30	15	20	25	30	35
30 to 50	20	25	30	35	40
50 to 100	25	30	35	40	45
over 100	30	35	40	45	50

2. Time of Removal

The following requirements replace those of Article 3.4.8.2.

Do not remove forms until the concrete has attained strengths required in Article 420-16 of the Standard Specifications and these Special Provisions.

Do not remove forms until the concrete has sufficient strength to prevent damage to the surface.

Table 2.2A - Steady State Maximum Wind Speeds by Counties in North Carolina

COUNTY	25 YR (mph)	COUNTY	25 YR (mph)	COUNTY	25 YR (mph)
Alamance	70	Franklin	70	Pamlico	100
Alexander	70	Gaston	70	Pasquotank	100
Alleghany	70	Gates	90	Pender	100
Anson	70	Graham	80	Perquimans	100
Ashe	70	Granville	70	Person	70
Avery	70	Greene	80	Pitt	90
Beaufort	100	Guilford	70	Polk	80
Bertie	90	Halifax	80	Randolph	70
Bladen	90	Harnett	70	Richmond	70
Brunswick	100	Haywood	80	Robeson	80
Buncombe	80	Henderson	80	Rockingham	70
Burke	70	Hertford	90	Rowan	70
Cabarrus	70	Hoke	70	Rutherford	70
Caldwell	70	Hyde	110	Sampson	90
Camden	100	Iredell	70	Scotland	70
Carteret	110	Jackson	80	Stanley	70
Caswell	70	Johnston	80	Stokes	70
Catawba	70	Jones	100	Surry	70
Cherokee	80	Lee	70	Swain	80
Chatham	70	Lenoir	90	Transylvania	80
Chowan	90	Lincoln	70	Tyrell	100
Clay	80	Macon	80	Union	70
Cleveland	70	Madison	80	Vance	70
Columbus	90	Martin	90	Wake	70
Craven	100	McDowell	70	Warren	70
Cumberland	80	Mecklenburg	70	Washington	100
Currituck	100	Mitchell	70	Watauga	70
Dare	110	Montgomery	70	Wayne	80
Davidson	70	Moore	70	Wilkes	70
Davie	70	Nash	80	Wilson	80
Duplin	90	New Hanover	100	Yadkin	70
Durham	70	Northampton	80	Yancey	70
Edgecombe	80	Onslow	100		
Forsyth	70	Orange	70		

B. Review and Approval

The Engineer is responsible for the review and approval of temporary works' drawings.

Submit the working drawings sufficiently in advance of proposed use to allow for their review, revision (if needed), and approval without delay to the work.

The time period for review of the working drawings does not begin until complete drawings and design calculations, when required, are received by the Engineer.

Do not start construction of any temporary work for which working drawings are required until the drawings have been approved. Such approval does not relieve the Contractor of the responsibility for the accuracy and adequacy of the working drawings.

4.0 CONSTRUCTION REQUIREMENTS

All requirements of Section 420 of the Standard Specifications apply.

Construct temporary works in conformance with the approved working drawings. Ensure that the quality of materials and workmanship employed is consistent with that assumed in the design of the temporary works. Do not weld falsework members to any portion of the permanent structure unless approved. Show any welding to the permanent structure on the approved construction drawings.

Provide tell-tales attached to the forms and extending to the ground, or other means, for accurate measurement of falsework settlement. Make sure that the anticipated compressive settlement and/or deflection of falsework does not exceed 1 inch. For cast-in-place concrete structures, make sure that the calculated deflection of falsework flexural members does not exceed 1/240 of their span regardless of whether or not the deflection is compensated by camber strips.

A. Maintenance and Inspection

Inspect and maintain the temporary work in an acceptable condition throughout the period of its use. Certify that the manufactured devices have been maintained in a condition to allow them to safely carry their rated loads. Clearly mark each piece so that its capacity can be readily determined at the job site.

Perform an in-depth inspection of an applicable portion(s) of the temporary works, in the presence of the Engineer, not more than 24 hours prior to the beginning of each concrete placement. Inspect other temporary works at least once a month to ensure that they are functioning properly. Have a North Carolina Registered Professional Engineer inspect the cofferdams, shoring, sheathing, support of excavation structures, and support systems for load tests prior to loading.

B. Foundations

Determine the safe bearing capacity of the foundation material on which the supports for temporary works rest. If required by the Engineer, conduct load tests to verify proposed bearing capacity values that are marginal or in other high-risk situations.

The use of the foundation support values shown on the contract plans of the permanent structure is permitted if the foundations are on the same level and on the same soil as those of the permanent structure.

Allow for adequate site drainage or soil protection to prevent soil saturation and washout of the soil supporting the temporary works supports.

If piles are used, the estimation of capacities and later confirmation during construction using standard procedures based on the driving characteristics of the pile is permitted. If preferred, use load tests to confirm the estimated capacities; or, if required by the Engineer conduct load tests to verify bearing capacity values that are marginal or in other high risk situations.

The Engineer reviews and approves the proposed pile and soil bearing capacities.

5.0 REMOVAL

Unless otherwise permitted, remove and keep all temporary works upon completion of the work. Do not disturb or otherwise damage the finished work.

Remove temporary works in conformance with the contract documents. Remove them in such a manner as to permit the structure to uniformly and gradually take the stresses due to its own weight.

6.0 METHOD OF MEASUREMENT

Unless otherwise specified, temporary works will not be directly measured.

7.0 BASIS OF PAYMENT

Payment at the contract unit prices for the various pay items requiring temporary works will be full compensation for the above falsework and formwork.

SUBMITTAL OF WORKING DRAWINGS**(6-19-15)****1.0 GENERAL**

Submit working drawings in accordance with Article 105-2 of the *Standard Specifications* and this provision. For this provision, “submittals” refers to only those listed in this provision. The list of submittals contained herein does not represent a list of required submittals for the project. Submittals are only necessary for those items as required by the contract. Make submittals that are not specifically noted in this provision directly to the

Engineer. Either the Structures Management Unit or the Geotechnical Engineering Unit or both units will jointly review submittals.

If a submittal contains variations from plan details or specifications or significantly affects project cost, field construction or operations, discuss the submittal with and submit all copies to the Engineer. State the reason for the proposed variation in the submittal. To minimize review time, make sure all submittals are complete when initially submitted. Provide a contact name and information with each submittal. Direct any questions regarding submittal requirements to the Engineer, Structures Management Unit contacts or the Geotechnical Engineering Unit contacts noted below.

In order to facilitate in-plant inspection by NCDOT and approval of working drawings, provide the name, address and telephone number of the facility where fabrication will actually be done if different than shown on the title block of the submitted working drawings. This includes, but is not limited to, precast concrete items, prestressed concrete items and fabricated steel or aluminum items.

2.0 ADDRESSES AND CONTACTS

For submittals to the Structures Management Unit, use the following addresses:

Via US mail:

Mr. T. K. Koch, P. E.
State Structures Engineer
North Carolina Department of
Transportation
Structures Management Unit
1581 Mail Service Center
Raleigh, NC 27699-1581

Via other delivery service:

Mr. T. K. Koch, P. E.
State Structures Engineer
North Carolina Department of
Transportation
Structures Management Unit
1000 Birch Ridge Drive
Raleigh, NC 27610

Attention: Mr. P. D. Lambert, P. E.

Attention: Mr. P. D. Lambert, P. E.

Submittals may also be made via email. Send submittals to:

plambert@ncdot.gov

(Paul Lambert)

Send an additional e-copy of the submittal to the following addresses:

jgaither@ncdot.gov

(James Gaither)

mrorie@ncdot.gov

(Madonna Rorie)

For submittals to the Geotechnical Engineering Unit, use the following addresses:

For projects in Divisions 1-7, use the following Eastern Regional Office address:

Via US mail:

Mr. K. J. Kim, Ph. D., P. E.
Eastern Regional Geotechnical
Manager
North Carolina Department of
Transportation
Geotechnical Engineering Unit -
Eastern Regional Office
1570 Mail Service Center
Raleigh, NC 27699-1570

Via other delivery service:

Mr. K. J. Kim, Ph. D., P. E.
Eastern Regional Geotechnical
Manager
North Carolina Department of
Transportation
Geotechnical Engineering Unit -
Eastern Regional Office
3301 Jones Sausage Road, Suite 100
Garner, NC 27529

For projects in Divisions 8-14, use the following Western Regional Office address:

Via US mail:

Mr. Eric Williams, P. E.
Western Regional Geotechnical
Manager
North Carolina Department of
Transportation
Geotechnical Engineering Unit -
Western Regional Office
5253 Z Max Boulevard
Harrisburg, NC 28075

Via other delivery service:

Mr. Eric Williams, P. E.
Western Regional Geotechnical
Manager
North Carolina Department of
Transportation
Geotechnical Engineering Unit -
Western Regional Office
5253 Z Max Boulevard
Harrisburg, NC 28075

The status of the review of structure-related submittals sent to the Structures Management Unit can be viewed from the Unit's web site, via the "Drawing Submittal Status" link.

Direct any questions concerning submittal review status, review comments or drawing markups to the following contacts:

Primary Structures Contact:

Paul Lambert (919) 707-6407
(919) 250-4082 facsimile

Secondary Structures Contacts:

James Gaither (919) 707-6409
Madonna Rorie (919) 707-6508

Eastern Regional Geotechnical Contact (Divisions 1-7):

K. J. Kim (919) 662-4710
(919) 662-3095 facsimile
kkim@ncdot.gov

Western Regional Geotechnical Contact (Divisions 8-14):

Eric Williams (704) 455-8902
 (704) 455-8912 facsimile
ewilliams3@ncdot.gov

3.0 SUBMITTAL COPIES

Furnish one complete copy of each submittal, including all attachments, to the Engineer. At the same time, submit the number of hard copies shown below of the same complete submittal directly to the Structures Management Unit and/or the Geotechnical Engineering Unit.

The first table below covers “Structure Submittals”. The Engineer will receive review comments and drawing markups for these submittals from the Structures Management Unit. The second table in this section covers “Geotechnical Submittals”. The Engineer will receive review comments and drawing markups for these submittals from the Geotechnical Engineering Unit.

Unless otherwise required, submit one set of supporting calculations to either the Structures Management Unit or the Geotechnical Engineering Unit unless both units require submittal copies in which case submit a set of supporting calculations to each unit. Provide additional copies of any submittal as directed.

STRUCTURE SUBMITTALS

Submittal	Copies Required by Structures Management Unit	Copies Required by Geotechnical Engineering Unit	Contract Reference Requiring Submittal ¹
Arch Culvert Falsework	5	0	Plan Note, SN Sheet & “Falsework and Formwork”
Box Culvert Falsework ⁷	5	0	Plan Note, SN Sheet & “Falsework and Formwork”
Cofferdams	6	2	Article 410-4
Foam Joint Seals ⁶	9	0	“Foam Joint Seals”
Expansion Joint Seals (hold down plate type with base angle)	9	0	“Expansion Joint Seals”
Expansion Joint Seals (modular)	2, then 9	0	“Modular Expansion Joint Seals”

STRUCTURE SUBMITTALS

Submittal	Copies Required by Structures Management Unit	Copies Required by Geotechnical Engineering Unit	Contract Reference Requiring Submittal ¹
Expansion Joint Seals (strip seals)	9	0	“Strip Seals”
Falsework & Forms ² (substructure)	8	0	Article 420-3 & “Falsework and Formwork”
Falsework & Forms (superstructure)	8	0	Article 420-3 & “Falsework and Formwork”
Girder Erection over Railroad	5	0	Railroad Provisions
Maintenance and Protection of Traffic Beneath Proposed Structure	8	0	“Maintenance and Protection of Traffic Beneath Proposed Structure at Station ____”
Metal Bridge Railing	8	0	Plan Note
Metal Stay-in-Place Forms	8	0	Article 420-3
Metalwork for Elastomeric Bearings ^{4,5}	7	0	Article 1072-8
Miscellaneous Metalwork ^{4,5}	7	0	Article 1072-8
Disc Bearings ⁴	8	0	“Disc Bearings”
Overhead and Digital Message Signs (DMS) (metalwork and foundations)	13	0	Applicable Provisions
Placement of Equipment on Structures (cranes, etc.)	7	0	Article 420-20
Precast Concrete Box Culverts	2, then 1 reproducible	0	“Optional Precast Reinforced Concrete Box Culvert at Station ____”
Prestressed Concrete Cored Slab (detensioning sequences) ³	6	0	Article 1078-11
Prestressed Concrete Deck Panels	6 and 1 reproducible	0	Article 420-3

STRUCTURE SUBMITTALS

Submittal	Copies Required by Structures Management Unit	Copies Required by Geotechnical Engineering Unit	Contract Reference Requiring Submittal ¹
Prestressed Concrete Girder (strand elongation and detensioning sequences)	6	0	Articles 1078-8 and 1078-11
Removal of Existing Structure over Railroad	5	0	Railroad Provisions
Revised Bridge Deck Plans (adaptation to prestressed deck panels)	2, then 1 reproducible	0	Article 420-3
Revised Bridge Deck Plans (adaptation to modular expansion joint seals)	2, then 1 reproducible	0	“Modular Expansion Joint Seals”
Sound Barrier Wall (precast items)	10	0	Article 1077-2 & “Sound Barrier Wall”
Sound Barrier Wall Steel Fabrication Plans ⁵	7	0	Article 1072-8 & “Sound Barrier Wall”
Structural Steel ⁴	2, then 7	0	Article 1072-8
Temporary Detour Structures	10	2	Article 400-3 & “Construction, Maintenance and Removal of Temporary Structure at Station _____”
TFE Expansion Bearings ⁴	8	0	Article 1072-8

FOOTNOTES

- References are provided to help locate the part of the contract where the submittals are required. References in quotes refer to the provision by that name. Articles refer to the *Standard Specifications*.
- Submittals for these items are necessary only when required by a note on plans.
- Submittals for these items may not be required. A list of pre-approved sequences is available from the producer or the Materials & Tests Unit.
- The fabricator may submit these items directly to the Structures Management Unit.

5. The two sets of preliminary submittals required by Article 1072-8 of the *Standard Specifications* are not required for these items.
6. Submittals for Fabrication Drawings are not required. Submittals for Catalogue Cuts of Proposed Material are required. See Section 5.A of the referenced provision.
7. Submittals are necessary only when the top slab thickness is 18" or greater.

GEOTECHNICAL SUBMITTALS

Submittal	Copies Required by Geotechnical Engineering Unit	Copies Required by Structures Management Unit	Contract Reference Requiring Submittal ¹
Drilled Pier Construction Plans ²	1	0	Subarticle 411-3(A)
Crosshole Sonic Logging (CSL) Reports ²	1	0	Subarticle 411-5(A)(2)
Pile Driving Equipment Data Forms ^{2,3}	1	0	Subarticle 450-3(D)(2)
Pile Driving Analyzer (PDA) Reports ²	1	0	Subarticle 450-3(F)(3)
Retaining Walls ⁴	8 drawings, 2 calculations	2 drawings	Applicable Provisions
Temporary Shoring ⁴	5 drawings, 2 calculations	2 drawings	“Temporary Shoring” & “Temporary Soil Nail Walls”

FOOTNOTES

1. References are provided to help locate the part of the contract where the submittals are required. References in quotes refer to the provision by that name. Subarticles refer to the *Standard Specifications*.
2. Submit one hard copy of submittal to the Engineer. Submit a second copy of submittal electronically (PDF via email) or by facsimile, US mail or other delivery service to the appropriate Geotechnical Engineering Unit regional office. Electronic submission is preferred.
3. The Pile Driving Equipment Data Form is available from:
https://connect.ncdot.gov/resources/Geological/Pages/Geotech_Forms_Details.aspx
See second page of form for submittal instructions.
4. Electronic copy of submittal is required. See referenced provision.

CRANE SAFETY**(8-15-05)**

Comply with the manufacturer specifications and limitations applicable to the operation of any and all cranes and derricks. Prime contractors, sub-contractors, and fully operated rental companies shall comply with the current Occupational Safety and Health Administration regulations (OSHA).

Submit all items listed below to the Engineer prior to beginning crane operations involving critical lifts. A critical lift is defined as any lift that exceeds 75 percent of the manufacturer's crane chart capacity for the radius at which the load will be lifted or requires the use of more than one crane. Changes in personnel or equipment must be reported to the Engineer and all applicable items listed below must be updated and submitted prior to continuing with crane operations.

CRANE SAFETY SUBMITTAL LIST

- A. **Competent Person:** Provide the name and qualifications of the "Competent Person" responsible for crane safety and lifting operations. The named competent person will have the responsibility and authority to stop any work activity due to safety concerns.
- B. **Riggers:** Provide the qualifications and experience of the persons responsible for rigging operations. Qualifications and experience should include, but not be limited to, weight calculations, center of gravity determinations, selection and inspection of sling and rigging equipment, and safe rigging practices.
- C. **Crane Inspections:** Inspection records for all cranes shall be current and readily accessible for review upon request.
- D. **Certifications:** **By July 1, 2006**, crane operators performing critical lifts shall be certified by NC CCO (National Commission for the Certification of Crane Operators), or satisfactorily complete the Carolinas AGC's Professional Crane Operator's Proficiency Program. Other approved nationally accredited programs will be considered upon request. All crane operators shall also have a current CDL medical card. Submit a list of anticipated critical lifts and corresponding crane operator(s). Include current certification for the type of crane operated (small hydraulic, large hydraulic, small lattice, large lattice) and medical evaluations for each operator.

GROUT FOR STRUCTURES**(9-30-11)****1.0 DESCRIPTION**

This special provision addresses grout for use in pile blockouts, grout pockets, shear keys, dowel holes and recesses for structures. This provision does not apply to grout placed in post-tensioning ducts for bridge beams, girders, or decks. Mix and place grout in accordance with the manufacturer's recommendations, the applicable sections of the Standard Specifications and this provision.

2.0 MATERIAL REQUIREMENTS

Use a Department approved pre-packaged, non-shrink, non-metallic grout. Contact the Materials and Tests Unit for a list of approved pre-packaged grouts and consult the manufacturer to determine if the pre-packaged grout selected is suitable for the required application.

When using an approved pre-packaged grout, a grout mix design submittal is not required.

The grout shall be free of soluble chlorides and contain less than one percent soluble sulfate. Supply water in compliance with Article 1024-4 of the Standard Specifications.

Aggregate may be added to the mix only where recommended or permitted by the manufacturer and Engineer. The quantity and gradation of the aggregate shall be in accordance with the manufacturer's recommendations.

Admixtures, if approved by the Department, shall be used in accordance with the manufacturer's recommendations. The manufacture date shall be clearly stamped on each container. Admixtures with an expired shelf life shall not be used.

The Engineer reserves the right to reject material based on unsatisfactory performance.

Initial setting time shall not be less than 10 minutes when tested in accordance with ASTM C266.

Test the expansion and shrinkage of the grout in accordance with ASTM C1090. The grout shall expand no more than 0.2% and shall exhibit no shrinkage. Furnish a Type 4 material certification showing results of tests conducted to determine the properties listed in the Standard Specifications and to assure the material is non-shrink.

Unless required elsewhere in the contract the compressive strength at 3 days shall be at least 5000 psi. Compressive strength in the laboratory shall be determined in accordance with ASTM C109 except the test mix shall contain only water and the dry manufactured material. Compressive strength in the field will be determined by molding and testing 4" x 8" cylinders in accordance with AASHTO T22. Construction loading and traffic loading shall not be allowed until the 3 day compressive strength is achieved.

When tested in accordance with ASTM C666, Procedure A, the durability factor of the grout shall not be less than 80.

3.0 SAMPLING AND PLACEMENT

Place and maintain components in final position until grout placement is complete and accepted. Concrete surfaces to receive grout shall be free of defective concrete, laitance, oil, grease and other foreign matter. Saturate concrete surfaces with clean water and remove excess water prior to placing grout.

Do not place grout if the grout temperature is less than 50°F or more than 90°F or if the air temperature measured at the location of the grouting operation in the shade away from artificial heat is below 45°F.

Provide grout at a rate that permits proper handling, placing and finishing in accordance with the manufacturer's recommendations unless directed otherwise by the Engineer. Use grout free of any lumps and undispersed cement. Agitate grout continuously before placement.

Control grout delivery so the interval between placing batches in the same component does not exceed 20 minutes.

The Engineer will determine the locations to sample grout and the number and type of samples collected for field and laboratory testing. The compressive strength of the grout will be considered the average compressive strength test results of 3 cube or 2 cylinder specimens at 28 days.

4.0 BASIS OF PAYMENT

No separate payment will be made for "Grout for Structures". The cost of the material, equipment, labor, placement, and any incidentals necessary to complete the work shall be considered incidental to the structure item requiring grout.

CLASSIC CONCRETE BRIDGE RAIL

(SPECIAL)

1.0 GENERAL

The "Classic Concrete Bridge Rail" shall be in accordance with applicable parts of the Standard Specifications, the details shown on the plans and as outlined in this Special Provision. Plans for the bridge rails are detailed for cast in place concrete and must be placed using conventional forms.

2.0 CONCRETE MIX

Concrete for the bridge rail shall meet the requirements for Class AA Concrete with exception noted below:

The maximum size coarse aggregate used in the concrete mix shall be #78M. The slump shall be within the range of 5" to 8" when tested in accordance with AASHTO T119. A high range water reducer shall be used. The quantity of high range water reducer per pound of cement shall be within the range recommended on the current list of approved admixtures issued by the Materials & Tests Unit.

3.0 CONSTRUCTION

The bridge rails shall be placed to the established shape, line, grade and dimensions shown on the plans. Joints in the rails shall be constructed at the locations and of the type specified on the plans.

4.0 FINISHING

All exposed surfaces which are not satisfactory to the Engineer as to uniformity of color and texture or because of excessive patching shall be corrected as required by the Engineer. All surfaces of the bridge rails shall be given a Class I Surface Finish in accordance with the Standard Specifications unless directed otherwise by the Engineer.

5.0 MEASUREMENT

The quantity to be paid for under this item shall be the actual number of linear feet of "Classic Concrete Bridge Rail", complete in place and accepted, measured continuously along the top surface of completed rail from end to end without deductions for spaces between sections.

6.0 PAYMENT

The quantity, measured as described above, will be paid for at the contract unit price per linear foot bid for "Classic Concrete Bridge Rail", which price and payment shall be full compensation for all materials, admixtures, forms, falsework, curing, surface finish, tools, labor, equipment and incidentals necessary to complete the item.

SPECIAL PROVISIONS FOR PROTECTION OF RAILWAY INTEREST

Under the terms of these provisions, the North Carolina Department of Transportation shall hereinafter be called "Department", the North Carolina Railroad Company shall hereinafter be called "Company" and the Norfolk Southern Railway Company shall hereinafter be called "Railroad".

1. AUTHORITY OF RAILROAD ENGINEER AND DEPARTMENT ENGINEER:

The Railroad's Public Projects Engineer, hereinafter referred to as Railroad Engineer, shall have final authority in all matters affecting the safe maintenance of Railroad traffic including the adequacy of the foundations and structures supporting the Railroad tracks.

The authorized representative of the North Carolina Department of Transportation, hereinafter referred to as the Department Engineer, shall have authority over all other matters as prescribed herein including Project Specifications, Special Provisions, and the plans.

2. NOTICE OF STARTING WORK:

A. The Contractor shall not commence any work on Company's corridor until he has complied with the following conditions:

1. Sign and receive back from the Company a fully executed copy of the required Construction Right of Entry Agreement attached as an addendum.

2. Give the Company and Railroad written notice, with copy to the Department Engineer who is designated to be in charge of the work, at least ten (10) days in advance of the date he proposes to begin work on Company's corridor to:

Office of Chief Engineer - Bridges & Structures
Norfolk Southern Corporation
1200 Peachtree Street NE
Internal Box 142
Atlanta, Georgia 30309

Jim Kessler, P.E.
Vice President – Engineering
North Carolina Railroad Company
2809 Highwoods Boulevard, Suite 100
Raleigh, North Carolina 27604-1640

3. Obtain written approval from the Company and Railroad of Railroad Protective Liability Insurance coverage as required by section 14 herein. The Railroad does not accept notation of Railroad protective insurance on a certificate of liability insurance form or Binders as Railroad must have the full original countersigned policy. The policy will be reviewed for compliance prior to written approval. Due to the number of projects system-wide, it typically takes a minimum of 30-45 days for Railroad to review.
4. Obtain Railroad's Flagging Services as required by section 7 herein.
5. Obtain written authorization from the Railroad and Company to begin work on Company's corridor, such authorization to include an outline of specific conditions with which he must comply.
6. Furnish a schedule for all work within the Company's corridor as required by section 7B1 herein.

- B. The Railroad's and Company's written authorization to proceed with the work will include the names, addresses, and telephone numbers of the Railroad's and Company's representatives who are to be notified as hereinafter required. Where more than one representative is designated, the area of responsibility of each representative will be specified.

3. INTERFERENCE WITH RAILROAD OPERATIONS:

- A. The Contractor shall so arrange and conduct his work that there will be no interference with Railroad operations, including train, signal, telephone and telegraphic services, or damage to the property of the Company or Railroad or to poles, wires, and other facilities of tenants on the corridor of the Company. Whenever work is liable to affect the operations or safety of trains, the method of doing such work shall first be submitted to the Railroad Engineer for approval, but such approval shall not relieve the Contractor from liability. Any work to be performed by the Contractor which requires

flagging service or inspection service (watchman) shall be deferred by the Contractor until the flagging protection or inspection service required by the Railroad is available at the job site.

- B. Whenever work within Company's corridor is of such a nature that impediment to Railroad operations such as use of runaround tracks or necessity for reduced speed is unavoidable, the Contractor shall schedule and conduct his operations so that such impediment is reduced to the absolute minimum.
- C. Should conditions arising from, or in connection with the work, require that immediate and unusual provisions be made to protect operations and property of the Company and Railroad, the Contractor shall make such provisions. If in the judgment of the Railroad Engineer, or in his absence, the Railroad's Division Engineer, such provision is insufficient, either may require or provide such provisions as he deems necessary. In any event, such unusual provisions shall be at the Contractor's expense and without cost to the Department, Company, or Railroad.
- D. "One Call" Services do not locate buried Railroad utilities. The contractor shall contact the Railroad's representative 2 days in advance of work at those places where excavation, pile driving, or heavy loads may damage the Railroad's underground facilities. Upon request from the Contractor or Sponsor, Railroad forces will locate and paint mark or flag the Railroad's underground facilities. The Contractor shall avoid excavation or other disturbances of these facilities. If disturbance or excavation is required near a buried Railroad facility, the contractor shall coordinate with the Railroad to have the facility potholed manually with careful hand excavation. The facility shall be protected by the Contractor during the course of the disturbance under the supervision and direction of the Railroad's representative.

4. TEMPORARY TRACK CLEARANCES DURING CONSTRUCTION:

- A. The minimum track clearances to be maintained by the Contractor during construction are shown on the Plans. If temporary clearances are not shown on the plans, the following criteria shall govern the use of falsework and formwork above or adjacent to operated tracks.
 - 1. A minimum vertical clearance of 22'-0" above top of highest rail shall be maintained at all times.
 - 2. A minimum horizontal clearance of 13'-0" from centerline of tangent track or 14'-0" from centerline of curved track shall be maintained at all times. Additional horizontal clearance may be required in special cases to be safe for operating conditions. This additional clearance will be as determined by the Railroad Engineer.
 - 3. All proposed temporary clearances which are less than those listed above must be submitted to Railroad Engineer for approval prior to construction and must also be authorized by the regulatory body of the State if less than the legally prescribed clearances.

4. The temporary clearance requirements noted above shall also apply to all other physical obstructions including, but not limited to: stockpiled materials, parked equipment, placement or driving of piles, and bracing or other construction supports.
- B. However, before undertaking any work within Company's corridor, or before placing any obstruction over any track, the Contractor shall:
 1. Notify the Railroad Engineer at least 72 hours in advance of the work.
 2. Receive assurance from the Railroad Engineer that arrangements have been made for flagging service as may be necessary.
 3. Receive permission from the Railroad Engineer to proceed with the work.
 4. Ascertain that the Department Engineer has received copies of notice to the Railroad and of the Railroad's response thereto.
5. CONSTRUCTION PROCEDURES:
 - A. General:
 1. Construction work and operations by the Contractor on Company's corridor shall be:
 - a. Subject to the inspection and approval of the Railroad Engineer or their designated Construction Engineering Representative.
 - b. In accord with the Railroad's written outline of specific conditions.
 - c. In accord with the Railroad's general rules, regulations and requirements including those relating to safety, fall protection and personal protective equipment.
 - d. In accord with these Special Provisions.
 2. Submittal Requirements
 - a. The Contractor shall submit all construction related correspondence and submittals electronically to the Railroad Engineer with a copy to the Company's Engineer.
 - b. The Contractor shall allow for 30 days for the Company's and Railroad's review and response.
 - c. All work in the vicinity of the Company's corridor that has the potential to affect the Railroad's train operations or disturb the Company's property must be submitted and approved by the Railroad prior to work being performed.

- d. All submittals and calculations must be signed and sealed by a North Carolina registered Professional Engineer.
- e. All submittals shall first be approved by the Department Engineer prior to forwarding to the Company and Railroad. Approval of submittals by the Company Engineer and the Railroad Engineer shall not relieve the Contractor from liability.

B. Ballast Protection

1. The Contractor shall submit the proposed ballast protection system detailing the specific filter fabric and anchorage system to be used during all construction activities.
2. The ballast protection is to extend 25' beyond the proposed limit of work, be installed at the start of the project and be continuously maintained to prevent all contaminants from entering the ballast section of all tracks for the entire duration of the project.

C. Excavation:

The subgrade of an operated track shall be maintained with edge of berm at least 10'-0" from centerline of track and not more than 24 inches below top of rail. The Contractor will not be required to make existing section meet this specification if substandard, in which case existing section will be maintained.

Additionally, the Railroad Engineer may require the Contractor to install orange construction safety fencing for protection of the work area.

D. Excavation for Structures:

The Contractor will be required to take special precaution and care in connection with excavating and shoring pits, and in driving piles or sheeting, for footings adjacent to tracks to provide adequate lateral support for the tracks and the loads which they carry, without disturbance of track alignment and surface, and to avoid obstructing track clearances with working equipment, tools or other material. All plans and calculations for shoring shall be prepared and signed by a North Carolina Registered Professional Engineer. The Professional Engineer will be responsible for the accuracy for all controlling dimensions as well as the selection of soil design values which will accurately reflect the actual field conditions. The procedure for doing such work, including need of and plans for shoring, shall first be reviewed by the Department Engineer then reviewed and approved by the Railroad Engineer, but such approval shall not relieve the Contractor from liability.

Additionally, a walkway with handrail protection may be required as noted in Section 11 herein.

E. Demolition, Erection, Hoisting:

1. Company tracks and other Company or Railroad property must be protected from damage during the procedure.
2. The Contractor is required to submit a plan showing the locations of cranes, horizontally and vertically, operating radii, with delivery or disposal locations shown. The location of all tracks and other railroad facilities as well as wire lines, poles, adjacent structures, etc. must also be shown.
3. Crane rating sheets showing cranes to be adequate for 150% of the actual weight of the pick. A complete set of crane charts, including crane, counterweight, and boom nomenclature is to be submitted.
4. Plans and computations showing the weight of the picks must be submitted. Calculations shall be made from plans of the existing and/or proposed structure showing complete and sufficient details with supporting data for the demolition or erection of the structure. If plans do not exist, lifting weights must be calculated from filed measurements. The field measurements are to be made under the supervision of the North Carolina Registered Professional Engineer submitting the procedure and calculations.
5. A data sheet must be submitted listing the types, size and arrangements of all rigging and connection equipment.
6. A complete written procedure is to be submitted, including the order of lifts, time required for each lift, and any repositioning or rehitching of the crane or cranes.
7. All erection or demolition plans, procedures, data sheets, etc. submitted must be prepared, signed and sealed by a North Carolina Registered Professional Engineer.
8. The Railroad Engineer or his designated representative must be present at the site during the entire demolition and erection procedure period.
9. All procedures, plans and calculations shall first be reviewed by the Department Engineer and then approved by the Railroad Engineer and Company Engineer, but such approval does not relieve the Contractor from liability.

F. Blasting:

1. The Contractor shall obtain advance approval of the Railroad Engineer and Department Engineer for use of explosives on or adjacent to Company's corridor. The request for permission to use explosives shall include a detailed blasting plan. If permission for use of explosives is granted, the Contractor will be required to comply with the following:
 - a. Blasting shall be done with light charges under the direct supervision of a responsible officer or employee of the Contractor and a licensed blaster.

- b. Electric detonating fuses shall not be used because of the possibility of premature explosions resulting from operation of two-way train radios.
 - c. No blasting shall be done without the presence of the Railroad Engineer or his authorized representative. At least 72 hours advance notice to the person designated in the Railroad's notice of authorization to proceed (see section 2B above) will be required to arrange for the presence of an authorized Railroad representative and such flagging as the Railroad may require.
 - d. Have at the job site adequate equipment, labor and materials and allow sufficient time to clean up debris resulting from the blasting without delay to trains, as well as correcting at his expense any track misalignment or other damage to Company property resulting from the blasting as directed by the Railroad Engineer. If his actions result in delay of trains, the Contractor shall bear the entire cost thereof.
 2. The Railroad Engineer will:
 - a. Determine the approximate location of trains and advise the Contractor the approximate amount of time available for the blasting operation and clean-up.
 - b. Have the authority to order discontinuance of blasting if, in his opinion, blasting is too hazardous or is not in accord with these special provisions.
- G. Maintenance of Railroad Facilities:
 1. The Contractor will be required to maintain all ditches and drainage structures free of silt or other obstructions which may result from his operations and provide and maintain any erosion control measures as required. The Contractor will promptly repair eroded areas within Company's corridor and repair any other damage to the property of the Company or its tenants.
 2. If, in the course of construction, it may be necessary to block a ditch, pipe or other drainage facility, temporary pipes, ditches or other drainage facilities shall be installed to maintain adequate drainage, as approved by the Railroad and Company. Upon completion of the work, the temporary facilities shall be removed and the permanent facilities restored.
 3. All such maintenance and repair of damages due to the Contractor's operations shall be done at the Contractor's expense.
- H. Storage of Materials and Equipment:

Materials and equipment shall not be stored where they will interfere with Railroad operations, nor on the corridor of the Company without first having obtained permission from the Railroad Engineer and Company Engineer, and such permission will be with the understanding that neither the Company nor Railroad will be liable for damage to such material and equipment from any cause and that the Railroad Engineer

or Company Engineer may move or require the Contractor to move, at the Contractor's expense, such material and equipment.

All grading or construction machinery that is left parked near the track unattended by a watchman shall be effectively immobilized so that it cannot be moved by unauthorized persons. The Contractor shall protect, defend, indemnify and save Company and Railroad, and any associated, controlled or affiliated corporation, harmless from and against all loss, costs, expenses, claim or liability for loss of or damage to property or the loss of life or personal injury, arising out of or incident to the Contractor's failure to immobilize grading or construction machinery. The Contractor shall protect, defend, indemnify and save Railroad, and any associated, controlled or affiliated corporation, harmless from and against all losses, costs, expenses, claim or liability for loss or damage to property or the loss of life or personal injury, arising out of or incident to the Contractor's failure to immobilize grading or construction machinery.

I. **Cleanup:**

Upon completion of the work, the Contractor shall remove from within the limits of the Company's right corridor, all machinery, equipment, surplus materials, falsework, rubbish or temporary buildings of the Contractor, and leave said corridor in a neat condition satisfactory to the Railroad Engineer or his authorized representative and satisfactory to the Company's authorized representative. Cleanup also included removal, replacement or cleaning of soiled or contaminated ballast in the construction area

6. **DAMAGES:**

- A. The Contractor shall assume all liability for any and all damages to his work, employees, servants, equipment and materials caused by Railroad traffic.
- B. Any cost incurred by the Company or Railroad for repairing damages to Company's property or to property of its tenants, caused by or resulting from the operations of the Contractor, shall be paid directly to the Company or Railroad by the Contractor.

7. **FLAGGING SERVICES:**

A. **Requirements:**

- 1. Flagging services will not be provided until the Contractor's insurance has been reviewed and approved by the Company and Railroad.
- 2. Under the terms of the agreement between the Department, Company and Railroad, the Railroad has sole authority to determine the need for flagging required to protect its operations. In general, the requirements of such services will be whenever the Contractor's men or equipment are, or are likely to be, working on the Company's corridor, or across, over, adjacent to or under a track, or when such work has disturbed or is likely to disturb a Railroad or Company structure, roadbed, or

surface and alignment of any track to such extent that the movement of trains must be controlled by flagging.

3. Normally, the Railroad will assign one flagman to a project; but in some cases, more than one may be necessary, such as yard limits where three (3) flagmen may be required. However, if the Contractor works within distances that violate instructions given by the Railroad Engineer or performs work that has not been scheduled with the Railroad Engineer, a flagman or flagmen may be required full time until the project has been completed. Should such violations or unscheduled, unauthorized work by the Contractor result in full time flagging being required by the Railroad, the additional cost of such flagging above normal flagging cost shall be deducted from the final payment to the Contractor as provided in Article 109-9 of the Standard Specifications. Neither the Department, Company nor Railroad will be liable for damages resulting from unscheduled or unauthorized work.

B. Scheduling and Notification:

1. The Contractor's work requiring railroad flagging should be scheduled to limit the presence of a flagman at the site to a maximum of 50 hours per week. The Contractor shall receive Railroad approval of work schedules requiring a flagman presence in excess of 40 hours per week.
2. No later than the time that approval is initially requested to begin work on Company corridor, the Contractor shall furnish to the Department, Company, and Railroad a schedule for all work required to complete the portion of the project within Company corridor and arrange for a job site meeting between the Contractor, Department, and Railroad. Flagman or flagmen may not be provided until the job site meeting has been conducted and the Contractor's work scheduled.
3. The Contractor will be required to give the Railroad Engineer at least 10 working days of advance written notice of intent to begin work within Company's corridor in accordance with this special provision. Once begun, when such work is then suspended at any time, or for any reason, the Contractor will be required to give the Railroad Engineer at least 3 working days of advance notice before resuming work on Company's corridor. Such notices shall include sufficient details of the proposed work to enable the Railroad Engineer to determine if flagging will be required. If such notice is in writing, the Contractor shall furnish the Department Engineer a copy; if notice is given verbally, it shall be confirmed in writing with a copy to the Department Engineer.
4. If flagging is required, no work shall be undertaken until the flagman, or flagmen, is present at the job site. It may take up to 30 days to obtain flagging initially from the Railroad. When flagging begins, the flagman is usually assigned by the Railroad to work at the project site on a continual basis until no longer needed and cannot be called for on a spot basis. If flagging becomes unnecessary and is suspended, it may take up to 30 days to again obtain from the Railroad. Due to labor agreements,

it is necessary to give 5 working days notice before flagging service may be discontinued and responsibility for payment stopped.

5. If, after the flagman is assigned to the project site, emergencies arise which require the flagman's presence elsewhere, the Contractor shall delay work on Company's corridor until such time as the flagman is again available. Any additional costs resulting from such delay shall be borne by the Contractor and not the Department, Company, or Railroad.

C. Payment:

1. The Department will be responsible for paying the Railroad directly for any and all costs of flagging which may be required to accomplish the construction. The Contractor shall reimburse the Railroad for any costs of the flagging which is required for work for the benefit of the Contractor.
2. The estimated cost of flagging service is the current rate per day based on a 10-hour work day. This cost includes the base pay for each flagman, overhead, and a per diem charge for travel expenses, meals and lodging. The charge by the Railroad will be the actual cost based on the rate of pay for the Railroad's employees who are available for flagging service at the time the service is required.
3. Work by a flagman in excess of 8 hours per day or 40 hours per week, but not more than 12 hours a day will result in overtime pay at 1½ times the appropriate rate. Work by a flagman in excess of 12 hours per day will result in overtime pay at 2 times the appropriate rate. If work is performed on a holiday, the flagging rate is 2½ times the normal rate.
4. Railroad work involved in preparing and handling bills will also be charged to the Department. Charges to the Department by the Railroad shall be in accordance with applicable provisions of the Federal-Aid Policy Guide, Title 23 Subchapter B, Part 140I and Subchapter G, Part 646B issued by the Federal Highway Administration on December 9, 1991, including all current amendments. Flagging costs are subject to change. The above estimates of flagging costs are provided for information only and are not binding in any way.

D. Verification:

1. Railroad's flagman will electronically enter flagging time via Railroad's electronic billing system. Any complaints concerning flagman or flagmen must be resolved in a timely manner. If need for flagman or flagmen is questioned, please contact Railroad's System Engineer of Public Improvements at (404) 529-1641. All verbal complaints must be confirmed in writing by the Contractor within 5 working days with copy to the Department Engineer. Address all written correspondence electronically to the Railroad Engineer:

Scott Overbey – Public Projects Engineer
saoverbey@nscorp.com

2. The Railroad flagman assigned to the project will be responsible for notifying the Department Engineer upon arrival at the job site on the first day (or as soon thereafter as possible) that flagging services begin and on the last day that he performs such services for each separate period that services are provided. The Department Engineer will document such notification and general flagging times for verification purposes in the project records. When requested, the Department Engineer will also sign the flagman's diary showing daily time spent and activity at the project site. Also if requested, the flagman will cooperate with the Department by submitting daily timesheets or signing the Department Engineer's diary showing daily time spent at the project site.
8. HAUL ACROSS RAILROADS:
 - A. Where the plans show or imply that materials of any nature must be hauled across a railroad, unless the plans clearly show that the Department has included arrangements for such haul in its agreement with the Railroad and Company, the Contractor will be required to make all necessary arrangements with the Railroad and Company regarding means of transporting such materials across the railroad. The Contractor will be required to bear all costs incidental, including flagging, to such crossings whether services are performed by his own forces or by Railroad personnel.
 - B. No crossing may be established for use of the Contractor for transporting materials or equipment across the tracks of the Company unless specific authority for its installation, maintenance, necessary watching and flagging thereof and removal, all at the expense of the Contractor, is first obtained from the Railroad Engineer. The approval process for a temporary private crossing agreement executed between the Contractor, Company and Railroad normally takes 90 days.
 9. WORK FOR THE BENEFIT OF THE CONTRACTOR:
 - A. All temporary or permanent changes in wire lines or other facilities which are considered necessary to the project are shown on the plans and included in the force account agreement between the Department, Company and Railroad; or will be covered by appropriate revisions to same which will be initiated and approved by the Department, Railroad and/or Company.
 - B. Should the Contractor desire any changes in addition to the above, then he shall make separate arrangements with the Railroad and Company for same to be accomplished at the Contractor's expense.
 10. COOPERATION AND DELAYS:
 - A. It shall be the Contractor's responsibility to arrange a schedule with the Railroad for accomplishing stage construction involving work by the Railroad or tenants of the Company or Railroad. In arranging his schedule he shall ascertain, from the Railroad, the lead time required for assembling crews and materials and shall make due allowance therefore. The Contractor shall cooperate with others in the construction of the project to the end that all work may be accomplished to the best advantage.

- B. No charge or claims of the Contractor against the Department, Company, or Railroad will be allowed for hindrance or delay on account of railroad traffic, any work done by the Railroad or other delay incident to or necessary for safe maintenance of railroad traffic or for any delays due to compliance with these special provisions.
- C. The Contractor's attention is called to the fact that neither the Department, Company nor Railroad assumes any responsibility for any work performed by others in connection with the construction of the project, and the Contractor shall have no claim whatsoever against the Department, Company or Railroad for any inconvenience, delay, or additional cost incurred by him on account of such operations by others.

11. TRAINMAN'S WALKWAYS:

Along the outer side of each exterior track of multiple operated tracks, and on each side of single operated track, an unobstructed continuous space suitable for trainman's use in walking along trains, extending to a line not less than 10' from centerline of track, shall be maintained. Any temporary impediments to walkways and track drainage encroachments or obstructions allowed during work hours while Railroad's protective service is provided shall be removed before the close of each work day. If there is any excavation near the walkway, a handrail, with 10'-0" minimum clearance from centerline of track shall be placed and must conform to AREMA and/or FRA standards.

12. GUIDELINES FOR PERSONNEL ON COMPANY'S CORRIDOR:

- A. All persons shall wear hard hats. Appropriate eye and hearing protection must be used. Working in shorts is prohibited. Shirts must cover shoulders, back and abdomen. Working in tennis or jogging shoes, sandals, boots with high heels, cowboy and other slip-on type boots is prohibited. Hard-sole, lace-up footwear, zippered boots or boots cinched up with straps which fit snugly about the ankle are adequate. Wearing Safety boots is strongly recommended. In the vicinity of at-grade crossings, it is strongly recommended to wear reflective vests.
- B. No one is allowed within 25' of the centerline of track without specific authorization from the flagman.
- C. All persons working near track while train is passing are to lookout for dragging bands, chains and protruding or shifted cargo.
- D. No one is allowed to cross tracks without specific authorization from the flagman.
- E. All welders and cutting torches working within 25' of track must stop when train is passing.
- F. No steel tape or chain will be allowed to cross or touch rails without permission from the Railroad.

13. GUIDELINES FOR EQUIPMENT ON COMPANY'S CORRIDOR:

- A. No crane or boom equipment will be allowed to set up to work or park within boom distance plus 15 ft. of centerline of track without specific permission from Railroad Engineer and flagman.
- B. No crane or boom equipment will be allowed to foul track or lift a load over the track without flag protection and track time.
- C. All employees will stay with their machines when crane or boom equipment is pointed toward track.
- D. All cranes and boom equipment under load will stop work while train is passing (including pile driving).
- E. Swinging loads must be secured to prevent movement while train is passing.
- F. No loads will be suspended above a moving train.
- G. No equipment will be allowed within 25' of centerline of track without specific authorization of the flagman.
- H. Trucks, tractors or any equipment will not touch ballast line without specific permission from railroad official and flagman. Orange construction fencing may be required as directed.
- I. No equipment or load movement within 25' or above a standing train or railroad equipment without specific authorization of the flagman.
- J. All operating equipment within 25' of track must halt operations when a train is passing. All other operating equipment may be halted by the flagman if the flagman views the operation to be dangerous to the passing train.
- K. All equipment, loads and cables are prohibited from touching rails.
- L. While clearing and grubbing, no vegetation will be removed from railroad embankment with heavy equipment without specific permission from the Railroad Engineer and flagman.
- M. No equipment or materials will be parked or stored on Company's corridor unless specific authorization is granted from the Railroad Engineer.
- N. All unattended equipment that is left parked on Company's corridor shall be effectively immobilized so that it cannot be moved by unauthorized persons.
- O. All cranes and boom equipment will be turned away from track after each work day or whenever unattended by an operator.

- P. Prior to performing any crane operations, the Contractor shall establish a single point of contact for the Railroad flagman to remain in communication with at all times. Person must also be in direct contact with the individual(s) directing the crane operation(s).

14. INSURANCE:

- A. In addition to any other forms of insurance or bonds required under the terms of the contract and specifications, the Prime Contractor will be required to provide coverage conforming to the requirements of the Federal-Aid Policy Guide outlined under Title 23 Subchapter G, Part 646A for all work to be performed on Company's corridor by carrying insurance of the following kinds and amounts:

1. **Commercial General Liability Insurance** having a combined single limit of not less than \$2,000,000 per occurrence for all loss, damage, cost and expense, including attorneys' fees, arising out of bodily injury liability and property damage liability during the policy period. Said policy shall include explosion, collapse, and underground hazard (XCU) coverage, shall be endorsed to name Company and Railroad specified in section 14A2(c) below both as the certificate holder and as an additional insured, and shall include a severability of interests provision.
2. **Railroad Protective Liability Insurance** having a combined single limit of not less than \$2,000,000 each occurrence and \$6,000,000 in the aggregate applying separately to each annual period. If the project involves track over which passenger trains operate, the insurance limits required are not less than a combined single limit of \$5,000,000 each occurrence and \$10,000,000 in the aggregate applying separately to each annual period. Said policy shall provide coverage for all loss, damage or expense arising from bodily injury and property damage liability, and physical damage to property attributed to acts or omissions at the job site.

The standards for the Railroad Protective Liability Insurance are as follows:

- a. The insurer must be rated A- or better by A.M. Best Company, Inc.

NOTE: NS does not accept from insurers Chartis (AIG or Affiliated Railroad including Lexington Insurance Railroad), Hudson Group or ACE.

- b. The policy must be written using one of the following combinations of Insurance Services Office ("ISO") Railroad Protective Liability Insurance Form Numbers:

- (1) CG 00 35 01 96 and CG 28 31 10 93; or
- (2) CG 00 35 07 98 and CG 28 31 07 98; or
- (3) CG 00 35 10 01; or
- (4) CG 00 35 12 04; or
- (5) CG 00 35 12 07

- c. The named insured on each policy as required to be issued to each Company and to Railroad shall read:
(NOTE: The below insured is to be treated separately as an insured on each railroad protective policy for a total of (2) two separate policies being issued.)

North Carolina Railroad Company
2809 Highwoods Boulevard, Suite 100
Raleigh, North Carolina 27604-1000
ATTN: Property Department; and

Norfolk Southern Railway Company
Three Commercial Place
Norfolk, Virginia 23510-2191
ATTN: Risk Management

- d. The description of operations must appear on the Declarations, must match the project description in this agreement, and must include the appropriate Department project and contract identification numbers.

The Description and Designation shall read:

Description and Designation: Replace Bridge Numbers 66 and 69 on US-29/601 (Concord Parkway) beginning at Station 20+46.56 –L- and ending at Station 23+02.31 –L- over the tracks owed by Norfolk Southern Railway Company in Cabarrus County, North Carolina identified as State Project 42295.1.1 (B-5136) and Federal Project BRSTP-0029(43).

- e. The job location must appear on the Declarations and must include the city, state, and appropriate highway name/number.

NOTE: Do not include any references to milepost on the insurance policy.

- f. The name and address of the prime contractor must appear on the Declarations.
- g. The name and address of the Department must be identified on the Declarations as the “Involved Governmental Authority or Other Contracting Party.”
- h. Other endorsements/forms that will be accepted are:
- (1) Broad Form Nuclear Exclusion – Form IL 00 21
 - (2) 30-day Advance Notice of Non-renewal or cancellation
 - (3) 60-day written notice to the Department prior to cancellation or change
 - (4) Quick Reference or Index Form CL/IL 240
- i. Endorsements/forms that are NOT acceptable are:
- (1) Any Pollution Exclusion Endorsement except CG 28 31
 - (2) Any Punitive or Exemplary Damages Exclusion

- (3) Known injury or Damage Exclusion form CG 00 59
- (4) Any Common Policy Conditions form
- (5) Any other endorsement/form not specifically authorized in section 14A2h above.

- B. If any part of the work is sublet, similar insurance, and evidence thereof as specified in section 14A1 above, shall be provided by or on behalf of the subcontractor to cover its operations on Company's corridor. As an alternative, the Prime Contractor may provide insurance for the subcontractor by means of separate and individual policies.
- C. Prior to entry on Company's corridor, the original and one duplicate copy of the Railroad Protective Liability Insurance Policy shall be submitted by the Prime Contractor to the Department at the address below for its review and transmittal to the Company and Railroad. In addition, certificates of insurance evidencing the Prime Contractor's and any subcontractors' Commercial General Liability Insurance shall be issued to the Department, Company and Railroad at the addresses below, and one certified copy of the Prime Contractor and any Subcontractor's policy is to be forwarded to the Department for its review and transmittal to the Company and Railroad. All policies and certificates of insurance shall state that the insurance coverage will not be suspended, voided, canceled, or reduced in coverage or limits without (30) days advance written notice to the Department, Company and Railroad. The Railroad will not permit any work on Company's corridor until the Company and Railroad has reviewed and approved the evidence of insurance required herein.

DEPARTMENT:
 NCDOT Rail Division
 Engineering & Safety Branch
 C/O State Railroad Agent
 1556 Mail Service Center
 Raleigh, NC 27699-1556

RAILROAD:
 Risk Management
 Norfolk Southern Railway Company
 Three Commercial Place
 Norfolk, Virginia 23510-2191

COMPANY:
 North Carolina Railroad Company
 2809 Highwoods Blvd.
 Suite 100
 Raleigh, NC 27604

- D. The insurance required herein shall in no way serve to limit the liability of Department or its Contractors under the terms of this agreement.
- E. The insurance amounts specified are minimum amounts and the Contractor may carry insurance in larger amounts if he so desires. As to "aggregate limits", if the insurer establishes loss reserves equal to or in excess of the aggregate limit specified in any of the required insurance policies, the Contractor shall immediately notify the Department and shall cease all operations until the aggregate limit is reinstated. If the insurer establishes loss reserves equal to or in excess of one/half of the aggregate limit, the Contractor shall arrange to restore the aggregate limit to at least the minimum amount

stated in these requirements. Any insurance policies and certificates taken out and furnished due to these requirements shall be approved by the Department, Company and Railroad as to form and amount prior to beginning work on Company's corridor.

F. Insurance Submission Procedures

1. Norfolk Southern will only accept initial insurance submissions via US Mail or Overnightcarrier to the address noted in C above. NS will NOT accept initial insurance submissions via email or faxes.
2. Norfolk Southern requires the following two (2) forms of insurance in the initial insurance submission to be submitted under a cover letter providing details of the project and contact information:
 - a. The full original or certified true countersigned copy of the railroad protective liability insurance policy in its entirety inclusive of all declarations, schedule of forms and endorsements along with the policy forms and endorsements.
 - b. The Contractor's commercial general, automobile, and workers' compensation liability insurance certificate of liability insurance evidencing a combined single limit of a minimum of \$2M per occurrence of general and \$1M per occurrence of automobile liability insurance naming Norfolk Southern Railway Company, Three Commercial Place, Norfolk, VA 23510 as the certificate holder and as an additional insured on both the general and automobile liability insurance policy.
3. It should be noted that the Railroad does not accept notation of Railroad Protective insurance on a certificate of liability insurance form or Binders as Railroad must have the full original countersigned policy. Further, please note that mere receipt of the policy is not the only issue but review for compliance. Due to the number of projects system-wide, it typically takes a minimum of 30-45 days for the Railroad to review.

G. All insurance herein before specified shall be carried until the final inspection and acceptance of the project by the Department, Company and Railroad, or acceptance of that portion of the project within Company's corridor. At this point, no work or any other activities by the Contractor shall take place in Company's corridor without written permission from the Department, Company and Railroad.

15. FAILURE TO COMPLY:

- A. In the event the Contractor violates or fails to comply with any of the requirements of these Special Provisions:
 1. The Railroad Engineer may require that the Contractor vacate Company's property.
 2. The Department Engineer may withhold all monies due the Contractor on monthly statements.

Any such orders shall remain in effect until the Contractor has remedied the situation to the satisfaction of the Department Engineer and Railroad Engineer.

16. PAYMENT FOR COST OF COMPLIANCE:

No separate payment will be made for any extra cost incurred on account of compliance with these special provisions. All such cost shall be included in the various prices bid to perform the work.

17. COMPLETION AND ACCEPTANCE:

Upon completion of the work, the Contractor shall remove from within the limits of the Company's corridor all machinery, equipment, surplus materials, rubbish or temporary buildings of the Contractor, and leave said corridor in a neat and orderly condition. After the final inspection has been made and work found to be completed in a satisfactory manner acceptable to the Department, Railroad and Company, the Department will be notified of the Railroad's and Company's acceptance in writing by the Railroad's Chief Engineer or his authorized representative and by the Company's representative within ten (10) days or as soon thereafter as practicable.

Railroad Site Data:

The following information was received from the Railroad on January 27, 2015, and is provided as a convenience to the Contractor in bidding this project. This information is subject to change and the Contractor may, at his discretion, contact the Railroad directly to verify its current accuracy. Since this information is shown as a convenience to the Contractor, but is subject to change, the Contractor shall have no claims whatsoever against either the Railroad or the Department of Transportation for any delays or additional costs incurred based on changes in this information which occur after the above date of receipt.

Type and number of tracks within 50 ft. of project (mainline, branchline, siding, yard, etc.).

2 – Mainline

Number of trains on affected track per day.

30

Type of trains (passenger or freight).

Passenger and Freight

Maximum authorized operating speed of trains.

79 mph

Type and number of RR employees assigned to job.

1 - Flagman

County : Cabarrus

Line #	Item Number	Sec #	Description	Quantity	Unit Cost	Amount
ROADWAY ITEMS						
0001	0000100000-N	800	MOBILIZATION	Lump Sum	L.S.	
0002	0000400000-N	801	CONSTRUCTION SURVEYING	Lump Sum	L.S.	
0003	0029000000-N	SP	REINFORCED BRIDGE APPROACH FILL, STATION ***** (21+74.92 -L-)	Lump Sum	L.S.	
0004	0050000000-E	226	SUPPLEMENTARY CLEARING & GRUB- BING	1 ACR		
0005	0057000000-E	226	UNDERCUT EXCAVATION	1,000 CY		
0006	0063000000-N	SP	GRADING	Lump Sum	L.S.	
0007	0106000000-E	230	BORROW EXCAVATION	43,000 CY		
0008	0195000000-E	265	SELECT GRANULAR MATERIAL	1,000 CY		
0009	0196000000-E	270	GEOTEXTILE FOR SOIL STABILIZA- TION	2,470 SY		
0010	0199000000-E	SP	TEMPORARY SHORING	17,660 SF		
0011	0318000000-E	300	FOUNDATION CONDITIONING MATE- RIAL, MINOR STRUCTURES	437 TON		
0012	0320000000-E	300	FOUNDATION CONDITIONING GEO- TEXTILE	2,465 SY		
0013	0335200000-E	305	15" DRAINAGE PIPE	144 LF		
0014	0366000000-E	310	15" RC PIPE CULVERTS, CLASS III	324 LF		
0015	0448200000-E	310	15" RC PIPE CULVERTS, CLASS IV	2,060 LF		
0016	0448300000-E	310	18" RC PIPE CULVERTS, CLASS IV	4 LF		
0017	0995000000-E	340	PIPE REMOVAL	483 LF		
0018	1099500000-E	505	SHALLOW UNDERCUT	1,470 CY		
0019	1099700000-E	505	CLASS IV SUBGRADE STABILIZA- TION	2,646 TON		

County : Cabarrus

Line #	Item Number	Sec #	Description	Quantity	Unit Cost	Amount
0020	1121000000-E	520	AGGREGATE BASE COURSE	1,400		TON
0021	1220000000-E	545	INCIDENTAL STONE BASE	500		TON
0022	1330000000-E	607	INCIDENTAL MILLING	640		SY
0023	1491000000-E	610	ASPHALT CONC BASE COURSE, TYPE B25.0C	8,825		TON
0024	1503000000-E	610	ASPHALT CONC INTERMEDIATE COURSE, TYPE I19.0C	2,300		TON
0025	1523000000-E	610	ASPHALT CONC SURFACE COURSE, TYPE S9.5C	4,850		TON
0026	1575000000-E	620	ASPHALT BINDER FOR PLANT MIX	785		TON
0027	1693000000-E	654	ASPHALT PLANT MIX, PAVEMENT REPAIR	185		TON
0028	2022000000-E	815	SUBDRAIN EXCAVATION	168		CY
0029	2033000000-E	815	SUBDRAIN FINE AGGREGATE	84		CY
0030	2044000000-E	815	6" PERFORATED SUBDRAIN PIPE	500		LF
0031	2070000000-N	815	SUBDRAIN PIPE OUTLET	1		EA
0032	2077000000-E	815	6" OUTLET PIPE	6		LF
0033	2190000000-N	828	TEMPORARY STEEL PLATE COVERS FOR MASONRY DRAINAGE STRUCTURE	11		EA
0034	2253000000-E	840	PIPE COLLARS	2		CY
0035	2264000000-E	840	PIPE PLUGS	1		CY
0036	2275000000-E	SP	FLOWABLE FILL	35		CY
0037	2286000000-N	840	MASONRY DRAINAGE STRUCTURES	22		EA
0038	2308000000-E	840	MASONRY DRAINAGE STRUCTURES	15		LF

County : Cabarrus

Line #	Item Number	Sec #	Description	Quantity	Unit Cost	Amount
0039	2364000000-N	840	FRAME WITH TWO GRATES, STD 840.16	2 EA		
0040	2367000000-N	840	FRAME WITH TWO GRATES, STD 840.29	4 EA		
0041	2374000000-N	840	FRAME WITH GRATE & HOOD, STD 840.03, TYPE ** (F)	10 EA		
0042	2374000000-N	840	FRAME WITH GRATE & HOOD, STD 840.03, TYPE ** (G)	5 EA		
0043	2396000000-N	840	FRAME WITH COVER, STD 840.54	1 EA		
0044	2440000000-N	852	CONCRETE TRANSITIONAL SECTION FOR CATCH BASIN	3 EA		
0045	2451000000-N	852	CONCRETE TRANSITIONAL SECTION FOR DROP INLET	3 EA		
0046	2542000000-E	846	1'-6" CONCRETE CURB & GUTTER	2,150 LF		
0047	2549000000-E	846	2'-6" CONCRETE CURB & GUTTER	3,140 LF		
0048	2591000000-E	848	4" CONCRETE SIDEWALK	1,500 SY		
0049	2605000000-N	848	CONCRETE CURB RAMP	14 EA		
0050	2619000000-E	850	4" CONCRETE PAVED DITCH	25 SY		
0051	2655000000-E	852	5" MONOLITHIC CONCRETE ISLANDS (KEYED IN)	660 SY		
0052	2752000000-E	SP	GENERIC PAVING ITEM 8" X 6" TEMPORARY ASPHALT CURB	410 LF		
0053	2830000000-N	858	ADJUSTMENT OF MANHOLES	1 EA		
0054	2845000000-N	858	ADJUSTMENT OF METER BOXES OR VALVE BOXES	11 EA		
0055	2920000000-N	859	CONVERT EXISTING DROP INLET TO CATCH BASIN	4 EA		

County : Cabarrus

Line #	Item Number	Sec #	Description	Quantity	Unit Cost	Amount
0056	3030000000-E	862	STEEL BM GUARDRAIL	1,725	LF	
0057	3045000000-E	862	STEEL BM GUARDRAIL, SHOP CURVED	50	LF	
0058	3150000000-N	862	ADDITIONAL GUARDRAIL POSTS	10	EA	
0059	3195000000-N	862	GUARDRAIL ANCHOR UNITS, TYPE AT-1	1	EA	
0060	3210000000-N	862	GUARDRAIL ANCHOR UNITS, TYPE CAT-1	4	EA	
0061	3215000000-N	862	GUARDRAIL ANCHOR UNITS, TYPE III	4	EA	
0062	3270000000-N	SP	GUARDRAIL ANCHOR UNITS, TYPE 350	3	EA	
0063	3345000000-E	864	REMOVE & RESET EXISTING GUARDRAIL	405	LF	
0064	3360000000-E	863	REMOVE EXISTING GUARDRAIL	2,792	LF	
0065	3380000000-E	862	TEMPORARY STEEL BM GUARDRAIL	537.5	LF	
0066	3387000000-N	862	TEMPORARY GUARDRAIL ANCHOR UNITS, TYPE ***** (CAT-1)	4	EA	
0067	3387000000-N	862	TEMPORARY GUARDRAIL ANCHOR UNITS, TYPE ***** (III)	2	EA	
0068	3387000000-N	862	TEMPORARY GUARDRAIL ANCHOR UNITS, TYPE ***** (W-BEAM)	2	EA	
0069	3389100000-N	SP	TEMPORARY GUARDRAIL ANCHOR UNITS, TYPE 350	2	EA	
0070	3435000000-N	SP	GENERIC GUARDRAIL ITEM TEMPORARY IMPACT ATTENUATOR UNIT, TYPE 350	1	EA	
0071	3533000000-E	866	CHAIN LINK FENCE, *** FABRIC (72")	66	LF	

County : Cabarrus

Line #	Item Number	Sec #	Description	Quantity	Unit Cost	Amount
0072	3539000000-E	866	METAL LINE POSTS FOR *** CHAIN LINK FENCE (72")	5	EA	
0073	3542000000-E	866	METAL LINE POSTS FOR 48" CHAIN LINK FENCE	120	EA	
0074	3545000000-E	866	METAL TERMINAL POSTS FOR *** CHAIN LINK FENCE (72")	6	EA	
0075	3548000000-E	866	METAL TERMINAL POSTS FOR 48" CHAIN LINK FENCE	10	EA	
0076	3575000000-E	SP	GENERIC FENCING ITEM DARK GREEN VINYL COATED CHAIN LINK FENCE 48" FABRIC	1,450	LF	
0077	3575000000-E	SP	GENERIC FENCING ITEM PEDESTRIAN SAFETY RAIL	270	LF	
0078	3575000000-E	SP	GENERIC FENCING ITEM TEMPORARY 72" CHAIN LINK FENCE WITH POSTS	780	LF	
0079	3649000000-E	876	RIP RAP, CLASS B	1	TON	
0080	3656000000-E	876	GEOTEXTILE FOR DRAINAGE	905	SY	
0081	4072000000-E	903	SUPPORTS, 3-LB STEEL U-CHANNEL	756	LF	
0082	4096000000-N	904	SIGN ERECTION, TYPE D	4	EA	
0083	4102000000-N	904	SIGN ERECTION, TYPE E	18	EA	
0084	4108000000-N	904	SIGN ERECTION, TYPE F	15	EA	
0085	4116100000-N	904	SIGN ERECTION, RELOCATE, TYPE **** (GROUND MOUNTED) (D)	1	EA	
0086	4155000000-N	907	DISPOSAL OF SIGN SYSTEM, U-CHANNEL	26	EA	
0087	4400000000-E	1110	WORK ZONE SIGNS (STATIONARY)	328	SF	
0088	4405000000-E	1110	WORK ZONE SIGNS (PORTABLE)	320	SF	

County : Cabarrus

Line #	Item Number	Sec #	Description	Quantity	Unit Cost	Amount
0089	4410000000-E	1110	WORK ZONE SIGNS (BARRICADE MOUNTED)	72 SF		
0090	4415000000-N	1115	FLASHING ARROW BOARD	1 EA		
0091	4420000000-N	1120	PORTABLE CHANGEABLE MESSAGE SIGN	1 EA		
0092	4430000000-N	1130	DRUMS	200 EA		
0093	4435000000-N	1135	CONES	50 EA		
0094	4445000000-E	1145	BARRICADES (TYPE III)	88 LF		
0095	4450000000-N	1150	FLAGGER	500 HR		
0096	4465000000-N	1160	TEMPORARY CRASH CUSHIONS	5 EA		
0097	4480000000-N	1165	TMA	1 EA		
0098	4485000000-E	1170	PORTABLE CONCRETE BARRIER	1,600 LF		
0099	4490000000-E	1170	PORTABLE CONCRETE BARRIER (ANCHORED)	518 LF		
0100	4510000000-N	SP	LAW ENFORCEMENT	48 HR		
0101	4516000000-N	1180	SKINNY DRUM	50 EA		
0102	4650000000-N	1251	TEMPORARY RAISED PAVEMENT MARKERS	416 EA		
0103	4685000000-E	1205	THERMOPLASTIC PAVEMENT MARKING LINES (4", 90 MILS)	166 LF		
0104	4686000000-E	1205	THERMOPLASTIC PAVEMENT MARKING LINES (4", 120 MILS)	4,433 LF		
0105	4697000000-E	1205	THERMOPLASTIC PAVEMENT MARKING LINES (8", 120 MILS)	1,070 LF		
0106	4710000000-E	1205	THERMOPLASTIC PAVEMENT MARKING LINES (24", 120 MILS)	354 LF		

County : Cabarrus

Line #	Item Number	Sec #	Description	Quantity	Unit Cost	Amount
0107	4721000000-E	1205	THERMOPLASTIC PAVEMENT MARKING CHARACTER (120 MILS)	4 EA		
0108	4725000000-E	1205	THERMOPLASTIC PAVEMENT MARKING SYMBOL (90 MILS)	21 EA		
0109	4770000000-E	1205	COLD APPLIED PLASTIC PAVEMENT MARKING LINES, TYPE ** (4") (II)	1,970 LF		
0110	4770000000-E	1205	COLD APPLIED PLASTIC PAVEMENT MARKING LINES, TYPE ** (4") (IV)	2,198 LF		
0111	4780000000-E	1205	COLD APPLIED PLASTIC PAVEMENT MARKING LINES, TYPE ** (8") (II)	152 LF		
0112	4810000000-E	1205	PAINT PAVEMENT MARKING LINES (4")	45,371 LF		
0113	4835000000-E	1205	PAINT PAVEMENT MARKING LINES (24")	744 LF		
0114	4840000000-N	1205	PAINT PAVEMENT MARKING CHARACTER	4 EA		
0115	4845000000-N	1205	PAINT PAVEMENT MARKING SYMBOL	77 EA		
0116	4850000000-E	1205	REMOVAL OF PAVEMENT MARKING LINES (4")	3,938 LF		
0117	4875000000-N	1205	REMOVAL OF PAVEMENT MARKING SYMBOLS & CHARACTERS	6 EA		
0118	4900000000-N	1251	PERMANENT RAISED PAVEMENT MARKERS	23 EA		
0119	5325800000-E	1510	8" WATER LINE	457 LF		
0120	5327400000-E	1510	24" WATER LINE	1,115 LF		
0121	5546000000-E	1515	8" VALVE	1 EA		
0122	5559400000-E	1515	24" VALVE	4 EA		
0123	5571600000-E	1515	6" TAPPING VALVE	1 EA		

County : Cabarrus

Line #	Item Number	Sec #	Description	Quantity	Unit Cost	Amount
0124	5571800000-E	1515	8" TAPPING VALVE	1 EA		
0125	5648000000-N	1515	RELOCATE WATER METER	2 EA		
0126	5666000000-E	1515	FIRE HYDRANT	1 EA		
0127	5775000000-E	1525	4' DIA UTILITY MANHOLE	2 EA		
0128	5781000000-E	1525	UTILITY MANHOLE WALL, 4' DIA	18 LF		
0129	5801000000-E	1530	ABANDON 8" UTILITY PIPE	534 LF		
0130	5813000000-E	1530	ABANDON 24" UTILITY PIPE	1,070 LF		
0131	5816000000-N	1530	ABANDON UTILITY MANHOLE	1 EA		
0132	5836400000-E	1540	36" ENCASEMENT PIPE	402 LF		
0133	5872400000-E	1550	TRENCHLESS INSTALLATION OF 36" IN SOIL	201 LF		
0134	5872410000-E	1550	TRENCHLESS INSTALLATION OF 36" NOT IN SOIL	201 LF		
0135	5882000000-N	SP	GENERIC UTILITY ITEM 3" COMBINATION AIR RELEASE VALVE	1 EA		
0136	6000000000-E	1605	TEMPORARY SILT FENCE	7,000 LF		
0137	6006000000-E	1610	STONE FOR EROSION CONTROL, CLASS A	360 TON		
0138	6009000000-E	1610	STONE FOR EROSION CONTROL, CLASS B	505 TON		
0139	6012000000-E	1610	SEDIMENT CONTROL STONE	540 TON		
0140	6015000000-E	1615	TEMPORARY MULCHING	7.5 ACR		
0141	6018000000-E	1620	SEED FOR TEMPORARY SEEDING	500 LB		
0142	6021000000-E	1620	FERTILIZER FOR TEMPORARY SEED- ING	2.5 TON		

County : Cabarrus

Line #	Item Number	Sec #	Description	Quantity	Unit Cost	Amount
0143	6024000000-E	1622	TEMPORARY SLOPE DRAINS	500 LF		
0144	6029000000-E	SP	SAFETY FENCE	200 LF		
0145	6030000000-E	1630	SILT EXCAVATION	610 CY		
0146	6036000000-E	1631	MATTING FOR EROSION CONTROL	2,500 SY		
0147	6042000000-E	1632	1/4" HARDWARE CLOTH	1,225 LF		
0148	6071010000-E	SP	WATTLE	75 LF		
0149	6071020000-E	SP	POLYACRYLAMIDE (PAM)	25 LB		
0150	6084000000-E	1660	SEEDING & MULCHING	8 ACR		
0151	6087000000-E	1660	MOWING	4 ACR		
0152	6090000000-E	1661	SEED FOR REPAIR SEEDING	100 LB		
0153	6093000000-E	1661	FERTILIZER FOR REPAIR SEEDING	0.25 TON		
0154	6096000000-E	1662	SEED FOR SUPPLEMENTAL SEEDING	225 LB		
0155	6108000000-E	1665	FERTILIZER TOPDRESSING	6.75 TON		
0156	6114500000-N	1667	SPECIALIZED HAND MOWING	10 MHR		
0157	6117000000-N	SP	RESPONSE FOR EROSION CONTROL	18 EA		
0158	6132000000-N	SP	GENERIC EROSION CONTROL ITEM CONCRETE WASHOUT STRUCTURE	8 EA		
0159	7060000000-E	1705	SIGNAL CABLE	1,470 LF		
0160	7120000000-E	1705	VEHICLE SIGNAL HEAD (12", 3 SECTION)	8 EA		
0161	7132000000-E	1705	VEHICLE SIGNAL HEAD (12", 4 SECTION)	3 EA		
0162	7144000000-E	1705	VEHICLE SIGNAL HEAD (12", 5 SECTION)	2 EA		

County : Cabarrus

Line #	Item Number	Sec #	Description	Quantity	Unit Cost	Amount
0163	7264000000-E	1710	MESSENGER CABLE (3/8")	530		LF
0164	7288000000-E	1715	PAVED TRENCHING (*****) (1, 2")	50		LF
0165	7300000000-E	1715	UNPAVED TRENCHING (*****) (1, 2")	790		LF
0166	7300100000-E	1715	UNPAVED TRENCHING FOR TEMP- ORARY LEAD-IN	95		LF
0167	7301000000-E	1715	DIRECTIONAL DRILL (*****) (1, 2")	155		LF
0168	7324000000-N	1716	JUNCTION BOX (STANDARD SIZE)	16		EA
0169	7360000000-N	1720	WOOD POLE	7		EA
0170	7372000000-N	1721	GUY ASSEMBLY	10		EA
0171	7408000000-E	1722	1" RISER WITH WEATHERHEAD	1		EA
0172	7420000000-E	1722	2" RISER WITH WEATHERHEAD	3		EA
0173	7444000000-E	1725	INDUCTIVE LOOP SAWCUT	2,265		LF
0174	7456000000-E	1726	LEAD-IN CABLE (*****) (14-2)	7,635		LF
0175	7636000000-N	1745	SIGN FOR SIGNALS	4		EA
0176	7684000000-N	1750	SIGNAL CABINET FOUNDATION	1		EA
0177	7756000000-N	1751	CONTROLLER WITH CABINET (TYPE 2070L, BASE MOUNTED)	1		EA
0178	7780000000-N	1751	DETECTOR CARD (TYPE 2070L)	9		EA
0179	7901000000-N	1753	CABINET BASE EXTENDER	1		EA
0180	7980000000-N	SP	GENERIC SIGNAL ITEM MICROWAVE VEHICLE DETECTOR- SINGLE ZONE	4		EA

County : Cabarrus

Line #	Item Number	Sec #	Description	Quantity	Unit Cost	Amount
WALL ITEMS						
0181	8801000000-E	SP	MSE RETAINING WALL NO **** (1)	930 SF		
0182	8801000000-E	SP	MSE RETAINING WALL NO **** (2, 4 & END BENT 2 ABUTMENT)	22,750 SF		
0183	8801000000-E	SP	MSE RETAINING WALL NO **** (3)	995 SF		
0184	8801000000-E	SP	MSE RETAINING WALL NO **** (5)	5,460 SF		
STRUCTURE ITEMS						
0185	8007000000-N	SP	CONSTRUCTION, MAINTENANCE, & REMOVAL OF TEMP STRUCTURE AT STA ***** (21+74.92-L-)	Lump Sum	L.S.	
0186	8042000000-N	402	REMOVAL OF EXISTING STRUCTURES AT STATION ***** (21+74.92-L-)	Lump Sum	L.S.	
0187	8091000000-N	410	FOUNDATION EXCAVATION FOR BENT ** AT STATION ***** (1,21+74.92-L-)	Lump Sum	L.S.	
0188	8091000000-N	410	FOUNDATION EXCAVATION FOR BENT ** AT STATION ***** (2,21+74.92-L-)	Lump Sum	L.S.	
0189	8112730000-N	450	PDA TESTING	1 EA		
0190	8121000000-N	412	UNCLASSIFIED STRUCTURE EXCAVA- TION AT STATION ***** (21+74.92-L-)	Lump Sum	L.S.	
0191	8147000000-E	420	REINFORCED CONCRETE DECK SLAB	29,220 SF		
0192	8161000000-E	420	GROOVING BRIDGE FLOORS	29,382 SF		
0193	8182000000-E	420	CLASS A CONCRETE (BRIDGE)	640.8 CY		
0194	8210000000-N	422	BRIDGE APPROACH SLABS, STATION ***** (21+74.92-L-)	Lump Sum	L.S.	

County : Cabarrus

Line #	Item Number	Sec #	Description	Quantity	Unit Cost	Amount
0195	8217000000-E	425	REINFORCING STEEL (BRIDGE)	101,903	LB	
0196	8238000000-E	425	SPIRAL COLUMN REINFORCING STEEL (BRIDGE)	9,553	LB	
0197	8262000000-E	430	45" PRESTRESSED CONCRETE GIRDERS	1,544	LF	
0198	8280000000-E	440	APPROX LBS STRUCTURAL STEEL	437,500	LS	
0199	8364000000-E	450	HP12X53 STEEL PILES	2,785	LF	
0200	8384000000-E	450	HP14X73 STEEL PILES	3,360	LF	
0201	8531000000-E	462	4" SLOPE PROTECTION	900	SY	
0202	8657000000-N	430	ELASTOMERIC BEARINGS	Lump Sum	L.S.	
0203	8706000000-N	SP	EXPANSION JOINT SEALS	Lump Sum	L.S.	
0204	8867000000-E	SP	GENERIC STRUCTURE ITEM CLASSIC CONC BRIDGE RAIL	506.7	LF	

1630/Jul09/Q857086.0/D943029170000/E204

Total Amount Of Bid For Entire Project :

Vendor 1 of 5: HRI INC DBA HRI BRIDGE COMPANY (9304)
Call Order 006 (Proposal: C203565)

Bid Information

Proposal County: CABARRUS

Vendor Address: 2409 E. Cherokee Street
Blackburg , SC , 29702

Signature Check: Kent_L._Wible_9304

Time Bid Received: August 18, 2015 01:49 PM

Amendment Count: 0

Bid Checksum: B64EFE11

Bid Total: \$12,949,964.50

Items Total: \$12,949,964.50

Time Total: \$0.00

Bidding Errors:

Item Warning : item 2022000000-E (Line# 0028) quantity
Item Warning : item 2033000000-E (Line# 0029) quantity
Item Warning : item 2044000000-E (Line# 0030) quantity
Item Warning : item 2070000000-N (Line# 0031) quantity
Item Warning : item 2077000000-E (Line# 0032) quantity
Item Warning : item 8147000000-E (Line# 0191) quantity

DBE Goal Set 10.0%

DBE Goal Met 10.0%

Vendor 1 of 5: HRI INC DBA HRI BRIDGE COMPANY (9304)
Call Order 006 (Proposal: C203565)

Bid Bond Information

Projects:	Bond Maximum:
Counties:	State of Incorporation:
Bond ID: 6YDE-1UMK-CKQC-V63X	Agency Execution Date: 8/18/2015
Paid by Check: No	Surety Name: SurePathNetwork
Bond Percent: 5%	Bond Agency Name: Liberty Mutual Insurance Company

Bidder 5 of 5

Vendor 9304's Bid Information for Call 006, Letting L150818, 08/18/15

HRI Inc., dba HRI Bridge Company (9304)
 Call Order 006 (Proposal ID C203565)

LIST OF DBE PARTICIPANTS

VENDOR NUMBER	DBE NAME ADDRESS	WORK CODE TYPE OF WORK	CERT TYPE AMOUNT	
4898	WB BULLINGTON CONSTRUCTION INC 417 FOXGLOVE LANE , INDIAN TRAIL, NC 28079		Sub	97,721.50 80,391.50 ARM Committed
3080	WB CURTIN TRUCKING & DRAINAGE, INC POST OFFICE BOX 38220 , CHARLOTTE, NC 282781003		Sub	83,190.30 Committed
11402	WB FLORENCE CONCRETE PRODUCTS, INC P.O. BOX 5506 , FLORENCE, SC 295025506		Man	171,893.52 Committed
3230	WB HIATT & MASON ENTERPRISES INC POST OFFICE BOX 1378 , MOUNT AIRY, NC 27030		Sub	26,882.40 Committed 64,752.26 ARM
5653	MB BORDER REBAR, LLC 1920 SILVER CREEK DRIVE , GASTONIA, NC 28052		Sub	50,078.23 Committed
5640	WB ALL POINTS TRUCKING P.O. BOX 240801 , CHARLOTTE, NC 28224		Sub	588,345.50 Committed
3376	WB REYNOLDS FENCE & GUARDRAIL INC 9320 MACHADO DRIVE , INDIAN TRAIL, NC 28079		Sub	63,485.75 Committed
12278	WB CLIFTON CONSTRUCTION CO., INC. 1435 GIDDENSVILLE ROAD , FAISON, NC 28341		Sub	17,330.00 Committed
12289	MB SMITH JAMISON DBA SMITH JAMISON 4015 PENDORIC CIRCLE , WINSTON-SALEM, NC 27106		Sub	159,335.00 Committed
3765	WB STAY ALERT SAFETY SERVICES INC POST OFFICE BOX 467 , KERNERSVILLE, NC 27285		Sub	46,440.44 Committed \$1,302,046.67 ARM
			TOTAL:	\$1,304,702.64 -10.07% 10.05% ARM

Vendor 9304's Bid Information for Call 006, Letting L150818, 08/18/15

HRI Inc., dba HRI Bridge Company (9304)
 Call Order 006 (Proposal ID C203565)

Miscellaneous Data Info - Contractor Responses:
 =====

NON-COLLUSION AND DEBARMENT CERTIFICATION

Explanation of the prospective bidder that is unable to certify to any of the statements in this certification:

Explanation:
 NOT ANSWERED
 NOT ANSWERED
 NOT ANSWERED
 NOT ANSWERED

AWARD LIMITS ON MULTIPLE PROJECTS

By answering YES to this statement, the bidder acknowledges that they are using the award limits on multiple projects. No

It is the desire of the Bidder to be awarded contracts, the value of which will not exceed a total of NOT ANSWERED for those projects indicated herein, for which bids will be opened on (MM/DD/YY)

Bidder 1 of 5

The Award Limits shall apply to the following projects:

Contract Number	County
NOT ANSWERED	
NOT ANSWERED	
NOT ANSWERED	
NOT ANSWERED	
NOT ANSWERED	
NOT ANSWERED	

Bid Bond Data Info - Contractor Responses:

=====

BondID: 6YDE-1UMK-CKQC-V63X
 Surety Registry Agency: SurePathNetwork
 Verified?: Yes
 Surety Agency: Liberty Mutual Insurance Company
 Bond Execution Date: 8/18/2015
 Bond Amount: \$647,498.22 (Five Percent of Bid)

Contract ID: C203565 Project(s): BRSTP-0029(43)
 Letting Date: 08-18-15 Call Order: 006
 Bidder: 9304 - HRI Inc., dba HRI Bridge Company

Line No.	Item Description	Approx. Quantity and Units	Unit Price Dollars Cts	Bid Amount Dollars Ct
Section 0001 ROADWAY ITEMS				
Alt Group				
0001	0000100000-N MOBILIZATIO N	LUMP	LUMP	625,000.00
0002	0000400000-N CONSTRUCTIO N SURVEYING	LUMP	LUMP	150,000.00
0003	0029000000-N REINFORCED BRIDGE APPROACH FILL, STATION ***** (21+74.92 -L-)	LUMP	LUMP	68,580.06
0004	0050000000-E SUPPLEMENTA RY CLEARING & GRUB-BING	1.000 ACR	8,000.00000	8,000.00
0005	0057000000-E UNDERCUT EXCAVATION	1,000.000 CY	4.00000	4,000.00
0006	0063000000-N GRADING	LUMP	LUMP	815,000.00
0007	0106000000-E BORROW EXCAVATION	43,000.000 CY	1.00000	43,000.00
0008	0195000000-E SELECT GRANULAR MATERIAL	1,000.000 CY	3.00000	3,000.00
0009	0196000000-E GEOTEXTILE FOR SOIL STABILIZA-TION	2,470.000 SY	2.21000	5,458.70
0010	0199000000-E TEMPORARY SHORING	17,660.000 SF	10.00000	176,600.00

State of NC
 Dept of Transportation

Date: 07-20-15
 Revised:

Contract ID: C203565 Project(s): BRSTP-0029(43)
 Letting Date: 08-18-15 Call Order: 006
 Bidder: 9304 - HRI Inc., dba HRI Bridge Company

Line No.	Item Description	Approx. Quantity and Units	Unit Price Dollars Cts	Bid Amount Dollars Ct
0011	0318000000-E FOUNDATION CONDITIONING MATERIAL, MINOR STRUCTURES	437.000 TON	29.60000	12,935.20
0012	0320000000-E FOUNDATION CONDITIONING GEOTEXTILE	2,465.000 SY	3.20000	7,888.00
0013	0335200000-E 15" DRAINAGE PIPE	144.000 LF	38.62000	5,561.28
0014	0366000000-E 15" RC PIPE CULVERTS, CLASS III	324.000 LF	55.10000	17,852.40
0015	0448200000-E 15" RC PIPE CULVERTS, CLASS IV	2,060.000 LF	76.52000	157,631.20
0016	0448300000-E 18" RC PIPE CULVERTS, CLASS IV	4.000 LF	104.81000	419.24
0017	0995000000-E PIPE REMOVAL	483.000 LF	39.55000	19,102.65
0018	1099500000-E SHALLOW UNDERCUT	1,470.000 CY	10.00000	14,700.00
0019	1099700000-E CLASS IV SUBGRADE STABILIZATION	2,646.000 TON	15.00000	39,690.00
0020	1121000000-E AGGREGATE BASE COURSE	1,400.000 TON	33.76000	47,264.00
0021	1220000000-E INCIDENTAL STONE BASE	500.000 TON	31.43000	15,715.00
0022	1330000000-E INCIDENTAL MILLING	640.000 SY	7.25000	4,640.00

State of NC
Dept of Transportation

Date: 07-20-15
Revised:

Contract ID: C203565 Project(s): BRSTP-0029(43)
Letting Date: 08-18-15 Call Order: 006
Bidder: 9304 - HRI Inc., dba HRI Bridge Company

Line No.	Item Description	Approx. Quantity and Units	Unit Price Dollars Cts	Bid Amount Dollars Ct
0023	1491000000-E ASPHALT CONC BASE COURSE, TYPE B25.0C	8,825.000 TON	48.50000	428,012.50
0024	1503000000-E ASPHALT CONC INTERMEDIATE COURSE, TYPE I19.0C	2,300.000 TON	53.00000	121,900.00
0025	1523000000-E ASPHALT CONC SURFACE COURSE, TYPE S9.5C	4,850.000 TON	49.00000	237,650.00
0026	1575000000-E ASPHALT BINDER FOR PLANT MIX	785.000 TON	550.00000	431,750.00
0027	1693000000-E ASPHALT PLANT MIX, PAVEMENT REPAIR	185.000 TON	144.67000	26,763.95
0028	2022000000-E SUBDRAIN EXCAVATION	168.000 CY	30.00000	5,040.00
0029	2033000000-E SUBDRAIN FINE AGGREGATE	84.000 CY	50.00000	4,200.00
0030	2044000000-E 6" PERFORATED SUBDRAIN PIPE	500.000 LF	15.00000	7,500.00
0031	2070000000-N SUBDRAIN PIPE OUTLET	1.000 EA	350.00000	350.00
0032	2077000000-E 6" OUTLET PIPE	6.000 LF	40.00000	240.00
0033	2190000000-N TEMPORARY STEEL PLATE COVERS FOR MASONRY DRAINAGE STRUCTURE	11.000 EA	413.04000	4,543.44

State of NC
 Dept of Transportation

Date: 07-20-15
 Revised:

Contract ID: C203565 Project(s): BRSTP-0029(43)
 Letting Date: 08-18-15 Call Order: 006
 Bidder: 9304 - HRI Inc., dba HRI Bridge Company

Line No.	Item Description	Approx. Quantity and Units	Unit Price Dollars Cts	Bid Amount Dollars Ct
0034	2253000000-E PIPE COLLARS	2.000 CY	1,610.18000	3,220.36
0035	2264000000-E PIPE PLUGS	1.000 CY	1,610.18000	1,610.18
0036	2275000000-E FLOWABLE FILL	35.000 CY	212.09000	7,423.15
0037	2286000000-N MASONRY DRAINAGE STRUCTURES	22.000 EA	2,230.21000	49,064.62
0038	2308000000-E MASONRY DRAINAGE STRUCTURES	15.000 LF	140.89000	2,113.35
0039	2364000000-N FRAME WITH TWO GRATES, STD 840.16	2.000 EA	804.28000	1,608.56
0040	2367000000-N FRAME WITH TWO GRATES, STD 840.29	4.000 EA	802.57000	3,210.28
0041	2374000000-N FRAME WITH GRATE & HOOD, STD 840.03, TYPE ** (F)	10.000 EA	737.77000	7,377.70
0042	2374000000-N FRAME WITH GRATE & HOOD, STD 840.03, TYPE ** (G)	5.000 EA	737.77000	3,688.85
0043	2396000000-N FRAME WITH COVER, STD 840.54	1.000 EA	533.30000	533.30
0044	2440000000-N CONCRETE TRANSITIONAL SECTION FOR CATCH BASIN	3.000 EA	900.00000	2,700.00
0045	2451000000-N CONCRETE TRANSITIONAL SECTION FOR DROP INLET	3.000 EA	900.00000	2,700.00

State of NC
Dept of Transportation

Date: 07-20-15
Revised:

Contract ID: C203565 Project(s): BRSTP-0029(43)
Letting Date: 08-18-15 Call Order: 006
Bidder: 9304 - HRI Inc., dba HRI Bridge Company

Line No.	Item Description	Approx. Quantity and Units	Unit Price Dollars Cts	Bid Amount Dollars Ct
0046	2542000000-E 1'-6" CONCRETE CURB & GUTTER	2,150.000 LF	13.00000	27,950.00
0047	2549000000-E 2'-6" CONCRETE CURB & GUTTER	3,140.000 LF	13.50000	42,390.00
0048	2591000000-E 4" CONCRETE SIDEWALK	1,500.000 SY	27.00000	40,500.00
0049	2605000000-N CONCRETE CURB RAMP	14.000 EA	1,050.00000	14,700.00
0050	2619000000-E 4" CONCRETE PAVED DITCH	25.000 SY	27.00000	675.00
0051	2655000000-E 5" MONOLITHIC CONCRETE ISLANDS (KEYED IN)	660.000 SY	42.00000	27,720.00
0052	2752000000-E GENERIC PAVING ITEM 8" X 6" TEMPORARY ASPHALT CURB	410.000 LF	68.00000	27,880.00
0053	2830000000-N ADJUSTMENT OF MANHOLES	1.000 EA	469.20000	469.20
0054	2845000000-N ADJUSTMENT OF METER BOXES OR VALVE BOXES	11.000 EA	500.00000	5,500.00
0055	2920000000-N CONVERT EXISTING DROP INLET TOCATCH BASIN	4.000 EA	1,005.12000	4,020.48
0056	3030000000-E STEEL BM GUARDRAIL	1,725.000 LF	15.50000	26,737.50
0057	3045000000-E STEEL BM GUARDRAIL, SHOP CURVED	50.000 LF	17.50000	875.00

State of NC
Dept of Transportation

Date: 07-20-15
Revised:

Contract ID: C203565 Project(s): BRSTP-0029(43)
Letting Date: 08-18-15 Call Order: 006
Bidder: 9304 - HRI Inc., dba HRI Bridge Company

Line No.	Item Description	Approx. Quantity and Units	Unit Price Dollars Cts	Bid Amount Dollars Ct
0058	3150000000-N ADDITIONAL GUARDRAIL POSTS	10.000 EA	10.00000	100.00
0059	3195000000-N GUARDRAIL ANCHOR UNITS, TYPE AT-1	1.000 EA	400.00000	400.00
0060	3210000000-N GUARDRAIL ANCHOR UNITS, TYPE CAT-1	4.000 EA	500.00000	2,000.00
0061	3215000000-N GUARDRAIL ANCHOR UNITS, TYPE III	4.000 EA	1,400.00000	5,600.00
0062	3270000000-N GUARDRAIL ANCHOR UNITS, TYPE 350	3.000 EA	1,850.00000	5,550.00
0063	3345000000-E REMOVE & RESET EXISTING GUARD-RAIL	405.000 LF	5.00000	2,025.00
0064	3360000000-E REMOVE EXISTING GUARDRAIL	2,792.000 LF	1.00000	2,792.00
0065	3380000000-E TEMPORARY STEEL BM GUARDRAIL	537.500 LF	9.50000	5,106.25
0066	3387000000-N TEMPORARY GUARDRAIL ANCHOR UNITS, TYPE ***** (CAT-1)	4.000 EA	350.00000	1,400.00
0067	3387000000-N TEMPORARY GUARDRAIL ANCHOR UNITS, TYPE ***** (III)	2.000 EA	850.00000	1,700.00
0068	3387000000-N TEMPORARY GUARDRAIL ANCHOR UNITS, TYPE ***** (W-BEAM)	2.000 EA	500.00000	1,000.00

State of NC
Dept of Transportation

Date: 07-20-15
Revised:

Contract ID: C203565 Project(s): BRSTP-0029(43)
Letting Date: 08-18-15 Call Order: 006
Bidder: 9304 - HRI Inc., dba HRI Bridge Company

Line No.	Item Description	Approx. Quantity and Units	Unit Price Dollars Cts	Bid Amount Dollars Ct
0069	3389100000-N TEMPORARY GUARDRAIL ANCHOR UNITS, TYPE 350	2.000 EA	1,100.00000	2,200.00
0070	3435000000-N GENERIC GUARDRAIL ITEM TEMPORARY IMPACT ATTENUATOR UNIT, TYPE 350	1.000 EA	6,000.00000	6,000.00
0071	3533000000-E CHAIN LINK FENCE, **" FABRIC (72")	66.000 LF	16.50000	1,089.00
0072	3539000000-E METAL LINE POSTS FOR **" CHAINLINK FENCE (72")	5.000 EA	120.00000	600.00
0073	3542000000-E METAL LINE POSTS FOR 48" CHAINLINK FENCE	120.000 EA	52.00000	6,240.00
0074	3545000000-E METAL TERMINAL POSTS FOR **" CHAIN LINK FENCE (72")	6.000 EA	180.00000	1,080.00
0075	3548000000-E METAL TERMINAL POSTS FOR 48" CHAIN LINK FENCE	10.000 EA	140.00000	1,400.00
0076	3575000000-E GENERIC FENCING ITEM DARK GREEN VINYL COATED CHAIN LINK FENCE 48" FABRIC	1,450.000 LF	12.75000	18,487.50
0077	3575000000-E GENERIC FENCING ITEM PEDESTRIAN SAFETY RAIL	270.000 LF	144.50000	39,015.00
0078	3575000000-E GENERIC FENCING ITEM TEMPORARY 72" CHAIN LINK FENCE WITH POSTS	780.000 LF	16.00000	12,480.00
0079	3649000000-E RIP RAP, CLASS B	1.000 TON	52.72000	52.72

State of NC
 Dept of Transportation

Date: 07-20-15
 Revised:

Contract ID: C203565 Project(s): BRSTP-0029(43)
 Letting Date: 08-18-15 Call Order: 006
 Bidder: 9304 - HRI Inc., dba HRI Bridge Company

Line No.	Item Description	Approx. Quantity and Units	Unit Price Dollars Cts	Bid Amount Dollars Ct
0080	3656000000-E GEOTEXTILE FOR DRAINAGE SY	905.000	2.21000	2,000.05
0081	4072000000-E SUPPORTS, 3-LB STEEL U-CHANNEL LF	756.000	4.99000	3,772.44
0082	4096000000-N SIGN ERECTION, TYPE D EA	4.000	75.00000	300.00
0083	4102000000-N SIGN ERECTION, TYPE E EA	18.000	55.00000	990.00
0084	4108000000-N SIGN ERECTION, TYPE F EA	15.000	65.00000	975.00
0085	4116100000-N SIGN ERECTION, RELOCATE, TYPE ***** (GROUND MOUNTED) (D) EA	1.000	185.00000	185.00
0086	4155000000-N DISPOSAL OF SIGN SYSTEM, U-CHANNEL EA	26.000	5.00000	130.00
0087	4400000000-E WORK ZONE SIGNS (STATIONARY) SF	328.000	4.55000	1,492.40
0088	4405000000-E WORK ZONE SIGNS (PORTABLE) SF	320.000	11.81000	3,779.20
0089	4410000000-E WORK ZONE SIGNS (BARRICADE MOUNTED) SF	72.000	16.84000	1,212.48
0090	4415000000-N FLASHING ARROW BOARD EA	1.000	7,801.39000	7,801.39
0091	4420000000-N PORTABLE CHANGEABLE MESSAGE SIGN EA	1.000	18,066.29000	18,066.29

State of NC
Dept of Transportation

Date: 07-20-15
Revised:

Contract ID: C203565 Project(s): BRSTP-0029(43)
Letting Date: 08-18-15 Call Order: 006
Bidder: 9304 - HRI Inc., dba HRI Bridge Company

Line No.	Item Description	Approx. Quantity and Units	Unit Price Dollars Cts	Bid Amount Dollars Ct
0092	4430000000-N DRUMS	200.000 EA	62.02000	12,404.00
0093	4435000000-N CONES	50.000 EA	27.06000	1,353.00
0094	4445000000-E BARRICADES (TYPE III)	88.000 LF	14.00000	1,232.00
0095	4450000000-N FLAGGER	500.000 HR	24.62000	12,310.00
0096	4465000000-N TEMPORARY CRASH CUSHIONS	5.000 EA	7,432.80000	37,164.00
0097	4480000000-N TMA	1.000 EA	48,305.40000	48,305.40
0098	4485000000-E PORTABLE CONCRETE BARRIER	1,600.000 LF	23.20000	37,120.00
0099	4490000000-E PORTABLE CONCRETE BARRIER (ANCHORED)	518.000 LF	35.85000	18,570.30
0100	4510000000-N LAW ENFORCEMENT	48.000 HR	45.00000	2,160.00
0101	4516000000-N SKINNY DRUM	50.000 EA	44.57000	2,228.50
0102	4650000000-N TEMPORARY RAISED PAVEMENT MARKERS	416.000 EA	6.00000	2,496.00
0103	4685000000-E THERMOPLAST IC PAVEMENT MARKING LINES (4", 90 MILS)	166.000 LF	2.50000	415.00

State of NC
Dept of Transportation

Date: 07-20-15
Revised:

Contract ID: C203565

Project(s): BRSTP-0029(43)

Letting Date: 08-18-15 Call Order: 006

Bidder: 9304 - HRI Inc., dba HRI Bridge Company

Line No.	Item Description	Approx. Quantity and Units	Unit Price Dollars Cts	Bid Amount Dollars Ct
0104	4686000000-E THERMOPLAST IC PAVEMENT MARKING LINES (4", 120 MILS)	4,433.000 LF	2.50000	11,082.50
0105	4697000000-E THERMOPLAST IC PAVEMENT MARKING LINES (8", 120 MILS)	1,070.000 LF	4.00000	4,280.00
0106	4710000000-E THERMOPLAST IC PAVEMENT MARKING LINES (24", 120 MILS)	354.000 LF	12.00000	4,248.00
0107	4721000000-E THERMOPLAST IC PAVEMENT MARKING CHARACTER (120 MILS)	4.000 EA	100.00000	400.00
0108	4725000000-E THERMOPLAST IC PAVEMENT MARKING SYMBOL (90 MILS)	21.000 EA	100.00000	2,100.00
0109	4770000000-E COLD APPLIED PLASTIC PAVEMENT MARKING LINES, TYPE ** (4") (II)	1,970.000 LF	1.75000	3,447.50
0110	4770000000-E COLD APPLIED PLASTIC PAVEMENT MARKING LINES, TYPE ** (4") (IV)	2,198.000 LF	1.75000	3,846.50
0111	4780000000-E COLD APPLIED PLASTIC PAVEMENT MARKING LINES, TYPE ** (8") (II)	152.000 LF	3.00000	456.00
0112	4810000000-E PAINT PAVEMENT MARKING LINES (4")	45,371.000 LF	0.35000	15,879.85
0113	4835000000-E PAINT PAVEMENT MARKING LINES (24")	744.000 LF	4.00000	2,976.00
0114	4840000000-N PAINT PAVEMENT MARKING CHARACTER	4.000 EA	35.00000	140.00

State of NC
Dept of Transportation

Date: 07-20-15
Revised:

Contract ID: C203565 Project(s): BRSTP-0029(43)
Letting Date: 08-18-15 Call Order: 006
Bidder: 9304 - HRI Inc., dba HRI Bridge Company

Line No.	Item Description	Approx. Quantity and Units	Unit Price Dollars Cts	Bid Amount Dollars Ct
0115	4845000000-N PAINT PAVEMENT MARKING SYMBOL	77.000 EA	35.00000	2,695.00
0116	4850000000-E REMOVAL OF PAVEMENT MARKING LINES (4")	3,938.000 LF	0.75000	2,953.50
0117	4875000000-N REMOVAL OF PAVEMENT MARKING SYMBOLS & CHARACTERS	6.000 EA	50.00000	300.00
0118	4900000000-N PERMANENT RAISED PAVEMENT MARKERS	23.000 EA	10.00000	230.00
0119	5325800000-E 8" WATER LINE	457.000 LF	175.00000	79,975.00
0120	5327400000-E 24" WATER LINE	1,115.000 LF	365.00000	406,975.00
0121	5546000000-E 8" VALVE	1.000 EA	1,000.00000	1,000.00
0122	5559400000-E 24" VALVE	4.000 EA	17,000.00000	68,000.00
0123	5571600000-E 6" TAPPING VALVE	1.000 EA	3,500.00000	3,500.00
0124	5571800000-E 8" TAPPING VALVE	1.000 EA	4,500.00000	4,500.00
0125	5648000000-N RELOCATE WATER METER	2.000 EA	2,100.00000	4,200.00
0126	5666000000-E FIRE HYDRANT	1.000 EA	5,000.00000	5,000.00

State of NC
 Dept of Transportation

Date: 07-20-15
 Revised:

Contract ID: C203565 Project(s): BRSTP-0029(43)
 Letting Date: 08-18-15 Call Order: 006
 Bidder: 9304 - HRI Inc., dba HRI Bridge Company

Line No.	Item Description	Approx. Quantity and Units	Unit Price Dollars Cts	Bid Amount Dollars Ct
0127	5775000000-E 4' DIA UTILITY MANHOLE	2.000 EA	2,200.00000	4,400.00
0128	5781000000-E UTILITY MANHOLE WALL, 4' DIA	18.000 LF	175.00000	3,150.00
0129	5801000000-E ABANDON 8" UTILITY PIPE	534.000 LF	13.00000	6,942.00
0130	5813000000-E ABANDON 24" UTILITY PIPE	1,070.000 LF	47.00000	50,290.00
0131	5816000000-N ABANDON UTILITY MANHOLE	1.000 EA	1,200.00000	1,200.00
0132	5836400000-E 36" ENCASEMENT PIPE	402.000 LF	260.00000	104,520.00
0133	5872400000-E TRENCHLESS INSTALLATION OF 36" IN SOIL	201.000 LF	330.00000	66,330.00
0134	5872410000-E TRENCHLESS INSTALLATION OF 36" NOT IN SOIL	201.000 LF	1.00000	201.00
0135	5882000000-N GENERIC UTILITY ITEM 3" COMBINATION AIR RELEASE VALVE	1.000 EA	8,500.00000	8,500.00
0136	6000000000-E TEMPORARY SILT FENCE	7,000.000 LF	3.50000	24,500.00
0137	6006000000-E STONE FOR EROSION CONTROL, CLASS A	360.000 TON	52.74000	18,986.40

State of NC
Dept of Transportation

Date: 07-20-15
Revised:

Contract ID: C203565 Project(s): BRSTP-0029(43)
Letting Date: 08-18-15 Call Order: 006
Bidder: 9304 - HRI Inc., dba HRI Bridge Company

Line No.	Item Description	Approx. Quantity and Units	Unit Price Dollars Cts	Bid Amount Dollars Ct
0138	6009000000-E STONE FOR EROSION CONTROL, CLASS B	505.000 TON	52.74000	26,633.70
0139	6012000000-E SEDIMENT CONTROL STONE	540.000 TON	50.24000	27,129.60
0140	6015000000-E TEMPORARY MULCHING	7.500 ACR	1,100.00000	8,250.00
0141	6018000000-E SEED FOR TEMPORARY SEEDING	500.000 LB	1.25000	625.00
0142	6021000000-E FERTILIZER FOR TEMPORARY SEED-ING	2.500 TON	900.00000	2,250.00
0143	6024000000-E TEMPORARY SLOPE DRAINS	500.000 LF	22.85000	11,425.00
0144	6029000000-E SAFETY FENCE	200.000 LF	3.00000	600.00
0145	6030000000-E SILT EXCAVATION	610.000 CY	14.35000	8,753.50
0146	6036000000-E MATTING FOR EROSION CONTROL	2,500.000 SY	2.50000	6,250.00
0147	6042000000-E 1/4" HARDWARE CLOTH	1,225.000 LF	3.50000	4,287.50
0148	6071010000-E WATTLE	75.000 LF	9.00000	675.00
0149	6071020000-E POLYACRYLAMIDE (PAM)	25.000 LB	8.50000	212.50

State of NC
Dept of Transportation

Date: 07-20-15
Revised:

Contract ID: C203565 Project(s): BRSTP-0029(43)
Letting Date: 08-18-15 Call Order: 006
Bidder: 9304 - HRI Inc., dba HRI Bridge Company

Line No.	Item Description	Approx. Quantity and Units	Unit Price Dollars Cts	Bid Amount Dollars Ct
0150	6084000000-E SEEDING & MULCHING	8.000	1,900.00000	15,200.00
		ACR		
0151	6087000000-E MOWING	4.000	125.00000	500.00
		ACR		
0152	6090000000-E SEED FOR REPAIR SEEDING	100.000	3.00000	300.00
		LB		
0153	6093000000-E FERTILIZER FOR REPAIR SEEDING	0.250	975.00000	243.75
		TON		
0154	6096000000-E SEED FOR SUPPLEMENTAL SEEDING	225.000	3.00000	675.00
		LB		
0155	6108000000-E FERTILIZER TOPDRESSING	6.750	975.00000	6,581.25
		TON		
0156	6114500000-N SPECIALIZED HAND MOWING	10.000	95.00000	950.00
		MHR		
0157	6117000000-N RESPONSE FOR EROSION CONTROL	18.000	450.00000	8,100.00
		EA		
0158	6132000000-N GENERIC EROSION CONTROL ITEM CONCRETE WASHOUT STRUCTURE	8.000	2,748.87000	21,990.96
		EA		
0159	7060000000-E SIGNAL CABLE	1,470.000	2.75000	4,042.50
		LF		
0160	7120000000-E VEHICLE SIGNAL HEAD (12", 3 SECTION)	8.000	800.00000	6,400.00
		EA		

Contract ID: C203565 Project(s): BRSTP-0029(43)
 Letting Date: 08-18-15 Call Order: 006
 Bidder: 9304 - HRI Inc., dba HRI Bridge Company

Line No.	Item Description	Approx. Quantity and Units	Unit Price Dollars Cts	Bid Amount Dollars Ct
0161	7132000000-E VEHICLE SIGNAL HEAD (12", 4 SECTION)	3.000 EA	900.00000	2,700.00
0162	7144000000-E VEHICLE SIGNAL HEAD (12", 5 SECTION)	2.000 EA	1,100.00000	2,200.00
0163	7264000000-E MESSENGER CABLE (3/8")	530.000 LF	3.00000	1,590.00
0164	7288000000-E PAVED TRENCHING (***** (1, 2"))	50.000 LF	30.00000	1,500.00
0165	7300000000-E UNPAVED TRENCHING (***** (1, 2"))	790.000 LF	6.00000	4,740.00
0166	7300100000-E UNPAVED TRENCHING FOR TEMP-ORARY LEAD-IN	95.000 LF	2.00000	190.00
0167	7301000000-E DIRECTIONAL DRILL (***** (1, 2"))	155.000 LF	18.00000	2,790.00
0168	7324000000-N JUNCTION BOX (STANDARD SIZE)	16.000 EA	300.00000	4,800.00
0169	7360000000-N WOOD POLE	7.000 EA	900.00000	6,300.00
0170	7372000000-N GUY ASSEMBLY	10.000 EA	350.00000	3,500.00
0171	7408000000-E 1" RISER WITH WEATHERHEAD	1.000 EA	400.00000	400.00
0172	7420000000-E 2" RISER WITH WEATHERHEAD	3.000 EA	450.00000	1,350.00

Contract ID: C203565 Project(s): BRSTP-0029(43)
Letting Date: 08-18-15 Call Order: 006
Bidder: 9304 - HRI Inc., dba HRI Bridge Company

Line No.	Item Description	Approx. Quantity and Units	Unit Price Dollars Cts	Bid Amount Dollars Ct
0173	7444000000-E INDUCTIVE LOOP SAWCUT	2,265.000 LF	6.50000	14,722.50
0174	7456000000-E LEAD-IN CABLE (*****)(14-2)	7,635.000 LF	1.25000	9,543.75
0175	7636000000-N SIGN FOR SIGNALS	4.000 EA	300.00000	1,200.00
0176	7684000000-N SIGNAL CABINET FOUNDATION	1.000 EA	600.00000	600.00
0177	7756000000-N CONTROLLER WITH CABINET (TYPE 2070L, BASE MOUNTED)	1.000 EA	11,000.00000	11,000.00
0178	7780000000-N DETECTOR CARD (TYPE 2070L)	9.000 EA	100.00000	900.00
0179	7901000000-N CABINET BASE EXTENDER	1.000 EA	400.00000	400.00
0180	7980000000-N GENERIC SIGNAL ITEM MICROWAVE VEHICLE DETECTOR- SINGLE ZONE	4.000 EA	800.00000	3,200.00
Section 0001 Total				5,300,340.83

Section 0003 WALL ITEMS

Alt Group

0181	8801000000-E MSE RETAINING WALL NO *****(1)	930.000 SF	67.17000	62,468.10
------	---	------------	----------	-----------

Contract ID: C203565 Project(s): BRSTP-0029(43)
Letting Date: 08-18-15 Call Order: 006
Bidder: 9304 - HRI Inc., dba HRI Bridge Company

Line No.	Item Description	Approx. Quantity and Units	Unit Price Dollars Cts	Bid Amount Dollars Ct
0182	8801000000-E MSE RETAINING WALL NO **** (2, 4 & END BENT 2 ABUTMENT)	22,750.000 SF	85.17000	1,937,617.50
0183	8801000000-E MSE RETAINING WALL NO **** (3)	995.000 SF	75.54000	75,162.30
0184	8801000000-E MSE RETAINING WALL NO **** (5)	5,460.000 SF	59.69000	325,907.40
Section 0003 Total				2,401,155.30

Section 0004 STRUCTURE ITEMS

Alt Group

0185	8007000000-N CONSTRUCTIO N, MAINTENANCE, & REMOVAL OF TEMP STRUCTURE AT STA ***** (21+74.92-L-)	LUMP	LUMP	688,128.69
0186	8042000000-N REMOVAL OF EXISTING STRUCTURES AT STATION ***** (21+74.92-L-)	LUMP	LUMP	240,869.68
0187	8091000000-N FOUNDATION EXCAVATION FOR BENT** AT STATION ***** (1,21+74.92-L-)	LUMP	LUMP	21,779.52
0188	8091000000-N FOUNDATION EXCAVATION FOR BENT** AT STATION ***** (2,21+74.92-L-)	LUMP	LUMP	21,779.52
0189	8112730000-N PDA TESTING	1.000 EA	2,500.00000	2,500.00

State of NC
Dept of Transportation

Date: 07-20-15
Revised:

Contract ID: C203565 Project(s): BRSTP-0029(43)
Letting Date: 08-18-15 Call Order: 006
Bidder: 9304 - HRI Inc., dba HRI Bridge Company

Line No.	Item Description	Approx. Quantity and Units	Unit Price Dollars Cts	Bid Amount Dollars Ct
0190	8121000000-N UNCLASSIFIED STRUCTURE EXCAVATION AT STATION ***** (21+74.92-L-)	LUMP	LUMP	148,521.68
0191	8147000000-E REINFORCED CONCRETE DECK SLAB	29,220.000 SF	39.66000	1,158,865.20
0192	8161000000-E GROOVING BRIDGE FLOORS	29,382.000 SF	0.54000	15,866.28
0193	8182000000-E CLASS A CONCRETE (BRIDGE)	640.800 CY	967.64000	620,063.71
0194	8210000000-N BRIDGE APPROACH SLABS, STATION***** (21+74.92-L-)	LUMP	LUMP	106,005.80
0195	8217000000-E REINFORCING STEEL (BRIDGE)	101,903.000 LB	0.95000	96,807.85
0196	8238000000-E SPIRAL COLUMN REINFORCING STEEL (BRIDGE)	9,553.000 LB	2.51000	23,978.03
0197	8262000000-E 45" PRESTRESSED CONCRETE GIRDERS	1,544.000 LF	271.24000	418,794.56
0198	8280000000-E APPROX ***** LBS STRUCTURALSTEEL	LUMP	LUMP	919,861.40
0199	8364000000-E HP12X53 STEEL PILES	2,785.000 LF	48.67000	135,545.95
0200	8384000000-E HP14X73 STEEL PILES	3,360.000 LF	58.41000	196,257.60

Contract ID: C203565 Project(s): BRSTP-0029(43)
 Letting Date: 08-18-15 Call Order: 006
 Bidder: 9304 - HRI Inc., dba HRI Bridge Company

Line No.	Item Description	Approx. Quantity and Units	Unit Price Dollars Cts	Bid Amount Dollars Ct
0201	8531000000-E 4" SLOPE PROTECTION	900.000 SY	111.97000	100,773.00
0202	8657000000-N ELASTOMERIC BEARINGS	LUMP	LUMP	24,588.69
0203	8706000000-N EXPANSION JOINT SEALS	LUMP	LUMP	171,558.93
0204	8867000000-E GENERIC STRUCTURE ITEM CLASSIC CONC BRIDGE RAIL	506.700 LF	268.25000	135,922.28
	Section 0004 Total			5,248,468.37
	Bid Total			12,949,964.50

NON-COLLUSION AND DEBARMENT CERTIFICATION

The bidder certifies that neither he, nor any official, agent or employee of the bidder has entered into any agreement, participated in any collusion, or otherwise taken any action which is in restraint of free competitive bidding in connection with this bid, and that the bidder intends to do the work with its own bonafide employees or subcontractors and is not bidding for the benefit of another contractor. In addition, submitting this electronic bid constitutes the bidder's certification of Status under penalty of perjury under the laws of the United States and in accordance with the Debarment Certification on file with the Department.

By submitting this bid, the bidder certifies to the best of his knowledge and belief that he and his principals:

- a. Are not presently debarred, suspended, proposed for debarment, declared ineligible, or voluntarily excluded from covered transactions by any Federal department or agency;
- b. Have not within a three-year period preceding this proposal been convicted of or had a civil judgment rendered against them for commission of fraud or a criminal offense in connection with obtaining, attempting to obtain, or performing a public (Federal, State or local) transaction or contract under a public transaction; violation of Federal or State antitrust statutes or commission of embezzlement, theft, forgery, bribery, falsification or destruction of records; making false statements; or receiving stolen property;
- c. Are not presently indicted for or otherwise criminally or civilly charged by a governmental entity (Federal, State or local) with commission of any of the offenses enumerated in paragraph b. of this certification; and
- d. Have not within a three-year period preceding this proposal had one or more public transactions (Federal, State or local) terminated for cause or default.

Where the prospective bidder is unable to certify to any of the statements in this certification, the bidder shall submit an explanation in the blanks provided herein. The explanation will not necessarily result in denial of participation in a contract.

Explanation:
NOT ANSWERED
NOT ANSWERED
NOT ANSWERED
NOT ANSWERED

If the prequalified bidder's status changes, he shall immediately submit a new fully executed non-collusion affidavit and debarment certification with an explanation of the change to the Contract Office prior to submitting the bid.

Failure to furnish a certification or an explanation will be grounds for rejection of a bid

AWARD LIMITS ON MULTIPLE PROJECTS

By answering YES to this statement, the bidder acknowledges that they are using the award limits on multiple projects. No

A bidder who desires to bid on more than one project on which bids are to be opened on the same date, and who also desires to avoid receiving an award of more projects than he is equipped to handle, may bid on any number of projects but may limit the total amount of work awarded to him on selected projects by completing the AWARD LIMITS ON MULTIPLE PROJECTS.

The Award Limits on Multiple Projects must be filled in on each project bid for which the Bidder desires protection.

It is the desire of the Bidder to be awarded contracts, the value of which will not exceed a total of NOT ANSWERED for those projects indicated herein, for which bids will be opened on (MM/DD/YY)

The Award Limits shall apply to the following projects:

Contract Number	County
NOT ANSWERED	
NOT ANSWERED	
NOT ANSWERED	
NOT ANSWERED	
NOT ANSWERED	
NOT ANSWERED	

It is agreed that if I am (we are) the low Bidder(s) on indicated projects, the total value of which is more than the above stipulated award limits, the Board of Transportation will award me (us) projects from among those indicated that have a total value not to exceed the award limit and will result in the lowest total bids to the Department of Transportation.

PROPOSAL: C203565
 LETTING: L150818 CALL: 006
 VENDOR: 9304 HRI Inc., dba HRI Bridge Company

LINE NO.	ITEM NO.	ITEM DESC.	UNIT TYPE	SUBCONTRACTOR QUANTITY	SUBCONTRACTOR UNIT PRICE	EXTENDED AMOUNT	
DBE SUBCONTRACTOR: 4898 BULLINGTON CONSTRUCTION INC							
Will Use Quote: Yes							
0071	3533000000-E	CHN LK FENCE	LF	66.000	16.50000	1089.00	
0072	3539000000-E	MET LINE PST	EA	5.000	120.00000	600.00	
0073	3542000000-E	MET LINE PST	EA	120.000	52.00000	6240.00	
0074	3545000000-E	MET TERM PST	EA	6.000	180.00000	1080.00	
0075	3548000000-E	MET TERM PST	EA	10.000	140.00000	1400.00	
0076	3575000000-E	GENERIC FENC	LF	1450.000	12.75000	18487.50	
0077	3575000000-E	GENERIC FENC	LF	270.000	144.50000	39015.00	
0078	3575000000-E	GENERIC FENC	LF	780.000	16.00000	12480.00	
0028	2022000000-E	SUBDRAIN EXC	CY	168.000	30.00000	5040.00	ARM
0029	2033000000-E	SUBDRAIN FIN	CY	84.000	50.00000	4200.00	ARM
0030	2044000000-E	6" PERF SUBD	LF	500.000	15.00000	7500.00	ARM
0031	2070000000-N	SUBDRN PIPE	EA	1.000	350.00000	350.00	ARM
0032	2077000000-E	6" OUTLET PI	LF	6.000	40.00000	240.00	ARM
DBE COMMITMENT TOTAL FOR SUBCONTRACTOR:					80,391.50	97,721.50	Committed
DBE COMMITMENT TOTAL FOR VENDOR (SubContractor)						ARM	97,721.50 ARM

DBE SUBCONTRACTOR: 3080 CURTIN TRUCKING & DRAINAGE, INC.
 Will Use Quote: Yes

0096	4465000000-N	TEMPORARY CR	EA	5.000	5500.00000	27500.00	
Partial							
0098	4485000000-E	PORT CONC BA	LF	1600.000	23.20000	37120.00	
0099	4490000000-E	PORT CONC BA	LF	518.000	35.85000	18570.30	
DBE COMMITMENT TOTAL FOR SUBCONTRACTOR:					83,190.30		Committed
DBE COMMITMENT TOTAL FOR VENDOR (SubContractor)							83,190.

DBE SUBCONTRACTOR: 11402 FLORENCE CONCRETE PRODUCTS, INC.
 Will Use Quote: Yes

0197	8262000000-E	45" PRESTR C	LF	1544.000	111.33000	171893.52	
Furnish Beams							
DBE COMMITMENT TOTAL FOR SUBCONTRACTOR:					171,893.52		Committed
DBE COMMITMENT TOTAL FOR VENDOR (Manufacturer)							171,893

DBE SUBCONTRACTOR: 3230 HIATT & MASON ENTERPRISES INC
 Will Use Quote: Yes

0191	8147000000-E	REINF CONCRE	SF	29220.000	0.92000	26882.40	
SIP Form Installation							

LINE NO.	ITEM NO.	ITEM DESC.	UNIT TYPE	SUBCONTRACTOR QUANTITY	SUBCONTRACTOR UNIT PRICE	EXTENDED AMOUNT
----------	----------	------------	-----------	------------------------	--------------------------	-----------------

DBE COMMITMENT TOTAL FOR SUBCONTRACTOR: 26,882.40 Committed
 DBE COMMITMENT TOTAL FOR VENDOR (SubContractor) 26,882.

DBE SUBCONTRACTOR: 5653 BORDER REBAR, LLC
 Will Use Quote: Yes

0191	8147000000-E	REINF CONCRE SF		21467.000	1.90000	40787.30
		Install Rebar				
0194	8210000000-N	BRG APPR SLA LS		1.000	6132.00000	6132.00
		Install Rebar			0.1600	16,304.48
0195	8217000000-E	REINF STEEL LB		101903.000	0.01600 ARM	1630.45 ARM
0196	8238000000-E	SPIRAL COL R LB		9553.000	0.16000	1528.48
		Rebar Install				

DBE COMMITMENT TOTAL FOR SUBCONTRACTOR: 64,752.26 ~~50,078.23~~ Committed
 DBE COMMITMENT TOTAL FOR VENDOR (SubContractor) ARM ~~50,078.~~ ARM

DBE SUBCONTRACTOR: 5640 ALL POINTS TRUCKING
 Will Use Quote: Yes

0006	0063000000-N	GRADING	LS	1.000	349000.00000	349000.00
		Hauling				
0182	8801000000-E	MSE RETAIN W SF		22750.000	9.45000	214987.50
		Haul Aggregates				
0190	8121000000-N	UNCL STR EXC LS		1.000	24358.00000	24358.00
		Hauling				

DBE COMMITMENT TOTAL FOR SUBCONTRACTOR: 588,345.50 Committed
 DBE COMMITMENT TOTAL FOR VENDOR (SubContractor) 588,345

DBE SUBCONTRACTOR: 3376 REYNOLDS FENCE & GUARDRAIL INC
 Will Use Quote: Yes

0056	3030000000-E	STL BM GUARD LF		1725.000	15.50000	26737.50
0057	3045000000-E	SBGR SHOP CU LF		50.000	17.50000	875.00
0058	3150000000-N	ADDIT GUARDR EA		10.000	10.00000	100.00
0059	3195000000-N	GR ANCHOR TY EA		1.000	400.00000	400.00
0060	3210000000-N	GR ANCHOR TY EA		4.000	500.00000	2000.00
0061	3215000000-N	GR ANCHOR TY EA		4.000	1400.00000	5600.00
0062	3270000000-N	GR ANCHOR TY EA		3.000	1850.00000	5550.00
0063	3345000000-E	REMOVE & RES LF		405.000	5.00000	2025.00
0064	3360000000-E	REMOVE EXIST LF		2792.000	1.00000	2792.00
0065	3380000000-E	TEMP STL BM LF		537.500	9.50000	5106.25
0066	3387000000-N	TEMP GDRL AN EA		4.000	350.00000	1400.00
0067	3387000000-N	TEMP GDRL AN EA		2.000	850.00000	1700.00
0068	3387000000-N	TEMP GDRL AN EA		2.000	500.00000	1000.00
0069	3389100000-N	TEMP GDRL AN EA		2.000	1100.00000	2200.00
0070	3435000000-N	GENERIC GUAR EA		1.000	6000.00000	6000.00

NORTH CAROLINA STATE DEPARTMENT OF TRANSPORTATION
DBE COMMITMENT ITEMS

DATE:07-20-15
PAGE: 24

LINE NO.	ITEM NO.	ITEM DESC.	UNIT TYPE	SUBCONTRACTOR QUANTITY	SUBCONTRACTOR UNIT PRICE	EXTENDED AMOUNT
DBE COMMITMENT TOTAL FOR SUBCONTRACTOR:						63,485.75 Committed
DBE COMMITMENT TOTAL FOR VENDOR (SubContractor)						63,485.
DBE SUBCONTRACTOR: 12278 CLIFTON CONSTRUCTION CO., INC. Will Use Quote: Yes						
0028	2022000000-E	SUBDRAIN EXC	CY	168.000	30.00000	5040.00
0030	2044000000-E	6" PERF SUBD	LF	500.000	15.00000	7500.00
0031	2070000000-N	SUBDRN PIPE	EA	1.000	350.00000	350.00
0032	2077000000-E	6" OUTLET PI	LF	6.000	40.00000	240.00
0029	2033000000-E	SUBDRAIN FIN	CY	84.000	50.00000	4200.00
DBE COMMITMENT TOTAL FOR SUBCONTRACTOR:						17,330.00 Committed
DBE COMMITMENT TOTAL FOR VENDOR (SubContractor)						17,330.
DBE SUBCONTRACTOR: 12289 SMITH JAMISON DBA SMITH JAMISON Will Use Quote: Yes						
0044	2440000000-N	CONC TRANS S	EA	3.000	900.00000	2700.00
0045	2451000000-N	CONC TRANS S	EA	3.000	900.00000	2700.00
0046	2542000000-E	1'-6" CONC C	LF	2150.000	13.00000	27950.00
0047	2549000000-E	2'-6" CONC C	LF	3140.000	13.50000	42390.00
0048	2591000000-E	4" CONCRETE	SY	1500.000	27.00000	40500.00
0049	2605000000-N	CONCRETE CUR	EA	14.000	1050.00000	14700.00
0050	2619000000-E	4" CONCRETE	SY	25.000	27.00000	675.00
0051	2655000000-E	5" MONO CONC	SY	660.000	42.00000	27720.00
DBE COMMITMENT TOTAL FOR SUBCONTRACTOR:						159,335.00 Committed
DBE COMMITMENT TOTAL FOR VENDOR (SubContractor)						159,335
DBE SUBCONTRACTOR: 3765 STAY ALERT SAFETY SERVICES INC Will Use Quote: Yes						
0081	4072000000-E	SUPPORT, 3-L	LF	756.000	4.99000	3772.44
0082	4096000000-N	SIGN ERECTIO	EA	4.000	75.00000	300.00
0083	4102000000-N	SIGN ERECTIO	EA	18.000	55.00000	990.00
0084	4108000000-N	SIGN ERECTIO	EA	15.000	65.00000	975.00
0085	4116100000-N	SIGN ERECT,	EA	1.000	185.00000	185.00
0086	4155000000-N	DISPOSE SIGN	EA	26.000	5.00000	130.00
0087	4400000000-E	WORK ZONE SI	SF	328.000	4.55000	1492.40
0089	4410000000-E	WORK ZONE SI	SF	72.000	5.05000	363.60
0097	4480000000-N	TMA	EA	1.000	37000.00000	37000.00
0094	4445000000-E	BARRICADES (LF	88.000	14.00000	1232.00
DBE COMMITMENT TOTAL FOR SUBCONTRACTOR:						46,440.44 Committed
DBE COMMITMENT TOTAL FOR VENDOR (SubContractor)						46,440.

TOTAL DBE COMMITMENT FOR VENDOR:

ARM 10.05%
Entered: ~~10.07%~~ or ~~1304702.64~~ 1,302,046.67
Required: 10.00% or 1294996.45 ARM
<GOAL MET>

THIS PROPOSAL CONTAINS THE FOLLOWING ERRORS/WARNINGS (IF ANY)

- Item Warning : item 2022000000-E (Line# 0028) quantity overcommitted by DBE'
- Item Warning : item 2033000000-E (Line# 0029) quantity overcommitted by DBE'
- Item Warning : item 2044000000-E (Line# 0030) quantity overcommitted by DBE'
- Item Warning : item 2070000000-N (Line# 0031) quantity overcommitted by DBE'
- Item Warning : item 2077000000-E (Line# 0032) quantity overcommitted by DBE'
- Item Warning : item 8147000000-E (Line# 0191) quantity overcommitted by DBE'

This Bid contains 0 amendment files

Electronic Bid Submission

By submitting this bid electronically, I hereby acknowledge that all requirements included in the hard copy proposal, addendum, amendments, plans, standard specifications, supplemental specifications and special provisions are part of the bid and contract. Further, I acknowledge that I have read, understand, accept, acknowledge and agree to comply with all statements in this electronic bid.

I Hereby certify that I have the authority to submit this bid.

Signature

Agency

Date

Line #	ItemNumber	Sec #	Description	Quantity Unit	Unit Bid Price	Amount Bid
ROADWAY ITEMS						
0001	0000100000-N	800	MOBILIZATION	Lump Sum LS	625,000.00	625,000.00
0002	0000400000-N	801	CONSTRUCTION SURVEYING	Lump Sum LS	150,000.00	150,000.00
0003	0029000000-N	SP	REINFORCED BRIDGE APPROACH FILL, STATION ***** (21+74.92 -L-)	Lump Sum LS	68,580.06	68,580.06
0004	0050000000-E	226	SUPPLEMENTARY CLEARING & GRUB- BING	1 ACR	8,000.00	8,000.00
0005	0057000000-E	226	UNDERCUT EXCAVATION	1,000 CY	4.00	4,000.00
0006	0063000000-N	SP	GRADING	Lump Sum LS	815,000.00	815,000.00
0007	0106000000-E	230	BORROW EXCAVATION	43,000 CY	1.00	43,000.00
0008	0195000000-E	265	SELECT GRANULAR MATERIAL	1,000 CY	3.00	3,000.00
0009	0196000000-E	270	GEOTEXTILE FOR SOIL STABILIZA- TION	2,470 SY	2.21	5,458.70
0010	0199000000-E	SP	TEMPORARY SHORING	17,660 SF	10.00	176,600.00
0011	0318000000-E	300	FOUNDATION CONDITIONING MATE- RIAL, MINOR STRUCTURES	437 TON	29.60	12,935.20
0012	0320000000-E	300	FOUNDATION CONDITIONING GEO- TEXTILE	2,465 SY	3.20	7,888.00
0013	0335200000-E	305	15" DRAINAGE PIPE	144 LF	38.62	5,561.28
0014	0366000000-E	310	15" RC PIPE CULVERTS, CLASS III	324 LF	55.10	17,852.40
0015	0448200000-E	310	15" RC PIPE CULVERTS, CLASS IV	2,060 LF	76.52	157,631.20
0016	0448300000-E	310	18" RC PIPE CULVERTS, CLASS IV	4 LF	104.81	419.24
0017	0995000000-E	340	PIPE REMOVAL	483 LF	39.55	19,102.65
0018	1099500000-E	505	SHALLOW UNDERCUT	1,470 CY	10.00	14,700.00
0019	1099700000-E	505	CLASS IV SUBGRADE STABILIZA- TION	2,646 TON	15.00	39,690.00

Line #	ItemNumber	Sec #	Description	Quantity Unit	Unit Bid Price	Amount Bid
0020	1121000000-E	520	AGGREGATE BASE COURSE	1,400 TON	33.76	47,264.00
0021	1220000000-E	545	INCIDENTAL STONE BASE	500 TON	31.43	15,715.00
0022	1330000000-E	607	INCIDENTAL MILLING	640 SY	7.25	4,640.00
0023	1491000000-E	610	ASPHALT CONC BASE COURSE, TYPE B25.0C	8,825 TON	48.50	428,012.50
0024	1503000000-E	610	ASPHALT CONC INTERMEDIATE COURSE, TYPE I19.0C	2,300 TON	53.00	121,900.00
0025	1523000000-E	610	ASPHALT CONC SURFACE COURSE, TYPE S9.5C	4,850 TON	49.00	237,650.00
0026	1575000000-E	620	ASPHALT BINDER FOR PLANT MIX	785 TON	550.00	431,750.00
0027	1693000000-E	654	ASPHALT PLANT MIX, PAVEMENT REPAIR	185 TON	144.67	26,763.95
0028	2022000000-E	815	SUBDRAIN EXCAVATION	168 CY	30.00	5,040.00
0029	2033000000-E	815	SUBDRAIN FINE AGGREGATE	84 CY	50.00	4,200.00
0030	2044000000-E	815	6" PERFORATED SUBDRAIN PIPE	500 LF	15.00	7,500.00
0031	2070000000-N	815	SUBDRAIN PIPE OUTLET	1 EA	350.00	350.00
0032	2077000000-E	815	6" OUTLET PIPE	6 LF	40.00	240.00
0033	2190000000-N	828	TEMPORARY STEEL PLATE COVERS FOR MASONRY DRAINAGE STRUCTURE	11 EA	413.04	4,543.44
0034	2253000000-E	840	PIPE COLLARS	2 CY	1,610.18	3,220.36
0035	2264000000-E	840	PIPE PLUGS	1 CY	1,610.18	1,610.18
0036	2275000000-E	SP	FLOWABLE FILL	35 CY	212.09	7,423.15
0037	2286000000-N	840	MASONRY DRAINAGE STRUCTURES	22 EA	2,230.21	49,064.62
0038	2308000000-E	840	MASONRY DRAINAGE STRUCTURES	15 LF	140.89	2,113.35

Line #	ItemNumber	Sec #	Description	Quantity Unit	Unit Bid Price	Amount Bid
0039	2364000000-N	840	FRAME WITH TWO GRATES, STD 840.16	2 EA	804.28	1,608.56
0040	2367000000-N	840	FRAME WITH TWO GRATES, STD 840.29	4 EA	802.57	3,210.28
0041	2374000000-N	840	FRAME WITH GRATE & HOOD, STD 840.03, TYPE ** (F)	10 EA	737.77	7,377.70
0042	2374000000-N	840	FRAME WITH GRATE & HOOD, STD 840.03, TYPE ** (G)	5 EA	737.77	3,688.85
0043	2396000000-N	840	FRAME WITH COVER, STD 840.54	1 EA	533.30	533.30
0044	2440000000-N	852	CONCRETE TRANSITIONAL SECTION FOR CATCH BASIN	3 EA	900.00	2,700.00
0045	2451000000-N	852	CONCRETE TRANSITIONAL SECTION FOR DROP INLET	3 EA	900.00	2,700.00
0046	2542000000-E	846	1'-6" CONCRETE CURB & GUTTER	2,150 LF	13.00	27,950.00
0047	2549000000-E	846	2'-6" CONCRETE CURB & GUTTER	3,140 LF	13.50	42,390.00
0048	2591000000-E	848	4" CONCRETE SIDEWALK	1,500 SY	27.00	40,500.00
0049	2605000000-N	848	CONCRETE CURB RAMP	14 EA	1,050.00	14,700.00
0050	2619000000-E	850	4" CONCRETE PAVED DITCH	25 SY	27.00	675.00
0051	2655000000-E	852	5" MONOLITHIC CONCRETE ISLANDS (KEYED IN)	660 SY	42.00	27,720.00
0052	2752000000-E	SP	GENERIC PAVING ITEM 8" X 6" TEMPORARY ASPHALT CURB	410 LF	68.00	27,880.00
0053	2830000000-N	858	ADJUSTMENT OF MANHOLES	1 EA	469.20	469.20
0054	2845000000-N	858	ADJUSTMENT OF METER BOXES OR VALVE BOXES	11 EA	500.00	5,500.00
0055	2920000000-N	859	CONVERT EXISTING DROP INLET TO CATCH BASIN	4 EA	1,005.12	4,020.48
0056	3030000000-E	862	STEEL BM GUARDRAIL	1,725 LF	15.50	26,737.50

Line #	ItemNumber	Sec #	Description	Quantity Unit	Unit Bid Price	Amount Bid
0057	3045000000-E	862	STEEL BM GUARDRAIL, SHOP CURVED	50 LF	17.50	875.00
0058	3150000000-N	862	ADDITIONAL GUARDRAIL POSTS	10 EA	10.00	100.00
0059	3195000000-N	862	GUARDRAIL ANCHOR UNITS, TYPE AT-1	1 EA	400.00	400.00
0060	3210000000-N	862	GUARDRAIL ANCHOR UNITS, TYPE CAT-1	4 EA	500.00	2,000.00
0061	3215000000-N	862	GUARDRAIL ANCHOR UNITS, TYPE III	4 EA	1,400.00	5,600.00
0062	3270000000-N	SP	GUARDRAIL ANCHOR UNITS, TYPE 350	3 EA	1,850.00	5,550.00
0063	3345000000-E	864	REMOVE & RESET EXISTING GUARDRAIL	405 LF	5.00	2,025.00
0064	3360000000-E	863	REMOVE EXISTING GUARDRAIL	2,792 LF	1.00	2,792.00
0065	3380000000-E	862	TEMPORARY STEEL BM GUARDRAIL	537.5 LF	9.50	5,106.25
0066	3387000000-N	862	TEMPORARY GUARDRAIL ANCHOR UNITS, TYPE ***** (CAT-1)	4 EA	350.00	1,400.00
0067	3387000000-N	862	TEMPORARY GUARDRAIL ANCHOR UNITS, TYPE ***** (III)	2 EA	850.00	1,700.00
0068	3387000000-N	862	TEMPORARY GUARDRAIL ANCHOR UNITS, TYPE ***** (W-BEAM)	2 EA	500.00	1,000.00
0069	3389100000-N	SP	TEMPORARY GUARDRAIL ANCHOR UNITS, TYPE 350	2 EA	1,100.00	2,200.00
0070	3435000000-N	SP	GENERIC GUARDRAIL ITEM TEMPORARY IMPACT ATTENUATOR UNIT, TYPE 350	1 EA	6,000.00	6,000.00
0071	3533000000-E	866	CHAIN LINK FENCE, *** FABRIC (72")	66 LF	16.50	1,089.00
0072	3539000000-E	866	METAL LINE POSTS FOR **** CHAIN LINK FENCE (72")	5 EA	120.00	600.00

Line #	ItemNumber	Sec #	Description	Quantity Unit	Unit Bid Price	Amount Bid
0073	3542000000-E	866	METAL LINE POSTS FOR 48" CHAIN LINK FENCE	120 EA	52.00	6,240.00
0074	3545000000-E	866	METAL TERMINAL POSTS FOR *** CHAIN LINK FENCE (72")	6 EA	180.00	1,080.00
0075	3548000000-E	866	METAL TERMINAL POSTS FOR 48" CHAIN LINK FENCE	10 EA	140.00	1,400.00
0076	3575000000-E	SP	GENERIC FENCING ITEM DARK GREEN VINYL COATED CHAIN LINK FENCE 48" FABRIC	1,450 LF	12.75	18,487.50
0077	3575000000-E	SP	GENERIC FENCING ITEM PEDESTRIAN SAFETY RAIL	270 LF	144.50	39,015.00
0078	3575000000-E	SP	GENERIC FENCING ITEM TEMPORARY 72" CHAIN LINK FENCE WITH POSTS	780 LF	16.00	12,480.00
0079	3649000000-E	876	RIP RAP, CLASS B	1 TON	52.72	52.72
0080	3656000000-E	876	GEOTEXTILE FOR DRAINAGE	905 SY	2.21	2,000.05
0081	4072000000-E	903	SUPPORTS, 3-LB STEEL U-CHANNEL	756 LF	4.99	3,772.44
0082	4096000000-N	904	SIGN ERECTION, TYPE D	4 EA	75.00	300.00
0083	4102000000-N	904	SIGN ERECTION, TYPE E	18 EA	55.00	990.00
0084	4108000000-N	904	SIGN ERECTION, TYPE F	15 EA	65.00	975.00
0085	4116100000-N	904	SIGN ERECTION, RELOCATE, TYPE **** (GROUND MOUNTED) (D)	1 EA	185.00	185.00
0086	4155000000-N	907	DISPOSAL OF SIGN SYSTEM, U-CHANNEL	26 EA	5.00	130.00
0087	4400000000-E	1110	WORK ZONE SIGNS (STATIONARY)	328 SF	4.55	1,492.40
0088	4405000000-E	1110	WORK ZONE SIGNS (PORTABLE)	320 SF	11.81	3,779.20
0089	4410000000-E	1110	WORK ZONE SIGNS (BARRICADE MOUNTED)	72 SF	16.84	1,212.48
0090	4415000000-N	1115	FLASHING ARROW BOARD	1 EA	7,801.39	7,801.39

Line #	ItemNumber	Sec #	Description	Quantity Unit	Unit Bid Price	Amount Bid
0091	4420000000-N	1120	PORTABLE CHANGEABLE MESSAGE SIGN	1 EA	18,066.29	18,066.29
0092	4430000000-N	1130	DRUMS	200 EA	62.02	12,404.00
0093	4435000000-N	1135	CONES	50 EA	27.06	1,353.00
0094	4445000000-E	1145	BARRICADES (TYPE III)	88 LF	14.00	1,232.00
0095	4450000000-N	1150	FLAGGER	500 HR	24.62	12,310.00
0096	4465000000-N	1160	TEMPORARY CRASH CUSHIONS	5 EA	7,432.80	37,164.00
0097	4480000000-N	1165	TMA	1 EA	48,305.40	48,305.40
0098	4485000000-E	1170	PORTABLE CONCRETE BARRIER	1,600 LF	23.20	37,120.00
0099	4490000000-E	1170	PORTABLE CONCRETE BARRIER (ANCHORED)	518 LF	35.85	18,570.30
0100	4510000000-N	SP	LAW ENFORCEMENT	48 HR	45.00	2,160.00
0101	4516000000-N	1180	SKINNY DRUM	50 EA	44.57	2,228.50
0102	4650000000-N	1251	TEMPORARY RAISED PAVEMENT MARKERS	416 EA	6.00	2,496.00
0103	4685000000-E	1205	THERMOPLASTIC PAVEMENT MARKING LINES (4", 90 MILS)	166 LF	2.50	415.00
0104	4686000000-E	1205	THERMOPLASTIC PAVEMENT MARKING LINES (4", 120 MILS)	4,433 LF	2.50	11,082.50
0105	4697000000-E	1205	THERMOPLASTIC PAVEMENT MARKING LINES (8", 120 MILS)	1,070 LF	4.00	4,280.00
0106	4710000000-E	1205	THERMOPLASTIC PAVEMENT MARKING LINES (24", 120 MILS)	354 LF	12.00	4,248.00
0107	4721000000-E	1205	THERMOPLASTIC PAVEMENT MARKING CHARACTER (120 MILS)	4 EA	100.00	400.00
0108	4725000000-E	1205	THERMOPLASTIC PAVEMENT MARKING SYMBOL (90 MILS)	21 EA	100.00	2,100.00

Line #	ItemNumber	Sec #	Description	Quantity Unit	Unit Bid Price	Amount Bid
0109	4770000000-E	1205	COLD APPLIED PLASTIC PAVEMENT MARKING LINES, TYPE ** (4") (II)	1,970 LF	1.75	3,447.50
0110	4770000000-E	1205	COLD APPLIED PLASTIC PAVEMENT MARKING LINES, TYPE ** (4") (IV)	2,198 LF	1.75	3,846.50
0111	4780000000-E	1205	COLD APPLIED PLASTIC PAVEMENT MARKING LINES, TYPE ** (8") (II)	152 LF	3.00	456.00
0112	4810000000-E	1205	PAINT PAVEMENT MARKING LINES (4")	45,371 LF	0.35	15,879.85
0113	4835000000-E	1205	PAINT PAVEMENT MARKING LINES (24")	744 LF	4.00	2,976.00
0114	4840000000-N	1205	PAINT PAVEMENT MARKING CHARACTER	4 EA	35.00	140.00
0115	4845000000-N	1205	PAINT PAVEMENT MARKING SYMBOL	77 EA	35.00	2,695.00
0116	4850000000-E	1205	REMOVAL OF PAVEMENT MARKING LINES (4")	3,938 LF	0.75	2,953.50
0117	4875000000-N	1205	REMOVAL OF PAVEMENT MARKING SYMBOLS & CHARACTERS	6 EA	50.00	300.00
0118	4900000000-N	1251	PERMANENT RAISED PAVEMENT MARKERS	23 EA	10.00	230.00
0119	5325800000-E	1510	8" WATER LINE	457 LF	175.00	79,975.00
0120	5327400000-E	1510	24" WATER LINE	1,115 LF	365.00	406,975.00
0121	5546000000-E	1515	8" VALVE	1 EA	1,000.00	1,000.00
0122	5559400000-E	1515	24" VALVE	4 EA	17,000.00	68,000.00
0123	5571600000-E	1515	6" TAPPING VALVE	1 EA	3,500.00	3,500.00
0124	5571800000-E	1515	8" TAPPING VALVE	1 EA	4,500.00	4,500.00
0125	5648000000-N	1515	RELOCATE WATER METER	2 EA	2,100.00	4,200.00
0126	5666000000-E	1515	FIRE HYDRANT	1 EA	5,000.00	5,000.00

Line #	ItemNumber	Sec #	Description	Quantity Unit	Unit Bid Price	Amount Bid
0127	5775000000-E	1525	4' DIA UTILITY MANHOLE	2 EA	2,200.00	4,400.00
0128	5781000000-E	1525	UTILITY MANHOLE WALL, 4' DIA	18 LF	175.00	3,150.00
0129	5801000000-E	1530	ABANDON 8" UTILITY PIPE	534 LF	13.00	6,942.00
0130	5813000000-E	1530	ABANDON 24" UTILITY PIPE	1,070 LF	47.00	50,290.00
0131	5816000000-N	1530	ABANDON UTILITY MANHOLE	1 EA	1,200.00	1,200.00
0132	5836400000-E	1540	36" ENCASEMENT PIPE	402 LF	260.00	104,520.00
0133	5872400000-E	1550	TRENCHLESS INSTALLATION OF 36" IN SOIL	201 LF	330.00	66,330.00
0134	5872410000-E	1550	TRENCHLESS INSTALLATION OF 36" NOT IN SOIL	201 LF	1.00	201.00
0135	5882000000-N	SP	GENERIC UTILITY ITEM 3" COMBINATION AIR RELEASE VALVE	1 EA	8,500.00	8,500.00
0136	6000000000-E	1605	TEMPORARY SILT FENCE	7,000 LF	3.50	24,500.00
0137	6006000000-E	1610	STONE FOR EROSION CONTROL, CLASS A	360 TON	52.74	18,986.40
0138	6009000000-E	1610	STONE FOR EROSION CONTROL, CLASS B	505 TON	52.74	26,633.70
0139	6012000000-E	1610	SEDIMENT CONTROL STONE	540 TON	50.24	27,129.60
0140	6015000000-E	1615	TEMPORARY MULCHING	7.5 ACR	1,100.00	8,250.00
0141	6018000000-E	1620	SEED FOR TEMPORARY SEEDING	500 LB	1.25	625.00
0142	6021000000-E	1620	FERTILIZER FOR TEMPORARY SEED- ING	2.5 TON	900.00	2,250.00
0143	6024000000-E	1622	TEMPORARY SLOPE DRAINS	500 LF	22.85	11,425.00
0144	6029000000-E	SP	SAFETY FENCE	200 LF	3.00	600.00
0145	6030000000-E	1630	SILT EXCAVATION	610 CY	14.35	8,753.50

Line #	ItemNumber	Sec #	Description	Quantity Unit	Unit Bid Price	Amount Bid
0146	6036000000-E	1631	MATTING FOR EROSION CONTROL	2,500 SY	2.50	6,250.00
0147	6042000000-E	1632	1/4" HARDWARE CLOTH	1,225 LF	3.50	4,287.50
0148	6071010000-E	SP	WATTLE	75 LF	9.00	675.00
0149	6071020000-E	SP	POLYACRYLAMIDE (PAM)	25 LB	8.50	212.50
0150	6084000000-E	1660	SEEDING & MULCHING	8 ACR	1,900.00	15,200.00
0151	6087000000-E	1660	MOWING	4 ACR	125.00	500.00
0152	6090000000-E	1661	SEED FOR REPAIR SEEDING	100 LB	3.00	300.00
0153	6093000000-E	1661	FERTILIZER FOR REPAIR SEEDING	0.25 TON	975.00	243.75
0154	6096000000-E	1662	SEED FOR SUPPLEMENTAL SEEDING	225 LB	3.00	675.00
0155	6108000000-E	1665	FERTILIZER TOPDRESSING	6.75 TON	975.00	6,581.25
0156	6114500000-N	1667	SPECIALIZED HAND MOWING	10 MHR	95.00	950.00
0157	6117000000-N	SP	RESPONSE FOR EROSION CONTROL	18 EA	450.00	8,100.00
0158	6132000000-N	SP	GENERIC EROSION CONTROL ITEM CONCRETE WASHOUT STRUCTURE	8 EA	2,748.87	21,990.96
0159	7060000000-E	1705	SIGNAL CABLE	1,470 LF	2.75	4,042.50
0160	7120000000-E	1705	VEHICLE SIGNAL HEAD (12", 3 SECTION)	8 EA	800.00	6,400.00
0161	7132000000-E	1705	VEHICLE SIGNAL HEAD (12", 4 SECTION)	3 EA	900.00	2,700.00
0162	7144000000-E	1705	VEHICLE SIGNAL HEAD (12", 5 SECTION)	2 EA	1,100.00	2,200.00
0163	7264000000-E	1710	MESSENGER CABLE (3/8")	530 LF	3.00	1,590.00
0164	7288000000-E	1715	PAVED TRENCHING (***** (1, 2"))	50 LF	30.00	1,500.00

Line #	ItemNumber	Sec #	Description	Quantity Unit	Unit Bid Price	Amount Bid
0165	7300000000-E	1715	UNPAVED TRENCHING (*****) (1, 2")	790 LF	6.00	4,740.00
0166	7300100000-E	1715	UNPAVED TRENCHING FOR TEMP- ORARY LEAD-IN	95 LF	2.00	190.00
0167	7301000000-E	1715	DIRECTIONAL DRILL (*****) (1, 2")	155 LF	18.00	2,790.00
0168	7324000000-N	1716	JUNCTION BOX (STANDARD SIZE)	16 EA	300.00	4,800.00
0169	7360000000-N	1720	WOOD POLE	7 EA	900.00	6,300.00
0170	7372000000-N	1721	GUY ASSEMBLY	10 EA	350.00	3,500.00
0171	7408000000-E	1722	1" RISER WITH WEATHERHEAD	1 EA	400.00	400.00
0172	7420000000-E	1722	2" RISER WITH WEATHERHEAD	3 EA	450.00	1,350.00
0173	7444000000-E	1725	INDUCTIVE LOOP SAWCUT	2,265 LF	6.50	14,722.50
0174	7456000000-E	1726	LEAD-IN CABLE (*****) (14-2)	7,635 LF	1.25	9,543.75
0175	7636000000-N	1745	SIGN FOR SIGNALS	4 EA	300.00	1,200.00
0176	7684000000-N	1750	SIGNAL CABINET FOUNDATION	1 EA	600.00	600.00
0177	7756000000-N	1751	CONTROLLER WITH CABINET (TYPE 2070L, BASE MOUNTED)	1 EA	11,000.00	11,000.00
0178	7780000000-N	1751	DETECTOR CARD (TYPE 2070L)	9 EA	100.00	900.00
0179	7901000000-N	1753	CABINET BASE EXTENDER	1 EA	400.00	400.00
0180	7980000000-N	SP	GENERIC SIGNAL ITEM MICROWAVE VEHICLE DETECTOR- SINGLE ZONE	4 EA	800.00	3,200.00

Contract Item Sheets For C203565

Line #	ItemNumber	Sec #	Description	Quantity Unit	Unit Bid Price	Amount Bid
0181	8801000000-E	SP	MSE RETAINING WALL NO **** (1)	930 SF	67.17	62,468.10
0182	8801000000-E	SP	MSE RETAINING WALL NO **** (2, 4 & END BENT 2 ABUTMENT)	22,750 SF	85.17	1,937,617.50
0183	8801000000-E	SP	MSE RETAINING WALL NO **** (3)	995 SF	75.54	75,162.30
0184	8801000000-E	SP	MSE RETAINING WALL NO **** (5)	5,460 SF	59.69	325,907.40

Line #	ItemNumber	Sec #	Description	Quantity Unit	Unit Bid Price	Amount Bid
0185	8007000000-N	SP	CONSTRUCTION, MAINTENANCE, & REMOVAL OF TEMP STRUCTURE AT STA ***** (21+74.92-L-)	Lump Sum LS	688,128.69	688,128.69
0186	8042000000-N	402	REMOVAL OF EXISTING STRUCTURES AT STATION ***** (21+74.92-L-)	Lump Sum LS	240,869.68	240,869.68
0187	8091000000-N	410	FOUNDATION EXCAVATION FOR BENT ** AT STATION ***** (1,21+74.92-L-)	Lump Sum LS	21,779.52	21,779.52
0188	8091000000-N	410	FOUNDATION EXCAVATION FOR BENT ** AT STATION ***** (2,21+74.92-L-)	Lump Sum LS	21,779.52	21,779.52
0189	8112730000-N	450	PDA TESTING	1 EA	2,500.00	2,500.00
0190	8121000000-N	412	UNCLASSIFIED STRUCTURE EXCAVATION AT STATION ***** (21+74.92-L-)	Lump Sum LS	148,521.68	148,521.68
0191	8147000000-E	420	REINFORCED CONCRETE DECK SLAB	29,220 SF	39.66	1,158,865.20
0192	8161000000-E	420	GROOVING BRIDGE FLOORS	29,382 SF	0.54	15,866.28
0193	8182000000-E	420	CLASS A CONCRETE (BRIDGE)	640.8 CY	967.64	620,063.71
0194	8210000000-N	422	BRIDGE APPROACH SLABS, STATION ***** (21+74.92-L-)	Lump Sum LS	106,005.80	106,005.80
0195	8217000000-E	425	REINFORCING STEEL (BRIDGE)	101,903 LB	0.95	96,807.85
0196	8238000000-E	425	SPIRAL COLUMN REINFORCING STEEL (BRIDGE)	9,553 LB	2.51	23,978.03
0197	8262000000-E	430	45" PRESTRESSED CONCRETE GIRDERS	1,544 LF	271.24	418,794.56
0198	8280000000-E	440	APPROX LBS STRUCTURAL STEEL	437,500 LS	919,861.40	919,861.40
0199	8364000000-E	450	HP12X53 STEEL PILES	2,785 LF	48.67	135,545.95
0200	8384000000-E	450	HP14X73 STEEL PILES	3,360 LF	58.41	196,257.60
0201	8531000000-E	462	4" SLOPE PROTECTION	900 SY	111.97	100,773.00

Contract Item Sheets For C203565

Line #	ItemNumber	Sec #	Description	Quantity Unit	Unit Bid Price	Amount Bid
0202	8657000000-N	430	ELASTOMERIC BEARINGS	Lump Sum LS	24,588.69	24,588.69
0203	8706000000-N	SP	EXPANSION JOINT SEALS	Lump Sum LS	171,558.93	171,558.93
0204	8867000000-E	SP	GENERIC STRUCTURE ITEM CLASSIC CONC BRIDGE RAIL	506.7 LF	268.25	135,922.28
TOTAL AMOUNT OF BID FOR ENTIRE PROJECT						\$12,949,964.50

1216/Sep02/Q857086/D943029170000/E204

Contract No. C203565
County Cabarrus

Rev. 5-19-11

**EXECUTION OF CONTRACT
NON-COLLUSION AFFIDAVIT, DEBARMENT CERTIFICATION AND GIFT BAN CERTIFICATION
CORPORATION**

The Contractor being duly sworn, solemnly swears (or affirms) that neither he, nor any official, agent or employee has entered into any agreement, participated in any collusion, or otherwise taken any action which is in restraint of free competitive bidding in connection with this Contract, that the Contractor has not been convicted of violating *N.C.G.S. § 133-24* within the last three years, and that the Contractor intends to do the work with its own bonafide employees or subcontractors and did not bid for the benefit of another contractor.

By submitting this Execution of Contract, Non-Collusion Affidavit and Debarment Certification, the Contractor is certifying his status under penalty of perjury under the laws of the United States in accordance with the Debarment Certification attached, provided that the Debarment Certification also includes any required statements concerning exceptions that are applicable.

N.C.G.S. § 133-32 and Executive Order 24 prohibit the offer to, or acceptance by, any State Employee of any gift from anyone with a contract with the State, or from any person seeking to do business with the State. By execution of any response in this procurement, you attest, for your entire organization and its employees or agents, that you are not aware that any such gift has been offered, accepted, or promised by any employees of your organization.

SIGNATURE OF CONTRACTOR

HRI, Inc. DBA HRI Bridge Company

Full name of Corporation

1750 West College Ave, State College, PA 16801

Address as Prequalified

Attest

[Signature]
Secretary/Assistant Secretary
Select appropriate title

By

[Signature]
President/Vice President/Assistant Vice President
Select appropriate title

Steve Schaffer

Print or type Signer's name

Jeffrey C. Lamb

Print or type Signer's name

CORPORATE SEAL

AFFIDAVIT MUST BE NOTARIZED

Subscribed and sworn to before me this the

17th day of September 2015.

Jorden Michelle Mousaw
Signature of Notary Public

of Centre County

State of Pennsylvania

My Commission Expires: July 16, 2018

NOTARY SEAL

COMMONWEALTH OF PENNSYLVANIA
NOTARIAL SEAL
Jorden Michelle Mousaw, Notary Public
Ferguson Twp., Centre County
My Commission Expires July 16, 2018
MEMBER, PENNSYLVANIA ASSOCIATION OF NOTARIES

DEBARMENT CERTIFICATION

Conditions for certification:

1. The prequalified bidder shall provide immediate written notice to the Department if at any time the bidder learns that his certification was erroneous when he submitted his debarment certification or explanation filed with the Department, or has become erroneous because of changed circumstances.
2. The terms *covered transaction, debarred, suspended, ineligible, lower tier covered transaction, participant, person, primary covered transaction, principal, proposal, and voluntarily excluded*, as used in this provision, have the meanings set out in the Definitions and Coverage sections of the rules implementing Executive Order 12549. A copy of the Federal Rules requiring this certification and detailing the definitions and coverages may be obtained from the Contract Officer of the Department.
3. The prequalified bidder agrees by submitting this form, that he will not knowingly enter into any lower tier covered transaction with a person who is debarred, suspended, declared ineligible, or voluntarily excluded from participation in NCDOT contracts, unless authorized by the Department.
4. For Federal Aid projects, the prequalified bidder further agrees that by submitting this form he will include the Federal-Aid Provision titled *Required Contract Provisions Federal-Aid Construction Contract (Form FHWA PR 1273)* provided by the Department, without subsequent modification, in all lower tier covered transactions.
5. The prequalified bidder may rely upon a certification of a participant in a lower tier covered transaction that he is not debarred, suspended, ineligible, or voluntarily excluded from the covered transaction, unless he knows that the certification is erroneous. The bidder may decide the method and frequency by which he will determine the eligibility of his subcontractors.
6. Nothing contained in the foregoing shall be construed to require establishment of a system of records in order to render in good faith the certification required by this provision. The knowledge and information of a participant is not required to exceed that which is normally possessed by a prudent person in the ordinary course of business dealings.
7. Except as authorized in paragraph 6 herein, the Department may terminate any contract if the bidder knowingly enters into a lower tier covered transaction with a person who is suspended, debarred, ineligible, or voluntarily excluded from participation in this transaction, in addition to other remedies available by the Federal Government.

Contract No. C203565
County Cabarrus

Rev. 5-19-11

DEBARMENT CERTIFICATION

The prequalified bidder certifies to the best of his knowledge and belief, that he and his principals:

- a. Are not presently debarred, suspended, proposed for debarment, declared ineligible, or voluntarily excluded from covered transactions by any Federal department or agency;
- b. Have not within a three-year period preceding this proposal been convicted of or had a civil judgment rendered against them for commission of fraud or a criminal offense in connection with obtaining, attempting to obtain, or performing a public (Federal, State or local) transaction or contract under a public transaction; violation of Federal or State antitrust statutes or commission of embezzlement, theft, forgery, bribery, falsification or destruction of records; making false statements; or receiving stolen property;
- c. Are not presently indicted for or otherwise criminally or civilly charged by a governmental entity (Federal, State or local) with commission of any of the offenses enumerated in paragraph b. of this certification; and
- d. Have not within a three-year period preceding this proposal had one or more public transactions (Federal, State or local) terminated for cause or default.
- e. Will submit a revised Debarment Certification immediately if his status changes and will show in his bid proposal an explanation for the change in status.

If the prequalified bidder cannot certify that he is not debarred, he shall provide an explanation with this submittal. An explanation will not necessarily result in denial of participation in a contract.

Failure to submit a non-collusion affidavit and debarment certification will result in the prequalified bidder's bid being considered non-responsive.

Check here if an explanation is attached to this certification.

Contract No. **C203565**

County (ies): **Cabarrus**

ACCEPTED BY THE
DEPARTMENT OF TRANSPORTATION

DocuSigned by:

A7079EC32A09478...

Contract Officer

9/21/2015

Date

Execution of Contract and Bonds
Approved as to Form:

DocuSigned by:

1839E4C3ADF14AE...

Attorney General

9/18/2015

Date

Signature Sheet (Bid - Acceptance by Department)

Contract No. C203565
County Cabarrus

Rev 5-17-11

CONTRACT PAYMENT BOND

Date of Payment Bond Execution September 16, 2015

Name of Principal Contractor HRI, Inc. DBA HRI Bridge Company

Name of Surety: Liberty Mutual Insurance Company & Fidelity and Deposit Company of Maryland

Name of Contracting Body: North Carolina Department of Transportation
Raleigh, North Carolina

Amount of Bond: \$12,949,964.50

Contract ID No.: C203565

County Name: Cabarrus

KNOW ALL MEN BY THESE PRESENTS, That we, the PRINCIPAL CONTRACTOR (hereafter, PRINCIPAL) and SURETY above named, are held and firmly bound unto the above named Contracting Body, hereinafter called the Contracting Body, in the penal sum of the amount stated above for the payment of which sum well and truly to be made, we bind ourselves, our heirs, executors, administrators, and successors, jointly and severally, firmly by these presents.

THE CONDITION OF THIS OBLIGATION IS SUCH, that whereas the principal entered into a certain contract with the Contracting Body, numbered as shown above and hereto attached:

NOW THEREFORE, if the principal shall promptly make payment to all persons supplying labor and material in the prosecution of the work provided for in said contract, and any and all duly authorized modifications of said contract that may hereafter be made, notice of which modifications to the surety being hereby waived, then this obligation to be void; otherwise to remain in full force and virtue.

IN WITNESS WHEREOF, the above-bound parties have executed this instrument under their several seals on the date indicated above, the name and corporate seal of each corporate party being hereto affixed and these presents duly signed by its undersigned representative, pursuant to authority of its governing body.

Contract No. C203565
County Cabarrus

Rev 5-17-11

CONTRACT PAYMENT BOND

Affix Seal of Surety Company

Liberty Mutual Insurance Company &
Fidelity and Deposit Company of Maryland

Print or type Surety Company Name

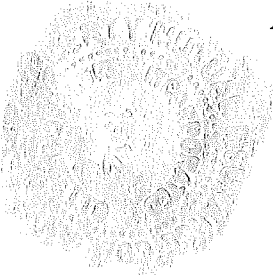

By Stacy Rivera

Print, stamp or type name of Attorney-in-Fact

Signature of Attorney-in-Fact

Signature of Witness

Lucy Bernatchy

Print or type Signer's name

185 Asylum St., 25th Floor
Hartford, CT 06103

Address of Attorney-in-Fact

Contract No. C203565
County Cabarrus

Rev 5-17-11

CONTRACT PAYMENT BOND

CORPORATION

SIGNATURE OF CONTRACTOR (Principal)

HRI, Inc. DBA HRI Bridge Company

Full name of Corporation

1750 West College Avenue, State College, PA 16801

Address as prequalified

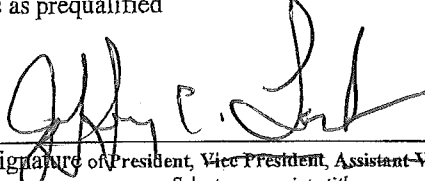
By 
Signature of President, Vice President, Assistant Vice President
Select appropriate title

Jeffrey C. Lamb

Print or type Signer's name

Affix Corporate Seal

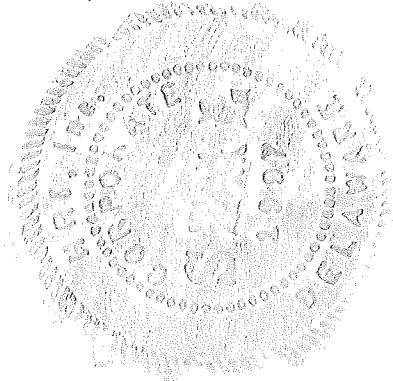

Attest

Signature of Secretary, Assistant Secretary
Select appropriate title

Steve Schaffer

Print or type Signer's name



LIBERTY MUTUAL INSURANCE COMPANY
FINANCIAL STATEMENT — DECEMBER 31, 2014

Assets		Liabilities	
Cash and Bank Deposits.....	\$744,221,142	Unearned Premiums.....	\$6,288,178,795
*Bonds — U.S Government.....	1,718,117,704	Reserve for Claims and Claims Expense	16,879,324,618
*Other Bonds.....	11,205,872,087	Funds Held Under Reinsurance Treaties.....	211,983,009
*Stocks	9,533,437,819	Reserve for Dividends to Policyholders.....	1,246,547
Real Estate.....	277,742,849	Additional Statutory Reserve.....	40,877,587
Agents' Balances or Uncollected Premiums.....	4,150,041,316	Reserve for Commissions, Taxes and Other Liabilities	<u>2,664,248,124</u>
Accrued Interest and Rents.....	129,261,358	Total	\$26,085,858,680
Other Admitted Assets.....	<u>14,896,464,393</u>	Special Surplus Funds.....	\$53,954,363
Total Admitted Assets.....	<u>\$42,655,158,668</u>	Capital Stock.....	10,000,000
		Paid in Surplus.....	8,829,117,542
		Unassigned Surplus.....	7,676,228,083
		Surplus to Policyholders	<u>16,569,299,988</u>
		Total Liabilities and Surplus	<u>\$42,655,158,668</u>



* Bonds are stated at amortized or investment value; Stocks at Association Market Values.
The foregoing financial information is taken from Liberty Mutual Insurance Company's financial statement filed with the state of Massachusetts Department of Insurance.

I, TIM MIKOLAJEWSKI, Assistant Secretary of Liberty Mutual Insurance Company, do hereby certify that the foregoing is a true, and correct statement of the Assets and Liabilities of said Corporation, as of December 31, 2014, to the best of my knowledge and belief.

IN WITNESS WHEREOF, I have hereunto set my hand and affixed the seal of said Corporation at Seattle, Washington, this 20th day of March, 2015.

T. Mikolajewski

Assistant Secretary

THIS POWER OF ATTORNEY IS NOT VALID UNLESS IT IS PRINTED ON RED BACKGROUND.

This Power of Attorney limits the acts of those named herein, and they have no authority to bind the Company except in the manner and to the extent herein stated.

Certificate No. 7025686

American Fire and Casualty Company
The Ohio Casualty Insurance Company

Liberty Mutual Insurance Company
West American Insurance Company

POWER OF ATTORNEY

KNOWN ALL PERSONS BY THESE PRESENTS: That American Fire & Casualty Company and The Ohio Casualty Insurance Company are corporations duly organized under the laws of the State of New Hampshire, that Liberty Mutual Insurance Company is a corporation duly organized under the laws of the State of Massachusetts, and West American Insurance Company is a corporation duly organized under the laws of the State of Indiana (herein collectively called the "Companies"), pursuant to and by authority herein set forth, does hereby name, constitute and appoint, Aiza Lopez; Danielle M. Bechard; Erin L. Kiernan; Jeannette Porrini; Stacy Rivera

all of the city of Hartford, state of CT each individually if there be more than one named, its true and lawful attorney-in-fact to make, execute, seal, acknowledge and deliver, for and on its behalf as surety and as its act and deed, any and all undertakings, bonds, recognizances and other surety obligations, in pursuance of these presents and shall be as binding upon the Companies as if they have been duly signed by the president and attested by the secretary of the Companies in their own proper persons.

IN WITNESS WHEREOF, this Power of Attorney has been subscribed by an authorized officer or official of the Companies and the corporate seals of the Companies have been affixed thereto this 17th day of June, 2015

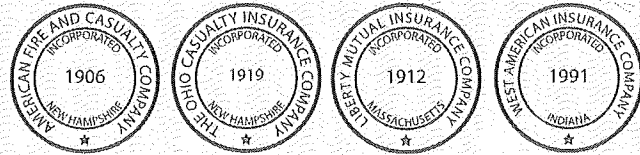

American Fire and Casualty Company
The Ohio Casualty Insurance Company
Liberty Mutual Insurance Company
West American Insurance Company

By: David M. Carey
David M. Carey, Assistant Secretary

STATE OF PENNSYLVANIA ss
COUNTY OF MONTGOMERY

On this 17th day of June, 2015, before me personally appeared David M. Carey, who acknowledged himself to be the Assistant Secretary of American Fire and Casualty Company, Liberty Mutual Insurance Company, The Ohio Casualty Insurance Company, and West American Insurance Company, and that he, as such, being authorized so to do, execute the foregoing instrument for the purposes therein contained by signing on behalf of the corporations by himself as a duly authorized officer.

IN WITNESS WHEREOF, I have hereunto subscribed my name and affixed my notarial seal at Plymouth Meeting, Pennsylvania, on the day and year first above written.



COMMONWEALTH OF PENNSYLVANIA
Notarial Seal
Teresa Pastella, Notary Public
Plymouth Twp., Montgomery County
My Commission Expires March 28, 2017
Member, Pennsylvania Association of Notaries

By: Teresa Pastella
Teresa Pastella, Notary Public

This Power of Attorney is made and executed pursuant to and by authority of the following By-laws and Authorizations of American Fire and Casualty Company, The Ohio Casualty Insurance Company, Liberty Mutual Insurance Company, and West American Insurance Company which resolutions are now in full force and effect reading as follows:

ARTICLE IV – OFFICERS – Section 12. Power of Attorney. Any officer or other official of the Corporation authorized for that purpose in writing by the Chairman or the President, and subject to such limitation as the Chairman or the President may prescribe, shall appoint such attorneys-in-fact, as may be necessary to act in behalf of the Corporation to make, execute, seal, acknowledge and deliver as surety any and all undertakings, bonds, recognizances and other surety obligations. Such attorneys-in-fact, subject to the limitations set forth in their respective powers of attorney, shall have full power to bind the Corporation by their signature and execution of any such instruments and to attach thereto the seal of the Corporation. When so executed, such instruments shall be as binding as if signed by the President and attested to by the Secretary. Any power or authority granted to any representative or attorney-in-fact under the provisions of this article may be revoked at any time by the Board, the Chairman, the President or by the officer or officers granting such power or authority.

ARTICLE XIII – Execution of Contracts – SECTION 5. Surety Bonds and Undertakings. Any officer of the Company authorized for that purpose in writing by the chairman or the president, and subject to such limitations as the chairman or the president may prescribe, shall appoint such attorneys-in-fact, as may be necessary to act in behalf of the Company to make, execute, seal, acknowledge and deliver as surety any and all undertakings, bonds, recognizances and other surety obligations. Such attorneys-in-fact subject to the limitations set forth in their respective powers of attorney, shall have full power to bind the Company by their signature and execution of any such instruments and to attach thereto the seal of the Company. When so executed such instruments shall be as binding as if signed by the president and attested by the secretary.

Certificate of Designation – The President of the Company, acting pursuant to the Bylaws of the Company, authorizes David M. Carey, Assistant Secretary to appoint such attorneys-in-fact as may be necessary to act on behalf of the Company to make, execute, seal, acknowledge and deliver as surety any and all undertakings, bonds, recognizances and other surety obligations.

Authorization – By unanimous consent of the Company's Board of Directors, the Company consents that facsimile or mechanically reproduced signature of any assistant secretary of the Company, wherever appearing upon a certified copy of any power of attorney issued by the Company in connection with surety bonds, shall be valid and binding upon the Company with the same force and effect as though manually affixed.

I, Gregory W. Davenport, the undersigned, Assistant Secretary, of American Fire and Casualty Company, The Ohio Casualty Insurance Company, Liberty Mutual Insurance Company, and West American Insurance Company do hereby certify that the original power of attorney of which the foregoing is a full, true and correct copy of the Power of Attorney executed by said Companies, is in full force and effect and has not been revoked.

IN TESTIMONY WHEREOF, I have hereunto set my hand and affixed the seals of said Companies this 16 day of September, 2015

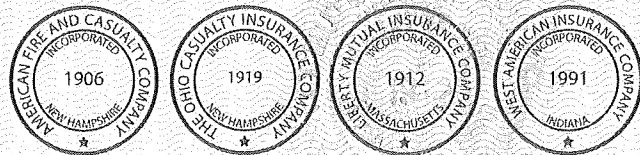

By: Gregory W. Davenport
Gregory W. Davenport, Assistant Secretary

Not valid for mortgage, note, loan, letter of credit, currency rate, interest rate or residual value guarantees.

To confirm the validity of this Power of Attorney call 1-610-832-8240 between 9:00 am and 4:30 pm EST on any business day.

FIDELITY AND DEPOSIT COMPANY

OF MARYLAND

600 Red Brook Blvd., Suite 600, Owings Mills, MD 21117

Statement of Financial Condition

As Of December 31, 2014

ASSETS

Bonds.....	\$ 142,720,308
Stocks	21,816,223
Cash and Short Term Investments.....	2,077,768
Reinsurance Recoverable	10,375,303
Other Accounts Receivable	46,778,921
TOTAL ADMITTED ASSETS.....	\$ 223,768,523

LIABILITIES, SURPLUS AND OTHER FUNDS

Reserve for Taxes and Expenses	\$ 1,321,332
Ceded Reinsurance Premiums Payable.....	49,965,411
Securities Lending Collateral Liability.....	4,009,064
TOTAL LIABILITIES	\$ 55,295,807
Capital Stock, Paid Up.....	\$ 5,000,000
Surplus.....	163,472,717
Surplus as regards Policyholders.....	168,472,716
TOTAL.....	\$ 223,768,523

Securities carried at \$58,191,540 in the above statement are deposited with various states as required by law.

Securities carried on the basis prescribed by the National Association of Insurance Commissioners. On the basis of market quotations for all bonds and stocks owned, the Company's total admitted assets at December 31, 2014 would be \$227,936,393 and surplus as regards policyholders \$172,640,586.

I, DENNIS F. KERRIGAN, Corporate Secretary of the FIDELITY AND DEPOSIT COMPANY OF MARYLAND, do hereby certify that the foregoing statement is a correct exhibit of the assets and liabilities of the said Company on the 31st day of December, 2014.

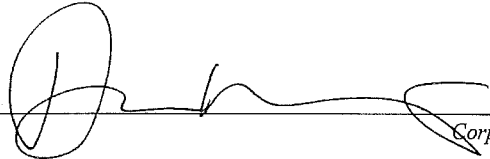

 Corporate Secretary

State of Illinois }
 City of Schaumburg } SS:

Subscribed and sworn to, before me, a Notary Public of the State of Illinois, in the City of Schaumburg, this 15th day of March, 2015.

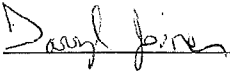

 Notary Public

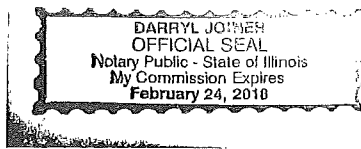

**ZURICH AMERICAN INSURANCE COMPANY
COLONIAL AMERICAN CASUALTY AND SURETY COMPANY
FIDELITY AND DEPOSIT COMPANY OF MARYLAND
POWER OF ATTORNEY**

KNOW ALL MEN BY THESE PRESENTS: That the ZURICH AMERICAN INSURANCE COMPANY, a corporation of the State of New York, the COLONIAL AMERICAN CASUALTY AND SURETY COMPANY, a corporation of the State of Maryland, and the FIDELITY AND DEPOSIT COMPANY OF MARYLAND a corporation of the State of Maryland (herein collectively called the "Companies"), by **THOMAS O. MCCLELLAN, Vice President**, in pursuance of authority granted by Article V, Section 8, of the By-Laws of said Companies, which are set forth on the reverse side hereof and are hereby certified to be in full force and effect on the date hereof, do hereby nominate, constitute, and appoint **Jeannette PORRINI, Stacy RIVERA, Aiza LOPEZ, Elana V. SANCHEZ and Erin L. KIERNAN, all of Hartford, Connecticut, EACH** its true and lawful agent and Attorney-in-Fact, to make, execute, seal and deliver, for, and on its behalf as surety, and as its act and deed: **any and all bonds and undertakings**, and the execution of such bonds or undertakings in pursuance of these presents, shall be as binding upon said Companies, as fully and amply, to all intents and purposes, as if they had been duly executed and acknowledged by the regularly elected officers of the ZURICH AMERICAN INSURANCE COMPANY at its office in New York, New York., the regularly elected officers of the COLONIAL AMERICAN CASUALTY AND SURETY COMPANY at its office in Owings Mills, Maryland., and the regularly elected officers of the FIDELITY AND DEPOSIT COMPANY OF MARYLAND at its office in Owings Mills, Maryland., in their own proper persons.

The said Vice President does hereby certify that the extract set forth on the reverse side hereof is a true copy of Article V, Section 8, of the By-Laws of said Companies, and is now in force.

IN WITNESS WHEREOF, the said Vice-President has hereunto subscribed his/her names and affixed the Corporate Seals of the said **ZURICH AMERICAN INSURANCE COMPANY, COLONIAL AMERICAN CASUALTY AND SURETY COMPANY, and FIDELITY AND DEPOSIT COMPANY OF MARYLAND**, this 8th day of December, A.D. 2014.

ATTEST:

**ZURICH AMERICAN INSURANCE COMPANY
COLONIAL AMERICAN CASUALTY AND SURETY COMPANY
FIDELITY AND DEPOSIT COMPANY OF MARYLAND**



By: *Eric D. Barnes*
Secretary
Eric D. Barnes

Thomas O. McClellan
Vice President
Thomas O. McClellan

State of Maryland
County of Baltimore

On this 8th day of December, A.D. 2014, before the subscriber, a Notary Public of the State of Maryland, duly commissioned and qualified, **THOMAS O. MCCLELLAN, Vice President, and ERIC D. BARNES, Secretary**, of the Companies, to me personally known to be the individuals and officers described in and who executed the preceding instrument, and acknowledged the execution of same, and being by me duly sworn, depose and saith, that he/she is the said officer of the Company aforesaid, and that the seals affixed to the preceding instrument are the Corporate Seals of said Companies, and that the said Corporate Seals and the signature as such officer were duly affixed and subscribed to the said instrument by the authority and direction of the said Corporations.

IN TESTIMONY WHEREOF, I have hereunto set my hand and affixed my Official Seal the day and year first above written.

Maria D. Adamski
Maria D. Adamski, Notary Public
My Commission Expires: July 8, 2015

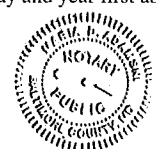

EXTRACT FROM BY-LAWS OF THE COMPANIES

"Article V, Section 8, Attorneys-in-Fact. The Chief Executive Officer, the President, or any Executive Vice President or Vice President may, by written instrument under the attested corporate seal, appoint attorneys-in-fact with authority to execute bonds, policies, recognizances, stipulations, undertakings, or other like instruments on behalf of the Company, and may authorize any officer or any such attorney-in-fact to affix the corporate seal thereto; and may with or without cause modify or revoke any such appointment or authority at any time."

CERTIFICATE

I, the undersigned, Vice President of the ZURICH AMERICAN INSURANCE COMPANY, the COLONIAL AMERICAN CASUALTY AND SURETY COMPANY, and the FIDELITY AND DEPOSIT COMPANY OF MARYLAND, do hereby certify that the foregoing Power of Attorney is still in full force and effect on the date of this certificate; and I do further certify that Article V, Section 8, of the By-Laws of the Companies is still in force.

This Power of Attorney and Certificate may be signed by facsimile under and by authority of the following resolution of the Board of Directors of the ZURICH AMERICAN INSURANCE COMPANY at a meeting duly called and held on the 15th day of December 1998.

RESOLVED: "That the signature of the President or a Vice President and the attesting signature of a Secretary or an Assistant Secretary and the Seal of the Company may be affixed by facsimile on any Power of Attorney...Any such Power or any certificate thereof bearing such facsimile signature and seal shall be valid and binding on the Company."

This Power of Attorney and Certificate may be signed by facsimile under and by authority of the following resolution of the Board of Directors of the COLONIAL AMERICAN CASUALTY AND SURETY COMPANY at a meeting duly called and held on the 5th day of May, 1994, and the following resolution of the Board of Directors of the FIDELITY AND DEPOSIT COMPANY OF MARYLAND at a meeting duly called and held on the 10th day of May, 1990.

RESOLVED: "That the facsimile or mechanically reproduced seal of the company and facsimile or mechanically reproduced signature of any Vice-President, Secretary, or Assistant Secretary of the Company, whether made heretofore or hereafter, wherever appearing upon a certified copy of any power of attorney issued by the Company, shall be valid and binding upon the Company with the same force and effect as though manually affixed.

IN TESTIMONY WHEREOF, I have hereunto subscribed my name and affixed the corporate seals of the said Companies, this 16 day of September, 20 15.



Gerald F. Haley

Gerald F. Haley, Vice President

Contract No. C203565
 County Cabarrus

Rev 5-17-11

CONTRACT PERFORMANCE BOND

Date of Performance Bond Execution: September 16, 2015

Name of Principal Contractor: HRI, Inc. DBA HRI Bridge Company

Name of Surety: Liberty Mutual Insurance Company &
Fidelity and Deposit Company of Maryland

Name of Contracting Body: **North Carolina Department of Transportation**
Raleigh, North Carolina

Amount of Bond: \$12,949,964.50

Contract ID No.: C203565

County Name: Cabarrus

KNOW ALL MEN BY THESE PRESENTS, That we, the PRINCIPAL CONTRACTOR (hereafter, PRINCIPAL) and SURETY above named, are held and firmly bound unto the above named Contracting Body, hereinafter called the Contracting Body, in the penal sum of the amount stated above for the payment of which sum well and truly to be made, we bind ourselves, our heirs, executors, administrators, and successors, jointly and severally, firmly by these presents.

THE CONDITION OF THIS OBLIGATION IS SUCH, that whereas the principal entered into a certain contract with the Contracting Body, numbered as shown above and hereto attached:

NOW THEREFORE, if the principal shall well and truly perform and fulfill all the undertakings, covenants, terms, conditions, and agreements of said contract during the original term of said contract and any extensions thereof that may be granted by the Contracting Body, with or without notice to the Surety, and during the life of any guaranty required under the contract, and shall also well and truly perform and fulfill all the undertakings, covenants, terms, conditions, and agreements of any and all duly authorized modifications of said contract that may hereafter be made, notice of which modifications to the surety being hereby waived, then this obligation to be void; otherwise to remain in full force and virtue.

IN WITNESS WHEREOF, the above-bound parties have executed this instrument under their several seals on the date indicated above, the name and corporate seal of each corporate party being hereto affixed and these presents duly signed by its undersigned representative, pursuant to authority of its governing body.

Contract No. C203565
County Cabarrus

Rev 5-17-11

CONTRACT PERFORMANCE BOND

Liberty Mutual Insurance Company &
Fidelity and Deposit Company of Maryland

Print or type Surety Company Name



By Stacy Rivera

Print, stamp or type name of Attorney-in-Fact

Signature of Attorney-in-Fact

Signature of Witness

Lucy Bernatchy

Print or type Signer's name

185 Asylum St., 25th Floor
Hartford, CT 06103

Address of Attorney-in-Fact

Contract No. C203565
County Cabarrus

Rev 5-17-11

CONTRACT PERFORMANCE BOND

CORPORATION

SIGNATURE OF CONTRACTOR (Principal)

HRI, Inc. DBA HRI Bridge Company

Full name of Corporation

1750 West College Avenue, State College, PA 16801

Address as prequalified

By

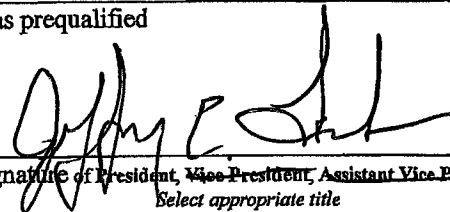

Signature of President, Vice President, Assistant Vice President

Select appropriate title

Jeffrey C. Lamb

Print or type Signer's name

Affix Corporate Seal

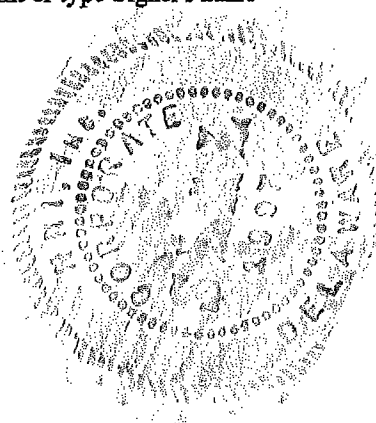

Attest

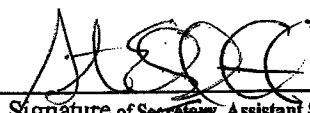

Signature of Secretary, Assistant Secretary

Select appropriate title

Steve Schaffer

Print or type Signer's name

THIS POWER OF ATTORNEY IS NOT VALID UNLESS IT IS PRINTED ON RED BACKGROUND.

This Power of Attorney limits the acts of those named herein, and they have no authority to bind the Company except in the manner and to the extent herein stated.

Certificate No. 7025687

American Fire and Casualty Company
The Ohio Casualty Insurance Company

Liberty Mutual Insurance Company
West American Insurance Company

POWER OF ATTORNEY

KNOWN ALL PERSONS BY THESE PRESENTS: That American Fire & Casualty Company and The Ohio Casualty Insurance Company are corporations duly organized under the laws of the State of New Hampshire, that Liberty Mutual Insurance Company is a corporation duly organized under the laws of the State of Massachusetts, and West American Insurance Company is a corporation duly organized under the laws of the State of Indiana (herein collectively called the "Companies"), pursuant to and by authority herein set forth, does hereby name, constitute and appoint, Aiza Lopez; Danielle M. Bechard; Erin L. Kiernan; Jeannette Porrini; Stacy Rivera

all of the city of Hartford, state of CT each individually if there be more than one named, its true and lawful attorney-in-fact to make, execute, seal, acknowledge and deliver, for and on its behalf as surety and as its act and deed, any and all undertakings, bonds, recognizances and other surety obligations, in pursuance of these presents and shall be as binding upon the Companies as if they have been duly signed by the president and attested by the secretary of the Companies in their own proper persons.

IN WITNESS WHEREOF, this Power of Attorney has been subscribed by an authorized officer or official of the Companies and the corporate seals of the Companies have been affixed thereto this 17th day of June, 2015.

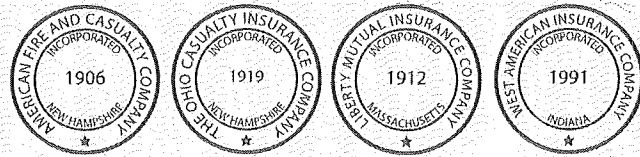

American Fire and Casualty Company
The Ohio Casualty Insurance Company
Liberty Mutual Insurance Company
West American Insurance Company

By: David M. Carey
David M. Carey, Assistant Secretary

STATE OF PENNSYLVANIA ss
COUNTY OF MONTGOMERY

On this 17th day of June, 2015, before me personally appeared David M. Carey, who acknowledged himself to be the Assistant Secretary of American Fire and Casualty Company, Liberty Mutual Insurance Company, The Ohio Casualty Insurance Company, and West American Insurance Company, and that he, as such, being authorized so to do, execute the foregoing instrument for the purposes therein contained by signing on behalf of the corporations by himself as a duly authorized officer.

IN WITNESS WHEREOF, I have hereunto subscribed my name and affixed my notarial seal at Plymouth Meeting, Pennsylvania, on the day and year first above written.



COMMONWEALTH OF PENNSYLVANIA
Notarial Seal
Teresa Pastella, Notary Public
Plymouth Twp., Montgomery County
My Commission Expires March 28, 2017
Member, Pennsylvania Association of Notaries

By: Teresa Pastella
Teresa Pastella, Notary Public

This Power of Attorney is made and executed pursuant to and by authority of the following By-laws and Authorizations of American Fire and Casualty Company, The Ohio Casualty Insurance Company, Liberty Mutual Insurance Company, and West American Insurance Company which resolutions are now in full force and effect reading as follows:

ARTICLE IV – OFFICERS – Section 12. Power of Attorney. Any officer or other official of the Corporation authorized for that purpose in writing by the Chairman or the President, and subject to such limitation as the Chairman or the President may prescribe, shall appoint such attorneys-in-fact, as may be necessary to act in behalf of the Corporation to make, execute, seal, acknowledge and deliver as surety any and all undertakings, bonds, recognizances and other surety obligations. Such attorneys-in-fact, subject to the limitations set forth in their respective powers of attorney, shall have full power to bind the Corporation by their signature and execution of any such instruments and to attach thereto the seal of the Corporation. When so executed, such instruments shall be as binding as if signed by the President and attested to by the Secretary. Any power or authority granted to any representative or attorney-in-fact under the provisions of this article may be revoked at any time by the Board, the Chairman, the President or by the officer or officers granting such power or authority.

ARTICLE XIII – Execution of Contracts – SECTION 5. Surety Bonds and Undertakings. Any officer of the Company authorized for that purpose in writing by the chairman or the president, and subject to such limitations as the chairman or the president may prescribe, shall appoint such attorneys-in-fact, as may be necessary to act in behalf of the Company to make, execute, seal, acknowledge and deliver as surety any and all undertakings, bonds, recognizances and other surety obligations. Such attorneys-in-fact subject to the limitations set forth in their respective powers of attorney, shall have full power to bind the Company by their signature and execution of any such instruments and to attach thereto the seal of the Company. When so executed such instruments shall be as binding as if signed by the president and attested by the secretary.

Certificate of Designation – The President of the Company, acting pursuant to the Bylaws of the Company, authorizes David M. Carey, Assistant Secretary to appoint such attorneys-in-fact as may be necessary to act on behalf of the Company to make, execute, seal, acknowledge and deliver as surety any and all undertakings, bonds, recognizances and other surety obligations.

Authorization – By unanimous consent of the Company's Board of Directors, the Company consents that facsimile or mechanically reproduced signature of any assistant secretary of the Company, wherever appearing upon a certified copy of any power of attorney issued by the Company in connection with surety bonds, shall be valid and binding upon the Company with the same force and effect as though manually affixed.

I, Gregory W. Davenport, the undersigned, Assistant Secretary, of American Fire and Casualty Company, The Ohio Casualty Insurance Company, Liberty Mutual Insurance Company, and West American Insurance Company do hereby certify that the original power of attorney of which the foregoing is a full, true and correct copy of the Power of Attorney executed by said Companies, is in full force and effect and has not been revoked.

IN TESTIMONY WHEREOF, I have hereunto set my hand and affixed the seals of said Companies this 16 day of September, 2015.

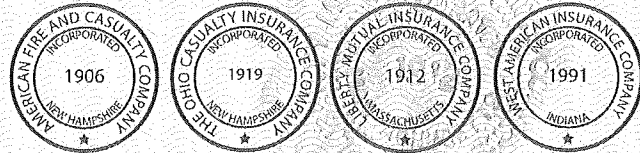

By: Gregory W. Davenport
Gregory W. Davenport, Assistant Secretary

Not valid for mortgage, note, loan, letter of credit, currency rate, interest rate or residual value guarantees.

To confirm the validity of this Power of Attorney call 1-610-832-8240 between 9:00 am and 4:30 pm EST on any business day.

**ZURICH AMERICAN INSURANCE COMPANY
COLONIAL AMERICAN CASUALTY AND SURETY COMPANY
FIDELITY AND DEPOSIT COMPANY OF MARYLAND
POWER OF ATTORNEY**

KNOW ALL MEN BY THESE PRESENTS: That the ZURICH AMERICAN INSURANCE COMPANY, a corporation of the State of New York, the COLONIAL AMERICAN CASUALTY AND SURETY COMPANY, a corporation of the State of Maryland, and the FIDELITY AND DEPOSIT COMPANY OF MARYLAND a corporation of the State of Maryland (herein collectively called the "Companies"), by **THOMAS O. MCCLELLAN, Vice President**, in pursuance of authority granted by Article V, Section 8, of the By-Laws of said Companies, which are set forth on the reverse side hereof and are hereby certified to be in full force and effect on the date hereof, do hereby nominate, constitute, and appoint **Jeannette PORRINI, Stacy RIVERA, Aiza LOPEZ, Elana V. SANCHEZ and Erin L. KIERNAN, all of Hartford, Connecticut, EACH** its true and lawful agent and Attorney-in-Fact, to make, execute, seal and deliver, for, and on its behalf as surety, and as its act and deed: **any and all bonds and undertakings**, and the execution of such bonds or undertakings in pursuance of these presents, shall be as binding upon said Companies, as fully and amply, to all intents and purposes, as if they had been duly executed and acknowledged by the regularly elected officers of the ZURICH AMERICAN INSURANCE COMPANY at its office in New York, New York., the regularly elected officers of the COLONIAL AMERICAN CASUALTY AND SURETY COMPANY at its office in Owings Mills, Maryland., and the regularly elected officers of the FIDELITY AND DEPOSIT COMPANY OF MARYLAND at its office in Owings Mills, Maryland., in their own proper persons.

The said Vice President does hereby certify that the extract set forth on the reverse side hereof is a true copy of Article V, Section 8, of the By-Laws of said Companies, and is now in force.

IN WITNESS WHEREOF, the said Vice-President has hereunto subscribed his/her names and affixed the Corporate Seals of the said **ZURICH AMERICAN INSURANCE COMPANY, COLONIAL AMERICAN CASUALTY AND SURETY COMPANY, and FIDELITY AND DEPOSIT COMPANY OF MARYLAND**, this 8th day of December, A.D. 2014.

ATTEST:

**ZURICH AMERICAN INSURANCE COMPANY
COLONIAL AMERICAN CASUALTY AND SURETY COMPANY
FIDELITY AND DEPOSIT COMPANY OF MARYLAND**



By: *Eric D. Barnes*
Secretary
Eric D. Barnes

Thomas O. McClellan
Vice President
Thomas O. McClellan

State of Maryland
County of Baltimore

On this 8th day of December, A.D. 2014, before the subscriber, a Notary Public of the State of Maryland, duly commissioned and qualified, **THOMAS O. MCCLELLAN, Vice President, and ERIC D. BARNES, Secretary**, of the Companies, to me personally known to be the individuals and officers described in and who executed the preceding instrument, and acknowledged the execution of same, and being by me duly sworn, depose and saith, that he/she is the said officer of the Company aforesaid, and that the seals affixed to the preceding instrument are the Corporate Seals of said Companies, and that the said Corporate Seals and the signature as such officer were duly affixed and subscribed to the said instrument by the authority and direction of the said Corporations.

IN TESTIMONY WHEREOF, I have hereunto set my hand and affixed my Official Seal the day and year first above written.

Maria D. Adamski

Maria D. Adamski, Notary Public
My Commission Expires: July 8, 2015



EXTRACT FROM BY-LAWS OF THE COMPANIES

"Article V, Section 8, Attorneys-in-Fact. The Chief Executive Officer, the President, or any Executive Vice President or Vice President may, by written instrument under the attested corporate seal, appoint attorneys-in-fact with authority to execute bonds, policies, recognizances, stipulations, undertakings, or other like instruments on behalf of the Company, and may authorize any officer or any such attorney-in-fact to affix the corporate seal thereto; and may with or without cause modify or revoke any such appointment or authority at any time."

CERTIFICATE

I, the undersigned, Vice President of the ZURICH AMERICAN INSURANCE COMPANY, the COLONIAL AMERICAN CASUALTY AND SURETY COMPANY, and the FIDELITY AND DEPOSIT COMPANY OF MARYLAND, do hereby certify that the foregoing Power of Attorney is still in full force and effect on the date of this certificate; and I do further certify that Article V, Section 8, of the By-Laws of the Companies is still in force.

This Power of Attorney and Certificate may be signed by facsimile under and by authority of the following resolution of the Board of Directors of the ZURICH AMERICAN INSURANCE COMPANY at a meeting duly called and held on the 15th day of December 1998.

RESOLVED: "That the signature of the President or a Vice President and the attesting signature of a Secretary or an Assistant Secretary and the Seal of the Company may be affixed by facsimile on any Power of Attorney...Any such Power or any certificate thereof bearing such facsimile signature and seal shall be valid and binding on the Company."

This Power of Attorney and Certificate may be signed by facsimile under and by authority of the following resolution of the Board of Directors of the COLONIAL AMERICAN CASUALTY AND SURETY COMPANY at a meeting duly called and held on the 5th day of May, 1994, and the following resolution of the Board of Directors of the FIDELITY AND DEPOSIT COMPANY OF MARYLAND at a meeting duly called and held on the 10th day of May, 1990.

RESOLVED: "That the facsimile or mechanically reproduced seal of the company and facsimile or mechanically reproduced signature of any Vice-President, Secretary, or Assistant Secretary of the Company, whether made heretofore or hereafter, wherever appearing upon a certified copy of any power of attorney issued by the Company, shall be valid and binding upon the Company with the same force and effect as though manually affixed.

IN TESTIMONY WHEREOF, I have hereunto subscribed my name and affixed the corporate seals of the said Companies, this 16 day of September, 2015.



Gerald F. Haley

Gerald F. Haley, Vice President

