

STATE OF NORTH CAROLINA  
DEPARTMENT OF TRANSPORTATION  
RALEIGH, N.C.

C204650

CONTRACT AND  
CONTRACT BONDS  
FOR CONTRACT NO. C204650

WBS 49633.3.1 0095077

T.I.P NO. HI-0008

COUNTY OF JOHNSTON

THIS IS THE ROADWAY & STRUCTURE CONTRACT

ROUTE NUMBER I-95 LENGTH 2.517 MILES

LOCATION I-95 FROM MILEMARKER 97 TO MILEMARKER 101.

CONTRACTOR S T WOOTEN CORPORATION

ADDRESS P.O. BOX 2408

WILSON, NC 278942408

BIDS OPENED SEPTEMBER 20, 2022

CONTRACT EXECUTION 10/26/2022

STATE OF NORTH CAROLINA  
DEPARTMENT OF TRANSPORTATION  
RALEIGH, N.C.

PROPOSAL

**INCLUDES ADDENDUM No.1 DATED 09-08-2022**

DATE AND TIME OF BID OPENING: **Sep 20, 2022 AT 02:00 PM**

CONTRACT ID C204650  
WBS 49633.3.1

FEDERAL-AID NO. 0095077  
COUNTY JOHNSTON  
T.I.P NO. HI-0008  
MILES 2.517  
ROUTE NO. I-95  
LOCATION I-95 FROM MILEMARKER 97 TO MILEMARKER 101.

TYPE OF WORK PAVEMENT AND STRUCTURE REHABILITATION.

**NOTICE:**

ALL BIDDERS SHALL COMPLY WITH ALL APPLICABLE LAWS REGULATING THE PRACTICE OF GENERAL CONTRACTING AS CONTAINED IN CHAPTER 87 OF THE GENERAL STATUTES OF NORTH CAROLINA WHICH REQUIRES THE BIDDER TO BE LICENSED BY THE N.C. LICENSING BOARD FOR CONTRACTORS WHEN BIDDING ON ANY NON-FEDERAL AID PROJECT WHERE THE BID IS \$30,000 OR MORE, EXCEPT FOR CERTAIN SPECIALTY WORK AS DETERMINED BY THE LICENSING BOARD. BIDDERS SHALL ALSO COMPLY WITH ALL OTHER APPLICABLE LAWS REGULATING THE PRACTICES OF ELECTRICAL, PLUMBING, HEATING AND AIR CONDITIONING AND REFRIGERATION CONTRACTING AS CONTAINED IN CHAPTER 87 OF THE GENERAL STATUTES OF NORTH CAROLINA. NOTWITHSTANDING THESE LIMITATIONS ON BIDDING, THE BIDDER WHO IS AWARDED ANY FEDERAL - AID FUNDED PROJECT SHALL COMPLY WITH CHAPTER 87 OF THE GENERAL STATUTES OF NORTH CAROLINA FOR LICENSING REQUIREMENTS WITHIN 60 CALENDAR DAYS OF BID OPENING.

**BIDS WILL BE RECEIVED AS SHOWN BELOW:**

**THIS IS A ROADWAY & STRUCTURE PROPOSAL**

**5% BID BOND OR BID DEPOSIT REQUIRED**

---

**PROPOSAL FOR THE CONSTRUCTION OF  
CONTRACT No. C204650 IN JOHNSTON COUNTY, NORTH CAROLINA**

Date \_\_\_\_\_ 20 \_\_\_\_\_

**DEPARTMENT OF TRANSPORTATION,  
RALEIGH, NORTH CAROLINA**

The Bidder has carefully examined the location of the proposed work to be known as Contract No. **C204650** has carefully examined the plans and specifications, which are acknowledged to be part of the proposal, the special provisions, the proposal, the form of contract, and the forms of contract payment bond and contract performance bond; and thoroughly understands the stipulations, requirements and provisions. The undersigned bidder agrees to bound upon his execution of the bid and subsequent award to him by the Board of Transportation in accordance with this proposal to provide the necessary contract payment bond and contract performance bond within fourteen days after the written notice of award is received by him. The undersigned Bidder further agrees to provide all necessary machinery, tools, labor, and other means of construction; and to do all the work and to furnish all materials, except as otherwise noted, necessary to perform and complete the said contract in accordance with *the 2018 Standard Specifications for Roads and Structures* by the dates(s) specified in the Project Special Provisions and in accordance with the requirements of the Engineer, and at the unit or lump sum prices, as the case may be, for the various items given on the sheets contained herein.

The Bidder shall provide and furnish all the materials, machinery, implements, appliances and tools, and perform the work and required labor to construct and complete State Highway Contract No. **C204650** in **Johnston County**, for the unit or lump sum prices, as the case may be, bid by the Bidder in his bid and according to the proposal, plans, and specifications prepared by said Department, which proposal, plans, and specifications show the details covering this project, and hereby become a part of this contract.

The published volume entitled *North Carolina Department of Transportation, Raleigh, Standard Specifications for Roads and Structures, January 2018* with all amendments and supplements thereto, is by reference incorporated into and made a part of this contract; that, except as herein modified, all the construction and work included in this contract is to be done in accordance with the specifications contained in said volume, and amendments and supplements thereto, under the direction of the Engineer.

If the proposal is accepted and the award is made, the contract is valid only when signed either by the Contract Officer or such other person as may be designated by the Secretary to sign for the Department of Transportation. The conditions and provisions herein cannot be changed except over the signature of the said Contract Officer.

The quantities shown in the itemized proposal for the project are considered to be approximate only and are given as the basis for comparison of bids. The Department of Transportation may increase or decrease the quantity of any item or portion of the work as may be deemed necessary or expedient.

An increase or decrease in the quantity of an item will not be regarded as sufficient ground for an increase or decrease in the unit prices, nor in the time allowed for the completion of the work, except as provided for the contract.

Accompanying this bid is a bid bond secured by a corporate surety, or certified check payable to the order of the Department of Transportation, for five percent of the total bid price, which deposit is to be forfeited as liquidated damages in case this bid is accepted and the Bidder shall fail to provide the required payment and performance bonds with the Department of Transportation, under the condition of this proposal, within 14 calendar days after the written notice of award is received by him, as provided in the *Standard Specifications*; otherwise said deposit will be returned to the Bidder.



*State Contract Officer*

DocuSigned by:

*Ronald Elton Davenport, Jr.*

F81B6038A47A442...

09/08/2022

**TABLE OF CONTENTS**

**COVER SHEET**  
**PROPOSAL SHEET**

**PROJECT SPECIAL PROVISIONS**

INTERESTED PARTIES LIST:..... G-1  
 CONTRACT TIME AND LIQUIDATED DAMAGES: ..... G-1  
 INTERMEDIATE CONTRACT TIME NUMBER 1 AND LIQUIDATED DAMAGES: ..... G-2  
 INTERMEDIATE CONTRACT TIME NUMBER 2 AND LIQUIDATED DAMAGES: ..... G-3  
 MAJOR CONTRACT ITEMS: ..... G-4  
 SPECIALTY ITEMS:..... G-4  
 FUEL PRICE ADJUSTMENT:..... G-4  
 STEEL PRICE ADJUSTMENT:..... G-5  
 SCHEDULE OF ESTIMATED COMPLETION PROGRESS:..... G-16  
 DISADVANTAGED BUSINESS ENTERPRISE: ..... G-16  
 CERTIFICATION FOR FEDERAL-AID CONTRACTS: ..... G-29  
 CONTRACTOR'S LICENSE REQUIREMENTS: ..... G-30  
 RESTRICTIONS ON ITS EQUIPMENT AND SERVICES:..... G-30  
 USE OF UNMANNED AIRCRAFT SYSTEM (UAS): ..... G-30  
 EQUIPMENT IDLING GUIDELINES:..... G-30  
 U.S. DEPARTMENT OF TRANSPORTATION HOTLINE: ..... G-31  
 NOTE TO CONTRACTOR (DMS):..... G-31  
 MAINTENANCE OF THE PROJECT: ..... G-32  
 COOPERATION BETWEEN CONTRACTORS:..... G-32  
 ELECTRONIC BIDDING:..... G-33  
 AWARD LIMITS: ..... G-33  
 TWELVE MONTH GUARANTEE: ..... G-33  
 NOTE TO CONTRACTOR (Concrete Waste Water): ..... G-34  
  
 ROADWAY..... R-1

**STANDARD SPECIAL PROVISIONS**

AVAILABILITY FUNDS – TERMINATION OF CONTRACTS..... SSP-1  
 NCDOT GENERAL SEED SPECIFICATION FOR SEED QUALITY ..... SSP-2  
 ERRATA..... SSP-5  
 PLANT AND PEST QUARANTINES ..... SSP-7  
 TITLE VI AND NONDISCRIMINATION ..... SSP-8  
 MINORITY AND FEMALE EMPLOYMENT REQUIREMENTS ..... SSP-16  
 REQUIRED CONTRACT PROVISIONS FEDERAL-AID CONST. CONTRACTS ..... SSP-19  
 ON-THE-JOB TRAINING ..... SSP-32  
 MINIMUM WAGES ..... SSP-35

**UNIT PROJECT SPECIAL PROVISIONS**

PAVEMENT MARKINGS.....	PM-1
TRAFFIC CONTROL .....	TC-1
EROSION CONTROL .....	EC-1
ITS.....	ITS-1
STRUCTURE / CULVERTS.....	BP-1

**PROPOSAL ITEM SHEET**

ITEM SHEET(S) (TAN SHEETS)

**PROJECT SPECIAL PROVISIONS****GENERAL****INTERESTED PARTIES LIST:**

(6-21-22)(Rev. 7-19-22)

102

SP1 G02

Revise the *2018 Standard Specifications* as follows:

**Page 1-12, Article 102-3 PROPOSALS AND PLAN HOLDER LISTS**, lines 45-49, delete and replace with the following:

**102-3 PROPOSALS AND INTERESTED PARTIES LIST**

On Department projects advertised, the prospective bidder shall sign up on the *Interested Parties List* no later than one business day prior to the Letting day of that project, for which he intends to submit a bid. There is no cost for signing up on the *Interested Parties List* that can be found on the Department's website at [connect.ncdot.gov/letting](http://connect.ncdot.gov/letting).

**Page 1-12, Article 102-3 PROPOSALS AND PLAN HOLDER LISTS**, lines 1-3, delete and replace the first sentence of the second paragraph with the following:

The proposal will state the location of the contemplated construction and show a schedule of contract items with the approximate quantity of each of these items for which bid prices are invited.

**Page 1-14, Article 102-8 PREPARATION AND SUBMISSION OF BIDS**, lines 30-31, delete and replace the first paragraph with the following:

Prior to submitting a bid on a project, the bidder shall sign up on the *Interested Parties List* in conformance with Article 102-3. The bidder shall submit a unit or lump sum price for every item in the proposal other than items that are authorized alternates to those items for which a bid price has been submitted.

**CONTRACT TIME AND LIQUIDATED DAMAGES:**

(7-1-95) (Rev. 12-18-07)

108

SP1 G10 A

The date of availability for this contract is **October 31, 2022**.

The completion date for this contract is **May 17, 2024**.

Except where otherwise provided by the contract, observation periods required by the contract will not be a part of the work to be completed by the completion date and/or intermediate contract times stated in the contract. The acceptable completion of the observation periods that extend beyond the final completion date shall be a part of the work covered by the performance and payment bonds.

The liquidated damages for this contract are **One Thousand Five Hundred Dollars (\$1,500.00)** per calendar day.

**INTERMEDIATE CONTRACT TIME NUMBER 1 AND LIQUIDATED DAMAGES:**

(2-20-07)

108

SP1 G14 A

The Contractor shall complete the required work of installing, maintaining, and removing the traffic control devices for lane closures and restoring traffic to the existing traffic pattern. The Contractor shall not close or narrow a lane of traffic on **I-95 (including associated Ramps and/or Loops)** during the following time restrictions:

**DAY AND TIME RESTRICTIONS****For All Operations except Bridge Deck Overlay and Joint Repair:****Monday thru Thursday, 7:00 a.m. to 8:00 p.m.****and****Friday thru Sunday, 7:00 a.m. to 10:00 p.m.****For Bridge Deck Overlay and Joint Repair:****From the Week after Labor Day to the Week before Memorial Day,  
Friday 12:00 p.m. (Noon) to Sunday 12:00 a.m. (Midnight)****and****From the Week before Memorial Day to the Week after Labor Day,  
No Continuous Lane Closure Allowed**

**For Bridge Deck Overlay and Joint Repair, a continuous lane closure is allowed as specified above to perform work associated with Bridge Deck Preservation to include Overlay Surface Preparation for Polymer Concrete, Polymer Concrete Bridge Deck Overlay, Concrete Work for Joint Replacement, and Strip Seals for Preservation. This work shall be performed in a continuous manner. Any surface that is scarified shall be covered with the proper Polymer Concrete Bridge Deck Overlay before traffic is returned to the bridge deck.**

In addition, the Contractor shall not close or narrow a lane of traffic on **I-95 (including associated Ramps and/or Loops)**, detain and/or alter the traffic flow on or during holidays, holiday weekends, special events, or any other time when traffic is unusually heavy, including the following schedules:

**HOLIDAY AND HOLIDAY WEEKEND LANE CLOSURE RESTRICTIONS**

1. For **unexpected occurrence** that creates unusually high traffic volumes, as directed by the Engineer.
2. For **New Year's Day**, between the hours of **6:30 a.m.** December 31<sup>st</sup> and **8:00 p.m.** January 2<sup>nd</sup>. If New Year's Day is on a Friday, Saturday, Sunday or Monday, then until **8:00 p.m.** the following Tuesday.
3. For **Easter**, between the hours of **6:30 a.m.** Thursday and **8:00 p.m.** Monday.
4. For **Memorial Day**, between the hours of **6:30 a.m.** Friday and **8:00 p.m.** Tuesday.
5. For **Independence Day**, between the hours of **6:30 a.m.** the day before Independence Day and **8:00 p.m.** the day after Independence Day.

If **Independence Day** is on a Friday, Saturday, Sunday, or Monday, then between the hours of **6:30 a.m.** the Thursday before Independence Day and **8:00 p.m.** the Tuesday after Independence Day.

6. For **Labor Day**, between the hours of **6:30 a.m.** Friday and **8:00 p.m.** Tuesday.
7. For **Thanksgiving**, between the hours of **6:30 a.m.** Tuesday and **8:00 p.m.** Monday.
8. For **Christmas**, between the hours of **6:30 a.m.** the Friday before the week of Christmas Day and **8:00 p.m.** the following Tuesday after the week of Christmas Day.

Holidays and holiday weekends shall include New Year's, Easter, Memorial Day, Independence Day, Labor Day, Thanksgiving, and Christmas. The Contractor shall schedule his work so that lane closures will not be required during these periods, unless otherwise directed by the Engineer.

The time of availability for this intermediate contract work shall be the time the Contractor begins to install all traffic control devices for lane closures according to the time restrictions listed herein.

The completion time for this intermediate contract work shall be the time the Contractor is required to complete the removal of all traffic control devices for lane closures according to the time restrictions stated above and place traffic in the existing traffic pattern.

The liquidated damages are **One Thousand Two Hundred Fifty Dollars (\$ 1,250.00)** per fifteen (**15**) minute time period.

**INTERMEDIATE CONTRACT TIME NUMBER 2 AND LIQUIDATED DAMAGES:**

(2-20-07)

108

SP1 G14 D

The Contractor shall complete the required work of installing, maintaining, and removing the traffic control devices for road closures and restoring traffic to the existing traffic pattern. The Contractor shall not close either direction of **I-95 (including associated Ramps and/or Loops)** during the following time restrictions:

**DAY AND TIME RESTRICTIONS**

**For Removal of Existing Overhead DMS Structure**  
**Sunday thru Saturday, 5:00 a.m. to 11:00 p.m.**

The time of availability for this intermediate contract work shall be the time the Contractor begins to implement the road closure.

The completion time for this intermediate contract work shall be the time the Contractor is required to open the roadway to traffic and place traffic in the existing traffic pattern.

The liquidated damages are **Two Thousand Five Hundred Dollars (\$ 2,500.00)** per fifteen (**15**) minute time period.



**MAJOR CONTRACT ITEMS:**

(2-19-02)

104

SP1 G28

The following listed items are the major contract items for this contract (see Article 104-5 of the *2018 Standard Specifications*):

<b>Line #</b>	<b>Description</b>
3	Asphalt Concrete Surface Course, Type S9.5D
69	Polyester Polymer Concrete Materials
	Or
3	Asphalt Concrete Surface Course, Type S9.5D
70	Epoxy Polymer Concrete Materials

**SPECIALTY ITEMS:**

(7-1-95)(Rev. 7-20-21)

108-6

SP1 G37

Items listed below will be the specialty items for this contract (see Article 108-6 of the *2018 Standard Specifications*).

<b>Line #</b>	<b>Description</b>
8-11	Guardrail
12-15	Signing
32-35, 38	Long-Life Pavement Markings
39	Permanent Pavement Markers
41-48	Signals/ITS System
50, 55-58	Bridge Painting
64 & 69 or 64 & 70	Polymer Concrete Overlay

**FUEL PRICE ADJUSTMENT:**

(11-15-05) (Rev. 7-20-21)

109-8

SP1 G43

Revise the *2018 Standard Specifications* as follows:

**Page 1-87, Article 109-8, Fuel Price Adjustments**, add the following:

The base index price for DIESEL #2 FUEL is \$ **3.7538** per gallon. Where any of the following are included as pay items in the contract, they will be eligible for fuel price adjustment.

The pay items and the fuel factor used in calculating adjustments to be made will be as follows:

<b>Description</b>	<b>Units</b>	<b>Fuel Usage Factor Diesel</b>
Unclassified Excavation	Gal/CY	0.29
Borrow Excavation	Gal/CY	0.29
Class IV Subgrade Stabilization	Gal/Ton	0.55
Aggregate Base Course	Gal/Ton	0.55
Sub-Ballast	Gal/Ton	0.55
Asphalt Concrete Base Course, Type _____	Gal/Ton	0.90 or 2.90
Asphalt Concrete Intermediate Course, Type _____	Gal/Ton	0.90 or 2.90
Asphalt Concrete Surface Course, Type _____	Gal/Ton	0.90 or 2.90
Open-Graded Asphalt Friction Course	Gal/Ton	0.90 or 2.90
Permeable Asphalt Drainage Course, Type _____	Gal/Ton	0.90 or 2.90
Sand Asphalt Surface Course, Type _____	Gal/Ton	0.90 or 2.90
Aggregate for Cement Treated Base Course	Gal/Ton	0.55
Portland Cement for Cement Treated Base Course	Gal/Ton	0.55
____ " Portland Cement Concrete Pavement	Gal/SY	0.245
Concrete Shoulders Adjacent to ____ " Pavement	Gal/SY	0.245

For the asphalt items noted in the chart as eligible for fuel adjustments, the bidder may include the *Fuel Usage Factor Adjustment Form* with their bid submission if they elect to use the fuel usage factor. The *Fuel Usage Factor Adjustment Form* is found at the following link:

<https://connect.ncdot.gov/letting/LetCentral/Fuel%20Usage%20Factor%20Adjustment%20Form.pdf>

Select either 2.90 Gal/Ton fuel factor or 0.90 Gal/Ton fuel factor for each asphalt line item on the *Fuel Usage Factor Adjustment Form*. The selected fuel factor for each asphalt item will remain in effect for the duration of the contract.

Failure to complete the *Fuel Usage Factor Adjustment Form* will result in using 2.90 gallons per ton as the Fuel Usage Factor for Diesel for the asphalt items noted above. The contractor will not be permitted to change the Fuel Usage Factor after the bids are submitted.

### **STEEL PRICE ADJUSTMENT:**

(4-19-22)(Rev. 9-20-22)

SP1 G47

### **Description and Purpose**

Steel price adjustments will be made to the payments due the Contractor for items as defined herein that are permanently incorporated into the work, when the price of raw steel mill products utilized on the contract have fluctuated. The Department will adjust monthly progress payments up or down as appropriate for cost changes in steel according to this provision.

**Eligible Items**

The list of eligible bid items for steel price adjustment can be found on the Departments website at the following address:

<https://connect.ncdot.gov/letting/LetCentral/Eligible%20Bid%20Items%20for%20Steel%20Price%20Adjustment.xlsx>

Nuts, bolts, anchor bolts, rebar chairs, connecting bands and other miscellaneous hardware associated with these items shall not be included in the price adjustment.

Adjustments will only be made for fluctuations in the material cost of the steel used in the above products as specified in the Product Relationship Table below. The producing mill is defined as the source of steel product before any fabrication has occurred (e.g., coil, plate, rebar, hot rolled shapes, etc.). No adjustment will be made for changes in the cost of fabrication, coating, shipping, storage, etc.

No steel price adjustments will be made for any products manufactured from steel having an adjustment date, as defined by the Product Relationship Table below, prior to the letting date.

**Bid Submittal Requirements**

The successful bidder, within 14 calendar days after the notice of award is received by him, shall provide the completed Form SPA-1 to the Department (State Contract Officer or Division Contract Engineer) along with the payment bonds, performance bonds and contract execution signature sheets in a single submittal. If Form SPA-1 is not included in the same submittal as the payment bonds, performance bonds and contract execution signature sheets, the Contractor will not be eligible for any steel price adjustment for any item in the contract for the life of the contract. Form SPA-1 can be found on the Department's website at the following address:

<https://connect.ncdot.gov/letting/LetCentral/Form%20SPA-1.xlsm>

The Contractor shall provide Form SPA-1 listing the Contract Line Number, (with corresponding Item Number, Item Description, and Category) for the steel products they wish to have an adjustment calculated. Only the contract items corresponding to the list of eligible item numbers for steel price adjustment may be entered on Form SPA-1. The Contractor may choose to have steel price adjustment applied to any, all, or none of the eligible items. However, the Contractor's selection of items for steel price adjustment or non-selection (non-participation) may not be changed once Form SPA-1 has been received by the Department. Items the Bidder chooses for steel price adjustment must be designated by writing the word "Yes" in the column titled "Option" by each Pay Item chosen for adjustment. Should the bidder elect an eligible steel price item, the entire quantity of the line item will be subject to the price adjustment for the duration of the Contract. The Bidder's designations on Form SPA-1 must be written in ink or typed and signed by the Bidder (Prime Contractor) to be considered complete. Items not properly designated, designated with "No", or left blank on the Bidder's Form SPA-1 will automatically be removed from consideration for adjustment. No steel items will be eligible for steel price adjustment on this Project if the Bidder fails to return Form SPA-1 in accordance with this provision.

### Establishing the Base Price

The Department will use a blend of monthly average prices as reported from the Fastmarkets platform to calculate the monthly adjustment indices (BI and MI). This data is typically available on the first day of the month for the preceding month. The indices will be calculated by the Department for the different categories found on the Product Relationship Table below. For item numbers that include multiple types of steel products, the category listed for that item number will be used for adjusting each steel component.

The bidding index for Category 1 Steel items is **\$ 53.88** per hundredweight.

The bidding index for Category 2 Steel items is **\$ 85.49** per hundredweight.

The bidding index for Category 3 Steel items is **\$ 71.54** per hundredweight.

The bidding index for Category 4 Steel items is **\$ 46.74** per hundredweight.

The bidding index for Category 5 Steel items is **\$ 63.69** per hundredweight.

The bidding index for Category 6 Steel items is **\$ 89.42** per hundredweight.

The bidding index for Category 7 Steel items is **\$ 57.67** per hundredweight.

The bidding index represents a selling price of steel based on Fastmarkets data for the month of **July 2022**.

MI = Monthly Index. – in Dollars (\$) per hundredweight (CWT). Use the adjustment indices from the month the steel was shipped from the producing mill, received on the project, or member cast as defined in the Product Relationship Table.

BI = Bidding Index. - in Dollars (\$) per hundredweight (CWT). Use the adjustment indices as listed in the proposal.

<i>Steel Product (Title)</i>	BI, MI*	Adjustment Date for MI	Category
Reinforcing Steel, Bridge Deck, and SIP Forms	Based on one or more Fastmarkets indices	Delivery Date from Producing Mill	1
Structural Steel and Encasement Pipe	Based on one or more Fastmarkets indices	Delivery Date from Producing Mill	2
Steel H-Piles, Soldier Pile Walls	Based on one or more Fastmarkets indices	Delivery Date from Producing Mill	3
Guardrail Items and Pipe Piles	Based on one or more Fastmarkets indices	Material Received Date**	4
Fence Items	Based on one or more Fastmarkets indices	Material Received Date**	5
Overhead Sign Assembly, Signal Poles, High Mount Standards	Based on one or more Fastmarkets indices	Material Received Date**	6
Prestressed Concrete Members	Based on one or more Fastmarkets indices	Cast Date of Member	7

Submit documentation to the Engineer for all items listed in the Contract for which the Contractor is requesting a steel price adjustment.

### Submittal Requirements

The items in categories 1,2, and 3, shall be specifically stored, labeled, or tagged, recognizable by color marking, and identifiable by Project for inspection and audit verification immediately upon arrival at the fabricator.

Furnish the following documentation for all steel products to be incorporated into the work and documented on Form SPA-2, found on the Departments website at the following address:

<https://connect.ncdot.gov/projects/construction/Construction%20Forms/Form%20SPA-2.xlsx>

Submit all documentation to the Engineer prior to incorporation of the steel into the completed work. The Department will withhold progress payments for the affected contract line item if the documentation is not provided and at the discretion of the Engineer the work is allowed to proceed. Progress payments will be made upon receipt of the delinquent documentation.

#### Step 1 (Form SPA -2)

Utilizing Form SPA-2, submit separate documentation packages for each line item from Form SPA-1 for which the Contractor opted for a steel price adjustment. For line items with multiple components of steel, each component should be listed separately. Label each SPA-2 documentation package with a unique number as described below.

- a. Documentation package number: (Insert the contract line-item) - (Insert sequential package number beginning with "1").  
Example: 412 - 1,  
          412 - 2,  
          424 - 1,  
          424 - 2,  
          424 - 3, etc.
- b. The steel product quantity in pounds
  - i. The following sources should be used, in declining order of precedence, to determine the weight of steel/iron, based on the Engineers decision:
    1. Department established weights of steel/iron by contract pay item per pay unit;
    2. Approved Shop Drawings;
    3. Verified Shipping Documents;
    4. Contract Plans;
    5. Standard Drawing Sheets;
    6. Industry Standards (i.e., AISC Manual of Steel Construction, AWWA Standards, etc.); and
    7. Manufacture's data.
  - ii. Any item requiring approved shop drawings shall have the weights of steel calculated and shown on the shop drawings or submitted and certified separately by the fabricator.
- c. The date the steel product, subject to adjustment, was shipped from the producing mill (Categories 1-3), received on the project (Categories 4-6), or casting date (Category 7).

#### Step 2 (Monthly Calculator Spreadsheet)

For each month, upon the incorporation of the steel product into the work, provide the Engineer the following:

- 1) Completed NCDOT Steel Price Adjustment Calculator Spreadsheet, summarizing all the steel submittal packages (Form SPA-2) actually incorporated into the completed work in the given month.
  - a. Contract Number
  - b. Bidding Index Reference Month
  - c. Contract Completion Date or Revised Completion Date
  - d. County, Route, and Project TIP information
  - e. Item Number
  - f. Line-Item Description
  - g. Submittal Number from Form SPA-2
  - h. Adjustment date
  - i. Pounds of Steel
- 2) An affidavit signed by the Contractor stating the documentation provided in the NCDOT Steel Price Adjustment Calculator Spreadsheet is true and accurate.

### Price Adjustment Conditions

Download the Monthly Steel Adjustment Spreadsheet with the most current reference data from the Department's website each month at the following address:

<https://connect.ncdot.gov/projects/construction/Construction%20Forms/Form%20SPA-3%20NCDOT%20Steel%20Price%20Adjustment%20Calculator.xlsx>

If the monthly Fastmarkets data is not available, the data for the most recent immediately preceding month will be used as the basis for adjustment.

### Price Adjustment Calculations

The price adjustment will be determined by comparing the percentage of change in index value listed in the proposal (BI) to the monthly index value (MI). (See included sample examples). Weights and date of shipment must be documented as required herein. The final price adjustment dollar value will be determined by multiplying this percentage increase or decrease in the index by the represented quantity of steel incorporated into the work, and the established bidding index (BI) subject to the limitations herein.

### Price increase/decrease will be computed as follows:

$$\text{SPA} = ((\text{MI} / \text{BI}) - 1) * \text{BI} * (\text{Q} / 100)$$

Where;

SPA = Steel price adjustment in dollars

MI = Monthly Shipping Index. - in Dollars (\$) per hundredweight (CWT). Use the adjustment indices from the month the steel was shipped from the producing mill, received on the project, or member cast as defined in the Product Relationship Table.

BI = Bidding Index. - in Dollars (\$) per hundredweight (CWT). Use the adjustment indices as listed in the proposal.

Q = Quantity of steel, product, pounds actually incorporated into the work as documented by the Contractor, or Design Build Team and verified by the Engineer.

Calculations for price adjustment shall be shown separate from the monthly progress estimate and will not be included in the total cost of work for determination of progress or for extension of Contract time in accordance with Subarticle 108-10(B)(1).

Any apparent attempt to unbalance bids in favor of items subject to price adjustment may result in rejection of the bid proposal.

Adjustments will be paid or charged to the Contractor only. Any Contractor receiving an adjustment under this provision shall distribute the proper proportional part of such adjustments to the subcontractor who performed the applicable work.

Delays to the work caused by steel shortages may be justification for a Contract time extension but will not constitute grounds for claims for standby equipment, extended office overhead, or other costs associated with such delays.

If an increase in the steel material price is anticipated to exceed 50% of the original quoted price, the contractor must notify the Department within 7 days prior to purchasing the material. Upon receipt of such notification, the Department will direct the Contractor to either (1) proceed with the work or (2) suspend the work and explore the use of alternate options.

If the decrease in the steel material exceeds 50% of the original quoted price, the contractor may submit to the Department additional market index information specific to the item in question to dispute the decrease. The Department will review this information and determine if the decrease is warranted.

When the steel product adjustment date, as defined in the Product Relationship Table, is after the approved contract completion date, the steel price adjustments will be based on the lesser value of either the MI for the month of the approved contract completion date or the MI for the actual adjustment date.

If the price adjustment is based on estimated material quantities for that time, and a revision to the total material quantity is made in a subsequent or final estimate, an appropriate adjustment will be made to the price adjustment previously calculated. The adjustment will be based on the same indices used to calculate the price adjustment which is being revised. If the adjustment date of the revised material quantity cannot be determined, the adjustment for the quantity in question, will be based on the indices utilized to calculate the steel price adjustment for the last initial documentation package submission, for the steel product subject to adjustment, that was incorporated into the particular item of work, for which quantities are being finalized.

Example: Structural steel for a particular bridge was provided for in three different shipments with each having a different mill shipping date. The quantity of structural steel actually used for the bridge was calculated and a steel price adjustment was made in a progress payment. At the conclusion of the work an error was found in the plans of the final quantity of structural steel used for the bridge. The quantity to be adjusted cannot be directly related to any one of the three mill shipping dates. The steel price adjustment for the quantity in question would be calculated using the indices that were utilized to calculate the steel price adjustment for the quantity of

structural steel represented by the last initial structural steel documentation package submission. The package used will be the one with the greatest sequential number.

**Extra Work/Force Account:**

When steel products, as specified herein, are added to the contract as extra work, in accordance with the provisions of Article 104-7 or 104-3, the Engineer will determine and specify in the supplemental agreement, the need for application of steel price adjustments on a case-by-case basis. No steel price adjustments will be made for any products manufactured from steel having an adjustment date prior to the supplemental agreement execution date. Price adjustments will be made as provided herein, except the Bidding Index will be based on the month in which the supplemental agreement pricing was executed.

For work performed on force account basis, reimbursement of actual material costs, along with the specified overhead and profit markup, will be considered to include full compensation for the current cost of steel and no steel price adjustments will be made.

**Examples Form SPA-2**

**Steel Price Adjustment Submission Form**

Contract Number C203394 Bid Reference Month January 2019

Submittal Date 8/31/2019

Contract Line Item 237

Line Item Description APPROX....LBS Structural Steel

Sequential Submittal Number 2

Supplier	Description of material	Location information	Quantity in lbs.	Adjustment Date
XYZ mill	Structural Steel	Structure 3, Spans A-C	1,200,000	May 4, 2020
ABC distributing	Various channel & angle shapes	Structure 3 Spans A-C	35,000	July 14, 2020
		Total Pounds of Steel	1,235,000	

Note: Attach the following supporting documentation to this form.

- Bill of Lading to support the shipping dates
- Supporting information for weight documentation (e.g., Pay item reference, Shop drawings, shipping documents, Standards Sheets, industry standards, or manufacturer's data)

By providing this data under my signature, I attest to the accuracy of and validity of the data on this form and certify that no deliberate misrepresentation in any manner has occurred.



Printed Name

Signature

---

**Examples Form SPA-2**  
**Steel Price Adjustment Submission Form**

Contract Number C203394 Bid Reference Month January 2019

Submittal Date August 31, 2019

Contract Line Item 237

Line Item Description SUPPORT, OVRHD SIGN STR -DFEB – STA 36+00

Sequential Submittal  
 Number 2

Supplier	Description of material	Location information	Quantity in lbs.	Adjustment Date
XYZ mill	Tubular Steel (Vertical legs)	<u>-DFEB – STA 36+00</u>	12000	December 11, 2021
PDQ Mill	4" Tubular steel (Horizontal legs)	<u>-DFEB – STA 36+00</u>	5900	December 11, 2021
ABC distributing	Various channel & angle shapes (see quote)	<u>-DFEB – STA 36+00</u>	1300	December 11, 2021
	Catwalk assembly	<u>-DFEB – STA 36+00</u>	2000	December 11, 2021
Nucor	Flat plate	<u>-DFEB – STA 36+00</u>	650	December 11, 2021
		Total Pounds of Steel	21,850	

Note: Attach the following supporting documentation to this form.

- Bill of Lading to support the shipping dates
- Supporting information for weight documentation (e.g., Pay item reference, Shop drawings, shipping documents, Standards Sheets, industry standards, or manufacturer's data)

By providing this data under my signature, I attest to the accuracy of and validity of the data on this form and certify that no deliberate misrepresentation in any manner has occurred.

Printed Name

Signature

---

### Price Adjustment Sample Calculation (increase)

---

Project bid on September 17, 2019

Line Item 635 "Structural Steel" has a plan quantity of 2,717,000 lbs.

Bidding Index for Structural Steel (Category 2) in the proposal was \$36.12/CWT = BI

450,000 lbs. of Structural Steel for Structure 2 at Station 44+08.60 were shipped to fabricator from the producing mill in same month, May 2021.

Monthly Index for Structural Steel (Category 2) for May 2021 was \$64.89/CWT = MI

The Steel Price Adjustment formula is as follows:

$$\text{SPA} = ((\text{MI} / \text{BI}) - 1) * \text{BI} * (\text{Q} / 100)$$

Where; SPA = Steel price adjustment in dollars

BI = Bidding Index – in dollars (\$) per hundredweight (CWT). Use the adjustment indices as listed in the proposal.

MI = Mill Shipping Index – in dollars (\$) per hundredweight (CWT). Use the adjustment indices from the month the steel was shipped from the producing mill, received on the project, or member cast as defined in the Product Relationship Table.

Q = Quantity of steel product, in pounds (lbs.) actually incorporated into the work as documented by the Contractor, or Design Build Team and verified by the Engineer.

$$\text{BI} = \$36.12 / \text{CWT}$$

$$\text{MI} = \$64.89 / \text{CWT}$$

$$\% \text{ change} = ((\text{MI} / \text{BI}) - 1) = (\$64.89 / \$36.12 - 1) = (1.79651 - 1) = 0.79651162791$$

$$\text{Q} = 450,000 \text{ lbs.}$$

$$\text{SPA} = 0.79651162791 \times \$36.12 \times (450,000 / 100)$$

$$\text{SPA} = 0.79651162791 * \$36.12 * 4,500$$

$$\text{SPA} = \$129,465 \text{ pay adjustment to Contractor for Structural Steel (Structure 2 at Station 44+08.60)}$$

### Price Adjustment Sample Calculation (decrease)

---

Project bid on December 18, 2018

Line Item 635 Structural Steel has a plan quantity of 2,717,000 lbs.

Bidding Index for Structural Steel (Category 2) in the proposal was \$46.72/CWT = BI

600,000 lbs. of Structural Steel for Structure 1 at Station 22+57.68 were shipped to fabricator from the producing mill in same month, August 2020.

Monthly Index for Structural Steel (Category 2) for August 2020 was \$27.03/CWT = MI

The Steel Price Adjustment formula is as follows:

$$\text{SPA} = ((\text{MI} / \text{BI}) - 1) * \text{BI} * (\text{Q} / 100)$$

Where; SPA = Steel price adjustment in dollars

BI = Bidding Index – in dollars (\$) per hundredweight (CWT). Use the adjustment indices as listed in the proposal.

MI = Mill Shipping Index – in dollars (\$) per hundredweight (CWT). Use the adjustment indices from the month the steel was shipped from the producing mill, received on the project, or member cast as defined in the Product Relationship Table.

Q = Quantity of steel product, in pounds (lbs.) actually incorporated into the work as documented by the Contractor, or Design Build Team and verified by the Engineer.

$$\text{BI} = \$46.72 / \text{CWT}$$

$$\text{MI} = \$27.03 / \text{CWT}$$

$$\% \text{ change} = ((\text{MI} / \text{BI}) - 1) = (\$27.03 / \$46.72 - 1) = (0.57855 - 1) = -0.421446917808$$

$$\text{Q} = 600,000 \text{ lbs.}$$

$$\text{SPA} = -0.421446917808 * \$46.72 * (600,000 / 100)$$

$$\text{SPA} = -0.421446917808 * \$46.72 * 6,000$$

$$\text{SPA} = \$ 118,140.00 \text{ Credit to the Department for Structural Steel (Structure 1 at Station 22+57.68)}$$

### Price Adjustment Sample Calculation (increase)

---

Project bid on July 16, 2020

Line Item 614 Reinforced Concrete Deck Slab has a plan quantity of 241974 lbs.

Bidding Index Reference Month was May 2020. Bidding Index for Reinforced Concrete Deck Slab (Category 1) in the proposal was \$29.21/CWT = BI

51,621 lbs. of reinforcing steel and 52,311 lbs. of epoxy coated reinforcing steel for Structure 2 at Station 107+45.55 -L- was shipped to fabricator from the producing mill in same month, May 2021.

Monthly Index for Reinforced Concrete Deck Slab (Category 1) for May 2021 was \$43.13/CWT = MI

The Steel Price Adjustment formula is as follows:

$$\text{SPA} = ((\text{MI} / \text{BI}) - 1) * \text{BI} * (\text{Q} / 100)$$

Where; SPA = Steel price adjustment in dollars

BI = Bidding Index – in dollars (\$) per hundredweight (CWT). Use the adjustment indices as listed in the proposal.

MI = Mill Shipping Index – in dollars (\$) per hundredweight (CWT). Use the adjustment indices from the month the steel was shipped from the producing mill, received on the project, or member cast as defined in the Product Relationship Table.

Q = Quantity of steel product, in pounds (lbs.) actually incorporated into the work as documented by the Contractor, or Design Build Team and verified by the Engineer.

$$\text{BI} = \$29.21 / \text{CWT}$$

$$\text{MI} = \$43.13 / \text{CWT}$$

$$\% \text{ change} = ((\text{MI} / \text{BI}) - 1) = (\$43.13 / \$29.21 - 1) = (1.47655 - 1) = 0.47654912701$$

$$\text{Q} = 103932 \text{ lbs.}$$

$$\text{SPA} = 0.47654912701 * \$29.21 * (103,932 / 100)$$

$$\text{SPA} = 0.47654912701 * \$29.21 * 1,039.32$$

SPA = \$14,467.33 Pay Adjustment to Contractor for Reinforced Concrete Deck Slab (Category 1) at Station 107+45.55 -L-

**SCHEDULE OF ESTIMATED COMPLETION PROGRESS:**

(7-15-08) (Rev. 7-19-22)

108-2

SP1 G58

The Contractor's attention is directed to the Standard Special Provision entitled *Availability of Funds Termination of Contracts* included elsewhere in this proposal. The Department of Transportation's schedule of estimated completion progress for this project as required by that Standard Special Provision is as follows:

	<b><u>Fiscal Year</u></b>	<b><u>Progress (% of Dollar Value)</u></b>
2023	(7/01/22 - 6/30/23)	<b>62%</b> of Total Amount Bid
2024	(7/01/23 - 6/30/24)	<b>38%</b> of Total Amount Bid

The Contractor shall also furnish his own progress schedule in accordance with Article 108-2 of the *2018 Standard Specifications*. Any acceleration of the progress as shown by the Contractor's progress schedule over the progress as shown above shall be subject to the approval of the Engineer.

**DISADVANTAGED BUSINESS ENTERPRISE:**

(10-16-07)(Rev. 8-17-21)

102-15(J)

SP1 G61

**Description**

The purpose of this Special Provision is to carry out the U.S. Department of Transportation's policy of ensuring nondiscrimination in the award and administration of contracts financed in whole or in part with Federal funds. This provision is guided by 49 CFR Part 26.

**Definitions**

*Additional DBE Subcontractors* - Any DBE submitted at the time of bid that will not be used to meet the DBE goal. No submittal of a Letter of Intent is required.

*Committed DBE Subcontractor* - Any DBE submitted at the time of bid that is being used to meet the DBE goal by submission of a Letter of Intent. Or any DBE used as a replacement for a previously committed DBE firm.

*Contract Goal Requirement* - The approved DBE participation at time of award, but not greater than the advertised contract goal.

*DBE Goal* - A portion of the total contract, expressed as a percentage, that is to be performed by committed DBE subcontractor(s).

*Disadvantaged Business Enterprise (DBE)* - A firm certified as a Disadvantaged Business Enterprise through the North Carolina Unified Certification Program.

*Goal Confirmation Letter* - Written documentation from the Department to the bidder confirming the Contractor's approved, committed DBE participation along with a listing of the committed DBE firms.

*Manufacturer* - A firm that operates or maintains a factory or establishment that produces on the premises, the materials or supplies obtained by the Contractor.

*Regular Dealer* - A firm that owns, operates, or maintains a store, warehouse, or other establishment in which the materials or supplies required for the performance of the contract are bought, kept in stock, and regularly sold to the public in the usual course of business. A regular dealer engages in, as its principal business and in its own name, the purchase and sale or lease of the products in question. A regular dealer in such bulk items as steel, cement, gravel, stone, and petroleum products need not keep such products in stock, if it owns and operates distribution equipment for the products. Brokers and packagers are not regarded as manufacturers or regular dealers within the meaning of this section.

*Replacement / Substitution* – A full or partial reduction in the amount of work subcontracted to a committed (or an approved substitute) DBE firm.

*North Carolina Unified Certification Program (NCUCP)* - A program that provides comprehensive services and information to applicants for DBE certification, such that an applicant is required to apply only once for a DBE certification that will be honored by all recipients of USDOT funds in the state and not limited to the Department of Transportation only. The Certification Program is in accordance with 49 CFR Part 26.

*United States Department of Transportation (USDOT)* - Federal agency responsible for issuing regulations (49 CFR Part 26) and official guidance for the DBE program.

### **Forms and Websites Referenced in this Provision**

*DBE Payment Tracking System* - On-line system in which the Contractor enters the payments made to DBE subcontractors who have performed work on the project.  
<https://apps.dot.state.nc.us/Vendor/PaymentTracking/>

*DBE-IS Subcontractor Payment Information* - Form for reporting the payments made to all DBE firms working on the project. This form is for paper bid projects only.  
<https://connect.ncdot.gov/business/Turnpike/Documents/Form%20DBE-IS%20Subcontractor%20Payment%20Information.pdf>

*RF-1 DBE Replacement Request Form* - Form for replacing a committed DBE.  
<http://connect.ncdot.gov/projects/construction/Construction%20Forms/DBE%20MBE%20WBE%20Replacement%20Request%20Form.pdf>

*SAF Subcontract Approval Form* - Form required for approval to sublet the contract.  
<http://connect.ncdot.gov/projects/construction/Construction%20Forms/Subcontract%20Approval%20Form%20Rev.%202012.zip>

*JC-1 Joint Check Notification Form* - Form and procedures for joint check notification. The form acts as a written joint check agreement among the parties providing full and prompt disclosure of the expected use of joint checks.  
<http://connect.ncdot.gov/projects/construction/Construction%20Forms/Joint%20Check%20Notification%20Form.pdf>

*Letter of Intent* - Form signed by the Contractor and the DBE subcontractor, manufacturer or regular dealer that affirms that a portion of said contract is going to be performed by the signed DBE for the estimated amount (based on quantities and unit prices) listed at the time of bid.

<http://connect.ncdot.gov/letting/LetCentral/Letter%20of%20Intent%20to%20Perform%20as%20a%20Subcontractor.pdf>

*Listing of DBE Subcontractors Form* - Form for entering DBE subcontractors on a project that will meet this DBE goal. This form is for paper bids only.

[http://connect.ncdot.gov/municipalities/Bid%20Proposals%20for%20LGA%20Content/08%20DBE%20Subcontractors%20\(Federal\).docx](http://connect.ncdot.gov/municipalities/Bid%20Proposals%20for%20LGA%20Content/08%20DBE%20Subcontractors%20(Federal).docx)

*Subcontractor Quote Comparison Sheet* - Spreadsheet for showing all subcontractor quotes in the work areas where DBEs quoted on the project. This sheet is submitted with good faith effort packages.

<http://connect.ncdot.gov/business/SmallBusiness/Documents/DBE%20Subcontractor%20Quote%20Comparison%20Example.xls>

### **DBE Goal**

The following DBE goal for participation by Disadvantaged Business Enterprises is established for this contract:

Disadvantaged Business Enterprises **4.0** %

- (A) *If the DBE goal is more than zero*, the Contractor shall exercise all necessary and reasonable steps to ensure that DBEs participate in at least the percent of the contract as set forth above as the DBE goal.
- (B) *If the DBE goal is zero*, the Contractor shall make an effort to recruit and use DBEs during the performance of the contract. Any DBE participation obtained shall be reported to the Department.

### **Directory of Transportation Firms (Directory)**

Real-time information is available about firms doing business with the Department and firms that are certified through NCUCP in the Directory of Transportation Firms. Only firms identified in the Directory as DBE certified shall be used to meet the DBE goal. The Directory can be found at the following link. [https:// www.ebs.nc.gov/VendorDirectory/default.html](https://www.ebs.nc.gov/VendorDirectory/default.html)

The listing of an individual firm in the directory shall not be construed as an endorsement of the firm's capability to perform certain work.

### **Listing of DBE Subcontractors**

At the time of bid, bidders shall submit all DBE participation that they anticipate to use during the life of the contract. Only those identified to meet the DBE goal will be considered committed, even though the listing shall include both committed DBE subcontractors and additional DBE subcontractors. Additional DBE subcontractor participation submitted at the time of bid will be used toward the Department's overall race-neutral goal. Only those firms with current DBE

certification at the time of bid opening will be acceptable for listing in the bidder's submittal of DBE participation. The Contractor shall indicate the following required information:

(A) Electronic Bids

Bidders shall submit a listing of DBE participation in the appropriate section of the electronic submittal file.

- (1) Submit the names and addresses of DBE firms identified to participate in the contract. If the bidder uses the updated listing of DBE firms shown in the electronic submittal file, the bidder may use the dropdown menu to access the name and address of the DBE firm.
- (2) Submit the contract line numbers of work to be performed by each DBE firm. When no figures or firms are entered, the bidder will be considered to have no DBE participation.
- (3) The bidder shall be responsible for ensuring that the DBE is certified at the time of bid by checking the Directory of Transportation Firms. If the firm is not certified at the time of the bid-letting, that DBE's participation will not count towards achieving the DBE goal.

(B) Paper Bids

- (1) *If the DBE goal is more than zero,*
  - (a) Bidders, at the time the bid proposal is submitted, shall submit a listing of DBE participation, including the names and addresses on *Listing of DBE Subcontractors* contained elsewhere in the contract documents in order for the bid to be considered responsive. Bidders shall indicate the total dollar value of the DBE participation for the contract.
  - (b) If bidders have no DBE participation, they shall indicate this on the *Listing of DBE Subcontractors* by entering the word "None" or the number "0." This form shall be completed in its entirety. **Blank forms will not be deemed to represent zero participation.** Bids submitted that do not have DBE participation indicated on the appropriate form will not be read publicly during the opening of bids. The Department will not consider these bids for award and the proposal will be rejected.
  - (c) The bidder shall be responsible for ensuring that the DBE is certified at the time of bid by checking the Directory of Transportation Firms. If the firm is not certified at the time of the bid-letting, that DBE's participation will not count towards achieving the corresponding goal.
- (2) *If the DBE goal is zero,* entries on the *Listing of DBE Subcontractors* are not required for the zero goal, however any DBE participation that is achieved during the project shall be reported in accordance with requirements contained elsewhere in the special provision.



**DBE Prime Contractor**

When a certified DBE firm bids on a contract that contains a DBE goal, the DBE firm is responsible for meeting the goal or making good faith efforts to meet the goal, just like any other bidder. In most cases, a DBE bidder on a contract will meet the DBE goal by virtue of the work it performs on the contract with its own forces. However, all the work that is performed by the DBE bidder and any other DBE subcontractors will count toward the DBE goal. The DBE bidder shall list itself along with any DBE subcontractors, if any, in order to receive credit toward the DBE goal.

For example, if the DBE goal is 45% and the DBE bidder will only perform 40% of the contract work, the prime will list itself at 40%, and the additional 5% shall be obtained through additional DBE participation with DBE subcontractors or documented through a good faith effort.

DBE prime contractors shall also follow Sections A and B listed under *Listing of DBE Subcontractor* just as a non-DBE bidder would.

**Written Documentation – Letter of Intent**

The bidder shall submit written documentation for each DBE that will be used to meet the DBE goal of the contract, indicating the bidder's commitment to use the DBE in the contract. This documentation shall be submitted on the Department's form titled *Letter of Intent*.

The documentation shall be received in the office of the State Contractor Utilization Engineer or at DBE@ncdot.gov no later than 10:00 a.m. of the sixth calendar day following opening of bids, unless the sixth day falls on an official state holiday. In that situation, it is due in the office of the State Contractor Utilization Engineer no later than 10:00 a.m. on the next official state business day.

If the bidder fails to submit the Letter of Intent from each committed DBE to be used toward the DBE goal, or if the form is incomplete (i.e. both signatures are not present), the DBE participation will not count toward meeting the DBE goal. If the lack of this participation drops the commitment below the DBE goal, the Contractor shall submit evidence of good faith efforts, completed in its entirety, to the State Contractor Utilization Engineer or DBE@ncdot.gov no later than 10:00 a.m. on the eighth calendar day following opening of bids, unless the eighth day falls on an official state holiday. In that situation, it is due in the office of the State Contractor Utilization Engineer no later than 10:00 a.m. on the next official state business day.

**Submission of Good Faith Effort**

If the bidder fails to meet or exceed the DBE goal, the apparent lowest responsive bidder shall submit to the Department documentation of adequate good faith efforts made to reach the DBE goal.

A hard copy and an electronic copy of this information shall be received in the office of the State Contractor Utilization Engineer or at DBE@ncdot.gov no later than 10:00 a.m. on the sixth calendar day following opening of bids unless the sixth day falls on an official state holiday. In that situation, it is due in the office of the State Contractor Utilization Engineer no later than 10:00 a.m.

on the next official state business day. If the contractor cannot send the information electronically, then one complete set and 5 copies of this information shall be received under the same time constraints above.

Note: Where the information submitted includes repetitious solicitation letters, it will be acceptable to submit a representative letter along with a distribution list of the firms that were solicited. Documentation of DBE quotations shall be a part of the good faith effort submittal. This documentation may include written subcontractor quotations, telephone log notations of verbal quotations, or other types of quotation documentation.

### **Consideration of Good Faith Effort for Projects with DBE Goals More Than Zero**

Adequate good faith efforts mean that the bidder took all necessary and reasonable steps to achieve the goal which, by their scope, intensity, and appropriateness, could reasonably be expected to obtain sufficient DBE participation. Adequate good faith efforts also mean that the bidder actively and aggressively sought DBE participation. Mere *pro forma* efforts are not considered good faith efforts.

The Department will consider the quality, quantity, and intensity of the different kinds of efforts a bidder has made. Listed below are examples of the types of actions a bidder will take in making a good faith effort to meet the goal and are not intended to be exclusive or exhaustive, nor is it intended to be a mandatory checklist.

- (A) Soliciting through all reasonable and available means (e.g. attendance at pre-bid meetings, advertising, written notices, use of verifiable electronic means through the use of the NCDOT Directory of Transportation Firms) the interest of all certified DBEs who have the capability to perform the work of the contract. The bidder must solicit this interest within at least 10 days prior to bid opening to allow the DBEs to respond to the solicitation. Solicitation shall provide the opportunity to DBEs within the Division and surrounding Divisions where the project is located. The bidder must determine with certainty if the DBEs are interested by taking appropriate steps to follow up initial solicitations.
- (B) Selecting portions of the work to be performed by DBEs in order to increase the likelihood that the DBE goals will be achieved.
  - (1) Where appropriate, break out contract work items into economically feasible units to facilitate DBE participation, even when the prime contractor might otherwise prefer to perform these work items with its own forces.
  - (2) Negotiate with subcontractors to assume part of the responsibility to meet the contract DBE goal when the work to be sublet includes potential for DBE participation (2<sup>nd</sup> and 3<sup>rd</sup> tier subcontractors).
- (C) Providing interested DBEs with adequate information about the plans, specifications, and requirements of the contract in a timely manner to assist them in responding to a solicitation.
- (D) (1) Negotiating in good faith with interested DBEs. It is the bidder's responsibility to

make a portion of the work available to DBE subcontractors and suppliers and to select those portions of the work or material needs consistent with the available DBE subcontractors and suppliers, to facilitate DBE participation. Evidence of such negotiation includes the names, addresses, and telephone numbers of DBEs that were considered; a description of the information provided regarding the plans and specifications for the work selected for subcontracting; and evidence as to why additional agreements could not be reached for DBEs to perform the work.

- (2) A bidder using good business judgment would consider a number of factors in negotiating with subcontractors, including DBE subcontractors, and would take a firm's price and capabilities as well as contract goals into consideration. However, the fact that there may be some additional costs involved in finding and using DBEs is not in itself sufficient reason for a bidder's failure to meet the contract DBE goal, as long as such costs are reasonable. Also, the ability or desire of a prime contractor to perform the work of a contract with its own organization does not relieve the bidder of the responsibility to make good faith efforts. Bidding contractors are not, however, required to accept higher quotes from DBEs if the price difference is excessive or unreasonable.
- (E) Not rejecting DBEs as being unqualified without sound reasons based on a thorough investigation of their capabilities. The bidder's standing within its industry, membership in specific groups, organizations, or associates and political or social affiliations (for example, union vs. non-union employee status) are not legitimate causes for the rejection or non-solicitation of bids in the bidder's efforts to meet the project goal.
- (F) Making efforts to assist interested DBEs in obtaining bonding, lines of credit, or insurance as required by the recipient or bidder.
- (G) Making efforts to assist interested DBEs in obtaining necessary equipment, supplies, materials, or related assistance or services.
- (H) Effectively using the services of available minority/women community organizations; minority/women contractors' groups; Federal, State, and local minority/women business assistance offices; and other organizations as allowed on a case-by-case basis to provide assistance in the recruitment and placement of DBEs. Contact within 7 days from the bid opening the Business Opportunity and Work Force Development Unit at [BOWD@ncdot.gov](mailto:BOWD@ncdot.gov) to give notification of the bidder's inability to get DBE quotes.
- (I) Any other evidence that the bidder submits which shows that the bidder has made reasonable good faith efforts to meet the DBE goal.

In addition, the Department may take into account the following:

- (1) Whether the bidder's documentation reflects a clear and realistic plan for achieving the DBE goal.
- (2) The bidders' past performance in meeting the DBE goals.

- (3) The performance of other bidders in meeting the DBE goal. For example, when the apparent successful bidder fails to meet the DBE goal, but others meet it, you may reasonably raise the question of whether, with additional reasonable efforts the apparent successful bidder could have met the goal. If the apparent successful bidder fails to meet the DBE goal, but meets or exceeds the average DBE participation obtained by other bidders, the Department may view this, in conjunction with other factors, as evidence of the apparent successful bidder having made a good faith effort.

If the Department does not award the contract to the apparent lowest responsive bidder, the Department reserves the right to award the contract to the next lowest responsive bidder that can satisfy to the Department that the DBE goal can be met or that an adequate good faith effort has been made to meet the DBE goal.

### **Non-Good Faith Appeal**

The State Prequalification Engineer will notify the contractor verbally and in writing of non-good faith. A contractor may appeal a determination of non-good faith made by the Goal Compliance Committee. If a contractor wishes to appeal the determination made by the Committee, they shall provide written notification to the State Prequalification Engineer or at [DBE@ncdot.gov](mailto:DBE@ncdot.gov). The appeal shall be made within 2 business days of notification of the determination of non-good faith.

### **Counting DBE Participation Toward Meeting DBE Goal**

#### **(A) Participation**

The total dollar value of the participation by a committed DBE will be counted toward the contract goal requirement. The total dollar value of participation by a committed DBE will be based upon the value of work actually performed by the DBE and the actual payments to DBE firms by the Contractor.

#### **(B) Joint Checks**

Prior notification of joint check use shall be required when counting DBE participation for services or purchases that involves the use of a joint check. Notification shall be through submission of Form JC-1 (*Joint Check Notification Form*) and the use of joint checks shall be in accordance with the Department's Joint Check Procedures.

#### **(C) Subcontracts (Non-Trucking)**

A DBE may enter into subcontracts. Work that a DBE subcontracts to another DBE firm may be counted toward the contract goal requirement. Work that a DBE subcontracts to a non-DBE firm does not count toward the contract goal requirement. If a DBE contractor or subcontractor subcontracts a significantly greater portion of the work of the contract than would be expected on the basis of standard industry practices, it shall be presumed that the DBE is not performing a commercially useful function. The DBE may present evidence to rebut this presumption to the Department. The Department's decision on the rebuttal of this presumption is subject to review by the Federal Highway Administration but is not administratively appealable to USDOT.

## (D) Joint Venture

When a DBE performs as a participant in a joint venture, the Contractor may count toward its contract goal requirement a portion of the total value of participation with the DBE in the joint venture, that portion of the total dollar value being a distinct clearly defined portion of work that the DBE performs with its forces.

## (E) Suppliers

A contractor may count toward its DBE requirement 60 percent of its expenditures for materials and supplies required to complete the contract and obtained from a DBE regular dealer and 100 percent of such expenditures from a DBE manufacturer.

## (F) Manufacturers and Regular Dealers

A contractor may count toward its DBE requirement the following expenditures to DBE firms that are not manufacturers or regular dealers:

- (1) The fees or commissions charged by a DBE firm for providing a *bona fide* service, such as professional, technical, consultant, or managerial services, or for providing bonds or insurance specifically required for the performance of a DOT-assisted contract, provided the fees or commissions are determined to be reasonable and not excessive as compared with fees and commissions customarily allowed for similar services.
- (2) With respect to materials or supplies purchased from a DBE, which is neither a manufacturer nor a regular dealer, count the entire amount of fees or commissions charged for assistance in the procurement of the materials and supplies, or fees or transportation charges for the delivery of materials or supplies required on a job site (but not the cost of the materials and supplies themselves), provided the fees are determined to be reasonable and not excessive as compared with fees customarily allowed for similar services.

**Commercially Useful Function**

## (A) DBE Utilization

The Contractor may count toward its contract goal requirement only expenditures to DBEs that perform a commercially useful function in the work of a contract. A DBE performs a commercially useful function when it is responsible for execution of the work of the contract and is carrying out its responsibilities by actually performing, managing, and supervising the work involved. To perform a commercially useful function, the DBE shall also be responsible with respect to materials and supplies used on the contract, for negotiating price, determining quality and quantity, ordering the material and installing (where applicable) and paying for the material itself. To determine whether a DBE is performing a commercially useful function, the Department will evaluate the amount of work subcontracted, industry practices, whether the amount the firm is to be paid under the

contract is commensurate with the work it is actually performing and the DBE credit claimed for its performance of the work, and any other relevant factors.

(B) DBE Utilization in Trucking

The following factors will be used to determine if a DBE trucking firm is performing a commercially useful function:

- (1) The DBE shall be responsible for the management and supervision of the entire trucking operation for which it is responsible on a particular contract, and there shall not be a contrived arrangement for the purpose of meeting DBE goals.
- (2) The DBE shall itself own and operate at least one fully licensed, insured, and operational truck used on the contract.
- (3) The DBE receives credit for the total value of the transportation services it provides on the contract using trucks it owns, insures, and operates using drivers it employs.
- (4) The DBE may subcontract the work to another DBE firm, including an owner-operator who is certified as a DBE. The DBE who subcontracts work to another DBE receives credit for the total value of the transportation services the subcontracted DBE provides on the contract.
- (5) The DBE may also subcontract the work to a non-DBE firm, including from an owner-operator. The DBE who subcontracts the work to a non-DBE is entitled to credit for the total value of transportation services provided by the non-DBE subcontractor not to exceed the value of transportation services provided by DBE-owned trucks on the contract. Additional participation by non-DBE subcontractors receives credit only for the fee or commission it receives as a result of the subcontract arrangement. The value of services performed under subcontract agreements between the DBE and the Contractor will not count towards the DBE contract requirement.
- (6) A DBE may lease truck(s) from an established equipment leasing business open to the general public. The lease must indicate that the DBE has exclusive use of and control over the truck. This requirement does not preclude the leased truck from working for others during the term of the lease with the consent of the DBE, so long as the lease gives the DBE absolute priority for use of the leased truck. This type of lease may count toward the DBE's credit as long as the driver is under the DBE's payroll.
- (7) Subcontracted/leased trucks shall display clearly on the dashboard the name of the DBE that they are subcontracted/leased to and their own company name if it is not identified on the truck itself. Magnetic door signs are not permitted.

**DBE Replacement**

When a Contractor has relied on a commitment to a DBE subcontractor (or an approved substitute DBE subcontractor) to meet all or part of a contract goal requirement, the contractor shall not

terminate the DBE subcontractor for convenience. This includes, but is not limited to, instances in which the Contractor seeks to perform the work of the terminated subcontractor with another DBE subcontractor, a non-DBE subcontractor, or with the Contractor's own forces or those of an affiliate.

The Contractor must give notice in writing both by certified mail and email to the DBE subcontractor, with a copy to the Engineer of its intent to request to terminate and/or substitute, and the reason for the request. The Contractor must give the DBE subcontractor five (5) business days to respond to the Contractor's Notice of Intent to Request Termination and/or Substitution. If the DBE subcontractor objects to the intended termination/substitution, the DBE, within five (5) business days must advise the Contractor and the Department of the reasons why the action should not be approved. The five-day notice period shall begin on the next business day after written notice is provided to the DBE subcontractor.

A committed DBE subcontractor may only be terminated after receiving the Department's written approval based upon a finding of good cause for the proposed termination and/or substitution. For purposes of this section, good cause shall include the following circumstances:

- (a) The listed DBE subcontractor fails or refuses to execute a written contract;
- (b) The listed DBE subcontractor fails or refuses to perform the work of its subcontract in a way consistent with normal industry standards. Provided, however, that good cause does not exist if the failure or refusal of the DBE subcontractor to perform its work on the subcontract results from the bad faith or discriminatory action of the prime contractor;
- (c) The listed DBE subcontractor fails or refuses to meet the prime contractor's reasonable, nondiscriminatory bond requirements;
- (d) The listed DBE subcontractor becomes bankrupt, insolvent, or exhibits credit unworthiness;
- (e) The listed DBE subcontractor is ineligible to work on public works projects because of suspension and debarment proceedings pursuant to 2 CFR Parts 180, 215 and 1,200 or applicable state law;
- (f) The listed DBE subcontractor is not a responsible contractor;
- (g) The listed DBE voluntarily withdraws from the project and provides written notice of withdrawal;
- (h) The listed DBE is ineligible to receive DBE credit for the type of work required;
- (i) A DBE owner dies or becomes disabled with the result that the listed DBE contractor is unable to complete its work on the contract;
- (j) Other documented good cause that compels the termination of the DBE subcontractor. Provided, that good cause does not exist if the prime contractor seeks to terminate a DBE it relied upon to obtain the contract so that the prime contractor can self-perform the work for which the DBE contractor was engaged or so that the prime contractor can substitute another DBE or non-DBE contractor after contract award.

The Contractor shall comply with the following for replacement of a committed DBE:

(A) Performance Related Replacement

When a committed DBE is terminated for good cause as stated above, an additional DBE that was submitted at the time of bid may be used to fulfill the DBE commitment. A good faith effort will only be required for removing a committed DBE if there were no additional DBEs submitted at the time of bid to cover the same amount of work as the DBE that was terminated.

If a replacement DBE is not found that can perform at least the same amount of work as the terminated DBE, the Contractor shall submit a good faith effort documenting the steps taken. Such documentation shall include, but not be limited to, the following:

- (1) Copies of written notification to DBEs that their interest is solicited in contracting the work defaulted by the previous DBE or in subcontracting other items of work in the contract.
  - (2) Efforts to negotiate with DBEs for specific subbids including, at a minimum:
    - (a) The names, addresses, and telephone numbers of DBEs who were contacted.
    - (b) A description of the information provided to DBEs regarding the plans and specifications for portions of the work to be performed.
  - (3) A list of reasons why DBE quotes were not accepted.
  - (4) Efforts made to assist the DBEs contacted, if needed, in obtaining bonding or insurance required by the Contractor.
- (B) Decertification Replacement
- (1) When a committed DBE is decertified by the Department after the SAF (*Subcontract Approval Form*) has been received by the Department, the Department will not require the Contractor to solicit replacement DBE participation equal to the remaining work to be performed by the decertified firm. The participation equal to the remaining work performed by the decertified firm will count toward the contract goal requirement.
  - (2) When a committed DBE is decertified prior to the Department receiving the SAF (*Subcontract Approval Form*) for the named DBE firm, the Contractor shall take all necessary and reasonable steps to replace the DBE subcontractor with another DBE subcontractor to perform at least the same amount of work to meet the DBE goal requirement. If a DBE firm is not found to do the same amount of work, a good faith effort must be submitted to NCDOT (see A herein for required documentation).
  - (3) Exception: If the DBE's ineligibility is caused solely by its having exceeded the size standard during the performance of the contract, the Department will not require the Contractor to solicit replacement DBE participation equal to the remaining work to be performed by the decertified firm. The participation equal to the remaining work performed by the decertified firm will count toward the contract goal requirement and overall goal.

All requests for replacement of a committed DBE firm shall be submitted to the Engineer for approval on Form RF-1 (*DBE Replacement Request*). If the Contractor fails to follow this procedure, the Contractor may be disqualified from further bidding for a period of up to 6 months.



**Changes in the Work**

When the Engineer makes changes that result in the reduction or elimination of work to be performed by a committed DBE, the Contractor will not be required to seek additional participation. When the Engineer makes changes that result in additional work to be performed by a DBE based upon the Contractor's commitment, the DBE shall participate in additional work to the same extent as the DBE participated in the original contract work.

When the Engineer makes changes that result in extra work, which has more than a minimal impact on the contract amount, the Contractor shall seek additional participation by DBEs unless otherwise approved by the Engineer.

When the Engineer makes changes that result in an alteration of plans or details of construction, and a portion or all of the work had been expected to be performed by a committed DBE, the Contractor shall seek participation by DBEs unless otherwise approved by the Engineer.

When the Contractor requests changes in the work that result in the reduction or elimination of work that the Contractor committed to be performed by a DBE, the Contractor shall seek additional participation by DBEs equal to the reduced DBE participation caused by the changes.

**Reports and Documentation**

A SAF (*Subcontract Approval Form*) shall be submitted for all work which is to be performed by a DBE subcontractor. The Department reserves the right to require copies of actual subcontract agreements involving DBE subcontractors.

When using transportation services to meet the contract commitment, the Contractor shall submit a proposed trucking plan in addition to the SAF. The plan shall be submitted prior to beginning construction on the project. The plan shall include the names of all trucking firms proposed for use, their certification type(s), the number of trucks owned by the firm, as well as the individual truck identification numbers, and the line item(s) being performed.

Within 30 calendar days of entering into an agreement with a DBE for materials, supplies or services, not otherwise documented by the SAF as specified above, the Contractor shall furnish the Engineer a copy of the agreement. The documentation shall also indicate the percentage (60% or 100%) of expenditures claimed for DBE credit.

**Reporting Disadvantaged Business Enterprise Participation**

The Contractor shall provide the Engineer with an accounting of payments made to all DBE firms, including material suppliers and contractors at all levels (prime, subcontractor, or second tier subcontractor). This accounting shall be furnished to the Engineer for any given month by the end of the following month. Failure to submit this information accordingly may result in the following action:

- (A) Withholding of money due in the next partial pay estimate; or
- (B) Removal of an approved contractor from the prequalified bidders' list or the removal of other entities from the approved subcontractors list.

While each contractor (prime, subcontractor, 2nd tier subcontractor) is responsible for accurate accounting of payments to DBEs, it shall be the prime contractor's responsibility to report all monthly and final payment information in the correct reporting manner.

Failure on the part of the Contractor to submit the required information in the time frame specified may result in the disqualification of that contractor and any affiliate companies from further bidding until the required information is submitted.

Failure on the part of any subcontractor to submit the required information in the time frame specified may result in the disqualification of that contractor and any affiliate companies from being approved for work on future DOT projects until the required information is submitted.

Contractors reporting transportation services provided by non-DBE lessees shall evaluate the value of services provided during the month of the reporting period only.

At any time, the Engineer can request written verification of subcontractor payments.

The Contractor shall report the accounting of payments through the Department's DBE Payment Tracking System.

### **Failure to Meet Contract Requirements**

Failure to meet contract requirements in accordance with Subarticle 102-15(J) of the *2018 Standard Specifications* may be cause to disqualify the Contractor.

### **CERTIFICATION FOR FEDERAL-AID CONTRACTS:**

(3-21-90)

SP1 G85

The prospective participant certifies, by signing and submitting this bid or proposal, to the best of his or her knowledge and belief, that:

- (A) No Federal appropriated funds have been paid or will be paid, by or on behalf of the undersigned, to any person for influencing or attempting to influence an officer or employee of any Federal agency, a Member of Congress, an officer or employee of Congress, or an employee of a Member of Congress in connection with the awarding of any Federal contract, the making of any Federal grant, the making of any Federal loan, the entering into of any cooperative agreement, and the extension, continuation, renewal, amendment, or modification of any Federal contract, grant, loan, or cooperative agreement.
- (B) If any funds other than Federal appropriated funds have been paid or will be paid to any person for influencing or attempting to influence an officer or employee of any Federal agency, a Member of Congress, an officer or employee of Congress, or an employee of a Member of Congress in connection with this Federal contract, grant, loan, or cooperative agreement, the undersigned shall complete and submit Standard Form-LLL, *Disclosure Form to Report Lobbying*, in accordance with its instructions.

This certification is a material representation of fact upon which reliance was placed when this transaction was made or entered into. Submission of this certification is a prerequisite for making or entering into this transaction imposed by *Section 1352, Title 31, U.S. Code*. Any person who

fails to file the required certification shall be subject to a civil penalty of not less than \$10,000 and not more than \$100,000 for each such failure.

The prospective participant also agrees by submitting his or her bid or proposal that he or she shall require that the language of this certification be included in all lower tier subcontracts, which exceed \$100,000 and that all such subrecipients shall certify and disclose accordingly.

**CONTRACTOR'S LICENSE REQUIREMENTS:**

(7-1-95)

102-14

SP1 G88

If the successful bidder does not hold the proper license to perform any plumbing, heating, air conditioning, or electrical work in this contract, he will be required to sublet such work to a contractor properly licensed in accordance with *Article 2 of Chapter 87 of the General Statutes* (licensing of heating, plumbing, and air conditioning contractors) and *Article 4 of Chapter 87 of the General Statutes* (licensing of electrical contractors).

**RESTRICTIONS ON ITS EQUIPMENT AND SERVICES:**

(11-17-20)

SP01 G090

All telecommunications, video or other ITS equipment or services installed or utilized on this project must be in conformance with UNIFORM ADMINISTRATIVE REQUIREMENTS, COST PRINCIPLES, AND AUDIT REQUIREMENTS FOR FEDERAL AWARDS **2 CFR, § 200.216** **Prohibition on certain telecommunications and video surveillance services or equipment.**

**USE OF UNMANNED AIRCRAFT SYSTEM (UAS):**

(8-20-19)

SP1 G092

The Contractor shall adhere to all Federal, State and Local regulations and guidelines for the use of Unmanned Aircraft Systems (UAS). This includes but is not limited to US 14 CFR Part 107 *Small UAS Rule*, NC GS 15A-300.2 *Regulation of launch and recovery sites*, NC GS 63-95 *Training required for the operation of unmanned aircraft systems*, NC GS 63-96 *Permit required for commercial operation of unmanned aircraft system*, and NCDOT UAS Policy. The required operator certifications include possessing a current Federal Aviation Administration (FAA) Remote Pilot Certificate, a NC UAS Operator Permit as well as operating a UAS registered with the FAA.

Prior to beginning operations, the Contractor shall complete the NCDOT UAS – Flight Operation Approval Form and submit it to the Engineer for approval. All UAS operations shall be approved by the Engineer prior to beginning the operations.

All contractors or subcontractors operating UAS shall have UAS specific general liability insurance to cover all operations under this contract.

The use of UAS is at the Contractor's discretion. No measurement or payment will be made for the use of UAS. In the event that the Department directs the Contractor to utilize UAS, payment will be in accordance with Article 104-7 Extra Work.

**EQUIPMENT IDLING GUIDELINES:**

(1-19-21)

107

SP1 G096

Exercise reduced fuel consumption and reduced equipment emissions during the construction of all work associated with this contract. Employees engaged in the construction of this project

should turn off vehicles when stopped for more than thirty (30) minutes and off-highway equipment should idle no longer than fifteen (15) consecutive minutes.

These guidelines for turning off vehicles and equipment when idling do not apply to:

1. Idling when queuing.
2. Idling to verify the vehicle is in safe operating condition.
3. Idling for testing, servicing, repairing or diagnostic purposes.
4. Idling necessary to accomplish work for which the vehicle was designed (such as operating a crane, mixing concrete, etc.).
5. Idling required to bring the machine system to operating temperature.
6. Emergency vehicles, utility company, construction, and maintenance vehicles where the engines must run to perform needed work.
7. Idling to ensure safe operation of the vehicle.
8. Idling when the propulsion engine is providing auxiliary power for other than heating or air conditioning. (such as hydraulic systems for pavers)
9. When specific traffic, safety, or emergency situations arise.
10. If the ambient temperature is less than 32 degrees Fahrenheit. Limited idling to provide for the safety of vehicle occupants (e.g. to run the heater).
11. If the ambient temperature is greater than 90 degrees Fahrenheit. Limited idling to provide for the safety of vehicle occupants of off-highway equipment (e.g. to run the air conditioning) no more than 30 minutes.
12. Diesel powered vehicles may idle for up to 30 minutes to minimize restart problems.

Any vehicle, truck, or equipment in which the primary source of fuel is natural gas or electricity is exempt from the idling limitations set forth in this special provision.

**U.S. DEPARTMENT OF TRANSPORTATION HOTLINE:**

(11-22-94)

108-5

SP1 G100

To report bid rigging activities call: **1-800-424-9071**

The U.S. Department of Transportation (DOT) operates the above toll-free hotline Monday through Friday, 8:00 a.m. to 5:00 p.m. eastern time. Anyone with knowledge of possible bid rigging, bidder collusion, or other fraudulent activities should use the hotline to report such activities.

The hotline is part of the DOT's continuing effort to identify and investigate highway construction contract fraud and abuse is operated under the direction of the DOT Inspector General. All information will be treated confidentially and caller anonymity will be respected.

**NOTE TO CONTRACTOR (DMS):**

Submit a written detailed narrative for the removal and disposal of the existing overhead DMS structure and foundation to the Resident Engineer for review and approval. Pay items and quantities are provided for a rolling road block or an offsite detour option (see TMP plans for acceptable detour route). Please identify the preferred traffic control alternative in your narrative.

Note the DMS structures may have a long lead time for delivery after the shop drawings are approved. This lead time should be incorporated into your schedule of work and planning for operations.

**MAINTENANCE OF THE PROJECT:**

(11-20-07) (Rev. 1-17-12)

104-10

SP1 G125

Revise the *2018 Standard Specifications* as follows:

**Page 1-39, Article 104-10 Maintenance of the Project, line 25,** add the following after the first sentence of the first paragraph:

All guardrail/guiderail within the project limits shall be included in this maintenance.

**Page 1-39, Article 104-10 Maintenance of the Project, line 30,** add the following as the last sentence of the first paragraph:

The Contractor shall perform weekly inspections of guardrail and guiderail and shall report damages to the Engineer on the same day of the weekly inspection. *Where damaged guardrail or guiderail is repaired or replaced as a result of maintaining the project in accordance with this article, such repair or replacement shall be performed within 7 consecutive calendar days of such inspection report.*

**Page 1-39, Article 104-10 Maintenance of the Project, lines 42-44,** replace the last sentence of the last paragraph with the following:

The Contractor will not be directly compensated for any maintenance operations necessary, except for maintenance of guardrail/guiderail, as this work will be considered incidental to the work covered by the various contract items. The provisions of Article 104-7, Extra Work, and Article 104-8, Compensation and Record Keeping will apply to authorized maintenance of guardrail/guiderail. Performance of weekly inspections of guardrail/guiderail, and the damage reports required as described above, will be considered to be an incidental part of the work being paid for by the various contract items.

**COOPERATION BETWEEN CONTRACTORS:**

(7-1-95)

105-7

SP1 G133

The Contractor's attention is directed to Article 105-7 of the *2018 Standard Specifications*.

I-5986C (C204556 - I-95 Broadband Infrastructure Project from South Carolina State Line to Virginia State Line) is located throughout the project limits. I-5986C is currently under construction and not anticipated to be complete prior to the letting of this project.

The Contractor on this project shall cooperate with the Contractor working within or adjacent to the limits of this project to the extent that the work can be carried out to the best advantage of all concerned.

**ELECTRONIC BIDDING:**

(2-19-19)

101, 102, 103

SP1 G140

Revise the *2018 Standard Specifications* as follows:

**Page 1-4, Article 101-3, DEFINITIONS, BID (OR PROPOSAL) *Electronic Bid*, line 1,** replace “Bid Express®” with “the approved electronic bidding provider”.

**Page 1-15, Subarticle 102-8(B), Electronic Bids, lines 39-40,** replace “to Bid Express®” with “via the approved electronic bidding provider”.

**Page 1-15, Subarticle 102-8(B)(1), Electronic Bids, line 41,** delete “from Bid Express®”

**Page 1-17, Subarticle 102-9(C)(2), Electronic Bids, line 21,** replace “Bid Express® miscellaneous folder within the .ebs” with “electronic submittal”.

**Page 1-29, Subarticle 103-4(C)(2), Electronic Bids, line 32,** replace “.ebs miscellaneous data file of Expedite” with “electronic submittal file”

**AWARD LIMITS:**

(4-19-22)

103

SP1 G141

Revise the *2018 Standard Specifications* as follows:

**Page 1-29, Subarticle 103-4(C), Award Limits, line 4-8,** delete and replace the first sentence in the first paragraph with the following:

A bidder who desires to bid on more than one project on which bids are to be opened in the same letting and who desires to avoid receiving an award of more projects than he is equipped to handle, may bid on any number of projects but may limit the total amount of work awarded to him on selected projects by completing the form Award Limits on Multiple Projects for each project subject to the award limit.

**TWELVE MONTH GUARANTEE:**

(7-15-03)

108

SP1 G145

- (A) The Contractor shall guarantee materials and workmanship against latent and patent defects arising from faulty materials, faulty workmanship or negligence for a period of twelve months following the date of final acceptance of the work for maintenance and shall replace such defective materials and workmanship without cost to the Department. The Contractor will not be responsible for damage due to faulty design, normal wear and tear, for negligence on the part of the Department, and/or for use in excess of the design.
- (B) Where items of equipment or material carry a manufacturer’s guarantee for any period in excess of twelve months, then the manufacturer’s guarantee shall apply for that particular piece of equipment or material. The Department’s first remedy shall be through the manufacturer although the Contractor is responsible for invoking the warranted repair work with the manufacturer. The Contractor’s responsibility shall be limited to the term of the manufacturer’s guarantee. NCDOT would be afforded the same warranty as provided by the Manufacturer.

This guarantee provision shall be invoked only for major components of work in which the Contractor would be wholly responsible for under the terms of the contract. Examples would include pavement structures, bridge components, and sign structures. This provision will not be used as a mechanism to force the Contractor to return to the project to make repairs or perform additional work that the Department would normally compensate the Contractor for. In addition, routine maintenance activities (i.e. mowing grass, debris removal, ruts in earth shoulders,) are not parts of this guarantee.

Appropriate provisions of the payment and/or performance bonds shall cover this guarantee for the project.

To ensure uniform application statewide the Division Engineer will forward details regarding the circumstances surrounding any proposed guarantee repairs to the Chief Engineer for review and approval prior to the work being performed.

**NOTE TO CONTRACTOR (Concrete Waste Water):**

Any concrete waste water must be disposed of in accordance with the Department of Environmental Quality General Permit NCG01.

**PROJECT SPECIAL PROVISIONS****ROADWAY****BURNING RESTRICTIONS:**

(7-1-95)

200, 210, 215

SP2 R05

Open burning is not permitted on any portion of the right-of-way limits established for this project. Do not burn the clearing, grubbing or demolition debris designated for disposal and generated from the project at locations within the project limits, off the project limits or at any waste or borrow sites in this county. Dispose of the clearing, grubbing and demolition debris by means other than burning, according to state or local rules and regulations.

**PRICE ADJUSTMENT - ASPHALT BINDER FOR PLANT MIX:**

(11-21-00)

620

SP6 R25

Price adjustments for asphalt binder for plant mix will be made in accordance with Section 620 of the *2018 Standard Specifications*.

The base price index for asphalt binder for plant mix is **\$ 790.00** per ton.

This base price index represents an average of F.O.B. selling prices of asphalt binder at supplier's terminals on **August 1, 2022**.

**FINAL SURFACE TESTING NOT REQUIRED:**

(5-18-04) (Rev. 2-16-16)

610

SP6 R45

Final surface testing is not required on this project in accordance with Section 610-13, *Final Surface Testing and Acceptance*.

**PATCHING EXISTING PAVEMENT:**

(1-15-02) (Rev. 3-11-18)

610

SP6 R88R

**Description**

The Contractor's attention is directed to the fact that there are areas of existing pavement on this project that will require repair prior to resurfacing. Patch the areas that, in the opinion of the Engineer, need repairing. The areas to be patched will be delineated by the Engineer prior to the Contractor performing repairs.

**Materials**

The patching consists of Asphalt Concrete Base Course, Asphalt Concrete Intermediate Course, Asphalt Concrete Surface Course, or a combination of base, binder and surface course.

**Construction Methods**

Remove existing pavement at locations directed by the Engineer in accordance with Section 250 of the *2018 Standard Specifications*.

Place Asphalt Concrete Base Course, in lifts not exceeding 5.5 inches. Utilize compaction equipment suitable for compacting patches as small as 3.5 feet by 6 feet on each lift. Use an



approved compaction pattern to achieve proper compaction. If patched pavement is to be open to traffic for more than 48 hours prior to overlay, use Asphalt Surface Course in the top 1.5 inches of the patch.

Schedule operations so that all areas where pavement has been removed will be repaired on the same day of the pavement removal and all lanes of traffic restored.

### Measurement and Payment

*Patching Existing Pavement* will be measured and paid as the actual number of tons of asphalt plant mix complete in place that has been used to make completed and accepted repairs. The asphalt plant mixed material will be measured by being weighed in trucks on certified platform scales or other certified weighing devices. The above price and payment will be full compensation for all work covered by this provision, including but not limited to removal and disposal of all types of pavement; furnishing and applying tack coat; furnishing, placing, and compacting of asphalt plant mix; furnishing of asphalt binder for the asphalt plant mix; and furnishing scales.

Any provisions included in the contract that provide for adjustments in compensation due to variations in the price of asphalt binder will not be applicable to payment for the work covered by this provision.

Payment will be made under:

Pay Item	Pay Unit
Patching Existing Pavement	Ton

### **MILLING ASPHALT PAVEMENT:**

(1-15-19)

607

SP6 R59

Revise the *2018 Standard Specifications* as follows:

**Page 6-5, Article 607-2, EQUIPMENT, lines 14-16**, delete the seventh sentence of this Article and replace with the following:

Use either a non-contacting laser or sonar type ski system with a minimum of three referencing stations mounted on the milling machine at a length of at least 24 feet.

### **OPEN GRADED ASPHALT FRICTION COURSE:**

(1-15-19)

650

SP6 R63

Revise the *2018 Standard Specifications* as follows:

**Page 6-37, Article 650-5, CONSTRUCTION METHODS, lines 2-4**, delete items (A) and (B) and replace with the following:

- (A) Use Asphalt Binder Grade PG 58-28, Grade PG 64-22 tack coat material, or an approved non-tracking hot-applied (NTHA) asphalt tack coat material.
- (B) Uniformly apply the asphalt binder tack coat material at an applied rate of 0.06 to 0.08 gal/sy, or as directed. Uniformly apply the NTHA asphalt tack coat material at a rate of 0.10 to 0.14 gal/sy, or as directed.

**ASPHALT CONCRETE PLANT MIX PAVEMENTS:**

(2-20-18) (Rev.1-15-19)

610, 1012

SP6 R65

Revise the *2018 Standard Specifications* as follows:

**Page 6-14, Table 609-3, LIMITS OF PRECISION FOR TEST RESULTS**, replace with the following:

<b>TABLE 609-3 LIMITS OF PRECISION FOR TEST RESULTS</b>	
<b>Mix Property</b>	<b>Limits of Precision</b>
25.0 mm sieve (Base Mix)	± 10.0%
19.0 mm sieve (Base Mix)	± 10.0%
12.5 mm sieve (Intermediate & Type P-57)	± 6.0%
9.5 mm sieve (Surface Mix)	± 5.0%
4.75 mm sieve (Surface Mix)	± 5.0%
2.36 mm sieve (All Mixes, except S4.75A)	± 5.0%
1.18 mm sieve (S4.75A)	± 5.0%
0.075 mm sieve (All Mixes)	± 2.0%
Asphalt Binder Content	± 0.5%
Maximum Specific Gravity ( $G_{mm}$ )	± 0.020
Bulk Specific Gravity ( $G_{mb}$ )	± 0.030
TSR	± 15.0%
QA retest of prepared QC Gyratory Compacted Volumetric Specimens	± 0.015
Retest of QC Core Sample	± 1.2% (% Compaction)
Comparison QA Core Sample	± 2.0% (% Compaction)
QA Verification Core Sample	± 2.0% (% Compaction)
Density Gauge Comparison of QC Test	± 2.0% (% Compaction)
QA Density Gauge Verification Test	± 2.0% (% Compaction)

**Page 6-17, Table 610-1, MIXING TEMPERATURE AT THE ASPHALT PLANT**, replace with the following:

<b>TABLE 610-1 MIXING TEMPERATURE AT THE ASPHALT PLANT</b>	
<b>Binder Grade</b>	<b>JMF Temperature</b>
PG 58-28; PG 64-22	250 - 290°F
PG 76-22	300 - 325°F

**Page 6-17, Subarticle 610-3(C), Job Mix Formula (JMF), lines 38-39**, delete the fourth paragraph.

**Page 6-18, Subarticle 610-3(C), Job Mix Formula (JMF), line 12**, replace “SF9.5A” with “S9.5B”.

**Page 6-18, Table 610-3, MIX DESIGN CRITERIA**, replace with the following:

**TABLE 610-3**

MIX DESIGN CRITERIA									
Mix Type	Design ESALs millions <sup>A</sup>	Binder PG Grade	Compaction Levels		Max. Rut Depth (mm)	Volumetric Properties <sup>B</sup>			
			G <sub>mm</sub> @			VMA	VTM	VFA	%G <sub>mm</sub>
			N <sub>ini</sub>	N <sub>des</sub>	% Min.	%	Min.-Max.	@ N <sub>ini</sub>	
S4.75A	< 1	64 - 22	6	50	11.5	16.0	4.0 - 6.0	65 - 80	≤ 91.5
S9.5B	0 - 3	64 - 22	6	50	9.5	16.0	3.0 - 5.0	70 - 80	≤ 91.5
S9.5C	3 - 30	64 - 22	7	65	6.5	15.5	3.0 - 5.0	65 - 78	≤ 90.5
S9.5D	> 30	76 - 22	8	100	4.5	15.5	3.0 - 5.0	65 - 78	≤ 90.0
I19.0C	ALL	64 - 22	7	65	-	13.5	3.0 - 5.0	65 - 78	≤ 90.5
B25.0C	ALL	64 - 22	7	65	-	12.5	3.0 - 5.0	65 - 78	≤ 90.5
Design Parameter					Design Criteria				
All Mix Types	Dust to Binder Ratio (P <sub>0.075</sub> / P <sub>be</sub> )				0.6 - 1.4 <sup>C</sup>				
	Tensile Strength Ratio (TSR) <sup>D</sup>				85% Min. <sup>E</sup>				

- A. Based on 20 year design traffic.
- B. Volumetric Properties based on specimens compacted to N<sub>des</sub> as modified by the Department.
- C. Dust to Binder Ratio (P<sub>0.075</sub> / P<sub>be</sub>) for Type S4.75A is 1.0 - 2.0.
- D. NCDOT-T-283 (No Freeze-Thaw cycle required).
- E. TSR for Type S4.75A & B25.0C mixes is 80% minimum.

Page 6-19, Table 610-5, BINDER GRADE REQUIREMENTS (BASED ON RBR%), replace with the following:

**TABLE 610-5  
BINDER GRADE REQUIREMENTS (BASED ON RBR%)**

Mix Type	%RBR ≤ 20%	21% ≤ %RBR ≤ 30%	%RBR ≥ 30%
S4.75A, S9.5B, S9.5C, I19.0C, B25.0C	PG 64-22	PG 64-22 <sup>A</sup>	PG-58-28
S9.5D, OGFC	PG 76-22 <sup>B</sup>	n/a	n/a

- A. If the mix contains any amount of RAS, the virgin binder shall be PG 58-28.
- B. Maximum Recycled Binder Replacement (%RBR) is 18% for mixes using PG 76-22 binder.

Page 6-20, Table 610-6, PLACEMENT TEMPERATURES FOR ASPHALT, replace with the following:

TABLE 610-6 PLACEMENT TEMPERATURES FOR ASPHALT	
Asphalt Concrete Mix Type	Minimum Surface and Air Temperature
B25.0C	35°F
I19.0C	35°F
S4.75A, S9.5B, S9.5C	40°F <sup>A</sup>
S9.5D	50°F

- A. For the final layer of surface mixes containing recycled asphalt shingles (RAS), the minimum surface and air temperature shall be 50°F.

Page 6-21, Article 610-8, SPREADING AND FINISHING, lines 34-35, delete the second sentence and replace with the following:

Use an MTV for all surface mix regardless of binder grade on Interstate, US Routes, and NC Routes (primary routes) that have 4 or more lanes and median divided.

Page 6-21, Article 610-8, SPREADING AND FINISHING, lines 36-38, delete the fourth sentence and replace with the following:

Use MTV for all ramps, loops, Y-line that have 4 or more lanes and are median divided, full width acceleration lanes, full width deceleration lanes, and full width turn lanes that are greater than 1000 feet in length.

**Page 6-23, Table 610-7, DENSITY REQUIREMENTS**, replace with the following:

<b>TABLE 610-7 DENSITY REQUIREMENTS</b>	
<b>Mix Type</b>	<b>Minimum % G<sub>mm</sub> (Maximum Specific Gravity)</b>
S4.75A	85.0 <sup>A</sup>
S9.5B	90.0
S9.5C, S9.5D, I19.0C, B25.0C	92.0

- A. Compaction to the above specified density will be required when the S4.75A mix is applied at a rate of 100 lbs/sy or higher.

**Page 6-24, Article 610-13, FINAL SURFACE TESTING, lines 35-36**, delete the second sentence and replace with the following:

Final surface testing is not required on ramps, loops and turn lanes.

**Page 6-26, Subarticle 610-13(A)(1), Acceptance for New Construction, lines 29-30**, delete the second sentence and replace with the following:

Areas excluded from testing by the profiler may be tested using a 10-foot straightedge in accordance with Article 610-12.

**Page 6-27, Subarticle 610-13(B), Option 2- North Carolina Hearne Straightedge, lines 41-46**, delete the eighth and ninth sentence of this paragraph and replace with the following:

Take profiles over the entire length of the final surface travel lane pavement exclusive of structures, approach slabs, paved shoulders, tapers, or other irregular shaped areas of pavement, unless otherwise approved by the Engineer. Test in accordance with this provision all mainline travel lanes, full width acceleration or deceleration lanes and collector lanes.

**Page 6-28, Subarticle 610-13(B), Option 2- North Carolina Hearne Straightedge, lines 1-2**, delete these two lines.

**Page 6-32, Article 610-16 MEASUREMENT AND PAYMENT**, replace with the following:

<b>Pay Item</b>	<b>Pay Unit</b>
Asphalt Concrete Base Course, Type B25.0C	Ton
Asphalt Concrete Intermediate Course, Type I19.0C	Ton
Asphalt Concrete Surface Course, Type S4.75A	Ton
Asphalt Concrete Surface Course, Type S9.5B	Ton
Asphalt Concrete Surface Course, Type S9.5C	Ton
Asphalt Concrete Surface Course, Type S9.5D	Ton

Page 10-30, Table 1012-1, AGGREGATE CONSENSUS PROPERTIES, replace with the following:

**TABLE 1012-1  
AGGREGATE CONSENSUS PROPERTIES<sup>A</sup>**

Mix Type	Coarse Aggregate Angularity <sup>B</sup>	Fine Aggregate Angularity % Minimum	Sand Equivalent % Minimum	Flat and Elongated 5 : 1 Ratio % Maximum
<i>Test Method</i>	<i>ASTM D5821</i>	<i>AASHTO T 304</i>	<i>AASHTO T 176</i>	<i>ASTM D4791</i>
S4.75A; S9.5B	75 / -	40	40	-
S9.5C; I19.0C; B25.0C	95 / 90	45	45	10
S9.5D	100 / 100	45	50	10
OGFC	100 / 100	45	45	10
UBWC	100 / 85	45	45	10

A. Requirements apply to the design aggregate blend.

B. 95 / 90 denotes that 95% of the coarse aggregate has one fractured face and 90% has 2 or more fractured faces.

**SUPPLEMENTAL SURVEYING:**

(4-20-21)

801

SP8 R03

Revise the *2018 Standard Specifications* as follows:

Page 8-7, Article 801-3 MEASUREMENT AND PAYMENT, lines 10-11, replace with the following:

*Supplemental Surveying Office Calculations* will be paid at the stated price of \$85.00 per hour. *Supplemental Field Surveying* will be paid at the stated price of \$145.00 per hour. The

**GUARDRAIL END UNITS, TYPE - TL-3:**

(4-20-04) (Rev. 7-1-17)

862

SP8 R65

**Description**

Furnish and install guardrail end units in accordance with the details in the plans, the applicable requirements of Section 862 of the *2018 Standard Specifications*, and at locations shown in the plans.

**Materials**

Furnish guardrail end units listed on the NCDOT Approved Products List at <https://apps.dot.state.nc.us/vendor/approvedproducts/> or approved equal.

Prior to installation the Contractor shall submit to the Engineer:

- (A) FHWA acceptance letter for each guardrail end unit certifying it meets the requirements of the AASHTO Manual for Assessing Safety Hardware, Test Level 3, in accordance with Article 106-2 of the *2018 Standard Specifications*.
- (B) Certified working drawings and assembling instructions from the manufacturer for each guardrail end unit in accordance with Article 105-2 of the *2018 Standard Specifications*.

No modifications shall be made to the guardrail end unit without the express written permission from the manufacturer. Perform installation in accordance with the details in the plans, and details and assembling instructions furnished by the manufacturer.

### **Construction Methods**

Guardrail end delineation is required on all approach and trailing end sections for both temporary and permanent installations. Guardrail end delineation consists of yellow reflective sheeting applied to the entire end section of the guardrail in accordance with Article 1088-3 of the *2018 Standard Specifications* and is incidental to the cost of the guardrail end unit.

### **Measurement and Payment**

Measurement and payment will be made in accordance with Article 862-6 of the *2018 Standard Specifications*.

Payment will be made under:

<b>Pay Item</b>	<b>Pay Unit</b>
Guardrail End Units, Type TL-3	Each

### **FOUNDATIONS AND ANCHOR ROD ASSEMBLIES FOR METAL POLES:**

(1-17-12) (Rev. 1-16-18)

9, 14, 17

SP9 R05

### **Description**

Foundations for metal poles include foundations for signals, cameras, overhead and dynamic message signs (DMS) and high mount and light standards supported by metal poles or upright trusses. Foundations consist of footings with pedestals and drilled piers with or without grade beams or wings. Anchor rod assemblies consist of anchor rods (also called anchor bolts) with nuts and washers on the exposed ends of rods and nuts and a plate or washers on the other ends of rods embedded in the foundation.

Construct concrete foundations with the required resistances and dimensions and install anchor rod assemblies in accordance with the contract and accepted submittals. Construct drilled piers consisting of cast-in-place reinforced concrete cylindrical sections in excavated holes. Provide temporary casings or polymer slurry as needed to stabilize drilled pier excavations. Use a prequalified Drilled Pier Contractor to construct drilled piers for metal poles. Define “excavation” and “hole” as a drilled pier excavation and “pier” as a drilled pier.

This provision does not apply to foundations for signal pedestals; see Section 1743 of the *2018 Standard Specifications* and 2018 Roadway Standard Drawing No. 1743.01.

## Materials

Refer to the *2018 Standard Specifications*.

Item	Section
Conduit	1091-3
Grout, Type 2	1003
Polymer Slurry	411-2(B)(2)
Portland Cement Concrete	1000
Reinforcing Steel	1070
Rollers and Chairs	411-2(C)
Temporary Casings	411-2(A)

Provide Type 3 material certifications in accordance with Article 106-3 of the *2018 Standard Specifications* for conduit, rollers, chairs and anchor rod assemblies. Store steel materials on blocking at least 12" above the ground and protect it at all times from damage; and when placing in the work make sure it is free from dirt, dust, loose mill scale, loose rust, paint, oil or other foreign materials. Load, transport, unload and store foundation and anchor rod assembly materials so materials are kept clean and free of damage. Bent, damaged or defective materials will be rejected.

Use conduit type in accordance with the contract. Use Class A concrete for footings and pedestals, Class Drilled Pier concrete for drilled piers and Class AA concrete for grade beams and wings including portions of drilled piers above bottom of wings elevations. Corrugated temporary casings may be accepted at the discretion of the Engineer. A list of approved polymer slurry products is available from:

[connect.ncdot.gov/resources/Geological/Pages/Products.aspx](http://connect.ncdot.gov/resources/Geological/Pages/Products.aspx)

Provide anchor rod assemblies in accordance with the contract consisting of the following:

- (A) Straight anchor rods,
- (B) Heavy hex top and leveling nuts and flat washers on exposed ends of rods, and
- (C) Nuts and either flat plates or washers on the other ends of anchor rods embedded in foundations.

Do not use lock washers. Use steel anchor rods, nuts and washers that meet ASTM F1554 for Grade 55 rods and Grade A nuts. Use steel plates and washers embedded in concrete with a thickness of at least 1/4". Galvanize anchor rods and exposed nuts and washers in accordance with Article 1076-4 of the *2018 Standard Specifications*. It is not necessary to galvanize nuts, plates and washers embedded in concrete.

## Construction Methods

Install the required size and number of conduits in foundations in accordance with the plans and accepted submittals. Construct top of piers, footings, pedestals, grade beams and wings flat, level and within 1" of elevations shown in the plans or approved by the Engineer. Provide an Ordinary Surface finish in accordance with Subarticle 825-6(B) of the *2018 Standard Specifications* for portions of foundations exposed above finished grade. Do not remove anchor bolt templates or

pedestal or grade beam forms or erect metal poles or upright trusses onto foundations until concrete attains a compressive strength of at least 3,000 psi.

(A) Drilled Piers

Before starting drilled pier construction, hold a predrill meeting to discuss the installation, monitoring and inspection of the drilled piers. Schedule this meeting after the Drilled Pier Contractor has mobilized to the site. The Resident or Division Traffic Engineer, Contractor and Drilled Pier Contractor Superintendent will attend this predrill meeting.

Do not excavate holes, install piles or allow equipment wheel loads or vibrations within 20 ft of completed piers until 16 hours after Drilled Pier concrete reaches initial set.

Check for correct drilled pier alignment and location before beginning drilling. Check plumbness of holes frequently during drilling.

Construct drilled piers with the minimum required diameters shown in the plans. Install piers with tip elevations no higher than shown in the plans or approved by the Engineer.

Excavate holes with equipment of the sizes required to construct drilled piers. Depending on the subsurface conditions encountered, drilling through rock and boulders may be required. Do not use blasting for drilled pier excavations.

Contain and dispose of drilling spoils and waste concrete as directed and in accordance with Section 802 of the *2018 Standard Specifications*. Drilling spoils consist of all materials and fluids removed from excavations.

If unstable, caving or sloughing materials are anticipated or encountered, stabilize holes with temporary casings and/or polymer slurry. Do not use telescoping temporary casings. If it becomes necessary to replace a temporary casing during drilling, backfill the excavation, insert a larger casing around the casing to be replaced or stabilize the excavation with polymer slurry before removing the temporary casing.

If temporary casings become stuck or the Contractor proposes leaving casings in place, temporary casings should be installed against undisturbed material. Unless otherwise approved, do not leave temporary casings in place for mast arm poles and cantilever signs. The Engineer will determine if casings may remain in place. If the Contractor proposes leaving temporary casings in place, do not begin drilling until a casing installation method is approved.

Use polymer slurry and additives to stabilize holes in accordance with the slurry manufacturer's recommendations. Provide mixing water and equipment suitable for polymer slurry. Maintain the required slurry properties at all times except for sand content.

Define a "sample set" as slurry samples collected from mid-height and within 2 ft of the bottom of holes. Take sample sets from excavations to test polymer slurry immediately after filling holes with slurry, at least every 4 hours thereafter and immediately before placing concrete. Do not place Drilled Pier concrete until both slurry samples from an excavation meet the required polymer slurry properties. If any slurry test results do not



meet the requirements, the Engineer may suspend drilling until both samples from a sample set meet the required polymer slurry properties.

Remove soft and loose material from bottom of holes using augers to the satisfaction of the Engineer. Assemble rebar cages and place cages and Drilled Pier concrete in accordance with Subarticle 411-4(E) of the *2018 Standard Specifications* except for the following:

- (1) Inspections for tip resistance and bottom cleanliness are not required,
- (2) Temporary casings may remain in place if approved, and
- (3) Concrete placement may be paused near the top of pier elevations for anchor rod assembly installation and conduit placement or
- (4) If applicable, concrete placement may be stopped at bottom of grade beam or wings elevations for grade beam or wing construction.

If wet placement of concrete is anticipated or encountered, do not place Drilled Pier concrete until a concrete placement procedure is approved. If applicable, temporary casings and fluids may be removed when concrete placement is paused or stopped in accordance with the exceptions above provided holes are stable. Remove contaminated concrete from exposed Drilled Pier concrete after removing casings and fluids. If holes are unstable, do not remove temporary casings until a procedure for placing anchor rod assemblies and conduit or constructing grade beams or wings is approved.

Use collars to extend drilled piers above finished grade. Remove collars after Drilled Pier concrete sets and round top edges of piers.

If drilled piers are questionable, pile integrity testing (PIT) and further investigation may be required in accordance with Article 411-5 of the *2018 Standard Specifications*. A drilled pier will be considered defective in accordance with Subarticle 411-5(D) of the *2018 Standard Specifications* and drilled pier acceptance is based in part on the criteria in Article 411-6 of the *2018 Standard Specifications* except for the top of pier tolerances in Subarticle 411-6(C) of the *2018 Standard Specifications*.

If a drilled pier is under further investigation, do not grout core holes, backfill around the pier or perform any work on the drilled pier until the Engineer accepts the pier. If the drilled pier is accepted, dewater and grout core holes and backfill around the pier with approved material to finished grade. If the Engineer determines a pier is unacceptable, remediation is required in accordance with Article 411-6 of the *2018 Standard Specifications*. No extension of completion date or time will be allowed for remediation of unacceptable drilled piers or post repair testing.

Permanently embed a plate in or mark top of piers with the pier diameter and depth, size and number of vertical reinforcing bars and the minimum compressive strength of the concrete mix at 28 days.

(B) Footings, Pedestals, Grade Beams and Wings

Excavate as necessary for footings, grade beams and wings in accordance with the plans, accepted submittals and Section 410 of the *2018 Standard Specifications*. If unstable,

caving or sloughing materials are anticipated or encountered, shore foundation excavations as needed with an approved method. Notify the Engineer when foundation excavation is complete. Do not place concrete or reinforcing steel until excavation dimensions and foundation material are approved.

Construct cast-in-place reinforced concrete footings, pedestals, grade beams and wings with the dimensions shown in the plans and in accordance with Section 825 of the *2018 Standard Specifications*. Use forms to construct portions of pedestals and grade beams protruding above finished grade. Provide a chamfer with a 3/4" horizontal width for pedestal and grade beam edges exposed above finished grade. Place concrete against undisturbed soil or backfill and fill in accordance with Article 410-8 of the *2018 Standard Specifications*. Proper compaction around footings and wings is critical for foundations to resist uplift and torsion forces.

(C) Anchor Rod Assemblies

Size anchor rods for design and the required projection above top of foundations. Determine required anchor rod projections from nut, washer and base plate thicknesses, the protrusion of 3 to 5 anchor rod threads above top nuts after tightening and the distance of one nut thickness between top of foundations and bottom of leveling nuts.

Protect anchor rod threads from damage during storage and installation of anchor rod assemblies. Before placing anchor rods in foundations, turn nuts onto and off rods past leveling nut locations. Turn nuts with the effort of one workman using an ordinary wrench without a cheater bar. Report any thread damage to the Engineer that requires extra effort to turn nuts.

Arrange anchor rods symmetrically about center of base plate locations as shown in the plans. Set anchor rod elevations based on required projections above top of foundations. Securely brace and hold rods in the correct position, orientation and alignment with a steel template. Do not weld to reinforcing steel, temporary casings or anchor rods.

Install top and leveling (bottom) nuts, washers and the base plate for each anchor rod assembly in accordance with the following procedure:

- (1) Turn leveling nuts onto anchor rods to a distance of one nut thickness between the top of foundation and bottom of leveling nuts. Place washers over anchor rods on top of leveling nuts.
- (2) Determine if nuts are level using a flat rigid template on top of washers. If necessary, lower leveling nuts to level the template in all directions or if applicable, lower nuts to tilt the template so the metal pole or upright truss will lean as shown in the plans. If leveling nuts and washers are not in full contact with the template, replace washers with galvanized beveled washers.
- (3) Verify the distance between the foundation and leveling nuts is no more than one nut thickness.
- (4) Place base plate with metal pole or upright truss over anchor rods on top of washers. High mount luminaires may be attached before erecting metal poles but do not attach cables, mast arms or trusses to metal poles or upright trusses at this time.

- (5) Place washers over anchor rods on top of base plate. Lubricate top nut bearing surfaces and exposed anchor rod threads above washers with beeswax, paraffin or other approved lubricant.
- (6) Turn top nuts onto anchor rods. If nuts are not in full contact with washers or washers are not in full contact with the base plate, replace washers with galvanized beveled washers.
- (7) Tighten top nuts to snug-tight with the full effort of one workman using a 12" wrench. Do not tighten any nut all at once. Turn top nuts in increments. Follow a star pattern cycling through each nut at least twice.
- (8) Repeat (7) for leveling nuts.
- (9) Replace washers above and below the base plate with galvanized beveled washers if the slope of any base plate face exceeds 1:20 (5%), any washer is not in firm contact with the base plate or any nut is not in firm contact with a washer. If any washers are replaced, repeat (7) and (8).
- (10) With top and leveling nuts snug-tight, mark each top nut on a corner at the intersection of 2 flats and a corresponding reference mark on the base plate. Mark top nuts and base plate with ink or paint that is not water-soluble. Use the turn-of-nut method for pretensioning. Do not pretension any nut all at once. Turn top nuts in increments for a total turn that meets the following nut rotation requirements:

<b>NUT ROTATION REQUIREMENTS (Turn-of-Nut Pretensioning Method)</b>	
<b>Anchor Rod Diameter, inch</b>	<b>Requirement</b>
$\leq 1 \frac{1}{2}$	1/3 turn (2 flats)
$> 1 \frac{1}{2}$	1/6 turn (1 flat)

Follow a star pattern cycling through each top nut at least twice.

- (11) Ensure nuts, washers and base plate are in firm contact with each other for each anchor rod. Cables, mast arms and trusses may now be attached to metal poles and upright trusses.
- (12) Between 4 and 14 days after pretensioning top nuts, use a torque wrench calibrated within the last 12 months to check nuts in the presence of the Engineer. Completely erect mast arm poles and cantilever signs and attach any hardware before checking top nuts for these structures. Check that top nuts meet the following torque requirements:

<b>TORQUE REQUIREMENTS</b>	
<b>Anchor Rod Diameter, inch</b>	<b>Requirement, ft-lb</b>
7/8	180
1	270
1 1/8	380
1 1/4	420
$\geq 1 \frac{1}{2}$	600

If necessary, retighten top nuts in the presence of the Engineer with a calibrated torque wrench to within  $\pm 10$  ft-lb of the required torque. Do not overtighten top nuts.

- (13) Do not grout under base plate.

## Measurement and Payment

Foundations and anchor rod assemblies for metal poles and upright trusses will be measured and paid for elsewhere in the contract.

No payment will be made for temporary casings that remain in drilled pier excavations. No payment will be made for PIT. No payment will be made for further investigation of defective piers. Further investigation of piers that are not defective will be paid as extra work in accordance with Article 104-7 of the *2018 Standard Specifications*. No payment will be made for remediation of unacceptable drilled piers or post repair testing.

## OVERHEAD AND DYNAMIC MESSAGE SIGN FOUNDATIONS:

(1-16-18)

SP9 R07

### Description

Sign foundations include foundations for overhead and dynamic message signs (DMS) supported by metal poles or upright trusses. Sign foundations consist of footings with pedestals or drilled piers with or without grade beams or wings, conduit and anchor rod assemblies. Construct sign foundations in accordance with the contract and accepted submittals. Define “cantilever sign” as an overhead cantilever sign support in accordance with Figure 1-1 of the *AASHTO Standard Specifications for Structural Supports for Highway Signs, Luminaires and Traffic Signals*.

### Materials

Use sign foundation materials that meet the *Foundations and Anchor Rod Assemblies for Metal Poles* provision.

### Subsurface Conditions

Assume the following soil parameters and groundwater elevation for sign foundations unless these subsurface conditions are not applicable to sign locations:

- (A) Unit weight ( $\gamma$ ) = 120 pcf,
- (B) Friction angle ( $\phi$ ) = 30°,
- (C) Cohesion ( $c$ ) = 0 psf and
- (D) Groundwater 7 feet below finished grade.

A subsurface investigation is required if the Engineer determines these assumed subsurface conditions do not apply to a sign location and the sign cannot be moved. Subsurface conditions requiring a subsurface investigation include but are not limited to weathered or hard rock, boulders, very soft or loose soil, muck or shallow groundwater. No extension of completion date or time will be allowed for subsurface investigations.

### Subsurface Investigations

Use a prequalified geotechnical consultant to perform one standard penetration test (SPT) boring in accordance with ASTM D1586 at each sign location requiring a subsurface investigation. Rough grade sign locations to within 2 feet of finished grade before beginning drilling. Drill borings to 2 drilled pier diameters below anticipated pier tip elevations or refusal, whichever is

higher.

Use the computer software gINT version V8i or later manufactured by Bentley Systems, Inc. with the current NCDOT gINT library and data template to produce SPT boring logs. Provide boring logs sealed by a geologist or engineer licensed in the state of North Carolina.

### **Sign Foundation Designs**

Design sign foundations for the wind zone and clearances shown in the plans and the slope of finished grade at each sign location. Use the assumed soil parameters and groundwater elevation above for sign foundation designs unless a subsurface investigation is required. For sign locations requiring a subsurface investigation, design sign foundations for the subsurface conditions at each sign location. Design footings, pedestals, drilled piers, grade beams and wings in accordance with the *AASHTO Standard Specifications for Structural Supports for Highway Signs, Luminaires and Traffic Signals*. In some instances, conflicts with drainage structures may dictate sign foundation types.

Design footings in accordance with Section 4.4 of the *AASHTO Standard Specifications for Highway Bridges*. Do not use an allowable bearing pressure of more than 3,000 psf for footings. Design drilled piers for side resistance only in accordance with Section 4.6 of the *AASHTO Standard Specifications for Highway Bridges* except reduce ultimate side resistance by 25% for uplift. Use the computer software LPILE version 2016 or later manufactured by Ensoft, Inc. to analyze drilled piers. Provide drilled pier designs with a horizontal deflection of less than 1" at top of piers. For cantilever signs with single drilled pier foundations supporting metal poles, use wings to resist torsion forces. Provide drilled pier designs with a factor of safety of at least 2.0 for torsion.

For drilled pier sign foundations supporting upright trusses, use dual drilled piers connected with a grade beam having a moment of inertia approximately equal to that of either pier. The Broms' method is acceptable to analyze drilled piers with grade beams instead of LPILE. Use a safety factor of at least 3.5 for the Broms' design method in accordance with C13.6.1.1 of the *AASHTO Standard Specifications for Structural Supports for Highway Signs, Luminaires and Traffic Signals*.

Submit boring logs, if any, working drawings and design calculations for acceptance in accordance with Article 105-2 of the *2018 Standard Specifications*. Submit working drawings showing plan views, required foundation dimensions and elevations and typical sections with reinforcement, conduit and anchor rod assembly details. Include all boring logs, design calculations and LPILE output for sign foundation design submittals. Have sign foundations designed, detailed and sealed by an engineer licensed in the state of North Carolina.

### **Construction Methods**

Construct footings, pedestals, drilled piers, grade beams and wings and install anchor rod assemblies for sign foundations in accordance with the *Foundations and Anchor Rod Assemblies for Metal Poles* provision.

### **Measurement and Payment**

*Overhead Footings* will be measured and paid in cubic yards. Sign foundations will be measured

as the cubic yards of foundation concrete for footings, pedestals, drilled piers, grade beams and wings shown in the accepted submittals. The contract unit price for *Overhead Footings* will be full compensation for providing labor, tools, equipment and foundation materials, stabilizing or shoring excavations, supplying and placing concrete, reinforcing steel, conduit, anchor rod assemblies and any incidentals necessary to construct sign foundations. Subsurface investigations required by the Engineer will be paid as extra work in accordance with Article 104-7 of the *2018 Standard Specifications*.

Payment will be made under:

**Pay Item**  
Overhead Footings

**Pay Unit**  
Cubic Yard

**PORTLAND CEMENT CONCRETE PRODUCTION AND DELIVERY:**

(9-15-20)

1000, 1014, 1024

SP10 R01

Revise the *2018 Standard Specifications* as follows:

**Page 10-6, Table 1000-1, REQUIREMENTS FOR CONCRETE**, replace with the following:

<b>TABLE 1000-1 REQUIREMENTS FOR CONCRETE</b>											
<b>Class of Concrete</b>	<b>Min. Compressive Strength at 28 days</b>	<b>Maximum Water-Cement Ratio</b>				<b>Consistency Maximum Slump</b>		<b>Cement Content</b>			
		<b>Air-Entrained Concrete</b>		<b>Non-Air- Entrained Concrete</b>		<b>Vibrated</b>	<b>Non- Vibrated</b>	<b>Vibrated</b>		<b>Non-Vibrated</b>	
		Rounded Aggregate	Angular Aggregate	Rounded Aggregate	Angular Aggregate			Min.	Max.	Min.	Max.
		<i>Units</i>	<i>psi</i>					<i>inch</i>	<i>inch</i>	<i>lb/cy</i>	<i>lb/cy</i>
AA	4500	0.381	0.426	---	---	3.5 <sup>A</sup>	---	639	715	---	---
AA Slip Form	4500	0.381	0.426	---	---	1.5	---	639	715	---	---
Drilled Pier	4500	---	---	0.450	0.450	---	5 - 7 dry 7 - 9 wet	---	---	640	800
A	3000	0.488	0.532	0.550	0.594	3.5 <sup>A</sup>	4.0	564	---	602	---
B	2500	0.488	0.567	0.559	0.630	1.5 machine placed 2.5 <sup>A</sup> hand placed	4.0	508	---	545	---
Sand Light- weight	4500	---	0.420	---	---	4.0 <sup>A</sup>	---	715	---	---	---
Latex Modified	3000 (at 7 days)	0.400	0.400	---	---	6.0	---	658	---	---	---

Flowable Fill excavatable	150 max. (at 56 days)	as needed	as needed	as needed	as needed	---	Flowable	---	---	40	100
Flowable Fill non-excavatable	125	as needed	as needed	as needed	as needed	---	Flowable	---	---	100	as needed
Pavement	4500 Design, field	0.559	0.559	---	---	1.5 slip form	---	526	---	---	---
	650 flexural, design only										
Precast	See Table 1077-1	as needed	as needed	---	---	6.0	as needed	as needed	as needed	as needed	as needed
Prestressed	per contract	See Table 1078-1	See Table 1078-1	---	---	8.0	---	564	as needed	---	---

- A. The slump may be increased to 6 inches, provided the increase in slump is achieved by adding a chemical admixture conforming to Section 1024-3. In no case shall the water-cement ratio on the approved design be exceeded. Concrete exhibiting segregation and/or excessive bleeding will be rejected. Utilizing an Admixture to modify slump does not relinquish the contractor’s responsibility to ensure the final product quality and overall configuration meets design specifications. Caution should be taken when placing these modified mixes on steep grades to prevent unintended changes to the set slope.

**THERMOPLASTIC INTERMIXED BEAD TESTING:**

7-19-22

1087

SP10 R04

Revise the *2018 Standard Specifications* as follows:

**Page 10-183, Subarticle 1087-7(B) Thermoplastic Pavement Marking Material Composition**, delete line 34 and 35.

**Page 10-184, Article 1087-8 MATERIAL CERTIFICATION**, delete and replace with the following after line 34:

Drop-on Glass Beads	Type 3 Material Certification and Type 4 Material Certification
Intermix Glass Beads	Type 2 Material Certification and Type 3 Material Certification
Paint	Type 3 Material Certification
Removable Tape	Type 3 Material Certification
Thermoplastic	Type 3 Material Certification and Type 4 Material Certification
Cold Applied Plastic	Type 2 Material Certification and Type 3 Material Certification
Polyurea	Type 2 Material Certification and Type 3 Material Certification

**THERMOPLASTIC PAVEMENT MARKING MATERIAL – COLOR TESTING:**

3-19-19

1087

SP10 R05

Revise the *2018 Standard Specifications* as follows:

**Pages 10-183 and 10-184, Subarticle 1087-7(D)(1)(b) Yellow**, lines 9-11, delete and replace with the following:

Obtain Color Values Y,x,y per ASTM E1349 using C/2° illuminant/observer.  
Results shall be  $Y \geq 45\%$ , and x,y shall fall within PR#1 chart chromaticity limits.

**POLYUREA PAVEMENT MARKING MATERIAL – TYPE 2 TYPICAL CERTIFIED MILL TEST REPORT:**

3-19-19

1087

SP10 R06

Amend the *2018 Standard Specifications* as follows:

**Page 10-184, Subarticle 1087-8 Material Certification**, in accordance with Subarticle 106-3 provide a Type 2 Typical Certified Mill Test Report and a Type 3 Manufacturer’s Certification for Polyurea pavement marking material.

When tested, the material shall meet the physical and chemical characteristics provided by the manufacturer. NCDOT reserves the right to compare these test results to baseline test results gathered by the NCDOT Materials and Test Unit.

**NON-CAST IRON SNOWPLOWABLE PAVEMENT MARKERS:**

10-19-21 (Rev. 11-16-21)

1086, 1250, 1253

SP10 R08

Revise the *2018 Standard Specifications* as follows:

**Pages 10-177 and 10-178, Subarticle 1086-3 SNOWPLOWABLE PAVEMENT MARKERS**, delete items (A), (B) and (C)(1) and replace with the following:

**(A) General**

Use non-cast iron snowplowable pavement markers evaluated by NTPEP. The non-cast iron snowplowable pavement marker shall consist of a housing with one or more glass or plastic face lens type reflective lenses to provide the required color designation. The marker shall be designed or installed in a manner that minimizes damage from snowplow blades. Plastic lens faces shall use an abrasion resistant coating.

**(B) Housings**

(1) Dimensions

The dimension, slope and minimum area of reflecting surface shall conform to dimensions as shown in the plans. The minimum area of each reflecting surface shall be 1.44 sq.in.

(2) Materials

Use non-cast iron snowplowable pavement markers that are on the NCDOT Approved Products List.

(3) Surface

The surface of the housing shall be free of scale, dirt, rust, oil, grease or any other contaminant which might reduce its bond to the epoxy adhesive.

(4) Identification

Mark the housing with the manufacturer's name and model number of marker.



**(C) Reflectors****(1) General**

Laminate the reflector to an elastomeric pad and attach with adhesive to the housing. The thickness of the elastomeric pad shall be 0.04".

**Pages 12-14, Subarticle 1250-3(C) Removal of Existing Pavement Markers, lines 19-29,** delete and replace with the following:

Remove the existing raised pavement markers or the snowplowable pavement markers including the housings, before overlaying an existing roadway with pavement. Repair the pavement by filling holes as directed by the Engineer.

When traffic patterns are changed in work zones due to construction or reconstruction, remove all raised pavement markers or snowplowable markers including housings that conflict with the new traffic pattern before switching traffic to the new traffic pattern. Lens removal in lieu of total housing removal is not an acceptable practice for snowplowable markers.

Properly dispose of the removed pavement markers. No direct payment will be made for removal or disposal of existing pavement markers or repair of pavement, as such work will be incidental to other items in the contract.

**Pages 12-16, Subarticle 1253-1 DESCRIPTION, lines 4-5,** delete and replace with the following:

Furnish, install and maintain non-cast iron snowplowable pavement markers in accordance with the contract.

**Pages 12-16 and 12-17, Subarticle 1253-3 CONSTRUCTION METHODS,** delete items (A), (B) and (C) and replace with the following:

**(A) General**

Bond marker housings to the pavement with epoxy adhesive. Mechanically mix and dispense epoxy adhesives as required by the manufacturer's specifications. Place the markers immediately after the adhesive has been mixed and dispensed.

If saw cutting, milling, or grooving operations are used, promptly remove all resulting debris from the pavement surface. Install the marker housings within 7 calendar days after saw cutting, milling, or grooving the pavement. Remove and dispose of loose material from the slots by brushing, blow cleaning, or vacuuming. Dry the slots before applying the epoxy adhesive. Install non-cast iron snowplowable pavement markers according to the manufacturer's recommendations.

Protect the non-cast iron snowplowable pavement markers until the epoxy has initially cured and is track free.

**(B) Reflector Replacement**

In the event that a reflector is damaged, replace the damaged reflector by using adhesives and methods recommended by the manufacturer of the markers and approved by the Engineer.

This work is considered incidental if damage occurs during the initial installation of the marker housings and maintenance of initial non-cast iron snowplowable markers specified in this section. This work will be paid for under the pay item for the type of reflector replacement if the damage occurred after the initial installation of the non-cast iron snowplowable pavement marker.

Missing housings shall be replaced. Broken housings shall be removed and replaced. In both cases the slot for the housings shall be properly prepared prior to installing the new housing; patch the existing marker slots as directed by the Engineer and install the new marker approximately one foot before or after the patch. Removal of broken housings and preparation of slots will be considered incidental to the work of replacing housings.

**Pages 12-17, Subarticle 1253-4 MAINTENANCE, lines 5,** delete and replace with the following:

Maintain all installed non-cast iron snowplowable pavement markers until acceptance.

**Pages 12-17, Subarticle 1253-5 MEASUREMENT AND PAYMENT, lines 7-8,** delete and replace with the following:

*Non-Cast Iron Snowplowable Pavement Markers* will be measured and paid as the actual number of non-cast iron snowplowable pavement markers satisfactorily placed and accepted by the Engineer.

**Pages 12-17, Subarticle 1253-5 MEASUREMENT AND PAYMENT, lines 11,** delete and replace with the following:

Payment will be made under:

<b>Pay Item</b>	<b>Pay Unit</b>
Non-Cast Iron Snowplowable Pavement Marker	Each
Replace Snowplowable Pavement Marker Reflector	Each

**MATERIALS FOR PORTLAND CEMENT CONCRETE:**

(9-15-20)

1000, 1024

SP10 R24

Revise the *2018 Standard Specifications* as follows:

**Page 10-52, Article 1024-4, WATER, lines 3-6,** delete and replace with the following:

Test water from wells at all locations. Test public water supplies from all out of state locations and in the following counties: Beaufort, Bertie, Brunswick, Camden, Carteret, Chowan, Craven, Currituck, Dare, Gates, Hyde, New Hanover, Onslow, Pamlico, Pasquotank, Pender, Perquimans, Tyrell and Washington unless the Engineer waives the testing requirements.

Page 10-52, Table 1024-2, PHYSICAL PROPERTIES OF WATER, replace with the following:

Property	Requirement	Test Method
Compression Strength, minimum percent of control at 3 and 7 days	90%	ASTM C1602
Time of set, deviation from control	From 1:00 hr. earlier to 1:30 hr. later	ASTM C1602
pH	4.5 to 8.5	ASTM D1293 *
Chloride Ion Content, Max.	250 ppm	ASTM D512 *
Total Solids Content (Residue), Max.	1,000 ppm	SM 2540B *
Resistivity, Min.	0.500 kohm-cm	ASTM D1125 *

\*Denotes an alternate method is acceptable. Test method used shall be referenced in the test report.

**MATERIAL AND EQUIPMENT STORAGE & PARKING OF PERSONAL VEHICLES:**

11-17-21(Rev. 8-16-22)

1101

SP11 R03

Revise the 2018 Standard Specifications as follows:

Page 11-2, Article 1101-8 MATERIAL AND EQUIPMENT STORAGE, line 35-38, delete and replace with the following:

When work is not in progress, keep all personnel, equipment, machinery, tools, construction debris, materials and supplies away from active travel lanes that meets Table 1101-1.

TABLE 1101-1 MATERIAL AND EQUIPMENT STORAGE FROM ACTIVE TRAVEL LANES	
Posted Speed Limit (mph)	Distance (ft)
40 or less	≥ 18
45-50	≥ 28
55	≥ 32
60 or higher	≥ 40

When vehicles, equipment and materials are protected by concrete barrier or guardrail, they shall be offset at least 5 feet from the barrier or guardrail.

Page 11-2, Article 1101-9 PARKING OF PERSONAL VEHICLES, line 40-41, delete and replace with the following:

Provide staging areas for personal vehicle parking in accordance with Article 1101-8 or as directed by the Engineer before use.

**WORK ZONE INSTALLER:**

(7-20-21)(Rev. 8-16-22)

1101, 1150

SP11 R04

Provide the service of at least one qualified work zone installer during the setup, installation, and removal of temporary traffic control within the highway right of way. The qualified work zone installer shall serve as crew leader and shall be on site and directing the installation and removal of temporary traffic control. If multiple temporary traffic control installations or removals are occurring simultaneously, then each shall have a qualified work zone installer.

The work zone installer shall be qualified by an NCDOT approved training agency or other NCDOT approved training provider in the safe and competent set up of temporary traffic control. For a complete listing of approved training agencies, see the Work Zone Safety Training webpage.

A work zone supervisor, in accordance with Article 1101-13 of the *Standard Specifications*, may fulfill the role of the work zone installer during the setup, installation, and removal of temporary traffic control within the highway right of way provided they are on site and directing the installation and removal of temporary traffic control.

All other individuals participating in the setup, installation, and removal of temporary traffic control within the highway right of way shall be certified as a qualified flagger in accordance with Article 1150-3 of the *Standard Specifications*, even if flagging is not being performed as part of the traffic control.

Provide the name and contact information of all qualified work zone installers to the Engineer prior to or at the preconstruction conference. Additionally, provide a qualification statement that all other individuals participating in the setup, installation, and removal of temporary traffic control are qualified flaggers that have been properly trained through an NCDOT approved training agency or other NCDOT approved training provider.

All certification records for qualified work zone installers and flaggers shall be uploaded by the approved training agency or other NCDOT approved training provider to the Department's Work Zone Education Verification App (WZ-EVA) prior to the qualified work zone installer or flagger performing any traffic control duties on the project. For more information about WZ-EVA, see the Work Zone Safety Training webpage.

**PORTABLE CHANGEABLE MESSAGE SIGNS:**

(9-20-22)

1089, 1120

SP11 R10

Revise the *2018 Standard Specifications* as follows:

**Page 10-197, Subarticle 1089-7(D) Controller, line 16**, add the following after the third sentence of the first paragraph:

Change the controller password from the factory default and periodically change the controller password to deter unauthorized programming of the controller.

**Page 10-197, Subarticle 1089-7(D) Controller, line 24** replace the sentence with the following:

The controller shall be stored in a locked, weather and vandal resistant box when not in use and after changes to the messages are made.

**Page 11-8, Article 1120-3 CONSTRUCTION METHODS, lines 26-32,** replace the second paragraph with the following:

Provide an experienced operator for the portable changeable message sign during periods of operation to ensure that the messages displayed on the sign panel are in accordance with the plans and Subarticle 1089-7(D). Change the controller password from the factory default and periodically change the controller password to deter unauthorized programming of the controller. Using two levels of password security is recommended such that operators at one level may only change message sequences displayed using preprogrammed sequences and operators at a higher level may create and store messages or message sequences. Lock the controller in a weather and vandal resistant box when not in use and after changes to the messages are made.

**LAW ENFORCEMENT:**

(6-21-22)

1190

SP11 R30

Revise the *2018 Standard Specifications* as follows:

**Page 11-19, Article 1190-1 DESCRIPTION, lines 4-5,** replace the paragraph with the following:

Furnish Law Enforcement Officers and official Law Enforcement vehicles to direct traffic in accordance with the contract.

**Page 11-19, Article 1190-2 CONSTRUCTION METHODS, lines 7-9,** replace the first paragraph with the following:

Use off duty uniformed Law Enforcement Officers and official Law Enforcement vehicles equipped with blue lights to direct or control traffic as required by the plans or by the Engineer.

**Page 11-19, Article 1190-3 MEASUREMENT AND PAYMENT, lines 14-15,** replace the second sentence of the first paragraph with the following:

There will be no direct payment for official Law Enforcement vehicles as they are considered incidental to the pay item.

**EXTRUDED THERMOPLASTIC PAVEMENT MARKING THICKNESS:**

3-19-19 (Rev. 6-21-22)

1205

SP12 R05

Revise the *2018 Standard Specifications* as follows:

**Page 12-6, Subarticle 1205-4(A)(1) General, lines 5-8,** delete the second sentence and replace with the following:

Use application equipment that provides multiple width settings ranging from 4 inches to 12 inches and multiple thickness settings to achieve the required thickness above the surface of the pavement as shown in Table 1205-3.

**Page 12-7, Table 1205-3, THICKNESS REQUIREMENTS FOR THERMOPLASTIC,** replace with the following:

<b>TABLE 1205-3 MINIMUM THICKNESS REQUIREMENTS FOR THERMOPLASTIC</b>	
<b>Thickness</b>	<b>Location</b>
240 mils	In-lane and shoulder-transverse pavement markings (rumble strips). May be placed in 2 passes.
90 mils	Center lines, skip lines, transverse bands, mini-skip lines, characters, bike lane symbols, crosswalk lines, edge lines, gore lines, diagonals, and arrow symbols

**PORTABLE CONSTRUCTION LIGHTING:**

4-19-22

1413

SP14 R13

Revise the *2018 Standard Specifications* as follows:

**Page 14-24, Article 1413-3 TOWER LIGHT, lines 2-7,** delete and replace the first and second sentence in the first paragraph with the following:

Use tower lights which consist of mercury vapor, metal halide, high pressure sodium, low pressure sodium or light emitting diode (with correlated color temperature of 4000 Kelvin or less) fixtures mounted on a tower approximately 30 feet in height. Use tower light fixtures which are heavy duty flood, area, or roadway style with wide beam spread, have sufficient output to provide the minimum illumination requirements for the Category of work, are weatherproof and supplied with attached waterproof power cord and plug.

**Page 14-24, Article 1413-3 TOWER LIGHT, lines 11-12,** delete and replace the second paragraph with the following:

Provide tower lights of sufficient wattage or quantity to provide the minimum average maintained horizontal illuminance over the work area based on the Category of work as shown in Table 1413-1. For any work not covered in Table 1413-1, provide a minimum average maintained horizontal illuminance of 20.0 footcandles over the work area.

<b>TABLE 1413-1 MINIMUM ILLUMINATION REQUIREMENTS FOR PORTABLE CONSTRUCTION LIGHTING</b>		
<b>Category</b>	<b>Description of Construction and Maintenance Task</b>	<b>Minimum Average Maintained Horizontal Illuminance</b>
I	Excavation; Embankment, Fill and Compaction; Maintenance of Embankment; Asphalt Pavement Rolling; Subgrade, Stabilization and Construction; Base Course Rolling; Sweeping and Cleaning; Landscaping, Sod and Seeding; Reworking Shoulders.	5.0 footcandle
II	Barrier Wall and Traffic Separators; Milling, Removal of Pavement; Asphalt Paving and Resurfacing; Concrete Pavement; Base Course Grading and Shaping; Surface Treatment; Waterproofing and Sealing; Sidewalk Construction; Guardrails and Fencing; Striping and Pavement Marking; Highway Signs; Bridge Decks; Drainage Structures and Drainage Piping; Other Concrete Structures; Repair of Concrete Pavement; Pothole Filling; Repair of Guardrail and Fencing.	10.0 footcandle
III	Traffic Signals; Highway Lighting Systems; Crack Filling.	20.0 footcandle

**Page 14-24, Article 1413-4 MACHINE LIGHTS, lines 18-21**, delete and replace the first and second sentence in the first paragraph with the following:

Use machine lights which have mercury vapor, metal halide, high pressure sodium, low pressure sodium or light emitting diode (with correlated color temperature of 4000 Kelvin or less) fixtures mounted on supports attached to the construction machine at a height of approximately 13 feet.

**Page 14-24, Article 1413-5 CONSTRUCTION METHODS, lines 33-34**, delete and replace the third and fourth sentence in the first paragraph with the following:

Submit photometric calculations showing the minimum average maintained horizontal illuminance over the work area and the tower spacing to the Engineer for review and approval prior to installation.

**STANDARD SPECIAL PROVISION**  
**AVAILABILITY OF FUNDS – TERMINATION OF CONTRACTS**

(5-20-08)

Z-2

*General Statute 143C-6-11. (h) Highway Appropriation* is hereby incorporated verbatim in this contract as follows:

(h) Amounts Encumbered. – Transportation project appropriations may be encumbered in the amount of allotments made to the Department of Transportation by the Director for the estimated payments for transportation project contract work to be performed in the appropriation fiscal year. The allotments shall be multiyear allotments and shall be based on estimated revenues and shall be subject to the maximum contract authority contained in *General Statute 143C-6-11(c)*. Payment for transportation project work performed pursuant to contract in any fiscal year other than the current fiscal year is subject to appropriations by the General Assembly. Transportation project contracts shall contain a schedule of estimated completion progress, and any acceleration of this progress shall be subject to the approval of the Department of Transportation provided funds are available. The State reserves the right to terminate or suspend any transportation project contract, and any transportation project contract shall be so terminated or suspended if funds will not be available for payment of the work to be performed during that fiscal year pursuant to the contract. In the event of termination of any contract, the contractor shall be given a written notice of termination at least 60 days before completion of scheduled work for which funds are available. In the event of termination, the contractor shall be paid for the work already performed in accordance with the contract specifications.

Payment will be made on any contract terminated pursuant to the special provision in accordance with Subarticle 108-13(D) of the *2018 Standard Specifications*.



**STANDARD SPECIAL PROVISION**  
**NCDOT GENERAL SEED SPECIFICATION FOR SEED QUALITY**

(5-17-11)

Z-3

Seed shall be sampled and tested by the North Carolina Department of Agriculture and Consumer Services, Seed Testing Laboratory. When said samples are collected, the vendor shall supply an independent laboratory report for each lot to be tested. Results from seed so sampled shall be final. Seed not meeting the specifications shall be rejected by the Department of Transportation and shall not be delivered to North Carolina Department of Transportation warehouses. If seed has been delivered it shall be available for pickup and replacement at the supplier's expense.

Any re-labeling required by the North Carolina Department of Agriculture and Consumer Services, Seed Testing Laboratory, that would cause the label to reflect as otherwise specified herein shall be rejected by the North Carolina Department of Transportation.

Seed shall be free from seeds of the noxious weeds Johnsongrass, Balloonvine, Jimsonweed, Witchweed, Itchgrass, Serrated Tussock, Showy Crotalaria, Smooth Crotalaria, Sicklepod, Sandbur, Wild Onion, and Wild Garlic. Seed shall not be labeled with the above weed species on the seed analysis label. Tolerances as applied by the Association of Official Seed Analysts will NOT be allowed for the above noxious weeds except for Wild Onion and Wild Garlic.

Tolerances established by the Association of Official Seed Analysts will generally be recognized. However, for the purpose of figuring pure live seed, the found pure seed and found germination percentages as reported by the North Carolina Department of Agriculture and Consumer Services, Seed Testing Laboratory will be used. Allowances, as established by the NCDOT, will be recognized for minimum pure live seed as listed on the following pages.

The specifications for restricted noxious weed seed refers to the number per pound as follows:

<b><u>Restricted Noxious Weed</u></b>	<b><u>Limitations per Lb. Of Seed</u></b>	<b><u>Restricted Noxious Weed</u></b>	<b><u>Limitations per Lb. of Seed</u></b>
Blessed Thistle	4 seeds	Cornflower (Ragged Robin)	27 seeds
Cocklebur	4 seeds	Texas Panicum	27 seeds
Spurred Anoda	4 seeds	Bracted Plantain	54 seeds
Velvetleaf	4 seeds	Buckhorn Plantain	54 seeds
Morning-glory	8 seeds	Broadleaf Dock	54 seeds
Corn Cockle	10 seeds	Curly Dock	54 seeds
Wild Radish	12 seeds	Dodder	54 seeds
Purple Nutsedge	27 seeds	Giant Foxtail	54 seeds
Yellow Nutsedge	27 seeds	Horsenettle	54 seeds
Canada Thistle	27 seeds	Quackgrass	54 seeds
Field Bindweed	27 seeds	Wild Mustard	54 seeds
Hedge Bindweed	27 seeds		

Seed of Pensacola Bahiagrass shall not contain more than 7% inert matter, Kentucky Bluegrass, Centipede and Fine or Hard Fescue shall not contain more than 5% inert matter whereas a maximum of 2% inert matter will be allowed on all other kinds of seed. In addition, all seed shall not contain more than 2% other crop seed nor more than 1% total weed seed. The germination

rate as tested by the North Carolina Department of Agriculture shall not fall below 70%, which includes both dormant and hard seed. Seed shall be labeled with not more than 7%, 5% or 2% inert matter (according to above specifications), 2% other crop seed and 1% total weed seed.

Exceptions may be made for minimum pure live seed allowances when cases of seed variety shortages are verified. Pure live seed percentages will be applied in a verified shortage situation. Those purchase orders of deficient seed lots will be credited with the percentage that the seed is deficient.

FURTHER SPECIFICATIONS FOR EACH SEED GROUP ARE GIVEN BELOW:

Minimum 85% pure live seed; maximum 1% total weed seed; maximum 2% total other crop seed; maximum 144 restricted noxious weed seed per pound. Seed less than 83% pure live seed will not be approved.

Sericea Lespedeza  
Oats (seeds)

Minimum 80% pure live seed; maximum 1% total weed seed; maximum 2% total other crop; maximum 144 restricted noxious weed seed per pound. Seed less than 78% pure live seed will not be approved.

Tall Fescue (all approved varieties)	Bermudagrass
Kobe Lespedeza	Browntop Millet
Korean Lespedeza	German Millet – Strain R
Weeping Lovegrass	Clover – Red/White/Crimson
Carpetgrass	

Minimum 78% pure live seed; maximum 1% total weed seed; maximum 2% total other crop seed; maximum 144 restricted noxious weed seed per pound. Seed less than 76% pure live seed will not be approved.

Common or Sweet Sundangrass

Minimum 76% pure live seed; maximum 1% total weed seed; maximum 2% total other crop seed; maximum 144 restricted noxious weed seed per pound. Seed less than 74% pure live seed will not be approved.

Rye (grain; all varieties)  
Kentucky Bluegrass (all approved varieties)  
Hard Fescue (all approved varieties)  
Shrub (bicolor) Lespedeza

Minimum 70% pure live seed; maximum 1% total weed seed; maximum 2% total other crop seed; maximum 144 noxious weed seed per pound. Seed less than 70% pure live seed will not be approved.

Centipedegrass	Japanese Millet
Crownvetch	Reed Canary Grass
Pensacola Bahiagrass	Zoysia
Creeping Red Fescue	

Minimum 70% pure live seed; maximum 1% total weed seed; maximum 2% total other crop seed; maximum 5% inert matter; maximum 144 restricted noxious weed seed per pound.

Barnyard Grass  
Big Bluestem  
Little Bluestem  
Bristly Locust  
Birdsfoot Trefoil  
Indiangrass  
Orchardgrass  
Switchgrass  
Yellow Blossom Sweet Clover

**STANDARD SPECIAL PROVISION****ERRATA**

(10-16-18) (Rev. 8-16-22)

Z-4

Revise the *2018 Standard Specifications* as follows:

**Division 4**

**Page 4-84, Article 458-5 MEASUREMENT AND PAYMENT, line 31,** replace article number “454-1” with “458-1”.

**Division 6**

**Page 6-7, Article 609-1 DESCRIPTION, line 29,** replace article number “609-10” with “609-9”.

**Page 6-26, Subarticle 610-13(A)(1) Acceptance for New Construction, line 31,** replace Table number “610-7” with “610-8”.

**Page 6-29, Subarticle 610-13(B) North Carolina Hearne Straightedge, line 32,** replace Table number “610-8” with “610-9”.

**Page 6-31, Article 610-14 DENSITY ACCEPTANCE, Specified Density prior to line 30 and line 32,** replace Table number “610-6” with “610-7”.

**Division 7**

**Page 7-27, Article 725-1 MEASUREMENT AND PAYMENT, line 4,** replace article number “725-1” with “724-4”.

**Page 7-28, Article 725-1 MEASUREMENT AND PAYMENT, line 10,** replace article number “725-1” with “725-3”.

**Division 10**

**Page 10-37, Article 1012-4, LIGHTWEIGHT AGGREGATE, line 4,** replace Table number “1012-8” with “1012-5”.

**Page 10-78, Article 1056-4 GEOTEXTILES, TABLE 1056-1, Permittivity, Type 2,** replace “Table 6<sup>D</sup>” with “Table 7<sup>D</sup>” and **Permittivity, Type 3<sup>B</sup>,** replace “Table 7<sup>D</sup>” with “Table 8<sup>D</sup>”.

**Page 10-121, Article 1076-7, REPAIR OF GALVANIZING, line 8,** replace article number “1080-9” with “1080-7”.

**Page 10-162, Article 1080-50 PAINT FOR VERTICAL MARKERS, line 1,** replace article number “1080-50” with “1080-10”.

**Page 10-162, Article 1080-61 EPOXY RESIN FOR REINFORCING STEEL, line 5,** replace article number “1080-61” with “1080-11”.

**Page 10-162, Article 1080-72 ABRASIVE MATERIALS FOR BLAST CLEANING STEEL, line 22,** replace article number “1080-72” with “1080-12”.

**Page 10-163, Article 1080-83 FIELD PERFORMANCE AND SERVICES, line 25**, replace article number “1080-83” with “1080-13”.

**Division 17**

**Page 17-15, Article 1715-4 MEASUREMENT AND PAYMENT, lines 42-44**, replace the second sentence with the following:

An example is an installation of a single 1.25 inch HDPE conduit would be paid as:

Directional Drill (1)(1.25") Linear Foot

**Page 17-15, Subarticle 1715-3(E) Bore and Jack, line 5**, replace article number “1540-4” with “1550-4”.

**Page 17-15, Subarticle 1715-3(E) Bore and Jack, lines 10 & 11**, replace "*NCDOT Policies and Procedures for Accommodating Utilities on Highway Rights of Way*" with "*NCDOT Utilities Accommodations Manual*".

**STANDARD SPECIAL PROVISION****PLANT AND PEST QUARANTINES****(Imported Fire Ant, Gypsy Moth, Witchweed, Emerald Ash Borer, Guava Root Knot Nematode, And Other Noxious Weeds)**

(3-18-03) (Rev. 5-21-19)

Z-04a

**Within Quarantined Area**

This project may be within a county regulated for plant and/or pests. If the project or any part of the Contractor's operations is located within a quarantined area, thoroughly clean all equipment prior to moving out of the quarantined area. Comply with federal/state regulations by obtaining a certificate or limited permit for any regulated article moving from the quarantined area.

**Originating in a Quarantined County**

Obtain a certificate or limited permit issued by the N.C. Department of Agriculture/United States Department of Agriculture. Have the certificate or limited permit accompany the article when it arrives at the project site.

**Contact**

Contact the N.C. Department of Agriculture/United States Department of Agriculture at 1-800-206-9333, 919-707-3730, or <https://www.ncagr.gov/plantindustry/Plant/quaran/table2.htm> to determine those specific project sites located in the quarantined area or for any regulated article used on this project originating in a quarantined county.

**Regulated Articles Include**

1. Soil, sand, gravel, compost, peat, humus, muck, and decomposed manure, separately or with other articles. This includes movement of articles listed above that may be associated with cut/waste, ditch pulling, and shoulder cutting.
2. Plants with roots including grass sod.
3. Plant crowns and roots.
4. Bulbs, corms, rhizomes, and tubers of ornamental plants.
5. Hay, straw, fodder, and plant litter of any kind.
6. Clearing and grubbing debris.
7. Used agricultural cultivating and harvesting equipment.
8. Used earth-moving equipment.
9. Any other products, articles, or means of conveyance, of any character, if determined by an inspector to present a hazard of spreading imported fire ant, gypsy moth, witchweed, emerald ash borer, guava root knot nematode, or other noxious weeds.

**STANDARD SPECIAL PROVISION****TITLE VI AND NONDISCRIMINATION:**

(6-28-77)(Rev 6/19/2018)

Z-6

Revise the *2018 Standard Specifications* as follows:

Replace Article 103-4(B) with the following:

The North Carolina Department of Transportation is committed to carrying out the U.S. Department of Transportation's policy of ensuring nondiscrimination in the award and administration of contracts.

The provisions of this section related to United States Department of Transportation (US DOT) Order 1050.2A, Title 49 Code of Federal Regulations (CFR) part 21, 23 United States Code (U.S.C.) 140 and 23 CFR part 200 (or 49 CFR 303, 49 U.S.C. 5332 or 49 U.S.C. 47123) are applicable to all North Carolina Department of Transportation (NCDOT) contracts and to all related subcontracts, material supply, engineering, architectural and other service contracts, regardless of dollar amount. Any Federal provision that is specifically required not specifically set forth is hereby incorporated by reference.

(1) **Title VI Assurances (USDOT Order 1050.2A, Appendix A)**

During the performance of this contract, the contractor, for itself, its assignees, and successors in interest (hereinafter referred to as the "contractor") agrees as follows:

(a) Compliance with Regulations

The contractor (hereinafter includes consultants) shall comply with the Acts and the Regulations relative to Nondiscrimination in Federally-assisted programs of the U.S. Department of Transportation, Federal Highway Administration (FHWA), as they may be amended from time to time, which are herein incorporated by reference and made a part of this contract.

(b) Nondiscrimination

The contractor, with regard to the work performed by it during the contract, shall not discriminate on the grounds of race, color, or national origin in the selection and retention of subcontractors, including procurements of materials and leases of equipment. The contractor shall not participate directly or indirectly in the discrimination prohibited by the Acts and the Regulations, including employment practices when the contract covers any activity, project, or program set forth in Appendix B of 49 CFR Part 21.

(c) Solicitations for Subcontractors, Including Procurements of Materials and Equipment

In all solicitations, either by competitive bidding, or negotiation made by the contractor for work to be performed under a subcontract, including procurements of materials, or leases of equipment, each potential subcontractor or supplier shall be notified by the contractor of the contractor's obligations under this contract and the Acts and the Regulations relative to Nondiscrimination on the grounds of race, color, or national origin.

(d) Information and Reports

The contractor shall provide all information and reports required by the Acts, the Regulations, and directives issued pursuant thereto and shall permit access to its books, records, accounts, other sources of information, and its facilities as may be determined by the Recipient or the FHWA to be pertinent to ascertain compliance with such Acts, Regulations, and instructions. Where any information required of a contractor is in the

exclusive possession of another who fails or refuses to furnish the information, the contractor shall so certify to the Recipient or the FHWA, as appropriate, and shall set forth what efforts it has made to obtain the information.

(e) Sanctions for Noncompliance:

In the event of a contractor's noncompliance with the Non-discrimination provisions of this contract, the Recipient will impose such contract sanctions as it and/or the FHWA may determine to be appropriate, including, but not limited to:

(i) Withholding payments to the contractor under the contract until the contractor complies; and/or

(ii) Cancelling, terminating, or suspending a contract, in whole or in part.

(f) Incorporation of Provisions

The contractor shall include the provisions of paragraphs (a) through (f) in every subcontract, including procurements of materials and leases of equipment, unless exempt by the Acts, the Regulations and directives issued pursuant thereto. The contractor shall take action with respect to any subcontract or procurement as the Recipient or the FHWA may direct as a means of enforcing such provisions including sanctions for noncompliance. Provided, that if the contractor becomes involved in, or is threatened with litigation by a subcontractor, or supplier because of such direction, the contractor may request the Recipient to enter into any litigation to protect the interests of the Recipient. In addition, the contractor may request the United States to enter into the litigation to protect the interests of the United States.

(2) **Title VI Nondiscrimination Program (23 CFR 200.5(p))**

The North Carolina Department of Transportation (NCDOT) has assured the USDOT that, as a condition to receiving federal financial assistance, NCDOT will comply with Title VI of the Civil Rights Act of 1964 and all requirements imposed by Title 49 CFR part 21 and related nondiscrimination authorities to ensure that no person shall, on the ground of race, color, national origin, limited English proficiency, sex, age, or disability (including religion/creed or income-level, where applicable), be excluded from participation in, be denied the benefits of, or be subjected to discrimination under any programs, activities, or services conducted or funded by NCDOT. Contractors and other organizations under contract or agreement with NCDOT must also comply with Title VI and related authorities, therefore:

(a) During the performance of this contract or agreement, contractors (e.g., subcontractors, consultants, vendors, prime contractors) are responsible for complying with NCDOT's Title VI Program. Contractors are not required to prepare or submit Title VI Programs. To comply with this section, the prime contractor shall:

1. Post NCDOT's Notice of Nondiscrimination and the Contractor's own Equal Employment Opportunity (EEO) Policy in conspicuous locations accessible to all employees, applicants and subcontractors on the jobsite.
2. Physically incorporate the required Title VI clauses into all subcontracts on federally-assisted and state-funded NCDOT projects, and ensure inclusion by subcontractors into all lower-tier subcontracts.
3. Required Solicitation Language. The Contractor shall include the following notification in all solicitations for bids and requests for work or material, regardless of funding source:

"The North Carolina Department of Transportation, in accordance with the provisions of Title VI of the Civil Rights Act of 1964 (78 Stat. 252, 42 U.S.C. §§ 2000d to 2000d-4) and the Regulations, hereby notifies all bidders that it will affirmatively ensure that any contract entered into pursuant to this advertisement, disadvantaged business enterprises will be afforded full and fair opportunity to submit bids in response to this invitation and will not



be discriminated against on the grounds of race, color, or national origin in consideration for an award. In accordance with other related nondiscrimination authorities, bidders and contractors will also not be discriminated against on the grounds of sex, age, disability, low-income level, creed/religion, or limited English proficiency in consideration for an award.”

4. Physically incorporate the FHWA-1273, in its entirety, into all subcontracts and subsequent lower tier subcontracts on Federal-aid highway construction contracts only.
  5. Provide language assistance services (i.e., written translation and oral interpretation), free of charge, to LEP employees and applicants. Contact NCDOT OCR for further assistance, if needed.
  6. For assistance with these Title VI requirements, contact the NCDOT Title VI Nondiscrimination Program at 1-800-522-0453.
- (b) Subrecipients (e.g. cities, counties, LGAs, planning organizations) may be required to prepare and submit a Title VI Plan to NCDOT, including Title VI Assurances and/or agreements. Subrecipients must also ensure compliance by their contractors and subrecipients with Title VI. (23 CFR 200.9(b)(7))
- (c) If reviewed or investigated by NCDOT, the contractor or subrecipient agrees to take affirmative action to correct any deficiencies found within a reasonable time period, not to exceed 90 calendar days, unless additional time is granted by NCDOT. (23 CFR 200.9(b)(15))
- (d) The Contractor is responsible for notifying subcontractors of NCDOT’s External Discrimination Complaints Process.
1. Applicability  
Title VI and related laws protect participants and beneficiaries (e.g., members of the public and contractors) from discrimination by NCDOT employees, subrecipients and contractors, regardless of funding source.
  2. Eligibility  
Any person—or class of persons—who believes he/she has been subjected to discrimination based on race, color, national origin, Limited English Proficiency (LEP), sex, age, or disability (and religion in the context of employment, aviation, or transit) may file a written complaint. The law also prohibits intimidation or retaliation of any sort.
  3. Time Limits and Filing Options  
Complaints may be filed by the affected individual(s) or a representative and must be filed no later than 180 calendar days after the following:
    - (i) The date of the alleged act of discrimination; or
    - (ii) The date when the person(s) became aware of the alleged discrimination; or
    - (iii) Where there has been a continuing course of conduct, the date on which that conduct was discontinued or the latest instance of the conduct.Title VI and related discrimination complaints may be submitted to the following entities:
    - North Carolina Department of Transportation, Office of Civil Rights, Title VI Program, 1511 Mail Service Center, Raleigh, NC 27699-1511; toll free 1-800-522-0453
    - Federal Highway Administration, North Carolina Division Office, 310 New Bern Avenue, Suite 410, Raleigh, NC 27601, 919-747-7010
    - US Department of Transportation, Departmental Office of Civil Rights, External Civil Rights Programs Division, 1200 New Jersey Avenue, SE, Washington, DC 20590; 202-366-4070

## 4. Format for Complaints

Complaints must be in writing and signed by the complainant(s) or a representative, and include the complainant's name, address, and telephone number. Complaints received by fax or e-mail will be acknowledged and processed. Allegations received by telephone will be reduced to writing and provided to the complainant for confirmation or revision before processing. Complaints will be accepted in other languages, including Braille.

## 5. Discrimination Complaint Form

Contact NCDOT Civil Rights to receive a full copy of the Discrimination Complaint Form and procedures.

## 6. Complaint Basis

Allegations must be based on issues involving race, color, national origin (LEP), sex, age, disability, or religion (in the context of employment, aviation or transit). "Basis" refers to the complainant's membership in a protected group category.

**TABLE 103-1  
COMPLAINT BASIS**

Protected Categories	Definition	Examples	Applicable Nondiscrimination Authorities
Race and Ethnicity	An individual belonging to one of the accepted racial groups; or the perception, based usually on physical characteristics that a person is a member of a racial group	Black/African American, Hispanic/Latino, Asian, American Indian/Alaska Native, Native Hawaiian/Pacific Islander, White	Title VI of the Civil Rights Act of 1964; 49 CFR Part 21; 23 CFR 200; 49 U.S.C. 5332(b); 49 U.S.C. 47123. <i>(Executive Order 13166)</i>
Color	Color of skin, including shade of skin within a racial group	Black, White, brown, yellow, etc.	
National Origin ( <i>Limited English Proficiency</i> )	Place of birth. Citizenship is not a factor. ( <i>Discrimination based on language or a person's accent is also covered</i> )	Mexican, Cuban, Japanese, Vietnamese, Chinese	
Sex	Gender. The sex of an individual. <i>Note: Sex under this program does not include sexual orientation.</i>	Women and Men	1973 Federal-Aid Highway Act; 49 U.S.C. 5332(b); 49 U.S.C. 47123.
Age	Persons of any age	21-year-old person	Age Discrimination Act of 1975 49 U.S.C. 5332(b); 49 U.S.C. 47123.
Disability	Physical or mental impairment, permanent or temporary, or perceived.	Blind, alcoholic, para-amputee, epileptic, diabetic, arthritic	Section 504 of the Rehabilitation Act of 1973; Americans with Disabilities Act of 1990

<p>Religion (in the context of employment) <i>(Religion/ Creed in all aspects of any aviation or transit-related construction)</i></p>	<p>An individual belonging to a religious group; or the perception, based on distinguishable characteristics that a person is a member of a religious group. In practice, actions taken as a result of the moral and ethical beliefs as to what is right and wrong, which are sincerely held with the strength of traditional religious views. <b>Note:</b> Does not have to be associated with a recognized religious group or church; if an individual sincerely holds to the belief, it is a protected religious practice.</p>	<p>Muslim, Christian, Sikh, Hindu, etc.</p>	<p>Title VII of the Civil Rights Act of 1964; 23 CFR 230; FHWA-1273 Required Contract Provisions. <i>(49 U.S.C. 5332(b); 49 U.S.C. 47123)</i></p>
--	---	---	---

### (3) Pertinent Nondiscrimination Authorities

During the performance of this contract, the contractor, for itself, its assignees, and successors in interest agrees to comply with the following non-discrimination statutes and authorities, including, but not limited to:

- (a) Title VI of the Civil Rights Act of 1964 (42 U.S.C. § 2000d et seq., 78 stat. 252), (prohibits discrimination on the basis of race, color, national origin); and 49 CFR Part 21.
- (b) The Uniform Relocation Assistance and Real Property Acquisition Policies Act of 1970, (42 U.S.C. § 4601), (prohibits unfair treatment of persons displaced or whose property has been acquired because of Federal or Federal-aid programs and projects);
- (c) Federal-Aid Highway Act of 1973, (23 U.S.C. § 324 et seq.), (prohibits discrimination on the basis of sex);
- (d) Section 504 of the Rehabilitation Act of 1973, (29 U.S.C. § 794 et seq.), as amended, (prohibits discrimination on the basis of disability) and 49 CFR Part 27;
- (e) The Age Discrimination Act of 1975, as amended, (42 U.S.C. § 6101 et seq.), (prohibits discrimination on the basis of age);
- (f) Airport and Airway Improvement Act of 1982, (49 USC § 471, Section 47123), as amended, (prohibits discrimination based on race, creed, color, national origin, or sex);
- (g) The Civil Rights Restoration Act of 1987, (PL 100-209), (Broadened the scope, coverage and applicability of Title VI of the Civil Rights Act of 1964, The Age Discrimination Act of 1975 and Section 504 of the Rehabilitation Act of 1973, by expanding the definition of the terms "programs or activities" to include all of the programs or activities of the Federal-aid recipients, sub-recipients and contractors, whether such programs or activities are Federally funded or not);
- (h) Titles II and III of the Americans with Disabilities Act, which prohibit discrimination on the basis of disability in the operation of public entities, public and private transportation systems, places of public accommodation, and certain testing entities (42 U.S.C. §§ 12131-12189) as implemented by Department of Transportation regulations at 49 C.F.R. parts 37 and 38;
- (i) The Federal Aviation Administration's Nondiscrimination statute (49 U.S.C. § 47123) (prohibits discrimination on the basis of race, color, national origin, and sex);
- (j) Executive Order 12898, Federal Actions to Address Environmental Justice in Minority Populations and Low-Income Populations, which ensures Nondiscrimination against minority populations by discouraging programs, policies, and activities with disproportionately high and adverse human health or environmental effects on minority and low-income populations;

- (k) Executive Order 13166, Improving Access to Services for Persons with Limited English Proficiency, and resulting agency guidance, national origin discrimination includes discrimination because of Limited English proficiency (LEP). To ensure compliance with Title VI, you must take reasonable steps to ensure that LEP persons have meaningful access to your programs (70 Fed. Reg. at 74087 to 74100);
  - (l) Title IX of the Education Amendments of 1972, as amended, which prohibits you from discriminating because of sex in education programs or activities (20 U.S.C. 1681 et seq).
  - (m) Title VII of the Civil Rights Act of 1964 (42 U.S.C. § 2000e et seq., Pub. L. 88-352), (prohibits employment discrimination on the basis of race, color, religion, sex, or national origin).
- (4) **Additional Title VI Assurances**
- \*\*The following Title VI Assurances (Appendices B, C and D) shall apply, as applicable*
- (a) Clauses for Deeds Transferring United States Property (1050.2A, Appendix B)  
The following clauses will be included in deeds effecting or recording the transfer of real property, structures, or improvements thereon, or granting interest therein from the United States pursuant to the provisions of Assurance 4.

NOW, THEREFORE, the U.S. Department of Transportation as authorized by law and upon the condition that the North Carolina Department of Transportation (NCDOT) will accept title to the lands and maintain the project constructed thereon in accordance with the North Carolina General Assembly, the Regulations for the Administration of the Federal-Aid Highway Program, and the policies and procedures prescribed by the Federal Highway Administration of the U.S. Department of Transportation in accordance and in compliance with all requirements imposed by Title 49, Code of Federal Regulations, U.S. Department of Transportation, Subtitle A, Office of the Secretary, Part 21, Nondiscrimination in Federally-assisted programs of the U.S. Department of Transportation pertaining to and effectuating the provisions of Title VI of the Civil Rights Act of 1964 (78 Stat. 252; 42 U.S.C. § 2000d to 2000d-4), does hereby remise, release, quitclaim and convey unto the NCDOT all the right, title and interest of the U.S. Department of Transportation in and to said lands described in Exhibit A attached hereto and made a part hereof.

(HABENDUM CLAUSE)

TO HAVE AND TO HOLD said lands and interests therein unto the North Carolina Department of Transportation (NCDOT) and its successors forever, subject, however, to the covenants, conditions, restrictions and reservations herein contained as follows, which will remain in effect for the period during which the real property or structures are used for a purpose for which Federal financial assistance is extended or for another purpose involving the provision of similar services or benefits and will be binding on the NCDOT, its successors and assigns.

The NCDOT, in consideration of the conveyance of said lands and interests in lands, does hereby covenant and agree as a covenant running with the land for itself, its successors and assigns, that (1) no person will on the grounds of race, color, or national origin, be excluded from participation in, be denied the benefits of, or be otherwise subjected to discrimination with regard to any facility located wholly or in part on, over, or under such lands hereby conveyed [,] [and]\* (2) that the NCDOT will use the lands and interests in lands and interests in lands so conveyed, in compliance with all requirements imposed by or pursuant to Title 49, Code of Federal Regulations, U.S. Department of Transportation, Subtitle A, Office of the Secretary, Part 21, Non-discrimination in Federally-assisted programs of the U.S. Department of Transportation, Effectuation of Title VI of the Civil Rights Act of 1964, and as said Regulations and Acts may be amended [,] and (3) that in the event of breach of any of the above-mentioned nondiscrimination conditions, the Department will have a right to enter or re-enter said lands and facilities on said land, and that above described land and facilities will thereon revert to and vest in and become the absolute property of the U.S. Department of Transportation and its assigns as such interest existed prior to this instruction].\*

(\*Reverter clause and related language to be used only when it is determined that such a clause is necessary in order to make clear the purpose of Title VI.)

(b) Clauses for Transfer of Real Property Acquired or Improved Under the Activity, Facility, or Program (1050.2A, Appendix C)

The following clauses will be included in deeds, licenses, leases, permits, or similar instruments entered into by the North Carolina Department of Transportation (NCDOT) pursuant to the provisions of Assurance 7(a):

1. The (grantee, lessee, permittee, etc. as appropriate) for himself/herself, his/her heirs, personal representatives, successors in interest, and assigns, as a part of the consideration hereof, does hereby covenant and agree [in the case of deeds and leases add "as a covenant running with the land"] that:
  - (i.) In the event facilities are constructed, maintained, or otherwise operated on the property described in this (deed, license, lease, permit, etc.) for a purpose for which a U.S. Department of Transportation activity, facility, or program is extended or for another purpose involving the provision of similar services or benefits, the (grantee, licensee, lessee, permittee, etc.) will maintain and operate such facilities and services in compliance with all requirements imposed by the Acts and Regulations (as may be amended) such that no person on the grounds of race, color, or national origin, will be excluded from participation in, denied the benefits of, or be otherwise subjected to discrimination in the use of said facilities.
2. With respect to licenses, leases, permits, etc., in the event of breach of any of the above Nondiscrimination covenants, the NCDOT will have the right to terminate the (lease, license, permit, etc.) and to enter, re-enter, and repossess said lands and facilities thereon, and hold the same as if the (lease, license, permit, etc.) had never been made or issued. \*
3. With respect to a deed, in the event of breach of any of the above Nondiscrimination covenants, the NCDOT will have the right to enter or re-enter the lands and facilities thereon, and the above described lands and facilities will there upon revert to and vest in and become the absolute property of the NCDOT and its assigns. \*

- (\*Reverter clause and related language to be used only when it is determined that such a clause is necessary to make clear the purpose of Title VI.)
- (c) Clauses for Construction/Use/Access to Real Property Acquired Under the Activity, Facility or Program (1050.2A, Appendix D)

The following clauses will be included in deeds, licenses, permits, or similar instruments/ agreements entered into by the North Carolina Department of Transportation (NCDOT) pursuant to the provisions of Assurance 7(b):

1. The (grantee, licensee, permittee, etc., as appropriate) for himself/herself, his/her heirs, personal representatives, successors in interest, and assigns, as a part of the consideration hereof, does hereby covenant and agree (in the case of deeds and leases add, "as a covenant running with the land") that (1) no person on the ground of race, color, or national origin, will be excluded from participation in, denied the benefits of, or be otherwise subjected to discrimination in the use of said facilities, (2) that in the construction of any improvements on, over, or under such land, and the furnishing of services thereon, no person on the ground of race, color, or national origin, will be excluded from participation in, denied the benefits of, or otherwise be subjected to discrimination, (3) that the (grantee, licensee, lessee, permittee, etc.) will use the premises in compliance with all other requirements imposed by or pursuant to the Acts and Regulations, as amended, set forth in this Assurance.
2. With respect to (licenses, leases, permits, etc.), in the event of breach of any of the above Non-discrimination covenants, the NCDOT will have the right to terminate the (license, permit, etc., as appropriate) and to enter or re-enter and repossess said land and the facilities thereon, and hold the same as if said (license, permit, etc., as appropriate) had never been made or issued. \*
3. With respect to deeds, in the event of breach of any of the above Nondiscrimination covenants, the NCDOT will there upon revert to and vest in and become the absolute property of the NCDOT and its assigns. \*

(\*Reverter clause and related language to be used only when it is determined that such a clause is necessary to make clear the purpose of Title VI.)

**STANDARD SPECIAL PROVISION****MINORITY AND FEMALE EMPLOYMENT REQUIREMENTS**

Z-7

NOTICE OF REQUIREMENTS FOR AFFIRMATIVE ACTION TO ENSURE EQUAL EMPLOYMENT OPPORTUNITY (*EXECUTIVE NUMBER 11246*)

1. The goals and timetables for minority and female participation, expressed in percentage terms for the Contractor's aggregate workforce in each trade on all construction work in the covered area, see as shown on the attached sheet entitled "Employment Goals for Minority and Female participation".

These goals are applicable to all the Contractor's construction work (whether or not it is Federal or federally assisted) performed in the covered area. If the Contractor performs construction work in a geographical area located outside of the covered area, it shall apply the goals established for such geographical area where the work is actually performed. With regard to this second area, the Contractor also is subject to the goals for both its federally involved and nonfederally involved construction.

The Contractor's compliance with the Executive Order and the regulations in *41 CFR Part 60-4* shall be based on its implementation of the Equal Opportunity Clause, specific affirmative action obligations required by the specifications set forth in *41 CFR 60-4.3(a)*, and its effort to meet the goals. The hours of minority and female employment and training must be substantially uniform throughout the length of the contract, and in each trade and the Contractor shall make a good faith effort to employ minorities and women evenly on each of its projects. The transfer of minority or female employees or trainees from Contractor to Contractor or from project to project for the sole purpose of meeting the Contractor's goals shall be a violation of the contract, the executive Order and the regulations in *41 CFR Part 60-4*. Compliance with the goals will be measured against the total work hours performed.

2. As used in this Notice and in the contract resulting from this solicitation, the "covered area" is the county or counties shown on the cover sheet of the proposal form and contract.

**EMPLOYMENT GOALS FOR MINORITY  
AND FEMALE PARTICIPATION**

Economic Areas

**Area 023 29.7%**

Bertie County  
Camden County  
Chowan County  
Gates County  
Hertford County  
Pasquotank County  
Perquimans County

**Area 024 31.7%**

Beaufort County  
Carteret County  
Craven County  
Dare County  
Edgecombe County  
Green County  
Halifax County  
Hyde County  
Jones County  
Lenoir County  
Martin County  
Nash County  
Northampton County  
Pamlico County  
Pitt County  
Tyrrell County  
Washington County  
Wayne County  
Wilson County

**Area 025 23.5%**

Columbus County  
Duplin County  
Onslow County  
Pender County

**Area 026 33.5%**

Bladen County  
Hoke County  
Richmond County  
Robeson County  
Sampson County  
Scotland County

**Area 027 24.7%**

Chatham County  
Franklin County  
Granville County  
Harnett County  
Johnston County  
Lee County  
Person County  
Vance County  
Warren County

**Area 028 15.5%**

Alleghany County  
Ashe County  
Caswell County  
Davie County  
Montgomery County  
Moore County  
Rockingham County  
Surry County  
Watauga County  
Wilkes County

**Area 029 15.7%**

Alexander County  
Anson County  
Burke County  
Cabarrus County  
Caldwell County  
Catawba County  
Cleveland County  
Iredell County  
Lincoln County  
Polk County  
Rowan County  
Rutherford County  
Stanly County

**Area 0480 8.5%**

Buncombe County  
Madison County

**Area 030 6.3%**

Avery County  
Cherokee County  
Clay County  
Graham County  
Haywood County  
Henderson County  
Jackson County  
McDowell County  
Macon County  
Mitchell County  
Swain County  
Transylvania County  
Yancey County



**SMSA Areas**

**Area 5720 26.6%**  
Currituck County

**Area 9200 20.7%**  
Brunswick County  
New Hanover County

**Area 2560 24.2%**  
Cumberland County

**Area 6640 22.8%**  
Durham County  
Orange County  
Wake County

**Area 1300 16.2%**  
Alamance County

**Area 3120 16.4%**  
Davidson County  
Forsyth County  
Guilford County  
Randolph County  
Stokes County  
Yadkin County

**Area 1520 18.3%**  
Gaston County  
Mecklenburg County  
Union County

---

**Goals for Female**

**Participation in Each Trade**

(Statewide) 6.9%

**REQUIRED CONTRACT PROVISIONS FEDERAL-AID CONSTRUCTION CONTRACTS**

- I. General
- II. Nondiscrimination
- III. Non-segregated Facilities
- IV. Davis-Bacon and Related Act Provisions
- V. Contract Work Hours and Safety Standards Act Provisions
- VI. Subletting or Assigning the Contract
- VII. Safety: Accident Prevention
- VIII. False Statements Concerning Highway Projects
- IX. Implementation of Clean Air Act and Federal Water Pollution Control Act
- X. Certification Regarding Debarment, Suspension, Ineligibility and Voluntary Exclusion
- XI. Certification Regarding Use of Contract Funds for Lobbying
- XII. Use of United States-Flag Vessels:

**ATTACHMENTS**

A. Employment and Materials Preference for Appalachian Development Highway System or Appalachian Local Access Road Contracts (included in Appalachian contracts only)

**I. GENERAL**

1. Form FHWA-1273 must be physically incorporated in each construction contract funded under title 23, United States Code, as required in 23 CFR 633.102(b) (excluding emergency contracts solely intended for debris removal). The contractor (or subcontractor) must insert this form in each subcontract and further require its inclusion in all lower tier subcontracts (excluding purchase orders, rental agreements and other agreements for supplies or services). 23 CFR 633.102(e).

The applicable requirements of Form FHWA-1273 are incorporated by reference for work done under any purchase order, rental agreement or agreement for other services. The prime contractor shall be responsible for compliance by any subcontractor, lower-tier subcontractor or service provider. 23 CFR 633.102(e).

Form FHWA-1273 must be included in all Federal-aid design-build contracts, in all subcontracts and in lower tier subcontracts (excluding subcontracts for design services, purchase orders, rental agreements and other agreements for supplies or services) in accordance with 23 CFR 633.102. The design-builder shall be responsible for compliance by any subcontractor, lower-tier subcontractor or service provider.

Contracting agencies may reference Form FHWA-1273 in solicitation-for-bids or request-for-proposals documents, however, the Form FHWA-1273 must be physically incorporated (not referenced) in all contracts, subcontracts and lower-tier subcontracts (excluding purchase orders, rental agreements and other agreements for supplies or services related to a construction contract). 23 CFR 633.102(b).

2. Subject to the applicability criteria noted in the following sections, these contract provisions shall apply to all work

performed on the contract by the contractor's own organization and with the assistance of workers under the contractor's immediate superintendence and to all work performed on the contract by piecework, station work, or by subcontract. 23 CFR 633.102(d).

3. A breach of any of the stipulations contained in these Required Contract Provisions may be sufficient grounds for withholding of progress payments, withholding of final payment, termination of the contract, suspension / debarment or any other action determined to be appropriate by the contracting agency and FHWA.

4. Selection of Labor: During the performance of this contract, the contractor shall not use convict labor for any purpose within the limits of a construction project on a Federal-aid highway unless it is labor performed by convicts who are on parole, supervised release, or probation. 23 U.S.C. 114(b). The term Federal-aid highway does not include roadways functionally classified as local roads or rural minor collectors. 23 U.S.C. 101(a).

**II. NONDISCRIMINATION (23 CFR 230.107(a); 23 CFR Part 230, Subpart A, Appendix A; EO 11246)**

The provisions of this section related to 23 CFR Part 230, Subpart A, Appendix A are applicable to all Federal-aid construction contracts and to all related construction subcontracts of \$10,000 or more. The provisions of 23 CFR Part 230 are not applicable to material supply, engineering, or architectural service contracts.

In addition, the contractor and all subcontractors must comply with the following policies: Executive Order 11246, 41 CFR Part 60, 29 CFR Parts 1625-1627, 23 U.S.C. 140, Section 504 of the Rehabilitation Act of 1973, as amended (29 U.S.C. 794), Title VI of the Civil Rights Act of 1964, as amended (42 U.S.C. 2000d et seq.), and related regulations including 49 CFR Parts 21, 26, and 27; and 23 CFR Parts 200, 230, and 633.

The contractor and all subcontractors must comply with: the requirements of the Equal Opportunity Clause in 41 CFR 60-1.4(b) and, for all construction contracts exceeding \$10,000, the Standard Federal Equal Employment Opportunity Construction Contract Specifications in 41 CFR 60-4.3.

Note: The U.S. Department of Labor has exclusive authority to determine compliance with Executive Order 11246 and the policies of the Secretary of Labor including 41 CFR Part 60, and 29 CFR Parts 1625-1627. The contracting agency and the FHWA have the authority and the responsibility to ensure compliance with 23 U.S.C. 140, Section 504 of the Rehabilitation Act of 1973, as amended (29 U.S.C. 794), and Title VI of the Civil Rights Act of 1964, as amended (42 U.S.C. 2000d et seq.), and related regulations including 49 CFR Parts 21, 26, and 27; and 23 CFR Parts 200, 230, and 633.

The following provision is adopted from 23 CFR Part 230, Subpart A, Appendix A, with appropriate revisions to conform to the U.S. Department of Labor (US DOL) and FHWA requirements.

**1. Equal Employment Opportunity:** Equal Employment Opportunity (EEO) requirements not to discriminate and to take affirmative action to assure equal opportunity as set forth under laws, executive orders, rules, regulations (*see* 28 CFR Part 35, 29 CFR Part 1630, 29 CFR Parts 1625-1627, 41 CFR Part 60 and 49 CFR Part 27) and orders of the Secretary of Labor as modified by the provisions prescribed herein, and imposed pursuant to 23 U.S.C. 140, shall constitute the EEO and specific affirmative action standards for the contractor's project activities under this contract. The provisions of the Americans with Disabilities Act of 1990 (42 U.S.C. 12101 et seq.) set forth under 28 CFR Part 35 and 29 CFR Part 1630 are incorporated by reference in this contract. In the execution of this contract, the contractor agrees to comply with the following minimum specific requirement activities of EEO:

a. The contractor will work with the contracting agency and the Federal Government to ensure that it has made every good faith effort to provide equal opportunity with respect to all of its terms and conditions of employment and in their review of activities under the contract. 23 CFR 230.409 (g)(4) & (5).

b. The contractor will accept as its operating policy the following statement:

"It is the policy of this Company to assure that applicants are employed, and that employees are treated during employment, without regard to their race, religion, sex, sexual orientation, gender identity, color, national origin, age or disability. Such action shall include: employment, upgrading, demotion, or transfer; recruitment or recruitment advertising; layoff or termination; rates of pay or other forms of compensation; and selection for training, including apprenticeship, pre-apprenticeship, and/or on-the-job training."

**2. EEO Officer:** The contractor will designate and make known to the contracting officers an EEO Officer who will have the responsibility for and must be capable of effectively administering and promoting an active EEO program and who must be assigned adequate authority and responsibility to do so.

**3. Dissemination of Policy:** All members of the contractor's staff who are authorized to hire, supervise, promote, and discharge employees, or who recommend such action or are substantially involved in such action, will be made fully cognizant of and will implement the contractor's EEO policy and contractual responsibilities to provide EEO in each grade and classification of employment. To ensure that the above agreement will be met, the following actions will be taken as a minimum:

a. Periodic meetings of supervisory and personnel office employees will be conducted before the start of work and then not less often than once every six months, at which time the contractor's EEO policy and its implementation will be reviewed and explained. The meetings will be conducted by the EEO Officer or other knowledgeable company official.

b. All new supervisory or personnel office employees will be given a thorough indoctrination by the EEO Officer, covering all major aspects of the contractor's EEO obligations within thirty days following their reporting for duty with the contractor.

c. All personnel who are engaged in direct recruitment for the project will be instructed by the EEO Officer in the contractor's procedures for locating and hiring minorities and women.

d. Notices and posters setting forth the contractor's EEO policy will be placed in areas readily accessible to employees, applicants for employment and potential employees.

e. The contractor's EEO policy and the procedures to implement such policy will be brought to the attention of employees by means of meetings, employee handbooks, or other appropriate means.

**4. Recruitment:** When advertising for employees, the contractor will include in all advertisements for employees the notation: "An Equal Opportunity Employer." All such advertisements will be placed in publications having a large circulation among minorities and women in the area from which the project work force would normally be derived.

a. The contractor will, unless precluded by a valid bargaining agreement, conduct systematic and direct recruitment through public and private employee referral sources likely to yield qualified minorities and women. To meet this requirement, the contractor will identify sources of potential minority group employees and establish with such identified sources procedures whereby minority and women applicants may be referred to the contractor for employment consideration.

b. In the event the contractor has a valid bargaining agreement providing for exclusive hiring hall referrals, the contractor is expected to observe the provisions of that agreement to the extent that the system meets the contractor's compliance with EEO contract provisions. Where implementation of such an agreement has the effect of discriminating against minorities or women, or obligates the contractor to do the same, such implementation violates Federal nondiscrimination provisions.

c. The contractor will encourage its present employees to refer minorities and women as applicants for employment. Information and procedures with regard to referring such applicants will be discussed with employees.

**5. Personnel Actions:** Wages, working conditions, and employee benefits shall be established and administered, and personnel actions of every type, including hiring, upgrading, promotion, transfer, demotion, layoff, and termination, shall be taken without regard to race, color, religion, sex, sexual orientation, gender identity, national origin, age or disability. The following procedures shall be followed:

a. The contractor will conduct periodic inspections of project sites to ensure that working conditions and employee facilities do not indicate discriminatory treatment of project site personnel.

b. The contractor will periodically evaluate the spread of wages paid within each classification to determine any evidence of discriminatory wage practices.

c. The contractor will periodically review selected personnel actions in depth to determine whether there is evidence of discrimination. Where evidence is found, the contractor will promptly take corrective action. If the review indicates that the discrimination may extend beyond the actions reviewed, such corrective action shall include all affected persons.

d. The contractor will promptly investigate all complaints of alleged discrimination made to the contractor in connection with its obligations under this contract, will attempt to resolve such complaints, and will take appropriate corrective action

within a reasonable time. If the investigation indicates that the discrimination may affect persons other than the complainant, such corrective action shall include such other persons. Upon completion of each investigation, the contractor will inform every complainant of all of their avenues of appeal.

#### **6. Training and Promotion:**

a. The contractor will assist in locating, qualifying, and increasing the skills of minorities and women who are applicants for employment or current employees. Such efforts should be aimed at developing full journey level status employees in the type of trade or job classification involved.

b. Consistent with the contractor's work force requirements and as permissible under Federal and State regulations, the contractor shall make full use of training programs (i.e., apprenticeship and on-the-job training programs for the geographical area of contract performance). In the event a special provision for training is provided under this contract, this subparagraph will be superseded as indicated in the special provision. The contracting agency may reserve training positions for persons who receive welfare assistance in accordance with 23 U.S.C. 140(a).

c. The contractor will advise employees and applicants for employment of available training programs and entrance requirements for each.

d. The contractor will periodically review the training and promotion potential of employees who are minorities and women and will encourage eligible employees to apply for such training and promotion.

**7. Unions:** If the contractor relies in whole or in part upon unions as a source of employees, the contractor will use good faith efforts to obtain the cooperation of such unions to increase opportunities for minorities and women. 23 CFR 230.409. Actions by the contractor, either directly or through contractor's association acting as agent, will include the procedures set forth below:

a. The contractor will use good faith efforts to develop, in cooperation with the unions, joint training programs aimed toward qualifying more minorities and women for membership in the unions and increasing the skills of minorities and women so that they may qualify for higher paying employment.

b. The contractor will use good faith efforts to incorporate an EEO clause into each union agreement to the end that such union will be contractually bound to refer applicants without regard to their race, color, religion, sex, sexual orientation, gender identity, national origin, age, or disability.

c. The contractor is to obtain information as to the referral practices and policies of the labor union except that to the extent such information is within the exclusive possession of the labor union and such labor union refuses to furnish such information to the contractor, the contractor shall so certify to the contracting agency and shall set forth what efforts have been made to obtain such information.

d. In the event the union is unable to provide the contractor with a reasonable flow of referrals within the time limit set forth in the collective bargaining agreement, the contractor will, through independent recruitment efforts, fill the employment vacancies without regard to race, color, religion, sex, sexual orientation, gender identity, national origin, age, or disability; making full efforts to obtain qualified and/or qualifiable minorities and women. The failure of a union to provide

sufficient referrals (even though it is obligated to provide exclusive referrals under the terms of a collective bargaining agreement) does not relieve the contractor from the requirements of this paragraph. In the event the union referral practice prevents the contractor from meeting the obligations pursuant to Executive Order 11246, as amended, and these special provisions, such contractor shall immediately notify the contracting agency.

**8. Reasonable Accommodation for Applicants / Employees with Disabilities:** The contractor must be familiar with the requirements for and comply with the Americans with Disabilities Act and all rules and regulations established thereunder. Employers must provide reasonable accommodation in all employment activities unless to do so would cause an undue hardship.

**9. Selection of Subcontractors, Procurement of Materials and Leasing of Equipment:** The contractor shall not discriminate on the grounds of race, color, religion, sex, sexual orientation, gender identity, national origin, age, or disability in the selection and retention of subcontractors, including procurement of materials and leases of equipment. The contractor shall take all necessary and reasonable steps to ensure nondiscrimination in the administration of this contract.

a. The contractor shall notify all potential subcontractors, suppliers, and lessors of their EEO obligations under this contract.

b. The contractor will use good faith efforts to ensure subcontractor compliance with their EEO obligations.

#### **10. Assurances Required:**

a. The requirements of 49 CFR Part 26 and the State DOT's FHWA-approved Disadvantaged Business Enterprise (DBE) program are incorporated by reference.

b. The contractor, subrecipient or subcontractor shall not discriminate on the basis of race, color, national origin, or sex in the performance of this contract. The contractor shall carry out applicable requirements of 49 CFR part 26 in the award and administration of DOT-assisted contracts. Failure by the contractor to carry out these requirements is a material breach of this contract, which may result in the termination of this contract or such other remedy as the recipient deems appropriate, which may include, but is not limited to:

- (1) Withholding monthly progress payments;
- (2) Assessing sanctions;
- (3) Liquidated damages; and/or
- (4) Disqualifying the contractor from future bidding as non-responsible.

c. The Title VI and nondiscrimination provisions of U.S. DOT Order 1050.2A at Appendixes A and E are incorporated by reference. 49 CFR Part 21.

**11. Records and Reports:** The contractor shall keep such records as necessary to document compliance with the EEO requirements. Such records shall be retained for a period of three years following the date of the final payment to the contractor for all contract work and shall be available at reasonable times and places for inspection by authorized representatives of the contracting agency and the FHWA.

a. The records kept by the contractor shall document the following:

(1) The number and work hours of minority and non-minority group members and women employed in each work classification on the project;

(2) The progress and efforts being made in cooperation with unions, when applicable, to increase employment opportunities for minorities and women; and

(3) The progress and efforts being made in locating, hiring, training, qualifying, and upgrading minorities and women.

a. The contractors and subcontractors will submit an annual report to the contracting agency each July for the duration of the project indicating the number of minority, women, and non-minority group employees currently engaged in each work classification required by the contract work. This information is to be reported on Form FHWA-1391. The staffing data should represent the project work force on board in all or any part of the last payroll period preceding the end of July. If on-the-job training is being required by special provision, the contractor will be required to collect and report training data. The employment data should reflect the work force on board during all or any part of the last payroll period preceding the end of July.

### III. NONSEGREGATED FACILITIES

This provision is applicable to all Federal-aid construction contracts and to all related construction subcontracts of more than \$10,000. 41 CFR 60-1.5.

As prescribed by 41 CFR 60-1.8, the contractor must ensure that facilities provided for employees are provided in such a manner that segregation on the basis of race, color, religion, sex, sexual orientation, gender identity, or national origin cannot result. The contractor may neither require such segregated use by written or oral policies nor tolerate such use by employee custom. The contractor's obligation extends further to ensure that its employees are not assigned to perform their services at any location under the contractor's control where the facilities are segregated. The term "facilities" includes waiting rooms, work areas, restaurants and other eating areas, time clocks, restrooms, washrooms, locker rooms and other storage or dressing areas, parking lots, drinking fountains, recreation or entertainment areas, transportation, and housing provided for employees. The contractor shall provide separate or single-user restrooms and necessary dressing or sleeping areas to assure privacy between sexes.

### IV. DAVIS-BACON AND RELATED ACT PROVISIONS

This section is applicable to all Federal-aid construction projects exceeding \$2,000 and to all related subcontracts and lower-tier subcontracts (regardless of subcontract size), in accordance with 29 CFR 5.5. The requirements apply to all projects located within the right-of-way of a roadway that is functionally classified as Federal-aid highway. 23 U.S.C. 113. This excludes roadways functionally classified as local roads or rural minor collectors, which are exempt. 23 U.S.C. 101. Where applicable law requires that projects be treated as a project on a Federal-aid highway, the provisions of this subpart will apply regardless of the location of the project. Examples include: Surface Transportation Block Grant Program projects funded under 23 U.S.C. 133 [excluding recreational trails projects], the Nationally Significant Freight and Highway

Projects funded under 23 U.S.C. 117, and National Highway Freight Program projects funded under 23 U.S.C. 167.

The following provisions are from the U.S. Department of Labor regulations in 29 CFR 5.5 "Contract provisions and related matters" with minor revisions to conform to the FHWA-1273 format and FHWA program requirements.

#### 1. Minimum wages (29 CFR 5.5)

a. All laborers and mechanics employed or working upon the site of the work, will be paid unconditionally and not less often than once a week, and without subsequent deduction or rebate on any account (except such payroll deductions as are permitted by regulations issued by the Secretary of Labor under the Copeland Act (29 CFR part 3)), the full amount of wages and bona fide fringe benefits (or cash equivalents thereof) due at time of payment computed at rates not less than those contained in the wage determination of the Secretary of Labor which is attached hereto and made a part hereof, regardless of any contractual relationship which may be alleged to exist between the contractor and such laborers and mechanics.

Contributions made or costs reasonably anticipated for bona fide fringe benefits under section 1(b)(2) of the Davis-Bacon Act on behalf of laborers or mechanics are considered wages paid to such laborers or mechanics, subject to the provisions of paragraph 1.d. of this section; also, regular contributions made or costs incurred for more than a weekly period (but not less often than quarterly) under plans, funds, or programs which cover the particular weekly period, are deemed to be constructively made or incurred during such weekly period. Such laborers and mechanics shall be paid the appropriate wage rate and fringe benefits on the wage determination for the classification of work actually performed, without regard to skill, except as provided in 29 CFR 5.5(a)(4). Laborers or mechanics performing work in more than one classification may be compensated at the rate specified for each classification for the time actually worked therein: Provided, That the employer's payroll records accurately set forth the time spent in each classification in which work is performed. The wage determination (including any additional classification and wage rates conformed under paragraph 1.b. of this section) and the Davis-Bacon poster (WH-1321) shall be posted at all times by the contractor and its subcontractors at the site of the work in a prominent and accessible place where it can be easily seen by the workers.

b.(1) The contracting officer shall require that any class of laborers or mechanics, including helpers, which is not listed in the wage determination and which is to be employed under the contract shall be classified in conformance with the wage determination. The contracting officer shall approve an additional classification and wage rate and fringe benefits therefore only when the following criteria have been met:

(i) The work to be performed by the classification requested is not performed by a classification in the wage determination; and

(ii) The classification is utilized in the area by the construction industry; and

(iii) The proposed wage rate, including any bona fide fringe benefits, bears a reasonable relationship to the wage rates contained in the wage determination.

(2) If the contractor and the laborers and mechanics to be employed in the classification (if known), or their representatives, and the contracting officer agree on the classification and wage rate (including the amount designated for fringe benefits where appropriate), a report of the action taken shall be sent by the contracting officer to the Administrator of the Wage and Hour Division, U.S. Department of Labor, Washington, DC 20210. The Administrator, or an authorized representative, will approve, modify, or disapprove every additional classification action within 30 days of receipt and so advise the contracting officer or will notify the contracting officer within the 30-day period that additional time is necessary.

(3) In the event the contractor, the laborers or mechanics to be employed in the classification or their representatives, and the contracting officer do not agree on the proposed classification and wage rate (including the amount designated for fringe benefits, where appropriate), the contracting officer shall refer the questions, including the views of all interested parties and the recommendation of the contracting officer, to the Administrator for determination. The Administrator, or an authorized representative, will issue a determination within 30 days of receipt and so advise the contracting officer or will notify the contracting officer within the 30-day period that additional time is necessary.

(4) The wage rate (including fringe benefits where appropriate) determined pursuant to paragraphs 1.b.(2) or 1.b.(3) of this section, shall be paid to all workers performing work in the classification under this contract from the first day on which work is performed in the classification.

c. Whenever the minimum wage rate prescribed in the contract for a class of laborers or mechanics includes a fringe benefit which is not expressed as an hourly rate, the contractor shall either pay the benefit as stated in the wage determination or shall pay another bona fide fringe benefit or an hourly cash equivalent thereof.

d. If the contractor does not make payments to a trustee or other third person, the contractor may consider as part of the wages of any laborer or mechanic the amount of any costs reasonably anticipated in providing bona fide fringe benefits under a plan or program. Provided, That the Secretary of Labor has found, upon the written request of the contractor, that the applicable standards of the Davis-Bacon Act have been met. The Secretary of Labor may require the contractor to set aside in a separate account assets for the meeting of obligations under the plan or program.

## 2. Withholding (29 CFR 5.5)

The contracting agency shall upon its own action or upon written request of an authorized representative of the Department of Labor, withhold or cause to be withheld from the contractor under this contract, or any other Federal contract with the same prime contractor, or any other federally-assisted contract subject to Davis-Bacon prevailing wage requirements, which is held by the same prime contractor, so much of the accrued payments or advances as may be considered necessary to pay laborers and mechanics,

including apprentices, trainees, and helpers, employed by the contractor or any subcontractor the full amount of wages required by the contract. In the event of failure to pay any laborer or mechanic, including any apprentice, trainee, or helper, employed or working on the site of the work, all or part of the wages required by the contract, the contracting agency may, after written notice to the contractor, take such action as may be necessary to cause the suspension of any further payment, advance, or guarantee of funds until such violations have ceased.

## 3. Payrolls and basic records (29 CFR 5.5)

a. Payrolls and basic records relating thereto shall be maintained by the contractor during the course of the work and preserved for a period of three years thereafter for all laborers and mechanics working at the site of the work. Such records shall contain the name, address, and social security number of each such worker, his or her correct classification, hourly rates of wages paid (including rates of contributions or costs anticipated for bona fide fringe benefits or cash equivalents thereof of the types described in section 1(b)(2)(B) of the Davis-Bacon Act), daily and weekly number of hours worked, deductions made and actual wages paid. Whenever the Secretary of Labor has found under 29 CFR 5.5(a)(1)(iv) that the wages of any laborer or mechanic include the amount of any costs reasonably anticipated in providing benefits under a plan or program described in section 1(b)(2)(B) of the Davis-Bacon Act, the contractor shall maintain records which show that the commitment to provide such benefits is enforceable, that the plan or program is financially responsible, and that the plan or program has been communicated in writing to the laborers or mechanics affected, and records which show the costs anticipated or the actual cost incurred in providing such benefits. Contractors employing apprentices or trainees under approved programs shall maintain written evidence of the registration of apprenticeship programs and certification of trainee programs, the registration of the apprentices and trainees, and the ratios and wage rates prescribed in the applicable programs.

b.(1) The contractor shall submit weekly for each week in which any contract work is performed a copy of all payrolls to the contracting agency. The payrolls submitted shall set out accurately and completely all of the information required to be maintained under 29 CFR 5.5(a)(3)(i), except that full social security numbers and home addresses shall not be included on weekly transmittals. Instead the payrolls shall only need to include an individually identifying number for each employee (e.g., the last four digits of the employee's social security number). The required weekly payroll information may be submitted in any form desired. Optional Form WH-347 is available for this purpose from the Wage and Hour Division Web site. The prime contractor is responsible for the submission of copies of payrolls by all subcontractors. Contractors and subcontractors shall maintain the full social security number and current address of each covered worker, and shall provide them upon request to the contracting agency for transmission to the State DOT, the FHWA or the Wage and Hour Division of the Department of Labor for purposes of an investigation or audit of compliance with prevailing wage requirements. It is not a violation of this section for a prime contractor to require a subcontractor to provide addresses and social security numbers to the prime contractor for its own records, without weekly submission to the contracting agency.

(2) Each payroll submitted shall be accompanied by a "Statement of Compliance," signed by the contractor or

subcontractor or his or her agent who pays or supervises the payment of the persons employed under the contract and shall certify the following:

(i) That the payroll for the payroll period contains the information required to be provided under 29 CFR 5.5(a)(3)(ii), the appropriate information is being maintained under 29 CFR 5.5(a)(3)(i), and that such information is correct and complete;

(ii) That each laborer or mechanic (including each helper, apprentice, and trainee) employed on the contract during the payroll period has been paid the full weekly wages earned, without rebate, either directly or indirectly, and that no deductions have been made either directly or indirectly from the full wages earned, other than permissible deductions as set forth in 29 CFR part 3;

(iii) That each laborer or mechanic has been paid not less than the applicable wage rates and fringe benefits or cash equivalents for the classification of work performed, as specified in the applicable wage determination incorporated into the contract.

(3) The weekly submission of a properly executed certification set forth on the reverse side of Optional Form WH-347 shall satisfy the requirement for submission of the "Statement of Compliance" required by paragraph 3.b.(2) of this section.

(4) The falsification of any of the above certifications may subject the contractor or subcontractor to civil or criminal prosecution under 18 U.S.C. 1001 and 31 U.S.C. 231.

c. The contractor or subcontractor shall make the records required under paragraph 3.a. of this section available for inspection, copying, or transcription by authorized representatives of the contracting agency, the State DOT, the FHWA, or the Department of Labor, and shall permit such representatives to interview employees during working hours on the job. If the contractor or subcontractor fails to submit the required records or to make them available, the FHWA may, after written notice to the contractor, the contracting agency or the State DOT, take such action as may be necessary to cause the suspension of any further payment, advance, or guarantee of funds. Furthermore, failure to submit the required records upon request or to make such records available may be grounds for debarment action pursuant to 29 CFR 5.12.

#### 4. Apprentices and trainees (29 CFR 5.5)

##### a. Apprentices (programs of the USDOL).

Apprentices will be permitted to work at less than the predetermined rate for the work they performed when they are employed pursuant to and individually registered in a bona fide apprenticeship program registered with the U.S. Department of Labor, Employment and Training Administration, Office of Apprenticeship Training, Employer and Labor Services, or with a State Apprenticeship Agency recognized by the Office, or if a person is employed in his or her first 90 days of probationary employment as an apprentice in such an apprenticeship program, who is not individually registered in the program, but who has been certified by the Office of Apprenticeship Training, Employer and Labor Services or a State

Apprenticeship Agency (where appropriate) to be eligible for probationary employment as an apprentice.

The allowable ratio of apprentices to journeymen on the job site in any craft classification shall not be greater than the ratio permitted to the contractor as to the entire work force under the registered program. Any worker listed on a payroll at an apprentice wage rate, who is not registered or otherwise employed as stated above, shall be paid not less than the applicable wage rate on the wage determination for the classification of work actually performed. In addition, any apprentice performing work on the job site in excess of the ratio permitted under the registered program shall be paid not less than the applicable wage rate on the wage determination for the work actually performed. Where a contractor is performing construction on a project in a locality other than that in which its program is registered, the ratios and wage rates (expressed in percentages of the journeyman's hourly rate) specified in the contractor's or subcontractor's registered program shall be observed.

Every apprentice must be paid at not less than the rate specified in the registered program for the apprentice's level of progress, expressed as a percentage of the journeymen hourly rate specified in the applicable wage determination. Apprentices shall be paid fringe benefits in accordance with the provisions of the apprenticeship program. If the apprenticeship program does not specify fringe benefits, apprentices must be paid the full amount of fringe benefits listed on the wage determination for the applicable classification. If the Administrator determines that a different practice prevails for the applicable apprentice classification, fringes shall be paid in accordance with that determination.

In the event the Office of Apprenticeship Training, Employer and Labor Services, or a State Apprenticeship Agency recognized by the Office, withdraws approval of an apprenticeship program, the contractor will no longer be permitted to utilize apprentices at less than the applicable predetermined rate for the work performed until an acceptable program is approved.

##### b. Trainees (programs of the USDOL).

Except as provided in 29 CFR 5.16, trainees will not be permitted to work at less than the predetermined rate for the work performed unless they are employed pursuant to and individually registered in a program which has received prior approval, evidenced by formal certification by the U.S. Department of Labor, Employment and Training Administration.

The ratio of trainees to journeymen on the job site shall not be greater than permitted under the plan approved by the Employment and Training Administration.

Every trainee must be paid at not less than the rate specified in the approved program for the trainee's level of progress, expressed as a percentage of the journeyman hourly rate specified in the applicable wage determination. Trainees shall be paid fringe benefits in accordance with the provisions of the trainee program. If the trainee program does not mention fringe benefits, trainees shall be paid the full amount of fringe benefits listed on the wage determination unless the Administrator of the Wage and Hour Division determines that there is an apprenticeship program associated with the

corresponding journeyman wage rate on the wage determination which provides for less than full fringe benefits for apprentices. Any employee listed on the payroll at a trainee rate who is not registered and participating in a training plan approved by the Employment and Training Administration shall be paid not less than the applicable wage rate on the wage determination for the classification of work actually performed. In addition, any trainee performing work on the job site in excess of the ratio permitted under the registered program shall be paid not less than the applicable wage rate on the wage determination for the work actually performed.

In the event the Employment and Training Administration withdraws approval of a training program, the contractor will no longer be permitted to utilize trainees at less than the applicable predetermined rate for the work performed until an acceptable program is approved.

c. Equal employment opportunity. The utilization of apprentices, trainees and journeymen under this part shall be in conformity with the equal employment opportunity requirements of Executive Order 11246, as amended, and 29 CFR part 30.

d. Apprentices and Trainees (programs of the U.S. DOT).

Apprentices and trainees working under apprenticeship and skill training programs which have been certified by the Secretary of Transportation as promoting EEO in connection with Federal-aid highway construction programs are not subject to the requirements of paragraph 4 of this Section IV. 23 CFR 230.111(e)(2). The straight time hourly wage rates for apprentices and trainees under such programs will be established by the particular programs. The ratio of apprentices and trainees to journeymen shall not be greater than permitted by the terms of the particular program.

**5. Compliance with Copeland Act requirements.** The contractor shall comply with the requirements of 29 CFR part 3, which are incorporated by reference in this contract as provided in 29 CFR 5.5.

**6. Subcontracts.** The contractor or subcontractor shall insert Form FHWA-1273 in any subcontracts and also require the subcontractors to include Form FHWA-1273 in any lower tier subcontracts. The prime contractor shall be responsible for the compliance by any subcontractor or lower tier subcontractor with all the contract clauses in 29 CFR 5.5.

**7. Contract termination: debarment.** A breach of the contract clauses in 29 CFR 5.5 may be grounds for termination of the contract, and for debarment as a contractor and a subcontractor as provided in 29 CFR 5.12.

**8. Compliance with Davis-Bacon and Related Act requirements.** All rulings and interpretations of the Davis-Bacon and Related Acts contained in 29 CFR parts 1, 3, and 5 are herein incorporated by reference in this contract as provided in 29 CFR 5.5.

**9. Disputes concerning labor standards.** As provided in 29 CFR 5.5, disputes arising out of the labor standards provisions of this contract shall not be subject to the general disputes clause of this contract. Such disputes shall be resolved in accordance with the procedures of the Department of Labor

set forth in 29 CFR parts 5, 6, and 7. Disputes within the meaning of this clause include disputes between the contractor (or any of its subcontractors) and the contracting agency, the U.S. Department of Labor, or the employees or their representatives.

#### **10. Certification of eligibility (29 CFR 5.5)**

a. By entering into this contract, the contractor certifies that neither it (nor he or she) nor any person or firm who has an interest in the contractor's firm is a person or firm ineligible to be awarded Government contracts by virtue of section 3(a) of the Davis-Bacon Act or 29 CFR 5.12(a)(1).

b. No part of this contract shall be subcontracted to any person or firm ineligible for award of a Government contract by virtue of section 3(a) of the Davis-Bacon Act or 29 CFR 5.12(a)(1).

c. The penalty for making false statements is prescribed in the U.S. Criminal Code, 18 U.S.C. 1001.

#### **V. CONTRACT WORK HOURS AND SAFETY STANDARDS ACT**

Pursuant to 29 CFR 5.5(b), the following clauses apply to any Federal-aid construction contract in an amount in excess of \$100,000 and subject to the overtime provisions of the Contract Work Hours and Safety Standards Act. These clauses shall be inserted in addition to the clauses required by 29 CFR 5.5(a) or 29 CFR 4.6. As used in this paragraph, the terms laborers and mechanics include watchmen and guards.

**1. Overtime requirements.** No contractor or subcontractor contracting for any part of the contract work which may require or involve the employment of laborers or mechanics shall require or permit any such laborer or mechanic in any workweek in which he or she is employed on such work to work in excess of forty hours in such workweek unless such laborer or mechanic receives compensation at a rate not less than one and one-half times the basic rate of pay for all hours worked in excess of forty hours in such workweek. 29 CFR 5.5.

**2. Violation; liability for unpaid wages; liquidated damages.** In the event of any violation of the clause set forth in paragraph 1 of this section, the contractor and any subcontractor responsible therefor shall be liable for the unpaid wages. In addition, such contractor and subcontractor shall be liable to the United States (in the case of work done under contract for the District of Columbia or a territory, to such District or to such territory), for liquidated damages. Such liquidated damages shall be computed with respect to each individual laborer or mechanic, including watchmen and guards, employed in violation of the clause set forth in paragraph 1 of this section, in the sum currently provided in 29 CFR 5.5(b)(2)\* for each calendar day on which such individual was required or permitted to work in excess of the standard workweek of forty hours without payment of the overtime wages required by the clause set forth in paragraph 1 of this section. 29 CFR 5.5.

\* \$27 as of January 23, 2019 (See 84 FR 213-01, 218) as may be adjusted annually by the Department of Labor; pursuant to the Federal Civil Penalties Inflation Adjustment Act of 1990).



**3. Withholding for unpaid wages and liquidated damages.**

The FHWA or the contacting agency shall upon its own action or upon written request of an authorized representative of the Department of Labor withhold or cause to be withheld, from any moneys payable on account of work performed by the contractor or subcontractor under any such contract or any other Federal contract with the same prime contractor, or any other federally-assisted contract subject to the Contract Work Hours and Safety Standards Act, which is held by the same prime contractor, such sums as may be determined to be necessary to satisfy any liabilities of such contractor or subcontractor for unpaid wages and liquidated damages as provided in the clause set forth in paragraph 2 of this section. 29 CFR 5.5.

**4. Subcontracts.** The contractor or subcontractor shall insert in any subcontracts the clauses set forth in paragraphs 1 through 4 of this section and also a clause requiring the subcontractors to include these clauses in any lower tier subcontracts. The prime contractor shall be responsible for compliance by any subcontractor or lower tier subcontractor with the clauses set forth in paragraphs 1 through 4 of this section. 29 CFR 5.5.

**VI. SUBLETTING OR ASSIGNING THE CONTRACT**

This provision is applicable to all Federal-aid construction contracts on the National Highway System pursuant to 23 CFR 635.116.

1. The contractor shall perform with its own organization contract work amounting to not less than 30 percent (or a greater percentage if specified elsewhere in the contract) of the total original contract price, excluding any specialty items designated by the contracting agency. Specialty items may be performed by subcontract and the amount of any such specialty items performed may be deducted from the total original contract price before computing the amount of work required to be performed by the contractor's own organization (23 CFR 635.116).

a. The term "perform work with its own organization" in paragraph 1 of Section VI refers to workers employed or leased by the prime contractor, and equipment owned or rented by the prime contractor, with or without operators. Such term does not include employees or equipment of a subcontractor or lower tier subcontractor, agents of the prime contractor, or any other assignees. The term may include payments for the costs of hiring leased employees from an employee leasing firm meeting all relevant Federal and State regulatory requirements. Leased employees may only be included in this term if the prime contractor meets all of the following conditions: (based on longstanding interpretation)

- (1) the prime contractor maintains control over the supervision of the day-to-day activities of the leased employees;
- (2) the prime contractor remains responsible for the quality of the work of the leased employees;
- (3) the prime contractor retains all power to accept or exclude individual employees from work on the project; and
- (4) the prime contractor remains ultimately responsible for the payment of predetermined minimum wages, the submission of payrolls, statements of compliance and all other Federal regulatory requirements.

b. "Specialty Items" shall be construed to be limited to work that requires highly specialized knowledge, abilities, or

equipment not ordinarily available in the type of contracting organizations qualified and expected to bid or propose on the contract as a whole and in general are to be limited to minor components of the overall contract. 23 CFR 635.102.

2. Pursuant to 23 CFR 635.116(a), the contract amount upon which the requirements set forth in paragraph (1) of Section VI is computed includes the cost of material and manufactured products which are to be purchased or produced by the contractor under the contract provisions.

3. Pursuant to 23 CFR 635.116(c), the contractor shall furnish (a) a competent superintendent or supervisor who is employed by the firm, has full authority to direct performance of the work in accordance with the contract requirements, and is in charge of all construction operations (regardless of who performs the work) and (b) such other of its own organizational resources (supervision, management, and engineering services) as the contracting officer determines is necessary to assure the performance of the contract.

4. No portion of the contract shall be sublet, assigned or otherwise disposed of except with the written consent of the contracting officer, or authorized representative, and such consent when given shall not be construed to relieve the contractor of any responsibility for the fulfillment of the contract. Written consent will be given only after the contracting agency has assured that each subcontract is evidenced in writing and that it contains all pertinent provisions and requirements of the prime contract. (based on longstanding interpretation of 23 CFR 635.116).

5. The 30-percent self-performance requirement of paragraph (1) is not applicable to design-build contracts; however, contracting agencies may establish their own self-performance requirements. 23 CFR 635.116(d).

**VII. SAFETY: ACCIDENT PREVENTION**

This provision is applicable to all Federal-aid construction contracts and to all related subcontracts.

1. In the performance of this contract the contractor shall comply with all applicable Federal, State, and local laws governing safety, health, and sanitation (23 CFR Part 635). The contractor shall provide all safeguards, safety devices and protective equipment and take any other needed actions as it determines, or as the contracting officer may determine, to be reasonably necessary to protect the life and health of employees on the job and the safety of the public and to protect property in connection with the performance of the work covered by the contract. 23 CFR 635.108.

2. It is a condition of this contract, and shall be made a condition of each subcontract, which the contractor enters into pursuant to this contract, that the contractor and any subcontractor shall not permit any employee, in performance of the contract, to work in surroundings or under conditions which are unsanitary, hazardous or dangerous to his/her health or safety, as determined under construction safety and health standards (29 CFR Part 1926) promulgated by the Secretary of Labor, in accordance with Section 107 of the Contract Work Hours and Safety Standards Act (40 U.S.C. 3704). 29 CFR 1926.10.

3. Pursuant to 29 CFR 1926.3, it is a condition of this contract that the Secretary of Labor or authorized representative thereof, shall have right of entry to any site of contract performance to inspect or investigate the matter of compliance

with the construction safety and health standards and to carry out the duties of the Secretary under Section 107 of the Contract Work Hours and Safety Standards Act (40 U.S.C. 3704).

### **VIII. FALSE STATEMENTS CONCERNING HIGHWAY PROJECTS**

This provision is applicable to all Federal-aid construction contracts and to all related subcontracts.

In order to assure high quality and durable construction in conformity with approved plans and specifications and a high degree of reliability on statements and representations made by engineers, contractors, suppliers, and workers on Federal-aid highway projects, it is essential that all persons concerned with the project perform their functions as carefully, thoroughly, and honestly as possible. Willful falsification, distortion, or misrepresentation with respect to any facts related to the project is a violation of Federal law. To prevent any misunderstanding regarding the seriousness of these and similar acts, Form FHWA-1022 shall be posted on each Federal-aid highway project (23 CFR Part 635) in one or more places where it is readily available to all persons concerned with the project:

18 U.S.C. 1020 reads as follows:

"Whoever, being an officer, agent, or employee of the United States, or of any State or Territory, or whoever, whether a person, association, firm, or corporation, knowingly makes any false statement, false representation, or false report as to the character, quality, quantity, or cost of the material used or to be used, or the quantity or quality of the work performed or to be performed, or the cost thereof in connection with the submission of plans, maps, specifications, contracts, or costs of construction on any highway or related project submitted for approval to the Secretary of Transportation; or

Whoever knowingly makes any false statement, false representation, false report or false claim with respect to the character, quality, quantity, or cost of any work performed or to be performed, or materials furnished or to be furnished, in connection with the construction of any highway or related project approved by the Secretary of Transportation; or

Whoever knowingly makes any false statement or false representation as to material fact in any statement, certificate, or report submitted pursuant to provisions of the Federal-aid Roads Act approved July 11, 1916, (39 Stat. 355), as amended and supplemented;

Shall be fined under this title or imprisoned not more than 5 years or both."

### **IX. IMPLEMENTATION OF CLEAN AIR ACT AND FEDERAL WATER POLLUTION CONTROL ACT (42 U.S.C. 7606; 2 CFR 200.88; EO 11738)**

This provision is applicable to all Federal-aid construction contracts in excess of \$150,000 and to all related subcontracts. 48 CFR 2.101; 2 CFR 200.326.

By submission of this bid/proposal or the execution of this contract or subcontract, as appropriate, the bidder, proposer, Federal-aid construction contractor, subcontractor, supplier, or vendor agrees to comply with all applicable standards, orders

or regulations issued pursuant to the Clean Air Act (42 U.S.C. 7401-7671q) and the Federal Water Pollution Control Act, as amended (33 U.S.C. 1251-1387). Violations must be reported to the Federal Highway Administration and the Regional Office of the Environmental Protection Agency. 2 CFR Part 200, Appendix II.

The contractor agrees to include or cause to be included the requirements of this Section in every subcontract, and further agrees to take such action as the contracting agency may direct as a means of enforcing such requirements. 2 CFR 200.326.

### **X. CERTIFICATION REGARDING DEBARMENT, SUSPENSION, INELIGIBILITY AND VOLUNTARY EXCLUSION**

This provision is applicable to all Federal-aid construction contracts, design-build contracts, subcontracts, lower-tier subcontracts, purchase orders, lease agreements, consultant contracts or any other covered transaction requiring FHWA approval or that is estimated to cost \$25,000 or more – as defined in 2 CFR Parts 180 and 1200. 2 CFR 180.220 and 1200.220.

#### **1. Instructions for Certification – First Tier Participants:**

a. By signing and submitting this proposal, the prospective first tier participant is providing the certification set out below.

b. The inability of a person to provide the certification set out below will not necessarily result in denial of participation in this covered transaction. The prospective first tier participant shall submit an explanation of why it cannot provide the certification set out below. The certification or explanation will be considered in connection with the department or agency's determination whether to enter into this transaction. However, failure of the prospective first tier participant to furnish a certification or an explanation shall disqualify such a person from participation in this transaction. 2 CFR 180.320.

c. The certification in this clause is a material representation of fact upon which reliance was placed when the contracting agency determined to enter into this transaction. If it is later determined that the prospective participant knowingly rendered an erroneous certification, in addition to other remedies available to the Federal Government, the contracting agency may terminate this transaction for cause of default. 2 CFR 180.325.

d. The prospective first tier participant shall provide immediate written notice to the contracting agency to whom this proposal is submitted if any time the prospective first tier participant learns that its certification was erroneous when submitted or has become erroneous by reason of changed circumstances. 2 CFR 180.345 and 180.350.

e. The terms "covered transaction," "debarred," "suspended," "ineligible," "participant," "person," "principal," and "voluntarily excluded," as used in this clause, are defined in 2 CFR Parts 180, Subpart I, 180.900-180.1020, and 1200. "First Tier Covered Transactions" refers to any covered transaction between a recipient or subrecipient of Federal funds and a participant (such as the prime or general contract). "Lower Tier Covered Transactions" refers to any covered transaction under a First Tier Covered Transaction (such as subcontracts). "First Tier Participant" refers to the participant

who has entered into a covered transaction with a recipient or subrecipient of Federal funds (such as the prime or general contractor). "Lower Tier Participant" refers any participant who has entered into a covered transaction with a First Tier Participant or other Lower Tier Participants (such as subcontractors and suppliers).

f. The prospective first tier participant agrees by submitting this proposal that, should the proposed covered transaction be entered into, it shall not knowingly enter into any lower tier covered transaction with a person who is debarred, suspended, declared ineligible, or voluntarily excluded from participation in this covered transaction, unless authorized by the department or agency entering into this transaction. 2 CFR 180.330.

g. The prospective first tier participant further agrees by submitting this proposal that it will include the clause titled "Certification Regarding Debarment, Suspension, Ineligibility and Voluntary Exclusion-Lower Tier Covered Transactions," provided by the department or contracting agency, entering into this covered transaction, without modification, in all lower tier covered transactions and in all solicitations for lower tier covered transactions exceeding the \$25,000 threshold. 2 CFR 180.220 and 180.300.

h. A participant in a covered transaction may rely upon a certification of a prospective participant in a lower tier covered transaction that is not debarred, suspended, ineligible, or voluntarily excluded from the covered transaction, unless it knows that the certification is erroneous. 2 CFR 180.300; 180.320, and 180.325. A participant is responsible for ensuring that its principals are not suspended, debarred, or otherwise ineligible to participate in covered transactions. 2 CFR 180.335. To verify the eligibility of its principals, as well as the eligibility of any lower tier prospective participants, each participant may, but is not required to, check the System for Award Management website (<https://www.sam.gov/>). 2 CFR 180.300, 180.320, and 180.325.

i. Nothing contained in the foregoing shall be construed to require the establishment of a system of records in order to render in good faith the certification required by this clause. The knowledge and information of the prospective participant is not required to exceed that which is normally possessed by a prudent person in the ordinary course of business dealings.

j. Except for transactions authorized under paragraph (f) of these instructions, if a participant in a covered transaction knowingly enters into a lower tier covered transaction with a person who is suspended, debarred, ineligible, or voluntarily excluded from participation in this transaction, in addition to other remedies available to the Federal Government, the department or agency may terminate this transaction for cause or default. 2 CFR 180.325.

\* \* \* \* \*

## **2. Certification Regarding Debarment, Suspension, Ineligibility and Voluntary Exclusion – First Tier Participants:**

a. The prospective first tier participant certifies to the best of its knowledge and belief, that it and its principals:

(1) Are not presently debarred, suspended, proposed for debarment, declared ineligible, or voluntarily excluded from participating in covered transactions by any Federal department or agency, 2 CFR 180.335;

(2) Have not within a three-year period preceding this proposal been convicted of or had a civil judgment rendered against them for commission of fraud or a criminal offense in connection with obtaining, attempting to obtain, or performing a public (Federal, State, or local) transaction or contract under a public transaction; violation of Federal or State antitrust statutes or commission of embezzlement, theft, forgery, bribery, falsification or destruction of records, making false statements, or receiving stolen property, 2 CFR 180.800;

(3) Are not presently indicted for or otherwise criminally or civilly charged by a governmental entity (Federal, State or local) with commission of any of the offenses enumerated in paragraph (a)(2) of this certification, 2 CFR 180.700 and 180.800; and

(4) Have not within a three-year period preceding this application/proposal had one or more public transactions (Federal, State or local) terminated for cause or default. 2 CFR 180.335(d).

(5) Are not a corporation that has been convicted of a felony violation under any Federal law within the two-year period preceding this proposal (USDOT Order 4200.6 implementing appropriations act requirements); and

(6) Are not a corporation with any unpaid Federal tax liability that has been assessed, for which all judicial and administrative remedies have been exhausted, or have lapsed, and that is not being paid in a timely manner pursuant to an agreement with the authority responsible for collecting the tax liability (USDOT Order 4200.6 implementing appropriations act requirements).

b. Where the prospective participant is unable to certify to any of the statements in this certification, such prospective participant should attach an explanation to this proposal. 2 CFR 180.335 and 180.340.

### **3. Instructions for Certification - Lower Tier Participants:**

(Applicable to all subcontracts, purchase orders, and other lower tier transactions requiring prior FHWA approval or estimated to cost \$25,000 or more - 2 CFR Parts 180 and 1200). 2 CFR 180.220 and 1200.220.

a. By signing and submitting this proposal, the prospective lower tier participant is providing the certification set out below.

b. The certification in this clause is a material representation of fact upon which reliance was placed when this transaction was entered into. If it is later determined that the prospective lower tier participant knowingly rendered an erroneous certification, in addition to other remedies available to the Federal Government, the department, or agency with which this transaction originated may pursue available remedies, including suspension and/or debarment.

c. The prospective lower tier participant shall provide immediate written notice to the person to which this proposal is submitted if at any time the prospective lower tier participant learns that its certification was erroneous by reason of changed circumstances. 2 CFR 180.365.

d. The terms "covered transaction," "debarred," "suspended," "ineligible," "participant," "person," "principal," and "voluntarily excluded," as used in this clause, are defined in 2 CFR Parts 180, Subpart I, 180.900 – 180.1020, and 1200. You may contact the person to which this proposal is

submitted for assistance in obtaining a copy of those regulations. "First Tier Covered Transactions" refers to any covered transaction between a recipient or subrecipient of Federal funds and a participant (such as the prime or general contractor). "Lower Tier Covered Transactions" refers to any covered transaction under a First Tier Covered Transaction (such as subcontracts). "First Tier Participant" refers to the participant who has entered into a covered transaction with a recipient or subrecipient of Federal funds (such as the prime or general contractor). "Lower Tier Participant" refers to any participant who has entered into a covered transaction with a First Tier Participant or other Lower Tier Participants (such as subcontractors and suppliers).

e. The prospective lower tier participant agrees by submitting this proposal that, should the proposed covered transaction be entered into, it shall not knowingly enter into any lower tier covered transaction with a person who is debarred, suspended, declared ineligible, or voluntarily excluded from participation in this covered transaction, unless authorized by the department or agency with which this transaction originated. 2 CFR 1200.220 and 1200.332.

f. The prospective lower tier participant further agrees by submitting this proposal that it will include this clause titled "Certification Regarding Debarment, Suspension, Ineligibility and Voluntary Exclusion-Lower Tier Covered Transaction," without modification, in all lower tier covered transactions and in all solicitations for lower tier covered transactions exceeding the \$25,000 threshold. 2 CFR 180.220 and 1200.220.

g. A participant in a covered transaction may rely upon a certification of a prospective participant in a lower tier covered transaction that is not debarred, suspended, ineligible, or voluntarily excluded from the covered transaction, unless it knows that the certification is erroneous. A participant is responsible for ensuring that its principals are not suspended, debarred, or otherwise ineligible to participate in covered transactions. To verify the eligibility of its principals, as well as the eligibility of any lower tier prospective participants, each participant may, but is not required to, check the System for Award Management website (<https://www.sam.gov/>), which is compiled by the General Services Administration. 2 CFR 180.300, 180.320, 180.330, and 180.335.

h. Nothing contained in the foregoing shall be construed to require establishment of a system of records in order to render in good faith the certification required by this clause. The knowledge and information of participant is not required to exceed that which is normally possessed by a prudent person in the ordinary course of business dealings.

i. Except for transactions authorized under paragraph e of these instructions, if a participant in a covered transaction knowingly enters into a lower tier covered transaction with a person who is suspended, debarred, ineligible, or voluntarily excluded from participation in this transaction, in addition to other remedies available to the Federal Government, the department or agency with which this transaction originated may pursue available remedies, including suspension and/or debarment. 2 CFR 180.325.

\*\*\*\*\*

**Certification Regarding Debarment, Suspension, Ineligibility and Voluntary Exclusion--Lower Tier Participants:**

1. The prospective lower tier participant certifies, by submission of this proposal, that neither it nor its principals:

(a) is presently debarred, suspended, proposed for debarment, declared ineligible, or voluntarily excluded from participating in covered transactions by any Federal department or agency, 2 CFR 180.355;

(b) is a corporation that has been convicted of a felony violation under any Federal law within the two-year period preceding this proposal (USDOT Order 4200.6 implementing appropriations act requirements); and

(c) is a corporation with any unpaid Federal tax liability that has been assessed, for which all judicial and administrative remedies have been exhausted, or have lapsed, and that is not being paid in a timely manner pursuant to an agreement with the authority responsible for collecting the tax liability. (USDOT Order 4200.6 implementing appropriations act requirements)

2. Where the prospective lower tier participant is unable to certify to any of the statements in this certification, such prospective participant should attach an explanation to this proposal.

\*\*\*\*\*

**XI. CERTIFICATION REGARDING USE OF CONTRACT FUNDS FOR LOBBYING**

This provision is applicable to all Federal-aid construction contracts and to all related subcontracts which exceed \$100,000. 49 CFR Part 20, App. A.

1. The prospective participant certifies, by signing and submitting this bid or proposal, to the best of his or her knowledge and belief, that:

a. No Federal appropriated funds have been paid or will be paid, by or on behalf of the undersigned, to any person for influencing or attempting to influence an officer or employee of any Federal agency, a Member of Congress, an officer or employee of Congress, or an employee of a Member of Congress in connection with the awarding of any Federal contract, the making of any Federal grant, the making of any Federal loan, the entering into of any cooperative agreement, and the extension, continuation, renewal, amendment, or modification of any Federal contract, grant, loan, or cooperative agreement.

b. If any funds other than Federal appropriated funds have been paid or will be paid to any person for influencing or attempting to influence an officer or employee of any Federal agency, a Member of Congress, an officer or employee of Congress, or an employee of a Member of Congress in connection with this Federal contract, grant, loan, or cooperative agreement, the undersigned shall complete and submit Standard Form-LLL, "Disclosure Form to Report Lobbying," in accordance with its instructions.

2. This certification is a material representation of fact upon which reliance was placed when this transaction was made or entered into. Submission of this certification is a prerequisite for making or entering into this transaction imposed by 31 U.S.C. 1352. Any person who fails to file the required certification shall be subject to a civil penalty of not less than \$10,000 and not more than \$100,000 for each such failure.

3. The prospective participant also agrees by submitting its bid or proposal that the participant shall require that the language of this certification be included in all lower tier

subcontracts, which exceed \$100,000 and that all such recipients shall certify and disclose accordingly.

#### **XII. USE OF UNITED STATES-FLAG VESSELS:**

This provision is applicable to all Federal-aid construction contracts, design-build contracts, subcontracts, lower-tier subcontracts, purchase orders, lease agreements, or any other covered transaction. 46 CFR Part 381.

This requirement applies to material or equipment that is acquired for a specific Federal-aid highway project. 46 CFR 381.7. It is not applicable to goods or materials that come into inventories independent of an FHWA funded-contract.

When oceanic shipments (or shipments across the Great Lakes) are necessary for materials or equipment acquired for a specific Federal-aid construction project, the bidder, proposer, contractor, subcontractor, or vendor agrees:

1. To utilize privately owned United States-flag commercial vessels to ship at least 50 percent of the gross tonnage (computed separately for dry bulk carriers, dry cargo liners, and tankers) involved, whenever shipping any equipment, material, or commodities pursuant to this contract, to the extent such vessels are available at fair and reasonable rates for United States-flag commercial vessels. 46 CFR 381.7.
2. To furnish within 20 days following the date of loading for shipments originating within the United States or within 30 working days following the date of loading for shipments originating outside the United States, a legible copy of a rated, 'on-board' commercial ocean bill-of-lading in English for each shipment of cargo described in paragraph (b)(1) of this section to both the Contracting Officer (through the prime contractor in the case of subcontractor bills-of-lading) and to the Office of Cargo and Commercial Sealift (MAR-620), Maritime Administration, Washington, DC 20590. (MARAD requires copies of the ocean carrier's (master) bills of lading, certified onboard, dated, with rates and charges. These bills of lading may contain business sensitive information and therefore may be submitted directly to MARAD by the Ocean Transportation Intermediary on behalf of the contractor). 46 CFR 381.7.

**ATTACHMENT A - EMPLOYMENT AND MATERIALS  
PREFERENCE FOR APPALACHIAN DEVELOPMENT  
HIGHWAY SYSTEM OR APPALACHIAN LOCAL ACCESS  
ROAD CONTRACTS (23 CFR 633, Subpart B, Appendix B)**

This provision is applicable to all Federal-aid projects funded under the Appalachian Regional Development Act of 1965.

1. During the performance of this contract, the contractor undertaking to do work which is, or reasonably may be, done as on-site work, shall give preference to qualified persons who regularly reside in the labor area as designated by the DOL wherein the contract work is situated, or the subregion, or the Appalachian counties of the State wherein the contract work is situated, except:

a. To the extent that qualified persons regularly residing in the area are not available.

b. For the reasonable needs of the contractor to employ supervisory or specially experienced personnel necessary to assure an efficient execution of the contract work.

c. For the obligation of the contractor to offer employment to present or former employees as the result of a lawful collective bargaining contract, provided that the number of nonresident persons employed under this subparagraph (1c) shall not exceed 20 percent of the total number of employees employed by the contractor on the contract work, except as provided in subparagraph (4) below.

2. The contractor shall place a job order with the State Employment Service indicating (a) the classifications of the laborers, mechanics and other employees required to perform the contract work, (b) the number of employees required in each classification, (c) the date on which the participant estimates such employees will be required, and (d) any other pertinent information required by the State Employment Service to complete the job order form. The job order may be placed with the State Employment Service in writing or by telephone. If during the course of the contract work, the information submitted by the contractor in the original job order is substantially modified, the participant shall promptly notify the State Employment Service.

3. The contractor shall give full consideration to all qualified job applicants referred to him by the State Employment Service. The contractor is not required to grant employment to any job applicants who, in his opinion, are not qualified to perform the classification of work required.

4. If, within one week following the placing of a job order by the contractor with the State Employment Service, the State Employment Service is unable to refer any qualified job applicants to the contractor, or less than the number requested, the State Employment Service will forward a certificate to the contractor indicating the unavailability of applicants. Such certificate shall be made a part of the contractor's permanent project records. Upon receipt of this certificate, the contractor may employ persons who do not normally reside in the labor area to fill positions covered by the certificate, notwithstanding the provisions of subparagraph (1c) above.

5. The provisions of 23 CFR 633.207(e) allow the contracting agency to provide a contractual preference for the use of mineral resource materials native to the Appalachian region.

6. The contractor shall include the provisions of Sections 1 through 4 of this Attachment A in every subcontract for work which is, or reasonably may be, done as on-site work.

**STANDARD SPECIAL PROVISION****ON-THE-JOB TRAINING**

(10-16-07) (Rev. 4-21-15)

Z-10

**Description**

The North Carolina Department of Transportation will administer a custom version of the Federal On-the-Job Training (OJT) Program, commonly referred to as the Alternate OJT Program. All contractors (existing and newcomers) will be automatically placed in the Alternate Program. Standard OJT requirements typically associated with individual projects will no longer be applied at the project level. Instead, these requirements will be applicable on an annual basis for each contractor administered by the OJT Program Manager.

On the Job Training shall meet the requirements of 23 CFR 230.107 (b), 23 USC – Section 140, this provision and the On-the-Job Training Program Manual.

The Alternate OJT Program will allow a contractor to train employees on Federal, State and privately funded projects located in North Carolina. However, priority shall be given to training employees on NCDOT Federal-Aid funded projects.

**Minorities and Women**

Developing, training and upgrading of minorities and women toward journeyman level status is a primary objective of this special training provision. Accordingly, the Contractor shall make every effort to enroll minority and women as trainees to the extent that such persons are available within a reasonable area of recruitment. This training commitment is not intended, and shall not be used, to discriminate against any applicant for training, whether a member of a minority group or not.

**Assigning Training Goals**

The Department, through the OJT Program Manager, will assign training goals for a calendar year based on the contractors' past three years' activity and the contractors' anticipated upcoming year's activity with the Department. At the beginning of each year, all contractors eligible will be contacted by the Department to determine the number of trainees that will be assigned for the upcoming calendar year. At that time the Contractor shall enter into an agreement with the Department to provide a self-imposed on-the-job training program for the calendar year. This agreement will include a specific number of annual training goals agreed to by both parties. The number of training assignments may range from 1 to 15 per contractor per calendar year. The Contractor shall sign an agreement to fulfill their annual goal for the year.\

### **Training Classifications**

The Contractor shall provide on-the-job training aimed at developing full journeyman level workers in the construction craft/operator positions. Preference shall be given to providing training in the following skilled work classifications:

Equipment Operators	Office Engineers
Truck Drivers	Estimators
Carpenters	Iron / Reinforcing Steel Workers
Concrete Finishers	Mechanics
Pipe Layers	Welders

The Department has established common training classifications and their respective training requirements that may be used by the contractors. However, the classifications established are not all-inclusive. Where the training is oriented toward construction applications, training will be allowed in lower-level management positions such as office engineers and estimators. Contractors shall submit new classifications for specific job functions that their employees are performing. The Department will review and recommend for acceptance to FHWA the new classifications proposed by contractors, if applicable. New classifications shall meet the following requirements:

Proposed training classifications are reasonable and realistic based on the job skill classification needs, and

The number of training hours specified in the training classification is consistent with common practices and provides enough time for the trainee to obtain journeyman level status.

The Contractor may allow trainees to be trained by a subcontractor provided that the Contractor retains primary responsibility for meeting the training and this provision is made applicable to the subcontract. However, only the Contractor will receive credit towards the annual goal for the trainee.

Where feasible, 25 percent of apprentices or trainees in each occupation shall be in their first year of apprenticeship or training. The number of trainees shall be distributed among the work classifications on the basis of the contractor's needs and the availability of journeymen in the various classifications within a reasonable area of recruitment.

No employee shall be employed as a trainee in any classification in which they have successfully completed a training course leading to journeyman level status or in which they have been employed as a journeyman.

### **Records and Reports**

The Contractor shall maintain enrollment, monthly and completion reports documenting company compliance under these contract documents. These documents and any other information as requested shall be submitted to the OJT Program Manager.

Upon completion and graduation of the program, the Contractor shall provide each trainee with a certification Certificate showing the type and length of training satisfactorily completed.



**Trainee Interviews**

All trainees enrolled in the program will receive an initial and Trainee/Post graduate interview conducted by the OJT program staff.

**Trainee Wages**

Contractors shall compensate trainees on a graduating pay scale based upon a percentage of the prevailing minimum journeyman wages (Davis-Bacon Act). Minimum pay shall be as follows:

60 percent	of the journeyman wage for the first half of the training period
75 percent	of the journeyman wage for the third quarter of the training period
90 percent	of the journeyman wage for the last quarter of the training period

In no instance shall a trainee be paid less than the local minimum wage. The Contractor shall adhere to the minimum hourly wage rate that will satisfy both the NC Department of Labor (NCDOL) and the Department.

**Achieving or Failing to Meet Training Goals**

The Contractor will be credited for each trainee employed by him on the contract work who is currently enrolled or becomes enrolled in an approved program and who receives training for at least 50 percent of the specific program requirement. Trainees will be allowed to be transferred between projects if required by the Contractor's scheduled workload to meet training goals.

If a contractor fails to attain their training assignments for the calendar year, they may be taken off the NCDOT's Bidders List.

**Measurement and Payment**

No compensation will be made for providing required training in accordance with these contract documents.

**STANDARD SPECIAL PROVISION**  
**MINIMUM WAGES**  
**GENERAL DECISION NC20220090 02/25/2022 NC90**

Z-090

Date: February 25, 2022

General Decision Number: NC20220090 02/25/2022 NC90

Superseded General Decision Numbers: NC20210090

State: North Carolina

Construction Type: HIGHWAY

**COUNTIES:**

Brunswick	Greene	Onslow
Cumberland	Hoke	Pender
Currituck	Johnston	Pitt
Edgecombe	Nash	Wake
Franklin	New Hanover	Wayne

HIGHWAY CONSTRUCTION PROJECTS (excluding tunnels, building structures in rest area projects & railroad construction; bascule, suspension & spandrel arch bridges designed for commercial navigation, bridges involving marine construction; and other major bridges).

Note: Contracts subject to the Davis-Bacon Act are generally required to pay at least the applicable minimum wage rate required under Executive Order 14026 or Executive Order 13658. Please note that these Executive Orders apply to covered contracts entered into by the federal government that are subject to the Davis-Bacon Act itself, but do not apply to contracts subject only to the Davis-Bacon Related Acts, including those set forth at 29 CFR 5.1(a)(2)-(60).

If the contract is entered into on or after January 30, 2022, or the contract is renewed or extended (e.g., an option is exercised) on or after January 30, 2022:	Executive Order 14026 generally applies to the contract.  The contractor must pay all covered workers at least \$15.00 per hour (or the applicable wage rate listed on this wage determination, if it is higher) for all hours spent performing on that contract in 2022.
If the contract was awarded on or between January 1, 2015 and January 29, 2022, and the contract is not renewed or extended on or after January 30, 2022:	Executive Order 13658 generally applies to the contract.  The contractor must pay all covered workers at least \$11.25 per hour (or the applicable wage rate listed on this wage determination, if it is higher) for all hours spent performing on that contract in 2022.

The applicable Executive Order minimum wage rate will be adjusted annually. If this contract is covered by one of the Executive Orders and a classification considered necessary for performance of work on the contract does not appear on this wage determination, the contractor must still submit a conformance request.

Additional information on contractor requirements and worker protections under the Executive Orders is available at <https://www.dol.gov/agencies/whd/government-contracts>.

Modification Number

Publication Date

0

01/07/2022

1

02/25/2022

SUNC2014-005 11/17/2014

	Rates	Fringes
BLASTER	21.04	
CARPENTER	13.72 **	
CEMENT MASON/CONCRETE FINISHER	14.48 **	
ELECTRICIAN		
Electrician	17.97	
Telecommunications Technician	16.79	.63
IRONWORKER	16.02	
LABORER		
Asphalt Raker and Spreader	12.46 **	
Asphalt Screed/Jackman	14.33 **	
Carpenter Tender	12.88 **	
Cement Mason/Concrete Finisher Tender	12.54 **	
Common or General	10.20 **	
Guardrail/Fence Installer	12.87 **	
Pipelayer	12.17 **	
Traffic Signal/Lighting Installer	14.89 **	
PAINTER		
Bridge	24.57	
POWER EQUIPMENT OPERATORS		
Asphalt Broom Tractor	11.85 **	
Bulldozer Fine	17.04	
Bulldozer Rough	14.34 **	
Concrete Grinder/Groover	20.34	2.30
Crane Boom Trucks	20.54	
Crane Other	20.08	
Crane Rough/All-Terrain	20.67	
Drill Operator Rock	14.38 **	
Drill Operator Structure	21.14	
Excavator Fine	16.60	
Excavator Rough	14.00 **	
Grader/Blade Fine	18.47	
Grader/Blade Rough	14.62 **	
Loader 2 Cubic Yards or Less	13.76 **	
Loader Greater Than 2 Cubic Yards	14.14 **	
Material Transfer Vehicle (Shuttle Buggy)	15.18	
Mechanic	17.55	
Milling Machine	15.36	
Off-Road Hauler/Water Tanker	11.36 **	
Oiler/Greaser	13.55 **	
Pavement Marking Equipment	12.11 **	
Paver Asphalt	15.59	
Paver Concrete	18.20	
Roller Asphalt Breakdown	12.45 **	
Roller Asphalt Finish	13.85 **	
Roller Other	11.36 **	

	Rates	Fringes
Scraper Finish	12.71 **	
Scraper Rough	11.35 **	
Slip Form Machine	16.50	
Tack Truck/Distributor Operator	14.52 **	
TRUCK DRIVER		
GVWR of 26,000 Lbs or Less	11.12 **	
GVWR of 26,001 Lbs or Greater	12.37 **	

Welders – Receive rate prescribed for craft performing operation to which welding is incidental.

\*\* Workers in this classification may be entitled to a higher minimum wage under Executive Order 14026 (\$15.00) or 13658 (\$11.25). Please see the Note at the top of the wage determination for more information.

Note: Executive Order (EO) 13706, Establishing Paid Sick Leave for Federal Contractors applies to all contracts subject to the Davis-Bacon Act for which the contract is awarded (and any solicitation was issued) on or after January 1, 2017. If this contract is covered by the EO, the contractor must provide employees with 1 hour of paid sick leave for every 30 hours they work, up to 56 hours of paid sick leave each year. Employees must be permitted to use paid sick leave for their own illness, injury or other health-related needs, including preventive care; to assist a family member (or person who is like family to the employee) who is ill, injured, or has other health-related needs, including preventive care; or for reasons resulting from, or to assist a family member (or person who is like family to the employee) who is a victim of, domestic violence, sexual assault, or stalking. Additional information on contractor requirements and worker protections under the EO is available at <https://www.dol.gov/agencies/whd/government-contracts>.

Unlisted classifications needed for work not included within the scope of the classifications listed may be added after award only as provided in the labor standards contract clauses (29 CFR 5.5(a)(1)(ii)).

The body of each wage determination lists the classification and wage rates that have been found to be prevailing for the cited type(s) of construction in the area covered by the wage determination. The classifications are listed in alphabetical order of "identifiers" that indicate whether the particular rate is a union rate (current union negotiated rate for local), a survey rate (weighted average rate) or a union average rate (weighted union average rate).

#### Union Rate Identifiers

A four letter classification abbreviation identifier enclosed in dotted lines beginning with characters other than "SU" or "UAVG" denotes that the union classification and rate were prevailing for that classification in the survey. Example: PLUM0198-005 07/01/2014. PLUM is an abbreviation identifier of the union which prevailed in the survey for this classification, which in this example would be Plumbers. 0198 indicates the local union number or district council number where applicable, i.e., Plumbers Local 0198. The next number, 005 in the example, is an internal number used in processing the wage determination. 07/01/2014 is the effective date of the most current negotiated rate, which in this example is July 1, 2014.

Union prevailing wage rates are updated to reflect all rate changes in the collective bargaining agreement (CBA) governing this classification and rate.

#### Survey Rate Identifiers

Classifications listed under the "SU" identifier indicate that no one rate prevailed for this classification in the survey and the published rate is derived by computing a weighted average rate based on all the rates reported in the survey for that classification. As this weighted average rate includes all rates reported in the survey, it may include both union and non-union rates. Example: SULA2012-007 5/13/2014. SU indicates the rates are survey rates based on a weighted average calculation of rates and are not majority rates. LA indicates the State of Louisiana. 2012 is the year of survey on which these classifications and rates are based. The next number, 007 in the example, is an internal number used in producing the wage determination. 5/13/2014 indicates the survey completion date for the classifications and rates under that identifier.

Survey wage rates are not updated and remain in effect until a new survey is conducted.

#### Union Average Rate Identifiers

Classification(s) listed under the UAVG identifier indicate that no single majority rate prevailed for those classifications; however, 100% of the data reported for the classifications was union data. EXAMPLE: UAVG-OH-0010 08/29/2014. UAVG indicates that the rate is a weighted union average rate. OH indicates the state. The next number, 0010 in the example, is an internal number used in producing the wage determination. 08/29/2014 indicates the survey completion date for the classifications and rates under that identifier.

A UAVG rate will be updated once a year, usually in January of each year, to reflect a weighted average of the current negotiated/CBA rate of the union locals from which the rate is based.

#### WAGE DETERMINATION APPEALS PROCESS

1.) Has there been an initial decision in the matter? This can be:

- \* an existing published wage determination
- \* a survey underlying a wage determination
- \* a Wage and Hour Division letter setting forth a position on a wage determination matter
- \* a conformance (additional classification and rate) ruling

On survey related matters, initial contact, including requests for summaries of surveys, should be with the Wage and Hour National Office because National Office has responsibility for the David-Bacon survey program. If the response from this initial contact is not satisfactory, then the process described in 2.) and 3.) should be followed.

With regard to any other matter not yet ripe for the formal process described here, initial contact should be with the Branch of Construction Wage Determinations. Write to:

Branch of Construction Wage Determinations  
Wage and Hour Division  
U. S. Department of Labor  
200 Constitution Avenue, N.W.  
Washington, D.C. 20210

2.) If the answer to the question in 1.) is yes, then an interested party (those affected by the action) can request review and reconsideration from the Wage and Hour Administrator (See 29 CFR Part 1.8 and 29 CFR Part 7). Write to:

Wage and Hour Administrator

U.S. Department of Labor  
200 Constitution Avenue, N.W.  
Washington, D.C. 20210

The request should be accompanied by a full statement of the interested party's position and by any information (wage payment data, project description, area practice material, etc.) that the requestor considers relevant to the issue.

- 3.) If the decision of the Administrator is not favorable, an interested party may appeal directly to the Administrative Review Board (formerly the Wage Appeals Board). Write to:

Administrative Review Board  
U.S. Department of Labor  
200 Constitution Avenue, N.W.  
Washington, D.C. 20210

- 4.) All decisions by the Administrative Review Board are final.

END OF GENERAL DECISION



DocuSigned by:  
*Matthew V. Springer*  
 BC60F6E8B584403...  
 8/27/2020

**POLYUREA PAVEMENT MARKING MEDIA AND THICKNESS:**  
 (08-27-20)

Amend the *NCDOT 2018 Standard Specifications* as follows:

**Page 12-8, Subarticle 1205-5(B)**, lines 14-16, replace with the following:

Produce polyurea pavement marking lines that have a minimum dry thickness of 20 mils above the pavement surface when placed on concrete and asphalt pavements. Produce polyurea pavement marking lines that have a minimum dry thickness of 30 mils above the pavement surface on textured surfaces such as OGFC and on surfaces where the polyurea will be placed over a previously removed pavement marking.

**Page 12-9**, replace **Table 1205-4 Minimum Reflectometer Requirement for Polyurea** with the following:

TABLE 1205-4 MINIMUM REFLECTOMETER REQUIREMENTS FOR POLYUREA		
Item	Color	Reflectivity
Standard Glass Beads	White	375 mcd/lux/m <sup>2</sup>
	Yellow	250 mcd/lux/m <sup>2</sup>

The installer may choose to use an AASHTO Type 4/Type 1 or AASHTO Type 3/Type 1 double drop system, but no price adjustment will be made, and these systems will be incidental to the polyurea pavement marking.

Pay Item

Pay Unit

Polyurea Pavement Marking Lines, \_\_\_\_\_", \_\_\_\_\_mils  
 (Standard Glass Beads)

Linear Foot

# TC-1

HI-0008

Johnston County

## WORK ZONE TRAFFIC CONTROL Project Special Provisions Table of Contents

<b>Special Provision</b>	<b>Page</b>
Work Zone Traffic Control for Interstate/Freeway Resurfacing	TC-2
Connected Lane Closure Devices	TC-15
Work Zone Digital Speed Limit Signs	TC-17
Work Zone Presence Lighting	TC-22
Sequential Flashing Warning Lights	TC-25

9/29/2021



DocuSigned by:  
*R. K. Murphy, Jr.*  
687DF3E849AF42C...



## TC-2

HI-0008

Johnston County

### **WORK ZONE TRAFFIC CONTROL FOR INTERSTATE/FREEWAY RESURFACING** (02/17/2020) (Rev. 5/10/2021)

#### **General Requirements**

This Provision is intended for interstate / freeway resurfacing projects. In the event, the day and time restrictions allow for daytime work activities the Work Zone Presence Lighting and Sequential Flashing Lights are to be omitted. However, the Digital Speed Limit Signs and Connected Lane Closure Devices will be required as described below.

Maintain traffic in accordance with Divisions 10, 11 and 12 of the *2018 NCDOT Standard Specifications* and the following provisions:

Install Work Zone Advance Warning Signs in accordance with the attached drawing prior to beginning any other work.

When personnel and/or equipment are working on the shoulder adjacent to a divided facility and within 10 feet of an open travel lane, close the nearest open travel lane using Standard Drawing No. 1101.02 of the *2018 NCDOT Roadway Standard Drawings*.

When personnel and/or equipment are working within a lane of travel of a divided facility, close the lane using Standard Drawing No. 1101.02 of the *2018 NCDOT Roadway Standard Drawings* or as directed by the Engineer. Conduct the work so that all personnel and/or equipment remain within the closed travel lane. Perform work only when weather and visibility conditions allow safe operations as directed by the Engineer.

#### **1. Time Restrictions for Lane Closure and Road Closure Activities**

All lane closure and road closure activities shall be performed in compliance with the day and time restrictions listed and defined in this Contract.

Any activities performed outside of these requirements will be subject to the liquidated damages unless approved by the Engineer prior to beginning the activity.

The Contractor may place/pre-stage all required signs and traffic control devices necessary for lane closures prior to the closure time as approved by the Engineer. However, flashing arrow boards and changeable message signs shall not indicate lane closure information until 30 minutes or less prior to the installation of the lane closure. Typical pre-staging times are 1 hour for a single lane closure. The travel lane is to be closed at the prescribed times defined in this Contract. When available, law enforcement should be onsite to shadow workers during pre-staging activities.

# TC-3

HI-0008

Johnston County

For removal, the lane(s) must be reopened in compliance with the times defined in this Contract. It is acceptable to remove the signs and traffic control devices from the shoulder/staging area after the lane(s) are reopened to traffic. All electronic lane closure messages and flashing arrow displays shall be off once lanes are opened. When available, law enforcement should remain on the project while workers remove and secure their signs and devices.

## **2. Work Zone Speed Limits and Digital Speed Limit Signs (DSLSS)**

All speed limits are the sole authority of the NCDOT. An ordinance by the State Traffic Engineer is required for all speed limits in order to have a lawfully enforceable speed limit. No speed limit messages/signs shall be installed prior to receiving a signed ordinance.

The Regional Traffic Engineering Office and the Division Construction Engineer in coordination with the Work Zone Traffic Control Section will provide all work zone speed limit recommendations based on activities and conditions.

When lane closures are in effect, implement a Work Zone Variable Speed Limit Reduction as stated in the ordinance and in accordance with the attached provision and drawing.

Use Digital Speed Limit Signs (DSLSS) to display the work zone speed limit as shown in the attached special provision and drawing. The speed limit shall be continuously displayed on the digital speed limit signs.

The Contractor will be responsible for coordinating with the Engineer when the work zone speed limits are to be changed and will have to seek approval by the Engineer before the speed limit is changed.

When the variable speed limit reductions are in effect, cover or remove any existing speed limit signs located within the active work area that conflict with the variable speed limit reduction.

The speed limit shall be returned to the existing speed limit when the lane closure is removed and traffic is returned to the existing pattern.

## **3. Connected Lane Closure Devices**

Furnish and install Connected Lane Closure Devices that transmit the location of the lane closure to navigational companies and the Statewide Transportation Operations Center (STOC).

## **4. Work Zone Presence Lighting and Sequential Flashing Warning Lights**

Provide the following for nighttime work activities in accordance with attached drawing and special provisions:

## TC-4

HI-0008

Johnston County

A. Furnish and install Work Zone Presence Lighting to supplement the Contractor's portable construction and equipment lighting for the purpose of alerting motorist to the existence of an active work zone and to encourage compliance with the reduced work zone speed limit. See attached special provision.

B. Furnish and install Sequential Flashing Warning Lights on drums used for merging tapers to assist motorist in determining which direction to merge and to decrease late lane merging. See attached special provision.

### 5. Law Enforcement

Use two (2) off duty, uniformed law enforcement officers and official law enforcement vehicles, equipped with blue lights during lane closure operations and two (2) additional law enforcement officers for ramp/loop closures when both operations occur simultaneously.

Use law enforcement officers to assist in the shadowing of workers during the installation and during the removal of lane closures.

Law enforcement vehicles shall not be parked within the buffer space. When possible, position one law enforcement officer downstream of the other to conduct enforcement operations. When space is confined, conduct enforcement outside of the lane closure area.

### Temporary Traffic Control (TTC)

Refer to Standard Drawing No. 1101.02, 1101.11, 1110.01, 1110.02, 1115.01, 1130.01, 1135.01, 1165.01, and 1180.01 of the *2018 NCDOT Roadway Standard Drawings* when closing a lane of travel in a stationary work zone for items such as milling, paving, diamond grinding concrete pavements, minor bridge operations, and approach slab rehabilitation.

Drums are recommended for all lane closure operations occurring at night. However, if skinny drums are used at night, they shall be placed every 20' in the tangent sections of lane closure operations. Skinny drums shall not be used for upstream tapers.

When covering work zone signs, use an opaque material that prevents reading of the sign at night by a driver using high beam headlights. Use material which does not damage the sign sheeting.

Refer to Roadway Standard Drawing No. 1101.02, sheets 9 and 10, of the *2018 NCDOT Roadway Standard Drawings* for diamond grinding, milling and/or paving of ramps unless otherwise approved to be closed by the Engineer. If approved, see attached drawing for typical placement of devices and signing for the detour route. All items shall be compensated for based on the unit bid price for the respective item.

## TC-5

HI-0008

Johnston County

The Contractor has the option of closing I-95 utilizing either a moving road closure operation or an offsite detour for erection and removal of overhead signs and sign structures:

If the Contractor elects the moving road closure operation, refer to Roadway Standard Drawing No. 1101.03, sheet 9, of the *2018 NCDOT Roadway Standard Drawings* (Temporary Road Closures – Rolling Road Block Operation – Multi- Lane Facility). This standard drawing may also be used for such items as installation of lane closures, or other situations where the entire travel way must be slow rolling or closed to traffic. Refer to the General Notes.

The Contractor shall not implement Roadway Standard Drawing No. 1101.03, sheet 9, of the *2018 NCDOT Roadway Standard Drawings* on **I-95** during the following time restrictions:

### **Day and Time Restrictions**

5:00 A.M. – 11:00 P.M.  
Sunday through Saturday

Or

If the Contractor elects the offsite detour, refer to sheets PSH-04, TMP-01, TMP-02, and TMP-03. Refer to the General Notes.

Refer to Roadway Standard Drawing No. 1101.02, sheet 12 or 13, of the *2018 NCDOT Roadway Standard Drawings* for utilizing a moving operation for such items as pavement marking and marker placement. A minimum speed of 3 mph shall be maintained at all times with no stops that narrow or close a lane of travel. If the moving operation is progressing slower than 3 mph at any time, install a lane closure. All traffic control devices for this operation are considered incidental to the pay items for pavement markings and markers.

### **Traffic Operations**

#### **1. Project Requirements**

Failure to comply with the following requirements will result in a suspension of all other operations:

- A. Before working on ANY MAP, the Contractor shall submit a written construction sequence for traffic control and construction lighting for ALL MAPS to the Engineer at the first pre-construction meeting and the sequence must be approved before closing a lane of traffic.

## TC-6

HI-0008

Johnston County

- B. The standard active work area is 2 miles. This is defined as the distance of Resurfacing Operations taking place in a single work period. However, the maximum allowed lane closure distance is 5 miles. Approval by the Engineer is required before closing more than 2 miles of Interstate to ensure the Contractor has the equipment and labor force to actively pursue the work.
- C. Notify the Engineer 15 consecutive calendar days before resurfacing a bridge or its approaches. Patch and make repairs to bridge surface and its approaches before resurfacing occurs. Coordinate all operations on the bridge and its approaches with the Engineer.
- D. Notify the Engineer 48 hours before resurfacing the areas of existing pavement that require patching. Patch these areas before resurfacing occurs. Allow full depth asphalt patching to cool to the point of supporting traffic without displacement or rutting before reopening closed lane. Coordinate the resurfacing operations of the patched areas with the Engineer.
- E. Notify the Engineer 48 hours before milling or resurfacing will interfere with the existing Signal Loops. Loops may need to be placed in milled surface before resurfacing occurs. Coordinate all signal loop operations with the Engineer.
- F. Obtain written approval of the Engineer before working in more than one location or setting up additional lane closures.
- G. The Contractor on this and any adjacent projects, or subcontractors working within this project shall coordinate lane closure location, type, and direction with the Engineer to best maintain lane continuity through the limits of this and adjacent projects.
- H. Operate equipment and conduct operations in the same direction as the flow of traffic. Maintain vehicular access in accordance with Article 1101-05 of the *2018 NCDOT Standard Specifications*.
- I. Provide appropriate construction lighting in accordance with Section 1413 of the *2018 NCDOT Standard Specifications*.
- J. Contractor shall diamond grind, mill, and pave lanes in an order such that water shall not accumulate.

### 2. Paving Lift Requirements and Time Limitations

**Failure to comply with the following requirements will result in a suspension of all other operations until all lanes of traffic are brought to the same station and elevation:**

#### Paving Overlays and Lifts up to 3”

- A. For surface course paving lifts of 2.0” or less, the Contractor shall conduct his paving operations such that the following conditions are met.

## TC-7

HI-0008

Johnston County

Once paving begins in any lane, the Contractor will be permitted to pave as far as the work operations allow (up to 5 miles) for the initial paving period. In the next days' paving operation, not to exceed 72 hours, bring the adjacent lane to the same station and elevation. At the end of the work period, any uneven lane conditions shall be signed with an "UNEVEN PAVEMENT/NEXT XX MILES" on the portable changeable message signs and portable "UNEVEN PAVEMENT" signs (dual mounted) 1,000' in advance of the uneven pavement and every ½ miles thereafter along the uneven portion of roadway. Once mitigated, all portable "UNEVEN PAVEMENT" signs shall be removed.

For Open Graded Surface Mixes, "UNEVEN PAVEMENT" signs are not required.

- B. For 3" surface course mixes, place in two paving lifts of 1 ½" each unless directed otherwise by the Engineer. Conditions for uneven travel lanes same as described above.

### Paving Lifts Greater than 3"

For all other paving lifts greater than 3", bring all newly resurfaced lanes to the same station and elevation by the end of each work period unless the Contractor utilizes the notched wedge paving methods as described below:

- A. Any paving lift greater than 3" shall be mitigated by having an approved wedge apparatus on the paver that shapes the edge 1" vertically and the remaining at a maximum slope steepness of 2:1. The maximum paving lift allowed to use this method is 3".
- B. At the end of the work period, the Contractor shall place portable "UNEVEN PAVEMENT" signs in advance of the uneven pavement and spaced every ½ mile along the section of uneven pavement. Once mitigated, all portable "UNEVEN PAVEMENT" signs shall be removed.
- C. In the next day's paving operation and not to exceed 72 hours, the Contractor shall bring up the adjacent lane to the same station and elevation before any further paving takes place on the project.

### Milling Operations (Does Not Apply to Fine Milling)

Conduct milling operations so that any milled pavement is paved back by the end of each work period.

A milled/grooved surface shall not be re-opened to traffic except in cases where inclement weather or mechanical failure prevents the paving back of the lane by the end of the work period.

## TC-8

HI-0008

Johnston County

If milled areas are not paved back within the same work period due to inclement weather or mechanical failure, the Contractor is to furnish and install portable signs to warn drivers of the conditions. The signs include “Grooved Pavement” (W8-15) w/ Motorcycle Plaque mounted below, and “Uneven Lanes” (W8-11). These are to be dual indicated where lateral clearance can be obtained within the median areas. Install the “Grooved Pavement” (W8-15) w/ Motorcycle Plaque 1500’ in advance of the milled area. Install the “Uneven Lanes” (W8-11) 500’ in advance of the milled area. Alternate these signs every ½ mile. Once mitigated, all portable signs are to be removed.

Slope the pavement at the beginning and ending of the daily milling operation as directed by the Engineer. Sweep and remove all milled material from the roadway as soon as the daily milling operation is completed. Remove any existing pavement adjacent to the milled area that has been damaged and replace with patch material as directed by the Engineer.

### Fine Milling / Microsurfacing Operations (Depths less than 1”)

For fine milling operations less than 1”, paving is not required in the same work period. The paving of the fine milled area is to be conducted within the next work period and not to exceed 72 hours. No advance warning signs are needed for the conditions. However, pavement markings are required by the end of each work period.

### **3. Temporary Pavement Markings**

Review and record the existing pavement markings and markers before obliteration. Re-establish the new pavement markings and markers using the record of existing markings in conjunction with the *2018 NCDOT Roadway Standard Drawings* unless otherwise directed by the Engineer. Submit the record of the existing pavement markings seven calendar days before the obliteration of any pavement markings.

Obliterated pavement markings shall be replaced by the end of each work period. Interim paint may be used to comply with time limitations if final pavement markings cannot be placed except for milled surfaces or diamond ground surfaces. Final markings shall be placed within 30 days in accordance with Section 1205-4 and Section 1205-5. For milled surfaces, temporary pavement markings shall be used in accordance with Section 1205-8(C). There will be no direct payment for interim paint. Temporary paint will be paid for at the contract unit price.

For concrete surfaces that have been diamond ground as a surface treatment, 4” temporary paint shall be used in accordance with Section 1205-8(C). Upon completion of all diamond grinding operations, 4” line removal shall be used to remove 100% of the 4” temporary paint on the final concrete surface by grinding method only. Use an acceptable method to grind ridges smooth only where pavement markings will be installed prior to placing final pavement marking material. This

# TC-9

HI-0008

Johnston County

method shall also be used in the area of the black contrast for surface preparation. Payment for line removal will be made in accordance with Section 1205-10.

For project winterization, install temporary paint markings in accordance with Section 1205-8(C) of the *2018 NCDOT Standard Specifications*. Use 4" lane, edge, and center lines and 8" gore lines. Compensation for this work shall be made in accordance with Section 1205-10 except that no payment will be made if paving is completed more than 30 days before the written notification by the Department that winterization is required.

## 4. Work Zone Signing

### A. Description

Install advance/general warning work zone signs according to the attached drawings prior to beginning work.

For paving overlays of 3" or greater that create a drop-off adjacent to the median shoulder, install "LOW/SOFT SHOULDER" (SP 13107) signs on the median shoulder. Place initially at the construction limits, and then space 1 mile thereafter. No signing required for the outside shoulder.

Install and maintain signing in accordance with the Divisions 11 and 12 of the *2018 NCDOT Standard Specifications*.

### B. Installation

All stationary Work Zone Advance/General Warning signs require notification to existing Utility owners per Article 105-8 of the 2018 Standard Specifications and Special Provision SP1 G115 within 3 to 12 full working days prior to installation.

Install all Work Zone Advance/General Warning signs before beginning work on a particular map. If signs are installed more than seven (7) calendar days prior to the beginning of work on a particular map, cover the signs until the work begins. Install each Work Zone Advance/General Warning sign separately and not on the same post or stand with any other sign except where an advisory speed plate or directional arrow is used.

All sign locations to be verified by the Engineer prior to installation. Once the signs have been installed and accepted, any sign relocations requested by the Department will be compensated in accordance with Article 104-7. Any additional signs other than the ones required in this provision or attached drawings will be compensated in accordance with Article 104-7.



# TC-10

HI-0008

Johnston County

If there is a period of construction inactivity longer than 14 calendar days, remove or cover Work Zone Advance/General Warning signs. Uncover Work Zone Advance/General Warning signs no more than 7 calendar days before work resumes.

All other operations may be suspended upon failure to comply with the above requirements. Such suspended operations would not be resumed until the above requirements are fulfilled.

## C. Sign Removal

Once Maps on the project are substantially completed, it is acceptable to remove the stationary work zone signs on those Maps in lieu of waiting until all of the Maps are completed on the project. A Map is substantially complete when the resurfacing operations are completed and the shoulders are brought up to the same elevation as the proposed pavement and when temporary pavement markings (paint) are installed along the centerline and edge lines as well as the ramps and loops. The final pavement markings (thermoplastic or polyurea) and/or markers do not have to be installed for the Map to be considered substantially complete. Final pavement markings and markers are installed with portable signing and changeable message signs according to Roadway Standard Drawing 1101.02, sheet 13. Any remaining punch list items requiring traffic control are to be completed using portable work zone signing with compensation covered in the contract unit price for the required traffic control items.

**Stationary Work Zone Sign removal is a condition of final project acceptance.**

## D. Lane Closure Work Zone Signs

Install any required lane closure signing needed during the life of the project in accordance with the Standard Drawing No. 1101.02, 1101.11, and 1110.02 of the *2018 NCDOT Roadway Standard Drawings*.

## Measurement and Payment

The lane closure distance is measured from the end of the merge taper where traffic is completely in the remaining open lane(s) to the last channelizing device closing the lane. For multiple lane closures, the lane closure distance is measured from the end of the last merge taper to the last channelizing device closing the lane.

*Work Zone Advance / General Warning Signing* will be measured and paid as the actual number of square feet satisfactorily installed at each location and accepted by the Engineer.

## TC-11

HI-0008

Johnston County

*Work Zone Signs (Barricade Mounted)* will be measured and paid in accordance with Section 1110-4.

*Work Zone Signs (Portable)* will be measured and paid in accordance with Section 1110-4.

*Flashing Arrow Board* will be measured and paid in accordance with Section 1115-4.

*Drums* will be measured and paid in accordance with Section 1130-4.

*Barricades* will be measured and paid in accordance with Section 1145-5.

*Single Lane Closure* will be measured and paid as the actual number of single stationary lane closures satisfactorily installed for required operations as shown in Roadway Standard Drawing 1101.02, sheets 4, 5, 6, 9 & 10. All labor, traffic control devices, and signing for *Single Lane Closure*, up to 2 miles, as shown in these Roadway Standard Drawings are paid under this item

*Ramp/Loop Closure* will be measured and paid as the actual number of total ramp/loop closures and detours satisfactorily installed for ramp/loop paving and all other required operations, as shown on the Short Term Closure and Detour of Interstate/Freeway Ramps detail drawing. All labor, traffic control devices and signing required for re-routing traffic as shown on the Short Term Closure and Detour of Interstate/Freeway Ramps detail drawing are paid under this item. In the event two separate ramps are closed at the same time, they will be measured individually and paid on a per each basis.

*Paint Pavement Marking Lines, Paint Pavement Marking Symbols, and Removal of Pavement Marking Lines* will be measured and paid in accordance with Section 1205-10.

*Law Enforcement* will be measured and paid in accordance with Section 1190-3.

*Portable Changeable Message Signs* will be measured and paid in accordance with Section 1120-4.

*Truck Mounted Attenuator* – TMA's will be measured and paid in accordance with Section 1165-4.

Digital Speed Limit Signs, Connected Lane Closures, Sequential Flashing Warning Lights, and Work Zone Presence Lighting are paid separately in accordance with their respective special provisions.

# TC-12

HI-0008

Johnston County

Payment will be made under:

<b>Pay Item</b>	<b>Pay Unit</b>
Work Zone Advance / General Warning Signing	SF
Single Lane Closure	EA
Ramp/Loop Closures	EA

STATIONARY ADVANCE WARNING SIGNS FOR INTERSTATE / FREEWAY RESURFACING PROJECTS

DIVIDED MEDIANS WITH WIDTHS 46' OR GREATER

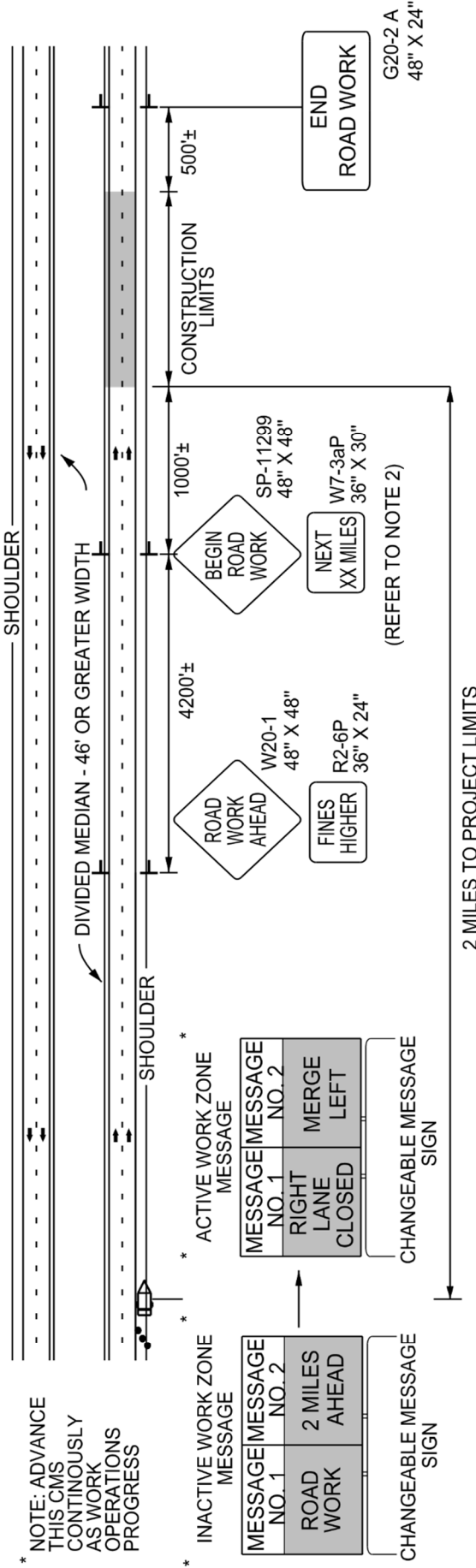

\* NOTE: ADVANCE THIS CMS CONTINUOUSLY AS WORK OPERATIONS PROGRESS

\* INACTIVE WORK ZONE MESSAGE

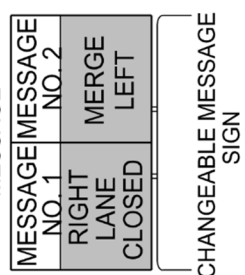
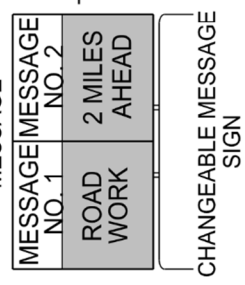

DIVIDED MEDIANS WITH WIDTHS LESS THAN 46' OR WITH PERMANENT MEDIAN BARRIER

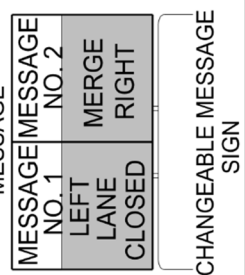
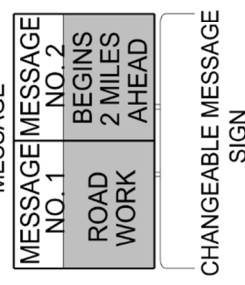
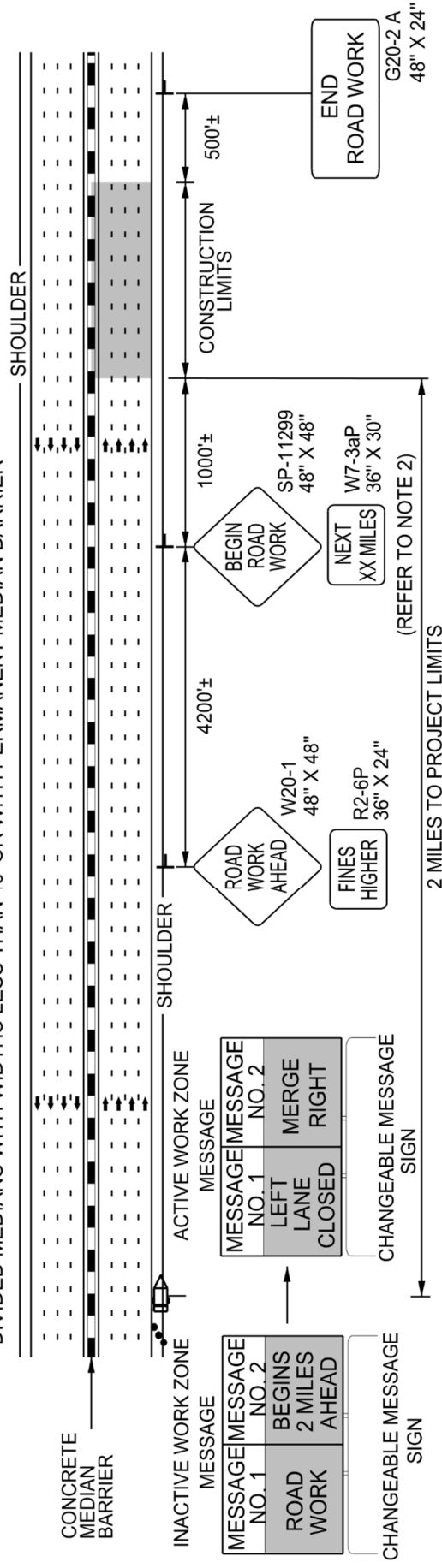

**LEGEND**

DIRECTION OF TRAFFIC FLOW  
 TRAFFIC DRUM  
 CHANGEABLE MESSAGE SIGN (CMS)  
 STATIONARY SIGN

**NOTES**

- THIS DRAWING IS TO BE USED IN CONJUNCTION WITH THE WORK ZONE VARIABLE SPEED LIMIT USING DIGITAL SPEED LIMIT SIGNS FOR INTERSTATE/FREEWAY RESURFACING PROJECTS DETAIL.
- FOR SIGN W7-3aP, ROUND TO THE NEAREST MILE.
- FOR ENTRANCE AND EXIT RAMP, REFER TO RSD 1101.01, SHEET 1, DETAIL B & C.
- FOR ADDITIONAL NOTES, REFER TO RSD 1101.01, SHEET 1.

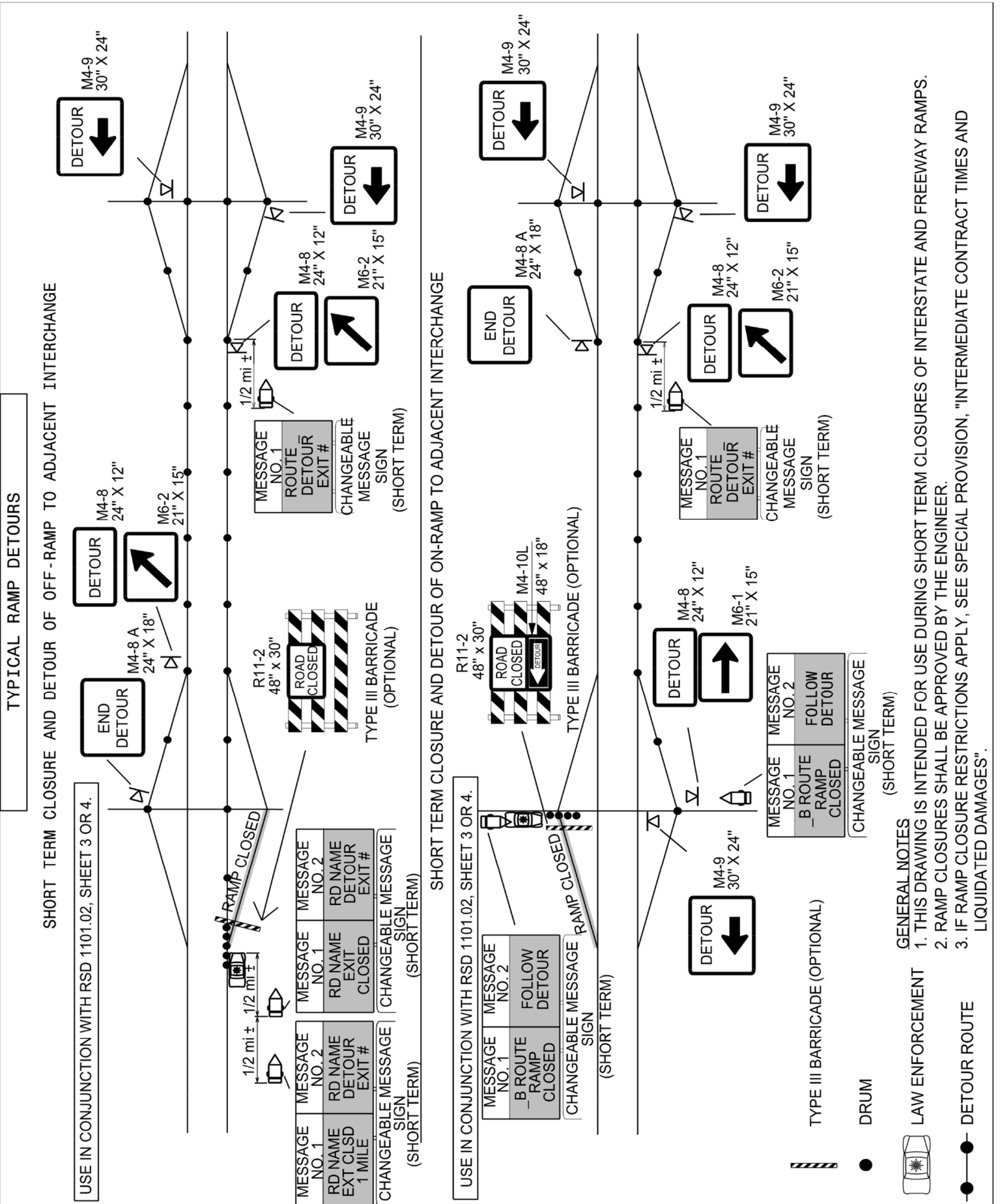

**TYPICAL RAMP DETOURS**

USE IN CONJUNCTION WITH RSD 1101.02, SHEET 3 OR 4.

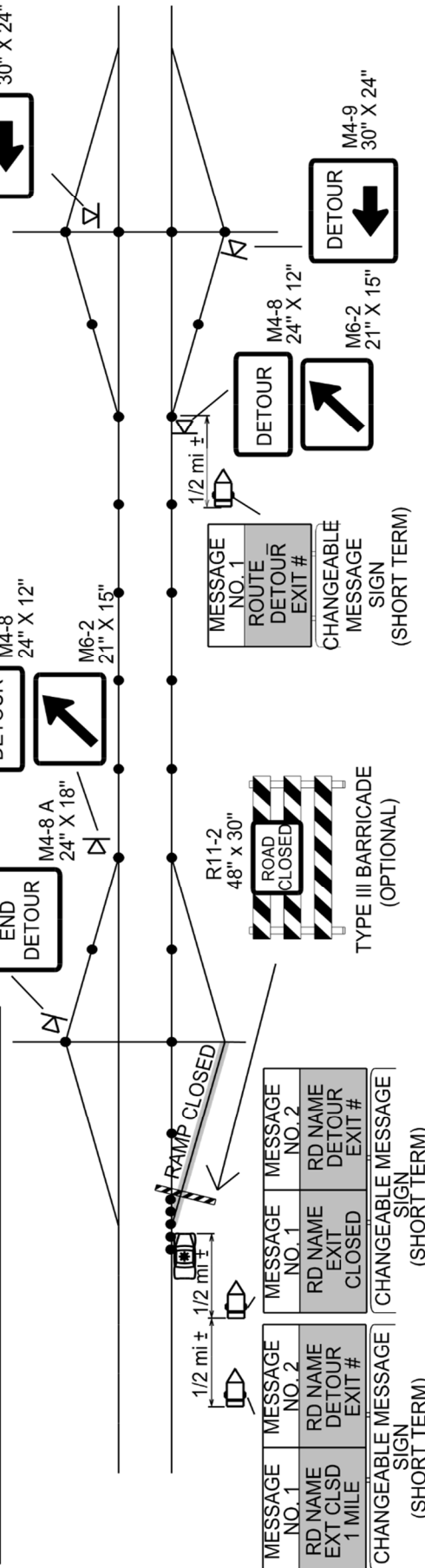

**SHORT TERM CLOSURE AND DETOUR OF ON-RAMP TO ADJACENT INTERCHANGE**

USE IN CONJUNCTION WITH RSD 1101.02, SHEET 3 OR 4.

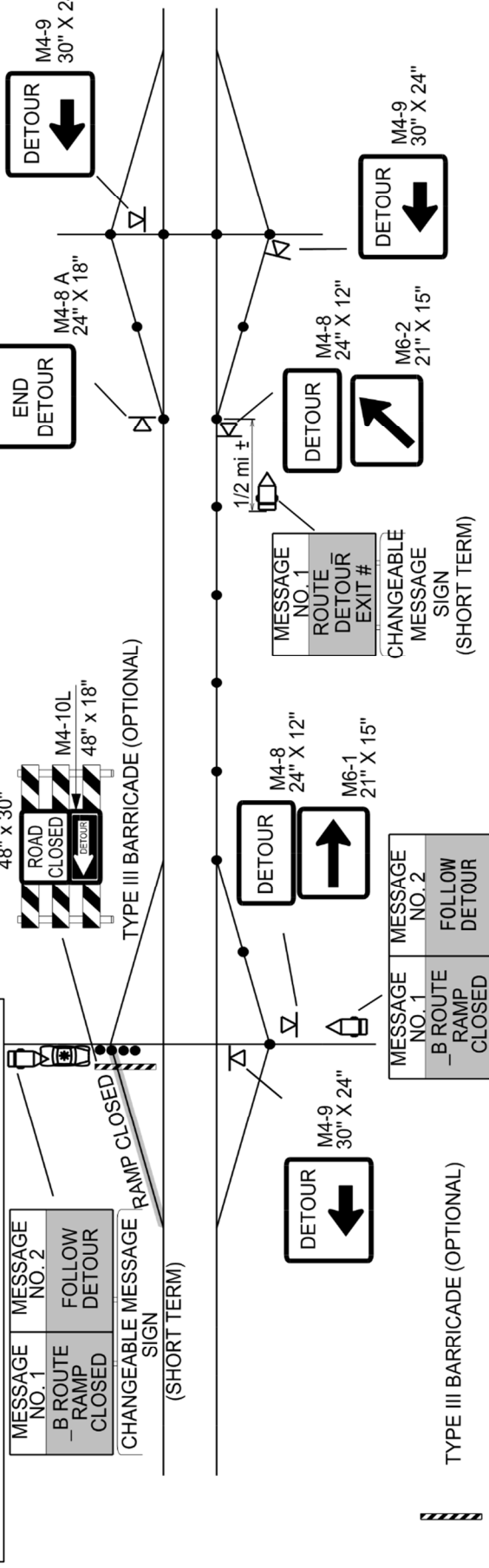

TYPE III BARRICADE (OPTIONAL)

DRUM



LAW ENFORCEMENT



DETOUR ROUTE

# TC-15

HI-0008

Johnston County

## **CONNECTED LANE CLOSURE DEVICES:**

(10/29/2018)

### **Description**

Furnish, install, operate, maintain, relocate, and remove connected lane closure devices for use on Interstate and Freeway lane closures. The connected lane closure devices shall transmit the location of the lane closure to navigational companies such as WAZE, Google Maps, Inrix, Here, TrafficCast, TomTom, Apple Maps, Panasonic, the Statewide Transportation Operations Center, (STOC), and any other navigational companies that requests it. A connected lane closure device shall be installed on the flashing arrow board identifying the beginning of a lane closure, and another connected lane closure device shall be installed on a crashworthy traffic control device (such as a drum) at the end of the same lane closure.

### **Materials**

The connected lane closure devices shall be designed and built to transmit the location of the lane closure to the navigational companies as well as the STOC. The format of the information received by each of these shall be approved by each entity, and at minimum, consist of an XML file. The connected lane closure devices shall be capable of obtaining wireless communication by either cellular or satellite technology.

The initial connected device shall be designed and attached to the flashing arrow board in such a manner that it is only activated when either the left or right arrows are displayed, not when the flashing arrow board is operated in caution mode. When the lane closure is removed, and the flashing arrow board turned off or changed to caution mode, the connected device shall automatically turn off simultaneously.

The second connected device in a lane closure shall be installed on a crashworthy traffic control device. It shall have an easily accessible power switch and a small status indicator light mounted such that it is visible when passing by in a vehicle at operating speed. When switched to the ON position, the light shall indicate that device has established communication and is transmitting. The light may be either steady burn or flashing and shall not exceed one (1) inch in diameter.

The devices shall have battery life sufficient to maintain operation for the duration of the lane closure, or have the ability to be recharged without deactivating the device.

### **Construction Methods**

Connected lane closure devices shall be used on all lane closures on freeways and interstates throughout the project.

Two connected lane closure devices shall be installed per grouping of lane closures (single); one attached and wired into the flashing arrow board at the beginning of the first taper, and the other at the last traffic control device at the end of the lane closure(s). Subsequent lane closures

# TC-16

HI-0008

Johnston County

occurring downstream of where all lanes have been reopened and lane closures in the opposite direction of travel will require additional connected devices.

The second connected lane closure device shall be manually turned ON and OFF by crews installing and removing the lane closure, unless the device can be controlled by the initial connected device. The unit shall be turned on immediately upon installation of the lane closure and turned off immediately upon removal of the lane closure.

Once installed, the Contractor shall verify that the connected lane closure devices are transmitting information prior to leaving the device unattended and re-verify transmission every 72 hours for long-term installations.

## **Technical Requirements**

The connected devices shall be run continuously during any active lane closures for the length of the contract.

The GPS within the connected devices shall have a horizontal accuracy of 50 feet, 95% of the time.

The connected device information, including the location, transmission status, and battery status shall be transmitted within five (5) minutes of initiation and updated every fifteen (15) minutes. In addition to transmitting information to the Department, the Contractor shall keep the retain device information for one (1) year after the contract ends. Information shall include timestamps, device name, and GPS location. This information shall be made available to the Department upon request.

The battery voltage shall be collected at least once an hour. The information shall be stored and available for troubleshooting. The system shall transmit an alert if the battery voltage of a device is under a specified threshold.

The connected devices shall emit an audible alert if a device is not transmitting its position for a period of 1 hour.

The outputs from the connected device on the arrow board and the downstream connected device at the end of the lane closure shall be easily identifiable as a single pair, either by sequential device IDs, identical project names, or other method as approved by the Engineer. Additional pairs on the project shall have unique identifiable information such that it is not confused with another project pair.

## **Measurement and Payment**

*Connected Lane Closure Devices* will be measured and paid as the maximum number of connected devices acceptably placed and in use at any one time during the life of the project. Each group of lane closures will require two (2) connected lane closure devices; one connected to the flashing arrow board and the other on a crashworthy device at the downstream end of the

# TC-17

HI-0008

Johnston County

lane closure. No payment will be made for either device unless both devices are satisfactorily installed.

The price for each connected lane closure device will cover all material, labor, maintenance, relocation, removal, and communication costs required for the duration of the project.

Flashing Arrow Boards will be measured and paid in accordance with Section 1115.

Crashworthy devices (such as drums) used to mount the downstream connected lane closure device shall be considered be incidental.

**Pay Item**

Connected Lane Closure Device

**Pay Unit**

Each

**WORK ZONE DIGITAL SPEED LIMIT SIGNS**

(5/10/2021)

**Description**

Furnish and install Work Zone Digital Speed Limit Signs on interstates and freeways with speed limits of 55 mph or greater. These signs are regulatory speed limit signs with LED displays for the speed limit numbers.

**Materials**

Digital Speed Limit Signs shall be a minimum 36" wide x 48" high. The speed limit sign (R2-1) shall be black on white with high intensity white prismatic sheeting.

The Digital Speed Limit Sign shall be mounted such that the bottom of the sign is 7' above roadway.

The LED panel shall be a minimum of 28" wide x 18" high. The display on the LED panel shall be amber or white.

The LED numbers shall have a minimum 5 wide by 7 high pixel array with a minimum height of 18".

The LED panel shall have auto brightness/dimming capability.

The black on orange "WORK ZONE" sign shall be mounted above the speed limit sign. It shall be 36" wide x 24" high with high intensity prismatic orange sheeting.

The black on white "\$250 FINE" sign shall be mounted below the speed limit sign. It shall be 36" wide x 24" high with high intensity prismatic white sheeting.



# TC-18

HI-0008

Johnston County

All digital speed limit systems shall have operational software and wireless communications that allows for remote operation and data monitoring. It shall be configured to allow access by the Engineer or their designee to change each sign independently or change the speed limit on all signs at once from a PC, tablet or cellular phone application.

Radar equipment to detect approaching speeds on the digital speed limit systems is optional. However, if the systems have radar, they will be equipped to store the detected speed data, this information should be available in a spreadsheet format and accessed remotely from a secure cloud location.

The Work Zone Digital Speed Limit systems shall have flashing beacons. The beacons are to be a minimum of 8" diameter LED circular yellow. They shall be mounted above and below the sign assemblies and are to be centered. The beacons shall alternately flash at rates not less than 50 or more than 60 times per minute.

In addition, the flashing beacons shall be mounted in such a manner that the \$250 FINE sign is not obscured when in operation.

Digital Speed Limit Signs may be trailer mounted or stationary mounted. The unit shall be solar powered and have the ability to operate continuously. It shall be supplemented with a battery backup system which includes a 110/120 VAC powered on-board charging system.

The batteries, when fully charged, shall be capable of powering the display for 20 continuous days with no solar power. The unit shall be capable of being powered by standard 110/120 VAC power source.

Store the battery bank and charging system in a lockable, weather and vandal resistant box.

All Work Zone Digital Speed Limit Sign equipment shall be on the NCDOT Approved Products List.

## **Digital Speed Limit Displays**

The speed limit shall be continuously displayed on the signs. All other stationary speed limit signs shall be covered when Digital Speed Limit systems are in operation.

## ***Reduced Speed Limit Displays***

The Digital Speed Limit systems shall have beacons activated when the work zone speed limit is reduced. Otherwise, the beacons are to remain off.

IF THE DIGITAL SPEED LIMIT SYSTEM IS EQUIPPED WITH RADAR: The Digital Speed Limit Signs shall display the reduced work zone speed limit without flashing the LED speed limit number unless approaching speeds are detected to be 6 MPH or higher than the displayed speed limit. If speeds are detected 6 MPH or above the displayed Speed Limit, then the LED shall flash the speed limit until the speeds are within the 6 MPH tolerance.

# TC-19

HI-0008

Johnston County

## *Existing Speed Limit Displays*

When the existing speed limit is displayed on the Digital Speed Limit Signs, the beacons are to remain off.

IF THE DIGITAL SPEED LIMIT SYSTEM IS EQUIPPED WITH RADAR: The speed limit number is not to flash unless the approaching speeds are detected to be 6 MPH or higher than the displayed speed limit.

## **Other Construction Methods**

The speed limits are the sole authority of the NCDOT. An ordinance by the State Traffic Engineer is required for all speed limits in order to have a lawfully enforceable speed limit.

The Regional Traffic Engineering Office and the Division Construction Engineer in coordination with the Work Zone Traffic Control Section will provide all work zone speed limit recommendations based on activities and conditions.

The Contractor will be responsible for coordinating with the Engineer when the work zone speed limits are to be changed and will have to seek approval by the Engineer or their designee before the speed limit is changed.

Whenever possible, each trailer mounted unit shall be placed on the paved shoulder and shall have the capability of being leveled.

## **Measurement and Payment**

*Work Zone Digital Speed Limit Signs* will be measured and paid as the maximum number of Work Zone Digital Speed Limit Signs satisfactorily installed according to the attached detail and properly functioning at any one time during the life of the project.

This includes all materials and labor to install, maintain and remove all the Work Zone Digital Speed Limit Signs.

### **Pay Item**

Work Zone Digital Speed Limit Signs

### **Pay Unit**

Each

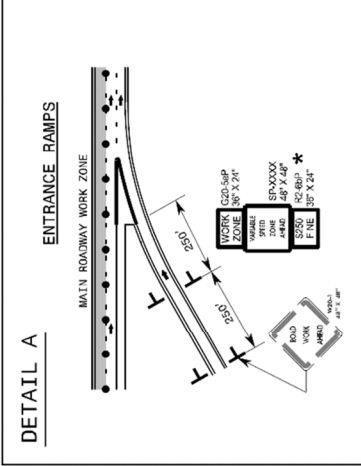
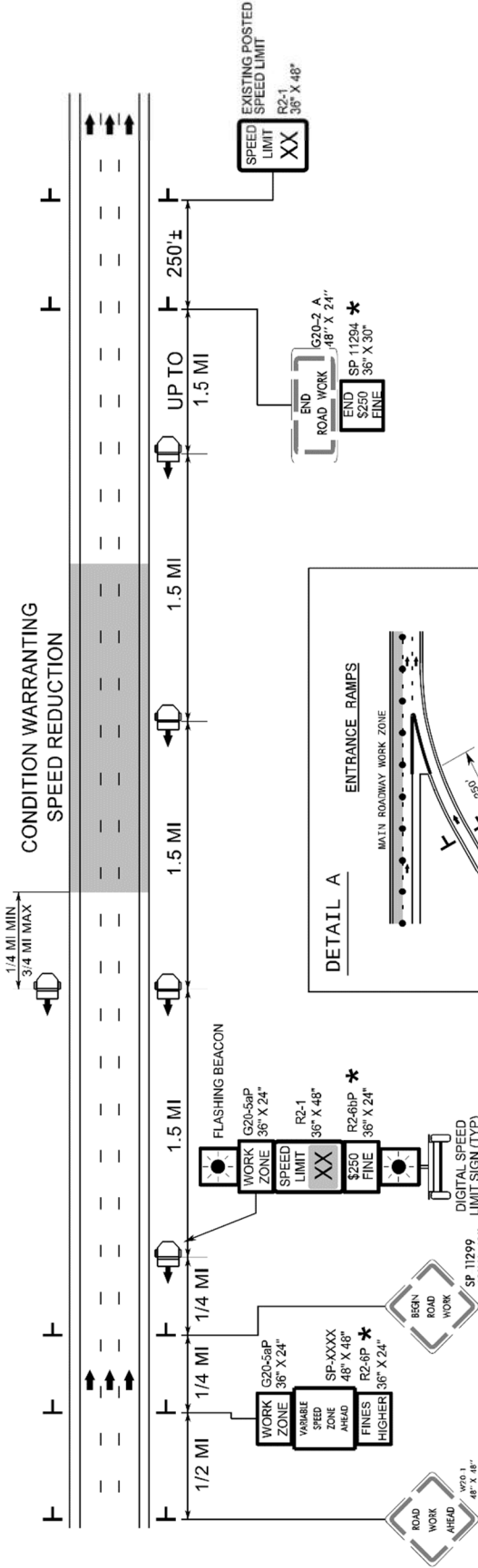

\* USE ONLY IF ORDINANCED. SEE NOTE 5 BELOW.

NOTES

1. THE DIGITAL SPEED LIMITS SIGNS WILL BE INSTALLED (TRAILER MOUNTED OR STATIONARY MOUNTED) IN ADVANCE OF AND SPACED APPROXIMATELY 1.5 MILES THROUGHOUT THE PROJECT LIMITS, UNLESS DIRECTED OTHERWISE.
2. WITHIN 1/4 TO 3/4 MILE UPSTREAM OF CONDITION WARRANTING A SPEED REDUCTION, PLACE A DIGITAL SPEED LIMIT SIGN ON BOTH THE INSIDE AND OUTSIDE SHOULDERS, UNLESS DIRECTED OTHERWISE BY THE ENGINEER. AT ALL OTHER LOCATIONS DOWNSTREAM, PLACE A SINGLE DIGITAL SPEED LIMIT SIGN ON THE OUTSIDE SHOULDER.  
IF SIGNS ARE NOT HIGHLY VISIBLE TO ALL MOTORISTS, SUPPLEMENTAL DIGITAL SPEED LIMIT SIGNS ARE PERMITTED ON THE MEDIAN SHOULDER.
3. THE DIGITAL SPEED LIMIT SIGNS TAKE PRECEDENCE OVER EXISTING SPEED LIMIT SIGNS AND SHOULD REMAIN UPRIGHT AND VISIBLE AT ALL TIMES. ALL EXISTING SPEED LIMIT SIGNS SHALL BE COVERED OR REMOVED FOR DURATION OF THE PROJECT.
4. NCDOT HAS SOLE AUTHORITY OF THE SPEED LIMITS DISPLAYED ON THE DIGITAL SPEED LIMIT SIGNS.
5. THE WORK ZONE VARIABLE SPEED LIMIT AND THE \$250 SPEEDING PENALTY ARE SEPARATE ORDINANCES THAT MUST BE SIGNED BY THE STATE TRAFFIC ENGINEER TO BE VALID AND ENFORCEABLE. WITHOUT SIGNED ORDINANCES, THE SPEED LIMIT ON A FACILITY SHALL REMAIN UNCHANGED AND/OR HIGHER FINES SIGNS SHALL NOT BE USED.
6. THE REDUCED SPEED SHALL BE DISPLAYED A MINIMUM OF 1/4 MILE AND A MAXIMUM OF 3/4 MILE IN ADVANCE OF AND THROUGHOUT THE AREA MEETING CONDITIONS LISTED IN THE CHART. THE EXISTING SPEED LIMIT SHALL BE DISPLAYED ON ALL OTHER DIGITAL SPEED LIMIT SIGNS.
7. THE SPEED DISPLAYED SHALL BE THE LOWER OF THE EXISTING SPEED LIMIT OR THE SPEED IN THE WORK ZONE CONDITION CHART.
8. THE BEACONS ON THE DIGITAL SPEED LIMIT SIGNS SHALL ONLY FLASH DURING TIMES THE SPEED IS REDUCED, AND REMAIN OFF AT ALL OTHER TIMES.

WORK ZONE CONDITIONS	SPEED TO DISPLAY (SEE NOTE 6 & 7)
2 LANES REDUCED TO 1 LANE	55
3 LANES REDUCED TO 1 LANE	55
3 LANES REDUCED TO 2 LANES	60
4 LANES REDUCED TO 1 LANE	55
4 LANES REDUCED TO 2 LANES	60
4 LANES REDUCED TO 3 LANES	65
1 OPEN LANE WITH CONTINUOUS BARRIER ON BOTH SHOULDERS	55
1 OPEN LANE WITH CONTINUOUS BARRIER ON 1 SHOULDER	60
3 OR 2 OPEN LANES WITH CONTINUOUS BARRIER ON BOTH SHOULDERS	60
3 OR 2 OPEN LANES WITH CONTINUOUS BARRIER ON 1 SHOULDER	65
4 OPEN LANES WITH BARRIER CONTINUOUS ON BOTH SHOULDERS	65
4 OPEN LANES WITH BARRIER CONTINUOUS ON 1 SHOULDER	EXISTING
UNEVEN LANES	60

LANE CLOSURES

CONTINUOUS BARRIER (LENGTH OF BARRIER GREATER THAN 1 MILE)



# TC-22

HI-0008

Johnston County

## **WORK ZONE PRESENCE LIGHTING**

(10/14/19) (Rev. 5/10/2021)

### **Description**

Furnish and install Work Zone Presence Lighting during nightly lane closures on multilane roadways with speed limits of 55 mph or greater.

### **Materials**

Anti-glare lighting systems are required. Work Zone Presence Lighting shall be installed in accordance with the attached detail and the Manufacturer's recommendations.

Supply a power source for each light to provide the light output as described in the chart below.

Each light unit shall be capable of providing a minimum of 14,000 lumens illuminating a minimum area of approximately 3,000 square feet. The light shall be capable of being elevated to a height of 14 feet above the pavement.

Each light unit support base or mounting stand shall have the capability of being leveled such that the light mast is plumb.

Provide Work Zone Presence Lighting listed on the NCDOT Approved Products List.

### **Construction Methods**

Work Zone Presence Lighting is permitted to be prestaged (up to 1 hour prior for single lane closures) along with other traffic control devices or installed within 1 hour after the necessary traffic control has been installed for the lane closure(s). At the end of the work night, the Work Zone Presence Lighting shall be removed within 1 hour before or after the lane closure(s) is removed.

Whenever possible, each light unit shall be placed on the outside paved shoulder, a minimum of 4 feet from the travel lane and spaced according to the chart below based on the amount of light output for each unit.

Work Zone Presence Lighting is permitted to supplement the Portable Construction Lighting inside the lane closure. At no time shall Work Zone Presence Lighting be used in lieu of Portable Construction Lighting when required.

If there is sufficient existing overhead lighting, Work Zone Presence Lighting may be eliminated as directed by the Engineer.

### **Lighting Unit Installation Requirements**

**TC-23**

HI-0008

Johnston County

The lighting units shall be installed in advance of the lane closure as shown on the attached detail and spaced according to the chart below:

Light Output (Lumens)	Illuminated Fixture Area (Sq. Ft.)	AREA 1		AREA 2	
		# of Lights	Spacing*	# of Lights	Spacing*
14,000 - 35,000	4	6	640' (16 skips)	8	480' (12 skips)
35,001 - 59,999	5	5	800' (20 skips)	6	640' (16 skips)
60,000+	6+	4	1,000' (25 skips)	5	800' (20 skips)

\*Skips refer to traditional 10' pavement marking lines with 30' gaps.

Area 1: Begins 2,640' downstream from CMS; Extends to just past 1<sup>st</sup> Lane Closure Sign

Area 2: Begins just past the 1<sup>st</sup> Lane Closure Sign; Extends to just past the last Lane Closure Sign

**MEASUREMENT AND PAYMENT**

*Work Zone Presence Lighting* will be measured and paid as the maximum number of lighting units satisfactorily placed, accepted by the Engineer, and in use at any one time during the life of the project.

Relocation, replacement, repair, removal, and maintenance of Work Zone Presence Lighting units will be incidental to the work of this section. No measurement or separate payment will be made for power generators, batteries, or other power supply devices.

**Pay Item**

Work Zone Presence Lighting

**Pay Unit**

Each

# TC-24

HI-0008

Johnston County

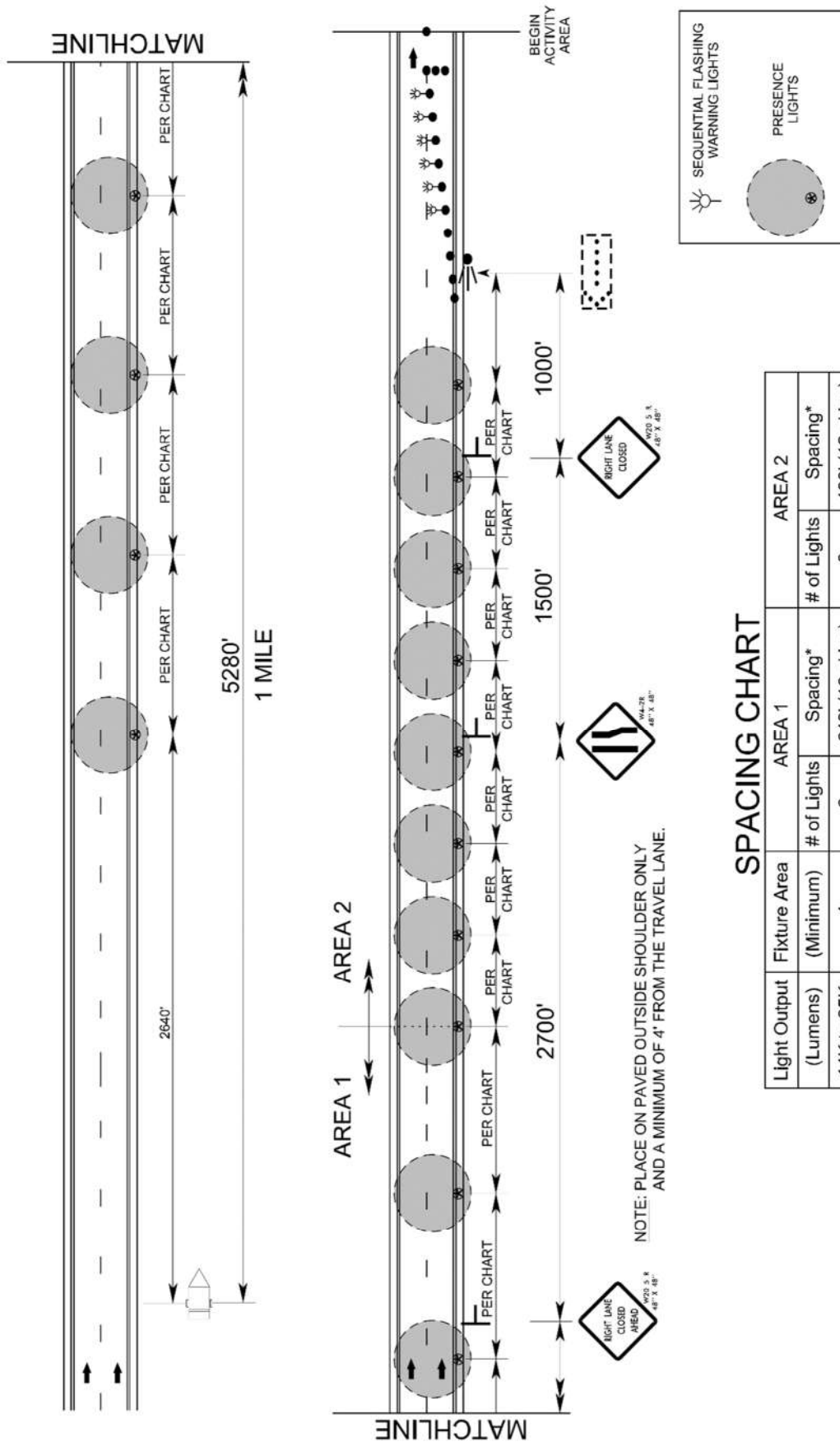

## SPACING CHART

Light Output (Lumens)	AREA 1		AREA 2	
	Fixture Area (Minimum)	# of Lights	Spacing*	# of Lights
14K to 35K	4	6	640' (16 skips)	8
35.1K to 60K	5	5	800' (20 skips)	6
60K +	6+	4	1000' (25 skips)	5

\*SKIPS REFER TO TRADITIONAL 10' PAVEMENT MARKING LINES WITH 30' GAPS.

AREA 1: BEGINS 2,640' DOWNSTREAM FROM CMS; EXTENDS TO JUST PAST 1ST LANE CLOSURE SIGN

AREA 2: BEGINS JUST PAST THE 1ST LANE CLOSURE SIGN; EXTENDS TO JUST PAST THE LAST LANE CLOSURE SIGN

NOTE: PLACE ON PAVED OUTSIDE SHOULDER ONLY AND A MINIMUM OF 4' FROM THE TRAVEL LANE.



# TC-25

HI-0008

Johnston County

## **SEQUENTIAL FLASHING WARNING LIGHTS**

(10/08/2016) (Rev. 5/10/2021)

### **Description**

Furnish and install Sequential Flashing Warning Lights on drums used for the merging tapers of nightly lane closures on all multilane roadways with speed limits of 55 mph or greater.

### **Materials**

The Sequential Flashing Warning Lights shall meet all of the requirements for warning lights within the current edition of the Manual of Uniform Traffic Control Devices (MUTCD).

Each light unit shall be capable of operating fully and continuously for a minimum of 200 hours when equipped with a standard battery set.

Each light in the sequence shall be flashed at a rate of not less than 55 times per minute and not more than 75 times per minute. The flash rate and flash duration shall be consistent throughout the sequence.

Supply a Type 3 Certification (Independent Test Lab results) documenting all actual test results for the specified parameters contained in the Institute of Transportation Engineer's (ITE's) *Purchase Specification for Flashing and Steady Burn Warning Lights*. The laboratory shall also identify all manufacturer codes and part numbers for the incandescent lamp or LED clusters, lenses, battery, and circuitry, and the total width of the light with the battery in place. The complete assembly shall be certified as crashworthy when firmly affixed to the channelizing device.

All Sequential Flashing Warning Lights shall be on the NCDOT Approved Products List.

### **Construction Methods**

These lights shall flash sequentially beginning with the first light and continuing until the final light.

The Sequential Flashing Warning Lights shall automatically flash in sequence when placed on the drums that form the merging taper.

The number of lights used in the drum taper shall equal the number of drums used in the taper.

Drums are the only channelizing device allowed to mount sequential flashing warning lights.

The Sequential Flashing Warning Lights shall be weather independent and visual obstructions shall not interfere with the operation of the lights.



# TC-26

HI-0008

Johnston County

The Sequential Flashing Warning Lights shall automatically sequence when placed in line in an open area with a distance between lights of 10 to 100 feet. A 10-foot stagger in the line of lights shall have no adverse effect on the operation of the lights.

If one light fails, the flashing sequence shall continue. If more than 1 light fails, all of the lights are to be automatically turned to the “off” mode. Non-sequential flashing is prohibited.

When lane closures are not in effect, the Sequential Flashing Warning Lights shall be deactivated.

## Measurement and Payment

Sequential Flashing Warning Lights will be measured and paid as the maximum number of sequential flashing warning lights satisfactorily installed and properly functioning at any one time during the life of the project.

This includes all materials and labor to install, maintain and remove all the Sequential Flashing Warning Lights.

### Pay Item

Sequential Flashing Warning Lights

### Pay Unit

Each

**STABILIZATION REQUIREMENTS:**

(3-11-16)

S-2A

Stabilization for this project shall comply with the time frame guidelines as specified by the NCG-010000 general construction permit effective April 1, 2019 issued by the North Carolina Department of Environmental Quality Division of Water Resources. Temporary or permanent ground cover stabilization shall occur within 7 calendar days from the last land-disturbing activity, with the following exceptions in which temporary or permanent ground cover shall be provided in 14 calendar days from the last land-disturbing activity:

- Slopes between 2:1 and 3:1, with a slope length of 10 ft. or less
- Slopes 3:1 or flatter, with a slope of length of 50 ft. or less
- Slopes 4:1 or flatter

The stabilization timeframe for High Quality Water (HQW) Zones shall be 7 calendar days with no exceptions for slope grades or lengths. High Quality Water Zones (HQW) Zones are defined by North Carolina Administrative Code 15A NCAC 04A.0105 (25). Temporary and permanent ground cover stabilization shall be achieved in accordance with the provisions in this contract and as directed.

**SEEDING AND MULCHING:**

**(East Crimp)**

The kinds of seed and fertilizer, and the rates of application of seed, fertilizer, and limestone, shall be as stated below. During periods of overlapping dates, the kind of seed to be used shall be determined. All rates are in pounds per acre.

All Roadway Areas

<b>March 1 - August 31</b>		<b>September 1 - February 28</b>	
50#	Tall Fescue	50#	Tall Fescue
10#	Centipede	10#	Centipede
25#	Bermudagrass (hulled)	35#	Bermudagrass (unhulled)
500#	Fertilizer	500#	Fertilizer
4000#	Limestone	4000#	Limestone
10#	Millet	25#	Choose ONE of the Following Rye Grain, Wheat FFR 555, or Roane Wheat

Waste and Borrow Locations

<b>March 1 – August 31</b>		<b>September 1 - February 28</b>	
75#	Tall Fescue	75#	Tall Fescue
25#	Bermudagrass (hulled)	35#	Bermudagrass (unhulled)
500#	Fertilizer	500#	Fertilizer
4000#	Limestone	4000#	Limestone

Note: 50# of Bahiagrass may be substituted for either Centipede or Bermudagrass only upon Engineer’s request.

## Approved Tall Fescue Cultivars

06 Dust	Escalade	Justice	Scorpion
2 <sup>nd</sup> Millennium	Essential	Kalahari	Serengeti
3 <sup>rd</sup> Millennium	Evergreen 2		Shelby
Apache III	Falcon IV	Kitty Hawk 2000	Sheridan
Avenger	Falcon NG	Legitimate	Signia
Barlexas	Falcon V	Lexington	Silver Hawk
Barlexas II	Faith	LSD	Sliverstar
Bar Fa	Fat Cat	Magellan	Shenandoah Elite
Barrera	Festnova	Matador	Sidewinder
Barrington	Fidelity	Millennium SRP	Skyline
Barrobusto	Finelawn Elite	Monet	Solara
Barvado	Finelawn Xpress	Mustang 4	Southern Choice II
Biltmore	Finesse II	Ninja 2	Speedway
Bingo	Firebird	Ol' Glory	Spyder LS
Bizem	Firecracker LS	Olympic Gold	Sunset Gold
Blackwatch	Firenza	Padre	Taccoa
Blade Runner II	Five Point	Patagonia	Tanzania
Bonsai	Focus	Pedigree	Trio
Braveheart	Forte	Picasso	Tahoe II
Bravo	Garrison	Piedmont	Talladega
Bullseye	Gazelle II	Plantation	Tarheel
Cannavaro	Gold Medallion	Proseeds 5301	Terrano
Catalyst	Grande 3	Prospect	Titan ltd
Cayenne	Greenbrooks	Pure Gold	Titanium LS
Cessane Rz	Greenkeeper	Quest	Tracer
Chipper	Gremlin	Raptor II	Traverse SRP
Cochise IV	Greystone	Rebel Exeda	Tulsa Time
Constitution	Guardian 21	Rebel Sentry	Turbo
Corgi	Guardian 41	Rebel IV	Turbo RZ
Corona	Hemi	Regiment II	Tuxedo RZ
Coyote	Honky Tonk	Regenerate	Ultimate
Darlington	Hot Rod	Rendition	Venture
Davinci	Hunter	Rhambler 2 SRP	Umbrella
Desire	Inferno	Rembrandt	Van Gogh
Dominion	Innovator	Reunion	Watchdog
Dynamic	Integrity	Riverside	Wolfpack II
Dynasty	Jaguar 3	RNP	Xtremegreen
Endeavor	Jamboree	Rocket	

On cut and fill slopes 2:1 or steeper Centipede shall be applied at the rate of 5 pounds per acre and add 20# of Sericea Lespedeza from January 1 - December 31.

Fertilizer shall be 10-20-20 analysis. A different analysis of fertilizer may be used provided the 1-2-2 ratio is maintained and the rate of application adjusted to provide the same amount of plant food as a 10-20-20 analysis and as directed.

All areas seeded and mulched shall be tacked with asphalt. Crimping of straw in lieu of asphalt tack shall not be allowed on this project.

**CRIMPING STRAW MULCH:**

Crimping shall be required on this project adjacent to any section of roadway where traffic is to be maintained or allowed during construction. In areas within six feet of the edge of pavement, straw is to be applied and then crimped. After the crimping operation is complete, an additional application of straw shall be applied and immediately tacked with a sufficient amount of undiluted emulsified asphalt.

Straw mulch shall be of sufficient length and quality to withstand the crimping operation.

Crimping equipment including power source shall be subject to the approval of the Engineer providing that maximum spacing of crimper blades shall not exceed 8".

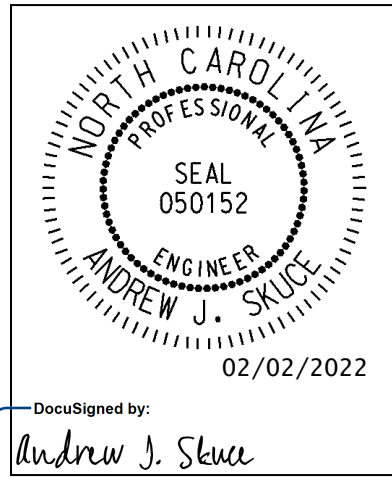

**HI-0008**  
**Intelligent Transportation Systems**  
**DMS Replacement**

**Project Special Provisions**

**DOCUMENT NOT CONSIDERED FINAL  
 UNLESS ALL SIGNATURES COMPLETED**

**Contents**

**1. GENERAL REQUIREMENTS..... 4**

1.1. DESCRIPTION..... 4

    A. *General*..... 4

    B. *Scope* ..... 4

    C. *Qualified Products* ..... 4

**2. REMOVAL AND DISPOSAL OF DMS COMPONENTS..... 4**

2.1. DESCRIPTION..... 4

2.2. CONSTRUCTION METHODS..... 5

2.3. MEASUREMENT AND PAYMENT..... 5

**3. MODIFY ELECTRICAL SERVICE..... 5**

3.1. DESCRIPTION..... 5

3.2. MATERIAL..... 6

3.3. CONSTRUCTION METHODS ..... 6

3.4. MEASUREMENT AND PAYMENT ..... 6

**4. DYNAMIC MESSAGE SIGN (DMS)..... 7**

4.1. DESCRIPTION..... 7

4.2. MATERIALS ..... 8

    A. *Environmental Requirements* ..... 8

    B. *Viewing Requirements for all DMS*..... 8

    C. *Housing Requirements for all DMS* ..... 8

    D. *Housing Requirements for Walk-in type DMS* ..... 9

    E. *Housing Requirements for Front Access DMS*..... 9

    F. *Housing Face Requirements for all DMS* ..... 9

    G. *Housing Face Requirements for Walk-in type DMS* ..... 10

H. Housing Face Requirements for Front Access type DMS..... 10

I. Housing Face Requirements for Embedded Front Access type DMS..... 10

J. Sign Housing Ventilation System for all DMS ..... 10

K. Sign Housing Ventilation System for Walk-in DMS..... 11

L. Sign Housing Photoelectric sensors..... 11

M. Display Modules..... 11

N. Discrete LEDs ..... 12

O. LED Power Supplies ..... 12

P. LED Pixels..... 13

Q. DMS Mini Controller ..... 13

R. DMS Enclosure Structure Mounting ..... 13

S. DMS / DMS Controller Interconnect ..... 14

T. DMS Controller and DMS Cabinet ..... 14

U. Equipment List..... 20

V. Physical Description ..... 20

W. Parts List ..... 20

X. Character Set Submittal ..... 21

Y. Wiring Diagrams..... 21

Z. Routine of Operation..... 21

AA. Maintenance Procedures..... 21

BB. Repair Procedures..... 21

CC. Warranty..... 21

4.3. CONSTRUCTION METHODS..... 22

    A. Description..... 22

    B. Layout..... 22

    C. Construction Submittal..... 22

    D. Conduit..... 22

    E. Wiring Methods (Power)..... 23

    F. Equipment and Cabinet Mounting ..... 23

    G. Work Site Clean-Up..... 23

4.4. GENERAL TEST PROCEDURE ..... 23

4.5. COMPATIBILITY TESTS ..... 24

    A. DMS System..... 24

4.6. OPERATIONAL FIELD TEST (ON-SITE COMMISSIONING)..... 25

    A. DMS System..... 25

4.7. MEASUREMENT AND PAYMENT ..... 26

**5. NTCIP REQUIREMENTS ..... 26**

5.1. REFERENCES ..... 26

    A. Standards..... 26

    B. Features..... 27

    C. Objects..... 28

    D. MULTI Tags..... 30

    E. Documentation ..... 31

    F. NTCIP Acceptance Testing ..... 31

5.2. MEASUREMENT AND PAYMENT..... 31

**6. DMS PEDESTAL STRUCTURE..... 32**

6.1. DESCRIPTION..... 32

6.2. MATERIALS..... 32

6.3. CONSTRUCTION METHODS..... 32

    A. *General*..... 32

    B. *DMS Maintenance Platform (Walkway)* ..... 33

    C. *DMS Access Ladder* ..... 33

6.4. MEASUREMENT AND PAYMENT..... 33

**7. OBSERVATION PERIOD ..... 34**

    7.1. 30-DAY OBSERVATION PERIOD ..... 34

    7.2. FINAL ACCEPTANCE..... 35

    7.3. MEASUREMENT AND PAYMENT..... 35

**8. DOCUMENTS AND SUBMITTALS..... 35**

    8.1. GENERAL ..... 35

    8.2. DRAWINGS AND DOCUMENTS’ CERTIFICATION..... 36

    8.3. MECHANICAL..... 36

    8.4. ELECTRICAL..... 36

    8.5. ELECTRONICS..... 36

    8.6. BLOCK DIAGRAMS ..... 36

    8.7. LEDs ..... 37

    8.8. BENCH REPAIR DOCUMENTATION:..... 37

    8.9. PROPRIETARY PARTS..... 37

    8.10. USE BY NCDOT AND PROTECTION OF MANUFACTURER’S PROPRIETARY INFORMATION ..... 37

    8.11. MEASUREMENT AND PAYMENT..... 38

## 1. GENERAL REQUIREMENTS

### 1.1. DESCRIPTION

#### A. General

Conform to these Project Special Provisions, Project Plans, and the *2018 Standard Specifications for Roads and Structures* (also referred to hereinafter as the “Standard Specifications”). The current edition of these specifications and publications in effect on the date of advertisement will apply.

In the event of a conflict between these Project Special Provisions and the Standard Specifications, these Project Special Provisions govern.

#### B. Scope

The scope of this project includes removal and replacement of an existing Dynamic Message Sign (DMS) at the following location:

1. DMS(04-9005), I-95 SB, near mile marker 101, remove and dispose of the existing DMS, overhead sign structure and foundations. Install new DMS on new pedestal structure, and new based mounted equipment cabinet on the existing foundation. Modify existing electrical service to add new 50A double pole circuit breaker and new lightning arrester to disconnect.

Return existing cell modem and antenna to Division 4 Incident Management Engineer (252-640-6400).

#### C. Qualified Products

Furnish new equipment, materials, and hardware unless otherwise required. Inscribe manufacturer’s name, model number, serial number, and any additional information needed for proper identification on each piece of equipment housed in a case or housing.

Furnish factory assembled cables without adapters, unless otherwise approved by the Engineer, for all cables required to interconnect any field or central equipment.

Certain equipment listed in these Project Special Provisions must be pre-approved on the Department’s ITS & Signals Qualified Products List (QPL) by the date of installation. Equipment, material, and hardware not pre-approved when required will not be allowed for use on the project.

The QPL is available on the Department’s website. The QPL website is:

<https://connect.ncdot.gov/resources/safety/pages/its-and-signals-qualified-products.aspx>

## 2. REMOVAL AND DISPOSAL OF DMS COMPONENTS

### 2.1. DESCRIPTION

Remove and dispose of one (1) existing DMS, one (1) existing DMS structure, and two (2) DMS structure foundations as shown in the Plans.



Perform the work required by this section in accordance with Section 907 of the Standard Specifications.

**2.2. CONSTRUCTION METHODS**

1. MM 101, south of Exit 101 on I-95:

- Remove and dispose of the existing DMS and the existing overhead sign structure.
- Remove and dispose of two (2) existing sign structure foundations.
- Replace the existing base mounted cabinet on the existing concrete foundation including a new 12” base extender. Cabinet replacement includes reuse of the existing interconnect center and re-splicing of existing fiber.
- Contractor shall deliver existing cell modem and antenna to Division 4 Incident Management Engineer (252-640-6400).

Ensure all abandoned conduits are removed to 24-inches below finished grade. Comply with Section 907-2(C) of the Standard Specifications.

**2.3. MEASUREMENT AND PAYMENT**

*Removal and Disposal of Existing DMS Components* will be measured and paid as the actual number of DMS removed and disposed of. Disposal of existing equipment cabinet will be considered incidental to disposal of existing DMS components.

*Removal and Disposal of Existing DMS Structure* will be measured and paid as the actual number of DMS structures removed and disposed of.

*Removal and Disposal of Existing DMS Structure Foundation* will be measured and paid as the actual number of DMS structure foundations removed and disposed of.

Replacement of existing base mounted cabinet and installation of a 12” base extender will be incidental to the installation of the new DMS cabinet. Relocation of the existing Ethernet edge switch, interconnect center and fiber splicing will be incidental to the cabinet replacement.

Payment will be made under:

**Pay Item**

Removal and Disposal of Existing DMS Components.....	Each
Removal and Disposal of Existing DMS Structure .....	Each
Removal and Disposal of Existing DMS Structure Foundation .....	Each

**3. MODIFY ELECTRICAL SERVICE**

**3.1. DESCRIPTION**

Modify existing electrical service equipment as shown in the Plans. Comply with the National Electrical Code (NEC), the National Electrical Safety Code (NESC), the Standard Specifications, the

Project Special Provisions, and all local ordinances. All work involving electrical service shall be coordinated with the appropriate utility company and the Engineer.

**3.2. MATERIAL**

At locations shown in the Plans, furnish and install a new 50A double pole breaker.

At the main service disconnect, furnish and install UL-approved lightning arrestors that meet the following requirements:

Type of design	Silicon Oxide Varistor
Voltage	120/240 Single Phase, 3 wire
Maximum current	100,000 amps
Maximum energy	3000 joules per pole
Maximum number of surges	Unlimited
Response time one milliamp test	5 nanoseconds
Response time to clamp 10,000 amps	10 nanoseconds
Response time to clamp 50,000 amps	25 nanoseconds
Leak current at double the rated voltage	None
Ground wire	Separate

**3.3. CONSTRUCTION METHODS**

At location shown in the Plans, remove the existing 50A double pole breaker and install a new 50A double pole breaker.

At the main service disconnect, install a UL-approved lightning arrestor.

**3.4. MEASUREMENT AND PAYMENT**

*Modify existing electrical service* will be measured and paid as the actual number of complete and functional modified existing electrical services furnished, installed and accepted. Removal of existing breakers, installation of new breakers, and installation of a new lightning arrestor as described above shall constitute a modified electrical service.

Modify Existing Electrical Service .....Each

4. DYNAMIC MESSAGE SIGN (DMS)

4.1. DESCRIPTION

To ensure compatibility with the existing DMS Control Software deployed in the State, furnish NTCIP compliant DMSs that are fully compatible with Daktronics, Inc. Vanguard V4 or latest version software (also referred to hereinafter as the “Control Software”). Contact the engineer to inquire about the current version being used.

Furnish and install DMSs compliant with UL standards 48, 50 and 879.

Add and configure the new DMSs in the system using the Control Software and computer system. Furnish, install, test, integrate and make fully operational the new DMSs at locations shown in the Project Plans.

Furnish operating Dynamic Message Signs, not limited to, the following types. Dimensions represent DMS sizes commonly used by the Department, other size DMS may be specified in the project plans.

DMS Naming Convention	
Type	Color
Type 1 – Front Access	A – Amber – 66mm
Type 2 – Walk-in	C – Full Color – 20mm
Type 3 – Embedded	
Type 4 – Lane Control	

- **DMS Type 1A** – Front Access Amber 66mm – 27 pixels high by 60 pixels wide
  - 3 lines, 10 characters per line, using 18” high characters.
- **DMS Type 1C** – Front Access Full Color 20mm – 96 pixels high by 208 pixels wide
  - 3 lines, 11 characters per line, using 18” high characters.
- **DMS Type 2A** – Walk-in Amber 66mm – 27 pixels high by 90 pixels wide
  - 3 lines, 15 characters per line, using 18” high characters.
- **DMS Type 2C** – Walk-in Full Color 20mm – 96 pixels high by 288 pixels wide
  - 3 lines, 15 characters per line, using 18” high characters.
- **DMS Type 3A** – Embedded Front Access Tri-color 66mm – 7 pixels high by 35 pixels wide
  - 1 line, 7 characters per line, using 18” high characters.
- **DMS Type 3C** – Embedded Front Access Full Color 20mm – 24 pixels high by 160 pixels wide
  - 1 line, 8 characters per line, using 18” high characters.

- **DMS Type 4C** – Lane Control Sign Full Color 20mm – 48- or 64-pixels square
  - 48 pixels high by 48 pixels wide
    - 1 line, 2 characters per line using 18” high characters
  - 64 pixels high x 64 pixel wide
    - 2 lines, 3 characters per line using 18” high characters

Use only UL listed and approved electronic and electrical components in the DMS system.

**Use only approved DMS models listed on the NCDOT Qualified Products List (QPL) at the time of construction. NCDOT Qualified Products List can be accessed via official website at <https://apps.ncdot.gov/products/qpl/>**

## 4.2. MATERIALS

### A. Environmental Requirements

Construct the DMS and DMS controller cabinet so the equipment within is protected against moisture, dust, corrosion, and vandalism.

Design the DMS system to comply with the requirements of Section 2.1 (Environmental and Operating Standards) of NEMA TS 4-2016.

### B. Viewing Requirements for all DMS

Each line of text should be clearly visible and legible to a person with 20/20 corrected vision from a distance of 900 feet in advance of the DMS at an eye height of 3.5 feet along the axis.

Any line must display equally spaced and equally sized alphanumeric individual characters. Each character must be at least 18 inches in height (unless otherwise noted in the plans) and composed from a luminous dot matrix.

### C. Housing Requirements for all DMS

Construct the external skin of the sign housing out of aluminum alloy 5052 H32 that is a minimum of 1/8 inches thick for all walk-in DMS and 0.090-inch-thick for all front access or embedded DMS. Ensure the interior structure is constructed of aluminum. Ensure that no internal frame connections or external skin attachments rely upon adhesive bonding or rivets. Ensure the sign housing meets the requirements of Section 3 of NEMA TS 4-2016.

Ensure that all drain holes and other openings in the sign housing are screened to prevent the entrance of insects. Design and construct the DMS unit for continuous usage of at least 20 years. Ensure that the top of the housing includes multiple steel lifting eyebolts or equivalent hoisting points. Ensure hoist points are positioned such that the sign remains level when lifted. Ensure that the hoist points and sign frame allow the sign to be shipped, handled, and installed without damage. Ensure all external assembly and mounting hardware, including but not limited to; nuts, bolts, screws, and locking washers are corrosion resistant galvanized steel and are sealed against water intrusion. Ensure all exterior housing surfaces, excluding the sign face, and all interior housing surfaces are a natural aluminum mill finish. Ensure signs are fabricated, welded, and inspected in accordance with the requirements of the current ANSI/AWS Structural Welding Code-Aluminum. Do not place a manufacturer name, logo, or other information on the front face of the DMS or shield visible to the motorist. Provide power supply monitoring circuitry to detect power failure in the DMS and to automatically report this fault to the Control Software. This requirement is in addition

to reporting power failure at the controller cabinet. Do not paint the stainless-steel bolts on the Z-bar assemblies used for mounting the enclosure.

#### **D. Housing Requirements for Walk-in type DMS**

Ensure the sign housing meets the requirements of Section 3.2.8 of NEMA TS 4-2016. Ensure that exterior seams and joints, except the finish coated face pieces, are continuously welded using an inert gas welding method. Stitch weld the exterior housing panel material to the internal structural members to form a unitized structure. Ensure that exterior mounting assemblies are fabricated from aluminum alloy 6061-T6 extrusions a minimum of 3/16 inches thick. Ensure housing access is provided through an access door at each end of the sign enclosure that meets the requirements of NEMA TS 4-2016, Section 3.2.8.1. Ensure the access doors include a keyed tumbler lock and a door handle with a hasp for a padlock. Ensure the doors include a closed-cell neoprene gasket and stainless-steel hinges. Install one appropriately sized fire extinguisher within 12 inches of each maintenance door. Ensure the sign housing meets the requirements of NEMA TS 4-2016, Section 3.2.8.3 for service lighting. All service lighting should be LED, incandescent and fluorescent lamps are not permitted. Ensure that the sign housing includes LED emergency lighting that automatically illuminates the interior when the door is open in the event of a power outage. Emergency lighting must be capable of operation without power for at least 90 minutes. Ensure the sign housing meets the requirements of NEMA TS 4-2016, Section 3.2.9 for convenience outlets.

#### **E. Housing Requirements for Front Access DMS**

Comply with the requirements of Section 3.2.5 and 3.2.6 of NEMA TS 4-2016 as it applies to front access enclosures. The following requirements complement TS 4-2016. Ensure access door does not require specialized tools or excessive force to open. Provide multiple access doors that allow maintenance personnel access to 2 or 3 sign modules at a time. Vertically hinge the doors and design to swing out from the face to provide access to the enclosure interior. Extend each door the full height of the display matrix. Provide a retaining latch mechanism for each door to hold the door open at a 90-degree angle. Each door will form the face panel for a section of the sign. Mount the LED modules to the door such that they can be removed from the door when in the open position. Other sign components can be located inside the sign enclosure and be accessible through the door opening. Provide for each door a minimum of two (2) screw-type captive latches to lock them in the closed position and pull the door tight and compress a gasket located around the perimeter of each door. Install the gasket around the doors to prevent water from entering the cabinet.

#### **F. Housing Face Requirements for all DMS**

Ensure the sign face meets the requirements of NEMA TS 4-2016, Section 3.1.3. Protect the DMS face with contiguous, weather-tight, removable panels. The DMS front face shall be constructed with multiple rigid panels, each of which supports and protects a full-height section of the LED display matrix. The panels shall be fabricated using aluminum sheeting on the exterior and polycarbonate sheeting on the interior of the panel. These panels must be a polycarbonate material that is ultraviolet protected and have an antireflection coating. Prime and coat the front side of the aluminum mask, which faces the viewing motorists, with automotive-grade semi-gloss black acrylic enamel paint or an approved equivalent. Guarantee all painted surfaces provide a minimum outdoor service life of 20 years. Design the panels so they will

not warp nor reduce the legibility of the characters. Differential expansion of the DMS housing and the front panel must not cause damage to any DMS component or allow openings for moisture or dust. Glare from sunlight, roadway lighting, commercial lighting, or vehicle headlights must not reduce the legibility or visibility of the DMS. Install the panels so that a maintenance person can easily remove or open them for cleaning.

#### **G. Housing Face Requirements for Walk-in type DMS**

The DMS front face shall be constructed with multiple rigid panels, each of which supports and protects a full-height section of the LED display matrix.

No exposed fasteners are allowed on the housing face. Ensure that display modules can be easily and rapidly removed from within the sign without disturbing adjacent display modules.

#### **H. Housing Face Requirements for Front Access type DMS**

The DMS front face shall be constructed with multiple vertically hinged rigid door panels, each of which contains a full-height section of the LED display matrix.

Any exposed fasteners on the housing face must be the same color and finish as the housing face. Only captive fasteners may be used on the housing face.

#### **I. Housing Face Requirements for Embedded Front Access type DMS**

Front Face shall be constructed with a single, horizontally hinged rigid face panel which contains a full-height section of the LED display matrix.

Any exposed fasteners on the housing face must be the same color and finish as the housing face. Only captive fasteners may be used on the housing face.

#### **J. Sign Housing Ventilation System for all DMS**

Install a minimum of one (1) temperature sensor that is mounted near the top of the DMS interior. The sensor(s) will measure the temperature of the air in the enclosure over a minimum range of -40°F to +176°F. Ensure the DMS controller will continuously monitor the internal temperature sensor output and report to the DMS control software upon request.

Design the DMS with systems for enclosure ventilation, face panel fog and frost prevention, and safe over-temperature shutdown.

Design the DMS ventilation system to be thermostatically controlled and to keep the internal DMS air temperature lower than +140°F, when the outdoor ambient temperature is +115°F or less.

The ventilation system will consist of two or more air intake ports located near the bottom of the DMS rear wall. Cover each intake port with a filter that removes airborne particles measuring 500 microns in diameter and larger. Mount one or more ball bearing-type ventilation fans at each intake port. These fans will positively pressure the DMS enclosure.

Design the ventilation fans and air filters to be removable and replaceable from inside the DMS housing. To ease serviceability, mount the ventilation fans no more than four (4) feet from the floor of the DMS enclosure. Position ventilation fans so they do not prevent removal of an LED pixel board or driver board.

Provide each ventilation fan with a sensor to monitor its rotational speed, measured in revolutions per minute and report this speed to the sign controller upon request.

The ventilation system will move air across the rear of the LED modules in a manner such that heat is dissipated from the LED's. Design the airflow system to move air from the bottom of the enclosure towards the top to work with natural convection to move heat away from the modules.

Install each exhaust port near the top of the rear DMS wall. Provide one exhaust port for each air intake port. Screen all exhaust port openings to prevent the entrance of insects and small animals.

Cover each air intake and exhaust port with an aluminum hood attached to the rear wall of the DMS. Thoroughly seal all intakes and exhaust hoods to prevent water from entering the DMS. Provide a thermostat near the top of the DMS interior to control the activation of the ventilation system.

The DMS shall automatically shut down the LED modules to prevent damaging the LEDs if the measured internal enclosure air temperature exceeds a maximum threshold temperature. The threshold temperature shall be configurable and shall have a default factory setting of 140°F. The DMS provide an output to the controller to notify the Vanguard client when the DMS shuts down due to high temperature.

#### **K. Sign Housing Ventilation System for Walk-in DMS**

Ensure the sign includes a fail-safe ventilation subsystem that includes a snap disk thermostat that is independent of the sign controller. Preset the thermostat at 140°F. If the sign housing's interior reaches 140°F, the thermostat must override the normal ventilation system, bypassing the sign controller and turning on all fans. The fans must remain on until the internal sign housing temperature falls below 115°F.

#### **L. Sign Housing Photoelectric sensors**

Install three photoelectric sensors with ½ inch minimum diameter photosensitive lens inside the DMS enclosure. Use sensors that will operate normally despite continual exposure to direct sunlight. Place the sensors so they are accessible and field adjustable. Point one sensor north or bottom of the sign. Place the other two, one on the back wall and one on the front wall of the sign enclosure. Alternate designs maybe accepted, provided the sensor assemblies that are accessible and serviceable from inside the sign enclosure.

Provide controls so that the Engineer can field adjust the following:

- The light level emitted by the pixels in each Light Level Mode,
- The ambient light level at which each Light Level Mode is activated.

#### **M. Display Modules**

Manufacture each display module with a standard number of pixels which can be easily removed. Assemble the modules onto the DMS assemblies contiguously to form a continuous matrix to display the required number of lines, characters, and character height.

Design display modules that are interchangeable, self-addressable, and replaceable without using special tools. Provide plug-in type power and communication cables to connect to a display module. Ensure that the sign has a full matrix display area as defined in NEMA TS 4-2016, Section 1.6.

Design each module to display:

- All upper- and lower-case letters,
- All punctuation marks,
- All numerals 0 to 9,

- Special user-created characters.

Display upper-case letters and numerals over the complete height of the module. Optimize the LED grouping and mounting angle within a pixel for maximum readability.

Design Type 3A and 3C DMS with at least the following message displays:

- A static display, green in color, reading “OPEN”
- A static display, red in color, reading “CLOSED”
- A static display, amber in color, with the ability to display a toll rate in the following format “\$ XX.XX”

**Furnish two (2) spare display modules per each DMS installed for emergency restoration.**

#### **N. Discrete LEDs**

Provide discrete LEDs with a nominal viewing cone of 30 degrees with a half-power angle of 15 degrees measured from the longitudinal axis of the LED. Make certain, the viewing cone tolerances are as specified in the LED manufacturer’s product specifications and do not exceed +/- 3 degrees half-power viewing angle of 30 degrees.

Provide LEDs that are untinted, non-diffused, high output solid state lamps utilizing AlInGaP technology for Red and InGaN technology for Green and Blue. No substitutions will be allowed. Provide LEDs that emit a full color.

Provide LEDs with a MTBF (Mean Time Before Failure) of at least 100,000 hours of permanent use at an operating point of 140° F or below at a specific forward current of 20mA. Discrete LED failure is defined as the point at which the LED’s luminous intensity has degraded to 50% or less of its original level.

Obtain the LEDs used in the display from a single LED manufacturer. Obtain them from batches sorted for luminous output, where the highest luminosity LED is not more than fifty percent more luminous than the lowest luminosity LED when the LEDs are driven at the same forward current. Do not use more than two successive and overlapping batches in the LED display.

Individually mount the LEDs on circuit boards that are at least 1/16” thick FR-4 fiberglass, flat black printed circuit board in a manner that promotes cooling. Protect all exposed metal on both sides of the LED pixel board (except the power connector) from water and humidity exposure by a thorough application of acrylic conformal coating. Design the boards so bench level repairs to individual pixels, including discrete LED replacement and conformal coating repair is possible.

Operate the LED display at a low internal DC voltage not to exceed 24 Volts.

Design the LED display operating range to be –20° F to +140° F at 95% relative humidity, non-condensing.

Supply the LED manufacturer’s technical specification sheet with the material submittals.

#### **O. LED Power Supplies**

Power the LED Display by means of multiple regulated switching DC power supplies that operate from 120 volts AC input power and have an output of 24 volts DC or less. Wire the power supplies in a redundant parallel configuration that uses multiple power supplies per display. Provide the power supplies with current sharing capability that allows equal amounts of current to their portion of the LED display. Provide power supplies rated such that if one supply fails the remaining supplies will be able to operate their portion of the display under full load conditions (i.e. all pixels on at maximum brightness) and at a temperature of 140° F.



Provide power supplies to operate within a minimum input voltage range of +90 to +135 volts AC and within a temperature range of -22° F to 140° F. Power supply output at 140° F must not deteriorate to less than 65% of its specified output at 70° F. Provide power supplies that are overload protected by means of circuit breakers, that have an efficiency rating of at least 75%, a power factor rating of at least .95, and are UL listed. Provide all power supplies from the same manufacturer and with the same model number for each Type of DMS. Design the power driver circuitry to minimize power consumption.

Design the field controller to monitor the operational status (normal or failed) of each individual power supply and be able to display this information on the Client Computer screen graphically. Color code power supply status, red for failed and green for normal.

#### **P. LED Pixels**

A pixel is defined as the smallest programmable portion of a display module that consists of a cluster of closely spaced discrete LEDs. Design each pixel with either 66mm or 20mm spacing depending on the type of DMS called for in the plans.

Construct the pixels with strings of LEDs. It is the manufacturer's responsibility to determine the number of LEDs in each string to produce the candela requirement as stated herein.

Use continuous current to drive the LEDs at the maximum brightness level. Design the light levels to be adjustable for each DMS / controller so the Engineer may set levels to match the luminance requirements at each installation site.

Ensure each pixel produces a luminous intensity of 40 Cd when driven with an LED drive current of 20 mA per string.

Power the LEDs in each pixel in strings. Use a redundant design so that the failure of an LED in one string does not affect the operation of any other string within the pixel and does not lower the luminous intensity of the pixel more than 25% of the 40Cd requirement. Provide the sign controller with the ability to detect the failure of any LED string and identify which LED string has failed.

#### **Q. DMS Mini Controller**

For Walk-In and Front Access DMS Types only, furnish and install a mini controller inside the DMS that is interconnected with the main controller using a fiber-optic cable. The mini controller will enable a technician to perform all functions available from the main controller. Provide the mini controller with an LCD/keypad interface. Size the LCD display screen to allow preview of an entire one-page message on one screen. Provide a 4 X 4 keypad.

#### **R. DMS Enclosure Structure Mounting**

Mount the DMS enclosure and interconnect system securely to the supporting structures. Design the DMS enclosure supports and structure to allow full access to the DMS enclosure inspection door. Mount the DMS enclosure according to the manufacturer's recommendations.

Furnish and install U-bolt connections of hanger beams to truss chords with a double nut at each end of the U-bolt. Bring the double nuts tight against each other by the use of two wrenches.

Submit plans for the DMS enclosure, structure, mounting description and calculations to the Engineer for approval. Have such calculations and drawings approved by a Professional Engineer registered in the state of North Carolina, and bear his signature, seal, and date of acceptance.

Provide removable lifting eyes or the equivalent on the DMS enclosure rated for its total weight to facilitate handling and mounting the DMS enclosure.

Design the DMS structure to conform to the applicable requirements of the most recent version of the *Standard Specifications for Structural Supports for Highway Signs, Luminaires and Traffic*

*Signals*, currently in use by the department and the section titled “DMS Assemblies” of these Project Special Provisions.

#### **S. DMS / DMS Controller Interconnect**

Furnish and install all necessary cabling, conduit, and terminal blocks to connect the DMS and the DMS controller located in the equipment cabinet. Use approved manufacturer's specifications and the Project Plans for cable and conduit types and sizes. Use fiber-optic cable to interconnect sign and controller. Install fiber-optic interconnect centers in the sign enclosure and cabinet to securely install and terminate the fiber-optic cable. Submit material submittal cut sheets for the interconnect center.

#### **T. DMS Controller and DMS Cabinet**

Furnish and install one DMS controller with accessories per DMS in a protective cabinet. Controlling multiple DMS with one controller is allowed when multiple DMS are mounted on the same structure. Mount the controller cabinet on the existing DMS cabinet foundation. Install new cabinet on a 12” (inch) base extender made of the same material as the cabinet.

Provide the DMS controller as a software-oriented microprocessor and with resident software stored in non-volatile memory. The Control Software, controller and communications must comply with the NTCIP Standards identified in these Project Special Provisions. Provide sufficient non-volatile memory to allow storage of at least 500 multi-page messages and a test pattern program.

For DMS Type 4C installations provide a single controller that can control up to eight (8) signs simultaneously.

Furnish the controller cabinet with, but not limited to, the following:

- Power supply and distribution assemblies,
- Power line filtering hybrid surge protectors,
- Radio Interference Suppressor,
- Communications surge protection devices,
- Industrial-Grade UPS system and local disconnect,
- Microprocessor based controller,
- Display driver and control system (unless integral to the DMS),
- RJ45 Ethernet interface port for local laptop computer,
- Local user interface,
- Interior lighting and duplex receptacle,
- Adjustable shelves as required for components,
- Temperature control system,
- All interconnect harnesses, connectors, and terminal blocks,
- All necessary installation and mounting hardware.

Furnish the DMS controller and associated equipment completely housed in a NEMA 3R cabinet made from 5052 H32 sheet aluminum at least 1/8” thick. Use natural aluminum cabinets. Perform all welding of aluminum and aluminum alloys in accordance with the latest edition of AWS D1.2,

Structural Welding Code - Aluminum. Continuously weld the seams using Gas Metal Arc Welding (GMAW).

Slant the cabinet roof away from the front of the cabinet to prevent water from collecting on it.

Do not place a manufacturer name, logo, or other information on the faces of the controller cabinet visible to the motorist.

Provide cabinets capable of housing the components and sized to fit space requirement. Design the cabinet layout for ease of maintenance and operation, with all components easily accessible. Submit a cabinet layout plan for approval by the Engineer.

Locate louvered vents with filters in the cabinet to direct airflow over the controller and auxiliary equipment, and in a manner that prevents rain from entering the cabinet. Fit the inside of the cabinet, directly behind the vents, with a replaceable, standard size, commercially available air filter of sufficient size to cover the entire vented area.

Provide a torsionally rigid door with a continuous stainless-steel hinge on the side that permits complete access to the cabinet interior. Provide a gasket as a permanent and weather resistant seal at the cabinet door and at the edges of the fan / exhaust openings. Use a non-absorbent gasket material that will maintain its resiliency after long term exposure to the outdoor environment. Construct the doors so that they fit firmly and evenly against the gasket material when closed. Provide the cabinet door with louvered vents and air filters near the bottom as described in the paragraph above.

The cabinet shall contain a full-height standard EIA 19-inch rack. The rack shall be secured within the cabinet by mounts at the top and bottom.

The rack shall contain a minimum of one (1) pullout drawer. The drawer shall be suitable for storing manuals and small tools. The drawer shall be able to latch in the out position to function as a laptop/utility shelf.

Provide a convenient location on the inside of the door to store the cabinet wiring diagrams and other related cabinet drawings. Provide a Corbin #2 main door lock made of non-ferrous or stainless-steel material. Key all locks on the project alike and provide 1 key per lock to the Engineer. In addition, design the handle to permit padlocking.

Provide the interior of the cabinet with ample space for housing the controller and all associated equipment and wiring. Provide ample space in the bottom of the cabinet for the entrance and exit of all power, communications, and grounding conductors and conduit.

Arrange the equipment to permit easy installation of the cabling through the conduit so that they will not interfere with the operation, inspection, or maintenance of the unit. Provide adjustable metal shelves, brackets, or other support for the controller unit and auxiliary equipment. Leave a 3-inch minimum clearance from the bottom of the cabinet to all equipment, terminals, and bus bars.

Provide power supply monitoring circuitry to detect power failure and to automatically report the occurrence to the Control Software.

Install two 15-watt fluorescent light strips with shields, one in the top of the cabinet and the other under the bottom shelf. Design both lights to automatically turn on when the cabinet door is opened and turn off when the door closes.

Mount and wire a 120V (+10%) GFCI duplex receptacle of the 3-wire grounding type in the cabinet in a location that presents no electrical hazard when used by service personnel for the operation of power tools and work lights.

**No cabinet resident equipment may utilize the GFCI receptacle. Furnish one spare non-GFCI duplex receptacle for future equipment.**

Mount a bug-proof and weatherproof thermostatically controlled fan and safety shield in the top of the cabinet. Size the fan to provide at least for two air exchanges per minute. Fuse the fan at 125% of the capacity of the motor. The magnetic field of the fan motor must not affect the

performance of the control equipment. Use a fan thermostat that is manually adjustable to turn on between 80° F and 160° F with a differential of not more than 10° F between automatic turn on and turn off. Mount it in an easily accessible location, but not within 6 inches of the fan.

Install additional fans and/or heaters as needed to maintain the temperature inside the cabinet within the operating temperature range of the equipment within the cabinet as recommended by equipment manufacturer(s).

### **1. Wiring**

The requirements stated herein apply wherever electrical wiring is needed for any DMS system assemblies and subassemblies such as controller cabinet, DMS enclosure, electrical panel boards etc.

Neatly arrange and secure the wiring inside the cabinet. Where cable wires are clamped to the walls of the control cabinet, provide clamps made of nylon, metal, plastic with rubber or neoprene protectors, or similar. Lace and jacket all harnesses or tie them with nylon tie wraps spaced at 6 inches maximum to prevent separation of the individual conductors.

Individually and uniquely label all conductors. Ensure all conductor labels are clearly visible without moving the conductor. Connect all terminal conductors to the terminal strip in right angles. Remove excess conductor before termination of the conductor. Mold the conductor in such a fashion as to retain its relative position to the terminal strip if removed from the strip. Do not run a conductor across a work surface with the exception of connecting to that work surface. No conductor bundles can be support by fasteners that support work surfaces. Install all connectors, devices and conductors in accordance to manufactures guidelines. Comply with the latest NEC guideline in effect during installation. No conductor or conductor bundle may hang loose or create a snag hazard. Protect all conductors from damage. Ensure all solder joints are completed using industry accepted practices and will not fail due to vibration or movement. Protect lamps and control boards from damage.

No splicing will be allowed for feeder conductors and communication cables from the equipment cabinet to the DMS enclosure.

Insulate all conductors and live terminals so they are not hazardous to maintenance personnel.

Route and bundle all wiring containing line voltage AC and / or shield it from all low voltage control circuits. Install safety covers to prevent accidental contact with all live AC terminals located inside the cabinet.

Use industry standard, keyed type connectors with a retaining feature for connections to the controller.

Label all equipment and equipment controls clearly.

Supply each cabinet with one complete set of wiring diagrams that identify the color-coding or wire tagging used in all connections. Furnish a water-resistant packet adequate for storing wiring diagrams, operating instructions, and maintenance manuals with each cabinet.

### **2. Power Supply and Circuit Protection**

Design the DMS and controller for use on a system with a line voltage of 120V + 10% at a frequency of 60 Hz  $\pm$  3 Hz. Under normal operation, do not allow the voltage drop between no load and full load of the DMS and its controller to exceed 3% of the nominal voltage.

Blackout, brownout, line noise, chronic over-voltage, sag, spike, surge, and transient effects are considered typical AC voltage defects. Protect the DMS system equipment so that these defects do not damage the DMS equipment or interrupt their operation. Equip all cabinets with devices to protect the equipment in the cabinet from damage due to lightning and external circuit power and current surges.

**3. Circuit Breakers**

Protect the DMS controller, accessories, and cabinet utilities with thermal magnetic circuit breakers. Provide the controller cabinet with a main circuit breaker sized according to the NEC. Use appropriately sized branch circuit breakers to protect the controller, sign display and accessories and for servicing DMS equipment and cabinet utilities.

Provide a subpanel in the sign enclosure with a main and branch circuit breakers sized appropriately per NEC.

Provide a detailed plan for power distribution within the cabinet and the sign. Label all breaker and conductor with size and loads. Have the plans signed and sealed by a NC registered PE and submit the plans for review and approval.

**4. Surge Suppressor**

Install and clearly label filtering hybrid power line surge protectors on the load side of the branch circuit breakers in a manner that permits easy servicing. Ground and electrically bond the surge protector to the cabinet within 2 inches.

Provide power line surge protector that meets the following requirements:

Peak surge current occurrences	20 minimum
Peak surge current for an 8 x 20 microsecond waveshape	50,000 Amperes
Energy Absorption	> 500 Joules
Clamp voltage	240 Volts
Response time	<1 nanosecond
Minimum current for filtered output	15 Amperes for 120VAC*
Temperature range	-40°F to +158°F

\*Capable of handling the continuous current to the equipment

**5. Transients and Emissions**

DMS and DMS controller will be designed in such a way to meet the latest NEMA TS-4 for Transients and Emissions.

**6. Transient Protection**

The RS232 and Ethernet communication ports in the DMS sign controller shall be protected with surge protection between each signal line and ground. This surge protection shall be integrated internally within the controller.

**7. Lightning Arrester**

Protect the system with an UL approved lightning arrester installed at the main service disconnect that meets the following requirements:

Type of design	Silicon Oxide Varistor
Voltage	120/240 Single phase, 3 wires
Maximum current	100,000 Amps

Maximum energy	3000 Joules per pole
Maximum number of surges	Unlimited
Response time one milliamp test	5 nanoseconds
Response time to clamp 10,000 amps	10 nanoseconds
Response time to clamp 50,000 amps	25 nanoseconds
Leak current at double the rated voltage	None
Ground Wire	Separate

**8. Uninterruptible Power Supply (UPS)**

Provide the cabinet with an industrial grade power conditioning UPS unit to supply continuous power to operate the equipment connected to it if the primary power fails. **The UPS must continue to condition power supplied to the DMS controller in the event of battery failure within the UPS.** The UPS must detect a power failure and provide backup power within 20 milliseconds. Transition to the UPS source from primary power must not cause loss of data or damage to the equipment being supplied with backup power. Provide an UPS with at least three outlets for supplying conditioned AC voltage to the DMS controller. Provide a unit to meet the following requirements:

Input Voltage Range	120VAC +12%, -25%
Power Rating	1000 VA, 700 Watts
Input Frequency	45 to 65 Hz
Input Current	7.2A
Output Voltage	120VAC +/- 3%
Output Frequency	50/60 +/-1 Hz
Output Current	8.3A
Output Crest Factor Ratio	@50% Load Up to 4.8:1 @75% Load Up to 3.2:1 @100% Load Up to 2.4:1
Output THD	3% Max. (Linear) 5% Max. (Non-Linear)
Output Overload	110% for 10 min; 200% for 0.05 sec.
Output Dynamic Response	+/- 4% for 100% Step Load Change 0.5 ms Recovery Time.
Output Efficiency @ 100% Load	90% (Normal Mode)
Operating Temperature	-40° F to +165 ° F
Humidity	0% to 95% Non-condensing

Remote Monitoring Interface	RS-232
Protection	Input/Output Short Circuit Input/Output Overload Excessive Battery Discharge
Specifications	UL1778, FCC Class A, IEE 587

Provide the UPS unit capable of supplying **30 minutes** of continuous backup power to the cabinet equipment connected to it when the equipment is operating at full load.

**9. Controller Communications Interface**

Provide the controller with the following interface ports:

- An EIA/TIA-232E port for remote communication using NTCIP,
- An 10/100 Ethernet port for remote communication using NTCIP,
- An EIA/TIA-232E port for onsite access using a laptop,
- An EIA/TIA-232E auxiliary port for communication with a field device such as a UPS,
- Fiber-optic ports for communication with the sign,
- RJ45 ports for communication with the sign using CAT-5 cable,
- RJ45 ports for communication with mini controller located inside the sign enclosure.

**10. Controller Local User Interface**

Provide the controller with a Local User Interface (LUI) for at least the following functions:

- On / Off Switch: controls power to the controller,
- Control Mode Switch: for setting the controller operation mode to either remote or local mode,
- LCD Display and Keypad: Allow user to navigate through the controller menu for configuration (display, communications parameter, etc.) running diagnostics, viewing peripherals status, message creation, message preview, message activation, etc. Furnish a LCD display with a minimum size of 240x64 dots with LED back light.

Protected access to the LUI with an alphanumeric and PIN passwords. Allow the user to select a preferred method of password protection. Default and hardcoded passwords are not allowed.

### **11. Controller Address**

Assign each DMS controller a unique address. Preface all commands from the Control Software with a particular DMS controller address. The DMS controller compares its address with the address transmitted; if the addresses match, then the controller processes the accompanying data.

### **12. Controller Functions**

Design the DMS controller to continuously control and monitor the DMS independent of the Control Software. Design the controller to display a message on the sign sent by the Control Software, a message stored in the sign controller memory, or a message created on site by an operator using the controller keypad.

Provide the DMS controller with a watchdog timer to detect controller failures and to reset the microprocessor, and with a battery backed up clock to maintain an accurate time and date reference. Set the clock through an external command from the Control Software or the Local User Interface.

### **13. DMS Controller Memory**

Furnish each DMS controller with non-volatile memory. Use the non-volatile memory to store and reprogram at least one test pattern sequence and 500 messages containing a minimum of two pages of 45 characters per page. The Control Software can upload messages into and download messages from each controller's non-volatile memory remotely.

Messages uploaded and stored in the controller's non-volatile memory may be erased and edited using the Control Software and the controller. New messages may be uploaded to and stored in the controller's non-volatile memory using the Control Software and the controller.

## **U. Equipment List**

Provide a general description of all equipment and all information necessary to describe the basic use or function of the major system components. Include a general "block diagram" presentation. Include tabular charts listing auxiliary equipment, if any is required. Include the nomenclature, physical and electrical characteristics, and functions of the auxiliary equipment unless such information is contained in an associated manual; in this case include a reference to the location of the information.

Include a table itemizing the estimated average and maximum power consumption for each major piece of equipment.

## **V. Physical Description**

Provide a detailed physical description of size, weight, center of gravity, special mounting requirements, electrical connections, and all other pertinent information necessary for proper installation and operation of the equipment.

## **W. Parts List**

Provide a parts list that contains all information needed to describe the characteristics of the individual parts, as required for identification. Include a list of all equipment within a group and a list of all assemblies, sub-assemblies, and replacement parts of all units. Arrange this data in a table, in alpha numerical order of the schematic reference symbols, which gives the associated description,



manufacturer's name, and part number, as well as alternate manufacturers and part numbers. Provide a table of contents or other appropriate grouping to identify major components, assemblies, etc.

#### **X. Character Set Submittal**

Submit an engineering drawing of the DMS character set including at a minimum, 26 upper case and lower case letters, 10 numerals, 9 punctuation marks ( , , ! ? - ' " ; : ) 12 special characters ( # & \* + / ( ) [ ] < > @ ) and arrows at 0, 45, 90, 135, 180, 225, 270, and 315 degrees.

#### **Y. Wiring Diagrams**

Provide a wiring diagram for each DMS and each controller cabinet, as well as interconnection wiring diagrams for the system as a whole.

**Provide complete and detailed schematic diagrams to component level for all DMS assemblies and subassemblies such as driver boards, control boards, DMS controller, power supplies, and etc. Ensure that each schematic enables an electronics technician to successfully identify any component on a board or assemblies and trace its incoming and outgoing signals.**

#### **Z. Routine of Operation**

Describe the operational routine, from necessary preparations for placing the equipment into operation to securing the equipment after operation. Show appropriate illustrations with the sequence of operations presented in tabular form wherever applicable. Include in this section a total list of the test instruments, aids and tools required to perform necessary measurements and measurement techniques for each component, as well as set up, test, and calibration procedures.

#### **AA. Maintenance Procedures**

Specify the recommended preventative maintenance procedures and checks at pre-operation, monthly, quarterly, semiannual, annual, and "as required" periods to assure equipment operates reliably. List specifications (including tolerances) for all electrical, mechanical, and other applicable measurements and / or adjustments.

#### **BB. Repair Procedures**

Include in this section all data and step by step procedures necessary to isolate and repair failures or malfunctions, assuming the maintenance technicians are capable of analytical reasoning using the information provided in the section titled "Wiring Diagrams and Theory of Operation."

Describe accuracy, limits, and tolerances for all electrical, physical, or other applicable measurements. Include instructions for disassembly, overhaul, and reassembly, with shop specifications and performance requirements.

Give detailed instructions only where failure to follow special procedures would result in damage to equipment, improper operation, danger to operating or maintenance personnel, etc. Include such instructions and specifications only for maintenance that specialized technicians and engineers in a modern electromechanical shop would perform. Describe special test set up, component fabrication, and the use of special tools, jigs, and test equipment.

#### **CC. Warranty**

Ensure that the DMS system and equipment has a manufacturer's warranty covering defects for a minimum of five (5) years from the date of final acceptance by the Engineer.

### 4.3. CONSTRUCTION METHODS

#### A. Description

This article establishes practices and procedures and gives minimum standards and requirements for the installation of DMS systems, auxiliary equipment and the construction of related structures.

Provide electrical equipment described in this specification that conforms to the standards of NEMA, UL, or Electronic Industries Association (EIA), wherever applicable. Provide connections between DMS equipment and DMS sign housing and electric utilities that conform to NEC standards.

Provide stainless steel screws, nuts, and locking washers in all external locations. Do not use self-tapping screws unless specifically approved by the Engineer. Use parts made of corrosion resistant materials, such as plastic, stainless steel, brass, or aluminum. Use construction materials that resist fungus growth and moisture deterioration. Separate dissimilar metals by an inert dielectric material.

#### B. Layout

The Regional ITS engineer or Division Traffic Engineer will establish the actual location of each DMS assembly. It is the Contractor's responsibility to ensure proper elevation, offset, and orientation of all DMS assemblies. The location of service poles as well as conduit lengths shown in the Project Plans, are approximate based on available project data. Make actual field measurements to place conduit and equipment at the required location.

#### C. Construction Submittal

When the work is complete, submit "as built" plans, inventory sheets, and any other data required by the Engineer to show the details of actual construction and installation and any modifications made during installation.

The "as built" plans will show: the DMS, controller, and service pole locations; DMS enclosure and controller cabinet wiring layouts; and wire and conduit routing. Show all underground conduits and cables dimensioned from fixed objects.

Include detailed drawings that identify the routing of all conductors in the system by cable type, color code, and function. Clearly label all equipment in the DMS system, controller cabinet, and DMS enclosure.

#### D. Conduit

Install the conduit system in accordance with Section 1715 of the Standard Specifications and NEC requirements for an approved watertight raceway.

Make bends in the conduit so as not to damage it or change its internal diameter. Install watertight and continuous conduit with as few couplings as standard lengths permit.

Clean conduit before, during, and after installation. Install conduit in such a manner that temperature changes will not cause elongation or contraction that might damage the system.

Attach the conduit system to and install along the structural components of the Sign structure assemblies with beam clamps or stainless-steel strapping or inside the structure if there is available space. Install strapping according to the strapping manufacturer's recommendations and according to NEC requirements. Do not use welding or drilling to fasten conduit to structural components.

Space the fasteners at no more than 4 feet for conduit 1.5 inches and larger or 6 feet for conduit smaller than 1.25 inches. Place fasteners no more than 3 feet from the center of bends, fittings, boxes, switches, and devices.

Flexible conduit will only be allowed when the conduits transition from the horizontal structure segment to the horizontal truss segment and from the horizontal truss segment to the rear entrance of the DMS when installing the DMS communications and feeder cables. The maximum length of flexible conduit allowed at each transition will be 5 feet.

Do not exceed the appropriate fill ratio on all cable installed in conduit as specified in the NEC.

#### **E. Wiring Methods (Power)**

Do not pull permanent wire through a conduit system until the system is complete and has been cleaned.

Color-code all conductors per the NEC. Use approved marking tape, paint, sleeves or continuous colored conductors for No.8 AWG and larger. Do not mark a white conductor in a cable assembly any other color.

Do not splice underground circuits unless specifically noted in the Project Plans.

#### **F. Equipment and Cabinet Mounting**

Mount equipment securely at the locations shown in the Project Plans, in conformance with the dimensions shown. Install fasteners as recommended by the manufacturer and space them evenly. Use all mounting holes and attachment points for attaching DMS enclosures and controller cabinets to the structures.

Drill holes for expansion anchors of the size recommended by the manufacturer of the anchors and thoroughly clean them of all debris.

Provide cabinets with all strapping hardware and any other necessary mounting hardware in accordance with these Project Special Provisions and the Project Plans.

Seal all unused conduit installed in cabinets at both ends to prevent water and dirt from entering the conduit and cabinet with approved sealing material.

Install a ground bushing attached inside the cabinet on all metal conduits entering the cabinet. Connect these ground bushings to the cabinet ground bus.

Install a level concrete technician pad measuring a minimum 4 inches thick, 36 inches wide and 36 inches long at the front door of the DMS equipment cabinet as shown on the Typical Details sheet within the Project Plans.

#### **G. Work Site Clean-Up**

Clean the site of all debris, excess excavation, waste packing material, wire, etc. Clean and clear the work site at the end of each workday. Do not throw waste material in storm drains or sewers.

#### **4.4. GENERAL TEST PROCEDURE**

Test the DMS and its components in a series of functional tests and ensure the results of each test meet the specified requirements. These tests should not damage the equipment. The Engineer will reject equipment that fails to fulfill the requirements of any test. Resubmit rejected equipment after correcting non-conformities and re-testing; completely document all diagnoses and corrective

actions. Modify all equipment furnished under this contract, without additional cost to the Department, to incorporate all design changes necessary to pass the required tests.

Provide 4 copies of all test procedures and requirements to the Engineer for review and approval at least 30 days prior to the testing start date.

Only use approved procedures for the tests. Include the following in the test procedures:

- A step-by-step outline of the test sequence that demonstrates the testing of every function of the equipment or system tested
- A description of the expected nominal operation, output, and test results, and the pass / fail criteria
- An estimate of the test duration and a proposed test schedule
- A data form to record all data and quantitative results obtained during the test
- A description of any special equipment, setup, manpower, or conditions required by the test

Provide all necessary test equipment and technical support. Use test equipment calibrated to National Institute of Standards and Technology (NIST) standards. Provide calibration documentation upon request.

Conform to these testing requirements and the requirements of these specifications. It is the Contractor's responsibility to ensure the system functions properly even after the Engineer accepts the CCTV test results.

Provide 4 copies of the quantitative test results and data forms containing all data taken, highlighting any non-conforming results and remedies taken, to the Engineer for approval. An authorized representative of the manufacturer must sign the test results and data forms.

#### **4.5. COMPATIBILITY TESTS**

##### **A. DMS System**

Compatibility Tests are applicable to DMS that the Contractor wishes to furnish but are of a different manufacturer or model series than the existing units installed in the Region. If required, the Compatibility Test shall be completed and accepted by the Engineer prior to approval of the material submittal.

The Compatibility Test shall be performed in a laboratory environment at a facility chosen by the Engineer based on the type of unit being tested. Provide notice to the Engineer with the material submitted that a Compatibility Test is requested. The notice shall include a detailed test plan that will show compatibility with existing equipment. The notice shall be given a minimum of 15 calendar days prior to the beginning of the Compatibility Test.

The Contractor shall provide, install, and integrate a full-functioning unit to be tested. The Department will provide access to existing equipment to facilitate these testing procedures. The Engineer will determine if the Compatibility Test was acceptable for each proposed device. To prove compatibility the Contractor is responsible for configuring the proposed equipment at the applicable Traffic Operations Center (TOC) with the accompaniment of an approved TOC employee.

#### 4.6. OPERATIONAL FIELD TEST (ON-SITE COMMISSIONING)

##### A. DMS System

Final DMS locations must be field verified and approved by the Engineer. Perform the following local operational field tests at the DMS assembly field site in accordance with the test plans. The Contractor is responsible for providing a laptop for camera control and positioning during the test. After completing the installation of the camera assemblies, including the camera hardware, power supply, and connecting cables, the contractor shall:

##### Local Field Testing

Furnish all equipment and labor necessary to test the installed camera and perform the following tests before any connections are made.

- Verify that physical construction has been completed.
- Inspect the quality and tightness of ground and surge protector connections.
- Check the power supply voltages and outputs, check connection of devices to power source.
- Verify installation of specified cables and connection between the DMS and control cabinet,
- Make sure cabinet wiring is neat and labeled properly; check wiring for any wear and tear; check for exposed or loose wires.
- Perform the DMS assembly manufacturer's initial power-on test in accordance with the manufacturer's recommendation.
- Set the DMS control address.

##### Central Operations Testing

- Interconnect the DMS's communication interface device with one of the following methods as depicted on the plans:
  - communication network's assigned Ethernet switch and assigned fiber-optic trunk cable and verify a transmit/receive LED is functioning and that the DMS is fully operational at the TOC.
- OR
  - to the DOT furnished cellular modem and verify a transmit/receive LED is functioning and that the DMS is fully operational at the TOC.
- Review DMS date and time and DMS controller information.
- Run DMS diagnostics and review results.
- Run DMS pixel test and review results.
- Run test message.
- Run test schedule.
- Program burn-in scenario.

Approval of Operational Field Test results does not relieve the Contractor to conform to the requirements in these Project Special Provisions. If the DMS system does not pass these tests, document a correction or substitute a new unit as approved by the Engineer. Re-test the system until it passes all requirements.

**4.7. MEASUREMENT AND PAYMENT**

*Dynamic Message Sign* (Type 2C) will be measured and paid as the actual type and number of DMS furnished, installed, and accepted. Each DMS consists of a LED Dynamic Message Sign, spare display modules, warranty, strapping hardware, controller, UPS, controller cabinet, base 12” base extender, concrete technician pad, conduit, fittings, couplings, sweeps, conduit bodies, wire, flexible conduit, feeder conductors and communications cable between the controller cabinet and the DMS enclosure, connectors, circuit protection equipment, photo-electric sensors, tools, materials, all related testing, cost of labor, cost of transportation, incidentals, and all other equipment necessary to furnish and install the DMS system.

Replacement of existing base mounted cabinet and installation of a 12” base extender will be incidental to the installation of the new DMS cabinet. Relocation of the existing Ethernet edge switch, interconnect center and fiber splicing will be incidental to the cabinet replacement.

Payment will be made under:

Dynamic Message Sign (Type 2C).....Each

**5. NTCIP REQUIREMENTS**

This section defines the NTCIP requirements for the DMSs covered by these Project Special Provisions and Project Plans.

**5.1. References**

**A. Standards**

This specification references several standards through their NTCIP designated names. The following list provides the full reference to the current version of each of these standards.

Implement the most recent version of the standard including any and all Approved or Recommended Amendments to these standards for each NTCIP Component covered by these project specifications. Refer to the NTCIP library at [www.ntcip.org](http://www.ntcip.org) for information on the current status of NTCIP standards.

Abbreviated Number	Title
NTCIP 1201	<i>Global Object (GO) Definitions</i>
NTCIP 1203	<i>Object Definitions for</i>

Abbreviated Number	Title
	<i>Dynamic Message Signs</i>
NTCIP 2101	<i>SP-PMPP/232 Subnet Profile for PMPP over RS-232</i>
NTCIP 2104	<i>SP-Ethernet Subnet Profile for Ethernet</i>
NTCIP 2201	<i>TP-Null Transport Profile</i>
NTCIP 2202	<i>Internet Transport Profile (TCP/IP and UDP/IP)</i>
NTCIP 2301	<i>AP for Simple Transportation Management Framework</i>

**B. Features**

Each DMS shall be required to support the following optional features, conformance groups and all functional requirements and objects that apply herein.

Feature	Reference
Time Management	NTCIP 1201 v3
Timebase Event Schedule	NTCIP 1201 v3
PMPP	NTCIP 1201 v3
Determine Sign Display Capabilities	NTCIP 1203 v03
Manage Fonts	NTCIP 1203 v03
Manage Graphics	NTCIP 1203 v03
Schedule Messages for Display	NTCIP 1203 v03
Change Message Display Based on and Internal Event	NTCIP 1203 v03
Control External Devices	NTCIP 1203 v03
Monitor Sign Environment	NTCIP 1203 v03
Monitor Door Status	NTCIP 1203 v03
Monitor Controller Software Operations	NTCIP 1203 v03
Monitor Automatic Blanking of Sign	NTCIP 1203 v03
Report	NTCIP 1103 v03

**C. Objects**

The following table represents objects that are considered optional in the NTCIP standards but are required by this specification. It also indicated modified objects value ranges for certain objects. Each DMS shall provide the full, standard object range support (FSORS) of all the objects required by these specifications unless otherwise stated below.

<b>Object</b>	<b>Reference</b>	<b>Requirement</b>
moduleTable	NTCIP 1201 – 2.2.3	Shall contain at least one row with moduleType equal to 3 (software) The moduleMake specifies the name of the manufacturer, the moduleModel specifies the manufacturer's name of the component and the moduleVersion indicates the model version number of the component.
maxTimeBaseScheduleEntries	NTCIP 1201 – 2.4.3.1.	Shall be at least 28
maxDayPlans	NTCIP 1201 – 2.4.4.1	Shall be at least 20
maxDayPlanEvents	NTCIP 1201 – 2.4.4.2	Shall be at least 12
maxGroupAddresses	NTCIP 1201 – 2.7.1	Shall be at least 1
maxEventLogConfigs	NTCIP 1103 – A.7.4	Shall be at least 50
eventConfigMode	NTCIP 1103 – A.7.5.3	The DMS shall support the following Event Configurations: onChange, greaterThanValue, smallerThanValue
eventConfigLogOID	NTCIP 1103 – A.7.5.7	FSORS
eventConfigAction	NTCIP 1103 – A.7.5.8	FSORS
maxEventLogSize	NTCIP 1103 – A.7.6	Shall be at least 20
maxEventClasses	NCTIP 1103 – A.7.2	Shall be at least 16
eventClassDescription	NTCIP 1103 – A.7.3.4	FSORS
communityNamesMax	NTCIP 1103 – A.7.8	Shall be at least 3
numFonts	NTCIP 1203 – 5.4.1	Shall be at least 12
maxFontCharacters	NTCIP 1203 – 5.4.3	Shall be at least 255
defaultFlashOn	NTCIP 1203 – 5.5.3	The DMS shall support flash “on” times ranging from 0.1 to 9.9 seconds in 0.1 second increments
defaultFlashOnActive	NTCIP 1203 – 5.5.4	The DMS shall support flash “on” times ranging from 0.1 to 9.9 seconds in 0.1 second increments
defaultFlashOff	NTCIP 1203 - 5.5.5	The DMS shall support flash “off” times ranging from 0.1 to 9.9 seconds in 0.1 second increments
defaultFlassOffActive	NTCIP 1203 – 5.5.6	The DMS shall support flash “off” times ranging from 0.1 to 9.9 seconds in 0.1 second increments



defaultBackgroundColor	NTCIP 1203 – 5.5.2	The DMS shall support the black background color
defaultForegroundColor	NTCIP 1203 - 5.5.2	The DMS shall support the amber foreground color
defaultJustificationLine	NTCIP 1203 - 5.5.9	The DMS shall support the following forms of line justification: left, center, and right
defaultJustificationPage	NTCIP 1203 - 5.5.11	The DMS shall support the following forms of page justification: top, middle, and bottom
defaultPageOnTime	NTCIP 1203 - 5.5.13	The DMS shall support page “on” times ranging from 0.1 to 25.5 seconds in 0.1 second increments
defaultPageOffTime	NTCIP 1203 - 5.5.15	The DMS shall support page “off” times ranging from 0.0 to 25.5 seconds in 0.1 second increments
defaultCharacterSet	NTCIP 1203 - 5.5.21	The DMS shall support the eight bit character set
dmsMaxChangeableMsg	NTCIP 1203 - 5.6.3	Shall be at least 100.
dmsMessageMultiString	NTCIP 1203 - 5.6.8.3	The DMS shall support any valid MULTI string containing any subset of those MULTI tags listed in Table 3 (below)
dmsControlMode	NTCIP 1203 - 5.7.1	Shall support at least the following modes: local, central, and centralOverride
dmsSWReset	NTCIP 1203 - 5.7.2	FSORS
dmsMessageTimeRemaining	NTCIP 1203 - 5.7.4	FSORS
dmsShortPowerRecoveryMessage	NTCIP 1203 - 5.7.8	FSORS
dmsLongPowerRecoveryMessage	NTCIP 1203 - 5.7.9	FSORS
dmsShortPowerLossTime	NTCIP 1203 – 5.7.14	FSORS
dmsResetMessage	NTCIP 1203 - 5.7.11	FSORS
dmsCommunicationsLossMessage	NTCIP 1203 - 5.7.12	FSORS
dmsTimeCommLoss	NTCIP 1203 - 5.7.13	FSORS
dmsEndDurationMessage	NTCIP 1203 - 5.7.15	FSORS
dmsMultiOtherErrorDescription	NTCIP 1203 - 5.7.20	If the vendor implements any vendor-specific MULTI tags, the DMS shall provide meaningful error messages within this object whenever one of these tags generates an error

dmsIllumControl	NTCIP 1203 - 5.8.1	The DMS shall support the following illumination control modes: Photocell, and Manual
dmsIllumNumBrightLevels	NTCIP 1203 - 5.8.4	Shall be at least 100
dmsIllumLightOutputStatus	NTCIP 1203 - 5.8.9	FSORS
numActionTableEntries	NTCIP 1203 - 5.9.1	Shall be at least 200
watcdogFailureCount	NTCIP 1203 - 5.11.1.5	FSORS
dmsStatDoorOpen	NTCIP 1203 - 5.11.1.6	FSORS
fanFailures	NTCIP 1203 - 5.11.2.3.1	FSORS
fanTestActivation	NTCIP 1203 - 5.11.2.3.2	FSORS
tempMinCtrlCabinet	NTCIP 1203 - 5.11.4.1	FSORS
tempMaxCtrlCabinet	NTCIP 1203 - 5.11.4.2	FSORS
tempMinSignHousing	NTCIP 1203 - 5.11.4.5	FSORS
tempMaxSignHousing	NTCIP 1203 - 5.11.4.6	FSORS

**D. MULTI Tags**

Each DMS shall support the following message formatting MULTI tags. The manufacturer may choose to support additional standard or manufacturer specific MULTI tags.

<b>Code</b>	<b>Feature</b>
f1	field 1 - time (12hr)
f2	field 2 - time (24hr)
f8	field 8 – day of month
f9	field 9 – month
f10	field 10 - 2 digit year
f11	field 11 - 4 digit year
fl (and /fl)	flashing text on a line by line basis with flash rates controllable in 0.5 second increments.
fo	Font
jl2	Justification – line – left
jl3	Justification – line – center
jl4	Justification – line – right
jl5	Justification – line – full
jp2	Justification – page – top
jp3	Justification – page – middle
jp4	Justification – page – bottom
mv	moving text
nl	new line

Code	Feature
np	new page, up to 2 instances in a message (i.e., up to 3 pages/frames in a message counting first page)
pt	page times controllable in 0.5 second increments.

**E. Documentation**

Supply software with full documentation, including a CD-ROM containing ASCII versions of the following MIB files in Abstract Syntax Notation 1 (ASN.1) format:

- The relevant version of each official standard MIB Module referenced by the device functionality.
- If the device does not support the full range of any given object within a Standard MIB Module, a manufacturer specific version of the official Standard MIB Module with the supported range indicated in ASN.1 format in the SYNTAX and/or DESCRIPTION fields of the associated OBJECT TYPE macro. Name this file identical to the standard MIB Module, except that it will have the extension ".man".
- A MIB Module in ASN.1 format containing any and all manufacturer-specific objects supported by the device with accurate and meaningful DESCRIPTION fields and supported ranges indicated in the SYNTAX field of the OBJECT-TYPE macros.
- A MIB containing any other objects supported by the device.

Allow the use of any and all of this documentation by any party authorized by the Department for systems integration purposes at any time initially or in the future, regardless of what parties are involved in the systems integration effort.

**F. NTCIP Acceptance Testing**

Test the NTCIP requirements outlined above by a third party testing firm. Submit to the Engineer for approval a portfolio of the selected firm. Include the name, address, and a history of the selected firm in performing NTCIP testing along with references. Also provide a contact person’s name and phone number. Submit detailed NTCIP testing plans and procedures, including a list of hardware and software, to the Engineer for review and approval 10 days in advance of a scheduled testing date. Develop test documents based on the NTCIP requirements of these Project Special Provisions. The acceptance test will use the NTCIP Exerciser, and/or other authorized testing tools and will follow the guidelines established in the ENTERPRISE Test Procedures. Conduct the test in North Carolina on the installed system in the presence of the Engineer. Document and certify the results of the test by the firm conducting the test and submit the Engineer for review and approval. In case of failures, remedy the problem and have the firm retest in North Carolina. Continue process until all failures are resolved. The Department reserves the right to enhance these tests as deemed appropriate to ensure device compliance.

**5.2. Measurement and Payment**

There will be no direct payment for the work covered by this section.

Payment for this work will be covered in the applicable sections of these Project Special Provisions at the contract unit price for “Dynamic Message Sign ( )” and will be full compensation for all work listed above.

## 6. DMS PEDESTAL STRUCTURE

### 6.1. DESCRIPTION

This section includes all design, fabrication, furnishing, and erection of the DMS pedestal structure, platforms, walkways, ladders for access to the DMS inspection doors, and attachment of the DMS enclosures to the structure in accordance with the requirements of these Project Special Provisions and the Project Plans. Fabricate the supporting DMS assemblies from tubular steel. Furnish pedestal type DMS assemblies as shown in the Project Plans.

Provide pedestal DMS structures with a minimum of 25 feet clearance from the high point of the road to the bottom of the DMS enclosure.

Design the new DMS assemblies (including footings), DMS mounting assemblies, maintenance platforms, and access ladders and submit shop drawings for approval. A Professional Engineer that is registered in the state of North Carolina will prepare such computations and drawings. These must bear his signature, seal, and date of acceptance.

The provisions of Section 900 of the Standard Specifications apply to all work covered by this section.

The Standard Provisions SP09R005 and SP09R007 found at the link below apply to all work covered by this section.

<https://connect.ncdot.gov/resources/Specifications/Pages/2018-Specifications-and-Special-Provisions.aspx>

It is the Contractor's responsibility to verify DMS S-dimension elevation drawings for the DMS locations and provide them with the DMS shop drawings for the Engineer's approval.

### 6.2. MATERIALS

Use materials that meet the requirements of:

Section 906 of the *2018 Standard Specification for Roads and Structures*.

Standard Provision SP09R005 *Foundations and Anchor Rod Assemblies for Metal Poles*.

Standard Provision SP09R007 *Overhead and Dynamic Message Sign Foundations*.

### 6.3. CONSTRUCTION METHODS

#### A. General

Construct DMS structures and assemblies in accordance with the requirements of:

Section 906 of the *2018 Standard Specification for Roads and Structures*.

Standard Provision SP09R005 *Foundations and Anchor Rod Assemblies for Metal Poles*.

Standard Provision SP09R007 *Overhead and Dynamic Message Sign Foundations*.

**B. DMS Maintenance Platform (Walkway)**

Provide a maintenance platform (walkway), a minimum of three feet wide with open skid resistant surface and safety railing on the DMS assemblies for access to one of the DMS inspection doors as shown on the plans. Provide platforms with fixed safety railings along both sides from the beginning of the platform to the inspection door. No gap is allowed between walkway and inspection door or along any part of the safety rails.

Ensure the design, fabrication and installation of the access platforms on new DMS structures complies with the following:

- A. The top of the platform grading surface is vertically aligned with the bottom of the DMS door,
- B. The DMS door will open 90-degrees from its closed position without any obstruction from the platform or safety handrails,
- C. The platform is rigidly and directly connected to the walkway brackets and there is no uneven surface between sections,
- D. Install a 4" x 4" safety angle parallel to and along both sides of the platform and extend it the entire length of the platform. Design the safety angle to withstand loading equivalent to the platform,
- E. Ensure the platform design allows full access to the DMS enclosure inspection door with no interference or obstructions.

**C. DMS Access Ladder**

Provide a fixed ladder, of the same material as the pedestal structures, leading to and ending at the access platform. Equip the ladder with a security cover (ladder guard) and lock to prohibit access by unauthorized persons. Furnish the lock to operate with a Corbin #2 key and furnish two keys per lock. Design the rungs on 12-inch center to center typical spacing. Start the first ladder rung no more than 18 inches above the landing pad. Attach the security cover approximately 6 feet above the finished ground. Design the ladder and security cover as a permanent part of the DMS assembly and include complete design details in the DMS assembly shop drawings. Fabricate the ladder and cover to meet all OSHA requirements and applicable state and local codes, including but not limited to providing a ladder cage.

Furnish and install a level concrete pad a minimum of 4 inches deep, 24 inches wide, and 36 inches long to service as a landing pad for accessing the ladder. Design the landing pad to be directly below the bottom rung. Access to the ladder shall not be obstructed by the DMS foundation. Provide pre-formed or cast-in place concrete pads.

**6.4. MEASUREMENT AND PAYMENT**

*DMS Pedestal Structure* will be measured and paid as the actual number of dynamic message sign pedestal structure assemblies furnished, installed, and accepted. Payment includes all design, fabrication, construction, transportation, and attachment of the complete dynamic message sign

assembly, supporting structure, grounding components, hardware, access platform, direct tension indicators, preparing and furnishing shop drawings, additional documentation, incidentals, and all other equipment and features necessary to furnish the system described above.

*DMS Access Ladder* will be measured and paid as the actual number of DMS access ladders, platform, walkway furnished, installed and accepted. Payment includes design, fabrication, transportation, attachment to the DMS assembly as described above, lock with two keys each, and concrete pad.

*Overhead Footings* will be measured and paid in cubic yards and will be full compensation for all materials and labor required in *Overhead and Dynamic Message Sign Foundations (SP09 R007) and Foundations and Anchor Rod Assemblies for Metal Poles (PS09 R005)* referred in the link above. Payment will be made according to PS09 R007

The contract unit price for Overhead Footings will be full compensation for providing labor, tools, equipment and foundation materials, stabilizing or shoring excavations, supplying and placing concrete, reinforcing steel, conduit, anchor rod assemblies and any incidentals necessary to construct sign foundations. Subsurface investigations required by the Engineer will be paid as extra work in accordance with Article 104-7 of the *2018 Standard Specifications for Roads and Structures*.

Payment will be made under:

DMS Pedestal Structure .....	Each
DMS Access Ladder .....	Each
Overhead Footings .....	CY

**7. OBSERVATION PERIOD**

**7.1. 30-DAY OBSERVATION PERIOD**

The 30-Day Observation Period shall be considered part of work to be completed by the project completion date.

Upon successful completion of all project work the 30-day Observation Period may commence. Examples of project work includes but is not limited to:

- Installation of all project devices and communications infrastructure.
- Field Acceptance Testing of all devices.
- Central System Testing of all devices and network communications.
- Correction of all deficiencies and punch list items. (including minor construction items)

This observation consists of a 30-day period of normal, day-to-day operations of the field equipment in operation with new or existing central equipment without any failures. The purpose of this period is to ensure that all components of the system function in accordance with the Plans and these Project Special Provisions.

Respond to system or component failures (or reported failures) that occur during the 30-day Observation Period within twenty-four (24) hours. Correct any failures within forty-eight (48) hours

(includes time of notification). Any failure that affects a major system component as defined below for more than forty-eight (48) hours will suspend the timing of the 30-day Observation Period beginning at the time when the Contractor is notified that the failure occurred. After the cause of such failures has been corrected, timing of the 30-day Observation Period will resume. System or component failures that necessitate a redesign of any component or a failure in any of the major system components exceeding a total of three (3) occurrences will terminate the 30-day Observation Period for that system. The 30-day Observation Period will be restarted from day zero when the redesigned components have been installed and/or the failures corrected. The major system components are:

- Dynamic Message Sign (DMS)
- Communications infrastructure (cell modem)

**7.2. FINAL ACCEPTANCE**

Final system acceptance is defined as the time when all work and materials described in the Plans and these Project Special Provisions have been furnished and completely installed by the Contractor; all parts of the work have been approved and accepted by the Engineer; and successful completion of the 30-day observation period.

The completed System will be ready for final acceptance upon the satisfactory completion of all acceptance tests as detailed in their respective Section of the Project Special provisions; the rectification of all punch-list discrepancies; and the submittal of all project documentation including as-built plans.

**7.3. MEASUREMENT AND PAYMENT**

There will be no payment for this item of work as it is incidental to the project as a whole and to the item of work in which it is associated.

**8. DOCUMENTS AND SUBMITTALS**

**8.1. GENERAL**

The submittals listed below complement requirements stated throughout these Project Special Provisions and do not replace them.

Provide all drawings electronically or on 11" X 17" sheets of paper unless approved by the Engineer otherwise. The drawing must fill the entire sheet of paper excluding a 1" border all around.

Allow 10 business days for all documentation and submittal reviews unless otherwise stated in these Project Special Provisions. Supplement each drawing by catalog cut sheets and parts list. Provide parts list in the following format:

Part ID	Source	Part number	Alternate source	Alternate Part number	Description

## **8.2. DRAWINGS AND DOCUMENTS' CERTIFICATION**

Provide the following drawings, documents, plans, and calculations approved by a Professional Engineer registered in the state of North Carolina that bears his/her signature, seal, and date of acceptance:

- Plans for the DMS enclosure, mounting description, and shop drawings.
- Electrical power distribution drawings and power consumption calculations.

## **8.3. MECHANICAL**

This set of submittals includes, but is not limited to, material specifications, catalog cut sheets, parts list, and fabrication drawings for DMS controller cabinet(s), DMS enclosure, character assemblies, DMS overhead assemblies, DMS to overhead assemblies mounting, and etc. Engineering calculations must accompany drawings as needed and applicable.

## **8.4. ELECTRICAL**

This set of submittals includes, but is not limited to, material specifications, catalog cut sheets, parts list, and wiring diagrams within the DMS controller cabinet, DMS enclosure, DMS controller cabinet/enclosure, service entrance cabinet/panels, and etc. This set of submittals also includes power consumption calculations, wire and conduit size calculations, voltage drop calculation, and etc. The DMS electrical system: wires, conduits, breakers, panel-boards, and etc. must meet the latest edition of NEC requirements.

## **8.5. Electronics**

This set of submittals includes, but is not limited to, material specifications, catalog cut sheets, parts list, and schematic diagrams for all electronics assemblies and sub-assemblies used in the system.

## **8.6. BLOCK DIAGRAMS**

Provide block diagrams for the following:

- DMS System
- DMS Controller Cabinet
- DMS Enclosure
- DMS Controller
- DMS Display Boards
- DMS Driver Board(s)
- DMS Lighting Control Board(s)
- Interface Board(s)
- And other system's boards/assemblies that help in understanding, troubleshooting, and repairing the system and/or system's components.



**8.7. LEDs**

This set of submittals includes LED data/specification sheets and the LED selection procedure as required elsewhere in these Project Special Provisions.

**8.8. BENCH REPAIR DOCUMENTATION:**

After approval of any equipment or equipment component parts and prior to installation of the equipment, supply all schematics drawings, board layout information, equipment manuals, software, and firmware required to perform bench repair to the component level and testing of electronic equipment and equipment circuit boards. Failure to supply the documentation required by this Section will be grounds for rejection of the submitted item. Provide schematic drawings as well as the board layout drawings that identify all components in the equipment or circuit board including but not limited to all digital and analog integrated circuits devices (ICs), all discrete electronic components, transformers, relays, and other electronic devices and components used in the circuits. Provide schematic drawings that show pin to pin interconnection between components. Provide a complete parts list for each circuit board's components. Provide a copy of all software required to operate any equipment or circuit boards for the purposes of test or system software to test operation of equipment used as a system component.

**8.9. PROPRIETARY PARTS**

Provide a list of all proprietary, non-warranty electronic component parts, along with its associated cost, at which the vendor will supply for a two year period after final project acceptance. Failure to supply this required proprietary part and price information may be grounds for rejection of the submitted item due to incomplete information. A part is considered to be a proprietary part if it is designed and manufactured exclusively for a specific application and is not commercially available for sale to the general public. In addition, any item that is sole source (e.g. available only from the vendor or from a single known manufacturer) is considered to be proprietary and should be identified along with the sole source. Identify and quote a price for parts that are no longer being manufactured and identify the item as one that is no longer manufactured.

**8.10. USE BY NCDOT AND PROTECTION OF MANUFACTURER'S PROPRIETARY INFORMATION**

NCDOT Traffic Electronics Center electronics technicians will use the above documentation (schematics, drawings, software, firmware, manuals, etc.) exclusively for the following purposes: diagnosing and performing repairs on malfunctioning equipment, equipment circuit boards, and malfunctioning systems; operational test of repaired equipment, circuit boards, systems; and performing authorized upgrades to equipment, circuit boards, and software supplied under this contract. NCDOT Traffic Electronics Center electronics technicians will not use or copy devices or software for any purpose other than diagnosis, repair, and testing or to perform authorized firmware or software upgrades.

Upon notification by the manufacturer, the Department agrees not to divulge any proprietary or otherwise confidential information contained in the above required documentation. The Transportation Mobility and Safety Division of NCDOT agrees to protect and secure any proprietary documentation identified by the manufacturer as proprietary or confidential. Upon request by the manufacturer, Transportation Mobility and Safety Division of NCDOT agrees to sign a binding non-disclosure agreement with the manufacturer or other business that is providing documentation it considers proprietary or otherwise confidential.

**8.11. MEASUREMENT AND PAYMENT**

There will be no direct payment for the work covered by this section.

Payment for this work will be covered in the applicable sections of these Project Special Provisions at the contract unit price for “DMS” and will be full compensation for all work covered in this section.

**Project Special Provisions  
Structures  
Table of Contents**

<b>Special Provision</b>		<b>Page</b>
Scope of Work		BP-2
Submittal of Working Drawings	(2-14-22)	BP-2
Falsework and Formwork	(2-14-22)	BP-8
Crane Safety	(6-20-19)	BP-14
Grout for Structures	(12-1-17)	BP-15
Overlay Surface Preparation for Polymer Concrete	(SPECIAL)	BP-16
Polymer Concrete Bridge Deck Overlay	(SPECIAL)	BP-22
Pourable Silicone Joint Sealant	(SPECIAL)	BP-35
Concrete Work for Joint Replacement	(2-11-19)	BP-37
Strip Seals for Preservation	(08-08-22)	BP-40
Painting Existing Structure	(2-11-19)	BP-45
Concrete for Deck Repair	(2-11-19)	BP-58
Epoxy Resin Injection	(08-08-22)	BP-59
Shotcrete Repairs	(08-08-22)	BP-64
Concrete Repairs	(2-11-19)	BP-68
Volumetric Mixer	(12-18-12)	BP-71
Bridge Jacking	(SPECIAL)	BP-73
Railroad Site Data		BP-74
Norfolk Southern - Special Provisions for Protection of Railway Interests		BP-75
Slope Protection Void Filling	(SPECIAL)	BP-96
Thermal Sprayed Coatings (Metallization)	(12-1-17)	BP-97



**STRUCTURE PROJECT SPECIAL PROVISIONS****SCOPE OF WORK**

This work shall consist of furnishing all labor, equipment, and materials to overlay the existing bridge deck with Polymer Concrete, repair substructure, clean and paint structural steel as directed in the plans. Work includes: portable lighting; existing superstructure bridge deck surface preparation; overlaying the prepared bridge decks with Polymer Concrete (PC); existing joint removal and reconstruction; installation of strip seal joints seals; substructure repair using shotcrete, epoxy resin injection and epoxy coating; removal, containment, and disposal of the existing structural steel paint system; preparation of the surface to be painted and application of the new structural steel paint system; disposal of demolition and waste material; seeding and mulching all grassed areas disturbed; and all incidental items necessary to complete the project as specified and shown on the plans. No separate measurement or payment will be made for seeding, mulching or any measures required to control erosion or prevent off-site sedimentation. The cost of this work shall be included in the lump sum price bid for Mobilization.

Work will be performed on the existing bridge at the following locations in Johnston County:

1. Bridge #500106 – I-95 NBL over SR1927/SR2305/Norfolk Southern Railroad
2. Bridge #500107 – I-95 SBL over SR1927/SR2305/ Norfolk Southern Railroad

The contractor shall provide all necessary access; underdeck platforms, scaffolding, ladders, etc.; provide all traffic control; provide all staging areas, material storage, waste disposal; provide environmental controls to limit loss of materials from sawing equipment, and chipping equipment; and all else necessary to complete the work.

The contractor shall be responsible for fulfilling all requirements of the NCDOT Standard Specifications for Roads and Structures dated January 2018, except as otherwise specified herein.

**SUBMITTAL OF WORKING DRAWINGS****(2-14-22)****1.0 GENERAL**

Submit working drawings in accordance with Article 105-2 of the *Standard Specifications* and this provision. For this provision, “submittals” refers to only those listed in this provision. The list of submittals contained herein does not represent a list of required submittals for the project. Submittals are only necessary for those items as required by the contract. Make submittals that are not specifically noted in this provision directly to the Engineer. Either the Structures Management Unit or the Geotechnical Engineering Unit or both units will jointly review submittals.

If a submittal contains variations from plan details or specifications or significantly affects project cost, field construction or operations, discuss the submittal with and submit all copies to the Engineer. State the reason for the proposed variation in the submittal. To minimize review time, make sure all submittals are complete when initially submitted. Provide a contact name and information with each submittal. Direct any questions regarding submittal requirements to the Engineer, Structures Management Unit contacts or the Geotechnical Engineering Unit contacts noted below.

To facilitate in-plant inspection by NCDOT and approval of working drawings, provide the name, address and telephone number of the facility where fabrication will actually be done if different than shown on the title block of the submitted working drawings. This includes, but is not limited to, precast concrete items, prestressed concrete items and fabricated steel or aluminum items.

## 2.0 ADDRESSES AND CONTACTS

For submittals to the Structures Management Unit, use the following addresses:

Via Email: [SMU-wdr@ncdot.gov](mailto:SMU-wdr@ncdot.gov) (do not cc SMU Working Drawings staff)

Via US mail:

Mr. B. C. Hanks, P. E.  
State Structures Engineer  
North Carolina Department  
of Transportation  
Structures Management Unit  
1581 Mail Service Center  
Raleigh, NC 27699-1581

Attention: Mr. J. L. Bolden, P. E.

Via other delivery service:

Mr. B. C. Hanks, P. E.  
State Structures Engineer  
North Carolina Department  
of Transportation  
Structures Management Unit  
1000 Birch Ridge Drive  
Raleigh, NC 27610

Attention: Mr. J. L. Bolden, P. E.

For submittals to the Geotechnical Engineering Unit, use the following addresses:

For projects in Divisions 1-7, use the following Eastern Regional Office addresses:

Via Email: [EastGeotechnicalSubmittal@ncdot.gov](mailto:EastGeotechnicalSubmittal@ncdot.gov)

Via US mail:

Mr. David Hering, L.G., P. E.  
Assistant State Geotechnical  
Engineer – Eastern Region  
North Carolina Department  
of Transportation  
Geotechnical Engineering Unit  
Eastern Regional Office  
1570 Mail Service Center

Via other delivery service:

Mr. David Hering, L.G., P. E.  
Assistant State Geotechnical  
Engineer – Eastern Region  
North Carolina Department  
of Transportation  
Geotechnical Engineering Unit  
Eastern Regional Office  
3301 Jones Sausage Road, Suite 100

Raleigh, NC 27699-1570

Garner, NC 27529

For projects in Divisions 8-14, use the following Western Regional Office addresses:

Via Email: [WestGeotechnicalSubmittal@ncdot.gov](mailto:WestGeotechnicalSubmittal@ncdot.gov)

Via US mail or other delivery service:

Mr. Eric Williams, P. E.  
Assistant State Geotechnical  
Engineer – Western Region  
North Carolina Department  
of Transportation  
Geotechnical Engineering Unit  
Western Regional Office  
5253 Z Max Boulevard  
Harrisburg, NC 28075

The status of the review of structure-related submittals sent to the Structures Management Unit can be viewed from the Unit's website, via the "[Drawing Submittal Status](#)" link.

The status of the review of geotechnical-related submittals sent to the Geotechnical Engineering Unit can be viewed from the Unit's website, via the "[Geotechnical Construction Submittals](#)" link.

Direct any questions concerning submittal review status, review comments or drawing markups to the following contacts:

Primary Structures Contact: James Bolden (919) 707 – 6408  
[jlbolden@ncdot.gov](mailto:jlbolden@ncdot.gov)

Secondary Structures Contacts: Emmanuel Omile (919) 707 – 6451  
[eomile@ncdot.gov](mailto:eomile@ncdot.gov)

Madonna Rorie (919) 707 – 6508  
[mrorie@ncdot.gov](mailto:mrorie@ncdot.gov)

Eastern Regional Geotechnical Contact (Divisions 1-7):  
David Hering (919) 662 – 4710  
[dthering@ncdot.gov](mailto:dthering@ncdot.gov)

Western Regional Geotechnical Contact (Divisions 8-14):  
Eric Williams (704) 455 – 8902  
[ewilliams3@ncdot.gov](mailto:ewilliams3@ncdot.gov)

**3.0 SUBMITTAL COPIES**

Furnish one complete copy of each submittal, including all attachments, to the Engineer. At the same time, submit a copy of the same complete submittal directly to the Structures Management Unit and/or the Geotechnical Engineering Unit as specified in the tables below.

The first table below covers “Structure Submittals.” The Engineer will receive review comments and drawing markups for these submittals from the Structures Management Unit. The second table in this section covers “Geotechnical Submittals.” The Engineer will receive review comments and drawing markups for these submittals from the Geotechnical Engineering Unit.

Unless otherwise required, submit one set of supporting calculations to either the Structures Management Unit or the Geotechnical Engineering Unit unless both units require submittal copies in which case submit a set of supporting calculations to each unit. Provide additional copies of any submittal as directed.

**STRUCTURE SUBMITTALS**

<b>Submittal</b>	<b>Submittal Required by Structures Management Unit?</b>	<b>Submittal Required by Geotechnical Engineering Unit?</b>	<b>Contract Reference Requiring Submittal <sup>1</sup></b>
Arch Culvert Falsework	Y	N	Plan Note, SN Sheet & “Falsework and Formwork”
Box Culvert Falsework <sup>7</sup>	Y	N	Plan Note, SN Sheet & “Falsework and Formwork”
Cofferdams	Y	Y	Article 410-4
Foam Joint Seals <sup>6</sup>	Y	N	“Foam Joint Seals”
Expansion Joint Seals (hold down plate type with base angle)	Y	N	“Expansion Joint Seals”
Expansion Joint Seals (modular)	Y	N	“Modular Expansion Joint Seals”
Expansion Joint Seals (strip seals)	Y	N	“Strip Seal Expansion Joints”
Falsework & Forms <sup>2</sup> (substructure)	Y	N	Article 420-3 & “Falsework and Formwork”

HI-0008

BP-6

Johnston County

Falsework & Forms (superstructure)	Y	N	Article 420-3 & “Falsework and Formwork”
Girder Erection over Railroad	Y	N	Railroad Provisions
Maintenance and Protection of Traffic Beneath Proposed Structure	Y	N	“Maintenance and Protection of Traffic Beneath Proposed Structure at Station ____”
Metal Bridge Railing	Y	N	Plan Note
Metal Stay-in-Place Forms	Y	N	Article 420-3
Metalwork for Elastomeric Bearings <sup>4,5</sup>	Y	N	Article 1072-8
Miscellaneous Metalwork <sup>4,5</sup>	Y	N	Article 1072-8
Disc Bearings <sup>4</sup>	Y	N	“Disc Bearings”
Overhead and Digital Message Signs (DMS) (metalwork and foundations)	Y	N	Applicable Provisions
Placement of Equipment on Structures (cranes, etc.)	Y	N	Article 420-20
Prestressed Concrete Box Beam (detensioning sequences) <sup>3</sup>	Y	N	Article 1078-11
Precast Concrete Box Culverts	Y	N	“Optional Precast Reinforced Concrete Box Culvert at Station ____”
Prestressed Concrete Cored Slab (detensioning sequences) <sup>3</sup>	Y	N	Article 1078-11
Prestressed Concrete Deck Panels	Y	N	Article 420-3
Prestressed Concrete Girder (strand elongation and detensioning sequences)	Y	N	Articles 1078-8 and 1078- 11
Removal of Existing Structure over Railroad	Y	N	Railroad Provisions
<hr/>			
Revised Bridge Deck Plans (adaptation to prestressed deck panels)	Y	N	Article 420-3



HI-0008

**BP-7**

Johnston County

Revised Bridge Deck Plans (adaptation to modular expansion joint seals)	Y	N	“Modular Expansion Joint Seals”
Sound Barrier Wall (precast items)	Y	N	Article 1077-2 & “Sound Barrier Wall”
Sound Barrier Wall Steel Fabrication Plans <sup>5</sup>	Y	N	Article 1072-8 & “Sound Barrier Wall”
Structural Steel <sup>4</sup>	Y	N	Article 1072-8
Temporary Detour Structures	Y	Y	Article 400-3 & “Construction, Maintenance and Removal of Temporary Structure at Station _____”
TFE Expansion Bearings <sup>4</sup>	Y	N	Article 1072-8

**FOOTNOTES**

1. References are provided to help locate the part of the contract where the submittals are required. References in quotes refer to the provision by that name. Articles refer to the *Standard Specifications*.
2. Submittals for these items are necessary only when required by a note on plans.
3. Submittals for these items may not be required. A list of pre-approved sequences is available from the producer or the Materials & Tests Unit.
4. The fabricator may submit these items directly to the Structures Management Unit.
5. The two sets of preliminary submittals required by Article 1072-8 of the *Standard Specifications* are not required for these items.
6. Submittals for Fabrication Drawings are not required. Submittals for Catalogue Cuts of Proposed Material are required. See Section 5.A of the referenced provision.
7. Submittals are necessary only when the top slab thickness is 18” or greater.

**GEOTECHNICAL SUBMITTALS**

Submittal	Submittals Required by Geotechnical	Submittals Required by Structures	Contract Reference Requiring Submittal <sup>1</sup>
-----------	---	---	--

	<b>Engineering Unit</b>	<b>Management Unit</b>	
Drilled Pier Construction Plans <sup>2</sup>	Y	N	Subarticle 411-3(A)
Crosshole Sonic Logging (CSL) Reports <sup>2</sup>	Y	N	Subarticle 411-5(A)(2)
Pile Driving Equipment Data Forms <sup>2,3</sup>	Y	N	Subarticle 450-3(D)(2)
Pile Driving Analyzer (PDA) Reports <sup>2</sup>	Y	N	Subarticle 450-3(F)(3)
Retaining Walls <sup>4</sup>	Y; drawings and calculations	Y; drawings	Applicable Provisions
Temporary Shoring <sup>4</sup>	Y; drawings and calculations	Y; drawings	“Temporary Shoring” & “Temporary Soil Nail Walls”

**FOOTNOTES**

- References are provided to help locate the part of the contract where the submittals are required. References in quotes refer to the provision by that name. Subarticles refer to the *Standard Specifications*.
- Submit one hard copy of submittal to the Engineer. Submit a second copy of submittal electronically (PDF via email), US mail or other delivery service to the appropriate Geotechnical Engineering Unit regional office. Electronic submission is preferred.
- The Pile Driving Equipment Data Form is available from:  
[https://connect.ncdot.gov/resources/Geological/Pages/Geotech\\_Forms\\_Details.aspx](https://connect.ncdot.gov/resources/Geological/Pages/Geotech_Forms_Details.aspx)  
See second page of form for submittal instructions.
- Electronic copy of submittal is required. See referenced provision.

**FALSEWORK AND FORMWORK**

**(2-14-22)**

**1.0 DESCRIPTION**

Use this Special Provision as a guide to develop temporary works submittals required by the Standard Specifications or other provisions; no additional submittals are required herein. Such temporary works include, but are not limited to, falsework and formwork.

Falsework is any temporary construction used to support the permanent structure until it becomes self-supporting. Formwork is the temporary structure or mold used to retain plastic or fluid concrete in its designated shape until it hardens. Access scaffolding is a temporary structure that functions as a work platform that supports construction personnel, materials, and tools, but is not intended to support the structure. Scaffolding systems that are used to temporarily support permanent structures (as opposed to functioning as work platforms) are considered to be falsework under the definitions given. Shoring is a component of falsework such as horizontal, vertical, or inclined support members. Where the term “temporary works” is used, it includes all of the temporary facilities used in bridge construction that do not become part of the permanent structure.

Design and construct safe and adequate temporary works that will support all loads imposed and provide the necessary rigidity to achieve the lines and grades shown on the plans in the final structure.

## **2.0 MATERIALS**

Select materials suitable for temporary works; however, select materials that also ensure the safety and quality required by the design assumptions. The Engineer has authority to reject material on the basis of its condition, inappropriate use, safety, or nonconformance with the plans. Clearly identify allowable loads or stresses for all materials or manufactured devices on the plans. Revise the plan and notify the Engineer if any change to materials or material strengths is required.

## **3.0 DESIGN REQUIREMENTS**

### **A. Working Drawings**

Provide working drawings for items as specified in the contract, or as required by the Engineer, with design calculations and supporting data in sufficient detail to permit a structural and safety review of the proposed design of the temporary work.

On the drawings, show all information necessary to allow the design of any component to be checked independently as determined by the Engineer.

When concrete placement is involved, include data such as the drawings of proposed sequence, rate of placement, direction of placement, and location of all construction joints.

When required, have the drawings and calculations prepared under the guidance of, and sealed by, a North Carolina Registered Professional Engineer who is knowledgeable in temporary works design.

If requested by the Engineer, submit with the working drawings manufacturer’s catalog data listing the weight of all construction equipment that will be supported on the temporary work. Show anticipated total settlements and/or deflections of falsework and forms on the working drawings. Include falsework footing settlements, joint take-up, and deflection of beams or girders.

As an option for the Contractor, overhang falsework hangers may be uniformly spaced, at a maximum of 36 inches, provided the following conditions are met:

Member Type (PCG)	Member Depth, (inches)	Max. Overhang Width, (inches)	Max. Slab Edge Thickness, (inches)	Max. Screed Wheel Weight, (lbs.)	Bracket Min. Vertical Leg Extension, (inches)
II	36	39	14	2000	26
III	45	42	14	2000	35
IV	54	45	14	2000	44
MBT	63	51	12	2000	50
MBT	72	55	12	1700	48

Overhang width is measured from the centerline of the girder to the edge of the deck slab. For Type II, III & IV prestressed concrete girders (PCG), 45-degree cast-in-place half hangers and rods must have a minimum safe working load of 6,000 lbs.

For MBT prestressed concrete girders, 45-degree angle holes for falsework hanger rods shall be cast through the girder top flange and located, measuring along the top of the member, 1'-2 1/2" from the edge of the top flange. Hanger hardware and rods must have a minimum safe working load of 6,000 lbs.

For links slabs, the tops of girders directly beneath the link slab shall be free of overhang falsework attachments or other hardware. Submit calculations and working drawings for overhang falsework in the link slab region.

The overhang bracket provided for the diagonal leg shall have a minimum safe working load of 3,750 lbs. The vertical leg of the bracket shall extend to the point that the heel bears on the girder bottom flange, no closer than 4 inches from the bottom of the member. However, for 72-inch members, the heel of the bracket shall bear on the web, near the bottom flange transition.

Provide adequate overhang falsework and determine the appropriate adjustments for deck geometry, equipment, casting procedures and casting conditions.

If the optional overhang falsework spacing is used, indicate this on the falsework submittal and advise the girder producer of the proposed details. Failure to notify the Engineer of hanger type and hanger spacing on prestressed concrete girder casting drawings may delay the approval of those drawings.

Falsework hangers that support concentrated loads and are installed at the edge of thin top flange concrete girders (such as bulb tee girders) shall be spaced so as not to exceed 75% of the manufacturer's stated safe working load. Use of dual leg hangers (such as Meadow Burke HF-42 and HF-43) are not allowed on concrete girders with thin top flanges. Design the falsework and forms supporting deck slabs and overhangs on girder bridges so that there will be no differential settlement between the girders and the deck forms during placement of deck concrete.

When staged construction of the bridge deck is required, detail falsework and forms for screed and fluid concrete loads to be independent of any previous deck pour components when the mid-span girder deflection due to deck weight is greater than 3/4".

Note on the working drawings any anchorages, connectors, inserts, steel sleeves or other such devices used as part of the falsework or formwork that remains in the permanent structure. If the plan notes indicate that the structure contains the necessary corrosion protection required for a Corrosive Site, epoxy coat, galvanize or metalize these devices. Electroplating will not be allowed. Any coating required by the Engineer will be considered incidental to the various pay items requiring temporary works.

Design falsework and formwork requiring submittals in accordance with the 1995 AASHTO *Guide Design Specifications for Bridge Temporary Works* except as noted herein.

1. Wind Loads

Table 2.2 of Article 2.2.5.1 is modified to include wind velocities up to 110 mph. In addition, Table 2.2A is included to provide the maximum wind speeds by county in North Carolina.

**Table 2.2 - Wind Pressure Values**

Height Zone feet above ground	Pressure, lb/ft <sup>2</sup> for Indicated Wind Velocity, mph				
	70	80	90	100	110
0 to 30	15	20	25	30	35
30 to 50	20	25	30	35	40
50 to 100	25	30	35	40	45
over 100	30	35	40	45	50

2. Time of Removal

The following requirements replace those of Article 3.4.8.2.

Do not remove forms until the concrete has attained strengths required in Article 420-16 of the Standard Specifications and these Special Provisions.

Do not remove forms until the concrete has sufficient strength to prevent damage to the surface.

**Table 2.2A - Steady State Maximum Wind Speeds by Counties in North Carolina**

COUNTY	25 YR (mph)	COUNTY	25 YR (mph)	COUNTY	25 YR (mph)
Alamance	70	Franklin	70	Pamlico	100
Alexander	70	Gaston	70	Pasquotank	100
Alleghany	70	Gates	90	Pender	100
Anson	70	Graham	80	Perquimans	100
Ashe	70	Granville	70	Person	70
Avery	70	Greene	80	Pitt	90
Beaufort	100	Guilford	70	Polk	80
Bertie	90	Halifax	80	Randolph	70
Bladen	90	Harnett	70	Richmond	70
Brunswick	100	Haywood	80	Robeson	80
Buncombe	80	Henderson	80	Rockingham	70
Burke	70	Hertford	90	Rowan	70
Cabarrus	70	Hoke	70	Rutherford	70
Caldwell	70	Hyde	110	Sampson	90
Camden	100	Iredell	70	Scotland	70
Carteret	110	Jackson	80	Stanley	70
Caswell	70	Johnston	80	Stokes	70
Catawba	70	Jones	100	Surry	70
Cherokee	80	Lee	70	Swain	80
Chatham	70	Lenoir	90	Transylvania	80
Chowan	90	Lincoln	70	Tyrell	100
Clay	80	Macon	80	Union	70
Cleveland	70	Madison	80	Vance	70
Columbus	90	Martin	90	Wake	70
Craven	100	McDowell	70	Warren	70
Cumberland	80	Mecklenburg	70	Washington	100
Currituck	100	Mitchell	70	Watauga	70
Dare	110	Montgomery	70	Wayne	80
Davidson	70	Moore	70	Wilkes	70
Davie	70	Nash	80	Wilson	80
Duplin	90	New Hanover	100	Yadkin	70
Durham	70	Northampton	80	Yancey	70
Edgecombe	80	Onslow	100		
Forsyth	70	Orange	70		

## B. Review and Approval

The Engineer is responsible for the review and approval of temporary works' drawings.

Submit the working drawings sufficiently in advance of proposed use to allow for their review, revision (if needed), and approval without delay to the work.

The time period for review of the working drawings does not begin until complete drawings and design calculations, when required, are received by the Engineer.

Do not start construction of any temporary work for which working drawings are required until the drawings have been approved. Such approval does not relieve the Contractor of the responsibility for the accuracy and adequacy of the working drawings.

## 4.0 CONSTRUCTION REQUIREMENTS

All requirements of Section 420 of the Standard Specifications apply.

Construct temporary works in conformance with the approved working drawings. Ensure that the quality of materials and workmanship employed is consistent with that assumed in the design of the temporary works. Do not weld falsework members to any portion of the permanent structure unless approved. Show any welding to the permanent structure on the approved construction drawings.

Provide tell-tales attached to the forms and extending to the ground, or other means, for accurate measurement of falsework settlement. Make sure that the anticipated compressive settlement and/or deflection of falsework does not exceed 1 inch. For cast-in-place concrete structures, make sure that the calculated deflection of falsework flexural members does not exceed 1/240 of their span regardless of whether or not the deflection is compensated by camber strips.

### A. Maintenance and Inspection

Inspect and maintain the temporary work in an acceptable condition throughout the period of its use. Certify that the manufactured devices have been maintained in a condition to allow them to safely carry their rated loads. Clearly mark each piece so that its capacity can be readily determined at the job site.

Perform an in-depth inspection of an applicable portion(s) of the temporary works, in the presence of the Engineer, not more than 24 hours prior to the beginning of each concrete placement. Inspect other temporary works at least once a month to ensure that they are functioning properly. Have a North Carolina Registered Professional Engineer inspect the cofferdams, shoring, sheathing, support of excavation structures, and support systems for load tests prior to loading.

**B. Foundations**

Determine the safe bearing capacity of the foundation material on which the supports for temporary works rest. If required by the Engineer, conduct load tests to verify proposed bearing capacity values that are marginal or in other high-risk situations.

The use of the foundation support values shown on the contract plans of the permanent structure is permitted if the foundations are on the same level and on the same soil as those of the permanent structure.

Allow for adequate site drainage or soil protection to prevent soil saturation and washout of the soil supporting the temporary works supports.

If piles are used, the estimation of capacities and later confirmation during construction using standard procedures based on the driving characteristics of the pile is permitted. If preferred, use load tests to confirm the estimated capacities; or, if required by the Engineer conduct load tests to verify bearing capacity values that are marginal or in other high risk situations.

The Engineer reviews and approves the proposed pile and soil bearing capacities.

**5.0 REMOVAL**

Unless otherwise permitted, remove and keep all temporary works upon completion of the work. Do not disturb or otherwise damage the finished work.

Remove temporary works in conformance with the contract documents. Remove them in such a manner as to permit the structure to uniformly and gradually take the stresses due to its own weight.

**6.0 METHOD OF MEASUREMENT**

Unless otherwise specified, temporary works will not be directly measured.

**7.0 BASIS OF PAYMENT**

Payment at the contract unit prices for the various pay items requiring temporary works will be full compensation for the above falsework and formwork.

**CRANE SAFETY****(6-20-19)**

Comply with the manufacturer specifications and limitations applicable to the operation of any and all cranes and derricks. Prime contractors, sub-contractors, and fully operated rental companies shall comply with the current Occupational Safety and Health Administration (OSHA) regulations.



Submit all items listed below to the Engineer prior to beginning crane operations. Changes in personnel or equipment must be reported to the Engineer and all applicable items listed below must be updated and submitted prior to continuing with crane operations.

#### **CRANE SAFETY SUBMITTAL LIST**

- A. **Competent Person:** Provide the name and qualifications of the “Competent Person” responsible for crane safety and lifting operations. The named competent person will have the responsibility and authority to stop any work activity due to safety concerns.
- B. **Riggers:** Provide the qualifications and experience of the persons responsible for rigging operations. Qualifications and experience should include, but not be limited to, weight calculations, center of gravity determinations, selection and inspection of sling and rigging equipment, and safe rigging practices.
- C. **Crane Inspections:** Inspection records for all cranes shall be current and readily accessible for review upon request.
- D. **Certifications:** Crane operators shall be certified by the National Commission for the Certification of Crane Operators (NCCCO) or the National Center for Construction Education and Research (NCCER). Other approved nationally accredited programs will be considered upon request. In addition, crane operators shall have a current CDL medical card. Submit a list of crane operator(s) and include current certification for each type of crane operated (small hydraulic, large hydraulic, small lattice, large lattice) and medical evaluations for each operator.

#### **GROUT FOR STRUCTURES**

**(12-1-17)**

#### **DESCRIPTION**

This special provision addresses grout for use in pile blockouts, grout pockets, shear keys, dowel holes and recesses for structures. This provision does not apply to grout placed in post-tensioning ducts for bridge beams, girders, decks, end bent caps, or bent caps. Mix and place grout in accordance with the manufacturer’s recommendations, the applicable sections of the Standard Specifications and this provision.

#### **MATERIAL REQUIREMENTS**

Unless otherwise noted on the plans, use a Type 3 Grout in accordance with Section 1003 of the Standard Specifications.

Initial setting time shall not be less than 10 minutes when tested in accordance with ASTM C266.

Construction loading and traffic loading shall not be allowed until the 3 day compressive strength is achieved.

#### **SAMPLING AND PLACEMENT**

Place and maintain components in final position until grout placement is complete and accepted. Concrete surfaces to receive grout shall be free of defective concrete, laitance, oil, grease and other foreign matter. Saturate concrete surfaces with clean water and remove excess water prior to placing grout.

#### **BASIS OF PAYMENT**

No separate payment will be made for “Grout for Structures”. The cost of the material, equipment, labor, placement, and any incidentals necessary to complete the work shall be considered incidental to the structure item requiring grout.

#### **OVERLAY SURFACE PREPARATION FOR POLYMER CONCRETE**

**(SPECIAL)**

#### **DESCRIPTION**

This special provision addresses the surface preparation activities required prior to the placement of polymer concrete (PC). Unless specifically mentioned below, all requirements specified for the bridge deck are also required for the approach slabs.

Work includes: removal of unsound and sound bridge deck concrete and existing patches in deck repair areas; preparation of repair areas prior to placement of PC bridge deck repair material; bridge deck surface preparation prior to placement of PC overlay; and any incidentals necessary to prepare the bridge deck for placement of PC repair material or PC overlay, as specified or as shown on the plans.

#### **DEFINITIONS**

Scarification shall consist of the removal of any asphalt wearing surface and concrete surface to the uniform depth and limits shown on the plans.

Shotblasting shall consist of steel beads (or other materials as approved by the Engineer) “shot” out of a machine onto the bridge concrete deck concrete floor to remove soft or deteriorated concrete, and to clean the concrete deck surface for the application of the PC overlay. Contractor shall vary the speed of the shotblaster or make multiple passes, as necessary, to achieve the required surface preparation for the PC overlay. Areas inaccessible with shotblasting equipment may require surface preparation with sandblasting equipment and hand equipment.

#### **EQUIPMENT**

All equipment for cleaning the existing concrete surface and mixing and applying the overlay system shall be in accordance with the System Provider’s recommendations, as approved by the Engineer prior to commencement of any work:

- (A) Scarifying equipment that is a power-operated, mechanical grinder capable of removing a minimum depth of ¼” for each pass.
- (B) Shotblasting and sandblasting equipment to adequately prepare the bridge deck substrate, as required in this special provision. Provide equipment to supply oil-free and moisture-free compressed air for final surface preparation.
- (C) Equipment capable of sawing concrete to the specified plan depth.
- (D) Power driven hand tools for removal of unsound concrete are required that meet the following requirements:
  - (1) Pneumatic hammers weighing a nominal 15 lbs. or less.
  - (2) Pneumatic hammer chisel-type bits that do not exceed the diameter of the shaft in width.
- (E) Hand tools, such as hammers and chisels, for removal of final particles of unsound concrete.
- (F) Self-propelled vacuum capable of picking up dust and other loose material from prepared deck surface.
- (G) Equipment to supply oil-free and moisture-free compressed air for final surface preparation.

The equipment must operate at a noise level less than 90 decibels at a distance of 50 feet.

#### **MANAGEMENT AND DISPOSAL OF CONCRETE DEBRIS**

All concrete debris shall become the property of the Contractor. The contractor shall be responsible for disposing of all debris generated by scarification, shotblasting, sandblasting, and any other surface preparation operations, in compliance with applicable regulations concerning such disposal.

All costs associated with management and disposal of all debris shall be included in the payment of other items.

#### **OSP PLAN SUBMITTAL**

Prior to beginning surface preparation activities, the Contractor shall submit for review and approval the Overlay Surface Preparation (OSP) Plan. The OSP Plan shall detail the type of equipment that is intended to be used and the means by which the Contractor will achieve the following requirements:

- (A) Estimate depth of reinforcing steel.
- (B) Scarification of deck to depth required.
- (C) Measure depth of scarification to show completed within limits.
- (D) Measure depth of shotblasting to show completed within limits.

The OSP Plan shall also include a schedule showing lane closures with estimated amount of bridge deck to be scarified, anticipated areas of Class II/III to be repaired and PC to be placed within that lane closure time. The Contractor should assume that any surface that is scarified shall be covered with the proper PC overlay before traffic is returned to the bridge deck, unless otherwise approved by the Engineer. The Contractor may propose traffic to be allowed on scarified bridge deck surfaces provided that the surface and joints are found to be structurally sound after scarification and a smooth transition is provided at the leading and trailing ends and

throughout the bridge surface. The duration between bridge deck scarification and PC placement shall be specified by the Engineer. The number of bridges, if any, that can be scarified in advance of PC placement shall be specified by the Engineer. Any additional approach work required to provide a smooth transition to the scarified surface before opening to traffic is incidental to the other items of work. The OSP plan shall clearly show the Contractor's intended plan and order of scarifying and placing PC on all bridges with associated timeframes. The OSP plan and associated scarification timeframes must be approved by the Engineer prior to starting any surface preparation operations.

### **SURFACE PREPARATION**

Prior to any construction, take the necessary precautions to ensure debris from bridge deck preparation and repairs is not allowed to fall below the bridge deck.

Remove all existing asphalt overlays and all loose, disintegrated, unsound or contaminated concrete to the limits shown on the plans with the following requirements.

During surface preparation, precaution shall be taken to assure that traffic is protected from rebound, dust, and construction activities. Appropriate shielding shall be provided as required and directed by the Engineer. During surface preparation, the Contractor shall provide suitable coverings, as needed to protect all exposed areas not to receive overlay, such as curbs, sidewalks, parapets, etc. All damage or defacement resulting from surface preparation shall be repaired to the Engineer's satisfaction at no additional cost to the Department.

(A) Sealing of Bridge Deck: Seal all expansion joints subject to run-off water from the scarification, shotblasting, and PC placement process with material approved by the Engineer, prior to beginning any demolition. The expansion joints shall remain sealed until it has been determined that water and materials from the scarification, shotblasting, and PC placement operations cannot be discharged through them any longer. Take all steps necessary to eliminate the flow of water or materials through the expansion joints, and any other locations water or materials could leak from the deck.

All deck drains in the immediate work area and other sections of the bridge affected by the work being performed shall be sealed prior to beginning scarification. Drains shall remain sealed until it has been determined that water and materials from the scarification, shotblasting, and PC placement operations cannot be discharged through them any longer.

(B) Scarifying Bridge Deck: Remove any asphalt wearing surface from the bridge deck and scarify the concrete deck to remove the entire concrete surface of the deck to the uniform depth and limits shown on the plans.

It will be the Contractor's responsibility to determine amount of cover for the reinforcing steel. Use a pachometer or other approved device, as approved by Engineer, prior to scarification. Readings shall be read and recorded in the presence of the Engineer. Readings shall be recorded for each span at 1/5 points longitudinally and 1/3 points transversely. The cost for this work will be considered incidental to the cost of surface preparation of the bridge deck.

#### **Estimated average cover to top mat:**

**Bridge Number: 2 1/2" +/- 1/4"**

The above top mat cover dimensions are an estimate based on the best available information. Calibrate scarifying equipment in order to avoid damaging the reinforcing steel in the bridge floor or the approach slab. Care shall be taken not to cut, stretch, or damage any exposed

reinforcing steel. If reinforcing bars or bridge drainage devices are pulled up or snagged during scarification operations, cease work and consult with the Engineer to determine any necessary adjustments to the roto-milling operation.

Remove and dispose of all concrete and asphalt, and thoroughly clean the scarified surface. In areas where reinforcing steel is located in the depth to be scarified, use another method with the Engineer's approval.

The Engineer will re-inspect after each removal and require additional removals until compliance with plans and specifications are met.

Regardless of the method of removal, the removal operation shall be stopped if it is determined that sound concrete is being removed to a depth greater than required by the plans.

- (C) Class II Surface Preparation (Partial Depth): At locations specified on the plans or identified by the Engineer for Class II Surface Preparation, verify the depth of removal achieved by the scarification. Remove by additional scarification or chipping with hand tools all existing patches and unsound concrete. No additional payment will be made for Class II Surface Preparation depths achieved by the initial scarification.

All patches shall be removed under Class II Surface Preparation. If any patch cannot be removed by means of scarification, the Contractor shall use hand tools to remove the patch. Areas indicated on the plans that require Class II Surface Preparation, including the locations of existing patches, are from the best information available. The Contractor shall verify prior to surface preparation the location of all existing patches.

Spalled or unsound areas of the deck not removed by scarification shall be removed to sound concrete at locations noted in the contract plans or as directed by the Engineer. Remove existing spalled or unsound areas of the bridge concrete deck by methods approved by the Engineer.

Provide a 1" deep saw cut around the perimeter of areas noted for bridge deck or patch removal. Remove, using the type of tools listed above, all concrete or patch material within the sawcut to a minimum depth of 1" and as necessary to remove unsound concrete. All loose and unsound concrete or patch material shall be removed.

Thoroughly clean the newly exposed surface to be free of all grease, oil, curing compounds, acids, dirt, or loose debris in accordance with this special provision.

Dispose of the removed concrete, clean, repair or replace rusted or loose reinforcing steel, and thoroughly clean the newly exposed surface. Care shall be taken not to cut, stretch, or damage any exposed reinforcing steel.

In overhangs, removing concrete areas of less than 0.60 ft<sup>2</sup>/ft length of bridge without overhang support is permitted unless the Engineer directs otherwise. Overhang support is required for areas removed greater than 0.60 ft<sup>2</sup>/ft length of bridge. Submit details of overhang support to the Engineer for approval prior to beginning the work.

- (D) Class III Surface Preparation (Full Depth): At locations specified on the plans or identified by the Engineer for Class III Surface Preparation, remove the concrete by chipping with hand tools the full depth of slab. Dispose of the removed concrete, clean, repair or replace

damaged reinforcing steel and thoroughly clean the newly exposed surface. Care shall be taken not to cut, stretch, or damage any exposed reinforcing steel.

For areas of less than 3 ft<sup>2</sup>, suspending forms from existing reinforcing steel using wire ties is permitted. For larger areas, support forms by blocking from the beam flanges, or other approved method.

Overhang support is required for full depth removal adjacent to bridge rails. Submit details of overhang support to the Engineer for approval prior to beginning the work.

- (E) Preparation of Reinforcing Steel: Remove concrete without cutting or damaging existing steel unless otherwise noted in the plans. Clean, repair, or replace rusted or loose reinforcing steel. Damaged reinforcing steel, such as bars with nicks deeper than 20% of the bar diameter, shall be repaired or replaced. Reinforcing steel which has a cross section reduced to 75% or less shall be replaced with new reinforcing steel of similar cross section area. Replacement bars shall be Grade 60 and meet the material requirements of Section 1070 of the *Standard Specifications*.

Replacement bars shall be spliced to existing bars using either minimum 30 bar diameter lap splices to existing steel with 100% cross sectional area or approved mechanical connectors.

For reinforcing steel left unsupported by the concrete removal process, support and protect the exposed reinforcing steel against displacement and damage from loads, such as those caused by removal equipment and delivery buggies. All reinforcing steel damaged or dislodged by these operations shall be replaced with bars of the same size at the contractor's expense.

Reinforcing steel exposed and satisfactorily cleaned and prepared will not require additional cleaning, if encased in concrete within seven (7) days. Rebar exposed for more than seven (7) days shall be satisfactorily cleaned and prepared, prior to placement of the new concrete. The satisfactory cleanliness and preparation of the reinforcing steel shall be determined by the Engineer.

When large areas of the deck on composite bridges are removed resulting in the debonding of the primary reinforcing bars, the removal shall be performed in stages to comply with the construction sequence shown on the plans or as directed by the Engineer.

- (F) Concrete Deck Repair: Repair and fill the Class II Surface Preparation areas of the existing bridge concrete deck prior to the final surface preparation and application of the PC overlay, at locations shown in the plans, or as determined by the Engineer, if necessary. Materials other than PC may be used for concrete deck repairs, but shall be approved by the PC System Provider's Technical Representative and shall be applied and prepared as required by the PC System Provider. For concrete deck repairs with PC:

- (1) Removal and surface preparation of the repair area shall be in accordance with and shall be paid for under pay items in this special provision.
- (2) Materials, equipment, placement, and finishing of PC used for concrete deck repairs shall meet the requirements of and shall be paid for under pay items in the Polymer Concrete Bridge Deck Overlay special provision.

PC repair material may be placed up to one (1) hour prior to overlay placement.

All repairs shall be placed and finished to match substrate deck grade prior to PC placement, in order to provide a uniform overlay thickness.

Concrete deck repairs with PC may be utilized as a stand-alone item where required on structures not to receive a PC overlay.

- (G) Surface Cleaning: The surface of concrete substrate and repaired areas shall be prepared for application of the overlay by shotblasting in order to remove all existing grease, slurry, oils, paint, dirt, striping, curing compound, rust, membrane, weak surface mortar, or any other contaminants that could interfere with the proper adhesion of the overlay system. The final prepared surface shall adhere to the following requirements:
- (1) If expansion joints are not being replaced or have been replaced prior to shotblasting they shall be protected from damage from the shotblasting operation. Deck drains and areas of curb or railing above the proposed surface shall be protected from the shotblasting operation.
  - (2) The areas to receive overlay shall be cleaned by shotblasting, or abrasive sandblasting in the event that the shotblaster cannot access areas to be prepared. Do not begin shotblasting until all grinding or milling operations are completed. Cleaning shall not commence until all work involving the repair of the concrete deck surface has been completed and the deck is dry. All contaminants shall be picked up and stored in the vacuum unit and no dust shall be created during the blasting operation that will obstruct the view of motorists in adjacent roadways. The travel speed and/or number of passes of the shotblasting unit shall be adjusted, so as to result in all weak or loose surface mortar being removed, aggregates within the concrete being exposed, and open pores in the concrete exposed, as well as a visible change in the concrete color. Cleaned surfaces shall not be exposed to vehicular traffic unless approved by the Engineer. If the deck becomes contaminated before placing the overlay, the Contractor shall shotblast or abrasive sandblast the contaminated areas to the satisfaction of the Engineer at no additional cost to the Department.
  - (3) Prior to the overlay placement, any loose particles shall be removed by magnets, oil free compressed air, and vacuuming, such that no trapped particles remain. Power washing will not be allowed.
  - (4) The areas to be overlaid shall be blown off with oil and moisture free compressed air just prior to placement of the primer and shall be completely dry.
  - (5) Cleaning methods other than those detailed by specification may be suggested by the PC System Provider and approved by the Engineer.
  - (6) All steel surfaces that will be in contact with the PC overlay shall be cleaned in accordance with Structural Steel Paint Council (SSPC) Surface Preparation (SP) No. 10, Near-White Blast Cleaning, except that wet blasting methods shall not be allowed.
- (H) Safety: Provide a containment system for handling expected and unexpected blow through of the deck. The containment system shall retain runoff water and debris and protect the area under the bridge deck. The Contractor shall be responsible for any injury or damage caused by these operations. The containment system shall remain in place until the concrete has been cast and attained minimum strength.

Provide adequate lighting when performing deck preparation activities at night. Submit a lighting plan to the Engineer for approval prior to beginning work.

**MEASUREMENT AND PAYMENT**

*Scarifying Bridge Deck* will be measured and paid for at the contract unit price per square yard and will be full compensation for the milling of existing asphalt wearing surface from the bridge deck and approaches, milling of the entire concrete bridge deck, repairing or replacing any damaged reinforcing steel, and the cleaning and disposal of all waste material generated.

*Shotblasting Bridge Deck* will be measured and paid for at the contract unit price per square yard and will be full compensation for the shotblasting and necessary sandblasting and handwork to prepare the entire concrete bridge deck and approaches, and removal and disposal of all waste material generated.

*Class II Surface Preparation* will be measured and paid for at the contract unit price per square yard and will be full compensation for Class II (partial depth) deck preparation where required by the plans. The cost will also include removal and disposal of unsound and contaminated concrete, removal of all existing patches, cleaning, repairing, or replacing of reinforcing steel, and all materials, labor, tools, equipment and incidentals necessary to complete the work.

*Class III Surface Preparation* will be measured and paid for at the contract unit price per square yard and will be full compensation for Class III (full depth) deck preparation and repair where required by the plans. The cost will also include removal and disposal of unsound and contaminated concrete, cleaning, repairing or replacing of reinforcing steel, under deck containment, placing and finishing concrete for full depth repair, and all materials, labor, tools, equipment and incidentals necessary to complete the work.

Reinforcing Steel that is required for the repairs will be in accordance with Section 425 of the *Standard Specifications*.

Payment will be made under:

**Pay Item**

Scarifying Bridge Deck  
 Shotblasting Bridge Deck  
 Class II Surface Preparation  
 Class III Surface Preparation

**Pay Unit**

Square Yard  
 Square Yard  
 Square Yard  
 Square Yard

**POLYMER CONCRETE BRIDGE DECK OVERLAY**

**(SPECIAL)**

**DESCRIPTION**

This work consists of furnishing and placing a Polymer Concrete (PC) overlay system with a resin primer on concrete surfaces. The surface of the concrete shall be prepared and the PC overlay system shall be applied in accordance with this special provision in conformity with the lines, grades, thickness, and typical cross-sections shown on the plans or as approved by the Engineer. Unless specifically mentioned below, all requirements specified for the bridge deck are also required for the approach slabs.



The Contractor shall select one of the PC overlay systems below:

- (A) Polyester Polymer Concrete (PPC) with a High Molecular Weight Methacrylate (HMWM) resin primer.
- (B) Epoxy Polymer Concrete (EPC) with an epoxy resin primer.

Work includes: placement of resin primer; placement of PC surface patching and/or overlay; and any incidentals necessary to complete the project as specified or as shown on the plans.

The System Provider is the manufacturer that will provide the PC system for the PC overlay. The System shall include the necessary and appropriate PC components, as well as the necessary and appropriate resin primer components. Contractor shall not change System Provider during project, without approval from the Engineer.

#### **QUALIFICATIONS AND SUBMITTALS**

The Contractor shall submit the following requested items and any other relevant documents at least two (2) weeks prior to the PC Overlay Pre-placement Conference. These submittals are for approval and shall be directed to the Engineer.

- (A) Overlay System: The Contractor shall submit two (2) copies of the System Provider's material information, written installation instructions, safety data sheets, and independent test results for approval.
- (B) System Provider Qualifications: The Contractor shall install an overlay system with all components provided through a single System Provider with documented experience successfully supplying at least five (5) PC overlay projects of similar size and scope installed within the past five (5) years. The Contractor shall submit documentation of the System Provider's project experience including the following:
  - (1) Project Location.
  - (2) Owner Agency.
  - (3) Project construction date.
  - (4) Overlay quantities.
  - (5) Reference name and contact information for owner representative.
- (C) Contractor Qualifications: The Contractor shall submit documentation of successful projects placing structural concrete bridge decks, modified concrete bridge deck overlays, or PC overlay systems to finished grade using similar equipment as specified herein within the past five (5) years. A minimum of two (2) employees on site must have the equivalent work experience qualifications of the Contractor. The documentation of Contractors qualifications shall include the following:
  - (1) Project Location.
  - (2) Owner Agency.
  - (3) Project construction date.
  - (4) Overlay quantities.
  - (5) Reference name and contact information for owner representative.
- (D) System Provider Technical Representative Qualifications: The System Provider Technical Representative shall be an employee of the PC overlay system manufacturer, have a minimum of five (5) successful PC overlay Projects within the last five (5) years, and be completely competent in all aspects of the work, including surface preparation, mixing, placement, curing,

and testing of the PC overlay system. The Technical Representative shall have experience on a minimum of five (5) successful projects of similar size and scope. The Contractor shall submit documentation of the System Provider Technical Representative's experience including the following:

- (1) Years of Experience with PC overlay systems
- (2) Project location
- (3) Project construction date
- (4) Overlay quantities
- (5) Reference name and contact information for owner representative

The Technical Representative shall be available on site, for a minimum of three (3) days per project, to give the installer advice and guidance on the installation of PC overlay systems. This includes, but is not limited to: deck concrete surface preparation, PC overlay materials, PC overlay application, PC overlay curing or any time there are questions or issues that may arise. The Technical Representative shall be on site for the first PC overlay placement and shall remain on site until the Engineer is satisfied with the PC overlay preparation, placement, and finishing operations.

(E) Overlay Placement Plan: The Contractor shall submit an Overlay Placement Plan that includes the following:

- (1) Schedule of overlay work and testing for each bridge.
- (2) Anticipated concrete deck repair locations and repair method.
- (3) Staging plan describing overlay placement sequence including:
  - (a) Construction joint locations. Longitudinal construction joints between passes shall be located along the centerline of travel lanes or edge of travel lanes.
  - (b) Sequence of placement.
  - (c) Placement widths.
  - (d) Anticipated placement lengths.
  - (e) Placement direction.
  - (f) Joint locations.
  - (g) Location of proposed trial overlay(s).
- (4) Description of equipment used for:
  - (a) Surface preparation including grinding and shotblasting.
  - (b) Applying resin primer.
  - (c) Measuring, mixing, placing, and finishing the PC overlay.
  - (d) Applying surface finish sand/fine aggregate.
- (5) Method of protecting and finishing inlets and bridge drains.
- (6) Method for isolating expansion joints.
- (7) Method for measuring and maintaining overlay thickness and profile.
- (8) Cure time for PC overlay.
- (9) Storage and handling of resin primer and PC overlay components.
- (10) Procedure for disposal of excess resin primer, PC overlay materials, and containers.
- (11) Procedure for cleanup of mixing and placement equipment.

(F) Equipment: The Contractor shall submit documentation of current certification that mixing equipment has been calibrated (Caltrans California test CT 109 or similar accepted). The

Contractor shall submit a documented history of the use of the placement equipment to successfully place PC overlays on bridge projects for review and approval by the Engineer.

**MATERIALS**

The Polymer Concrete shall consist of a resin binder and aggregate as specified below. It shall also include a compatible primer which when mixed with other specified ingredients and applied as specified herein, is capable of producing a Polymer Concrete meeting the requirements of this specification.

- (1) Verification. The Contractor shall submit a Certified Test Report from independent labs for all of the materials associated with the PC overlay in accordance with this special provision.
- (2) Packaging and Shipment. All components shall be shipped in strong, substantial containers, bearing the manufacturer’s label specifying batch/lot number, brand name, and quantity. If bulk resin is to be used, the contractor shall notify the Engineer in writing ten (10) working days prior to the delivery of the bulk resin to the job site. Bulk resin is any resin that is stored in containers in excess of 55 gallons.
- (3) Sampling. NCDOT reserves the right to retain and test samples of components of the PC overlay system. This includes requiring submittal of samples prior to the first installation or on-site sampling during construction.

Only use materials that are specified for the selected PC overlay system. Mixing materials from different PC overlay systems shall not be permitted.

(A) Polyester Polymer Concrete (PPC) materials shall consist of a polyester resin binder, a High Molecular Weight Methacrylate (HMWM) primer, and aggregate.

- (1) Polyester Resin Binder: Polyester resin binder shall have the following properties:
  - (a) Be an unsaturated isophthalic polyester-styrene co-polymer. The resin content shall be 12% +/-1% of the weight of the dry aggregate.
  - (b) Contain at least 1 percent by weight gamma-methacryloxypropyltrimethoxysilane, an organosilane ester silane coupler.
  - (c) Be used with a promoter that is compatible with suitable methyl ethyl ketone peroxide and cumene hydroperoxide initiators.
  - (d) Meet the required values for the material properties shown in Table 1, below.

Accelerators or inhibitors may be required to achieve proper setting time of PPC. They shall be used as recommended by the overlay System Provider.

**Table 1  
POLYESTER RESIN BINDER PROPERTIES (PPC ONLY)  
(Each lot sent to job shall be tested)**

Property	Test Method	Requirement
Viscosity*	ASTM D 2196	75 – 200 cps (RVT No.1 Spindle, 20 RPM at 77 °F)
Specific Gravity*	ASTM D 1475	1.05 to 1.10 at 77 °F

Elongation	ASTM D 638	35 percent, minimum Type I specimen, thickness 0.25 ± 0.03” at Rate = 0.45 inch/minute.
	ASTM D 618	Sample Conditioning: 18/25/50+5/70
Tensile Strength	ASTM D 638	2,500 psi, minimum Type I specimen, thickness 0.25 ± 0.03” at Rate = 0.45 inch/minute.
	ASTM D 618	Sample Conditioning: 18/25/50+5/70
* Test shall be performed before adding initiator.		

- (2) High Molecular Weight Methacrylate (HMWM) Primer: Primer for the substrate concrete surface shall be a wax-free, low odor, high molecular weight methacrylate primer, and consist of a resin, initiator, and promoter. The primer shall conform to requirements indicated in Table 2, below, and all components shall be supplied by the System Provider.

Initiator for the methacrylate resin shall consist of a metal drier and peroxide. If supplied separately from the resin, the metal drier shall not be mixed with the peroxide directly; a VIOLENT EXOTHERMIC REACTION will occur. The containers and measuring devices shall not be stored in a manner that allows leakage or spilling to contact the containers or materials of the other.

**Table 2  
HMWM PRIMER PROPERTIES (PPC ONLY)  
(Tested yearly)**

Property	Test Method	Requirement
Viscosity**	ASTM D 2196	25 cps maximum (Brookfield RVT with UL adapter, 50 RPM at 77 °F)
Volatile Content**	ASTM D 2369	30 percent, maximum
Specific Gravity**	ASTM D 1475	0.90 minimum at 77 °F
Flash Point	ASTM D 3278	180 °F minimum
Vapor Pressure**	ASTM D 323	1.0 mm Hg, maximum at 77 °F
PCC Saturated Surface-Dry Bond Strength (Adhesive)	California Test 551, part 5	700 psi, minimum at 24 hours and 70 ± 1°F (with PPC at 12% resin content by weight of the dry aggregate), primed surface
**Test shall be performed before initiator is added		

- (B) Epoxy Polymer Concrete (EPC) materials shall consist of an epoxy resin binder/primer and aggregate.

- (1) Epoxy Resin Binder/Primer: Epoxy resin binder/primer shall have the following properties:
- (a) Be a low viscosity epoxy resin. The resin content shall be 12% +/-1% of the weight of the dry aggregate.
  - (b) Be 100% solids epoxy.
  - (c) Be a two-part, low modulus epoxy resin.
  - (d) Be moisture insensitive.

(e) Meet the required values for the material properties shown in Table 3, below.  
 Accelerators or inhibitors may not be used to achieve proper setting time of EPC.

**Table 3**  
**EPOXY RESIN BINDER/PRIMER PROPERTIES (EPC ONLY)**  
 (Each lot sent to job shall be tested)

Property	Test Method	Requirement
Viscosity*	ASTM D 2196	75 – 150 cps (RVT No.1 Spindle, 20 RPM at 77 °F)
Specific Gravity*	ASTM D 1475	1.05 to 1.08 at 77 °F
Elongation	ASTM D 638	55 percent, minimum Type I specimen, thickness 0.25 ± 0.03” at Rate = 0.45 inch/minute.
	ASTM D 618	Sample Conditioning: 18/25/50+5/70
Tensile Strength	ASTM D 638	2,800 psi, minimum Type I specimen, thickness 0.25 ± 0.03” at Rate = 0.45 inch/minute.
	ASTM D 618	Sample Conditioning: 18/25/50+5/70

(C) Aggregates: PC overlay aggregate shall be used for PPC and EPC and have the following properties:

- (1) No more than 45 percent crushed particles retained on the No. 8 sieve when tested in accordance with American Association of State Highway and Transportation Officials (AASHTO) Test Method T335.
- (2) Fine aggregate consists of natural sand only.
- (3) Weighted-average aggregate absorption of no more than 1.0 percent when tested under AASHTO Test Methods T84 and T85.
- (4) At the time of mixing with resin, have moisture content of not more than one-half (½) of the weighted-average aggregate absorption when tested under AASHTO Test Method T255.
- (5) Moh’s hardness of seven (7) or greater.
- (6) Comply with the requirements for the aggregate gradation indicated in Table 4, below:

**Table 4**  
**AGGREGATE GRADATION**  
 (Tested yearly)

Sieve Size	Percent Passing
3/8”	100
No. 4	60-85
No. 8	55-65
No. 16	29-50
No. 30	16-36
No. 50	5-20
No. 100	0-7
No. 200	0-3

(D) Sand/Fine Aggregate: Sand or fine aggregate for an abrasive finish shall be used for PPC and EPC and have the following properties:

- (1) Commercial-quality blast sand/fine aggregate.
  - (2) Not less than 95 percent pass the No. 8 sieve and not less than 95 percent retained on the No. 20 sieve when tested under AASHTO Test Method T27.
  - (3) Shall be dry at the time of application.
- (E) Composite system: The composite PC overlay system shall have the following properties indicated in Table 5, below:

**Table 5**  
**COMPOSITE PROPERTIES**  
**(Tested every 2 years)**

Property	Test Method	Requirement
PCC Saturated Surface Dry Bond Strength	CT 551	500 psi minimum at 24 hrs. and 70° F (without primer, at 12% resin content by weight of the dry aggregate, on Saturated Surface Dry Specimen)
Abrasion Resistance	CT 550	< 2g weight loss (at 12% resin content by weight of the dry aggregate)
Modulus of Elasticity	ASTM C 469	1,000,000 psi to 2,000,000 psi (at 12% resin content by weight of the dry aggregate)

**CONSTRUCTION REQUIREMENTS**

- (A) PC Overlay Pre-placement Conference: A Pre-placement Conference shall be held before any overlay operations begin. Attendees shall include representatives from all parties involved in the work. If necessary, teleconferencing of attendees may be approved by the Engineer.
- (B) PC Overlay Placement Notice: Contractor shall provide a minimum 48 hours notice to the Engineer, prior to placement of PC overlay on any structure.
- (C) Trial Application: Prior to constructing the overlay, one or more trial applications shall be placed on a previously constructed concrete base to demonstrate proper initial set time and the effectiveness of the mixing, placing, and finishing equipment proposed. The set time can be determined as the time elapsed from resin catalyzation until the in-place PC trial application cannot be deformed by pressing with a finger, indicating the resin binder is no longer in a liquid state. Each trial application shall be the planned paving width, at least ten (10) feet long, and have the same thickness as the specified overlay. Conditions during the construction of the trial application(s) and equipment used shall be similar to those to be used for construction of the overlay. The location of the trial application(s) shall be approved by the Engineer. Trial applications shall be properly disposed of off-site by the Contractor, if removal is necessary.

The number of trial applications required shall be as many as necessary for the Contractor to demonstrate the ability to construct an acceptable trial overlay section and competency to perform the work. However, the installer or proposed equipment/techniques may be rejected if not shown to be acceptable after three (3) trials.

Overlay direct tension bond testing shall be performed in accordance with Section (F)(1) of this special provision. Acceptable test results shall be achieved on a trial application before the installation may proceed.

(D) Equipment: All equipment for cleaning the existing concrete surface and mixing and applying the overlay system shall be in accordance with the System Provider's recommendations, as approved by the Engineer prior to commencement of any work.

(1) Surface Preparation Equipment: Provide appropriate scarifying, shotblasting, sandblasting and other equipment to adequately prepare the bridge deck substrate, as required in the Overlay Surface Preparation for Polymer Concrete special provision.

(2) Mixing Equipment: A continuous automated mixer shall be used for all PC overlay applications. The continuous mixer shall:

- (a) Employ an auger screw/chute device capable of sufficiently mixing catalyzed resin with dry aggregate.
- (b) Employ a plural component pumping system capable of handling binder resin and catalyst while maintaining proper ratios to achieve set/cure times within the specified limits. Catalyzed resin shall flow through a static mix tube for sufficient duration to completely mix the liquid system.
- (c) Be equipped with an automatic metering device that measures and records aggregate and resin volumes. Record volumes at least every five (5) minutes, including time and date. Submit recorded volumes at the end of the work shift to the Engineer.
- (d) Have a visible readout gage that displays volumes of aggregate and resin being recorded.
- (e) Produce a satisfactory mix consistently during the entire placement.

A portable mechanical mixer of appropriate size for proposed batches, as recommended by the System Provider and approved by the Engineer, may be used for all PC patching applications and for smaller area overlay applications if approved by the Engineer.

(3) Finishing Equipment: Finishing may be accomplished with a Self-Propelled Slip-Form Paving Machine or Vibratory Screed.

(a) Self-Propelled Slip-Form Paving Machine: A self-propelled slip-form paving machine, which is modified or specifically built to effectively place the PC overlay in a manner that meets the objectives and requirements of the project, may be used for PC overlay applications. The paving machine shall:

- (i) Employ a vibrating pan to consolidate and finish the PC overlay.
- (ii) Be fitted with hydraulically controlled grade automation to establish the finished profile. The automation shall be fitted with substrate grade averaging devices on both sides of the new placement; the device shall average 15 feet in front and behind the automation sensors; or the sensor shall be constructed to work with string-line control. It is acceptable to match grade when placing lanes adjacent to previously placed PC.
- (iii) Be calibrated for the projects requirements, and calibrated periodically following the manufacturers recommendations.
- (iv) Have sufficient engine power and weight to provide adequate vibration of the finishing pan while maintaining consistent forward placement speed.
- (v) Be capable of both forward and reverse motion under its own power.

(b) Vibratory Screed: A vibratory screed may be used for finishing the PC overlay, but must be approved by the Engineer at least two (2) weeks prior to PC overlay placement.

- (D) Concrete Deck Repairs and Surface Preparation: All areas that require removal of existing patches or unsound concrete shall be removed and prepared in accordance with the requirements of the Overlay Surface Preparation for Polymer Concrete special provision. Placement of concrete for deck repair material shall be Polymer Concrete in accordance with this special provision. Prepare all concrete deck and repaired deck surfaces in accordance with the requirements of the Overlay Surface Preparation for Polymer Concrete special provision.
- (E) Application of Overlay: Methods indicated in this special provision are typical of general installations and may be modified per the System Provider's recommendations as approved by the Engineer. The application of the overlay shall not begin until the concrete deck is completely surface dry in accordance with ASTM D4263, with a wait time revised from 16 hours to two (2) hours, or as directed by the System Provider's Technical Representative. Prior to overlay application, the concrete surface temperature shall be within the specified temperature ranges below. Night work may be required when temperatures cannot be met during the day.

(a) For PPC overlays, the concrete surface temperature shall be between 40° and 100° F.

(b) For EPC overlays, the concrete surface temperature shall be between 60° and 90° F.

During overlay application, precaution shall be taken to assure that traffic is protected from rebound, dust, and construction activities. Appropriate shielding shall be provided as required and directed by the Engineer.

During overlay application, the Contractor shall provide suitable coverings (e.g. heavy duty drop cloths) as needed to protect all exposed areas not to receive overlay, such as curbs, sidewalks, parapets, etc. All damage or defacement resulting from this application shall be cleaned and/or repaired to the Engineer's satisfaction at no additional cost to the Department.

- (1) Primer Application: Immediately before placing primer, all exposed surfaces shall be completely dry and blown clean with oil-free compressed air. Exposed surfaces shall be protected from precipitation and heavy dew during and after the application of the primer.

After the exposed surfaces have been prepared and are dry, primer shall be applied in accordance with the System Provider's recommendations. Primer shall be placed within five (5) minutes of mixing at approximately 90-100 ft<sup>2</sup>/ gal or the rate acceptable to the Engineer.

Primer shall be applied by flooding and uniformly spread to completely cover surfaces to receive overlay. Care shall be taken to avoid heavy application that results in excess ponding. Excess material shall be removed or distributed to meet the required application rate. Primer shall be reapplied to any areas that appear dry prior to overlay placement.

Primer shall not be allowed to leak onto areas that have not received surface preparation.

- (2) PC Overlay Application: The PC overlay shall be applied during the interval between 15 minutes and two (2) hours after the primer has been applied. The PC overlay shall be placed prior to gelling. For PPC overlays, the overlay shall be placed within 15 minutes following addition of initiator, unless otherwise recommended by the System Provider's Technical Representative.

The resin binder shall be initiated for PPC overlays and blended completely. Aggregate shall be added and mixed sufficiently when a portable mechanical mixer is used.



The set time can be determined in the field when the in-place PC application cannot be deformed by pressing with a finger, indicating that the resin binder is no longer in a liquid state.

- (a) When using PPC, the initial set time shall be at least 30 minutes and at most 90 minutes. If the PPC initial set is not within 30 to 90 minutes, the material shall be removed and replaced.
- (b) When using EPC, the initial set time shall be at least 30 minutes and at most 180 minutes. If the EPC initial set is not within 30 to 180 minutes, the material shall be removed and replaced.

The overlay shall be consolidated and finished to the required grade and cross-section using PC placement equipment as defined herein.

If a vibratory screed is used, prior to placing the PC overlay, place and fasten screed rails in position to ensure finishing the new surface to the required profile. Do not treat screed rails with parting compound to facilitate their removal. Prior to placing the overlay, attach a filler block to the bottom of the screed and pass it over the overlay area to check the thickness. The filler block thickness shall be equal to the design overlay thickness as shown in the plans. Remove all concrete that the block does not clear.

Place the PC overlay in one operation. Provide a minimum overlay thickness as shown in the plans.

Although the paver or screed may yield a finished or nearly finished surface, additional finishing may be necessary. The PC overlay shall be finished, as necessary, through traditional concrete finishing methods, producing a slight resin bleed indicating complete consolidation of aggregates.

Finishing of Polymer Concrete used as patching of an existing deck surface or overlay shall be completed and finished using traditional concrete hand finishing methods and hand concrete finishing tools. Such patches shall be placed flush with the top of the existing deck surface.

Resin content shall be as specified in the Materials section of this special provision and to yield a Polymer Concrete consistency that requires surface applied consolidation and finishing to consolidate aggregates and yield a slight sheen of bleed resin on top surface, yet does not yield excess bleed resin.

A surface friction sand/fine aggregate finish of at least 2.2 lbs/ yd<sup>2</sup> shall be broadcast onto the glossy surface immediately after sufficient finishing and before resin gelling occurs. To ensure adequate pavement friction, the completed PC overlay surface shall be free of any smooth or "glassy" areas such as those resulting from insufficient quantities of surface aggregate. Any such surface defects shall be repaired by the Contractor in the manner recommended by the System Provider and approved by the Engineer at no additional cost to the Department.

All final edges of PC overlay not adjacent to barrier rail, parapet, or bridge deck joints shall be finished neat, straight, and square, unless otherwise noted on project plans or approved by the Engineer.

Unless otherwise indicated on the plans, groove the deck surface in accordance with Subarticle 420-14(B) of the *Standard Specifications*. Vehicular traffic may travel across a

deck surface that has not been grooved; however, the entire deck area shall be grooved after the PC overlay achieves design strength and no later than seven (7) calendar days after completion of the overlay unless otherwise approved by the Engineer.

Before completion of the project, all deck joints shall be sawcut, prepared, and sealed according to the details in the plans.

After the PC material has set, if final sawcutting for joint seals will not be done within 12 hours, at minimum, a single sawcut shall be made at the approximate midpoint of each joint. The sawcut shall be made within 12 hours or prior to opening of PC placement to traffic, if traffic will be allowed within 12 hours. Two (2) saw cuts may be made, but final saw cutting for the joints shall be done in accordance with the special provisions for the installation of the joint seals.

Any surface that is scarified shall be covered with the PC overlay before traffic is returned to the bridge deck, unless otherwise approved by the Engineer.

Upon approval by the Engineer, if traffic is to be returned to the site, but the overlay is not completed within the allowable lane closure time and is more than  $\frac{3}{4}$  inch higher in elevation than the adjacent pavement, the PC overlay edges shall be tapered. The leading edge of the overlay shall be tapered at a 4:1 (horizontal: vertical) slope. Tapered edges longitudinal to the direction of traffic and tapered edges on the trailing edge of the overlay and shall be at a 45 degree slope. Tapers of 45 degrees may remain, and PC overlay may be placed adjacent. Tapers with a 4:1 (horizontal: vertical) slope shall be sawcut square to the overlay surface, prior to placing adjacent PC overlay.

The Contractor shall collect a ticket for each pass or portion of a pass that is provided by each mixer, and ensure that the following information is shown on each ticket:

- (a) Project Number.
- (b) Bridge Number.
- (c) Date and Time.
- (d) Location of Placement (Lane and Station Limits or location and length of placement along the length of the bridge).
- (e) Aggregate Weight.
- (f) Resin Binder Weight.

The tickets shall be available on site for Inspection personnel to use in tabulating quantities.

Curing: The Contractor shall allow the overlay to cure sufficiently before subjecting it to loads or traffic of any nature that may damage the overlay. Cure time depends upon the ambient and deck temperatures as well as initiator/accelerator levels.

The overlay shall be considered cured to a traffic ready state when a minimum reading of 25 on a properly calibrated Swiss hammer is achieved. Other rebound hammers may be use as approved by the Engineer.

(F) Acceptance Testing: Acceptance of the deck repairs, surface preparation, and PC overlay will be determined by the Engineer based on direct tension bond testing, and smoothness quality testing performed by the Engineer, assisted by the Contractor.

- (1) Overlay Direct Tension Bond Testing: Direct tension bond (pull-off) tests shall be performed after 24 hours by the Contractor in accordance with ASTM C1583. At a

minimum, three (3) direct tension bond tests shall be performed on each bridge overlay. For bridges with deck areas greater than 25,000 square feet, additional tests shall be performed at a frequency of one test per 25,000 square feet of additional deck area, rounded up. Additional testing may be required as directed by the Engineer.

The test result shall be the average of the tests for each structure. Test cores shall be drilled a minimum of ½” below the bond line.

The average minimum bond strength of the PC overlay system on normal weight concrete shall be 250 psi, with no individual test measured below 225 psi. An acceptable test will demonstrate that the overlay bond strength is sufficient, or by producing a concrete subsurface failure area greater than 50% of the test surface area. The Contractor shall repair all direct tension test locations with PC overlay in accordance with this special provision.

Direct tension bond testing shall be performed by an independent testing firm and shall be arranged by the Contractor. The Contractor may perform the direct tension bond testing with the approval of the Engineer. Testing shall be performed using a calibrated tensile loading device, in the presence of the Engineer. The tensile loading device shall be calibrated annually. The cost of direct tension bond testing shall be included in the bid price for *Placing and Finishing PC Overlay* item.

- (2) Smoothness Quality Testing: As soon as practical after the PC overlay has hardened sufficiently, the Contractor shall test the finished surface with an approved rolling straightedge that is designed, constructed, and adjusted, so that it will accurately indicate or mark all deck areas which deviate from a plane surface by more than ⅛” in 10’. The Contractor shall remove all high areas in the hardened surface in excess of ⅛” in 10’ with an approved grinding or cutting machine. Any fins or other protrusions remaining after grinding operations shall be removed to the satisfaction of the Engineer. Additionally, the final PC deck surface shall not deviate from the line and elevation indicated on the plans by more than 0.3” over any 50’ length. If approved by the Engineer, correct low areas in an acceptable manner.

(G) Corrective Work

- (1) Repair of Surface Defects: The repair materials and finishing methods for surface defects in the overlay shall be in accordance with those used for the application of the overlay. All surface defects shall be repaired to the satisfaction of the Engineer before acceptance of the work is made.
- (2) Correction for Smoothness: Areas showing high spots of more than ⅛” in 10’ shall be marked and ground until the high spot does not exceed ⅛” in 10’. Ground surface may be sawcut grooved to restore the texture if ordered by the Engineer. Areas showing low spots of more than ⅛” in 10’ shall be marked and a proposed repair procedure shall be submitted to the Engineer. The use of the proposed repair procedure shall be as recommended by the System Provider and approved by the Engineer.
- (3) Replacement of Defective Overlay: A defective overlay, or portion thereof, resulting in failing overlay pull bond test results shall be removed and replaced at the Contractor’s expense. The Contractor shall submit a written corrective work proposal to the Engineer, which shall include the methods and procedures that will be used. The Contractor shall not commence corrective work until the methods and procedures have been approved in

writing by the Engineer. The Engineers approval shall not relieve the Contractor of the responsibility of producing work in conformity with the Contract.

- (4) Repair of Cracking: After a one-week cure period, if cracks are in the overlay, the Contractor shall fill the cracks with properly catalyzed and mixed primer material at no cost to the Department. Care shall be taken to fill the cracks only and ensure minimal primer material is left on the finished surface of the overlay.

#### **MEASUREMENT AND PAYMENT**

*Concrete Deck Repair for PC Overlay* will be measured and paid for at the contract unit price bid per square yard and will be full compensation for placement of concrete deck repair material and shall include the cost of labor, tools, equipment and incidentals necessary to complete the work.

*Placing and Finishing PC Overlay* will be measured and paid for as the contract unit price bid per square yard of overlay placement and final surface finishing. Payment will be full compensation for all labor, equipment, and all incidentals necessary to complete the PC overlay placement. Construction and removal (if required) of trial application(s), including concrete base surfaces, will not be measured and paid for separately, but shall be incidental to complete the work. Tining of bridge deck, if used, will be incidental to this pay item.

*Grooving Bridge Floors* will be measured and paid in accordance with Article 420-21 of the *Standard Specifications*.

Only one of the following pay items shall be used for materials, dependent on the PC overlay system used.

(A) *Polyester Polymer Concrete Materials* will be measured as the actual volume of PPC material complete-in-place. The volume shall include material used for overlay, patching of existing unsound concrete deck surface or overlays, and bridge deck concrete repairs as directed by the Engineer. Tickets provided to the project inspector, showing quantities of PPC produced, shall be sufficient to calculate volume of material placed. Materials placed for trial application(s) shall be included in this Pay Item if placed and remaining on the bridge deck as part of the permanent overlay. *Polyester Polymer Concrete Materials* will be paid for at the contract unit price per cubic yard and will be full compensation to furnish the PPC material, including HMWM primer, freight to the project site, receiving, storage, and disposal of any unused PPC overlay material. Payment by cubic foot will be based on a 135 lbs/ ft<sup>3</sup> unit weight and quantities recorded by calibrated mixer unit readouts.

(B) *Epoxy Polymer Concrete Materials* will be measured as the actual volume of EPC material complete-in-place. The volume shall include material used for overlay, patching of existing unsound concrete deck surface or overlays, and bridge deck concrete repairs as directed by the Engineer. Tickets provided to the project inspector, showing quantities of EPC produced, shall be sufficient to calculate volume of material placed. Materials placed for trial application(s) shall be included in this Pay Item if placed and remaining on the bridge deck as part of the permanent overlay. *Epoxy Polymer Concrete Materials* will be paid for at the contract unit price per cubic yard and will be full compensation to furnish the EPC material, including epoxy primer, freight to the project site, receiving, storage, and disposal of any unused EPC overlay material. Payment by cubic foot will be based on a 135 lbs/ ft<sup>3</sup> unit weight and quantities recorded by calibrated mixer unit readouts.

Payment will be made under:

**Pay Item**

Concrete Deck Repair for PC Overlay  
 Placing & Finishing PC Overlay  
 Grooving Bridge Floors  
 Polyester Polymer Concrete Materials  
 Epoxy Polymer Concrete Materials

**Pay Unit**

Square Yard  
 Square Yard  
 Square Feet  
 Cubic Yard  
 Cubic Yard

**POURABLE SILICONE JOINT SEALANT****(SPECIAL)****SEALS**

Provide and install a low modulus silicone sealant (non-sag or self-leveling) and backer rod which conforms to the *Standard Specifications* (Subsections 1028-3 and 1028-4, respectively) and this special provision. Use silicone approved for use on joint openings as indicated on project plans and provide a seal with a working range of minimum 50% compression and extension. Silicone joint seal product shall be designated as approved for use on the NCDOT Approved Products List. If non-sag and self-leveling sealants are to be in contact with each other, they shall be from the same manufacturer and shall be compatible for such use.

**SAWING THE JOINT**

Joint concrete material or joint concrete header material shall have sufficient time to cure such that no damage can occur to the concrete prior to sawing to the final width and depth as specified in the plans.

When sawing the joint to receive the seal, always use a rigid guide to control the saw in the desired direction. To control the saw and to produce a straight line as indicated on the plans, anchor and positively connect a template or a track to the bridge deck. Do not saw the joint by visual means such as a chalk line. Fill the holes used for holding the template or track to the deck with an approved flowable, non-shrink, non-metallic grout.

Saw cut to the desired width and depth in one or two (2) passes of the saw by placing and spacing two (2) metal blades on the saw shaft to the desired width for the joint opening.

The desired depth is the depth of the seal plus ¼” above the top of the seal plus approximately 1” below the bottom of the seal. An irregular bottom of sawed joint is permitted as indicated on the plans. Grind exposed corners on saw cut edges to a ¼” chamfer.

Saw cut a straight joint, centered over the formed opening and to the desired width specified in the plans. Prevent any chipping or damage to the sawed edges of the joint.

Remove any staining or deposited material resulting from sawing with a wet blade to the satisfaction of the Engineer.

**PREPARATION OF FORMED OR SAWED JOINT FOR SEAL INSTALLATION**

Joint concrete material or joint concrete header material shall cure a minimum of 24 hours prior to seal installation.

After forming or sawing the joint, the Engineer will thoroughly inspect the joint opening for spalls, popouts, cracks, etc. All necessary repairs will be made by the Contractor prior to blast cleaning and installing the seal, at no cost to the Department.

Clean the joints by sandblasting the joint opening to provide a firm, clean joint surface free of curing compound, loose material, and any foreign matter. Sandblast the joint opening without causing pitting or uneven surfaces. The aggregate in the polyester polymer concrete may be exposed after sandblasting.

After blasting, either brush the surface with clean brushes made of hair, bristle, or fiber, blow the surface with compressed air, or vacuum the surface until all traces of blast products and abrasives are removed from the surface, pockets, and corners. If nozzle blasting is used to clean the joint opening, use compressed air that does not contain detrimental amounts of water or oil.

Examine the blast-cleaned surface and remove any traces of oil, grease, or smudge deposited in the cleaning operations.

Apply recommended primer in accordance with the manufacturer's recommendations. Uniformly coat the entire surface. Over application may affect adhesion. Allow to thoroughly dry before installing backer rod and sealant.

Install a circular backer rod that is a minimum 25 percent oversized into the joint approximately 1 in. below the surface. The backer rod shall be sized according to the manufacturer's recommendation for the size of the joint to be sealed as measured by the Contractor. If two (2) pieces must be joined, abut the two (2) ends and tape them together to prevent sealant run down. The backer rod may be installed by hand, but roller device shall be used to insure a consistent, uniform placement at the proper depth below the top surface.

Install the backer rod and silicone sealant in the blast-cleaned opening on the same day the surface is blast cleaned.

#### **SEAL INSTALLATION**

Install the silicone joint sealant(s) as indicated on the plans, in accordance with the manufacturer's procedures and recommendations, and as recommended below. Do not install the joint seal if the ambient air or surface temperature is below 45°F. Have a manufacturer's certified trained factory representative present during the installation of the first seal of the project, to provide guidance for the proper installation of the silicone joint sealant(s).

The sealant must be recessed a minimum ½ in. below the pavement surface to prevent traffic abrasion or snow plow damage.

After a joint has been sealed, remove excess joint sealer on the pavement or bridge deck concrete as soon as possible.

The installed system shall be watertight and will be monitored until final inspection and approval.

Do not place pavement markings on top of pourable joint seals.

#### **(A) Watertight Integrity Test**

- (1) Upon completion of each pourable silicone joint, perform a water test on the top surface to detect any leakage. Cover the roadway section of the joint from curb to curb, or barrier

rail to barrier rail, with water, either ponded or flowing, not less than 1 inch above the roadway surface at all points. Block sidewalk sections and secure an unnozzled water hose delivering approximately 1 gallon of water per minute to the inside face of the bridge railing, trained in a downward position about six (6) inches above the sidewalk, such that there is continuous flow of water across the sidewalk and down the curb face of the joint.

- (2) Maintain the ponding or flowing of water on the roadway and continuous flow across sidewalks and curbs for a period of five (5) hours. At the conclusion of the test, the underside of the joint is closely examined for leakage. The strip seal expansion joint is considered watertight if no obvious wetness is visible on the Engineer’s finger after touching a number of underdeck areas. Damp concrete that does not impart wetness to the finger is not considered a sign of leakage.
- (3) If the joint system leaks, locate the place(s) of leakage and take any repair measures necessary to stop the leakage at no additional cost to the Department. Use repair measures recommended by the manufacturer and approved by the Engineer prior to beginning corrective work.
- (4) If measures to eliminate leakage are taken, perform a subsequent water integrity test subject to the same conditions as the original test. Subsequent tests carry the same responsibility as the original test and are performed at no additional cost to the Department.

**BASIS OF PAYMENT**

*Pourable Silicone Joint Sealant* will be measured and paid for at the contract unit price bid per linear foot and will be full compensation for furnishing all material, including backer rod, labor, tools, and equipment necessary for installing these seals in place and accepted.

<b>Pay Item</b>	<b>Pay Unit</b>
Pourable Silicone Joint Sealant	Linear Feet

**CONCRETE WORK FOR JOINT REPLACEMENT** **(2-11-19)**

**DESCRIPTION**

This special provision addresses the removal, placement and finishing of concrete required for reconstructing the deck slab and, if necessary, bent diaphragms at bridge joint locations as noted in the plans.

**MATERIALS**

Furnish Department approved pre-packaged concrete or bulk concrete materials in a mix proportioned to satisfy provisions for Class AA Concrete detailed in Article 1000-5 of the *Standard Specifications* or as otherwise noted in the Concrete for Deck Repair special provision.

**REMOVAL AND PREPARATION**

Remove existing deck slab concrete to the limits shown in the plans. Existing concrete that is deteriorated, cracked or spalled shall be removed to sound material. Do not cut or remove the existing reinforcing steel unless otherwise noted in the plans.

Prior to concrete removal, introduce a shallow saw cut, ½” in depth, around the repair area at right angles to the concrete surface. Remove all concrete within the limits called out in the plans. If concrete removal exposes reinforcing steel beyond the limits shown in the plans, remove concrete 1” below the reinforcing steel with a 17 lb (maximum) pneumatic hammer, with points that do not exceed the width of the shank, or with hand picks or chisels, as directed by the Engineer.

Abrasive blast all exposed concrete surfaces and existing non-epoxy coated reinforcing steel in repair areas to remove all debris, loose concrete, loose mortar, rust, scale, etc. After blasting, examine the reinforcing steel to ensure at least 90% of the original diameter remains. If there is more than 10% reduction in the rebar diameter, splice in and securely tie supplemental reinforcing bars as directed by the Engineer. This might require additional removal of concrete, in order to achieve an appropriate splice length of the reinforcing steel. Touch-up epoxy coatings of exposed epoxy reinforcing steel, as directed by the Engineer.

Follow all abrasive blasting with vacuum cleaning.

Prior to placing concrete at joint repair locations, install a rigid bulkhead at the required grade and profile.

For joint repairs utilizing elastomeric concrete, attach a 5 ½” x 2 ¼” minimum block out to the rigid bulkhead. The block out shall have 1” diameter air bleed holes spaced at 3’ centers along the block out to relieve air pockets and facilitate concrete consolidation. Once the concrete has cured properly, remove the block out and install elastomeric concrete as described in the Elastomeric Concrete special provision.

For joint repairs utilizing strip seals, secure the strip seal retainer rails in final position to match existing grade and cross slope. Furnish falsework to support retainer rails during installation as described in the Strip Seal special provision.

Secure screed rail guides in position to ensure finishing the surface to the required profile and cross slope. Do not treat screed rails with parting compound to facilitate their removal.

Completely clean all surfaces of grease, oil, curing compounds, acids, dirt, or loose debris within 24 hours of placing concrete. Thoroughly soak and cover existing concrete surfaces for a minimum of two (2) hours prior to placing concrete. Remove any standing water from the repair area surface prior to placing concrete

**PLACING AND FINISHING**

Construction joints other than those shown on the plans will not be permitted unless approved by the Engineer.



Prior to placement, the air temperature, wind speed, and evaporation rate shall be determined by the Contractor and verified by the Engineer. Do not place concrete if the ambient air temperature is below 45°F or above 85°F, or if the wind velocity is in excess of 10 mph.

If the rate of evaporation of surface moisture exceeds 0.10 pounds per square foot per hour during placement, measures shall be taken to reduce the rate of evaporation. The evaporation rate is calculated using the following formula:

$$E = (T_c^{2.5} - r * T_a^{2.5}) * (1 + 0.4V) * (10^{-6})$$

where,

E = Evaporation Rate,

T<sub>c</sub> = Concrete Temp (°F),

r = Relative Humidity (%/100)

T<sub>a</sub> = Air Temp (°F),

V = Wind Velocity (mph)

Do not place concrete if the predicted air temperature at the site will be less than 35°F within 72 hours after placement. For a predicted air temperature above 35°F but below 50°F, use insulation to protect the concrete for a period of at least 48 hours. Use insulation that meets the requirements of Subarticle 420-7(C) of the *Standard Specifications* and place on fresh concrete surfaces as soon as initial set permits. Do not remove the insulation during the wet curing period unless the ambient air temperature is at least 40°F and rising.

Place the concrete monolithically in one operation. Concrete shall not be placed in layers. Sections to be reconstructed are to be filled full depth and shall progress horizontally. Deviation from this procedure shall be cause for rejection.

Stop all placement operations during periods of precipitation. Keep an adequate quantity of protective coverings at the worksite and take adequate precautions to protect the freshly placed concrete from precipitation.

When a tight, uniform surface is achieved and before the concrete becomes non-plastic, finish the top surface of the deck repair by burlap dragging or other approved method that produces an acceptable uniform surface texture.

As soon as the surface supports burlap without deformations, cover the surface with two layers of clean, wet burlap. Drain excess water from the burlap before placement. Other wet cure methods are permitted but must be approved by the Engineer prior to start of placement.

Wet cure the concrete a minimum of three (3) hours or until 4,500 psi compressive strength is obtained.

After the concrete has hardened sufficiently, test the finished surface with a straightedge that is designed, constructed, and adjusted such that it will accurately indicate or mark all floor areas which deviate from a plane surface by more than 1/8" in 10 feet. Remove all high areas in excess of 1/8" in 10 feet with an approved grinding or cutting machine. Where variations are such that the corrections extend below the limits of the top layer of grout, seal the repaired surface with an approved sealing agent. Methods for correcting low areas shall be approved by the Engineer.

Groove finished concrete surfaces unless otherwise shown in the plans.

**LIMITATIONS OF OPERATIONS**

Submit volumetric mixer size and weight data to the Engineer for review. The volumetric mixer may be allowed on the bridge deck with approval from the Engineer.

No vehicular or construction traffic is permitted on finished concrete prior to achieving a compressive strength of 4,500 psi.

If working at night, provide approved lighting

**Measurement and Payment**

*Concrete Work for Joint Replacement* will be measured and paid for at the contract unit price bid per square feet and will be full compensation for removal, containment and disposal off-site of unsound concrete, placement and finishing of repair concrete, and shall include the cost of labor, tools, equipment (excluding the volumetric mixer) and incidentals necessary to complete the repair work.

<b>Pay Item</b>	<b>Pay Unit</b>
Concrete Work for Joint Replacement	Square Feet

**STRIP SEALS FOR PRESERVATION**

**(08-08-22)**

**GENERAL**

This special provision consists of furnishing, repairing, and installing strip seal expansion joints and glands as shown on the contract drawings and in accordance with this special provision, the *Standard Specifications* and the manufacturer's recommendation. All materials, labor, equipment, and incidentals necessary for the proper installation of the strip seal expansion joints are included.

**MATERIALS**

Provide strip seal expansion joints capable of accommodating a total movement measured parallel to the centerline of the roadway as shown on plans. The components of the expansion joint include steel retainer rails and a neoprene seal gland.

The steel retainer rails shall consist of a "P" shape profile configuration with welded anchor studs embedded into the concrete. The rails shall have a minimum height of 8 inches, a minimum

thickness of ½ inch and a maximum top surface (at the riding surface) width of 2 inches. Use AASHTO M270 Grade 36 or Grade 50 steel for the steel retainer rails.

Use a neoprene gland that is an extruded synthetic rubber utilizing virgin polychloroprene as the only polymer. Require the manufacturer to provide Type 4 certification, in accordance with the *Standard Specifications*, that the gland has been tested for the following properties:

PHYSICAL PROPERTY	TEST METHOD	REQUIREMENTS
Tensile Strength, psi (min.)	ASTM D412	2000
Elongation at break, % (min.)	ASTM D412	250
Hardness, Type A durometer, points	ASTM D2240 Modified	60 ± 10
Oven aging, 70h @ 212°F Tensile strength, % change (max.) Elongation, % change (max.) Hardness, points change (max.)	ASTM D573	-20 -20 0 to +10
Oil Swell, ASTM Oil No. 3, 70h @ 212°F Weight change, % (max.)	ASTM D471	45
Ozone resistance 20% strain, 300 pphm in air 70h @ 104°F	ASTM D1149 Modified	No cracks
Low temperature stiffening, 7 days @ 14°F Hardness, Type A durometer, points change	ASTM D2240	0 to +15
Compression Set, 70h @ 212°F (max.)	ASTM D395 Method B (modified)	40%

### SHOP DRAWINGS

Submit a set of complete shop drawings to the Engineer via email for review, comments and acceptance and copy (cc) the Structures Management Unit Working Drawing Review Group ([SMU-wdr@ncdot.gov](mailto:SMU-wdr@ncdot.gov)). Send the drawings well in advance of the scheduled installation time for the strip seal expansion joint. Prior to submitting the shop drawings, have someone, other than the draftsman who prepares the drawings, check all detailed drawings and include the signatures of both the draftsman and checker on each sheet of the drawings. The Engineer returns unchecked drawings to the Contractor.

Steel retainer rails shall consist of one-piece construction including upturns. Welding two or more components to obtain the required cross-sectional shape is not permitted. Show all dimensions, anchor stud locations, welded splice details, splice locations and any other details or data necessary to fabricate the joint on the shop drawings. Include the joint model number and joint movement range. Draw all details to scale. Identify, in detail, any welding procedures to be performed in fabricating the joint. When applicable, show the following on the drawings:

- All field splice locations. Steel retainer rail field splices are only permitted at crown points, locations with a change in the deck slab cross slope, and at travel lane lines. Splices within travel lanes are not permitted and splicing on edge lines is not required. For the location of travel lane markings at the strip seal expansion joint, see the structure plans. At the field splice locations, locate the horizontal stud anchors 3 inches from the centerline of the splice.
- Details of the shipping device for the steel retainer rail assemblies. Ensure the device is capable of resisting shipping and handling forces without causing damage to the steel retainer rail assemblies or metallized coating.
- The method of supporting steel retainer rails horizontally and vertically during joint installation and placement of concrete to ensure stability and proper alignment. Ensure the method is capable of resisting construction forces without causing damage to the steel retainer rail assemblies or metallized coating and are adjustable to account for variable temperature settings. Place supports near field splices of steel retainer rails to ensure that splices are straight and even.
- The proposed procedure to correct for the effects of beam movement and rotation when setting width of joint opening.
- The proposed installation procedure including the sequence and suggested direction of the concrete pour(s).
- The proposed mechanism to allow joint translation after the deck pour.
- A section through the joint detail showing horizontal offset dimensions of the steel retainer rails from the centerline of the joint. This detail is required when the vertical face of the joint opening is not perpendicular to the roadway surface (e.g. when the roadway grade is significant).
- For strip seal gland replacements, the proposed procedure for removing the existing strip seal gland and installing the new strip seal gland into the existing steel rails.

## **FABRICATION**

Fabricate the strip seal joint components in accordance with the approved shop drawings and the plans.

Splice sections of steel retainer rail in the shop to obtain required lengths. Do not use short pieces of steel retainer rail less than 6 feet 0 inches long unless required at curbs, sidewalks or staged construction locations. Splices in an individual steel retainer rail are only permitted where a construction joint is specifically required by the plans, joint segment length exceeds 50 feet, or approved by the Engineer in writing.

At splice locations where changes in deck slab cross slope occur, cut the ends of steel retainer rails parallel to the bridge centerline for skews less than 80° and greater than 100°.

Provide a neoprene gland that is compatible with the steel retainer rail. Produce a single continuous neoprene gland for the entire length of the joint. When necessary, only vulcanized splicing of the gland in the shop is permitted. Ensure the convolution(s) of the gland does not

project above the top of the steel retainer rails when the ambient temperature results in the minimum joint opening.

### SHIPMENT

Bolt the steel retainer rails together in the shop to form matching pairs. Clearly mark each pair to identify where they are to be placed. Ship the neoprene gland concurrently with the steel retainer rails and clearly mark them to identify where they are to be placed.

### INSTALLATION

Install the strip seal expansion joint in accordance with the plan details, this special provision, the *Standard Specifications*, and the manufacturer's recommended installation procedures. Have a manufacturer's representative present during installation of the joint.

#### Steel Retainer Rail Assemblies:

- Install the steel retainer rail assemblies at proper grade and alignment. See contract drawings for width of joint opening.
- Bolt, weld or clamp steel retainer rail assemblies in position using temporary or sacrificial brackets as required. Do not use temporary or sacrificial support brackets, bolts, clamps, etc. between the faces of the steel retainer rails. Do not weld within 2 inches of steel retainer rail surfaces exposed in the completed structure. Do not weld strip seal expansion joint components to reinforcing steel or structural steel.
- For staged construction, install steel retainer rail assemblies in a given subsequent stage to align with those installed in an adjacent prior stage after deflection and rotation due to deck casting of adjoining spans has occurred.
- Protect metalized steel retainer rail assemblies during screeding operations per the manufacturer's recommendations. Provide temporary blocking material in the steel retainer rail seal cavities to prevent concrete intrusion during deck pour and finishing.
- Loosen any temporary or sacrificial support brackets, bolts, clamps, etc. that span across the joint after initial set of concrete, but not more than two hours after conclusion of concrete placement.

#### Strip Seal Gland Replacement:

- Following manufacturer's recommended procedure for removing the existing strip seal gland from the steel retainer rails.
- Install the neoprene gland after completion of deck or overlay casting. Use a single continuous neoprene gland for the entire length of the joint. Field splicing of the neoprene gland is not permitted. Remove all joint form material and blocking material prior to installing the gland. Field install the gland in accordance with manufacturer's recommendations. Thoroughly coat all contact surfaces between the gland and the steel retainer rail seal cavities with an adhesive lubricant before setting the gland in place. Use lubricant adhesive that conforms to ASTM D4070 and is compatible with manufacturer's strip seal expansion joint to attach neoprene gland to the steel retainer rails.

**INSPECTION**

The Engineer inspects the joint system for proper alignment and proper stud placement and attachment. If any aspect of the strip seal expansion joint is deemed unacceptable, make the necessary corrections.

When concrete is cast, use a non-aluminum, 10 foot, true to line straight edge to check and grade the top of the slab on each side of the joint to ensure smooth transition between spans.

**Watertight Integrity Test**

- Upon completion of each strip seal expansion joint, perform a water test on the top surface to detect any leakage. Cover the roadway section of the joint from curb to curb, or barrier rail to barrier rail, with water, either ponded or flowing, not less than 1 inch above the roadway surface at all points. Block sidewalk sections and secure an unnozzled water hose delivering approximately 1 gallon of water per minute to the inside face of the bridge railing, trained in a downward position about 6 inches above the sidewalk, such that there is continuous flow of water across the sidewalk and down the curb face of the joint.
- Maintain the ponding or flowing of water on the roadway and continuous flow across sidewalks and curbs for a period of five (5) hours. At the conclusion of the test, the underside of the joint is closely examined for leakage. The strip seal expansion joint is considered watertight if no obvious wetness is visible on the Engineer's finger after touching a number of underdeck areas. Damp concrete that does not impart wetness to the finger is not considered a sign of leakage.
- If the joint system leaks, locate the place(s) of leakage and take any repair measures necessary to stop the leakage at no additional cost to the Department. Use repair measures recommended by the manufacturer and approved by the Engineer prior to beginning corrective work.
- If measures to eliminate leakage are taken, perform a subsequent water integrity test subject to the same conditions as the original test. Subsequent tests carry the same responsibility as the original test and are performed at no additional cost to the Department.

**BASIS OF PAYMENT**

*Strip Seals for Preservation* will be at the contract unit bid price per linear foot. Prices and payment will be full compensation for furnishing all material, including any steel accessory plates for sidewalks, medians and rails, labor, tools, and incidentals necessary for installing the strip seal in place and including all materials, labor, tools and incidentals for performing the original watertight integrity test.

**Pay Item**

Strip Seals for Preservation

**Pay Unit**

Linear Feet

**PAINTING EXISTING STRUCTURE****(2-11-19)****DESCRIPTION**

This work shall consist of furnishing all labor, equipment, and materials necessary to clean and paint the structural steel of the existing bridge. Work includes: removal, containment and disposal of the existing paint system; preparation of the surface to be painted and applying the new paint system; a containment enclosure; and any incidentals necessary to complete the project as specified and shown on the plans.

**TWELVE-MONTH OBSERVATION PERIOD**

The Contractor maintains responsibility for the coating system for a 12-month observation period beginning upon the satisfactory completion of all the work required in the plans or as directed by the Engineer. The Contractor shall guarantee the coating system under the payment and performance bond (refer to Article 109-10 of the *Standard Specifications*). To complete successfully the observation period, the coating system shall meet the following requirements after 12 months service:

- (A) No visible rust, contamination or application defect is observed in any coated area.
- (B) Painted surfaces have a uniform color and gloss.
- (C) Painted surfaces have an adhesion that meets an ASTM D3359, 3A rating.

Final acceptance is made only after the paint system meets the above requirements.

**SUBMITTALS**

Submit all of the following to the Engineer for review and approval before scheduling the pre-construction meeting. Allow at least two (2) weeks for the review process.

- (A) The existing paint systems include toxic substances such as red lead oxide, which are considered hazardous if improperly removed. The contractor shall be currently Society for Protective Coatings (SSPC) Quality Program (QP) 2, Category A certified, and have successfully completed lead paint removal and field painting on similar structures within 18 months prior to this bid. Lead abatement work completed within the 18 month period shall have been completed in accordance with contract specifications, free of citation from safety or environmental agencies. Lead abatement work shall include, but not be limited to: abrasive blasting; waste handling, storage and disposal; worker safety during lead abatement activities (fall protection, personal protective equipment (PPE), etc.); and containment. This requirement is in addition to the contractor pre-qualification requirements covered by Article 102-2 of the *Standard Specifications*.

The apparent low bidder shall submit a list of projects for which QP 2 work was performed within the last 18 months including owner contact information and submit to the Engineer a "Lead Abatement Affidavit". See link for form:

<https://www.ncdot.gov/initiatives-policies/Transportation/bridges/Documents/leadabatementaffidavit.pdf>.

- (B) Work schedule which shall be kept up to date, with a copy of the revised schedule being provided to the Engineer in a timely manner.
- (C) Containment system plans and design calculations in accordance with SSPC Guide 6, Class 2A and other project requirements, signed and sealed by a Professional Engineer licensed by the State of North Carolina.
- (D) Bridge wash water sampling and disposal plan.
- (E) Subcontractor identification.
- (F) Lighting plan for night work in accordance with Section 1413 of the *Standard Specifications*.
- (G) Traffic control plan with NCDOT certified supervisors, flaggers and traffic control devices.
- (H) Health and safety plan addressing at least the required topics as specified by the SSPC QP 1 and QP 2 program and including hazard communication, respiratory health, emergency procedures, and local hospital and treatment facilities with directions and phone numbers, disciplinary criteria for workers who violate the plan and accident investigation. The plan shall address the following: hazardous materials, personal protective equipment, general health and safety, occupational health and environmental controls, fire protection and prevention, signs signals, and barricades, materials handling, storage, use, and disposal, hand and power tools, welding and cutting, electrical, scaffolds, fall protection, cranes, derricks, hoists, elevators, and conveyors, ladders, toxic and hazardous substances, airless injection and high pressure water jet (HPWJ).
- (I) Provide the Engineer a letter of certification that all employees performing work on the project have blood lead levels that are below the Occupational Safety and Health Administration (OSHA) action level.
- (J) Provide the Engineer with Competent Person qualifications and summary of work experience.
- (K) Environmental Compliance Plan.
- (L) Quality Control Plan (Project Specific) with quality control qualifications and summary of work experience.
- (M) Bridge and Public Protection Plan (Overspray, Utilities, etc. - Project/Task Specific).
- (N) Abrasive Blast Media:
  - (1) Product Data Sheet.
  - (2) Blast Media Test Reports in accordance with Article 1080-12 of the *Standard Specification*.
- (O) Coating Material:
  - (1) NCDOT HICAMS Test Reports (testing performed by NCDOT Materials and Tests Unit).
  - (2) Product Data Sheets.
  - (3) Material Safety Data Sheets.
  - (4) Product Specific Repair Procedures.
  - (5) Acceptance letters from paint manufacturer's for work practices that conflict with special provisions and/or paint manufactures product data sheets.



### **PRE-CONSTRUCTION MEETING**

Submittals shall be reviewed and approved by the Engineer prior to scheduling the pre-construction meeting. Allow no less than two (2) weeks for a review process. When requesting a pre-construction meeting, contact the Engineer at least seven (7) working days in advance of the desired pre-construction date. The contractor's project supervisor, Competent Person, quality control personnel and certified traffic control supervisor shall be in attendance at the pre-construction meeting in order for the Contractor and NCDOT team to establish responsibilities for various personnel during project duration and to establish realistic timeframes for problem escalation.

### **CONTAINMENT SYSTEM**

Prior to performing any construction or painting operations on the structure, the Contractor shall furnish the Engineer with plans and design calculations for a sufficiently designed containment system, which will provide access for any repairs on structural steel members, cleaning and surface preparations for structural steel members, and coating operations for structural steel members of the bridge. The containment system shall not be installed, and no work shall begin, until the Engineer has reviewed and approved, in writing, the submitted containment system plans and design calculations. Containment system plans and design calculations shall be prepared, sealed, and signed by a Professional Engineer licensed by the State of North Carolina. Allow a minimum of two (2) weeks for review of the containment plans and calculations.

The containment system shall meet or exceed the requirements of Class 2A containment in accordance with SSPC Guide 6. The Contractor shall determine the required capacity of the containment system, which, at a minimum, shall include loads due to wind, repair materials and repair operations, equipment, and tools; however, the capacity shall not be less than that required by Federal or State regulations. Design steel members to meet the requirements of the *American Institute of Steel Construction Manual*. Design timber members in accordance with the *National Design Specification for Stress-Grade Lumber and Its Fastenings* of the National Forest Products Association. The containment system shall be constructed of materials capable of withstanding damage from any of the work required on this project and shall provide a two (2) hour resistance to fire.

In the containment system plans, describe how debris is contained and collected. Describe the type of tarpaulin, bracing materials, and the maximum designed wind load. Design wind loads shall be in accordance with the Falsework and Formwork special provision. Describe the dust collection system and how a negative pressure of 0.03 inches of water column is maintained inside the enclosure, while blasting operations are being conducted. Describe how the airflow inside the containment structure is designed to meet all applicable OSHA Standards. Describe how water run-off from rain will be routed by or through the enclosure. Describe how wash water will be contained and paint chips separated. Describe what physical containment will be provided during painting application to protect the public and areas not to be painted.

Drilling holes in the superstructure for the purpose of attaching the containment system is prohibited.

The Contractor will be responsible for certifying the containment system has been constructed in accordance with the approved plans.

The containment system shall be cleaned after each workday.

Upon completion of work, remove all anchorages in the substructure and repair the substructure at no additional cost to the Department.

Protect non-metallic parts of bearings from blasting and painting (i.e.: Pot Bearings, Elastomeric Pads, and Disc Bearings).

#### **WASH WATER SAMPLING AND DISPOSAL PLAN**

All wash water shall be collected and sampled prior to disposal. Representative sampling and testing methodology shall conform to North Carolina Administrative Code 15A NCAC 02B.0103, "Analytical Procedures". Wash water shall be tested for pollutants listed in 15A NCAC 02B.0211(3), 15A NCAC 02T.0505(b)(1) and 15A NCAC 2T.0905(h). Depending on the test results, wash water disposal methods shall be described in the disposal plan. Wash water shall be disposed of in accordance with all current Federal and State regulations. See link for NCDOT Guidelines for Managing Bridge Wash Water:

<https://www.ncdot.gov/initiatives-policies/Transportation/bridges/Documents/WashWater.pdf>

#### **WASTE HANDLING OF PAINT AND ABRASIVES**

Comply with all Federal, State, and local regulations. Failure to comply with the regulations could result in fines and loss of qualified status with NCDOT.

Comply with the Resource Conservation and Recovery Act (RCRA - 40 CFR 261 - 265) and the Occupational Safety and Health Act (OSHA - 29 CFR 1910 - 1926) regulations for employee training, and for the handling, storage, labeling, recordkeeping, reporting, inspections and disposal of all hazardous waste generated during paint removal.

A summary of Generator Requirements is available at the above NCDOT web link, which cites the specific regulations for each Generator category. Quantities of waste by weight and dates of waste generation shall be recorded. Waste stored at the project site shall be properly labeled. All waste, hazardous or non-hazardous, requires numbered shipping manifests.

The North Carolina Department of Environmental Quality (NCDEQ) have adopted RCRA as the North Carolina Hazardous Waste Management Rules and are responsible for enforcement. The *Hazardous Waste Generator Compliance Manual* is published by the Compliance Branch of the Division of Waste Management of NCDEQ, and can be found at: <https://files.nc.gov/ncdeq/Waste%20Management/DWM/HW/Compliance/Generator%20Compliance%20Manual.pdf>

Immediately after award of the contract, arrange for waste containers, sampling, testing, transportation, and disposal of all waste. No work shall begin until the Contractor furnishes the Engineer with a written waste disposal plan. Any alternative method for handling waste shall be

pre-approved by the Engineer. Use an approved waste management company from the following link:

<https://www.ebs.nc.gov/VendorDirectory/results.html?sap-params=cD0xJTIwJmN1cnJlbnRfc2VhcmNoX3BhZ2U9d2Mmc2VsZWNoaW9uX2Zpcm1fbmFtZT0mc2VsZWNoaW9uX2NlcnQ9JnNlbGVjdGlvl9maXJtdHlwZT0meXNjX2Zpcm10eXBIPSZzZWxlY3Rpb25fd29ya2xvY2F0aW9uPSZ5c2Nfd29ya2xvY2F0aW9uPSZzZWxlY3Rpb25fYWRkenN0YXRIPSZ5c2NfYWRkenN0YXRIPSZzZWxlY3Rpb25fYWRkcmNvdW50eT0meXNjX2FkZHIjb3VudHk9JnNlbGVjdGlvl93a2NvZGU9MDAzMDQwJnlzY193a2NvZGU9MDAzMDQwJTIwQ09OVEFNSU5BVEVEJTIwTUFURVJJQUxTJTIwUkVNT1ZBTCZzZWxlY3Rpb25fZGlzYz0meXNjX2Rpc2M9JnNlbGVjdGlvl9uYWIjcz0meXNjX25haWNzPSZzZWxlY3Rpb25fY3R5cGU9MA%3d%3d>

All removed paint and spent abrasive media shall be tested for lead following the SW-846 Toxicity Characteristic Leaching Procedure (TCLP) Method 1311 Extraction, as required in 40 CFR 261, Appendix 11, to determine whether it shall be disposed of as hazardous waste. Furnish the Engineer certified test reports showing TCLP results of the paint chips stored on site, with disposal in accordance with “Flowchart on Lead Waste Identification and Disposal” at:

<https://ncdenr.s3.amazonaws.com/s3fs-public/document-library/Lead%20Disposal.pdf>

All sampling shall be done in presence of the Engineer’s representative.

The Competent Person shall obtain composite samples from each barrel of the wash water and waste generated by collecting two or more portions taken at regularly spaced intervals during accumulation. Composite the portions into one sample for testing purposes. Acquire samples after 10% or before 90% of the barrel has accumulated. The intent is to provide samples that are representative of widely separated portions, but not the beginning and end of wash water or waste accumulation.

Perform sampling by passing a receptacle completely through the discharge stream or by completely diverting the discharge into a sample container. If discharge of the wash water or waste is too rapid to divert the complete discharge stream, discharge into a container or transportation unit sufficiently large to accommodate the flow and then accomplish the sampling in the same manner as described above.

Comply with the NCDEQ *Hazardous Waste Compliance Generator Manual*. Record quantities of waste by weight and dates of waste generation. Until test results are received, store all waste, and label as “NCDOT Bridge Paint Removal Waste - Pending Analysis” and include the date generated and contact information for the Engineer. Store waste containers in an enclosed, sealed, and secured storage container protected from traffic from all directions. Obtain approval for the protection plan for these containers from the Engineer. If adequate protection cannot be obtained by use of existing guardrail, provide the necessary supplies and equipment to maintain adequate protection. Once test results are received and characterized, label waste as either “Hazardous Waste - Pending Disposal” or “Paint Waste - Pending Disposal”.

Once the waste has been collected, and the quantities determined, prepare the appropriate shipping documents and manifests and present them to the Engineer. The Engineer will verify the type and

quantity of waste and obtain a Provisional Environmental Protection Agency (EPA) ID number from:

Melodi Deaver  
Division of Waste Management/Hazardous Waste Section  
North Carolina Department of Environmental Quality  
1646 Mail Service Center  
Raleigh, NC 27699  
Phone: (919) 707-8204, Email: [melodi.deaver@ncdenr.gov](mailto:melodi.deaver@ncdenr.gov)

At the time of shipping, the Engineer will sign, date, and add the ID number in the appropriate section on the manifest. The maximum on-site storage time for collected waste shall be 90 calendar days. All waste whether hazardous or non-hazardous will require numbered shipping manifests. The cost for waste disposal (including lab and Provisional EPA ID number) is included in the bid price for this contract. Note NC Hazardous Waste Management Rules (15A NCAC 13A) for more information. Provisional EPA ID numbers may be obtained at:

<https://deq.nc.gov/about/divisions/waste-management/hw/provisional-notification>

Testing labs shall be certified in accordance with North Carolina State Laboratory Public Health Environmental Sciences. List of certified laboratories may be obtained at:

<https://slphreporting.ncpublichealth.com/Certification/CertifiedLaboratory.asp>

All test results shall be documented on the lab analysis as follows:

(A) For leachable lead:

(1) Soils/Solid/Liquid- EPA 1311/200.7/6010

Area sampling will be performed for the first two (2) days at each bridge location. The area sample will be located within five (5) feet of the containment and where the highest probability of leakage will occur (access door, etc.). Results from the area sampling will be given to the Engineer within 72 hours of sampling (excluding weekends). If the results of the samples exceed  $20 \mu\text{g}/\text{m}^3$  corrective measures shall be taken and monitoring shall be continued until two (2) consecutive sample results are less than  $20 \mu\text{g}/\text{m}^3$ .

Time Weighted Average (TWA) may suspend the work if there are visible emissions outside the containment enclosure or pump monitoring results exceeding the level of  $30 \mu\text{g}/\text{m}^3$ .

Where schools, housing and/or buildings are within 500 feet of the containment, the Contractor shall perform initial Total Suspended Monitoring (TSP) Lead monitoring for the first ten (10) days of the project during abrasive blasting, vacuuming and containment removal. Additional monitoring will be required during abrasive blasting two (2) days per month thereafter. Results of the TSP monitoring at any location shall not exceed  $1.5 \mu\text{g}/\text{m}^3$ .

## EQUIPMENT MOBILIZATION

The equipment used in any travel lanes and paved shoulder shall be mobile equipment on wheels that has the ability to move on/off the roadway in less than 30 minutes. All work conducted in

travel lanes shall be from truck or trailer supported platforms and all equipment shall be self-propelled or attached to a tow vehicle at all times.

#### **QUALITY CONTROL INSPECTOR**

Provide a quality control (QC) inspector in accordance with the SSPC QP guidelines to ensure that all processes, preparation, blasting and coating application are in accordance with the requirements of the contract. The inspector shall have written authority to perform QC duties to include continuous improvement of all QC internal procedures. The presence of the engineer or inspector at the work site shall in no way lessen the contractor's responsibility for conformity with the contract.

#### **QUALITY ASSURANCE INSPECTOR**

The quality assurance inspector which may be a Department employee or a designated representative of the Department shall observe, document, assess, and report that the Contractor is complying with all of the requirements of the contract. Inspectors employed by the Department are authorized to inspect all work performed and materials furnished. Such inspection may extend to all or any part of the work and to the preparation, fabrication, or manufacture of the materials to be used. The inspector is not authorized to alter or waive the requirements of the contract. Each stage in preparing the structure to be coated which includes but not limited to washing, blasting, coating testing and inspection shall be inspected and approved by the Engineer or an authorized representative.

#### **SUBLETTING OF CONTRACT**

Only contractors certified to meet SSPC QP 2, Category A, and have successfully completed lead paint removal and field painting on all similar structures within 18 months prior to this bid are qualified for this work. Work is only sublet by approval of the Engineer.

#### **PREPARATION OF SURFACES**

Before any other surface preparation is conducted, all surfaces shall be power washed to remove dust, salts, dirt, and other contaminants. All wash water shall be contained, collected, and tested in accordance with the requirements of NCDOT Guidelines for Managing Bridge Wash Water. Obtain approval of the Engineer and allow all cleaned surfaces to dry to the touch and without standing water before beginning surface preparation or painting activities.

Surface preparation is done with materials meeting Article 1080-12 of the *2 Standard Specifications*. No silica sand or other silica materials are permitted for use. The profile shall be between 1.0 and 3.0 mils when measured on a smooth steel surface. Conduct and document at least two (2) tests per beam/girder and two (2) tests per span of diaphragms/cross bracing.

Spread tarpaulins over all pavements and surfaces underneath equipment used for abrasive blasting as well as equipment and containers used to collect abrasive media. This requirement will be enforced during activity and inactivity of equipment.

Before the Contractor departs from the work site at the end of the workday, collect all debris generated during surface preparation and all dust collector hoses, tarps or other appurtenances containing blasting residue in approved containers.

Clean a 3" x 3" area at each structure to demonstrate the specified finish, and the inspector will preserve this area by covering it with tape, plastic or some other suitable means so that it can be retained as the Dry Film Thickness (DFT) gauge adjustment standard. An acceptable alternative is for the Contractor to provide a steel plate with similar properties and geometry as the substrate to be measured.

The contractor and or quality assurance representative shall notify the Engineer of any area of corroded steel that has lost more than 50% of its original thickness.

All parts of the bridges not to be painted and the travelling public shall be protected from overspray. Submit a plan to protect all parts of bridge that are not required to be painted and a plan to protect the traveling public and surrounding environment while applying all coats of paint to a structure.

Ensure that chloride levels on the surfaces are  $7 \mu\text{g}/\text{cm}^2$  or lower using an acceptable sample method in accordance with SSPC Guide 15. The frequency of testing shall be two (2) tests per span after all surface preparation has been completed and immediately prior to painting. Select test areas representing the greatest amount of corrosion in the span as determined by the Engineers' representative. Additional testing may be required if significant amounts of chloride are detected.

All weld splatter, slag or other surface defects resulting in a raised surface above the final paint layer shall be removed prior to application of primer coat.

#### **PAINTING OF STEEL**

Paint System 1, as specified in these special provisions and Article 442-8 of the *Standard Specifications*, is to be used for this work. System 1 is an inorganic zinc primer, two coats acrylic paint, and one stripe coat of acrylic paint over blast-cleaned surfaces in accordance with SSPC-SP-10 (Near White Blast). Perform all mixing operations over an impervious surface with provisions to prevent runoff to grade of any spilled material. The contractor is responsible for reporting quantities of thinner purchased as well the amounts used. No container with thinner shall be left uncovered, when not in use.

Apply 2" stripe coat, by brush or roller only, to all exposed edges of steel including fasteners before applying the finish coat. Locate the edge or corner in the approximate center of the paint stripe.

Any area where newly applied paint fails to meet the specifications shall be repaired or replaced by the Contractor, at no additional cost to the Department. The Engineer approves all repair processes before the repair is made. Repaired areas shall meet the *Standard Specifications*. The Contractor applies an additional finish coat of paint to areas where the tape adhesion test is conducted.

**MATERIALS**

Only paint suppliers that have a NCDOT qualified inorganic zinc primer may furnish paints for this project. All paints applied to a structure shall be from the same supplier. Before any paints are applied the Contractor shall provide the Engineer a manufacturer's certification that each batch of paint meets the requirements of the applicable Section 1080 of the *Standard Specifications*.

The inspector randomly collects a one pint sample of each paint product used on the project. Additional samples may be collected as needed to verify compliance to the specifications.

Do not expose paint materials to rain, excessive condensation, long periods of direct sunlight, or temperatures above 110°F or below 40°F. In addition, the Contractor shall place a device that records the high, low, and current temperatures inside the storage location. Follow the manufacturer's storage requirements if more restrictive than the above requirements.

**INSPECTION**

Surface Preparation for System 1 shall be in accordance with SSPC SP-10. Any area(s) not meeting the requirements of SSPC SP-10 shall be remediated prior to application of coating. Surface inspection is considered ready for inspection when all blast abrasive, residue and dust is removed from surfaces to be coated.

**(A) Quality Assurance Inspection**

The Contractor furnishes all necessary OSHA approved apparatus such as ladders, scaffolds and platforms as required for the inspector to have reasonable and safe access to all parts of the work. The contractor illuminates the surfaces to be inspected to a minimum of 50-foot candles of light. All access points shall be illuminated to a minimum of 20-foot candles of light.

NCDOT reserves the right for ongoing Quality Assurance (QA) inspection to include but not limited to surface contamination testing, adhesion pull testing, and DFT readings as necessary to assure quality.

Inform the Engineer and the Division Safety Engineer of all scheduled and unannounced inspections from SSPC, OSHA, EPA and/or others that come on site. Furnish the Engineer a copy of all inspection reports except for reports performed by a third party and or consultant on behalf of the Contractor.

**(B) Inspection Instruments**

At a minimum, furnish the following calibrated instruments and conduct the following quality control tests:

- (1) Sling Psychrometer - ASTM E337 - bulb type
- (2) Surface Temperature Thermometer
- (3) Wind Speed Indicator
- (4) Tape Profile Tester - ASTM D4417 Method C

- (5) Surface Condition Standards - SSPC VIS-1 and VIS-3
- (6) Wet Film Thickness Gage - ASTM D4414
- (7) Dry Film Thickness Gage - SSPC-PA2 Modified
- (8) Solvent Rub Test Kit - ASTM D4752
- (9) Adhesion Test Kit - ASTM D3359 Method A (Tape Test)
- (10) Adhesion Pull test - ASTM D4541
- (11) Surface Contamination Analysis Kit or (Chloride Level Test Kit) SSPC Technology Guide 15

(C) Quality Control

Maintain a daily quality control record in accordance with Subarticle 442-12(D) of the *Standard Specifications* and make such records available at the job site for review by the inspector and submit to the Engineer as directed. In addition to the information required on Form M&T-610, submit all Dry Film Thickness (DFT) readings on a form equivalent to Form M&T-611. These forms can be found at:

<https://connect.ncdot.gov/resources/Materials/Pages/Materials-Manual-by-Material.aspx?Order=MM-03-02>

- (1) Measure DFT at each spot on the attached diagram and at the required number of locations as specified below:
  - (a) For span members less than 45 feet; three (3) random locations along each girder in each span.
  - (b) For span members greater than 45 feet; add one additional location for each additional ten (10) feet in span length.

DFT measurements for the prime coat shall not be taken for record until the zinc primer has cured in accordance with ASTM D4752 (MEK Rub Test) with no less than a four (4) resistance rating.

Stiffeners and other attachments to beams and or plate girders shall be measured at no less than five (5) random spots per span. Also, dry film thickness is measured at no less than six (6) random spots per span on diaphragms/cross frames.

Each spot is an average of three (3) to five (5) individual gage readings as defined in SSPC PA-2. No spot average shall be less than 80% of minimum DFT for each layer applied; this does not apply to stripe coat application. Spot readings that are non-conforming shall be re-assessed by performing additional spot measurements not to exceed one-foot intervals on both sides of the low areas until acceptable spot averages are obtained. These non-conforming areas shall be corrected by the Contractor prior to applying successive coats.



**Less than 36" in height and/or bottom flanges less than 16" in width.**

**7 Spot Areas**

**21 Individual DFT Readings**

**36" in height or greater and/or bottom flanges greater than 16" in width.**

**10 Spot Areas**

**30 Individual DFT Readings**

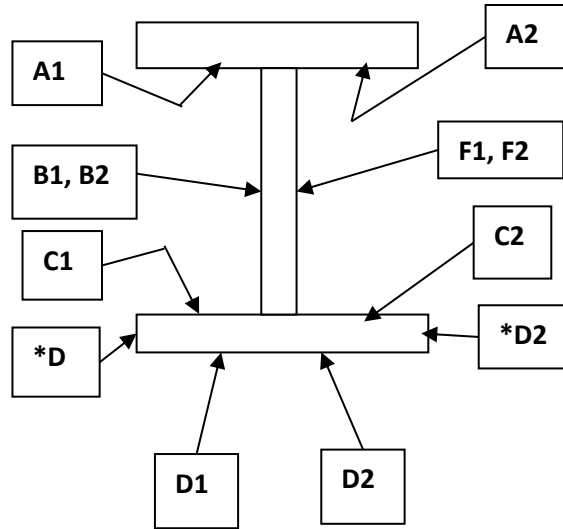
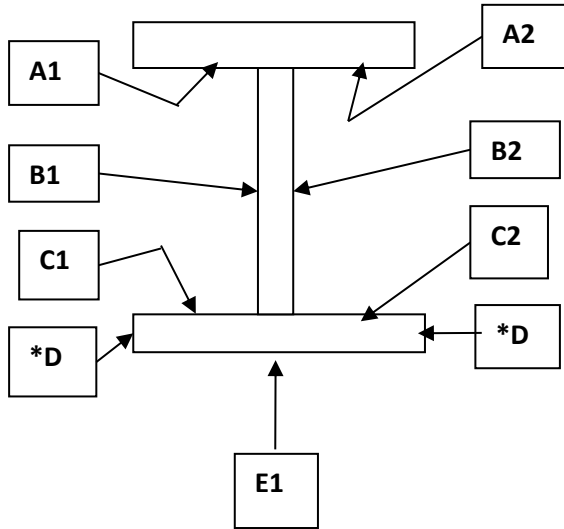

**\*D areas are only included when flange thickness is one inch (1") or greater.**

**\*D areas are only included when flange thickness is one inch (1") or greater.**

- (2) Two (2) random adhesion tests (1 test = 3 dollies) per span are conducted on interior surfaces in accordance with ASTM D4541 (Adhesion Pull Test) after the prime coat has been properly cured in accordance with ASTM D4752 (MEK Rub Test) with no less than a four (4) resistance rating, and will be touched up by the Contractor. The required minimum average adhesion is 400 psi.
- (3) Cure of the intermediate and stripe coats shall be accessed by using the thumb test in accordance with ASTM D1640 (Curing Formation Test) prior to the application of any successive layers of paint.
- (4) One random Cut Tape adhesion test per span is conducted in accordance with ASTM D3359 (X-Cut Tape Test) on interior surface after the finish coat is cured. Repair areas shall be properly tapered and touched up by the Contractor.

**SAFETY AND ENVIRONMENTAL COMPLIANCE PLANS**

Personnel access boundaries are delineated for each work site using signs, tape, cones, or other approved means. Submit copies of safety and environmental compliance plans that comply with SSPC QP 2 Certification requirements.

**HEALTH AND SAFETY RESPONSIBILITIES**

This project may involve toxic metals such as arsenic, lead, cadmium and hexavalent chromium. It is the contractor's responsibility to test for toxic metals and if found, comply with the OSHA regulations, which may include medical testing.

Ensure a "Competent Person" as defined in OSHA 29 CFR 1926.62; one who is capable of identifying existing and predictable hazards in the surroundings or working conditions which are unsanitary, hazardous, or dangerous to employees, and who has authorization to take prompt corrective measures to eliminate them; is on site during all surface preparation activities and monitors the effectiveness of containment, dust collection systems and waste sampling. Before any work begins, provide a written summary of the Competent Person's safety training.

Comply with Subarticle 442-14(B) of the *Standard Specifications*.

Comply with Subarticle 442-14(D) of the *Standard Specifications*. Ensure employee blood sampling test results are less than 50 micrograms per deciliter. Remove employees with a blood sampling test of 50 or more micrograms per deciliter from work activities involving any lead exposure.

An employee who has been removed with a blood level of 50 micrograms per deciliter or more shall have two (2) consecutive blood sampling tests spaced one week apart indicating that the employee's blood lead level is at or below 40 micrograms per deciliter before returning to work activities involving any lead exposure.

All OSHA recordable accidents that occur during the project duration are to be reported to the Engineer within twenty-four (24) hours of occurrence. In addition, for accidents that involve civilians or property damage that occurs within the work zone the Division Safety Engineer shall be notified immediately.

Prior to blasting operations, the Contractor shall have an operational OSHA approved hand wash station at each bridge location and a decontamination trailer at each bridge or between bridges unless the work is on the roadway, or the Contractor shall show reason why it is not feasible to do so and provide an alternative site as approved by the Engineer. The Contractor shall assure that all employees whose airborne exposure to lead is above the Permissible Exposure Limit (PEL) shall shower at the end of their work shift.

**STORAGE OF PAINT AND EQUIPMENT**

Provide a location for materials, equipment, and waste storage. Spread tarpaulins over all pavements and surfaces underneath equipment used for abrasive recycling and other waste handling equipment or containers. All land and or lease agreements that involve private property

shall disclose to the property owner that heavy metals may be present on the Contractor's equipment. Prior to storing the Contractor's equipment on private property, provide a notarized written consent signed by the land owner received by the Engineer at least forty-eight (48) hours before using property. All storage of paint, solvents, and other materials applied to structures shall be stored in accordance with Subarticle 442-9(C) of the *Standard Specifications* or the manufacturers' requirements. The more restrictive requirements will apply.

**UTILITIES**

Protect all utility lines or mains that may be supported on, under, or adjacent to bridge work sites from damage and paint overspray.

**MEASUREMENT AND PAYMENT**

The cost of inspection, surface preparation, and repainting the existing structure is included in the lump sum price bid for *Cleaning and Repainting of Bridge #\_\_\_*. This price is full compensation for furnishing all inspection equipment, all paint, cleaning abrasives, cleaning solvents and all other materials; preparing and cleaning surfaces to be painted; applying paint in the field; protecting work area, traffic and property; and furnishing blast cleaning equipment, paint spraying equipment, brushes, rollers, any other hand or power tools and any other equipment.

*Pollution Control* will be paid at the contract lump sum price which will be full compensation for all collection, handling, storage, air monitoring, and disposal of debris and wash water, all personal protective equipment, and all personal hygiene requirements, and all equipment, material and labor necessary for the daily collection of the blast debris into specified containers; and any measures necessary to ensure conformance to all safety and environmental regulations as directed by the Engineer.

*Painting Containment for Bridge #\_\_\_* will be paid at the lump sum contract price and will be full compensation for the design, materials, installation, maintenance, and removal of the containment system.

Payment will be made under:

<b>Pay Item</b>	<b>Pay Unit</b>
Cleaning and Repainting of Bridge #___	Lump Sum
Pollution Control	Lump Sum
Painting Containment for Bridge #___	Lump Sum

**SCOPE OF WORK**

**Bridge #500106:** This bridge was built in 1956 and widened in 1996 and carries I-95 NBL over SR1927/SR2305/Norfolk Southern RR. The superstructure consists of 3 continuous spans with 7 lines of steel 3 - 44 1/2" deep steel plate girders & 4 -54" deep steel buildup beams 1@5'-0", 3@8'-0", 1@ 4'-0", 1@7'-0" spacing with steel diaphragms, 3 simple spans with 7 lines of W36x135

beams 1@5'-0", 3@8'-0, 1@ 4'-0", 1@7'-0" spacing with steel diaphragms. The bridge has an overall length of 404'-2¼ " with a concrete deck and a 45'-1" total deck width. The minimum vertical clearance is 23'-0". The existing paint system is aluminum over red lead, and the estimated area to be cleaned and painted is **32,865** sq. ft.

**Bridge #500107:** This bridge was built in 1956 and widened in 1996 and carries I-95 SBL over SR1927/SR2305/Norfolk Southern RR. The superstructure consists of 3 continuous spans with 7 lines of steel, 3 - 44 ½" deep steel plate girders & 4 - 54" deep steel buildup beams 1@7'-0", 1@ 4'-0", 3@8'-0", 1@5'-0" spacing with steel diaphragms, 3 simple spans with 7 lines of W36x135 beams 1@7'-0", 1@ 4'-0", 3@8'-0, 1@5'-0" spacing with steel diaphragms. The bridge has an overall length of 404'-2¼ " with a concrete deck and a 45'-1" total deck width. The minimum vertical clearance is 23'-0". The existing paint system is aluminum over red lead, and the estimated area to be cleaned and painted is **32,865** sq. ft.

**CONCRETE FOR DECK REPAIR**

**(2-11-19)**

**DESCRIPTION**

This special provision addresses the material requirements of high early strength structural concrete to be used for reconstruction of deck slab and, if necessary, bent diaphragms as noted in the plans.

**MATERIALS**

Furnish Department approved pre-packaged concrete or bulk concrete materials in a mix proportioned to satisfy provisions for Class AA Concrete detailed in Article 1000-5 of the *Standard Specifications* or as otherwise noted in this special provision. Concrete mix shall meet the following requirements:

Physical Property	Threshold Limitation	Test Method
Compressive Strength (at 3 hrs.)	4,500 psi (min.)	ASTM C39/C109
Slump	4 in. (min.) 7 in. (max.)	AASHTO T119
Water to Cement Ratio	0.450 (max.)	N/A
Modulus of Elasticity (at 28 days)	5,200 ksi (max.)	ASTM C469

Coefficient of Thermal Expansion (at 28 days)	4.5 in./in./°F (min.)	AASHTO T336
	5.5 in./in./°F (max.)	
Concrete Setting Times	Initial	ASTM C191
	Final	
	30 min. (max.)	
	40 min. (max)	

Concrete shall be capable of placement on existing concrete substrate surfaces within the following temperature limitations:

40°F (min.)

100°F (max.)

Measurement for determination of concrete material compositions shall be in accordance with Article 1000-8 of the *Standard Specifications*.

Submit pre-packaged concrete mix contents or concrete mix design, including laboratory compressive strength data, for a minimum of six (6) 4-inch diameter by 8-inch cylinders at an age of three (3) hours and six (6) 4-in diameter by 8-inch cylinders at an age of 1 day to the Engineer for review. Include test results for the slump and air content of the laboratory mix. Perform tests in accordance with AASHTO T119 and T152.

Provide aggregates that are free from ice, frost and frozen particles when introduced into the mixer.

For equipment, proportioning and mixing of concrete compositions, see Article 1000-12 of the *Standard Specifications* and the Volumetric Mixer special provision. Prior to beginning any work, obtain approval for all equipment to be used for joint area preparation, mixing, placing, finishing, and curing the deck repair concrete.

**Measurement and Payment**

No separate payment will be made for Concrete for Deck Repair. The furnishing and placing of Concrete for Deck Repair shall be incidental to applicable pay items.

**EPOXY RESIN INJECTION**

**(08-08-22)**

**GENERAL**

For repairing cracks, an applicator certified by the manufacturer of epoxy injection system to be used is required to perform the epoxy resin injection. The Contractor shall submit documentation that indicates the firm, supervisor and the workmen have completed an instruction program in the methods of restoring concrete structures utilizing the epoxy injection process and have five (5) years of relative experience with a record of satisfactory performance on similar projects.

The Contractor furnishes all materials, tools, equipment, appliances, labor and supervision required when repairing cracks with the injection of an epoxy resin adhesive.

**SCOPE OF WORK**

Using Epoxy Resin Injection, repair cracks 25 mils (625 μm) wide or greater in the interior bent columns and caps, in the ends of the girders, in the cantilevered portion of the ends of the girders, and in the cantilevered portion of the superstructure deck.

**SUBMITTALS**

Prior to construction, the Contractor shall submit the following to the Engineer for review and approval:

- (A) Materials – Information detailing the materials and their properties, storage and handling requirements, and Material Safety Data Sheets. Material certifications and sampling shall be as required as per the NCDOT *Standard Specifications* Section 106.
- (B) Injection Procedures – Preparation and epoxy injection installation procedures, including written instructions from the manufacturer of the proportioning dispenser and the procedures recommended to monitor and assure its proportioning accuracy of the unit.
- (C) Contingencies – Proposed injection repair procedures in the event that during testing it is found that the injection installation procedure did not completely fill the cracks with epoxy.
- (D) Qualifications – The resumes of the Contractor’s staff and/or the epoxy resin manufacturer’s Technical Representative that will be on site performing the epoxy injection. The resumes shall detail the installer's applicable certifications and epoxy injection installation experience.
- (E) References – The names and telephone numbers of contact persons for recent (< 2years?) epoxy injection projects.

**COOPERATION**

Cooperate and coordinate with the Technical Representative of the epoxy resin manufacturer for satisfactory performance of the work.

Have the material manufacturer's Technical Representative present when the epoxy resin injection process begins and until the Engineer is assured that their service is no longer needed.

The expense of having this representative on the job is the Contractor’s responsibility at no additional cost to the Department.

**MATERIAL PROPERTIES**

Provide a two-component structural epoxy adhesive for injection into cracks or other voids. Provide modified epoxy resin (Component “A”) that conforms to the following requirements:

Test Method	Specification Requirements
-------------	----------------------------

Viscosity @ 40 ± 3°F, cps	Brookfield RVT Spindle No. 4 @ 20 rpm	6,000 – 8,000
Viscosity @ 77 ± 3°F, cps	Brookfield RVT Spindle No. 2 @ 20 rpm	400 - 700
Epoxide Equivalent Weight	ASTM D1652	152 - 168
Ash Content, %	ASTM D482	1 max.

Provide the amine curing agent (Component “B”) used with the epoxy resin that meets the following requirements:

	Test Method	Specification Requirements
Viscosity @ 40 ± 3°F, cps	Brookfield RVT Spindle No. 2 @ 20 rpm	700 - 1400
Viscosity @ 77 ± 3°F, cps	Brookfield RVT Spindle No. 2 @ 20 rpm	105 - 240
Amine Value, mg KOH/g	ASTM D664*	490 - 560
Ash Content, %	ASTM D482	1 max.
		* Method modified to use perchloric acid in acetic acid.

Certify that the Uncured Adhesive, when mixed in the mix ratio that the material supplier specifies, has the following properties:

- Pot Life (60 gram mass)
  - @ 77 ± 3°F - 15 minutes minimum
  - @ 100 ± 3°F - 5 minutes minimum

Certify that the Adhesive, when cured for seven (7) days at 77 ± 3°F unless otherwise specified, has the following properties:

	Test Method	Specification Requirements
Ultimate Tensile Strength	ASTM D638	7,000 psi (min.)
Tensile Elongation at Break	ASTM D638	4% max.
Flexural Strength	ASTM D790	10,000 psi (min.)
Flexural Modulus	ASTM D790	3.5 x 10 <sup>5</sup> psi
Compressive Yield Strength	ASTM D695	11,000 psi (min.)
Compressive Modulus	ASTM D695	2.0 - 3.5 x 10 <sup>5</sup> psi
Heat Deflection Temperature	ASTM D648*	125°F min.

Cured 28 days @ 77 ± 3°F		135°F min.
Slant Shear Strength, 5,000 psi (34.5 MPa) compressive strength concrete	AASHTO T237	
Cured 3 days @ 40°F wet concrete		3,500 psi (min.)
Cured 7 days @ 40°F wet concrete		4,000 psi (min.)
Cured 1 day @ 77°F dry concrete		5,000 psi (min.)
* Cure test specimens so the peak exothermic temperature does not exceed 77°F.		

Use an epoxy bonding agent, as specified for epoxy mortar, as the surface seal (used to confine the epoxy resin during injection).

**EQUIPMENT FOR INJECTION**

Use portable positive displacement type pumps with interlock to provide positive ratio control of exact proportions of the two (2) components at the nozzle to meter and mix the two (2) injection adhesive components and inject the mixed adhesive into the crack. Use electric or air powered pumps that provide in-line metering and mixing.

Use injection equipment with automatic pressure control capable of discharging the mixed adhesive at any pre-set pressure up to 200 ± 5 psi and equipped with a manual pressure control override.

Use equipment capable of maintaining the volume ratio for the injection adhesive as prescribed by the manufacturer. A tolerance of ± 5% by volume at any discharge pressure up to 200 psi is permitted.

Provide injection equipment with sensors on both the Component A and B reservoirs that automatically stop the machine when only one component is being pumped to the mixing head.

**PREPARATION**

Follow these steps prior to injecting the epoxy resin:

- (A) Remove all dirt, dust, grease, oil, efflorescence and other foreign matter detrimental to the bond of the epoxy injection surface seal system from the surfaces adjacent to the cracks or other areas of application. Acids and corrosives are not permitted.
- (B) Provide entry ports along the crack at intervals determined by the Contractor to ensure full penetration of the crack.
- (C) Apply surface seal material to the face of the crack between the entry ports. For through cracks, apply surface seal to both faces.



- (D) Allow enough time for the surface seal material to gain adequate strength before proceeding with the injection.
- (E) Perform an air pressure check of the surface seal to ensure the system is airtight prior to proceeding with the injection.

### **EPOXY INJECTION**

Before epoxy adhesive injection occurs, the Contractor shall test discharge one pint of epoxy to calibrate the equipment and to demonstrate that the workmen and equipment are working properly.

Follow approved preparation and installation procedures submitted by the Contractor. It is the Contractor's responsibility to achieve full penetration of cracks being injected.

Perform epoxy adhesive injection continuously until cracks are completely filled. Pressure shall be maintained until complete refusal of material is achieved. Any stoppage of injection for more than 15 minutes shall result in the injection equipment being cleaned, at no additional cost to the Department, before resuming injection.

If port to port travel of epoxy adhesive is not indicated, or the surface seal and/or ports become dislodged, immediately stop the work and notify the Engineer.

### **TESTING**

The Contractor shall core 3" diameter by 6" deep samples of the cured epoxy to verify the cracks have been completely filled with epoxy. When coring, care shall be taken to avoid existing steel reinforcement, where possible. Injection will not proceed beyond the initial 50 feet until three (3) cores have been submitted to, and approved by, the Engineer. If the epoxy does not penetrate a minimum of 6" or the full depth of the crack, whichever is less, the repair will be rejected, and the contractor shall follow their proposed repair procedure that has been approved by the Engineer. The presence of the technical representative will be required when repairs begin.

The Engineer will take possession of the cores from the repaired concrete for compressive strength testing. If the failure plane is located at the repaired crack, a minimum compressive strength of 3,000 psi is required of these cores. The cost of coring is incidental to the pay item for epoxy injection. If the core fails, the contractor will be required to take corrective action before proceeding and another 50' test section will be required.

After the contractor demonstrates acceptable repairs, cores will be taken at a rate of one per 100 linear feet of repair until completion of the work or unacceptable cores are encountered.

### **FINISHING**

When cracks are completely filled, allow the epoxy adhesive to cure for sufficient time to allow the removal of the surface seal without any draining or runback of epoxy material from the cracks.

Fill all cored holes with Type 3 grout in accordance with Section 1003 of the *Standard Specifications*.

Remove the surface seal material and injection adhesive runs or spills from concrete surfaces.

Finish the face of the crack and all core holes flush to the adjacent concrete, removing any indentations or protrusions caused by the placement of entry ports or grout placement.

**BASIS OF PAYMENT**

*Epoxy Resin Injection* will be paid at the contract unit price per linear foot. For full depth cracks, payment will be made for one side only. Such payment will be full compensation for all materials, tools, equipment, labor, coring and for all incidentals necessary to complete the work.

<b>Pay Item</b>	<b>Pay Unit</b>
Epoxy Resin Injection	Linear Foot

**SHOTCRETE REPAIRS**

**(08-08-22)**

**GENERAL**

The work covered by this special provision consists of removing deteriorated concrete from the structure in accordance with the limits, depth and details shown on the plans, described herein and as established by the Engineer. This work also includes removing and disposing all loose debris, cleaning and repairing reinforcing steel and applying structural shotcrete.

The location and extent of repairs shown on the plans are general in nature. The Engineer shall determine the extent of removal in the field based on an evaluation of the condition of the exposed surfaces.

Any portion of the structure that is damaged from construction operations shall be repaired to the Engineer’s satisfaction, at no extra cost to the Department.

**MATERIAL REQUIREMENTS**

Use prepackaged dry mix shotcrete conforming to the requirements of ASTM C1480, the applicable sections of the *Standard Specifications* and the following:

Test Description	Test Method	Age (Days)	Specified Requirements
Silica Fume (%)	ASTM C1240	-	10 (Max.)
Air Content - As Shot (%)	ASTM C231 or ASTM C457	-	5 ± 2
Minimum Compressive Strength (psi)	ASTM C109	7 28	3,000 5,000
Minimum Bond Pull-off Strength (psi)	ASTM C1583 or ASTM C882	28	250

Rapid Chloride Permeability Tests (range in coulombs)	ASTM C1202	-	100 - 1000
--	------------	---	------------

Admixtures are not allowed unless approved by the Engineer. Store shotcrete in an environment where temperatures remain above 40°F and less than 95°F

All equipment must operate in accordance with the manufacturer's specifications and material must be placed within the recommended time.

### QUALITY CONTROL

#### (A) Qualification of Shotcrete Contractor

The shotcrete Contractor shall provide proof of experience by submitting a description of jobs similar in size and character that have been completed within the last five (5) years. The name, address and telephone number of references for the submitted projects shall also be furnished. Failure to provide appropriate documentation will result in the rejection of the proposed shotcrete contractor.

#### (B) Qualification of Nozzleman

The shotcrete Contractor's nozzleman shall be certified by the American Concrete Institute (ACI). Submit proof of certification to the Engineer prior to beginning repair work. The nozzleman shall maintain certification at all times while work is being performed for the Department. Failure to provide and maintain certification will result in the rejection of the proposed nozzleman.

### TEMPORARY WORK PLATFORM

Prior to beginning any repair work, provide details for a sufficiently sized temporary work platform at each repair location. Design steel members to meet the requirements of the American Institute of Steel Construction Manual. Design timber members in accordance with the *National Design Specification for Stress-Grade Lumber and Its Fastenings* of the National Forest Products Association. Submit the platform design and plans for review and approval. The design and plans shall be sealed and signed by a North Carolina registered Professional Engineer. Do not install the platform until the design and plans are approved. Drilling holes in the superstructure for the purpose of attaching the platform is prohibited. Upon completion of work, remove all anchorages in the substructure and repair the substructure at no additional cost to the Department.

### SURFACE PREPARATION

Prior to starting the repair operation, delineate all surfaces and areas assumed to be deteriorated by visually examining and sounding the concrete surface with a hammer or other approved method. The Engineer is the sole judge in determining the limits of deterioration.

Prior to removal, introduce a shallow saw cut approximately ½" in depth around the repair area at right angles to the concrete surface. Remove all deteriorated concrete 1 inch below the reinforcing steel with a 17 lb (maximum) pneumatic hammer with points that do not exceed the width of the

shank or with hand picks or chisels as directed by the Engineer. Do not cut or remove the existing reinforcing steel. Unless specifically directed by the Engineer, do not remove concrete deeper than 1 inch below the reinforcing steel.

Abrasive blast all exposed concrete surfaces and existing reinforcing steel in repair areas to remove all debris, loose concrete, loose mortar, rust, scale, etc. After sandblasting examine the reinforcing steel to ensure at least 90% of the original diameter remains. If there is more than 10% reduction in the rebar diameter, splice in and securely tie supplemental reinforcing bars as directed by the Engineer.

Provide stainless welded wire fabric at each repair area larger than one square foot if the depth of the repair exceeds 2 inches from the existing, intact exterior face of the concrete member. Provide a minimum 4" x 4" - 12 gage stainless welded wire fabric unless otherwise shown on the plans. Rigidly secure the welded wire fabric to existing steel or to  $\frac{3}{16}$ " diameter stainless hook fasteners adequately spaced to prevent sagging. Encase the welded wire fabric in shotcrete a minimum depth of 1½ inches.

With the exception of overhead applications, the contractor has the option to use synthetic fiber reinforcement as an alternate to welded wire fabric if attaching welded wire fabric is impractical or if approved by the Engineer. Welded wire fabric and synthetic fiber reinforcement shall not be used in the same repair area.

Thoroughly clean the repair area of all dirt, grease, oil or foreign matter, and remove all loose or weakened material before applying shotcrete. Saturate the repair area with clean water the day before applying shotcrete. Bring the wetted surface to a saturated surface dry (SSD) condition prior to applying shotcrete and maintain this condition until the application begins. Use a blowpipe to facilitate removal of free surface water. Only oil-free compressed air is to be used in the blowpipe.

The time between removal of deteriorated concrete and applying shotcrete shall not exceed five (5) calendar days. If the time allowance exceeds (5) calendar days, prepare the surface at the direction of the Engineer before applying shotcrete.

#### **APPLICATION AND SURFACE FINISH**

Apply shotcrete only when the surface temperature of the repair area is greater than 40°F and less than 95°F. Do not apply shotcrete to frosted surfaces. Maintain shotcrete at a minimum temperature of 40°F for three (3) calendar days after placement.

Apply shotcrete in layers. The properties of the applied shotcrete determine the proper thickness of each layer or lift.

The nozzleman should hold the nozzle three (3) to four (4) feet from the surface being covered in a position that ensures the shotcrete strikes at right angles to the surface being covered without excessive impact. The nozzleman shall maintain the water amount at a practicable minimum, so the mix properly adheres to the repair area. Water content should not become high enough to cause the mix to sag or fall from vertical or inclined surfaces, or to separate in horizontal layers.

Use shooting wires or guide strips that do not entrap rebound sand. Use guide wires to provide a positive means of checking the total thickness of the shotcrete applied. Remove the guide wires prior to the final finish coat.

To avoid leaving sand pockets in the shotcrete, blow or rake off sand that rebounds and does not fall clear of the work, or which collects in pockets in the work. Do not reuse rebound material in the work.

If a work stoppage longer than two (2) hours takes place on any shotcrete layer prior to the time it has been built up to required thickness, saturate the area with clean water and use a blowpipe as outlined previously, prior to continuing with the remaining shotcrete course. Do not apply shotcrete to a dry surface.

Finish all repaired areas, including chamfered edges, as close as practicable to their original dimensions and configuration, unless otherwise required to provide a minimum 2" of cover for reinforcing steel exposed during repair. If necessary to extend shotcrete repair material beyond the original member dimensions and geometry, coordinate with the Engineer to determine methods, geometry, and dimensions of the final finished surface to provide a minimum 2" of cover on reinforcing steel. Slightly build up and trim shotcrete to the final surface by cutting with the leading edge of a sharp trowel. Use a rubber float to correct any imperfections. Limit work on the finished surface to correcting imperfections caused by trowel cutting.

Immediately after bringing shotcrete surfaces to final thickness, thoroughly check for sags, bridging, and other deficiencies. Repair any imperfections at the direction of the Engineer.

Cure the completed shotcrete surface in accordance with Article 420-15(B) Water Method, of the *Standard Specifications* for seven (7) calendar days. If the water method is impracticable and if approved by the Engineer, a membrane curing compound may be used in accordance with Subarticle 420-15(C) at double the manufacturer's recommended coverage rate.

#### **MATERIAL TESTING & ACCEPTANCE**

Each day shotcreting takes place, the nozzleman shall shoot one 18" x 18" x 3.5" test panel in the same position as the repair work that is being done to demonstrate the shotcrete is being applied properly. Store, handle and cure the test panel in the same manner as the repaired substructure and do not disturb for the first 24 hours after shotcreting.

Approximately 72 hours after completing the final shotcrete placement, thoroughly test the surface with a hammer. At this time, the repair area should have sufficient strength for all sound sections to ring sharply. Remove and replace any unsound portions prior to the final inspection of the work. No additional compensation will be provided for removal and replacement of unsound shotcrete.

In accordance with Subarticle 1002-3(H) of the *Standard Specifications*, core three (3) 3" diameter samples from each test panel. Compressive strength values on test panels shall equal or exceed the required 28-day strength requirements. Should failures occur on the test panel cores, acceptance of the material will be determined by tests on cores from the installed work on the structure. A minimum of (3) three cores shall be taken from the area in question of the structure. The average compressive strength of the cores taken from the structure shall equal or exceed the specified

strength of the shotcrete applied, and no single core shall have strength less than 85% of the specified value. Any cores taken from the structure shall penetrate into the existing concrete at least two (2) inches. Cores shall also be inspected for delamination, sand pockets, segregation, and voids.

The adequacy of the bond between the existing concrete and the shotcrete shall be determined by direct tension bond testing, in accordance with ASTM C1583 or ASTM C882, as directed by the Engineer. A minimum bond strength of 250 psi will be accepted as satisfactory. Bond failure less than 250 psi attributable to the failure of existing concrete will not be cause for rejection. The cost of up to three passing direct tension bond tests shall be the responsibility of the Contractor; additional passing pull-off tests will be the responsibility of the Department.

Any repair work failing to meet the requirements of this provision will be rejected and the Contractor shall implement a remediation plan to correct the deficiency at no additional cost to the Department. No extra payment will be provided for drilling extra cores. Patch all core holes in the repaired structure to the satisfaction of the Engineer.

**MEASUREMENT AND PAYMENT**

*Shotcrete Repairs* will be measured and paid for at the contract unit price bid per cubic foot and will be full compensation for removal, containment and disposal off-site of unsound concrete including the cost of materials, labor, tools, equipment and incidentals necessary to complete the repair work. Depth will be measured from the original outside concrete face. If modifications to the dimensions and geometry are approved by the Engineer to achieve proper clearance over reinforcing steel, depth measurements will be made from the modified final outside face. The Contractor and Engineer will measure quantities after removal of unsound concrete and before application of repair material. Payment will also include the cost of sandblasting, surface cleaning and preparation, cleaning of reinforcing steel, placement of new steel, cost of temporary work platform, testing for soundness and bond strength, curing of shotcrete and taking core samples from the test panels and the structure.

Payment will be made under:

<b>Pay Item</b>	<b>Pay Unit</b>
Shotcrete Repairs	Cubic Feet

**CONCRETE REPAIRS**

**(2-11-19)**

**DESCRIPTION**

Work includes removal of concrete in spalled, delaminated and/or cracked areas of the existing bent caps, bent columns, underside of bridge decks, deck slabs, girders, and bridge rails in reasonably close conformity with the lines, depth, and details shown on the plans, described herein and as established by the Engineer. This work also includes straightening, cleaning, and replacement of reinforcing steel, doweling new reinforcing steel, removing all loose materials, removing and disposing of debris, formwork, applying repair material, and protecting adjacent

areas of the bridge and environment from material leakage. The repair material shall be one of the materials described in this Special Provision, unless otherwise noted in the plans or special provisions.

The location and extent of repairs shown on the plans described herein are general in nature. The Engineer shall determine the extent of removal in the field based on an evaluation of the condition of the exposed surfaces. The Contractor shall coordinate removal operations with the Engineer. No more than 30% of a round or square column or 30% of the bearing area under a beam shall be removed without a temporary support system and approval from the Engineer.

Repair, to the Engineer's satisfaction, any portion of the structure that is damaged from construction operations. No extra payment is provided for these repairs.

### **SURFACE PREPARATION**

Adhere to the following surface preparation requirements or the repair material manufacturer's requirements, whichever is more stringent.

Prior to starting the repair operation, delineate all surfaces and areas assumed to be deteriorated by visually examining and sounding the concrete surface with a hammer or other approved method. The Engineer is the sole judge in determining the limits of deterioration.

Prior to concrete removal, introduce a shallow saw cut, ½" in depth, around the repair area at right angles to the concrete surface. Sawcut should be located a minimum 2" beyond the perimeter of the deteriorated concrete area to be repaired. Remove all concrete within the sawcut to a minimum depth of ½". If concrete removal exposes reinforcing steel, remove all deteriorated concrete 1" below the reinforcing steel with a 17 lb (maximum) pneumatic hammer, with points that do not exceed the width of the shank, or with hand picks or chisels, as directed by the Engineer. Do not cut or remove the existing reinforcing steel. Unless specifically directed by the Engineer, do not remove concrete deeper than 1" below the reinforcing steel.

Abrasive blast all exposed concrete surfaces and existing reinforcing steel in repair areas to remove all debris, loose concrete, loose mortar, rust, scale, etc. After blasting, examine the reinforcing steel to ensure at least 90% of the original diameter remains. If there is more than 10% reduction in the rebar diameter, splice in and securely tie supplemental reinforcing bars as directed by the Engineer. This might require additional removal of concrete, in order to achieve an appropriate splice length of the reinforcing steel.

Thoroughly clean the repair area of all dirt, grease, oil, or foreign matter, and remove all loose or weakened material by abrasive blasting before applying concrete repair material. Acid etch with 15% hydrochloric acid, only if approved by the Engineer. Follow acid etching by scrubbing and flushing with copious amounts of clean water. Check the cleaning using moist pH paper. Water cleaning is complete when the paper reads ten (10) or higher.

Follow all abrasive blasting with vacuum cleaning.

The time between removal of deteriorated concrete and applying concrete repair material shall not exceed 72 hours. If the time allowance exceeds 72 hours, prepare the surface at the direction of the Engineer before applying concrete repair material.

#### **APPLICATION AND SURFACE FINISH**

Apply repair material to damp surfaces only when allowed by repair material recommendations and approved by the Engineer. Prepare damp surfaces in accordance with the *Standard Specifications* and/ or repair material manufacturer's recommendations. Use a blowpipe to facilitate removal of free surface water. Only oil-free compressed air is to be used in the blowpipe.

When surface preparation is completed, mix and apply repair material in accordance with the *Standard Specifications* and/ or repair material manufacturer's recommendations.

Use aggregate that is washed, kiln-dried, and bagged. Maximum size of aggregate shall not exceed 2/3 of the minimum depth of the repair area, or 3/4 of the depth of excavation behind the reinforcing steel, whichever is smaller.

Unless otherwise required by the repair material manufacturer, apply bonding agent to all repair areas immediately prior to placing repair material.

Repair areas shall be formed unless otherwise approved by the Engineer. Form and finish all repaired areas, including chamfered edges, as close as practicable to their original "As Built" dimensions and configuration. After applying the repair material, remove excessive material and provide a smooth, flush surface, unless directed otherwise.

Cure finished Class A concrete repair material by maintaining 95% relative humidity at the repair and surrounding areas by fogging, moist curing, or other approved means for seven (7) days. Cure polymer modified concrete repair material in accordance with manufacturer's recommendations.

#### **REPAIR MATERIAL OPTIONS**

##### **(A) Polymer Modified Concrete Repair Material**

Repair material shall be polymer modified cement mortar for vertical or overhead applications and shall be suitable for applications in marine environments. Material shall be approved for use by NCDOT. Submit repair material to the Engineer for review and approval prior to beginning the work. Color of repair material shall be concrete gray.

##### **(B) Class A Concrete Repair Material**

Repair material shall be Class A Portland Cement Concrete as described in Article 1000-4 of the *Standard Specifications*.

#### **TEMPORARY WORK PLATFORM**

Prior to beginning any repair work, provide details for a sufficiently sized temporary work platform at each repair location. Design steel members to meet the requirements of the *American Institute of Steel Construction Manual*. Design timber members in accordance with the *National Design*



*Specification for Stress-Grade Lumber and Its Fastenings* of the National Forest Products Association. Submit the platform design and plans for review and approval. The design and plans shall be sealed and signed by a North Carolina registered Professional Engineer. Do not install the platform until the design and plans are approved. Drilling holes in the superstructure for the purpose of attaching the platform is prohibited. Upon completion of work, remove all anchorages in the substructure and repair the substructure at no additional cost to the Department.

**MEASUREMENT AND PAYMENT**

*Concrete Repairs* will be measured and paid for at the contract unit price bid per cubic foot and will be full compensation for removal, containment and disposal off-site of unsound concrete including the cost of materials, reinforcing steel, labor, tools, equipment and incidentals necessary to complete the repair work. Depth will be measured from the original outside concrete face. The Contractor and Engineer will measure quantities after removal of unsound concrete and before application of repair material. Payment will also include the cost of abrasive blasting, surface cleaning and preparation, blast cleaning of reinforcing steel, placement of new reinforcing steel, cost of temporary work platform, testing of the soundness of the exposed concrete surface, furnishing and installation of repair mortar material, curing and sampling of concrete, and protection/cleaning of adjacent areas from splatter or leakage.

Reinforcing Steel that is required for the repairs will be in accordance with Section 425 of the *Standard Specifications*.

Payment will be made under:

<b>Pay Item</b>	<b>Pay Unit</b>
Concrete Repairs	Cubic Feet

**VOLUMETRIC MIXER**

**(12-18-12)**

**DESCRIPTION**

This provision addresses the requirements for batching deck repair concrete at the point of delivery using a Mobile High Performance Volume Mixer (MHPVM). Work shall be in accordance with the general requirements of Section 1000-12 of the *Standard Specifications* and as amended by these provisions.

**MATERIALS**

Produce high early strength concrete with MHPVM equipment. Furnish project site storage facilities that will provide protection of materials in accordance with the *Standard Specifications* and all material suppliers' recommendations.

**EQUIPMENT**

MHPVM devices shall have prominently displayed stamped metal plate(s) from the Volumetric Mixers Manufacturers Bureau stating that the equipment conforms to the requirements of ASTM C685.

Hydraulic cement concrete shall be mixed at the point of delivery by a combination of materials and mixer unit conforming to the following:

- 1.) The unit shall be equipped with calibrated proportioning devices for each ingredient added to the concrete mix. The unit shall be equipped with a working recording meter that is visible at all times and furnishes a ticket printout with the calibrated measurement of the mix being produced. If at any time the mixer fails to discharge a uniform mix, production of concrete shall be suspended until such time that problems are corrected.
- 2.) Each unit shall have prominently displayed stamped metal plate(s) attached by the manufacturer on which the following are plainly marked: the gross volume of the transportation unit in terms of mixed concrete, the discharge speed and the mass calibrated constant of the machine in terms of volume.
- 3.) MHPVMs shall be calibrated by a Department approved testing agency in accordance with the manufacturer's recommendations at an interval of every 6 months or a maximum production of 2500 cubic yards, whichever comes first prior to use on the project. The yield shall be maintained within a tolerance of +/- 1% and verified using a minimum 2 cubic feet container every 500 cubic yards or a minimum of once per week.
- 4.) The three cubic feet initially discharged from the truck shall be discarded and not used for concrete placement. Acceptance of the concrete shall comply with the Standard Specifications except that the sample secured for acceptance testing will be taken after four cubic feet is discharged from the delivery vehicle. During discharge, the consistency as determined by ASTM C143 on representative samples taken from the mixer discharge at random intervals shall not vary by more than 1 inch. Acceptance tests shall be performed on each load. If test data demonstrates that acceptable consistency of concrete properties is being achieved, the Engineer may reduce testing requirements.
- 5.) MHPVM equipment shall be operated by a person who is a certified operator by the equipment manufacturer. Any equipment adjustments made during the on-site production of concrete shall be done under the direct on-site supervision of the producer's NCDOT Certified Concrete Batch Technician.

**UNIFORMITY AND ACCEPTANCE**

The contractor is responsible for providing a Certified Concrete Plant Technician during batching operations, and a Certified Concrete Field Technician during placing operations

**MEASUREMENT AND PAYMENT**

*Volumetric Mixer* will be paid for as lump sum and will be full compensation for furnishing the certified MHPVM devices and calibration of the equipment.

<b>Pay Item</b>	<b>Pay Unit</b>
Volumetric Mixer	Lump Sum

**BRIDGE JACKING****(SPECIAL)****DESCRIPTION**

Bridge jacking at end bents and interior bents is to facilitate beam or bent cap repairs and to replace and/ or reset bearings, as necessary. This work shall consist of furnishing all engineering, labor, equipment, and materials necessary for construction and subsequent removal of jacking support system, including jacks, jack supports, shims and all necessary blocking. Included under this item shall be all work to raise and support the existing structure as specified on the plans and as noted herein.

**UTILITY COORDINATION**

Utility owners with active utilities on the bridge shall be notified by the contractor of the jacking operation 30 days before the operation begins.

**SCOPE OF WORK**

Work for bridge jacking includes calculating existing and applied bridge loads, designing proper strength jacking scheme, evaluating stresses imposed on the bridge members, setting blocking and jacks, jacking bridge girders, mechanically locking jacks, and lowering bridge spans onto bearing assemblies.

Submit calculations, working drawings, and jacking procedure to the Engineer for review and approval prior to the start of work. Calculations and jacking procedure shall account for all loads expected while bridge is jacked or temporarily supported. Working drawings and all calculations (for determination of all applied loads, for design of the jacking scheme, to evaluate stresses imposed on the bridge members, and any other necessary calculations) for the required jacking scheme shall be sealed by an engineer licensed in the State of North Carolina. Included in the submittal, the Contractor shall submit all relevant information about the jacking system to be used.

Prior to bridge jacking, complete all diaphragm modifications necessary at the location where jacking is to occur. If a span connected to an end bent is to be jacked, ensure the curtain wall is either clear of the girders, or fully free to move with the jacked span prior to jacking. Lock jacks and install blocking while the bridge is in the raised condition. While in the raised condition, follow bridge plans for any work that may be required. After all repairs requiring bridge jacking are completed, lower the bridge onto the bearing assemblies. Complete repair work, as needed.

Unless otherwise allowed by the Engineer, all bridge jacking operations shall be complete before new deck overlay or deck joints and seals are placed on the existing structure.

Bridge jacking will be designated as one of two jacking arrangements, as follows:

**Type I**

Type I Bridge Jacking shall be applicable for jacking at individual beam or bearing locations. On a particular bridge bent or end bent, there might be more than one Type I Bridge Jacking. When jacking individual beam or bearing locations, all adjacent bearings of beams not being jacked may

be loosened to decrease the resistance of the deck slab during jacking. The maximum differential between adjacent beams that are being jacked is 1/8". Should the jacking of an individual beam require the jacking of adjacent beams to reduce stresses or damage in the bridge, the jacking of the individual beam and adjacent beams shall be considered one Type I Bridge Jacking. All bearings loosened shall be tightened back after repair operations are completed and the jacks and blocking have been removed.

Type II

Type II Bridge Jacking shall be applicable for jacking an entire span end (i.e., all beams at one time) on a bent or end bent.

**BASIS OF PAYMENT**

Payment will be made at the price bid for each set-up to complete *Type I Bridge Jacking Bridge No. \_\_\_* or *Type II Bridge Jacking Bridge No. \_\_\_* as shown in the contract plans. The price per each jacking set-up Type required will be full compensation for designing proper strength jacking scheme (calculations, working drawings, and jacking procedure), all materials, equipment, tools, labor, and incidentals necessary to complete the work of this scope, including any jacking frames, jacking plates, and concrete repair required due to jacking operations.

Payment will be made under:

<b>Pay Item</b>	<b>Pay Unit</b>
Type I Bridge Jacking Bridge No. ____	Each
Type II Bridge Jacking Bridge No. ____	Each

**Railroad Site Data:**

The following information was received from the Railroad, and is provided as a convenience to the Contractor in bidding this project. This information is subject to change and the Contractor may, at his discretion, contact the Railroad directly to verify its current accuracy. Since this information is shown as a convenience to the Contractor, but is subject to change, the Contractor shall have no claims whatsoever against either the Railroad or the Department of Transportation for any delays or additional costs incurred based on changes in this information which occur after the above date of receipt.

Type and number of tracks within 50 ft. of project (mainline, branchline, siding, yard, etc.).  
1 Siding

Number of trains on affected track per day. 3

Maximum authorized operating speed of trains. 40 mph

## Norfolk Southern – Special Provisions for Protection of Railway Interests

### 1. AUTHORITY OF RAILROAD ENGINEER AND SPONSOR ENGINEER:

Norfolk Southern Railway Company, hereinafter referred to as “Railroad”, and their authorized representative shall have final authority in all matters affecting the safe maintenance of railroad traffic including the adequacy of the foundations and structures supporting the railroad tracks. For Public Projects impacting the Railroad, the Railroad’s Public Projects Engineer, hereinafter referred to as “Railroad Engineer”, will serve as the authorized representative of the Railroad.

The authorized representative of the Project Sponsor (“Sponsor”), hereinafter referred to as the “Sponsor’s Engineer”, shall have authority over all other matters as prescribed herein and in the Project Specifications.

The Sponsor’s Prime Contractor, hereinafter referred to as “Contractor” shall be responsible for completing any and all work in accordance with the terms prescribed herein and in the Project Specifications. These terms and conditions are subject to change without notice, from time to time in the sole discretion of the Railroad. Contractor must request from Railroad and follow the latest version of these provisions prior to commencing work.

### 2. NOTICE OF STARTING WORK:

- A. The Contractor shall not commence any work on railroad rights-of-way until he has complied with the following conditions:
1. Signed and received a fully executed copy of the required Norfolk Southern Contractor Right of Entry Agreement.
  2. Given the Railroad written notice in electronic format to the Railroad Engineer, with copy to the Sponsor’s Engineer who has been designated to be in charge of the work, at least ten days in advance of the date he proposes to begin work on Railroad rights-of-way.
  3. Obtained written approval from the Railroad of Railroad Protective Liability Insurance coverage as required by paragraph 14 herein. It should be noted that the Railroad does not accept notation of Railroad Protective insurance on a certificate of liability insurance form or Binders as Railroad must have the full original countersigned policy. Further, please note that mere receipt of the policy is not the only issue but review for compliance. Due to the number of projects system-wide, it typically takes a minimum of 30-45 days for the Railroad to review.
  4. Obtained Railroad’s Flagging Services as required by paragraph 7 herein.
  5. Obtained written authorization from the Railroad to begin work on Railroad’s rights-of-way, such authorization to include an outline of specific conditions with which he must comply.
  6. Furnished a schedule for all work within the Railroad’s rights-of-way as required by paragraph 7.B.1.

- B. The Railroad's written authorization to proceed with the work shall include the names, addresses, and telephone numbers of the Railroad's representatives who are to be notified as hereinafter required. Where more than one representative is designated, the area of responsibility of each representative shall be specified.
3. INTERFERENCE WITH RAILROAD OPERATIONS:
- A. The Contractor shall so arrange and conduct his work that there will be no interference with Railroad's operations, including train, signal, telephone and telegraphic services, or damage to the property of the Railroad or to poles, wires, and other facilities of tenants on the rights-of-way of the Railroad. Whenever work is liable to affect the operations or safety of trains, the method of doing such work shall first be submitted to the Railroad Engineer for approval, but such approval shall not relieve the Contractor from liability. Any work to be performed by the Contractor which requires flagging service or inspection service shall be deferred by the Contractor until the flagging service or inspection service required by the Railroad is available at the job site.
- B. Whenever work within Railroad's rights-of-way is of such a nature that impediment to Railroad's operations such as use of runaround tracks or necessity for reduced speed is unavoidable, the Contractor shall schedule and conduct his operations so that such impediment is reduced to the absolute minimum.
- C. Should conditions arising from, or in connection with the work, require that immediate and unusual provisions be made to protect operations and property of the Railroad, the Contractor shall make such provisions. If in the judgment of the Railroad Engineer, or in his absence, the Railroad's Division Engineer, such provisions is insufficient, either may require or provide such provisions as he deems necessary. In any event, such unusual provisions shall be at the Contractor's expense and without cost to the Railroad or the Sponsor.
- D. "One Call" Services do not locate buried Railroad utilities. The contractor shall contact the Railroad's representative 2 days in advance of work at those places where excavation, pile driving, or heavy loads may damage the Railroad's underground facilities. Upon request from the Contractor or Sponsor, Railroad forces will locate and paint mark or flag the Railroad's underground facilities. The Contractor shall avoid excavation or other disturbances of these facilities. If disturbance or excavation is required near a buried Railroad facility, the contractor shall coordinate with the Railroad to have the facility potholed manually with careful hand excavation. The facility shall be protected by the Contractor during the course of the disturbance under the supervision and direction of the Railroad's representative.
4. TRACK CLEARANCES:
- A. The minimum track clearances to be maintained by the Contractor during construction are shown on the Project Plans. If temporary clearances are not shown on the project plans, the following criteria shall govern the use of falsework and formwork above or adjacent to operated tracks.
1. A minimum vertical clearance of 22'-0" above top of highest rail shall be maintained at all times.
  2. A minimum horizontal clearance of 13'-0" from centerline of tangent track or 14'-0" from centerline of curved track shall be maintained at all times. Additional horizontal

clearance may be required in special cases to be safe for operating conditions. This additional clearance will be as determined by the Railroad Engineer.

3. All proposed temporary clearances which are less than those listed above must be submitted to Railroad Engineer for approval prior to construction and must also be authorized by the regulatory body of the State if less than the legally prescribed clearances.
  4. The temporary clearance requirements noted above shall also apply to all other physical obstructions including, but not limited to: stockpiled materials, parked equipment, placement or driving of piles, and bracing or other construction supports.
- B. Before undertaking any work within Railroad right-of-way, and before placing any obstruction over any track, the Contractor shall:
1. Notify the Railroad's representative at least 72 hours in advance of the work.
  2. Receive assurance from the Railroad's representative that arrangements have been made for flagging service as may be necessary.
  3. Receive permission from the Railroad's representative to proceed with the work.
  4. Ascertain that the Sponsor's Engineer has received copies of notice to the Railroad and of the Railroad's response thereto.

5. CONSTRUCTION PROCEDURES:

A. General:

1. Construction work and operations by the Contractor on Railroad property shall be:
  - a. Subject to the inspection and approval of the Railroad Engineer or their designated Construction Engineering Representative.
  - b. In accordance with the Railroad's written outline of specific conditions.
  - c. In accordance with the Railroad's general rules, regulations and requirements including those relating to safety, fall protection and personal protective equipment.
  - d. In accordance with these Special Provisions.
2. Submittal Requirements
  - a. The Contractor shall submit all construction related correspondence and submittals electronically to the Railroad Engineer.
  - b. The Contractor shall allow for 30 days for the Railroad's review and response.
  - c. All work in the vicinity of the Railroad's property that has the potential to affect the Railroad's train operations or disturb the Railroad's Property must be submitted and approved by the Railroad prior to work being performed.

- d. All submittals and calculations must be signed and sealed by a registered engineer licensed in the state of the project work.
- e. All submittals shall first be approved by the Sponsor's Engineer and the Railroad Engineer, but such approval shall not relieve the Contractor from liability.
- f. For all construction projects, the following submittals, but not limited to those listed below, shall be provided for review and approval when applicable:
  - (1) General Means and Methods
  - (2) Ballast Protection
  - (3) Construction Excavation & Shoring
  - (4) Pipe, Culvert, & Tunnel Installations
  - (5) Demolition Procedure
  - (6) Erection & Hoisting Procedure
  - (7) Debris Shielding or Containment
  - (8) Blasting
  - (9) Formwork for the bridge deck, diaphragms, overhang brackets, and protective platforms
  - (10) Bent Cap Falsework. A lift plan will be required if the contractor want to move the falsework over the tracks.
- g. For Undergrade Bridges (Bridges carrying the Railroad) the following submittals in addition to those listed above shall be provided for review and approval:
  - (1) Shop Drawings
  - (2) Bearing Shop Drawings and Material Certifications
  - (3) Concrete Mix Design
  - (4) Structural Steel, Rebar, and/or Strand Certifications
  - (5) 28 day Cylinder Test for Concrete Strength
  - (6) Waterproofing Material Certification
  - (7) Test Reports for Fracture Critical Members
  - (8) Foundation Construction Reports

Fabrication may not begin until the Railroad has approved the required shop drawings.
- h. The Contractor shall include in all submissions a detailed narrative indicating the progression of work with the anticipated timeframe to complete each task. Work will not be permitted to commence until the Contractor has provided the Railroad with a satisfactory plan that the project will be undertaken without scheduling, performance or safety related issues. Submission shall also provide a listing of the anticipated equipment to be used, the location of all equipment to be used and insure a contingency plan of action is in place should a primary piece of equipment malfunction.

#### B. Ballast Protection

1. The Contractor shall submit the proposed ballast protection system detailing the specific filter fabric and anchorage system to be used during all construction activities.



2. The ballast protection is to extend 25' beyond the proposed limit of work, be installed at the start of the project and be continuously maintained to prevent all contaminants from entering the ballast section of all tracks for the entire duration of the project.
- C. Excavation:
1. The subgrade of an operated track shall be maintained with edge of berm at least 10'-0" from centerline of track and not more than 24-inches below top of rail. Contractor will not be required to make existing section meet this specification if substandard, in which case existing section will be maintained.
  2. Additionally, the Railroad will require the installation of an OSHA approved handrail and orange construction safety fencing for all excavations of the Railroad right-of-way.
- D. Excavation for Structures and Shoring Protection:
1. The Contractor will be required to take special precaution and care in connection with excavating and shoring pits, and in driving piles or sheeting for footings adjacent to tracks to provide adequate lateral support for the tracks and the loads which they carry, without disturbance of track alignment and surface, and to avoid obstructing track clearances with working equipment, tools or other material.
  2. All plans and calculations for shoring shall be prepared, signed, and sealed by a Registered Professional Engineer licensed in the state of the proposed project, in accordance with Norfolk Southern's Overhead Grade Separation Design Criteria, subsection H.1.6.E-Construction Excavation (Refer to Norfolk Southern Public Projects Manual Appendix H). The Registered Professional Engineer will be responsible for the accuracy for all controlling dimensions as well as the selection of soil design values which will accurately reflect the actual field conditions.
  3. The Contractor shall provide a detailed installation and removal plan of the shoring components. Any component that will be installed via the use of a crane or any other lifting device shall be subject to the guidelines outlined in section 5.G of these provisions.
  4. The Contractor shall be required to survey the track(s) and Railroad embankment and provide a cross section of the proposed excavation in relation to the tracks.
  5. Calculations for the proposed shoring should include deflection calculations. The maximum deflection for excavations within 18'-0" of the centerline of the nearest track shall be 3/8". For all other cases, the max deflection shall not exceed 1/2".
  6. Additionally, the Railroad will require the installation of an OSHA approved handrail and orange construction safety fencing for all excavations of the Railroad right-of-way.
  7. The front face of shoring located to the closest NS track for all shoring set-ups located in Zone 2 as shown on NS Typical Drawing No. 4 – Shoring Requirements (Appendix I) shall remain in place and be cut off 2'-0" below the final ground elevation. The remaining shoring in Zone 2 and all shoring in Zone 1 may be removed and all voids must be backfilled with flowable fill.

E. Pipe, Culvert, & Tunnel Installations

1. Pipe, Culvert, & Tunnel Installations shall be in accordance with the appropriate Norfolk Southern Design Specification as noted below:
  - a. For Open Cut Method refer to Norfolk Southern Public Projects Manual Appendix H.4.6.
  - b. For Jack and Bore Method refer to Norfolk Southern Public Projects Manual Appendix H.4.7.
  - c. For Tunneling Method refer to Norfolk Southern Public Projects Manual Appendix H.4.8.
2. The installation methods provided are for pipes carrying storm water or open flow runoff. All other closed pipeline systems shall be installed in accordance Norfolk Southern's Pipe and Wire Program and the NSCE-8

F. Demolition Procedures

1. General

- a. Demolition plans are required for all spans over the track(s), for all spans adjacent to the track(s), if located on (or partially on) Railroad right-of-way; and in all situations where cranes will be situated on, over, or adjacent to Railroad right-of-way and within a distance of the boom length plus 15'-0" from the centerline of track.
- b. Railroad tracks and other Railroad property must be protected from damage during the procedure.
- c. A pre-demolition meeting shall be conducted with the Sponsor, the Railroad Engineer or their representative, and the key Contractor's personnel prior to the start of the demolition procedure.
- d. The Railroad Engineer or his designated representative must be present at the site during the entire demolition procedure period.
- e. Existing, obsolete, bridge piers shall be removed to a sufficient depth below grade to enable restoration of the existing/proposed track ditch, but in no case less than 2'-0" below final grade.

2. Submittal Requirements

- a. In addition to the submittal requirements outlined in Section 5.A.2 of these provisions, the Contractor shall submit the following for approval by the Railroad Engineer:
  - (1) A plan showing the location of cranes, horizontally and vertically, operating radii, with delivery or disposal locations shown. The location of all tracks and other Railroad facilities as well as all obstructions such as wire lines, poles, adjacent structures, etc. must also be shown.

- (2) Rating sheets showing cranes or lifting devices to be adequate for 150% of the actual weight of the pick, including all rigging components. A complete set of crane charts, including crane, counterweight, and boom nomenclature is to be submitted. Safety factors that may have been "built-in" to the crane charts are not to be considered when determining the 150% factor of safety.
- (3) Plans and computations showing the weight of the pick must be submitted. Calculations shall be made from plans of the existing structure showing complete and sufficient details with supporting data for the demolition the structure. If plans do not exist, lifting weights must be calculated from field measurements. The field measurements are to be made under the supervision of the Registered Professional Engineer submitting the procedure and calculations.
- (4) The Contractor shall provide a sketch of all rigging components from the crane's hook block to the beam. Catalog cuts or information sheets of all rigging components with their lifting capacities shall be provided. All rigging must be adequate for 150% of the actual weight of the pick. Safety factors that may have been "built-in" to the rating charts are not to be considered when determining the 150% factor of safety. All rigging components shall be clearly identified and tagged with their rated lifting capacities. The position of the rigging in the field shall not differ from what is shown on the final plan without prior review from the Sponsor and the Railroad.
- (5) A complete demolition procedure, including the order of lifts, time required for each lift, and any repositioning or re-hitching of the crane or cranes.
- (6) Design and supporting calculations for the temporary support of components, including but not limited to the stability of the superstructure during the temporary condition, temporary girder tie-downs and falsework.

### 3. Overhead Demolition Debris Shield

- a. The demolition debris shield shall be installed prior to the demolition of the bridge deck or other relevant portions of the superstructure over the track area to catch all falling debris.
- b. The demolition debris shield shall provide a minimum vertical clearance as specified in Section 4.A.1 of these provisions or maintain the existing vertical clearance if the existing clearance is less than that specified in Section 4.A.1.
- c. The Contractor shall include the demolition debris shield installation/removal means and methods as part of the proposed Demolition procedure submission.
- d. The Contractor shall submit the demolition debris shield design and supporting calculations for approval by the Railroad Engineer.

- e. The demolition debris shield shall have a minimum design load of 50 pounds per square foot plus the weight of the equipment, debris, personnel, and other loads to be carried.
- f. The Contractor shall include the proposed bridge deck removal procedure in its demolition means and methods and shall verify that the size and quantity of the demolition debris generated by the procedure does not exceed the shield design loads.
- g. The Contractor shall clean the demolition debris shield daily or more frequently as dictated either by the approved design parameters or as directed by the Railroad Engineer.

#### 4. Vertical Demolition Debris Shield

- a. A vertical demolition debris shield may be required for substructure removals in close proximity to the Railroad's track and other facilities, as determined by the Railroad Engineer.

### G. Erection & Hoisting Procedures

#### 1. General

- a. Erection plans are required for all spans over the track(s), for all spans adjacent to the track(s), if located on (or partially on) Railroad right-of-way; and in all situations where cranes will be situated on, over, or adjacent to Railroad right-of-way and within a distance of the boom length plus 15'-0" from the centerline of track.
- b. Railroad tracks and other Railroad property must be protected from damage during the erection procedure.
- c. A pre-erection meeting shall be conducted with the Sponsor, the Railroad Engineer or their representative, and the key Contractor's personnel prior to the start of the erection procedure.
- d. The Railroad Engineer or his designated representative must be present at the site during the entire erection procedure period.
- e. For field splices located over Railroad property, a minimum of 50% of the holes for each connection shall be filled with bolts or pins prior to releasing the crane. A minimum of 50% of the holes filled shall be filled with bolts. All bolts must be appropriately tightened. Any changes to previously approved field splice locations must be submitted to the Railroad for review and approval. Refer to Norfolk Southern's Overhead Grade Separation Design Criteria for additional splice details (Norfolk Southern Public Projects Manual Appendix H.1, Section 4.A.3.).

## 2. Submittal Requirements

- a. In addition the submittal requirements outlined in Section 5.A.2 of these provisions, the Contractor shall submit the following for approval by the Railroad Engineer:
  - (1) As-built beam seat elevations - All as-built bridge seats and top of rail elevations shall be furnished to the Railroad Engineer for review and verification at least 30 days in advance of the erection, to ensure that minimum vertical clearances as approved in the plans will be achieved.
  - (2) A plan showing the location of cranes, horizontally and vertically, operating radii, with delivery or staging locations shown. The location of all tracks and other Railroad facilities as well as all obstructions such as wire lines, poles, adjacent structures, etc. must also be shown.
  - (3) Rating sheets showing cranes or lifting devices to be adequate for 150% of the actual weight of the pick, including all rigging components. A complete set of crane charts, including crane, counterweight, and boom nomenclature is to be submitted. Safety factors that may have been "built-in" to the crane charts are not to be considered when determining the 150% factor of safety.
  - (4) Plans and computations showing the weight of the pick must be submitted. Calculations shall be made from plans of the proposed structure showing complete and sufficient details with supporting data for the erection of the structure. If plans do not exist, lifting weights must be calculated from field measurements. The field measurements are to be made under the supervision of the Registered Professional Engineer submitting the procedure and calculations.
  - (5) The Contractor shall provide a sketch of all rigging components from the crane's hook block to the beam. Catalog cuts or information sheets of all rigging components with their lifting capacities shall be provided. All rigging must be adequate for 150% of the actual weight of the pick. Safety factors that may have been "built-in" to the rating charts are not to be considered when determining the 150% factor of safety. All rigging components shall be clearly identified and tagged with their rated lifting capacities. The position of the rigging in the field shall not differ from what is shown on the final plan without prior review from the Sponsor and the Railroad.
  - (6) A complete erection procedure, including the order of lifts, time required for each lift, and any repositioning or re-hitching of the crane or cranes.
  - (7) Design and supporting calculations for the temporary support of components, including but not limited to temporary girder tie-downs and falsework.

## H. Blasting:

1. The Contractor shall obtain advance approval of the Railroad Engineer and the Sponsor Engineer for use of explosives on or adjacent to Railroad property. The request for permission to use explosives shall include a detailed blasting plan. If permission for use of explosives is granted, the Contractor will be required to comply with the following:
  - a. Blasting shall be done with light charges under the direct supervision of a responsible officer or employee of the Contractor and a licensed blaster.
  - b. Electric detonating fuses shall not be used because of the possibility of premature explosions resulting from operation of two-way radios.
  - c. No blasting shall be done without the presence of the Railroad Engineer or his authorized representative. At least 72 hours advance notice to the person designated in the Railroad's notice of authorization to proceed (see paragraph 2.B) will be required to arrange for the presence of an authorized Railroad representative and such flagging as the Railroad may require.
  - d. Have at the job site adequate equipment, labor and materials and allow sufficient time to clean up debris resulting from the blasting without delay to trains, as well as correcting at his expense any track misalignment or other damage to Railroad property resulting from the blasting as directed by the Railway's authorized representative. If his actions result in delay of trains, the Contractor shall bear the entire cost thereof.
  - e. The blasting Contractor shall have a copy of the approved blasting plan on hand while on the site.
  - f. Explosive materials or loaded holes shall not be left unattended at the blast site.
  - g. A seismograph shall be placed on the track shoulder adjacent to each blast which will govern the peak particle velocity of two inches per second. Measurement shall also be taken on the ground adjacent to structures as designated by a qualified and independent blasting consultant. The Railroad reserves the option to direct the placement of additional seismographs at structures or other locations of concern, without regard to scaled distance.
  - h. After each blast, the blasting Contractor shall provide a copy of their drill log and blast report, which includes number of holes, depth of holes, number of decks, type and pounds of explosives used per deck.
  - i. The Railroad may require top of rail elevations and track centers taken before, during and after the blasting and excavation operation to check for any track misalignment resulting from the Contractor's activities.

2. The Railroad representative will:
  - a. Determine approximate location of trains and advise the Contractor the appropriate amount of time available for the blasting operation and clean up.
  - b. Have the authority to order discontinuance of blasting if, in his opinion, blasting is too hazardous or is not in accord with these special provisions.
3. The Contractor must hire, at no expense to the Railroad, a qualified and independent blasting consultant to oversee the use of explosives. The blasting consultant will:
  - a. Review the Contractor's proposed drilling and loading patterns, and with the blasting consultant's personnel and instruments, monitor the blasting operations.
  - b. Confirm that the minimum amounts of explosives are used to remove the rock.
  - c. Be empowered to intercede if he concludes that the Contractor's blasting operations are endangering the Railway.
  - d. Submit a letter acknowledging that he has been engaged to oversee the entire blasting operation and that he approves of the blasting plan.
  - e. Furnish copies of all vibration readings to the Railroad representative immediately after each blast. The representative will sign and date the seismograph tapes after each shot to verify the readings are for that specific shot.
  - f. Advise the Railroad representative as to the safety of the operation and notify him of any modifications to the blasting operation as the work progresses.
4. The request for permission to use explosives on the Railroad's Right-of-Way shall include a blasting proposal providing the following details:
  - a. A drawing which shows the proposed blasting area, location of nearest hole and distance to Railway structures, all with reference to the centerline of track.
  - b. Hole diameter.
  - c. Hole spacing and pattern.
  - d. Maximum depth of hole.
  - e. Maximum number of decks per hole.
  - f. Maximum pounds of explosives per hole.
  - g. Maximum pounds of explosives per delay.
  - h. Maximum number of holes per detonation.

- i. Type of detonator and explosives to be used. (Electronic detonating devices will not be permitted). Diameter of explosives if different from hole diameter.
  - j. Approximate dates and time of day when the explosives are to be detonated.
  - k. Type of flyrock protection.
  - l. Type and patterns of audible warning and all clear signals to be used before and after each blast.
  - m. A copy of the blasting license and qualifications of the person directly in charge of the blasting operation, including their name, address and telephone number.
  - n. A copy of the Authority's permit granting permission to blast on the site.
  - o. A letter from the blasting consultant acknowledging that he has been engaged to oversee the entire blasting operation and that he approves of the blasting plan.
  - p. In addition to the insurance requirements outlined in Paragraph 14 of these Provisions, A certificate of insurance from the Contractor's insurer stating the amount of coverage for XCU (Explosive Collapse and Underground Hazard) insurance and that XCU Insurance is in force for this project.
  - q. A copy of the borings and Geotechnical information or report.
- I. Track Monitoring
- 1. At the direction of the Railroad Engineer, any activity that has the potential to disturb the Railroad track structure may require the Contractor to submit a detailed track monitoring program for approval by the Railroad Engineer.
  - 2. The program shall specify the survey locations, the distance between the location points, and frequency of monitoring before, during, and after construction. Railroad reserves the right to modify the survey locations and monitoring frequency as necessary during the project.
  - 3. The survey data shall be collected in accordance with the approved frequency and immediately furnished to the Railroad Engineer for analysis.
  - 4. If any movement has occurred as determined by the Railroad Engineer, the Railroad will be immediately notified. Railroad, at its sole discretion, shall have the right to immediately require all Contractor operations to be ceased and determine what corrective action is required. Any corrective action required by the Railroad or performed by the Railroad including the monitoring of corrective action of the Contractor will be at project expense.
- J. Maintenance of Railroad Facilities:
- 1. The Contractor will be required to maintain all ditches and drainage structures free of silt or other obstructions which may result from his operations and provide and maintain any erosion control measures as required. The Contractor will promptly



repair eroded areas within Railroad rights-of-way and repair any other damage to the property of the Railroad or its tenants.

2. If, in the course of construction, it may be necessary to block a ditch, pipe or other drainage facility, temporary pipes, ditches or other drainage facilities shall be installed to maintain adequate drainage, as approved by the Railroad Engineer. Upon completion of the work, the temporary facilities shall be removed and the permanent facilities restored.
3. All such maintenance and repair of damages due to the Contractor's operations shall be done at the Contractor's expense.

K. Storage of Materials and Equipment:

1. Materials and equipment shall not be stored where they will interfere with Railroad operations, nor on the rights-of-way of the Railroad without first having obtained permission from the Railroad Engineer, and such permission will be with the understanding that the Railroad will not be liable for damage to such material and equipment from any cause and that the Railroad Engineer may move or require the Contractor to move, at the Contractor's expense, such material and equipment.
2. All grading or construction machinery that is left parked near the track unattended by a watchman shall be effectively immobilized so that it cannot be moved by unauthorized persons. The Contractor shall protect, defend, indemnify and save Railroad, and any associated, controlled or affiliated corporation, harmless from and against all losses, costs, expenses, claim or liability for loss or damage to property or the loss of life or personal injury, arising out of or incident to the Contractor's failure to immobilize grading or construction machinery.

L. Cleanup:

1. Upon completion of the work, the Contractor shall remove from within the limits of the Railroad rights-of-way, all machinery, equipment, surplus materials, falsework, rubbish or temporary buildings of the Contractor, and leave said rights-of-way in a neat condition satisfactory to the Railroad Engineer or his authorized representative.

6. DAMAGES:

- A. The Contractor shall assume all liability for any and all damages to his work, employees, servants, equipment and materials caused by Railroad traffic.
- B. Any cost incurred by the Railroad for repairing damages to its property or to property of its tenants, caused by or resulting from the operations of the Contractor, shall be paid directly to the Railroad by the Contractor.

7. FLAGGING SERVICES:

A. Requirements:

1. Flagging services will not be provided until the Contractor's insurance has been reviewed & approved by the Railroad.

2. Under the terms of the agreement between the Sponsor and the Railroad, the Railroad has sole authority to determine the need for flagging required to protect its operations. In general, the requirements of such services will be whenever the Contractor's personnel or equipment are or are likely to be, working on the Railroad's right-of-way, or across, over, adjacent to, or under a track, or when such work has disturbed or is likely to disturb a Railroad structure or the Railroad roadbed or surface and alignment of any track to such extent that the movement of trains must be controlled by flagging.
3. Normally, the Railroad will assign one flagman to a project; but in some cases, more than one may be necessary, such as yard limits where three (3) flagmen may be required. However, if the Contractor works within distances that violate instructions given by the Railroad's authorized representative or performs work that has not been scheduled with the Railroad's authorized representative, a flagman or flagmen may be required full time until the project has been completed.
4. For Projects exceeding 30 days of construction, Contractor shall provide the flagmen a small work area with a desk/counter and chair within the field/site trailer, including the use of bathroom facilities, where the flagman can check in/out with the Project, as well as to the flagman's home terminal. The work area should provide access to two (2) electrical outlets for recharging radio(s), and a laptop computer; and have the ability to print off needed documentation and orders as needed at the field/site trailer. This should aid in maximizing the flagman's time and efficiency on the Project.

B. Scheduling and Notification:

1. The Contractor's work requiring Railroad flagging should be scheduled to limit the presence of a flagman at the site to a maximum of 50 hours per week. The Contractor shall receive Railroad approval of work schedules requiring a flagman's presence in excess of 40 hours per week.
2. Not later than the time that approval is initially requested to begin work on Railroad right-of-way, Contractor shall furnish to the Railroad and the Sponsor a schedule for all work required to complete the portion of the project within Railroad right-of-way and arrange for a job site meeting between the Contractor, the Sponsor, and the Railroad's authorized representative. Flagman or Flagmen may not be provided until the job site meeting has been conducted and the Contractor's work scheduled.
3. The Contractor will be required to give the Railroad representative at least 10 working days of advance written notice of intent to begin work within Railroad right-of-way in accordance with this special provision. Once begun, when such work is then suspended at any time, or for any reason, the Contractor will be required to give the Railroad representative at least 3 working days of advance notice before resuming work on Railroad right-of-way. Such notices shall include sufficient details of the proposed work to enable the Railroad representative to determine if flagging will be required. If such notice is in writing, the Contractor shall furnish the Engineer a copy; if notice is given verbally, it shall be confirmed in writing with copy to the Engineer. If flagging is required, no work shall be undertaken until the flagman, or flagmen are present at the job site. It may take up to 30 days to obtain flagging initially from the Railroad. When flagging begins, the flagman is usually assigned by the Railroad to work at the project site on a continual basis until no longer

needed and cannot be called for on a spot basis. If flagging becomes unnecessary and is suspended, it may take up to 30 days to again obtain from the Railroad. Due to Railroad labor agreements, it is necessary to give 5 working days notice before flagging service may be discontinued and responsibility for payment stopped.

4. If, after the flagman is assigned to the project site, an emergency arises that requires the flagman's presence elsewhere, then the Contractor shall delay work on Railroad right-of-way until such time as the flagman is again available. Any additional costs resulting from such delay shall be borne by the Contractor and not the Sponsor or Railroad.

C. Payment:

1. The Sponsor will be responsible for paying the Railroad directly for any and all costs of flagging which may be required to accomplish the construction.
2. The estimated cost of flagging is the current rate per day based on a 10-hour work day. This cost includes the base pay for the flagman, overhead, and includes a per diem charge for travel expenses, meals and lodging. The charge to the Sponsor by the Railroad will be the actual cost based on the rate of pay for the Railroad's employees who are available for flagging service at the time the service is required.
3. Work by a flagman in excess of 8 hours per day or 40 hours per week, but not more than 12 hours a day will result in overtime pay at 1 and 1/2 times the appropriate rate. Work by a flagman in excess of 12 hours per day will result in overtime at 2 times the appropriate rate. If work is performed on a holiday, the flagging rate is 2 and 1/2 times the normal rate.
4. Railroad work involved in preparing and handling bills will also be charged to the Sponsor. Charges to the Sponsor by the Railroad shall be in accordance with applicable provisions of Subchapter B, Part 140, Subpart I and Subchapter G, Part 646, Subpart B of the Federal-Aid Policy Guide issued by the Federal Highway Administration on December 9, 1991, including all current amendments. Flagging costs are subject to change. The above estimates of flagging costs are provided for information only and are not binding in any way.

D. Verification:

1. Railroad's flagman will electronically enter flagging time via Railroad's electronic billing system. Any complaints concerning flagging must be resolved in a timely manner. If the need for flagging is questioned, please contact the Railroad Engineer. All verbal complaints will be confirmed in writing by the Contractor within 5 working days with a copy to the Sponsor's Engineer. Address all written correspondence electronically to Railroad Engineer.
2. The Railroad flagman assigned to the project will be responsible for notifying the Sponsor Engineer upon arrival at the job site on the first day (or as soon thereafter as possible) that flagging services begin and on the last day that he performs such services for each separate period that services are provided. The Sponsor's Engineer will document such notification in the project records. When requested, the Sponsor's Engineer will also sign the flagman's diary showing daily time spent and activity at the project site.

## 8. HAUL ACROSS RAILROAD TRACK:

- A. Where the plans show or imply that materials of any nature must be hauled across Railroad's track, unless the plans clearly show that the Sponsor has included arrangements for such haul in its agreement with the Railroad, the Contractor will be required to make all necessary arrangements with the Railroad regarding means of transporting such materials across the Railroad's track. The Contractor or Sponsor will be required to bear all costs incidental to such crossings whether services are performed by his own forces or by Railroad personnel.
- B. No crossing may be established for use of the Contractor for transporting materials or equipment across the tracks of the Railroad unless specific authority for its installation, maintenance, necessary watching and flagging thereof and removal, until a temporary private crossing agreement has been executed between the Contractor and Railroad. The approval process for an agreement normally takes 90 days.

## 9. WORK FOR THE BENEFIT OF THE CONTRACTOR:

- A. All temporary or permanent changes in wire lines or other facilities which are considered necessary to the project are shown on the plans; included in the force account agreement between the Sponsor and the Railroad or will be covered by appropriate revisions to same which will be initiated and approved by the Sponsor and/or the Railroad.
- B. Should the Contractor desire any changes in addition to the above, then he shall make separate arrangements with the Railroad for same to be accomplished at the Contractor's expense.

## 10. COOPERATION AND DELAYS:

- A. It shall be the Contractor's responsibility to arrange a schedule with the Railroad for accomplishing stage construction involving work by the Railroad or tenants of the Railroad. In arranging his schedule he shall ascertain, from the Railroad, the lead time required for assembling crews and materials and shall make due allowance therefore.
- B. No charge or claim of the Contractor against either the Sponsor or the Railroad will be allowed for hindrance or delay on account of railroad traffic; any work done by the Railroad or other delay incident to or necessary for safe maintenance of railroad traffic or for any delays due to compliance with these special provisions.

## 11. TRAINMAN'S WALKWAYS:

- A. Along the outer side of each exterior track of multiple operated track, and on each side of single operated track, an unobstructed continuous space suitable for trainman's use in walking along trains, extending to a line not less than 10 feet from centerline of track, shall be maintained. Any temporary impediments to walkways and track drainage encroachments or obstructions allowed during work hours while Railroad's protective service is provided shall be removed before the close of each work day. If there is any excavation near the walkway, a handrail, with 10'-0" minimum clearance from centerline of track, shall be placed and must conform to AREMA and/or FRA standards.

## 12. GUIDELINES FOR PERSONNEL ON RAILROAD RIGHT-OF-WAY:

- A. The Contractor and/or the Sponsor's personnel authorized to perform work on Railroad's property as specified in Section 2 above are not required to complete Norfolk Southern Roadway

Worker Protection Training; However the Contractor and the Sponsor's personnel must be familiar with Norfolk Southern's standard operating rules and guidelines, should conduct themselves accordingly, and may be removed from the property for failure to follow these guidelines.

- B. All persons shall wear hard hats. Appropriate eye and hearing protection must be used. Working in shorts is prohibited. Shirts must cover shoulders, back and abdomen. Working in tennis or jogging shoes, sandals, boots with high heels, cowboy and other slip-on type boots is prohibited. Hard-sole, lace-up footwear, zippered boots or boots cinched up with straps which fit snugly about the ankle are adequate. Wearing of safety boots is strongly recommended. In the vicinity of at-grade crossings, it is strongly recommended that reflective vests be worn.
- C. No one is allowed within 25' of the centerline of track without specific authorization from the flagman.
- D. All persons working near track while train is passing are to lookout for dragging bands, chains and protruding or shifted cargo.
- E. No one is allowed to cross tracks without specific authorization from the flagman.
- F. All welders and cutting torches working within 25' of track must stop when train is passing.
- G. No steel tape or chain will be allowed to cross or touch rails without permission from the Railroad.

#### 13. GUIDELINES FOR EQUIPMENT ON RAILROAD RIGHT-OF-WAY:

- A. No crane or boom equipment will be allowed to set up to work or park within boom distance plus 15' of centerline of track without specific permission from Railroad official and flagman.
- B. No crane or boom equipment will be allowed to foul track or lift a load over the track without flag protection and track time.
- C. All employees will stay with their machines when crane or boom equipment is pointed toward track.
- D. All cranes and boom equipment under load will stop work while train is passing (including pile driving).
- E. Swinging loads must be secured to prevent movement while train is passing.
- F. No loads will be suspended above a moving train.
- G. No equipment will be allowed within 25' of centerline of track without specific authorization of the flagman.
- H. Trucks, tractors or any equipment will not touch ballast line without specific permission from Railroad official and flagman. Orange construction fencing may be required as directed.
- I. No equipment or load movement within 25' or above a standing train or Railroad equipment without specific authorization of the flagman.

- J. All operating equipment within 25' of track must halt operations when a train is passing. All other operating equipment may be halted by the flagman if the flagman views the operation to be dangerous to the passing train.
- K. All equipment, loads and cables are prohibited from touching rails.
- L. While clearing and grubbing, no vegetation will be removed from Railroad embankment with heavy equipment without specific permission from the Railroad Engineer and flagman.
- M. No equipment or materials will be parked or stored on Railroad's property unless specific authorization is granted from the Railroad Engineer.
- N. All unattended equipment that is left parked on Railroad property shall be effectively immobilized so that it cannot be moved by unauthorized persons.
- O. All cranes and boom equipment will be turned away from track after each work day or whenever unattended by an operator.
- P. Prior to performing any crane operations, the Contractor shall establish a single point of contact for the Railroad flagman to remain in communication with at all times. Person must also be in direct contact with the individual(s) directing the crane operation(s).

#### 14. INSURANCE:

- A. In addition to any other forms of insurance or bonds required under the terms of the contract and specifications, the Prime Contractor will be required to carry insurance of the following kinds and amounts:
  - 1. a. Commercial General Liability Insurance having a combined single limit of not less than \$2,000,000 per occurrence for all loss, damage, cost and expense, including attorneys' fees, arising out of bodily injury liability and property damage liability during the policy period. Said policy shall include explosion, collapse, and underground hazard (XCU) coverage, shall be endorsed to name Railroad specified in item A.2.c. below both as the certificate holder and as an additional insured, and shall include a severability of interests provision.
    - b. Automobile Liability Insurance with a combined single limit of not less than \$1,000,000 each occurrence for injury to or death of persons and damage to or loss or destruction of property. Said policy or policies shall be endorsed to name Railroad specified in item A.2.c. below both as the certificate holder and as an additional insured and shall include a severability of interests provision.
  - 2. Railroad Protective Liability Insurance having a combined single limit of not less than \$2,000,000 each occurrence and \$6,000,000 in the aggregate applying separately to each annual period. If the project involves track over which passenger trains operate, the insurance limits required are not less than a combined single limit of \$5,000,000 each occurrence and \$10,000,000 in the aggregate applying separately to each annual period. Said policy shall provide coverage for all loss, damage or expense arising from bodily injury and property damage liability, and physical damage to property attributed to acts or omissions at the job site.

The standards for the Railroad Protective Liability Insurance are as follows:

- a. The insurer must be rated A- or better by A.M. Best Company, Inc.  
**NOTE: NS does not accept from insurers Chartis (AIG or Affiliated Company including Lexington Insurance Company), Hudson Group or Liberty or Affiliated Company, American Contractors Insurance Company and Erie Insurance Company including Erie Insurance Exchange and Erie Indemnity Company.**

- b. The policy must be written using one of the following combinations of Insurance Services Office ("ISO") Railroad Protective Liability Insurance Form Numbers:

- (1) CG 00 35 01 96 and CG 28 31 10 93; or
- (2) CG 00 35 07 98 and CG 28 31 07 98; or
- (3) CG 00 35 10 01; or
- (4) CG 00 35 12 04; or
- (5) CG 00 35 12 07; or
- (6) CG 00 35 04 13.

- c. The named insured shall read:

Norfolk Southern Corporation and its subsidiaries  
Three Commercial Place  
Norfolk, Virginia 23510-2191  
Attn: Risk Manager

**(NOTE: Railroad does not share coverage on RRPL with any other entity on this policy)**

- d. The description of operations must appear on the Declarations, must match the project description in this agreement, and must include the appropriate Sponsor project and contract identification numbers.
- e. The job location must appear on the Declarations and must include the city, state, and appropriate highway name/number. **NOTE: Do not include any references to milepost, valuation station, or mile marker on the insurance policy.**
- f. The name and address of the prime Contractor must appear on the Declarations.
- g. The name and address of the Sponsor must be identified on the Declarations as the "Involved Governmental Authority or Other Contracting Party."
- h. Endorsements/forms that are **required** are:
- (1) Physical Damage to Property Amendment
  - (2) Terrorism Risk Insurance Act (TRIA) coverage must be included
- i. Other endorsements/forms that will be accepted are:

- (1) Broad Form Nuclear Exclusion – Form IL 00 21
- (2) 30-day Advance Notice of Non-renewal or cancellation
- (3) Required State Cancellation Endorsement
- (4) Quick Reference or Index Form CL/IL 240

- j. Endorsements/forms that are NOT acceptable are:
  - (1) Any Pollution Exclusion Endorsement except CG 28 31
  - (2) Any Punitive or Exemplary Damages Exclusion
  - (3) Known injury or Damage Exclusion form CG 00 59
  - (4) Any Common Policy Conditions form
  - (5) An Endorsement that limits or excludes Professional Liability coverage
  - (6) A Non-Cumulation of Liability or Pyramiding of Limits Endorsement
  - (7) An Endorsement that excludes TRIA coverage
  - (8) A Sole Agent Endorsement
  - (9) Any type of deductible endorsement or amendment
  - (10) Any other endorsement/form not specifically authorized in item no. 2.h above.

- B. If any part of the work is sublet, similar insurance, and evidence thereof as specified in A.1 above, shall be provided by or on behalf of the subcontractor to cover its operations on Railroad’s right of way.
- C. All insurance required under the preceding subsection A shall be underwritten by insurers and be of such form and content, as may be acceptable to the Company. Prior to entry on Railroad right-of-way, the original Railroad Protective Liability Insurance Policy shall be submitted by the Prime Contractor to the Department at the address below for its review and transmittal to the Railroad. In addition, certificates of insurance evidencing the Prime Contractor’s and any subcontractors’ Commercial General Liability Insurance shall be issued to the Railroad and the Department at the addresses below, and forwarded to the Department for its review and transmittal to the Railroad. The certificates of insurance shall state that the insurance coverage will not be suspended, voided, canceled, or reduced in coverage or limits without (30) days advance written notice to Railroad and the Department. No work will be permitted by Railroad on its right-of-way until it has reviewed and approved the evidence of insurance required herein.

SPONSOR:

RAILROAD:

Risk Management  
 Norfolk Southern Railway Company  
 Three Commercial Place  
 Norfolk, Virginia 23510-2191

- D. The insurance required herein shall in no way serve to limit the liability of Sponsor or its Contractors under the terms of this agreement.
- E. Insurance Submission Procedures
  - 1. Railroad will only accept initial insurance submissions via US Mail or Overnight carrier to the address noted in C above. Railroad will NOT accept initial insurance submissions via email or faxes. **Please provide point of contact information with the submission including a phone number and email address. NOTE: Only one (1) set of the original or certified true copy of the Railroad Protective Policy as required under section 14 (2)**



and the contractor's certificate of liability insurance as required for section 14(1) (a) and 14 (1) (b) as part of the project should be provided to NS.

2. Railroad requires the following two (2) forms of insurance in the initial insurance submission to be submitted under a cover letter providing details of the project and contact information:
  - a. The full original or certified true countersigned copy of the railroad protective liability insurance policy in its entirety inclusive of all declarations, schedule of forms and endorsements along with the policy forms and endorsements.
  - b. The Contractor's commercial general, automobile, and workers' compensation liability insurance certificate of liability insurance evidencing a combined single limit of a minimum of \$2M per occurrence of general and \$1M per occurrence of automobile liability insurance naming Norfolk Southern Railway Company, Three Commercial Place, Norfolk, VA 23510 as the certificate holder and as an additional insured on both the general and automobile liability insurance policy.
3. It should be noted that the Railroad does not accept notation of Railroad Protective insurance on a certificate of liability insurance form or Binders as Railroad must have the full original countersigned policy. Further, please note that mere receipt of the policy is not the only issue but review for compliance. Due to the number of projects system-wide, it typically takes a minimum of 30-45 days for the Railroad to review.

15. FAILURE TO COMPLY:

- A. In the event the Contractor violates or fails to comply with any of the requirements of these Special Provisions:
  1. The Railroad Engineer may require that the Contractor vacate Railroad property.
  2. The Sponsor's Engineer may withhold all monies due the Contractor on monthly statements.
- B. Any such orders shall remain in effect until the Contractor has remedied the situation to the satisfaction of the Railroad Engineer and the Sponsor's Engineer.

16. PAYMENT FOR COST OF COMPLIANCE:

- A. No separate payment will be made for any extra cost incurred on account of compliance with these special provisions. All such costs shall be included in prices bid for other items of the work as specified in the payment items.

17. PROJECT INFORMATION

A. Date:	September 20, 2022
B. NS File No.:	
C. NS Milepost:	110.0 NC
Sponsor's Project No.:	HI-0008

**SLOPE PROTECTION VOID FILLING**

**(SPECIAL)**

**Description**

The Contractor shall use a High Density Polyurethane Foam for slope protection void filling in locations directed by the Engineer.

**Material**

The medium used shall be blown, high density, hydrophobic polyurethane. The high density, closed cell, polyurethane system shall exhibit the following characteristics and physical properties:

<b>Density, Lbs/Ft ASTM 1622</b>	<b>Compressive Strength ASTM 1621</b>
3.0	40 psi.
3.5	50 psi.
4.0	60 psi.
6.0	110 psi.

The polyurethane foam system will have a free rise density of 3.0 – 4.2 lb/ft, with a minimum compressive strength of 40 psi. The expansion of the polyurethane foam under pressure increases the foam density above the original free rise density value. The compressive strength is a function of density of the tested material; therefore the foam produced during the lifting process will normally have a higher compressive strength than foam produced without restriction (free rise).

**Equipment**

A list of lifting and undersealing equipment shall be submitted to the Engineer prior to commencement of the work for review. The minimum list of equipment required shall be as listed below. The listing is a minimum and shall not preclude the use of additional equipment.

- A pneumatic drill and an electric drill capable of drilling 5/8” to 3/4" dia. holes.
- A truck-mounted pumping unit capable of injecting the high density polyurethane formulation below the concrete slab or asphalt pavement. This pumping unit will be capable of controlling the rate of rise of the pavement.
- Stringlines or dial indicators may be periodically used to measure the rate of lift.

**Construction**

For leveling and undersealing, the Contractor shall prepare concrete to be leveled by profiling the existing slope protection and determining where the slope protection needs to be raised. Void filling shall be in areas as indicated and as directed by the Engineer.

The Contractor shall drill a series of 5/8” holes into the pavement at 3’-6’ O.C. (exact location and spacing to be determined in the field). The expanding High Density Polyurethane Foam material shall be injected under the slab. The amount of rise, if necessary, shall be controlled by regulating

the rate of High Density Polyurethane Foam material injected.

Final elevations shall be within 1/4” of the elevations proposed by profile, to the extent permitted by the structure, existing construction and site conditions. A tight string line may be used to monitor and verify elevations for slab lengths of 50ft or less. It will be the Contractor's responsibility to control these operations to make sure excessive rising of the slabs does not occur. The Contractor shall be responsible for any slab blowouts or excessive slab lifting which may result from the process and shall repair the damaged area to the satisfaction of the Engineer without additional cost.

The High Density Polyurethane Foam shall reach 90% of the full compressive strength in 15 minutes after injection.

Injection holes shall be sealed with a non-expansive cementitious grout once leveling is complete.

**Measurement and Payment**

The polyurethane material shall be paid for by the pound and the measurement verified by the following Double Verification methods.

- A conversion from pump counters to pounds will be provided with a manufacturer’s certification of the accurate conversion factor.
- A visual measurement conversion on the actual totes/barrels of pounds per inches pumped.

The quantity of material to be paid for shall be the actual quantity of High Density Polyurethane Foam used to satisfactorily complete the work. Such price and payment shall be full compensation for furnishing and injecting the material, labor, tools, equipment and all incidentals necessary to complete the work.

<b>Pay Item</b>	<b>Pay Unit</b>
Slope Protection Void Filling	Pounds

**THERMAL SPRAYED COATINGS (METALLIZATION) (12-1-2017)**

**1.0 DESCRIPTION**

Apply a thermal sprayed coating (TSC) and sealer to metal surfaces in accordance with the Thermal Sprayed Coatings (Metallization) Program and as specified herein when called for on the plans or by other Special Provisions. Use only Arc Sprayed application methods to apply TSC. The Engineer must approve other methods of application.

The Thermal Sprayed Coatings (Metallization) Program is available on the Materials and Tests Unit website.

## 2.0 QUALIFICATIONS

Only use NCDOT approved TSC Contractors meeting the requirements outlined in the Thermal Sprayed Coatings (Metallization) Program.

## 3.0 MATERIALS

Use only materials meeting the requirements of Section 7 of the Thermal Sprayed Coatings (Metallization) Program.

## 4.0 SURFACE PREPARATION AND TSC APPLICATION

Surface preparation of TSC surfaces shall meet the requirements of Section 8 of the Thermal Sprayed Coatings (Metallization) Program. Apply TSC with the alloy to the thickness specified on the plans or as required by Thermal Sprayed Coatings (Metallization) Program.

## 5.0 INSPECTION AND TESTING

The TSC Contractor must conduct inspections and tests listed in the Thermal Sprayed Coatings (Metallization) Program.

## 6.0 REPAIRS

Perform all shop repairs in accordance with the procedures outlined in the Thermal Sprayed Coatings (Metallization) Program.

Repairs associated with field welding shall be made by removing the existing metallizing by blast or power tool cleaning. Affected areas shall be addressed as follows:

- For Marine Environments, incorporate a minimum surface preparation in accordance with SSPC SP-11 (Power Tool Cleaning to Bare Metal) and require an approved epoxy mastic coating applied in accordance with the manufacturer's recommendation. Apply a minimum of two (2) coats at a rate of 5-7 (WFT) per coat to the affected area.
- For Non-Marine Environments, incorporate a minimum surface preparation in accordance with SSPC SP-11 (Power Tool Cleaning to Bare Metal) and require an approved organic zinc-rich coating applied in accordance with the manufacturer's recommendation. Apply a minimum of two (2) coats at a rate of 5-7 (WFT) per coat to the affected area.
  1. Minor localized areas less than or equal to 0.1 ft<sup>2</sup> with exposed substrate shall be repaired as outlined above for marine and non-marine environments.
  2. Large localized areas greater than 0.1 ft<sup>2</sup> with exposed substrate shall require the Contractor to submit a detailed repair procedure to the Engineer for review and approval.
- Repair methods for areas where the substrate has not been exposed shall be mutually agreed upon between the Contractor and TSC Contractor as approved by the Engineer.

**7.0 TWELVE MONTH OBSERVATION PERIOD**

All TSC materials applied under the Thermal Sprayed Coatings (Metallization) Program shall be evaluated twelve (12) months after project acceptance for defective materials and workmanship.

**8.0 BASIS OF PAYMENT**

The contract price bid for the metal component to which the TSC is applied will be full compensation for the thermal sprayed coating.

County: JOHNSTON

Line #	Item Number	Sec #	Description	Quantity	Unit Cost	Amount
<b>ROADWAY ITEMS</b>						
0001	0000100000-N	800	MOBILIZATION	Lump Sum	L.S.	
0002	1297000000-E	607	MILLING ASPHALT PAVEMENT, **** DEPTH (1-1/2")	146,763 SY		
0003	1524200000-E	610	ASPHALT CONC SURFACE COURSE, TYPE S9.5D	12,370 TON		
0004	1577000000-E	620	POLYMER MODIFIED ASPHALT BINDER FOR PLANT MIX	930 TON		
0005	1662000000-E	650	OPEN-GRADED ASPHALT FRICTION COURSE, TYPE FC-1 MODIFIED	3,320 TON		
0006	1704000000-E	SP	PATCHING EXISTING PAVEMENT	642 TON		
0007	1840000000-E	665	MILLED RUMBLE STRIPS (ASPHALT CONCRETE)	49,620 LF		
0008	3030000000-E	862	STEEL BEAM GUARDRAIL	262.5 LF		
0009	3150000000-N	862	ADDITIONAL GUARDRAIL POSTS	5 EA		
0010	3210000000-N	862	GUARDRAIL END UNITS, TYPE CAT-1	1 EA		
0011	3287000000-N	SP	GUARDRAIL END UNITS, TYPE TL-3	1 EA		
0012	4057000000-E	SP	OVERHEAD FOOTING	8 CY		
0013	4110000000-N	904	SIGN ERECTION, TYPE *** (GROUND MOUNTED) (A)	16 EA		
0014	4110000000-N	904	SIGN ERECTION, TYPE *** (GROUND MOUNTED) (B)	13 EA		
0015	4236000000-N	907	DISPOSAL OF SIGN, A & B (GROUND MOUNTED)	29 EA		
0016	4400000000-E	1110	WORK ZONE SIGNS (STATIONARY)	10 SF		

County: JOHNSTON

Line #	Item Number	Sec #	Description	Quantity	Unit Cost	Amount
0017	4405000000-E	1110	WORK ZONE SIGNS (PORTABLE)	1,060 SF		
0018	4410000000-E	1110	WORK ZONE SIGNS (BARRICADE MOUNTED)	240 SF		
0019	4413000000-E	SP	WORK ZONE ADVANCE/GENERAL WARNING SIGNING	224 SF		
0020	4415000000-N	1115	FLASHING ARROW BOARD	4 EA		
0021	4420000000-N	1120	PORTABLE CHANGEABLE MESSAGE SIGN	12 EA		
0022	4423000000-N	SP	WORK ZONE DIGITAL SPEED LIMIT SIGNS	10 EA		
0023	4424000000-N	SP	WORK ZONE PRESENCE LIGHTING	14 EA		
0024	4430000000-N	1130	DRUMS	220 EA		
0025	4434000000-N	SP	SEQUENTIAL FLASHING WARNING LIGHTS	24 EA		
0026	4445000000-E	1145	BARRICADES (TYPE III)	120 LF		
0027	4480000000-N	1165	TMA	2 EA		
0028	4510000000-N	1190	LAW ENFORCEMENT	498 HR		
0029	4600000000-N	SP	GENERIC TRAFFIC CONTROL ITEM CONNECTED LANE CLOSURE DEVICE	4 EA		
0030	4600000000-N	SP	GENERIC TRAFFIC CONTROL ITEM RAMP/LOOP CLOSURES	8 EA		
0031	4600000000-N	SP	GENERIC TRAFFIC CONTROL ITEM SINGLE LANE CLOSURE	50 EA		
0032	4688000000-E	1205	THERMOPLASTIC PAVEMENT MARKING LINES (6", 90 MILS)	75,820 LF		
0033	4700000000-E	1205	THERMOPLASTIC PAVEMENT MARKING LINES (12", 90 MILS)	4,520 LF		

County: JOHNSTON

Line #	Item Number	Sec #	Description	Quantity	Unit Cost	Amount
0034	4709000000-E	1205	THERMOPLASTIC PAVEMENT MARKING LINES (24", 90 MILS)	40 LF		
0035	4725000000-E	1205	THERMOPLASTIC PAVEMENT MARKING SYMBOL (90 MILS)	22 EA		
0036	4815000000-E	1205	PAINT PAVEMENT MARKING LINES (6")	63,700 LF		
0037	4825000000-E	1205	PAINT PAVEMENT MARKING LINES (12")	4,520 LF		
0038	4847096000-E	SP	POLYUREA PAVEMENT MARKING LINES, ***, ** MILS (STANDARD GLASS BEADS) (6", 20 MILS)	2,010 LF		
0039	4905100000-N	SP	NON-CAST IRON SNOWPLOWABLE PAVEMENT MARKER	870 EA		
0040	5255000000-N	1413	PORTABLE LIGHTING	Lump Sum	L.S.	
0041	7300000000-E	1715	UNPAVED TRENCHING (*****) (2, 2")	50 LF		
0042	7980000000-N	SP	GENERIC SIGNAL ITEM DMS ACCESS LADDER	1 EA		
0043	7980000000-N	SP	GENERIC SIGNAL ITEM DMS PEDESTAL STRUCTURE	1 EA		
0044	7980000000-N	SP	GENERIC SIGNAL ITEM DYNAMIC MESSAGE SIGN (TYPE 2C)	1 EA		
0045	7980000000-N	SP	GENERIC SIGNAL ITEM MODIFY EXISTING ELECTRICAL SERVICE	1 EA		
0046	7980000000-N	SP	GENERIC SIGNAL ITEM REMOVAL AND DISPOSAL OF EXISTING DMS COMPONENTS	1 EA		
0047	7980000000-N	SP	GENERIC SIGNAL ITEM REMOVAL AND DISPOSAL OF EXISTING DMS STRUCTURE	1 EA		
0048	7980000000-N	SP	GENERIC SIGNAL ITEM REMOVAL AND DISPOSAL OF EXISTING DMS STRUCTURE FOUNDATION	2 EA		



County: JOHNSTON

Line #	Item Number	Sec #	Description	Quantity	Unit Cost	Amount
<b>STRUCTURE ITEMS</b>						
0049	8161000000-E	420	GROOVING BRIDGE FLOORS	31,570 SF		
0050	8296000000-N	442	POLLUTION CONTROL	Lump Sum	L.S.	
0051	8559000000-E	SP	CLASS II, SURFACE PREPARATION	54.3 SY		
0052	8660000000-E	SP	CONCRETE REPAIRS	20.6 CF		
0053	8664000000-E	SP	SHOTCRETE REPAIRS	49.1 CF		
0054	8678000000-E	SP	EPOXY RESIN INJECTION	47.7 LF		
0055	8860000000-N	SP	GENERIC STRUCTURE ITEM CLEANING & REPAINTING OF BRIDGE #500106	Lump Sum	L.S.	
0056	8860000000-N	SP	GENERIC STRUCTURE ITEM CLEANING & REPAINTING OF BRIDGE #500107	Lump Sum	L.S.	
0057	8860000000-N	SP	GENERIC STRUCTURE ITEM PAINTING CONTAINMENT FOR BRIDGE #500106	Lump Sum	L.S.	
0058	8860000000-N	SP	GENERIC STRUCTURE ITEM PAINTING CONTAINMENT FOR BRIDGE #500107	Lump Sum	L.S.	
0059	8860000000-N	SP	GENERIC STRUCTURE ITEM VOLUMETRIC MIXER	Lump Sum	L.S.	
0060	8867000000-E	SP	GENERIC STRUCTURE ITEM POURABLE SILICONE JOINT SEALANT	538.2 LF		
0061	8867000000-E	SP	GENERIC STRUCTURE ITEM STRIP SEALS FOR PRESERVATION	92.8 LF		
0062	8889000000-E	SP	GENERIC STRUCTURE ITEM SLOPE PROTECTION VOID FILLING	27,837 LB		
0063	8892000000-E	SP	GENERIC STRUCTURE ITEM CONCRETE WORK FOR JOINT REPLACEMENT	201.2 SF		
0064	8893000000-E	SP	GENERIC STRUCTURE ITEM PLACING & FINISHING POLYMER CONCRETE OVERLAY	3,796 SY		

County: JOHNSTON

Line #	Item Number	Sec #	Description	Quantity	Unit Cost	Amount
0065	8893000000-E	SP	GENERIC STRUCTURE ITEM SCARIFYING BRIDGE DECK	3,796 SY		
0066	8893000000-E	SP	GENERIC STRUCTURE ITEM SHOTBLASTING BRIDGE DECK	3,796 SY		
0067	8897000000-N	SP	GENERIC STRUCTURE ITEM TYPE I BRIDGE JACKING BRIDGE #500106	6 EA		
0068	8897000000-N	SP	GENERIC STRUCTURE ITEM TYPE I BRIDGE JACKING BRIDGE #500107	1 EA		
***** BEGIN SCHEDULE AA ***** ***** ( 2 ALTERNATES ) *****						
0069 AA1	8881000000-E	SP	GENERIC STRUCTURE ITEM POLYESTER POLYMER CONCRETE MATERIALS	211.4 CY		
*** OR ***						
0070 AA2	8881000000-E	SP	GENERIC STRUCTURE ITEM EPOXY POLYMER CONCRETE MATERIALS	211.4 CY		
***** END SCHEDULE AA *****						

1253/Aug10/Q440277.2/D409900496000/E70

Total Amount Of Bid For Entire Project :

Vendor 1 of 2: S T WOOTEN CORPORATION (3760)  
Call Order 003 (Proposal: C204650)

### Bid Information

---

<b>Proposal County:</b> JOHNSTON	<b>Bid Checksum:</b> 30F7C503D3
<b>Vendor Address:</b> P.O. Box 2408 WILSON , NC , 278942408	<b>Bid Total:</b> \$7,279,037.99
<b>Signature Check:</b> Jonathan Karl Bivens	<b>Items Total:</b> \$7,279,037.99
<b>Time Bid Received:</b> September 20, 2022 01:33 PM	<b>Time Total:</b> \$0.00
<b>Amendment Count:</b> 0	

**Bidding Errors:**  
None.

**DBE Goal: 4% (\$291,161.52)**  
**Participation Submitted: 7.07% (\$291,164.00)**

**Vendor 1 of 2: S T WOOTEN CORPORATION (3760)**  
**Call Order 003 (Proposal: C204650)**

### Bid Bond Information

---

<b>Projects:</b>	<b>Bond Maximum:</b>
<b>Counties:</b>	<b>State of Incorporation:</b> IL
<b>Bond ID:</b> 2892-9F40-42CB-3311	<b>Agency Execution Date:</b> 2022-09-20T00
<b>Paid by Check:</b> No	<b>Surety Name:</b> Tinubu Surety
<b>Bond Percent:</b> 5%	<b>Bond Agency Name:</b> Fidelity and Deposit Company of Maryland

### DBE Load Information

Letting ID: L220920  
Letting Date: 09/20/2022  
Call Order: 003  
Contract ID: C204650  
Project: 0095077009507700950770095077  
Bid Total: \$7,279,037.99  
DBE Goal: 4.00% (\$291,161.52)

Vendor ID: 3760  
Vendor Name: S.T. Wooten  
DBE Entered: 4.00% (\$291,164.00)

<u>Vendor ID</u>	<u>DBE Name</u>	<u>Is Supplier?</u>	<u>City/State</u>	<u>Goods/Service</u>	<u>Amount</u>
4761	TRAFFIC CONTROL SAFETY SERVICES, INC.	False	POST OFFICE BOX 24511, WINSTON-SALEM, NC 27114	SubContractor	280,790.00
11110	J M COLLINS HAULING LLC	False	151 NEW CREECH RD, SELMA, NC 27576	SubContractor	10,374.00

Letting: L220920  
09/20/2022 02:00:00 PM

North Carolina Department of Transportation  
3760 - S.T. Wooten

Contract ID: C204650  
Call: 003

BondID: 2892-9F40-42CB-3311

Surety Registry Agency: Tinubu Surety

Verified?: 1

Surety Agency: Fidelity and Deposit Company of Maryland

Bond Execution Date: 2022-09-20T00:00:00

Line Number	Item Number	Quantity	Unit	Unit Price	Extension Price
Section 0001 ROADWAY ITEMS					
0001	0000100000-N MOBILIZATION	1.000	LS	\$965,000.0000	\$965,000.00
0002	1297000000-E MILLING ASPHALT PAVEMENT, ***" DEPTH (1-1/2")	146763.000	SY	\$2.2000	\$322,878.60
0003	1524200000-E ASPHALT CONC SURFACE COURSE, TYPE S9.5D	12370.000	TON	\$71.2500	\$881,362.50
0004	1577000000-E POLYMER MODIFIED ASPHALT BINDER FOR PLANT MIX	930.000	TON	\$750.0000	\$697,500.00
0005	1662000000-E OPEN-GRADED ASPHALT FRICTION COURSE, TYPE FC-1 MODIFIED	3320.000	TON	\$91.2500	\$302,950.00
0006	1704000000-E PATCHING EXISTING PAVEMENT	642.000	TON	\$249.1600	\$159,960.72
0007	1840000000-E MILLED RUMBLE STRIPS (ASPHALT CONCRETE)	49620.000	LF	\$0.2400	\$11,908.80
0008	3030000000-E STEEL BEAM GUARDRAIL	262.500	LF	\$28.0000	\$7,350.00
0009	3150000000-N ADDITIONAL GUARDRAIL POSTS	5.000	EA	\$55.0000	\$275.00
0010	3210000000-N GUARDRAIL END UNITS, TYPE CAT-1	1.000	EA	\$950.0000	\$950.00
0011	3287000000-N GUARDRAIL END UNITS, TYPE TL-3	1.000	EA	\$3,800.0000	\$3,800.00
0012	4057000000-E OVERHEAD FOOTING	8.000	CY	\$1,500.0000	\$12,000.00
0013	4110000000-N SIGN ERECTION, TYPE *** (GROUND MOUNTED) (A)	16.000	EA	\$1,000.0000	\$16,000.00
0014	4110000000-N SIGN ERECTION, TYPE *** (GROUND MOUNTED) (B)	13.000	EA	\$500.0000	\$6,500.00
0015	4236000000-N DISPOSAL OF SIGN, A & B (GROUND MOUNTED)	29.000	EA	\$10.0000	\$290.00
0016	4400000000-E WORK ZONE SIGNS (STATIONARY)	10.000	SF	\$8.5000	\$85.00
0017	4405000000-E WORK ZONE SIGNS (PORTABLE)	1060.000	SF	\$8.8500	\$9,381.00
0018	4410000000-E WORK ZONE SIGNS (BARRICADE MOUNTED)	240.000	SF	\$9.6500	\$2,316.00
0019	4413000000-E WORK ZONE ADVANCE/GENERAL WARNING SIGNING	224.000	SF	\$7.4500	\$1,668.80
0020	4415000000-N FLASHING ARROW BOARD	4.000	EA	\$1,850.0000	\$7,400.00
0021	4420000000-N PORTABLE CHANGEABLE MESSAGE SIGN	12.000	EA	\$6,300.0000	\$75,600.00
0022	4423000000-N WORK ZONE DIGITAL SPEED LIMIT SIGNS	10.000	EA	\$3,300.0000	\$33,000.00
0023	4424000000-N WORK ZONE PRESENCE LIGHTING	14.000	EA	\$1,800.0000	\$25,200.00

0024	4430000000-N DRUMS	220.000 EA	\$46.0000	\$10,120.00
0025	4434000000-N SEQUENTIAL FLASHING WARNING LIGHTS	24.000 EA	\$135.0000	\$3,240.00
0026	4445000000-E BARRICADES (TYPE III)	120.000 LF	\$26.0000	\$3,120.00
0027	4480000000-N TMA	2.000 EA	\$2,800.0000	\$5,600.00
0028	4510000000-N LAW ENFORCEMENT	498.000 HR	\$65.0000	\$32,370.00
0029	4600000000-N GENERIC TRAFFIC CONTROL ITEM CONNECTED LANE CLOSURE DEVICE	4.000 EA	\$2,400.0000	\$9,600.00
0030	4600000000-N GENERIC TRAFFIC CONTROL ITEM RAMP/LOOP CLOSURES	8.000 EA	\$950.0000	\$7,600.00
0031	4600000000-N GENERIC TRAFFIC CONTROL ITEM SINGLE LANE CLOSURE	50.000 EA	\$1,680.0000	\$84,000.00
0032	4688000000-E THERMOPLASTIC PAVEMENT MARKING LINES (6", 90 MILS)	75820.000 LF	\$1.1500	\$87,193.00
0033	4700000000-E THERMOPLASTIC PAVEMENT MARKING LINES (12", 90 MILS)	4520.000 LF	\$2.0000	\$9,040.00
0034	4709000000-E THERMOPLASTIC PAVEMENT MARKING LINES (24", 90 MILS)	40.000 LF	\$25.0000	\$1,000.00
0035	4725000000-E THERMOPLASTIC PAVEMENT MARKING SYMBOL (90 MILS)	22.000 EA	\$250.0000	\$5,500.00
0036	4815000000-E PAINT PAVEMENT MARKING LINES (6")	63700.000 LF	\$0.4000	\$25,480.00
0037	4825000000-E PAINT PAVEMENT MARKING LINES (12")	4520.000 LF	\$0.7500	\$3,390.00
0038	4847096000-E POLYUREA PAVEMENT MARKING LINES, **", ** MILS (STANDARD GLASS BEADS) (6", 20 MILS)	2010.000 LF	\$6.0000	\$12,060.00
0039	4905100000-N NON-CAST IRON SNOWPLOWABLE PAVEMENT MARKER	870.000 EA	\$45.0000	\$39,150.00
0040	5255000000-N PORTABLE LIGHTING	1.000 LS	\$355,502.6700	\$355,502.67
0041	7300000000-E UNPAVED TRENCHING (***** (2, 2"))	50.000 LF	\$200.0000	\$10,000.00
0042	7980000000-N GENERIC SIGNAL ITEM DMS ACCESS LADDER	1.000 EA	\$9,500.0000	\$9,500.00
0043	7980000000-N GENERIC SIGNAL ITEM DMS PEDESTAL STRUCTURE	1.000 EA	\$72,500.0000	\$72,500.00
0044	7980000000-N GENERIC SIGNAL ITEM DYNAMIC MESSAGE SIGN (TYPE 2C)	1.000 EA	\$110,000.0000	\$110,000.00
0045	7980000000-N GENERIC SIGNAL ITEM MODIFY EXISTING ELECTRICAL SERVICE	1.000 EA	\$10,000.0000	\$10,000.00
0046	7980000000-N GENERIC SIGNAL ITEM REMOVAL AND DISPOSAL OF EXISTING DMS COMPONENTS	1.000 EA	\$5,000.0000	\$5,000.00
0047	7980000000-N GENERIC SIGNAL ITEM REMOVAL AND DISPOSAL OF EXISTING DMS STRUCTURE	1.000 EA	\$2,000.0000	\$2,000.00



0048	7980000000-N	2.000 EA	\$7,500.0000	\$15,000.00
	GENERIC SIGNAL ITEM REMOVAL AND DISPOSAL OF EXISTING DMS STRUCTURE FOUNDATION			
Section 0001 Total				\$4,471,342.09
Section 0004 STRUCTURE ITEMS				
0049	8161000000-E	31570.000 SF	\$0.5700	\$17,994.90
	GROOVING BRIDGE FLOORS			
0050	8296000000-N	1.000 LS	\$1.0000	\$1.00
	POLLUTION CONTROL			
0051	8559000000-E	54.300 SY	\$1,000.0000	\$54,300.00
	CLASS II, SURFACE PREPARATION			
0052	8660000000-E	20.600 CF	\$950.0000	\$19,570.00
	CONCRETE REPAIRS			
0053	8664000000-E	49.100 CF	\$875.0000	\$42,962.50
	SHOTCRETE REPAIRS			
0054	8678000000-E	47.700 LF	\$95.0000	\$4,531.50
	EPOXY RESIN INJECTION			
0055	8860000000-N	1.000 LS	\$300,000.0000	\$300,000.00
	GENERIC STRUCTURE ITEM CLEANING & REPAINTING OF BRIDGE #500106			
0056	8860000000-N	1.000 LS	\$300,000.0000	\$300,000.00
	GENERIC STRUCTURE ITEM CLEANING & REPAINTING OF BRIDGE #500107			
0057	8860000000-N	1.000 LS	\$100,000.0000	\$100,000.00
	GENERIC STRUCTURE ITEM PAINTING CONTAINMENT FOR BRIDGE #500106			
0058	8860000000-N	1.000 LS	\$100,000.0000	\$100,000.00
	GENERIC STRUCTURE ITEM PAINTING CONTAINMENT FOR BRIDGE #500107			
0059	8860000000-N	1.000 LS	\$28,382.5000	\$28,382.50
	GENERIC STRUCTURE ITEM VOLUMETRIC MIXER			
0060	8867000000-E	538.200 LF	\$100.0000	\$53,820.00
	GENERIC STRUCTURE ITEM POURABLE SILICONE JOINT SEALANT			
0061	8867000000-E	92.800 LF	\$1,200.0000	\$111,360.00
	GENERIC STRUCTURE ITEM STRIP SEALS FOR PRESERVATION			
0062	8889000000-E	27837.000 LB	\$7.5000	\$208,777.50
	GENERIC STRUCTURE ITEM SLOPE PROTECTION VOID FILLING			
0063	8892000000-E	201.200 SF	\$975.0000	\$196,170.00
	GENERIC STRUCTURE ITEM CONCRETE WORK FOR JOINT REPLACEMENT			
0064	8893000000-E	3796.000 SY	\$120.0000	\$455,520.00
	GENERIC STRUCTURE ITEM PLACING & FINISHING POLYMER CONCRETE OVERLAY			
0065	8893000000-E	3796.000 SY	\$33.0000	\$125,268.00
	GENERIC STRUCTURE ITEM SCARIFYING BRIDGE DECK			
0066	8893000000-E	3796.000 SY	\$18.0000	\$68,328.00
	GENERIC STRUCTURE ITEM SHOTBLASTING BRIDGE DECK			
0067	8897000000-N	6.000 EA	\$8,000.0000	\$48,000.00
	GENERIC STRUCTURE ITEM TYPE I BRIDGE JACKING BRIDGE #500106			
0068	8897000000-N	1.000 EA	\$12,500.0000	\$12,500.00
	GENERIC STRUCTURE ITEM TYPE I BRIDGE JACKING BRIDGE #500107			
0069	8881000000-E	211.400 CY	\$2,650.0000	\$560,210.00
AA1	GENERIC STRUCTURE ITEM POLYESTER POLYMER CONCRETE MATERIALS			

---

0070	8881000000-E	211.400	CY	
AA2	GENERIC STRUCTURE ITEM EPOXY POLYMER CONCRETE MATERIALS			

---

Section 0004 Total				\$2,807,695.90
--------------------	--	--	--	----------------

---

Item Total				\$7,279,037.99
------------	--	--	--	----------------

---

**ELECTRONIC BID SUBMISSION**

By submitting this bid electronically, I hereby acknowledge that all requirements included in the hard copy proposal, addendum, amendments, plans, standard specifications, supplemental specifications and special provisions are part of the bid and contract. Further, I acknowledge that I have read, understand, accept, acknowledge and agree to comply with all statements in this electronic bid.

=====

**NON-COLLUSION, DEBARMENT AND GIFT BAN CERTIFICATION**

The prequalified bidder declares (or certifies, verifies, or states) under penalty of perjury under the laws of the United States that neither he, nor any official, agent or employee has entered into any agreement, participated in any collusion, or otherwise taken any action which is in restraint of free competitive bidding in connection with any bid or contract, that the prequalified bidder has not been convicted of violating N.C.G.S. §133-24 within the last three years, and that the prequalified bidder intends to do the work with his own bonafide employees or subcontractors and will not bid for the benefit of another contractor.

By submitting this non-collusion, debarment and gift ban certification, the Contractor is attesting his status under penalty of perjury under the laws of the United States in accordance with the Debarment Certification attached, provided that the Debarment Certification also includes any required statements concerning exceptions that are applicable.

N.C.G.S. §133-32 and Executive Order 24 prohibit the offer to, or acceptance by, any State Employee of any gift from anyone with a contract with the State, or from any person seeking to do business with the State. By execution of any response in this procurement, you attest, for your entire organization and its employees or agents, that you are not aware that any such gift has been offered, accepted, or promised by any employees of your organization.

**DEBARMENT CERTIFICATION OF PREQUALIFIED BIDDER**

Conditions for certification:

1. The prequalified bidder shall provide immediate written notice to the Department if at any time the bidder learns that his certification was erroneous when he submitted his debarment certification or explanation that is file with the Department, or has become erroneous because of changed circumstances.
2. The terms covered transaction, debarred, suspended, ineligible, lower tier

covered transaction, participant, person, primary covered transaction, principal, proposal, and voluntarily excluded, as used in this provision, have the meanings set out in the Definitions and Coverage sections of the rules implementing Executive Order 12549. A copy of the Federal Rules requiring this certification and detailing the definitions and coverages may be obtained from the Contract Officer of the Department.

3. The prequalified bidder agrees by submitting this form, that he will not knowingly enter into any lower tier covered transaction with a person who is debarred, suspended, declared ineligible, or voluntarily excluded from participation in NCDOT contracts, unless authorized by the Department.

4. For Federal Aid projects, the prequalified bidder further agrees that by submitting this form he will include the Federal- Aid Provision titled Required Contract Provisions Federal-Aid Construction Contract (Form FHWA PR 1273) provided by the Department, without subsequent modification, in all lower tier covered transactions.

5. The prequalified bidder may rely upon a certification of a participant in a lower tier covered transaction that he is not debarred, suspended, ineligible, or voluntarily excluded from the covered transaction, unless he knows that the certification is erroneous. The bidder may decide the method and frequency by which he will determine the eligibility of his subcontractors.

6. Nothing contained in the foregoing shall be construed to require establishment of a system of records in order to render in good faith the certification required by this provision. The knowledge and information of a participant is not required to exceed that which is normally possessed by a prudent person in the ordinary course of business dealings.

7. Except as authorized in paragraph 6 herein, the Department may terminate any contract if the bidder knowingly enters into a lower tier covered transaction with a person who is suspended, debarred, ineligible, or voluntarily excluded from participation in this transaction, in addition to other remedies available by the Federal Government.

### **DEBARMENT CERTIFICATION**

The prequalified bidder certifies to the best of his knowledge and belief, that he and his principals:

a. Are not presently debarred, suspended, proposed for debarment, declared ineligible, or voluntarily excluded from covered transactions by any Federal department or agency;

b. Have not within a three-year period preceding this proposal been convicted of or had a civil judgment rendered against them for commission of fraud or a criminal offense in connection with obtaining, attempting to obtain, or performing a public (Federal, State or local) transaction or contract under a public transaction; violation of Federal or State antitrust statutes or

commission of embezzlement, theft, forgery, bribery, falsification or destruction of records; making false statements; or receiving stolen property;

c. Are not presently indicted for or otherwise criminally or civilly charged by a governmental entity (Federal, State or local) with commission of any of the offenses enumerated in paragraph b. of this certification; and

d. Have not within a three-year period preceding this proposal had one or more public transactions (Federal, State or local) terminated for cause or default.

e. Will submit a revised Debarment Certification immediately if his status changes and will show in his bid proposal an explanation for the change in status.

If the prequalified bidder cannot certify that he is not debarred, he shall provide an explanation with this submittal. An explanation will not necessarily result in denial of participation in a contract.

Failure to submit a non-collusion and debarment certification will result in the prequalified bidder's bid being considered non-responsive.

**EXPLANATION:**

=====

### Award Limits on Multiple Projects

By answering YES to this statement, the bidder acknowledges that they are using the award limits on multiple projects? **Yes**  **No**

A bidder who desires to bid on more than one project on which bids are to be opened on the same date, and who also desires to avoid receiving an award of more projects than he is equipped to handle, may bid on any number of projects but may limit the total amount of work awarded to him on selected projects by completing the AWARD LIMITS ON MULTIPLE PROJECTS.

The Award Limits on Multiple Projects must be filled in on each project bid for which the Bidder desires protection.

It is the desire of the Bidder to be awarded contracts, the value of which will not exceed a total of     for those

projects indicated herein, for which bids will be opened on     (MM/DD/YY)

The Award Limits shall apply to the following projects:

Contract Number  
County

Contract Number  
County

Contract Number  
County

Contract Number  
County

Contract Number  
County

Contract Number  
County

It is agreed that if I am (we are) the low Bidder(s) on indicated projects, the total value of which is more than the above stipulated award limits, the Board of Transportation will award me (us) projects from among those indicated

that have a total value not to exceed the award limit and will result in the lowest total bids to the Department of Transportation.

### DBE List Summary

Project: 0095077

Bidder ID: 3760

Bid Total: 7,279,037.99

Business Name: S.T. Wooten

Goal: 4.00% (291,161.52)

Total Entered: 4.00% (291,164.00)

ID	Name	Is Supplier?	Item Count	Amount	Is Complete?
4761	TRAFFIC CONTROL SAFETY SERVICES, INC.	False	13	280,790.00	True
11110	J M COLLINS HAULING LLC	False	1	10,374.00	True



Name: TRAFFIC CONTROL SAFETY SERVICES, INC. ID: 4761

Address: POST OFFICE BOX 24511 , WINSTON-SALEM, NC 27114

Used As: SubContractor DBE Items Total:\$280,790.00

**Items for TRAFFIC CONTROL SAFETY SERVICES, INC.**

0001 ROADWAY ITEMS				
0001	0000100000-N MOBILIZATION	1.000	LS	\$12,000.0000 \$12,000.00
0012	4057000000-E OVERHEAD FOOTING	8.000	CY	\$1,500.0000 \$12,000.00
0013	4110000000-N SIGN ERECTION, TYPE *** (GROUND MOUNTED) (A)	16.000	EA	\$1,000.0000 \$16,000.00
0014	4110000000-N SIGN ERECTION, TYPE *** (GROUND MOUNTED) (B)	13.000	EA	\$500.0000 \$6,500.00
0015	4236000000-N DISPOSAL OF SIGN, A & B (GROUND MOUNTED)	29.000	EA	\$10.0000 \$290.00
0041	7300000000-E UNPAVED TRENCHING (***** ) (2, 2")	50.000	LF	\$200.0000 \$10,000.00
0042	7980000000-N GENERIC SIGNAL ITEM DMS ACCESS LADDER	1.000	EA	\$9,500.0000 \$9,500.00
0043	7980000000-N GENERIC SIGNAL ITEM DMS PEDESTAL STRUCTURE	1.000	EA	\$72,500.0000 \$72,500.00
0044	7980000000-N GENERIC SIGNAL ITEM DYNAMIC MESSAGE SIGN (TYPE 2C)	1.000	EA	\$110,000.0000 \$110,000.00
0045	7980000000-N GENERIC SIGNAL ITEM MODIFY EXISTING ELECTRICAL SERVICE	1.000	EA	\$10,000.0000 \$10,000.00
0046	7980000000-N GENERIC SIGNAL ITEM REMOVAL AND DISPOSAL OF EXISTING DMS COMPONENTS	1.000	EA	\$5,000.0000 \$5,000.00
0047	7980000000-N GENERIC SIGNAL ITEM REMOVAL AND DISPOSAL OF EXISTING DMS STRUCTURE	1.000	EA	\$2,000.0000 \$2,000.00
0048	7980000000-N GENERIC SIGNAL ITEM REMOVAL AND DISPOSAL OF EXISTING DMS STRUCTURE FOUNDATION	2.000	EA	\$7,500.0000 \$15,000.00
Section 0001 Total				\$280,790.00
Item Total				\$280,790.00

Name: J M COLLINS HAULING LLC ID: 11110

Address: 151 NEW CREECH RD , SELMA, NC 27576

Used As: SubContractor DBE Items Total:\$10,374.00

**Items for J M COLLINS HAULING LLC**

---

0001				
ROADWAY ITEMS				
0003	1524200000-E	1729 TON	\$6.0000	\$10,374.00
	ASPHALT CONC SURFACE COURSE, TYPE S9.5D			
Note: Haul Asphalt and Plant Stockpile				
Section 0001 Total				\$10,374.00
<hr/>				
Item Total				\$10,374.00

---

THIS PROPOSAL CONTAINS THE FOLLOWING ERRORS/WARNINGS (IF ANY)

This Bid contains 0 amendment files

**Electronic Bid Submission**

By submitting this bid electronically, I hereby acknowledge that all requirements included in the hard copy proposal, addendum, amendments, plans, standard specifications, supplemental specifications and special provisions are part of the bid and contract. Further, I acknowledge that I have read, understand, accept, acknowledge and agree to comply with all statements in this electronic bid.

I hereby certify that I have the authority to submit this bid.

Signature \_\_\_\_\_

Agency \_\_\_\_\_

Date \_\_\_\_\_

Signature \_\_\_\_\_

Agency \_\_\_\_\_

Date \_\_\_\_\_

Signature \_\_\_\_\_

Agency \_\_\_\_\_

Date \_\_\_\_\_

## Attachments

Failure to complete and attach the Fuel Usage Factor Adjustment Form will result in using 2.90 gallons per ton as the Fuel Usage Factor for Diesel for the asphalt items included on the form. The contractor will not be permitted to change the option after the bids are submitted.

NOTE: The maximum upload limit is 5 MB.

Verify

Line #	ItemNumber	Sec #	Description	Quantity Unit	Unit Bid Price	Amount Bid
<b>ROADWAY ITEMS</b>						
0001	0000100000-N	800	MOBILIZATION	LUMP SUM	965,000.00	965,000.00
0002	1297000000-E	607	MILLING ASPHALT PAVEMENT, **** DEPTH (1-1/2")	146,763 SY	2.20	322,878.60
0003	1524200000-E	610	ASPHALT CONC SURFACE COURSE, TYPE S9.5D	12,370 TON	71.25	881,362.50
0004	1577000000-E	620	POLYMER MODIFIED ASPHALT BINDER FOR PLANT MIX	930 TON	750.00	697,500.00
0005	1662000000-E	650	OPEN-GRADED ASPHALT FRICTION COURSE, TYPE FC-1 MODIFIED	3,320 TON	91.25	302,950.00
0006	1704000000-E	SP	PATCHING EXISTING PAVEMENT	642 TON	249.16	159,960.72
0007	1840000000-E	665	MILLED RUMBLE STRIPS (ASPHALT CONCRETE)	49,620 LF	0.24	11,908.80
0008	3030000000-E	862	STEEL BEAM GUARDRAIL	262.5 LF	28.00	7,350.00
0009	3150000000-N	862	ADDITIONAL GUARDRAIL POSTS	5 EA	55.00	275.00
0010	3210000000-N	862	GUARDRAIL END UNITS, TYPE CAT-1	1 EA	950.00	950.00
0011	3287000000-N	SP	GUARDRAIL END UNITS, TYPE TL-3	1 EA	3,800.00	3,800.00
0012	4057000000-E	SP	OVERHEAD FOOTING	8 CY	1,500.00	12,000.00
0013	4110000000-N	904	SIGN ERECTION, TYPE *** (GROUND MOUNTED) (A)	16 EA	1,000.00	16,000.00
0014	4110000000-N	904	SIGN ERECTION, TYPE *** (GROUND MOUNTED) (B)	13 EA	500.00	6,500.00
0015	4236000000-N	907	DISPOSAL OF SIGN, A & B (GROUND MOUNTED)	29 EA	10.00	290.00
0016	4400000000-E	1110	WORK ZONE SIGNS (STATIONARY)	10 SF	8.50	85.00
0017	4405000000-E	1110	WORK ZONE SIGNS (PORTABLE)	1,060 SF	8.85	9,381.00
0018	4410000000-E	1110	WORK ZONE SIGNS (BARRICADE MOUNTED)	240 SF	9.65	2,316.00
0019	4413000000-E	SP	WORK ZONE ADVANCE/GENERAL WARNING SIGNING	224 SF	7.45	1,668.80
0020	4415000000-N	1115	FLASHING ARROW BOARD	4 EA	1,850.00	7,400.00
0021	4420000000-N	1120	PORTABLE CHANGEABLE MESSAGE SIGN	12 EA	6,300.00	75,600.00

Line #	ItemNumber	Sec #	Description	Quantity Unit	Unit Bid Price	Amount Bid
0022	4423000000-N	SP	WORK ZONE DIGITAL SPEED LIMIT SIGNS	10 EA	3,300.00	33,000.00
0023	4424000000-N	SP	WORK ZONE PRESENCE LIGHTING	14 EA	1,800.00	25,200.00
0024	4430000000-N	1130	DRUMS	220 EA	46.00	10,120.00
0025	4434000000-N	SP	SEQUENTIAL FLASHING WARNING LIGHTS	24 EA	135.00	3,240.00
0026	4445000000-E	1145	BARRICADES (TYPE III)	120 LF	26.00	3,120.00
0027	4480000000-N	1165	TMA	2 EA	2,800.00	5,600.00
0028	4510000000-N	1190	LAW ENFORCEMENT	498 HR	65.00	32,370.00
0029	4600000000-N	SP	GENERIC TRAFFIC CONTROL ITEM CONNECTED LANE CLOSURE DEVICE	4 EA	2,400.00	9,600.00
0030	4600000000-N	SP	GENERIC TRAFFIC CONTROL ITEM RAMP/LOOP CLOSURES	8 EA	950.00	7,600.00
0031	4600000000-N	SP	GENERIC TRAFFIC CONTROL ITEM SINGLE LANE CLOSURE	50 EA	1,680.00	84,000.00
0032	4688000000-E	1205	THERMOPLASTIC PAVEMENT MARKING LINES (6", 90 MILS)	75,820 LF	1.15	87,193.00
0033	4700000000-E	1205	THERMOPLASTIC PAVEMENT MARKING LINES (12", 90 MILS)	4,520 LF	2.00	9,040.00
0034	4709000000-E	1205	THERMOPLASTIC PAVEMENT MARKING LINES (24", 90 MILS)	40 LF	25.00	1,000.00
0035	4725000000-E	1205	THERMOPLASTIC PAVEMENT MARKING SYMBOL (90 MILS)	22 EA	250.00	5,500.00
0036	4815000000-E	1205	PAINT PAVEMENT MARKING LINES (6")	63,700 LF	0.40	25,480.00
0037	4825000000-E	1205	PAINT PAVEMENT MARKING LINES (12")	4,520 LF	0.75	3,390.00
0038	4847096000-E	SP	POLYUREA PAVEMENT MARKING LINES, ***, ** MILS (STANDARD GLASS BEADS) (6", 20 MILS)	2,010 LF	6.00	12,060.00
0039	4905100000-N	SP	NON-CAST IRON SNOWPLOWABLE PAVEMENT MARKER	870 EA	45.00	39,150.00
0040	5255000000-N	1413	PORTABLE LIGHTING	LUMP SUM	355,502.67	355,502.67
0041	7300000000-E	1715	UNPAVED TRENCHING (***** (2, 2")	50 LF	200.00	10,000.00
0042	7980000000-N	SP	GENERIC SIGNAL ITEM DMS ACCESS LADDER	1 EA	9,500.00	9,500.00
0043	7980000000-N	SP	GENERIC SIGNAL ITEM DMS PEDESTAL STRUCTURE	1 EA	72,500.00	72,500.00

## Contract Item Sheets For C204650

Line #	ItemNumber	Sec #	Description	Quantity Unit	Unit Bid Price	Amount Bid
0044	7980000000-N	SP	GENERIC SIGNAL ITEM DYNAMIC MESSAGE SIGN (TYPE 2C)	1 EA	110,000.00	110,000.00
0045	7980000000-N	SP	GENERIC SIGNAL ITEM MODIFY EXISTING ELECTRICAL SERVICE	1 EA	10,000.00	10,000.00
0046	7980000000-N	SP	GENERIC SIGNAL ITEM REMOVAL AND DISPOSAL OF EXISTING DMS COMPONENTS	1 EA	5,000.00	5,000.00
0047	7980000000-N	SP	GENERIC SIGNAL ITEM REMOVAL AND DISPOSAL OF EXISTING DMS STRUCTURE	1 EA	2,000.00	2,000.00
0048	7980000000-N	SP	GENERIC SIGNAL ITEM REMOVAL AND DISPOSAL OF EXISTING DMS STRUCTURE FOUNDATION	2 EA	7,500.00	15,000.00

Line #	ItemNumber	Sec #	Description	Quantity Unit	Unit Bid Price	Amount Bid
STRUCTURE ITEMS						
0049	8161000000-E	420	GROOVING BRIDGE FLOORS	31,570 SF	0.57	17,994.90
0050	8296000000-N	442	POLLUTION CONTROL	LUMP SUM	1.00	1.00
0051	8559000000-E	SP	CLASS II, SURFACE PREPARATION	54.3 SY	1,000.00	54,300.00
0052	8660000000-E	SP	CONCRETE REPAIRS	20.6 CF	950.00	19,570.00
0053	8664000000-E	SP	SHOTCRETE REPAIRS	49.1 CF	875.00	42,962.50
0054	8678000000-E	SP	EPOXY RESIN INJECTION	47.7 LF	95.00	4,531.50
0055	8860000000-N	SP	GENERIC STRUCTURE ITEM CLEANING & REPAINTING OF BRIDGE #500106	LUMP SUM	300,000.00	300,000.00
0056	8860000000-N	SP	GENERIC STRUCTURE ITEM CLEANING & REPAINTING OF BRIDGE #500107	LUMP SUM	300,000.00	300,000.00
0057	8860000000-N	SP	GENERIC STRUCTURE ITEM PAINTING CONTAINMENT FOR BRIDGE #500106	LUMP SUM	100,000.00	100,000.00
0058	8860000000-N	SP	GENERIC STRUCTURE ITEM PAINTING CONTAINMENT FOR BRIDGE #500107	LUMP SUM	100,000.00	100,000.00
0059	8860000000-N	SP	GENERIC STRUCTURE ITEM VOLUMETRIC MIXER	LUMP SUM	28,382.50	28,382.50
0060	8867000000-E	SP	GENERIC STRUCTURE ITEM POURABLE SILICONE JOINT SEALANT	538.2 LF	100.00	53,820.00
0061	8867000000-E	SP	GENERIC STRUCTURE ITEM STRIP SEALS FOR PRESERVATION	92.8 LF	1,200.00	111,360.00
0062	8889000000-E	SP	GENERIC STRUCTURE ITEM SLOPE PROTECTION VOID FILLING	27,837 LB	7.50	208,777.50
0063	8892000000-E	SP	GENERIC STRUCTURE ITEM CONCRETE WORK FOR JOINT REPLACEMENT	201.2 SF	975.00	196,170.00
0064	8893000000-E	SP	GENERIC STRUCTURE ITEM PLACING & FINISHING POLYMER CONCRETE OVERLAY	3,796 SY	120.00	455,520.00
0065	8893000000-E	SP	GENERIC STRUCTURE ITEM SCARIFYING BRIDGE DECK	3,796 SY	33.00	125,268.00
0066	8893000000-E	SP	GENERIC STRUCTURE ITEM SHOTBLASTING BRIDGE DECK	3,796 SY	18.00	68,328.00
0067	8897000000-N	SP	GENERIC STRUCTURE ITEM TYPE I BRIDGE JACKING BRIDGE #500106	6 EA	8,000.00	48,000.00



Line #	ItemNumber	Sec #	Description	Quantity Unit	Unit Bid Price	Amount Bid
0068	8897000000-N	SP	GENERIC STRUCTURE ITEM TYPE I BRIDGE JACKING BRIDGE #500107	1 EA	12,500.00	12,500.00
***** BEGIN SCHEDULE AA***** ***** ( 2 ALTERNATES ) *****						
0069 AA1	8881000000-E	SP	GENERIC STRUCTURE ITEM POLYESTER POLYMER CONCRETE MATERIALS		211.4 CY	560,210.00
*** OR ***						
0070 AA2	8881000000-E	SP	GENERIC STRUCTURE ITEM EPOXY POLYMER CONCRETE MATERIALS		211.4 CY	
*** END SCHEDULE AA***						
TOTAL AMOUNT OF BID FOR ENTIRE PROJECT						\$7,279,037.99

Contract No. C204650  
County Johnston

Rev. 1-16-18

**EXECUTION OF CONTRACT  
NON-COLLUSION, DEBARMENT AND GIFT BAN CERTIFICATION**

**CORPORATION**

The Contractor declares (or certifies, verifies, or states) under penalty of perjury under the laws of the United States that neither he, nor any official, agent or employee has entered into any agreement, participated in any collusion, or otherwise taken any action which is in restraint of free competitive bidding in connection with this Contract, that the Contractor has not been convicted of violating *N.C.G.S. § 133-24* within the last three years, and that the Contractor intends to do the work with its own bona fide employees or subcontractors and did not bid for the benefit of another contractor.

By submitting this Execution of Contract, Non-Collusion and Debarment Certification, the Contractor is certifying his status under penalty of perjury under the laws of the United States in accordance with the Debarment Certification attached, provided that the Debarment Certification also includes any required statements concerning exceptions that are applicable.

*N.C.G.S. § 133-32* and Executive Order 24 prohibit the offer to, or acceptance by, any State Employee of any gift from anyone with a contract with the State, or from any person seeking to do business with the State. By execution of any response in this procurement, you attest, for your entire organization and its employees or agents, that you are not aware that any such gift has been offered, accepted, or promised by any employees of your organization.

**SIGNATURE OF CONTRACTOR**

S. T. Wooten Corporation

Full name of Corporation

PO Box 2408 Wilson NC 27894-2408

Address as Prequalified

Attest

*Laura Toler*  
Secretary/Assistant Secretary  
Select appropriate title

By

*[Signature]*  
President/Vice President/Assistant Vice President  
Select appropriate title

Laura Toler  
Print or type Signer's name

*Harvie H. Horner, Jr.*  
Print or type Signer's name

CORPORATE SEAL



**DEBARMENT CERTIFICATION**

## Conditions for certification:

1. The prequalified bidder shall provide immediate written notice to the Department if at any time the bidder learns that his certification was erroneous when he submitted his debarment certification or explanation filed with the Department, or has become erroneous because of changed circumstances.
2. The terms *covered transaction, debarred, suspended, ineligible, lower tier covered transaction, participant, person, primary covered transaction, principal, proposal, and voluntarily excluded*, as used in this provision, have the meanings set out in the Definitions and Coverage sections of the rules implementing Executive Order 12549. A copy of the Federal Rules requiring this certification and detailing the definitions and coverages may be obtained from the Contract Officer of the Department.
3. The prequalified bidder agrees by submitting this form, that he will not knowingly enter into any lower tier covered transaction with a person who is debarred, suspended, declared ineligible, or voluntarily excluded from participation in NCDOT contracts, unless authorized by the Department.
4. For Federal Aid projects, the prequalified bidder further agrees that by submitting this form he will include the Federal-Aid Provision titled *Required Contract Provisions Federal-Aid Construction Contract (Form FHWA PR 1273)* provided by the Department, without subsequent modification, in all lower tier covered transactions.
5. The prequalified bidder may rely upon a certification of a participant in a lower tier covered transaction that he is not debarred, suspended, ineligible, or voluntarily excluded from the covered transaction, unless he knows that the certification is erroneous. The bidder may decide the method and frequency by which he will determine the eligibility of his subcontractors.
6. Nothing contained in the foregoing shall be construed to require establishment of a system of records in order to render in good faith the certification required by this provision. The knowledge and information of a participant is not required to exceed that which is normally possessed by a prudent person in the ordinary course of business dealings.
7. Except as authorized in paragraph 6 herein, the Department may terminate any contract if the bidder knowingly enters into a lower tier covered transaction with a person who is suspended, debarred, ineligible, or voluntarily excluded from participation in this transaction, in addition to other remedies available by the Federal Government.

### DEBARMENT CERTIFICATION

The prequalified bidder certifies to the best of his knowledge and belief, that he and his principals:

- a. Are not presently debarred, suspended, proposed for debarment, declared ineligible, or voluntarily excluded from covered transactions by any Federal department or agency;
- b. Have not within a three-year period preceding this proposal been convicted of or had a civil judgment rendered against them for commission of fraud or a criminal offense in connection with obtaining, attempting to obtain, or performing a public (Federal, State or local) transaction or contract under a public transaction; violation of Federal or State antitrust statutes or commission of embezzlement, theft, forgery, bribery, falsification or destruction of records; making false statements; or receiving stolen property;
- c. Are not presently indicted for or otherwise criminally or civilly charged by a governmental entity (Federal, State or local) with commission of any of the offenses enumerated in paragraph b. of this certification; and
- d. Have not within a three-year period preceding this proposal had one or more public transactions (Federal, State or local) terminated for cause or default.
- e. Will submit a revised Debarment Certification immediately if his status changes and will show in his bid proposal an explanation for the change in status.

If the prequalified bidder cannot certify that he is not debarred, he shall provide an explanation with this submittal. An explanation will not necessarily result in denial of participation in a contract.

Failure to submit a non-collusion and debarment certification will result in the prequalified bidder's bid being considered non-responsive.

Check here if an explanation is attached to this certification.

**Contract No.**     **Johnston**

**County (ies):**     **C204650**

ACCEPTED BY THE  
DEPARTMENT OF TRANSPORTATION

DocuSigned by:  
*Ronald E. Davenport, Jr.*  
F81B6038A47A442...  
\_\_\_\_\_  
Contract Officer

10/26/2022  
\_\_\_\_\_  
Date

Execution of Contract and Bonds  
Approved as to Form:

\_\_\_\_\_  
Attorney General

\_\_\_\_\_  
Date

Contract No. C204650  
County Johnston

**CONTRACT PAYMENT BOND**

Date of Payment Bond Execution October 4, 2022

Name of Principal Contractor S. T. Wooten Corporation  
Fidelity and Deposit Company of Maryland  
Attn: Surety Claims  
1299 Zurich Way  
Schaumburg, IL 60196-1056

Name of Surety: \_\_\_\_\_

Name of Contracting Body: **North Carolina Department of Transportation**  
**Raleigh, North Carolina**

Amount of Bond: \$7,279,037.99

Contract ID No.: C204650

County Name: Johnston

\_\_\_\_\_

\_\_\_\_\_

KNOW ALL MEN BY THESE PRESENTS, That we, the PRINCIPAL CONTRACTOR (hereafter, PRINCIPAL) and SURETY above named, are held and firmly bound unto the above named Contracting Body, hereinafter called the Contracting Body, in the penal sum of the amount stated above for the payment of which sum well and truly to be made, we bind ourselves, our heirs, executors, administrators, and successors, jointly and severally, firmly by these presents.

THE CONDITION OF THIS OBLIGATION IS SUCH, that whereas the principal entered into a certain contract with the Contracting Body, numbered as shown above and hereto attached:

NOW THEREFORE, if the principal shall promptly make payment to all persons supplying labor and material in the prosecution of the work provided for in said contract, and any and all duly authorized modifications of said contract that may hereafter be made, notice of which modifications to the surety being hereby waived, then this obligation to be void; otherwise to remain in full force and virtue.

IN WITNESS WHEREOF, the above-bound parties have executed this instrument under their several seals on the date indicated above, the name and corporate seal of each corporate party being hereto affixed and these presents duly signed by its undersigned representative, pursuant to authority of its governing body.

Contract No. C204650  
County Johnston

**CONTRACT PAYMENT BOND**

*Affix Seal of Surety Company*

Fidelity and Deposit Company of Maryland  
Print or type Surety Company Name

By Debra S. Ritter, Attorney-in-Fact  
Print, stamp or type name of Attorney-in-Fact

*Debra S. Ritter*

Signature of Attorney-in-Fact

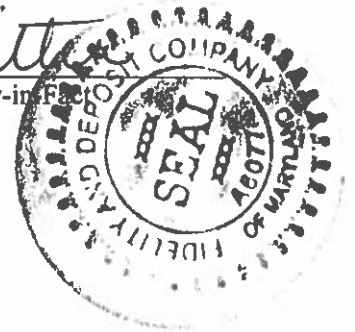

*Erin Ritter*  
Signature of Witness

Erin Ritter  
Print or type Signer's Name

Marsh & McLennan Agency LLC  
5605 Carnegie Blvd., Suite 300  
Charlotte, NC 28209  
Address of Attorney-in-Fact

Contract No. C204650  
County Johnston

**CONTRACT PAYMENT BOND**  
**CORPORATION**  
SIGNATURE OF CONTRACTOR (Principal)

S. T. Wooten Corporation  
Full name of Corporation

Post Office Box 2408; Wilson, North Carolina 27894-2408  
Address as prequalified

By: [Signature]  
Signature of ~~President~~ Vice President, Assistant Vice President  
*Select appropriate title*

Amie HOFFNER  
Print or type Signer's name

*Affix Corporate Seal*

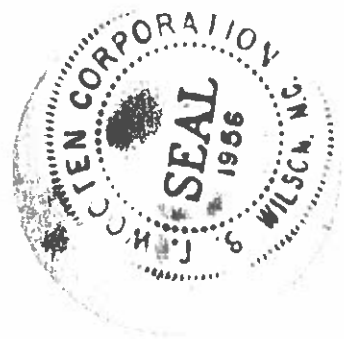

Attest [Signature]  
Signature of ~~Secretary~~, Assistant Secretary  
*Select appropriate title*

Laura Toler  
Print or type Signer's name



Contract No. C204650  
County Johnston

**CONTRACT PERFORMANCE BOND**

Date of Performance Bond Execution: October 4, 2022

Name of Principal Contractor: S. T. Wooten Corporation  
Fidelity and Deposit Company of Maryland  
Attn: Surety Claims  
1299 Zurich Way  
Schaumburg, IL 60196-1056

Name of Surety: \_\_\_\_\_

Name of Contracting Body: North Carolina Department of Transportation  
Raleigh, North Carolina

Amount of Bond: \$7,279,037.99

Contract ID No.: C204650

County Name: Johnston

\_\_\_\_\_

\_\_\_\_\_

KNOW ALL MEN BY THESE PRESENTS, That we, the PRINCIPAL CONTRACTOR (hereafter, PRINCIPAL) and SURETY above named, are held and firmly bound unto the above named Contracting Body, hereinafter called the Contracting Body, in the penal sum of the amount stated above for the payment of which sum well and truly to be made, we bind ourselves, our heirs, executors, administrators, and successors, jointly and severally, firmly by these presents.

THE CONDITION OF THIS OBLIGATION IS SUCH that whereas the principal entered into a certain contract with the Contracting Body, numbered as shown above and hereto attached:

NOW THEREFORE, if the principal shall well and truly perform and fulfill all the undertakings, covenants, terms, conditions, and agreements of said contract during the original term of said contract and any extensions thereof that may be granted by the Contracting Body, with or without notice to the Surety, and during the life of any guaranty required under the contract, and shall also well and truly perform and fulfill all the undertakings, covenants, terms, conditions, and agreements of any and all duly authorized modifications of said contract that may hereafter be made, notice of which modifications to the surety being hereby waived, then this obligation to be void; otherwise to remain in full force and virtue.

IN WITNESS WHEREOF, the above-bound parties have executed this instrument under their several seals on the date indicated above, the name and corporate seal of each corporate party being hereto affixed and these presents duly signed by it undersigned representative, pursuant to authority of its governing body.

Contract No. C204650  
County Johnston

**CONTRACT PERFORMANCE BOND**

*Affix Seal of Surety Company*

Fidelity and Deposit Company of Maryland  
Print or type Surety Company Name

By Debra S. Ritter, Attorney-in-Fact  
Print, stamp or type name of Attorney-in-Fact

Debra S. Ritter  
Signature of Attorney-in-Fact



Erin Ritter  
Signature of witness

Erin Ritter  
Print or type Signer's Name

Marsh & McLennan Agency LLC  
5605 Carnegie Blvd., Suite 300  
Charlotte, NC 28209  
Address of Attorney-in-Fact

Contract No. C204650  
County Johnston

**CONTRACT PERFORMANCE BOND  
CORPORATION**

SIGNATURE OF CONTRACTOR (Principal)

S. T. Wooten Corporation

Full name of Corporation

Post Office Box 2408; Wilson, North Carolina 27894-2408

Address as prequalified

By:



Signature of ~~President~~, Vice President, Assistant Vice President  
Select appropriate title

Amzie H. Hoffman SB

Print or type Signer's name

Affix Corporate Seal

Attest



Signature of ~~Secretary~~, Assistant Secretary  
Select appropriate title

Laura Toler

Print or type Signer's name

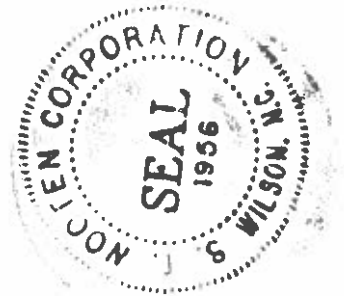

**ZURICH AMERICAN INSURANCE COMPANY  
COLONIAL AMERICAN CASUALTY AND SURETY COMPANY  
FIDELITY AND DEPOSIT COMPANY OF MARYLAND  
POWER OF ATTORNEY**

KNOW ALL MEN BY THESE PRESENTS: That the ZURICH AMERICAN INSURANCE COMPANY, a corporation of the State of New York, the COLONIAL AMERICAN CASUALTY AND SURETY COMPANY, a corporation of the State of Illinois, and the FIDELITY AND DEPOSIT COMPANY OF MARYLAND a corporation of the State of Illinois (herein collectively called the "Companies"), by **Robert D. Murray, Vice President**, in pursuance of authority granted by Article V, Section 8, of the By-Laws of said Companies, which are set forth on the reverse side hereof and are hereby certified to be in full force and effect on the date hereof, do hereby nominate, constitute, and appoint Raymond J. GARRUTO, Wendy E. LAHM, Debra S. RITTER, Martin D. PALLAZZA, Brad W. GIBSON, Angela Y. BUCKNER, Jenny SNELL, H. Thomas DAWKINS, Robert C. TRESHER, Sara G. DEESE of Charlotte, North Carolina, its true and lawful agent and Attorney-in-Fact, to make, execute, seal and deliver, for, and on its behalf as surety, and as its act and deed: **any and all bonds and undertakings**, and the execution of such bonds or undertakings in pursuance of these presents, shall be as binding upon said Companies, as fully and amply, to all intents and purposes, as if they had been duly executed and acknowledged by the regularly elected officers of the ZURICH AMERICAN INSURANCE COMPANY at its office in New York, New York., the regularly elected officers of the COLONIAL AMERICAN CASUALTY AND SURETY COMPANY at its office in Owings Mills, Maryland., and the regularly elected officers of the FIDELITY AND DEPOSIT COMPANY OF MARYLAND at its office in Owings Mills, Maryland., in their own proper persons.

The said Vice President does hereby certify that the extract set forth on the reverse side hereof is a true copy of Article V, Section 8, of the By-Laws of said Companies, and is now in force.

IN WITNESS WHEREOF, the said Vice-President has hereunto subscribed his/her names and affixed the Corporate Seals of the said ZURICH AMERICAN INSURANCE COMPANY, COLONIAL AMERICAN CASUALTY AND SURETY COMPANY, and FIDELITY AND DEPOSIT COMPANY OF MARYLAND, this 12th day of September, A.D. 2022.



**ATTEST:**  
ZURICH AMERICAN INSURANCE COMPANY  
COLONIAL AMERICAN CASUALTY AND SURETY COMPANY  
FIDELITY AND DEPOSIT COMPANY OF MARYLAND

By: *Robert D. Murray*  
Vice President

By: *Dawn E. Brown*  
Secretary

**State of Maryland  
County of Baltimore**

On this 12th day of September, A.D. 2022, before the subscriber, a Notary Public of the State of Maryland, duly commissioned and qualified, **Robert D. Murray, Vice President and Dawn E. Brown, Secretary** of the Companies, to me personally known to be the individuals and officers described in and who executed the preceding instrument, and acknowledged the execution of same, and being by me duly sworn, deposeth and saith, that he/she is the said officer of the Company aforesaid, and that the seals affixed to the preceding instrument are the Corporate Seals of said Companies, and that the said Corporate Seals and the signature as such officer were duly affixed and subscribed to the said instrument by the authority and direction of the said Corporations.

IN TESTIMONY WHEREOF, I have hereunto set my hand and affixed my Official Seal the day and year first above written.



Constance A. Dunn, Notary Public  
My Commission Expires: July 9, 2023

**EXTRACT FROM BY-LAWS OF THE COMPANIES**

"Article V, Section 8, Attorneys-in-Fact. The Chief Executive Officer, the President, or any Executive Vice President or Vice President may, by written instrument under the attested corporate seal, appoint attorneys-in-fact with authority to execute bonds, policies, recognizances, stipulations, undertakings, or other like instruments on behalf of the Company, and may authorize any officer or any such attorney-in-fact to affix the corporate seal thereto; and may with or without cause modify or revoke any such appointment or authority at any time."

**CERTIFICATE**

I, the undersigned, Vice President of the ZURICH AMERICAN INSURANCE COMPANY, the COLONIAL AMERICAN CASUALTY AND SURETY COMPANY, and the FIDELITY AND DEPOSIT COMPANY OF MARYLAND, do hereby certify that the foregoing Power of Attorney is still in full force and effect on the date of this certificate; and I do further certify that Article V, Section 8, of the By-Laws of the Companies is still in force.

This Power of Attorney and Certificate may be signed by facsimile under and by authority of the following resolution of the Board of Directors of the ZURICH AMERICAN INSURANCE COMPANY at a meeting duly called and held on the 15th day of December 1998.

RESOLVED: "That the signature of the President or a Vice President and the attesting signature of a Secretary or an Assistant Secretary and the Seal of the Company may be affixed by facsimile on any Power of Attorney...Any such Power or any certificate thereof bearing such facsimile signature and seal shall be valid and binding on the Company."

This Power of Attorney and Certificate may be signed by facsimile under and by authority of the following resolution of the Board of Directors of the COLONIAL AMERICAN CASUALTY AND SURETY COMPANY at a meeting duly called and held on the 5th day of May, 1994, and the following resolution of the Board of Directors of the FIDELITY AND DEPOSIT COMPANY OF MARYLAND at a meeting duly called and held on the 10th day of May, 1990.

RESOLVED: "That the facsimile or mechanically reproduced seal of the company and facsimile or mechanically reproduced signature of any Vice-President, Secretary, or Assistant Secretary of the Company, whether made heretofore or hereafter, wherever appearing upon a certified copy of any power of attorney issued by the Company, shall be valid and binding upon the Company with the same force and effect as though manually affixed.

IN TESTIMONY WHEREOF, I have hereunto subscribed my name and affixed the corporate seals of the said Companies, this 4th day of October, 2022.

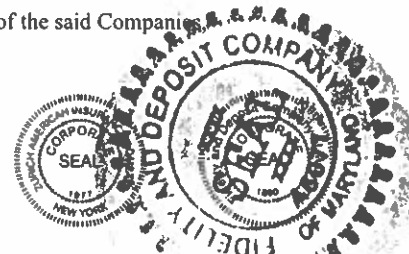

*MJ Pethick*  
By: Mary Jean Pethick  
Vice President

**TO REPORT A CLAIM WITH REGARD TO A SURETY BOND, PLEASE SUBMIT A COMPLETE DESCRIPTION OF THE CLAIM INCLUDING THE PRINCIPAL ON THE BOND, THE BOND NUMBER, AND YOUR CONTACT INFORMATION TO:**

Zurich Surety Claims  
1299 Zurich Way  
Schaumburg, IL 60196-1056  
Ph: 800-626-4577

If your jurisdiction allows for electronic reporting of surety claims, please submit to: [reportsfclaims@zurichna.com](mailto:reportsfclaims@zurichna.com)

Authenticity of this bond can be confirmed at [bondvalidator.zurichna.com](http://bondvalidator.zurichna.com) or 410-559-8790