



STATE OF NORTH CAROLINA
DEPARTMENT OF TRANSPORTATION

Beverly E. Purdue
GOVERNOR

Gene Conti
SECRETARY

January 23, 2010

Memo To: John Abel, Bridge Manager

From: Clay Willis, Division Environmental Officer

Subject: NW 3 authorization for Bridge #72 replacement over unnamed tributary to Frog Level Swamp on SR 1110 (Quitsna Rd) in Bertie County.

Provided with this memo is the NW 3 permit from the US Army Corps of Engineers and corresponding Division of Water Quality 401 certification authorizing jurisdictional impacts associated with the replacement of Bridge # 72 in Bertie County. There are permit drawings for the construction of the bridge that depict the limits of construction and authorized impacts. These drawings must be adhered to in order to stay in compliance with the issued permits. Any changes to the bridge design that may change the impacts may require a permit modification. **Before construction begins on this project a preconstruction meeting needs to be scheduled. A copy of this no authorization required needs to be on the project site during construction of this project.**

Sincerely,
Jerry Jennings, P.E.
Division One Engineer

Clay Willis
Division One Environmental Officer

Bertie County Bridge #72 SR 1110 Quitsna Rd

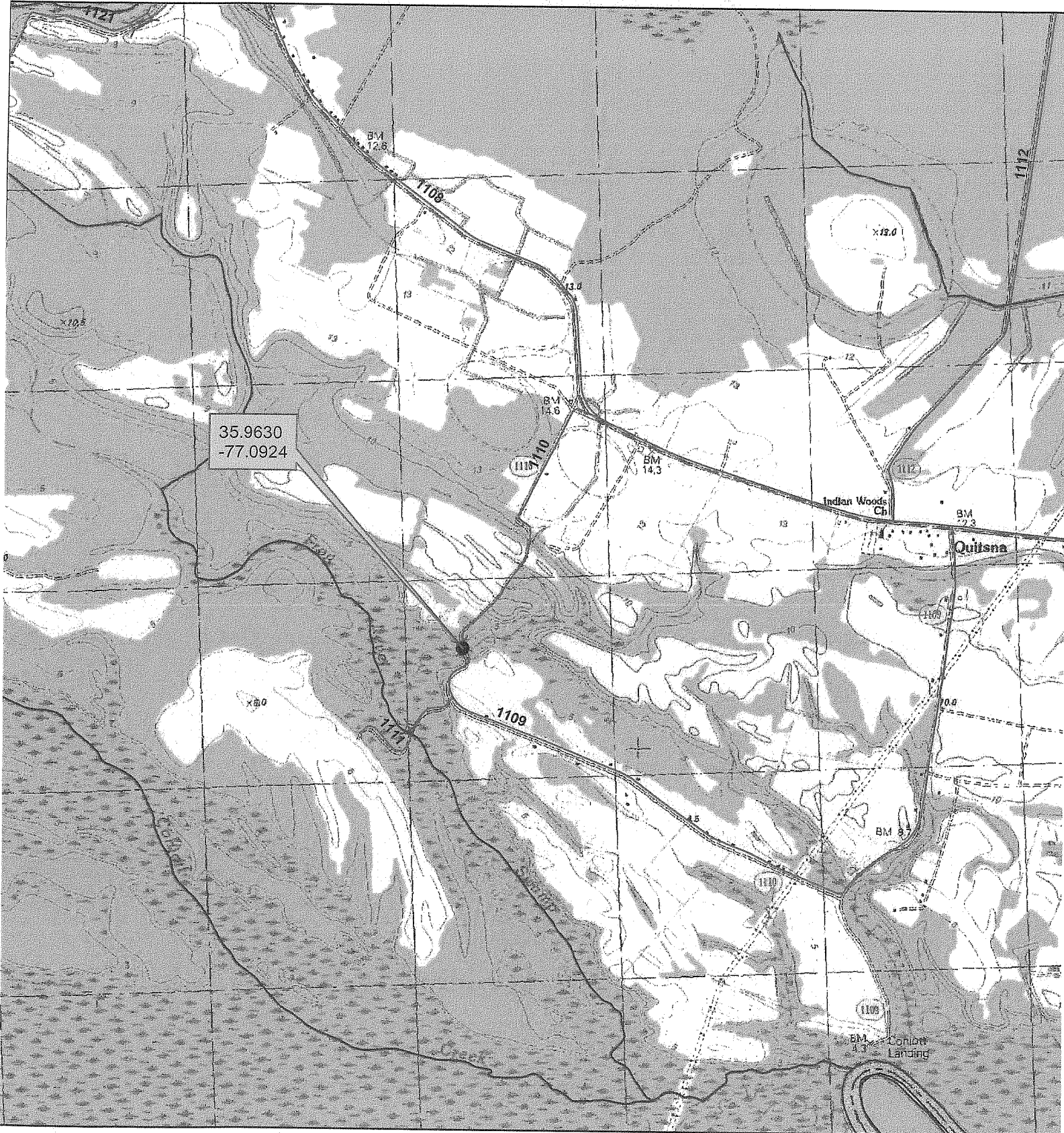

USGS Quad - Quitsna
Roanoke River Basin

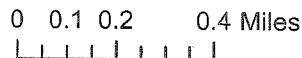

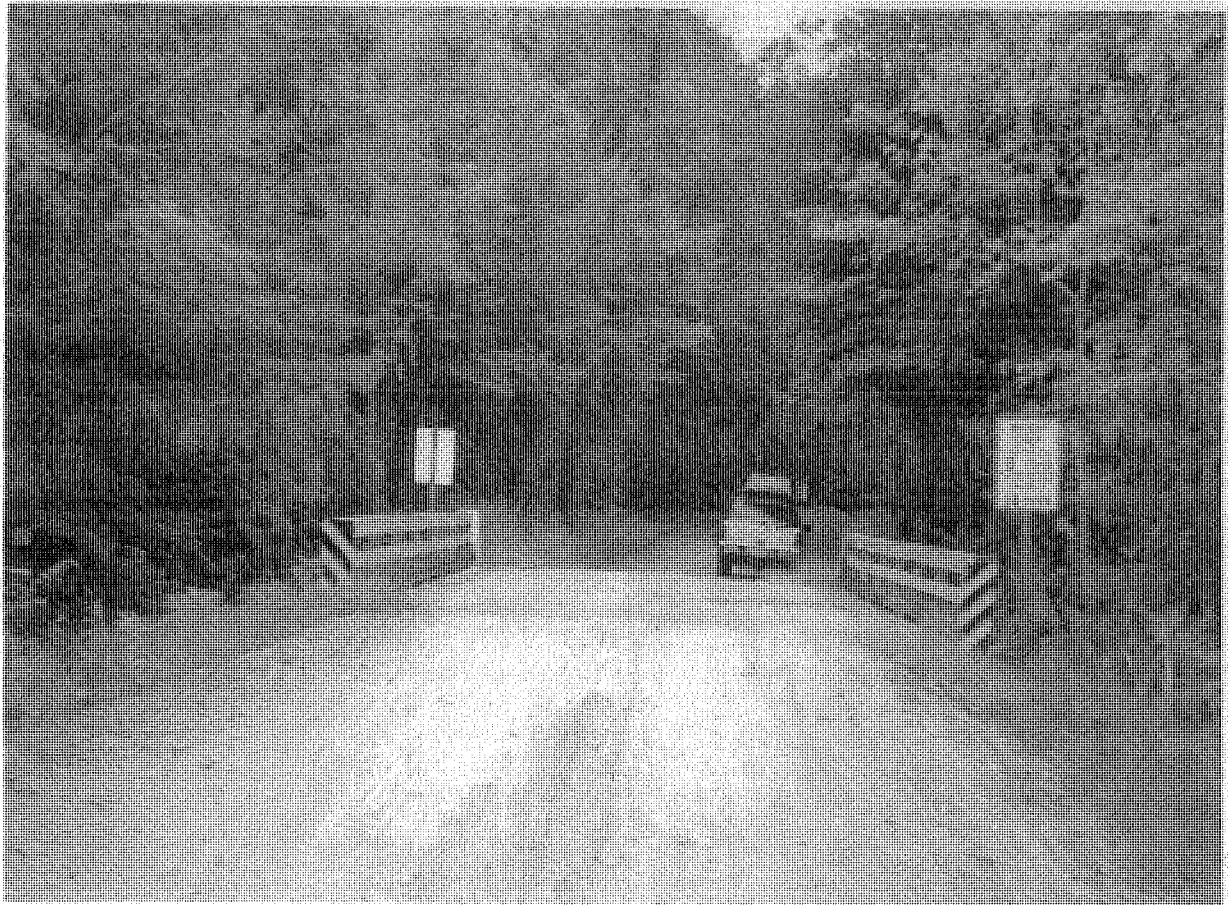

Bridge # 72 Bertie County

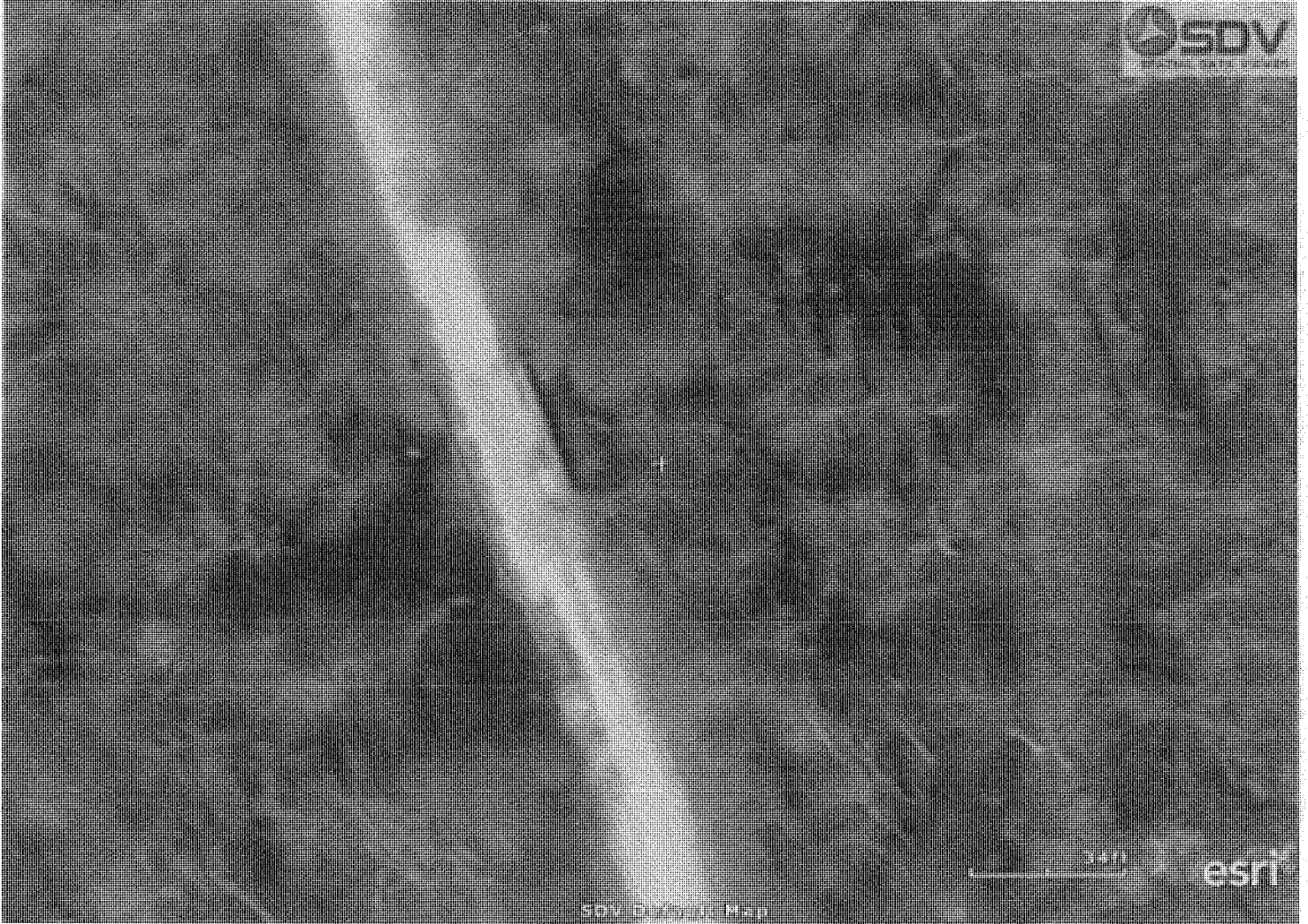

Low/Minimal Impact Bridge Project Data Sheet

	TIP NO	BD-51011
	WBS	45347.1.BD1
	County	Bertie County
	Bridge Number	Bridge # 72
	Description	Replacement of Bridge # 72 on SR-1110 (Quitsna Road) over Branch of frog Level Swamp
Stream	Basin	Roanoke Basin 8 digit huocode 03010107
	Classification	Class "C"
	SIN	DWQ Index # 28-48-1 Branch of Frog Level Swamp
	Type	Warm / Inland
	Size	channel at the bridge site was not visible due to impounded water as a result of beaver activity
Existing Structure	Type	Timber deck on steel girder I beams
	Size	Bridge is 1 span @ 41' - 4" Timber floor on steel girder I-Beams with timber abutments and wooden rails.
	Suff. Rating	Suff. Rating 44.9 Posted 11 tons for SU's/ 14 tons for TTST's
Proposed Structure	Type	Cored Slab Bridge
	Size	Preliminary; 1 @ 55' Cored Slab, 90 degree skew, 24 ft clear roadway
Stream	USACE Impacts (LF)	COE Jurisdictional Stream Present, do to bridging there should be no stream impacts
	Non 404 Impacts (LF)	not applicable
Wetlands	USACE Impacts (AC)	wetland impacts will be within the threshold for NW3 Permits from the COE
	Non 404 Impacts (AC)	not applicable
	CAMA Impacts (AC)	No Cama jurisdiction / None
NC DWQ Buffers	Impacts (SF)	None
Buffer Application Required (>40 ft) (Y/N)		No
NC DWQ StormWater Permit Required (Y/N)	Permit Required (Y/N)	No
T&E	Habitat (y/n)	No habitat present for Bald Eagle (BGPA)/Shortnose Surgeon(E)/Red-cockaded woodpecker(E)
	Species Present	No Habitat Present
	Bio Conclusion	No effect
Moratorium	Type	No Moratorium (WRC)
	Dates	No Moratorium (WRC)
Trout Waters	Native/Hatchery	not applicable
	Trout Species Present	not applicable
	Trout Conditions (Y/N)	not applicable
	WRC Reviewer	not applicable
CAMA	AECs	None
Essential Fish	Habitat (y/n)	No
Nav.	Opening	2 feet vertical clearance fro LSEL to WSEL and 42 feet horizontal
USCG	Permit	None
Historic	Properties	No further survey required
Archaeological	Resources	No further survey required
Tribal	Lands	None
4(f)	Resources	None
6(f) [LWCF]	Resources	None
Wild and	Scenic River	None
Forest Service	Lands	None
TVA	Area	None
FEMA	Buyout	None
FEMA	Flood Study	Not in a study, Is in floodplain of Roanoke River but not in non-encroachment zone
USTs	Haz Mats	None
	Relocates	None
Location	LAT	35.983
	LONG	-77.0972
Project Comments		
Completed by:		
Lead Engineer		
Division Environmental Officer	8/10/11 8/10/11	

Willis, Thomas C

From: Biddlecome, William J SAW <William.J.Biddlecome@usace.army.mil>
Sent: Tuesday, January 24, 2012 3:07 PM
To: Willis, Thomas C
Subject: NW # 3 Authorizations - Low Impact Bridge Replacement Program (UNCLASSIFIED)
Attachments: NWP3_6-07[1].pdf

Classification: UNCLASSIFIED
Caveats: NONE

Clay,

This e-mail acts as your authorization to proceed under the attached Nationwide # 3 permit for the following projects:

Bridge # 72 on NCSR 1110 (Quitsna Road) over UT to Frog Level Swamp in Bertie County □ Action ID # SAW-2012-00141 for the following impacts: 0.038 acres of permanent fill and 0.045 acres of temporary hand clearing impacts.

Bridge # 87 on NCSR 1354 (Nixon Road) over East Most Swamp in Bertie County □ Action ID # SAW-2012-00144 for the following impacts: 0.029 acres of permanent fill, 0.032 acres of temporary hand clearing impacts and 20 square feet of permanent open water impacts.

Bridge # 1 on NCSR 1100 (Drummonds Point Road) over Middleton Creek in Chowan County □ Action ID # SAW-2012-00150 for the following impacts : 0 permanent fill wetland impacts, 0.006 acres of temporary hand clearing impacts and 5 square feet of permanent open water impacts. There is also an in-water work moratorium for anadromous fish of February 15 □ June 15th for this project

If you have any questions about any of these please contact me. Thanks!

Bill Biddlecome
Regulatory Project Manager
Washington Regulatory Field Office
P.O. Box 1000
Washington, North Carolina 27889
(910) 251-4558
william.j.biddlecome@usace.army.mil

We at the U.S. Army Corps of Engineers Regulatory Branch are committed to improving service to our customers. We would appreciate your feedback on how we are performing our duties. Our automated Customer Service Survey is located at:

**NATIONWIDE PERMIT 3
DEPARTMENT OF THE ARMY
CORPS OF ENGINEERS
FINAL NOTICE OF ISSUANCE AND MODIFICATION OF NATIONWIDE PERMITS
FEDERAL REGISTER
AUTHORIZED MARCH 19, 2007**

Maintenance. (a) The repair, rehabilitation, or replacement of any previously authorized, currently serviceable, structure, or fill, or of any currently serviceable structure or fill authorized by 33 CFR 330.3, provided that the structure or fill is not to be put to uses differing from those uses specified or contemplated for it in the original permit or the most recently authorized modification. Minor deviations in the structure's configuration or filled area, including those due to changes in materials, construction techniques, or current construction codes or safety standards that are necessary to make the repair, rehabilitation, or replacement are authorized. This NWP authorizes the repair, rehabilitation, or replacement of those structures or fills destroyed or damaged by storms, floods, fire or other discrete events, provided the repair, rehabilitation, or replacement is commenced, or is under contract to commence, within two years of the date of their destruction or damage. In cases of catastrophic events, such as hurricanes or tornadoes, this two-year limit may be waived by the district engineer, provided the permittee can demonstrate funding, contract, or other similar delays.

(b) This NWP also authorizes the removal of accumulated sediments and debris in the vicinity of and within existing structures (e.g., bridges, culverted road crossings, water intake structures, etc.) and the placement of new or additional riprap to protect the structure. The removal of sediment is limited to the minimum necessary to restore the waterway in the immediate vicinity of the structure to the approximate dimensions that existed when the structure was built, but cannot extend further than 200 feet in any direction from the structure. This 200 foot limit does not apply to maintenance dredging to remove accumulated sediments blocking or restricting outfall and intake structures or to maintenance dredging to remove accumulated sediments from canals associated with outfall and intake structures. All dredged or excavated materials must be deposited and retained in an upland area unless otherwise specifically approved by the district engineer under separate authorization. The placement of riprap must be the minimum necessary to protect the structure or to ensure the safety of the structure. Any bank stabilization measures not directly associated with the structure will require a separate authorization from the district engineer.

(c) This NWP also authorizes temporary structures, fills, and work necessary to conduct the maintenance activity. Appropriate measures must be taken to maintain normal downstream flows and minimize flooding to the maximum extent practicable, when temporary structures, work, and discharges, including cofferdams, are necessary for construction activities, access fills, or dewatering of construction sites. Temporary fills must consist of materials, and be placed in a manner, that will not be eroded by expected high flows. Temporary fills must be removed in their entirety and the affected areas returned to pre-construction elevations. The areas affected by temporary fills must be revegetated, as appropriate.

(d) This NWP does not authorize maintenance dredging for the primary purpose of navigation or beach restoration. This NWP does not authorize new stream channelization or stream relocation projects.

Notification: For activities authorized by paragraph (b) of this NWP, the permittee must submit a pre-construction notification to the district engineer prior to commencing the activity (see general condition 27). Where maintenance dredging is proposed, the pre-construction notification must include information regarding the original design capacities and configurations of the outfalls, intakes, small impoundments, and canals. (Sections 10 and 404)

Note: This NWP authorizes the repair, rehabilitation, or replacement of any previously authorized structure or fill that does not qualify for the Clean Water Act Section 404(f) exemption for maintenance.

NATIONWIDE PERMIT CONDITIONS

The following General Conditions must be followed in order for any authorization by a NWP to be valid:

1. Navigation. (a) No activity may cause more than a minimal adverse effect on navigation.

(b) Any safety lights and signals prescribed by the U.S. Coast Guard, through regulations or otherwise, must be installed and maintained at the permittee's expense on authorized facilities in navigable waters of the United States.

(c) The permittee understands and agrees that, if future operations by the United States require the removal, relocation, or other alteration, of the structure or work herein authorized, or if, in the opinion of the Secretary of the Army or his authorized representative, said structure or work shall cause unreasonable obstruction to the free navigation of the navigable waters, the permittee will be required, upon due notice from the Corps of Engineers, to remove, relocate, or alter the structural work or obstructions caused thereby, without expense to the United States. No claim shall be made against the United States on account of any such removal or alteration.

2. Aquatic Life Movements. No activity may substantially disrupt the necessary life cycle movements of those species of aquatic life indigenous to the waterbody, including those species that normally migrate through the area, unless the activity's primary purpose is to impound water. Culverts placed in streams must be installed to maintain low flow conditions.

3. Spawning Areas. Activities in spawning areas during spawning seasons must be avoided to the maximum extent practicable. Activities that result in the physical destruction (e.g., through excavation, fill, or downstream smothering by substantial turbidity) of an important spawning area are not authorized.

4. Migratory Bird Breeding Areas. Activities in waters of the United States that serve as breeding areas for migratory birds must be avoided to the maximum extent practicable.

5. Shellfish Beds. No activity may occur in areas of concentrated shellfish populations, unless the activity is directly related to a shellfish harvesting activity authorized by NWPs 4 and 48.

6. Suitable Material. No activity may use unsuitable material (e.g., trash, debris, car bodies, asphalt, etc.). Material used for construction or discharged must be free from toxic pollutants in toxic amounts (see Section 307 of the Clean Water Act).

7. Water Supply Intakes. No activity may occur in the proximity of a public water supply intake, except where the activity is for the repair or improvement of public water supply intake structures or adjacent bank stabilization.

8. Adverse Effects From Impoundments. If the activity creates an impoundment of water, adverse effects to the aquatic system due to accelerating the passage of water, and/or restricting its flow must be minimized to the maximum extent practicable.

9. Management of Water Flows. To the maximum extent practicable, the pre-construction course, condition, capacity, and location of open waters must be maintained for each activity, including stream channelization and storm water management activities, except as provided below. The activity must be constructed to withstand expected high flows. The activity must not restrict or impede the passage of normal or high flows, unless the primary purpose of the activity is to impound water or manage high flows. The activity may alter the pre-construction course, condition, capacity, and location of open waters if it benefits the aquatic environment (e.g., stream restoration or relocation activities).

10. Fills Within 100-Year Floodplains. The activity must comply with applicable FEMA-approved state or local floodplain management requirements.

11. Equipment. Heavy equipment working in wetlands or mudflats must be placed on mats, or other measures must be taken to minimize soil disturbance.

12. Soil Erosion and Sediment Controls. Appropriate soil erosion and sediment controls must be used and maintained in effective operating condition during construction, and all exposed soil and other fills, as well as any work below the ordinary high water mark or high tide line, must be permanently stabilized at the earliest practicable date. Permittees are encouraged to perform work within waters of the United States during periods of low-flow or no-flow.

13. Removal of Temporary Fills. Temporary fills must be removed in their entirety and the affected areas returned to pre-construction elevations. The affected areas must be revegetated, as appropriate.

14. Proper Maintenance. Any authorized structure or fill shall be properly maintained, including maintenance to ensure public safety.

15. Wild and Scenic Rivers. No activity may occur in a component of the National Wild and Scenic River System, or in a river officially designated by Congress as a "study river" for possible inclusion in the system while the river is in an official study status, unless the appropriate Federal agency with direct management responsibility for such river, has determined in writing that the proposed activity will not adversely affect the Wild and Scenic River designation or study status. Information on Wild and Scenic Rivers may be obtained from the appropriate Federal land management agency in the area (e.g., National Park Service, U.S. Forest Service, Bureau of Land Management, U.S. Fish and Wildlife Service).

16. Tribal Rights. No activity or its operation may impair reserved tribal rights, including, but not limited to, reserved water rights and treaty fishing and hunting rights.

17. Endangered Species. (a) No activity is authorized under any NWP which is likely to jeopardize the continued existence of a threatened or endangered species or a species proposed for such designation, as identified under the Federal Endangered Species Act (ESA), or which will destroy or adversely modify the critical habitat of such species. No activity is authorized

under any NWP which “may affect” a listed species or critical habitat, unless Section 7 consultation addressing the effects of the proposed activity has been completed.

(b) Federal agencies should follow their own procedures for complying with the requirements of the ESA. Federal permittees must provide the district engineer with the appropriate documentation to demonstrate compliance with those requirements.

(c) Non-federal permittees shall notify the district engineer if any listed species or designated critical habitat might be affected or is in the vicinity of the project, or if the project is located in designated critical habitat, and shall not begin work on the activity until notified by the district engineer that the requirements of the ESA have been satisfied and that the activity is authorized. For activities that might affect Federally-listed endangered or threatened species or designated critical habitat, the pre-construction notification must include the name(s) of the endangered or threatened species that may be affected by the proposed work or that utilize the designated critical habitat that may be affected by the proposed work. The district engineer will determine whether the proposed activity “may affect” or will have “no effect” to listed species and designated critical habitat and will notify the non-Federal applicant of the Corps’ determination within 45 days of receipt of a complete pre-construction notification. In cases where the non-Federal applicant has identified listed species or critical habitat that might be affected or is in the vicinity of the project, and has so notified the Corps, the applicant shall not begin work until the Corps has provided notification the proposed activities will have “no effect” on listed species or critical habitat, or until Section 7 consultation has been completed.

(d) As a result of formal or informal consultation with the FWS or NMFS the district engineer may add species-specific regional endangered species conditions to the NWPs.

(e) Authorization of an activity by a NWP does not authorize the “take” of a threatened or endangered species as defined under the ESA. In the absence of separate authorization (e.g., an ESA Section 10 Permit, a Biological Opinion with “incidental take” provisions, etc.) from the U.S. FWS or the NMFS, both lethal and non-lethal “takes” of protected species are in violation of the ESA. Information on the location of threatened and endangered species and their critical habitat can be obtained directly from the offices of the U.S. FWS and NMFS or their world wide Web pages at <http://www.fws.gov/> and <http://www.noaa.gov/fisheries.html> respectively.

18. Historic Properties. (a) In cases where the district engineer determines that the activity may affect properties listed, or eligible for listing, in the National Register of Historic Places, the activity is not authorized, until the requirements of Section 106 of the National Historic Preservation Act (NHPA) have been satisfied.

(b) Federal permittees should follow their own procedures for complying with the requirements of Section 106 of the National Historic Preservation Act. Federal permittees must provide the district engineer with the appropriate documentation to demonstrate compliance with those requirements.

(c) Non-federal permittees must submit a pre-construction notification to the district engineer if the authorized activity may have the potential to cause effects to any historic properties listed, determined to be eligible for listing on, or potentially eligible for listing on the National Register of Historic Places, including previously unidentified properties. For such activities, the pre-construction notification must state which historic properties may be affected by the proposed work or include a vicinity map indicating the location of the historic properties or the potential for the presence of historic properties. Assistance regarding information on the location of or potential for the presence of historic resources can be sought from the State

Historic Preservation Officer or Tribal Historic Preservation Officer, as appropriate, and the National Register of Historic Places (see 33 CFR 330.4(g)). The district engineer shall make a reasonable and good faith effort to carry out appropriate identification efforts, which may include background research, consultation, oral history interviews, sample field investigation, and field survey. Based on the information submitted and these efforts, the district engineer shall determine whether the proposed activity has the potential to cause an effect on the historic properties. Where the non-Federal applicant has identified historic properties which the activity may have the potential to cause effects and so notified the Corps, the non-Federal applicant shall not begin the activity until notified by the district engineer either that the activity has no potential to cause effects or that consultation under Section 106 of the NHPA has been completed.

(d) The district engineer will notify the prospective permittee within 45 days of receipt of a complete pre-construction notification whether NHPA Section 106 consultation is required. Section 106 consultation is not required when the Corps determines that the activity does not have the potential to cause effects on historic properties (see 36 CFR 800.3(a)). If NHPA section 106 consultation is required and will occur, the district engineer will notify the non-Federal applicant that he or she cannot begin work until Section 106 consultation is completed.

(e) Prospective permittees should be aware that section 110k of the NHPA (16 U.S.C. 470h-2(k)) prevents the Corps from granting a permit or other assistance to an applicant who, with intent to avoid the requirements of Section 106 of the NHPA, has intentionally significantly adversely affected a historic property to which the permit would relate, or having legal power to prevent it, allowed such significant adverse effect to occur, unless the Corps, after consultation with the Advisory Council on Historic Preservation (ACHP), determines that circumstances justify granting such assistance despite the adverse effect created or permitted by the applicant. If circumstances justify granting the assistance, the Corps is required to notify the ACHP and provide documentation specifying the circumstances, explaining the degree of damage to the integrity of any historic properties affected, and proposed mitigation. This documentation must include any views obtained from the applicant, SHPO/THPO, appropriate Indian tribes if the undertaking occurs on or affects historic properties on tribal lands or affects properties of interest to those tribes, and other parties known to have a legitimate interest in the impacts to the permitted activity on historic properties.

19. Designated Critical Resource Waters. Critical resource waters include, NOAA-designated marine sanctuaries, National Estuarine Research Reserves, state natural heritage sites, and outstanding national resource waters or other waters officially designated by a state as having particular environmental or ecological significance and identified by the district engineer after notice and opportunity for public comment. The district engineer may also designate additional critical resource waters after notice and opportunity for comment.

(a) Discharges of dredged or fill material into waters of the United States are not authorized by NWPs 7, 12, 14, 16, 17, 21, 29, 31, 35, 39, 40, 42, 43, 44, 49, and 50 for any activity within, or directly affecting, critical resource waters, including wetlands adjacent to such waters.

(b) For NWPs 3, 8, 10, 13, 15, 18, 19, 22, 23, 25, 27, 28, 30, 33, 34, 36, 37, and 38, notification is required in accordance with general condition 27, for any activity proposed in the designated critical resource waters including wetlands adjacent to those waters. The district engineer may authorize activities under these NWPs only after it is determined that the impacts to the critical resource waters will be no more than minimal.

20. Mitigation. The district engineer will consider the following factors when determining appropriate and practicable mitigation necessary to ensure that adverse effects on the aquatic environment are minimal:

(a) The activity must be designed and constructed to avoid and minimize adverse effects, both temporary and permanent, to waters of the United States to the maximum extent practicable at the project site (i.e., on site).

(b) Mitigation in all its forms (avoiding, minimizing, rectifying, reducing, or compensating) will be required to the extent necessary to ensure that the adverse effects to the aquatic environment are minimal.

(c) Compensatory mitigation at a minimum one-for-one ratio will be required for all wetland losses that exceed 1/10 acre and require pre-construction notification, unless the district engineer determines in writing that some other form of mitigation would be more environmentally appropriate and provides a project-specific waiver of this requirement. For wetland losses of 1/10 acre or less that require pre-construction notification, the district engineer may determine on a case-by-case basis that compensatory mitigation is required to ensure that the activity results in minimal adverse effects on the aquatic environment. Since the likelihood of success is greater and the impacts to potentially valuable uplands are reduced, wetland restoration should be the first compensatory mitigation option considered.

(d) For losses of streams or other open waters that require pre-construction notification, the district engineer may require compensatory mitigation, such as stream restoration, to ensure that the activity results in minimal adverse effects on the aquatic environment.

(e) Compensatory mitigation will not be used to increase the acreage losses allowed by the acreage limits of the NWP. For example, if an NWP has an acreage limit of 1/2 acre, it cannot be used to authorize any project resulting in the loss of greater than 1/2 acre of waters of the United States, even if compensatory mitigation is provided that replaces or restores some of the lost waters. However, compensatory mitigation can and should be used, as necessary, to ensure that a project already meeting the established acreage limits also satisfies the minimal impact requirement associated with the NWP.

(f) Compensatory mitigation plans for projects in or near streams or other open waters will normally include a requirement for the establishment, maintenance, and legal protection (e.g., conservation easements) of riparian areas next to open waters. In some cases, riparian areas may be the only compensatory mitigation required. Riparian areas should consist of native species. The width of the required riparian area will address documented water quality or aquatic habitat loss concerns. Normally, the riparian area will be 25 to 50 feet wide on each side of the stream, but the district engineer may require slightly wider riparian areas to address documented water quality or habitat loss concerns. Where both wetlands and open waters exist on the project site, the district engineer will determine the appropriate compensatory mitigation (e.g., riparian areas and/or wetlands compensation) based on what is best for the aquatic environment on a watershed basis. In cases where riparian areas are determined to be the most appropriate form of compensatory mitigation, the district engineer may waive or reduce the requirement to provide wetland compensatory mitigation for wetland losses.

(g) Permittees may propose the use of mitigation banks, in-lieu fee arrangements or separate activity-specific compensatory mitigation. In all cases, the mitigation provisions will specify the party responsible for accomplishing and/or complying with the mitigation plan.

(h) Where certain functions and services of waters of the United States are permanently adversely affected, such as the conversion of a forested or scrub-shrub wetland to a herbaceous wetland in a permanently maintained utility line right-of-way, mitigation may be required to reduce the adverse effects of the project to the minimal level.

21. Water Quality. Where States and authorized Tribes, or EPA where applicable, have not previously certified compliance of an NWP with CWA Section 401, individual 401 Water Quality Certification must be obtained or waived (see 33 CFR 330.4(c)). The district engineer or State or Tribe may require additional water quality management measures to ensure that the authorized activity does not result in more than minimal degradation of water quality.

22. Coastal Zone Management. In coastal states where an NWP has not previously received a state coastal zone management consistency concurrence, an individual state coastal zone management consistency concurrence must be obtained, or a presumption of concurrence must occur (see 33 CFR 330.4(d)). The district engineer or a State may require additional measures to ensure that the authorized activity is consistent with state coastal zone management requirements.

23. Regional and Case-By-Case Conditions. The activity must comply with any regional conditions that may have been added by the Division Engineer (see 33 CFR 330.4(e)) and with any case specific conditions added by the Corps or by the state, Indian Tribe, or U.S. EPA in its section 401 Water Quality Certification, or by the state in its Coastal Zone Management Act consistency determination.

24. Use of Multiple Nationwide Permits. The use of more than one NWP for a single and complete project is prohibited, except when the acreage loss of waters of the United States authorized by the NWPs does not exceed the acreage limit of the NWP with the highest specified acreage limit. For example, if a road crossing over tidal waters is constructed under NWP 14, with associated bank stabilization authorized by NWP 13, the maximum acreage loss of waters of the United States for the total project cannot exceed 1/3-acre.

25. Transfer of Nationwide Permit Verifications. If the permittee sells the property associated with a nationwide permit verification, the permittee may transfer the nationwide permit verification to the new owner by submitting a letter to the appropriate Corps district office to validate the transfer. A copy of the nationwide permit verification must be attached to the letter, and the letter must contain the following statement and signature:
“When the structures or work authorized by this nationwide permit are still in existence at the time the property is transferred, the terms and conditions of this nationwide permit, including any special conditions, will continue to be binding on the new owner(s) of the property. To validate

the transfer of this nationwide permit and the associated liabilities associated with compliance with its terms and conditions, have the transferee sign and date below.”

(Transferee)

(Date)

26. Compliance Certification. Each permittee who received an NWP verification from the Corps must submit a signed certification regarding the completed work and any required mitigation. The certification form must be forwarded by the Corps with the NWP verification letter and will include:

- (a) A statement that the authorized work was done in accordance with the NWP authorization, including any general or specific conditions;
- (b) A statement that any required mitigation was completed in accordance with the permit conditions; and
- (c) The signature of the permittee certifying the completion of the work and mitigation.

27. Pre-Construction Notification. (a) Timing. Where required by the terms of the NWP, the prospective permittee must notify the district engineer by submitting a pre-construction notification (PCN) as early as possible. The district engineer must determine if the PCN is complete within 30 calendar days of the date of receipt and, as a general rule, will request additional information necessary to make the PCN complete only once. However, if the prospective permittee does not provide all of the requested information, then the district engineer will notify the prospective permittee that the PCN is still incomplete and the PCN review process will not commence until all of the requested information has been received by the district engineer. The prospective permittee shall not begin the activity until either:

- (1) He or she is notified in writing by the district engineer that the activity may proceed under the NWP with any special conditions imposed by the district or division engineer; or
- (2) Forty-five calendar days have passed from the district engineer's receipt of the complete PCN and the prospective permittee has not received written notice from the district or division engineer. However, if the permittee was required to notify the Corps pursuant to general condition 17 that listed species or critical habitat might be affected or in the vicinity of the project, or to notify the Corps pursuant to general condition 18 that the activity may have the potential to cause effects to historic properties, the permittee cannot begin the activity until receiving written notification from the Corps that is “no effect” on listed species or “no potential to cause effects” on historic properties, or that any consultation required under Section 7 of the Endangered Species Act (see 33 CFR 330.4(f)) and/or Section 106 of the National Historic Preservation Act (see 33 CFR 330.4(g)) is completed. Also, work cannot begin under NWPs 21, 49, or 50 until the permittee has received written approval from the Corps. If the proposed activity requires a written waiver to exceed specified limits of an NWP, the permittee cannot begin the activity until the district engineer issues the waiver. If the district or division engineer notifies the permittee in writing that an individual permit is required within 45 calendar days of receipt of a complete PCN, the permittee cannot begin the activity until an individual permit has been obtained.

Subsequently, the permittee's right to proceed under the NWP may be modified, suspended, or revoked only in accordance with the procedure set forth in 33 CFR 330.5(d)(2).

(b) Contents of Pre-Construction Notification: The PCN must be in writing and include the following information:

(1) Name, address and telephone numbers of the prospective permittee;

(2) Location of the proposed project;

(3) A description of the proposed project; the project's purpose; direct and indirect adverse environmental effects the project would cause; any other NWP(s), regional general permit(s), or individual permit(s) used or intended to be used to authorize any part of the proposed project or any related activity. The description should be sufficiently detailed to allow the district engineer to determine that the adverse effects of the project will be minimal and to determine the need for compensatory mitigation. Sketches should be provided when necessary to show that the activity complies with the terms of the NWP. (Sketches usually clarify the project and when provided result in a quicker decision.);

(4) The PCN must include a delineation of special aquatic sites and other waters of the United States on the project site. Wetland delineations must be prepared in accordance with the current method required by the Corps. The permittee may ask the Corps to delineate the special aquatic sites and other waters of the United States, but there may be a delay if the Corps does the delineation, especially if the project site is large or contains many waters of the United States. Furthermore, the 45 day period will not start until the delineation has been submitted to or completed by the Corps, where appropriate;

(5) If the proposed activity will result in the loss of greater than 1/10 acre of wetlands and a PCN is required, the prospective permittee must submit a statement describing how the mitigation requirement will be satisfied. As an alternative, the prospective permittee may submit a conceptual or detailed mitigation plan.

(6) If any listed species or designated critical habitat might be affected or is in the vicinity of the project, or if the project is located in designated critical habitat, for non-Federal applicants the PCN must include the name(s) of those endangered or threatened species that might be affected by the proposed work or utilize the designated critical habitat that may be affected by the proposed work. Federal applicants must provide documentation demonstrating compliance with the Endangered Species Act; and

(7) For an activity that may affect a historic property listed on, determined to be eligible for listing on, or potentially eligible for listing on, the National Register of Historic Places, for non-Federal applicants the PCN must state which historic property may be affected by the proposed work or include a vicinity map indicating the location of the historic property. Federal applicants must provide documentation demonstrating compliance with Section 106 of the National Historic Preservation Act.

(c) Form of Pre-Construction Notification: The standard individual permit application form (Form ENG 4345) may be used, but the completed application form must clearly indicate that it is a PCN and must include all of the information required in paragraphs (b)(1) through (7) of this general condition. A letter containing the required information may also be used.

(d) Agency Coordination: (1) The district engineer will consider any comments from Federal and state agencies concerning the proposed activity's compliance with the terms and conditions of the NWPs and the need for mitigation to reduce the project's adverse environmental effects to a minimal level.

(2) For all NWP 48 activities requiring pre-construction notification and for other NWP activities requiring pre-construction notification to the district engineer that result in the loss of greater than 1/2-acre of waters of the United States, the district engineer will immediately provide (e.g., via facsimile transmission, overnight mail, or other expeditious manner) a copy of the PCN to the appropriate Federal or state offices (U.S. FWS, state natural resource or water quality agency, EPA, State Historic Preservation Officer (SHPO) or Tribal Historic Preservation Office (THPO), and, if appropriate, the NMFS). With the exception of NWP 37, these agencies will then have 10 calendar days from the date the material is transmitted to telephone or fax the district engineer notice that they intend to provide substantive, site-specific comments. If so contacted by an agency, the district engineer will wait an additional 15 calendar days before making a decision on the pre-construction notification. The district engineer will fully consider agency comments received within the specified time frame, but will provide no response to the resource agency, except as provided below. The district engineer will indicate in the administrative record associated with each pre-construction notification that the resource agencies' concerns were considered. For NWP 37, the emergency watershed protection and rehabilitation activity may proceed immediately in cases where there is an unacceptable hazard to life or a significant loss of property or economic hardship will occur. The district engineer will consider any comments received to decide whether the NWP 37 authorization should be modified, suspended, or revoked in accordance with the procedures at 33 CFR 330.5.

(3) In cases of where the prospective permittee is not a Federal agency, the district engineer will provide a response to NMFS within 30 calendar days of receipt of any Essential Fish Habitat conservation recommendations, as required by Section 305(b)(4)(B) of the Magnuson-Stevens Fishery Conservation and Management Act.

(4) Applicants are encouraged to provide the Corps multiple copies of pre-construction notifications to expedite agency coordination.

(5) For NWP 48 activities that require reporting, the district engineer will provide a copy of each report within 10 calendar days of receipt to the appropriate regional office of the NMFS.

(e) District Engineer's Decision: In reviewing the PCN for the proposed activity, the district engineer will determine whether the activity authorized by the NWP will result in more than minimal individual or cumulative adverse environmental effects or may be contrary to the public interest. If the proposed activity requires a PCN and will result in a loss of greater than 1/10 acre of wetlands, the prospective permittee should submit a mitigation proposal with the PCN. Applicants may also propose compensatory mitigation for projects with smaller impacts. The district engineer will consider any proposed compensatory mitigation the applicant has included in the proposal in determining whether the net adverse environmental effects to the aquatic environment of the proposed work are minimal. The compensatory mitigation proposal may be either conceptual or detailed. If the district engineer determines that the activity complies with the terms and conditions of the NWP and that the adverse effects on the aquatic environment are minimal, after considering mitigation, the district engineer will notify the permittee and include any conditions the district engineer deems necessary. The district engineer must approve any compensatory mitigation proposal before the permittee commences work. If the prospective permittee elects to submit a compensatory mitigation plan with the PCN, the district engineer will expeditiously review the proposed compensatory mitigation plan. The district engineer must review the plan within 45 calendar days of receiving a complete PCN and determine whether the proposed mitigation would ensure no more than minimal adverse effects on the aquatic environment. If the net adverse effects of the project on the aquatic environment

(after consideration of the compensatory mitigation proposal) are determined by the district engineer to be minimal, the district engineer will provide a timely written response to the applicant. The response will state that the project can proceed under the terms and conditions of the NWP.

If the district engineer determines that the adverse effects of the proposed work are more than minimal, then the district engineer will notify the applicant either: (1) That the project does not qualify for authorization under the NWP and instruct the applicant on the procedures to seek authorization under an individual permit; (2) that the project is authorized under the NWP subject to the applicant's submission of a mitigation plan that would reduce the adverse effects on the aquatic environment to the minimal level; or (3) that the project is authorized under the NWP with specific modifications or conditions. Where the district engineer determines that mitigation is required to ensure no more than minimal adverse effects occur to the aquatic environment, the activity will be authorized within the 45-day PCN period. The authorization will include the necessary conceptual or specific mitigation or a requirement that the applicant submit a mitigation plan that would reduce the adverse effects on the aquatic environment to the minimal level. When mitigation is required, no work in waters of the United States may occur until the district engineer has approved a specific mitigation plan.

28. Single and Complete Project. The activity must be a single and complete project. The same NWP cannot be used more than once for the same single and complete project.

FURTHER INFORMATION

1. District Engineers have authority to determine if an activity complies with the terms and conditions of an NWP.
2. NWPs do not obviate the need to obtain other federal, state, or local permits, approvals, or authorizations required by law.
3. NWPs do not grant any property rights or exclusive privileges.
4. NWPs do not authorize any injury to the property or rights of others.
5. NWPs do not authorize interference with any existing or proposed Federal project.

DEFINITIONS

Best management practices (BMPs): Policies, practices, procedures, or structures implemented to mitigate the adverse environmental effects on surface water quality resulting from development. BMPs are categorized as structural or non-structural.

Compensatory mitigation: The restoration, establishment (creation), enhancement, or preservation of aquatic resources for the purpose of compensating for unavoidable adverse impacts which remain after all appropriate and practicable avoidance and minimization has been achieved.

Currently serviceable: Useable as is or with some maintenance, but not so degraded as to essentially require reconstruction.

Discharge: The term "discharge" means any discharge of dredged or fill material.

Enhancement: The manipulation of the physical, chemical, or biological characteristics of an aquatic resource to heighten, intensify, or improve a specific aquatic resource function(s). Enhancement results in the gain of selected aquatic resource function(s), but may also lead to a

decline in other aquatic resource function(s). Enhancement does not result in a gain in aquatic resource area.

Ephemeral stream: An ephemeral stream has flowing water only during, and for a short duration after, precipitation events in a typical year. Ephemeral stream beds are located above the water table year-round. Groundwater is not a source of water for the stream. Runoff from rainfall is the primary source of water for stream flow.

Establishment (creation): The manipulation of the physical, chemical, or biological characteristics present to develop an aquatic resource that did not previously exist at an upland site. Establishment results in a gain in aquatic resource area.

Historic Property: Any prehistoric or historic district, site (including archaeological site), building, structure, or other object included in, or eligible for inclusion in, the National Register of Historic Places maintained by the Secretary of the Interior. This term includes artifacts, records, and remains that are related to and located within such properties. The term includes properties of traditional religious and cultural importance to an Indian tribe or Native Hawaiian organization and that meet the National Register criteria (36 CFR part 60).

Independent utility: A test to determine what constitutes a single and complete project in the Corps regulatory program. A project is considered to have independent utility if it would be constructed absent the construction of other projects in the project area. Portions of a multi-phase project that depend upon other phases of the project do not have independent utility. Phases of a project that would be constructed even if the other phases were not built can be considered as separate single and complete projects with independent utility.

Intermittent stream: An intermittent stream has flowing water during certain times of the year, when groundwater provides water for stream flow. During dry periods, intermittent streams may not have flowing water. Runoff from rainfall is a supplemental source of water for stream flow.

Loss of waters of the United States: Waters of the United States that are permanently adversely affected by filling, flooding, excavation, or drainage because of the regulated activity. Permanent adverse effects include permanent discharges of dredged or fill material that change an aquatic area to dry land, increase the bottom elevation of a waterbody, or change the use of a waterbody. The acreage of loss of waters of the United States is a threshold measurement of the impact to jurisdictional waters for determining whether a project may qualify for an NWP; it is not a net threshold that is calculated after considering compensatory mitigation that may be used to offset losses of aquatic functions and services. The loss of stream bed includes the linear feet of stream bed that is filled or excavated. Waters of the United States temporarily filled, flooded, excavated, or drained, but restored to pre-construction contours and elevations after construction, are not included in the measurement of loss of waters of the United States. Impacts resulting from activities eligible for exemptions under Section 404(f) of the Clean Water Act are not considered when calculating the loss of waters of the United States.

Non-tidal wetland: A non-tidal wetland is a wetland that is not subject to the ebb and flow of tidal waters. The definition of a wetland can be found at 33 CFR 328.3(b). Non-tidal wetlands contiguous to tidal waters are located landward of the high tide line (i.e., spring high tide line).

Open water: For purposes of the NWPs, an open water is any area that in a year with normal patterns of precipitation has water flowing or standing above ground to the extent that an ordinary high water mark can be determined. Aquatic vegetation within the area of standing or

flowing water is either non-emergent, sparse, or absent. Vegetated shallows are considered to be open waters. Examples of "open waters" include rivers, streams, lakes, and ponds.

Ordinary High Water Mark: An ordinary high water mark is a line on the shore established by the fluctuations of water and indicated by physical characteristics, or by other appropriate means that consider the characteristics of the surrounding areas (see 33 CFR 328.3(e)).

Perennial stream: A perennial stream has flowing water year-round during a typical year. The water table is located above the stream bed for most of the year. Groundwater is the primary source of water for stream flow. Runoff from rainfall is a supplemental source of water for stream flow.

Practicable: Available and capable of being done after taking into consideration cost, existing technology, and logistics in light of overall project purposes.

Pre-construction notification: A request submitted by the project proponent to the Corps for confirmation that a particular activity is authorized by nationwide permit. The request may be a permit application, letter, or similar document that includes information about the proposed work and its anticipated environmental effects. Pre-construction notification may be required by the terms and conditions of a nationwide permit, or by regional conditions. A pre-construction notification may be voluntarily submitted in cases where pre-construction notification is not required and the project proponent wants confirmation that the activity is authorized by nationwide permit.

Preservation: The removal of a threat to, or preventing the decline of, aquatic resources by an action in or near those aquatic resources. This term includes activities commonly associated with the protection and maintenance of aquatic resources through the implementation of appropriate legal and physical mechanisms. Preservation does not result in a gain of aquatic resource area or functions.

Re-establishment: The manipulation of the physical, chemical, or biological characteristics of a site with the goal of returning natural/historic functions to a former aquatic resource. Re-establishment results in rebuilding a former aquatic resource and results in a gain in aquatic resource area.

Rehabilitation: The manipulation of the physical, chemical, or biological characteristics of a site with the goal of repairing natural/historic functions to a degraded aquatic resource. Rehabilitation results in a gain in aquatic resource function, but does not result in a gain in aquatic resource area.

Restoration: The manipulation of the physical, chemical, or biological characteristics of a site with the goal of returning natural/historic functions to a former or degraded aquatic resource. For the purpose of tracking net gains in aquatic resource area, restoration is divided into two categories: re-establishment and rehabilitation.

Riffle and pool complex: Riffle and pool complexes are special aquatic sites under the 404(b)(1) Guidelines. Riffle and pool complexes sometimes characterize steep gradient sections of streams. Such stream sections are recognizable by their hydraulic characteristics. The rapid movement of water over a coarse substrate in riffles results in a rough flow, a turbulent surface, and high dissolved oxygen levels in the water. Pools are deeper areas associated with riffles. A slower stream velocity, a streaming flow, a smooth surface, and a finer substrate characterize pools.

Riparian areas: Riparian areas are lands adjacent to streams, lakes, and estuarine-marine shorelines. Riparian areas are transitional between terrestrial and aquatic ecosystems, through

which surface and subsurface hydrology connects waterbodies with their adjacent uplands. Riparian areas provide a variety of ecological functions and services and help improve or maintain local water quality. (See general condition 20.)

Shellfish seeding: The placement of shellfish seed and/or suitable substrate to increase shellfish production. Shellfish seed consists of immature individual shellfish or individual shellfish attached to shells or shell fragments (i.e., spat on shell). Suitable substrate may consist of shellfish shells, shell fragments, or other appropriate materials placed into waters for shellfish habitat.

Single and complete project: The term “single and complete project” is defined at 33 CFR 330.2(i) as the total project proposed or accomplished by one owner/developer or partnership or other association of owners/developers. A single and complete project must have independent utility (see definition). For linear projects, a “single and complete project” is all crossings of a single water of the United States (i.e., a single waterbody) at a specific location. For linear projects crossing a single waterbody several times at separate and distant locations, each crossing is considered a single and complete project. However, individual channels in a braided stream or river, or individual arms of a large, irregularly shaped wetland or lake, etc., are not separate waterbodies, and crossings of such features cannot be considered separately.

Stormwater management: Stormwater management is the mechanism for controlling stormwater runoff for the purposes of reducing downstream erosion, water quality degradation, and flooding and mitigating the adverse effects of changes in land use on the aquatic environment.

Stormwater management facilities: Stormwater management facilities are those facilities, including but not limited to, stormwater retention and detention ponds and best management practices, which retain water for a period of time to control runoff and/or improve the quality (i.e., by reducing the concentration of nutrients, sediments, hazardous substances and other pollutants) of stormwater runoff.

Stream bed: The substrate of the stream channel between the ordinary high water marks. The substrate may be bedrock or inorganic particles that range in size from clay to boulders. Wetlands contiguous to the stream bed, but outside of the ordinary high water marks, are not considered part of the stream bed.

Stream channelization: The manipulation of a stream’s course, condition, capacity, or location that causes more than minimal interruption of normal stream processes. A channelized stream remains a water of the United States.

Structure: An object that is arranged in a definite pattern of organization. Examples of structures include, without limitation, any pier, boat dock, boat ramp, wharf, dolphin, weir, boom, breakwater, bulkhead, revetment, riprap, jetty, artificial island, artificial reef, permanent mooring structure, power transmission line, permanently moored floating vessel, piling, aid to navigation, or any other manmade obstacle or obstruction.

Tidal wetland: A tidal wetland is a wetland (i.e., water of the United States) that is inundated by tidal waters. The definitions of a wetland and tidal waters can be found at 33 CFR 328.3(b) and 33 CFR 328.3(f), respectively. Tidal waters rise and fall in a predictable and measurable rhythm or cycle due to the gravitational pulls of the moon and sun. Tidal waters end where the rise and fall of the water surface can no longer be practically measured in a predictable rhythm due to masking by other waters, wind, or other effects. Tidal wetlands are located channelward of the high tide line, which is defined at 33 CFR 328.3(d).

Vegetated shallows: Vegetated shallows are special aquatic sites under the 404(b)(1) Guidelines. They are areas that are permanently inundated and under normal circumstances have rooted aquatic vegetation, such as seagrasses in marine and estuarine systems and a variety of vascular rooted plants in freshwater systems.

Waterbody: For purposes of the NWPs, a waterbody is a jurisdictional water of the United States that, during a year with normal patterns of precipitation, has water flowing or standing above ground to the extent that an ordinary high water mark (OHWM) or other indicators of jurisdiction can be determined, as well as any wetland area (see 33 CFR 328.3(b)). If a jurisdictional wetland is adjacent--meaning bordering, contiguous, or neighboring--to a jurisdictional waterbody displaying an OHWM or other indicators of jurisdiction, that waterbody and its adjacent wetlands are considered together as a single aquatic unit (see 33 CFR 328.4(c)(2)). Examples of "waterbodies" include streams, rivers, lakes, ponds, and wetlands.

REGIONAL CONDITIONS FOR NATIONWIDE PERMITS IN THE WILMINGTON DISTRICT

1. Excluded Waters

The Corps has identified waters that will be excluded from the use of all NWP's during certain timeframes. These waters are:

1.1. Anadromous Fish Spawning Areas

Waters of the United States identified by either the North Carolina Division of Marine Fisheries (NCDMF) or the North Carolina Wildlife Resources Commission (NCWRC) as anadromous fish spawning areas are excluded during the period between February 15 and June 30, without prior written approval from NCDMF or NCWRC and the Corps.

1.2. Trout Waters Moratorium

Waters of the United States in the twenty-five designated trout counties of North Carolina are excluded during the period between October 15 and April 15 without prior written approval from the NCWRC. (see Section I. b. 7. for a list of the twenty-five trout counties).

1.3. Sturgeon Spawning Areas

Waters of the United States designated as sturgeon spawning areas are excluded during the period between February 1 and June 30, without prior written approval from the National Marine Fisheries Service (NMFS).

2. Waters Requiring Additional Notification

The Corps has identified waters that will be subject to additional notification requirements for activities authorized by all NWP's. These waters are:

2.1. Western NC Counties that Drain to Designated Critical Habitat

Waters of the U.S. that requires a Pre-Construction Notification pursuant to General Condition 27 (PCN) and located in the sixteen counties listed below, applicants must provide a copy of the PCN to the US Fish and Wildlife Service, 160 Zillicoa Street, Asheville, North Carolina 28805. This PCN must be sent concurrently to the US Fish and Wildlife Service and the Corps Asheville Regulatory Field Office. Please see General Condition 17 for specific notification requirements related to Federally Endangered Species and the following website for information on the location of designated critical habitat.

Counties with tributaries that drain to designated critical habitat that require notification to the Asheville US Fish and Wildlife Service: Avery, Cherokee, Forsyth, Graham, Haywood,

Henderson, Jackson, Macon Mecklenburg, Mitchell, Stokes, Surry, Swain, Transylvania, Union and Yancey.

Website and office addresses for Endangered Species Act Information:

The Wilmington District has developed the following website for applicants which provide guidelines on how to review linked websites and maps in order to fulfill NWP general condition 17 requirements.

<http://www.saw.usace.army.mil/wetlands/ESA>

Applicants who do not have internet access may contact the appropriate US Fish and Wildlife Service offices or the US Army Corps of Engineers office listed below.

US Fish and Wildlife Service
Asheville Field Office
160 Zillicoa Street
Asheville, NC 28801
Telephone: (828) 258-3939

Asheville US Fish and Wildlife Service Office counties: All counties west of and including Anson, Stanly, Davidson, Forsyth and Stokes Counties

US Fish and Wildlife Service
Raleigh Field Office
Post Office Box 33726
Raleigh, NC 27636-3726
Telephone: (919) 856-4520

Raleigh US Fish and Wildlife Service Office counties: all counties east of and including Richmond, Montgomery, Randolph, Guilford, and Rockingham Counties.

2.2. Special Designation Waters

Prior to the use of any NWP in any of the following North Carolina identified waters and contiguous wetlands, applicants must comply with Nationwide Permit General Condition 27 (PCN). The North Carolina waters and contiguous wetlands that require additional notification requirements are:

“Outstanding Resource Waters” (ORW) and “High Quality Waters” (HQW) (as designated by the North Carolina Environmental Management Commission), or
“Inland Primary Nursery Areas” (IPNA) (as designated by the North Carolina Wildlife Resources Commission), or “Contiguous Wetlands” (as defined by the North Carolina Environmental Management Commission), or “Primary Nursery Areas” (PNA) (as designated by the North Carolina Marine Fisheries Commission).

2.3. Coastal Area Management Act (CAMA) Areas of Environmental Concern

Non-Federal applicants for any NWP in a designated “Area of Environmental Concern” (AEC) in the twenty (20) counties of Eastern North Carolina covered by the North Carolina Coastal Area Management Act (CAMA), must also obtain the required CAMA permit. Construction activities for non-Federal projects may not commence until a copy of the approved CAMA permit is furnished to the appropriate Wilmington District Regulatory Field Office (Wilmington Field Office – P.O. Box 1890, Wilmington, NC 28402 or Washington Field Office – P.O. Box 1000, Washington, NC 27889).

2.4. Barrier Islands

Prior to the use of any NWP on a barrier island of North Carolina, applicants must comply with Nationwide Permit General Condition 27 (PCN).

2.5. Mountain or Piedmont Bogs

Prior to the use of any NWP in a “Mountain or Piedmont Bog” of North Carolina, applicants shall comply with Nationwide Permit General Condition 27 (PCN).

Note: The following wetland community types identified in the N.C. Natural Heritage Program document, “Classification of Natural communities of North Carolina (Michael P. Schafale and Alan S. Weakley, 1990), are subject to this regional condition.

Mountain Bogs	Piedmont Bogs
Swamp Forest-Bog Complex	Upland depression Swamp Forest
Swamp Forest-Bog Complex (Spruce Subtype)	
Southern Appalachian Bog (Northern Subtype)	
Southern Appalachian Bog (Southern Subtype)	
Southern Appalachian Fen	

2.6. Animal Waste Facilities

Prior to use of any NWP for construction of animal waste facilities in waters of the US, including wetlands, applicants shall comply with Nationwide Permit General Condition 27 (PCN).

2.7. Trout Waters

Prior to any discharge of dredge or fill material into streams or waterbodies within the twenty-five (25) designated trout counties of North Carolina, the applicant shall comply with

Nationwide Permit General Condition 27 (PCN). The applicant shall also provide a copy of the notification to the appropriate NCWRC office to facilitate the determination of any potential impacts to designated Trout Waters. Notification to the Corps of Engineers will include a statement with the name of the NCWRC biologist contacted, the date of the notification, the location of work, a delineation of wetlands, a discussion of alternatives to working in the mountain trout waters, why alternatives were not selected, and a plan to provide compensatory mitigation for all unavoidable adverse impacts to mountain trout waters.

NCWRC and NC Trout Counties

Mr. Ron Linville			
Western Piedmont Region Coordinator	Alleghany	Caldwell	Watauga
3855 Idlewild Road	Ashe	Mitchell	Wilkes
Kernersville, NC 27284-9180	Avery	Stokes	
Telephone: (336) 769-9453	Burke	Surry	

Mr. Dave McHenry			
Mountain Region Coordinator	Buncombe	Henderson	Polk
20830 Great Smoky Mtn. Expressway	Cherokee	Jackson	Rutherford
Waynesville, NC 28786	Clay	Macon	Swain
Telephone: (828) 452-2546	Graham	Madison	Transylvania
Fax: (828) 452-7772	Haywood	McDowell	Yancey

3. List of Corps Regional Conditions for All Nationwide Permits

The following conditions apply to all Nationwide Permits in the Wilmington District:

3.1. Limitation of Loss of Perennial Stream Bed

NWPs may not be used for activities that may result in the loss or degradation of greater than 300 total linear feet of perennial streams. The NWPs may not be used for activities that may result in the loss or degradation of greater than 300 total linear feet of ephemeral and intermittent streams that exhibit important aquatic function(s)* Loss of stream includes the linear feet of stream bed that is filled, excavated, or flooded by the proposed activity. The District Commander can waive the 300 linear foot limit for ephemeral and intermittent streams on a case-by-case basis if he determines that the proposed activity will result in minimal individual and cumulative adverse impacts to the aquatic environment. Waivers for the loss of ephemeral and intermittent streams must be in writing. This waiver only applies to the 300 linear feet threshold for NWPs. Mitigation may still be required for impacts to ephemeral and intermittent streams, on a case-by-case basis, depending on the impacts to the aquatic environment of the proposed project. [*Note: The Corps uses the Stream Quality Assessment Worksheet, located with Permit Information on the Regulatory Program Web Site, to aid in the determination of aquatic function within the intermittent stream channel.]

3.2. Mitigation for Loss of Stream Bed Exceeding 150 Feet.

For any NWP that results in a loss of more than 150 linear feet of perennial and/or ephemeral/intermittent stream, the applicant shall provide a mitigation proposal to compensate for the loss of aquatic function associated with the proposed activity. For stream losses less than 150 linear feet, that require a PCN, the District Commander may determine, on a case-by-case basis that compensatory mitigation is required to ensure that the activity results in minimal adverse effect on the aquatic environment.

3.3. Pre-construction Notification for Loss of Streambed Exceeding 150 Feet.

Prior to use of any NWP for any activity which impacts more than 150 total linear feet of perennial stream or ephemeral/ intermittent stream, the applicant must comply with Nationwide Permit General Condition 27 (PCN). This applies to NWPs that do not have specific notification requirements. If a NWP has specific notification requirements, the requirements of the NWP should be followed.

3.4. Restriction on Use of Live Concrete

For all NWPs which allow the use of concrete as a building material, measures will be taken to prevent live or fresh concrete, including bags of uncured concrete, from coming into contact with waters of the state until the concrete has hardened.

3.5. Requirements for Using Riprap for Bank Stabilization

For all NWPs that allow for the use of riprap material for bank stabilization, the following measures shall be applied:

3.5.1. Filter cloth must be placed underneath the riprap as an additional requirement of its use in North Carolina waters.

3.5.2. The placement of riprap shall be limited to the areas depicted on submitted work plan drawings.

3.5.3. The riprap material shall be clean and free from loose dirt or any pollutant except in trace quantities that would not have an adverse environmental effect.

3.5.4. It shall be of a size sufficient to prevent its movement from the authorized alignment by natural forces under normal conditions.

3.5.5. The riprap material shall consist of clean rock or masonry material such as, but not limited to, granite, marl, or broken concrete.

3.5.6. A waiver from the specifications in this Regional Condition may be requested in writing. The waiver will only be issued if it can be demonstrated that the impacts of complying with this Regional condition would result in greater adverse impacts to the aquatic environment.

3.6. Safe Passage Requirements for Culvert Placement

For all NWP's that involve the construction/installation of culverts, measures will be included in the construction/installation that will promote the safe passage of fish and other aquatic organisms. The dimension, pattern, and profile of the stream above and below a pipe or culvert should not be modified by widening the stream channel or by reducing the depth of the stream in connection with the construction activity. The width, height, and gradient of a proposed opening should be such as to pass the average historical low flow and spring flow without adversely altering flow velocity. Spring flow should be determined from gage data, if available. In the absence of such data, bankfull flow can be used as a comparable level.

In the twenty (20) counties of North Carolina designated as coastal counties by the Coastal Area Management Act (CAMA): All pipe and culvert bottoms shall be buried at least one foot below normal bed elevation when they are placed within the Public Trust Area of Environmental Concern (AEC) and/or the Estuarine Waters AEC as designated by CAMA, and/or all streams appearing as blue lines on United States Geological Survey (USGS) quad sheets.

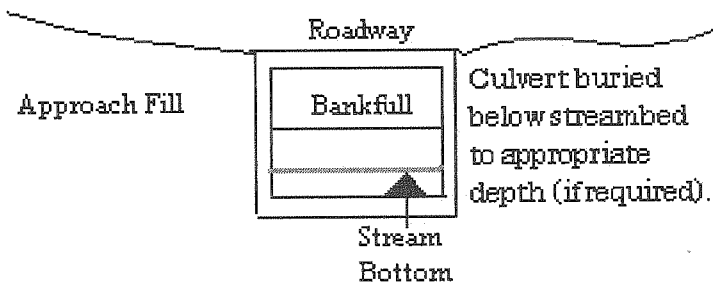

In all other counties: Culverts greater than 48 inches in diameter will be buried at least one foot below the bed of the stream. Culverts 48 inches in diameter or less shall be buried or placed on the stream bed as practicable and appropriate to maintain aquatic passage, and every effort shall be made to maintain the existing channel slope. The bottom of the culvert must be placed at a depth below the natural stream bottom to provide for passage during drought or low flow conditions.

Destabilizing the channel and head cutting upstream should be considered in the placement of the culvert.

A waiver from the depth specifications in this condition may be requested in writing. The waiver will be issued if it can be demonstrated that the proposal would result in the least impacts to the aquatic environment.

All counties: Culverts placed in wetlands do not have to be buried.

3.7. Notification to NCDENR Shellfish Sanitation Section

Applicants shall notify the NCDENR Shellfish Sanitation Section prior to dredging in or removing sediment from an area closed to shell fishing where the effluent may be released to an area open for shell fishing or swimming in order to avoid contamination from the disposal area and cause a temporary shellfish closure to be made. Such notification shall also be provided to the appropriate Corps of Engineers Regulatory Field Office. Any disposal of sand to the ocean beach should occur between November 1 and April 30 when recreational usage is low. Only clean sand should be used and no dredged sand from closed shell fishing areas may be used. If beach disposal were to occur at times other than stated above or if sand from a closed shell fishing area is to be used, a swimming advisory shall be posted, and a press release shall be issued.

3.8. Preservation of Submerged Aquatic Vegetation

Adverse impacts to Submerged Aquatic Vegetation (SAV) are not authorized by any NWP within any of the twenty coastal counties defined by North Carolina's Coastal Area Management Act of 1974 (CAMA).

NC DIVISION OF WATER QUALITY - GENERAL CERTIFICATION CONDITIONS

For the most recent General Certification conditions, call the NC Division of Water Quality, Wetlands/401 Certification Unit at (919) 733-1786 or access the following website:
<http://h2o.enr.state.nc.us/newetlands/certs.html>

NC DIVISION OF COASTAL MANAGEMENT - STATE CONSISTENCY

In a letter dated May 7, 2007, the North Carolina Division of Coastal Management found this NWP consistent with the North Carolina Coastal Zone Management Program. Updates on CAMA Consistency for NC can be found on the NC DCM web site at:
<http://dcm2.enr.state.nc.us/Permits/consist.htm>

EASTERN BAND OF THE CHEROKEE INDIANS TRIBAL WATER QUALITY CERTIFICATIONS

In a letter dated May 8, 2007, US EPA, on behalf of the Eastern Band of Cherokee Indians, provided Tribal General Conditions for Nationwide Permits on Cherokee Indian Reservation. These Tribal General Conditions are located on the Corps website at:
<http://www.saw.usace.army.mil/WETLANDS/NWP2007/EBCI-certs.html>

Citations:

2007 Nationwide Permits Public Notice for Final Issue Date: March 15, 2007

Correction Notice for Nationwide Permits, Federal Register / Vol. 72, No. 88 / Tuesday, May 8, 2007 / Notices p.26082

2007 SAW Regional Conditions – Authorized June 1, 2007

This and other information can be found on the Corps web site at:
<http://www.saw.usace.army.mil/WETLANDS/NWP2007/nationwide-permits.html>

Willis, Thomas C

From: Ward, Garcy
Sent: Thursday, January 19, 2012 9:52 AM
To: Willis, Thomas C; Shook, Ryan L
Cc: Biddlecome, William J SAW; Lane, Stephen; Carrillo, Sonia; Ward, Garcy
Subject: Bertie bridges 72 and 87

Clay,
I've reviewed your Low Impact Bridge applications requesting a NW 3 for the replacement of Bridge # 72 and Bridge # 87 in Bertie Co. (DWQ project #'s 11-1092 and 11-1093). Water Quality Certification # 3687 is issued for these projects. Written approval is not required for use of this Certification provided all the conditions can be met. If any of the conditions cannot be met, written approval may be required. Let me know if you have any questions. Thanks -
Garcy

E-mail correspondence to and from this address may be subject to the North Carolina Public Records Law and may be disclosed to third parties.

Water Quality Certification N^o. 3687

GENERAL CERTIFICATION FOR PROJECTS ELIGIBLE FOR U.S. ARMY CORPS OF ENGINEERS NATIONWIDE PERMIT NUMBERS: 3 (MAINTENANCE), 4 (FISH AND WILDLIFE HARVESTING, ENHANCEMENT, AND ATTRACTION DEVICES AND ACTIVITIES), 5 (SCIENTIFIC MEASUREMENT DEVICES—25 CUBIC YARDS FOR WEIRS AND FLUMES), 6 (SURVEY ACTIVITIES—25 CUBIC YARDS FOR TEMPORARY PADS), 7 (OUTFALL STRUCTURES AND ASSOCIATED INTAKE STRUCTURES), 19 (MINOR DREDGING), 20 (OIL SPILL CLEANUP), 22 (REMOVAL OF VESSELS), 25 (STRUCTURAL DISCHARGE), 30(MOIST SOIL MANAGEMENT FOR WILDLIFE), 32 (COMPLETED ENFORCEMENT ACTIONS), 36 (BOAT RAMPS (IN NONWETLAND SITES)), AND REGIONAL PERMIT 197800056 (PIERS, DOCKS AND BOATHOUSES), AND REGIONAL PERMIT 197800125 (BOAT RAMPS) AND RIPARIAN AREA PROTECTION RULES (BUFFER RULES)

Water Quality Certification Number 3687 is issued in conformity with the requirements of Section 401, Public Laws 92-500 and 95-217 of the United States and subject to the North Carolina Division of Water Quality (DWQ) Regulations in 15 NCAC 2H, Section .0500 and 15 NCAC 2B .0200 for the discharge of fill material to waters and wetland areas which are waters of the United States as described in 33 CFR 330 Appendix A (B) (3, 4, 5, 6, 7, 19, 20, 22, 25, 30, 32, and 36) of the Corps of Engineers regulations and Regional Permits 197800056 and 19780125 and for the Riparian Area Protection Rules (Buffer Rules) in 15A NCAC 2B .0200.

The State of North Carolina certifies that the specified category of activity will not violate applicable portions of Sections 301, 302, 303, 306 and 307 of the Public Laws 92-500 and 95-217 if conducted in accordance with the conditions hereinafter set forth.

Activities meeting any one (1) of the following thresholds or circumstances require *written approval* for a 401 Water Quality Certification from the Division of Water Quality (the "Division"):

- a. Impacts equal or greater than 40 linear feet of additional permanent stream impact at an existing stream crossing location, or
- b. Temporary or permanent impacts equal to or exceeding: one-third (1/3) acre of wetlands East of Interstate-95, or one-tenth (1/10) of acre of wetlands West of Interstate-95; or
- c. Any impact associated with a Notice of Violation or an enforcement action initiated by the Division and/or the Division of Land Resources; or
- d. Projects with any impacts to streams, wetlands, and/or waters that have received a Notice of Violation from the Division and/or Division of Land Resources; or
- e. Any impacts to streams and/or buffers in the Neuse, Tar-Pamlico, Randleman and Catawba River Basins (or any other basins with Riparian Area Protection Rules [Buffer Rules] in effect at the time of application) *unless* the activities are listed as "EXEMPT" from these Rules.

In accordance with North Carolina General Statute Section 143-215.3D(e), written approval for a 401 Water Quality General Certification must include the appropriate fee. If a project also requires a CAMA Permit, then one payment to both agencies shall be submitted and will be the higher of the two fees.

Activities included in this General Certification and below the thresholds listed above *do not* require written approval from the Division of Water Quality as long as they comply with the Conditions of Certification listed below. If any of these Conditions cannot be met, written approval from the Division is required.

Water Quality Certification N^o. 3687

Conditions of Certification:

1. No Impacts Beyond Those Authorized for this General Certification

No waste, spoil, solids, or fill of any kind shall occur in wetlands, waters, or riparian areas beyond the thresholds established for use of this General Certification, or beyond the footprint of the impacts authorized in the written approval, including incidental impacts. All construction activities, including the design, installation, operation, and maintenance of sediment and erosion control Best Management Practices, shall be performed so that no violations of state water quality standards, statutes, or rules occur.

2. Standard Erosion and Sediment Control Practices

Erosion and sediment control practices must be in full compliance with all specifications governing the proper design, installation and operation and maintenance of such Best Management Practices:

- a. Design, installation, operation, and maintenance of the sediment and erosion control measures must be such that they equal, or exceed, the requirements specified in the most recent version of the *North Carolina Sediment and Erosion Control Manual*. The devices shall be maintained on all construction sites, borrow sites, and waste pile (spoil) projects, including contractor-owned or leased borrow pits associated with the project.
- b. For borrow pit sites, the erosion and sediment control measures must be designed, installed, operated, and maintained in accordance with the most recent version of the *North Carolina Surface Mining Manual*.
- c. Reclamation measures and implementation must comply with the reclamation in accordance with the requirements of the Sedimentation Pollution Control Act and the Mining Act of 1971.
- d. Sufficient materials required for stabilization and/or repair of erosion control measures and stormwater routing and treatment shall be on site at all times, except for publicly funded linear transportation projects when materials can be accessed offsite in a timely manner.
- e. If the project occurs in waters or watersheds classified as Primary Nursery Areas (PNAs), Trout (Tr), SA, WS-I, WS-II, High Quality (HQW), or Outstanding Resource (ORW) waters, then the sediment and erosion control requirements contained within *Design Standards in Sensitive Watersheds* (15A NCAC 04B .0124) supercede all other sediment and erosion control requirements.

3. No Sediment and Erosion Control Measures in Wetlands or Waters

Sediment and erosion control measures should not be placed in wetlands or waters outside of the permitted impact areas without prior approval from the Division. If placement of sediment and erosion control devices in wetlands and waters is unavoidable, then the design and placement of temporary erosion control measures shall not be conducted in a manner that may result in dis-equilibrium of wetlands or stream beds or banks, adjacent to or upstream and down stream of the above structures. All sediment and erosion control devices shall be removed and the natural grade restored within two (2) months of the date that the Division of Land Resources or locally delegated program has released the project.

4. Construction Stormwater Permit NCG010000

Upon the approval of an Erosion and Sedimentation Control Plan issued by the Division of Land Resources (DLR) or a DLR delegated local erosion and sedimentation control program, an NPDES General stormwater permit (NCG010000) administered by the Division is automatically issued to the project. This General Permit allows stormwater to be discharged during land disturbing construction activities as stipulated by conditions in the permit. If the

Water Quality Certification N^o. 3687

activity is covered by this permit [applicable to construction projects that disturb one (1) or more acres], full compliance with permit conditions including the sedimentation control plan, self-monitoring, record keeping and reporting requirements are required. A copy of this permit and monitoring report forms may be found at http://h2o.enr.state.nc.us/su/Forms_Documents.htm.

NCDOT shall be required to be in full compliance with the conditions related to construction activities within the most recent version of their individual NPDES (NCS000250) stormwater permit.

5. Work in the Dry

All work in or adjacent to stream waters shall be conducted in a dry work area. Approved best management practices from the most current version of the NC Sediment and Erosion Control Manual, or the NC DOT Construction and Maintenance Activities Manual, such as sandbags, rock berms, cofferdams, and other diversion structures shall be used to minimize excavation in flowing water. Exceptions to this condition require submittal to, and approval by, the Division.

6. Construction Moratoriums and Coordination

If activities must occur during periods of high biological activity (i.e. sea turtle or bird nesting), then biological monitoring may be required at the request of other state or federal agencies and coordinated with these activities. This condition can be waived through written concurrence on a case by case basis upon reasonable justification.

All moratoriums on construction activities established by the NC Wildlife Resources Commission (WRC), US Fish and Wildlife Service (USFWS), NC Division of Marine Fisheries (DMF), or National Marine Fisheries Service (NMFS) to protect trout, anadromous fish, larval/post-larval fishes and crustaceans, or other aquatic species of concern shall be obeyed. This condition can be waived through written concurrence on a case by case basis upon reasonable justification.

Work within the twenty-five (25) designated trout counties or identified state or federal endangered or threatened species habitat shall be coordinated with the appropriate WRC, USFWS, NMFS personnel.

7. Riparian Area Protection Rules (Buffer Rules)

Activities located in the protected 50-foot wide riparian areas (whether jurisdictional wetlands or not) within the Neuse, Tar-Pamlico, Randleman, Catawba (or any other basin with buffer rules), shall be limited to "uses" identified within and constructed in accordance with 15A NCAC 2B .0233, .0259, .0250, and .0243, and shall be located, designed, constructed, and maintained to have minimal disturbance to protect water quality to the maximum extent practicable through the use of best management practices. All riparian area protection rule requirements, including diffuse flow requirements, must be met.

8. Water Supply Watershed Buffers

The 100-foot wide (high-density development) or the 30-foot wide vegetative buffer (all other development) must be maintained adjacent to all perennial waters except for allowances as provided in the Water Supply Watershed Protection Rules [15A NCAC 2B .0212 through .0215].

Water Quality Certification N°. 3687

9. Placement of Culverts and Other Structures in Waters and Wetlands

The application must include construction plans with cross-sectional details in order to indicate that the current stability of the stream will be maintained or enhanced (i.e., not result in head cuts).

Culverts required for this project shall be designed and installed in such a manner that the original stream profiles are not altered and allow for aquatic life movement during low flows. Existing stream dimensions (including the cross section dimensions, pattern, and longitudinal profile) must be maintained above and below locations of each culvert. Placement of culverts and other structures in waters, streams, and wetlands must be placed below the elevation of the streambed by one foot for all culverts with a diameter greater than 48 inches, and 20 percent of the culvert diameter for culverts having a diameter less than 48 inches, to allow low flow passage of water and aquatic life, unless otherwise justified and approved by the Division.

Installation of culverts in wetlands must ensure continuity of water movement and be designed to adequately accommodate high water or flood conditions. Additionally, when roadways, causeways or other fill projects are constructed across FEMA-designated floodways or wetlands, openings such as culverts or bridges must be provided to maintain the natural hydrology of the system as well as prevent constriction of the floodway that may result in destabilization of streams or wetlands.

Any rip rap required for normal pipe burial and stabilization shall be buried such that the original stream elevation is restored and maintained.

The establishment of native, woody vegetation and other soft stream bank stabilization techniques must be used where practicable instead of rip-rap or other bank hardening methods.

10. If concrete is used during the construction, then a dry work area should be maintained to prevent direct contact between curing concrete and stream water. Water that inadvertently contacts uncured concrete should not be discharged to surface waters due to the potential for elevated pH and possible aquatic life/fish kills.
11. Applications for riprap groins proposed in accordance with 15A NCAC 07H .1401 (NC Division of Coastal Management General Permit for construction of Wooden and Riprap Groins in Estuarine and Public Trust Waters) must meet all the specific conditions for design and construction specified in 15A NCAC 07H .1405.

12. Temporary Fills and/or Access Roads

All temporary fill and culverts shall be removed and the impacted area returned to the original grade, including each stream's original cross sectional dimensions, plan form pattern, and longitudinal bed and bed profile after construction is complete or within two (2) months of the establishment of the crossing, whichever is sooner, and the various sites shall be stabilized with natural woody vegetation (except for the maintenance areas of permanent utility crossings) and restored to prevent erosion. If the crossings are not completely removed and restored as described above within the specified time above, then written approval from the Division must be obtained to modify this condition.

Water Quality Certification N°. 3687

13. For activities requiring written approval, additional site-specific conditions may be added to the approval letter in order to ensure compliance with all applicable water quality and effluent standards.

14. Certificate of Completion

When written authorization is required for use of this certification, upon completion of all permitted impacts included within the approval and any subsequent modifications, the applicant shall be required to return the certificate of completion attached to the approval. One copy of the certificate shall be sent to the DWQ Central Office in Raleigh at 1650 Mail Service Center, Raleigh, NC, 27699-1650.

15. If an environmental document is required under NEPA or SEPA, then this General Certification is not valid until a Finding of No Significant Impact (FONSI) or Record of Decision (ROD) is issued by the State Clearinghouse.
16. This General Certification shall expire three (3) years from the date of issuance of the written approval or on the same day as the expiration date of these corresponding Nationwide and Regional General Permits. In accordance with General Statute 136-44.7B, certifications issued to the NCDOT shall expire only upon expiration of the federal 404 Permit. The conditions in effect on the date of issuance of Certification for a specific project shall remain in effect for the life of the project, regardless of the expiration date of this Certification. If the construction process for approved activities will overlap the expiration and renewal date of the corresponding 404 Permit and the Corps allows for continued use of the 404 Permit, then the General Certification shall also remain in effect without requiring re-application and re-approval to use this Certification for the specific impacts already approved.
17. The applicant/permittee and their authorized agents shall conduct all activities in a manner consistent with State water quality standards (including any requirements resulting from compliance with §303(d) of the Clean Water Act), and any other appropriate requirements of State and Federal Law. If the Division determines that such standards or laws are not being met, including failure to sustain a designated or achieved use, or that State or Federal law is being violated, or that further conditions are necessary to assure compliance, then the Division may reevaluate and modify this General Water Quality Certification.

Non-compliance with or violation of the conditions herein set forth by a specific fill project shall result in revocation of this General Certification for the project and may result in criminal and/or civil penalties.

The Director of the North Carolina Division of Water Quality may require submission of a formal application for Individual Certification for any project in this category of activity if it is determined that the project is likely to have a significant adverse effect upon water quality, including state or federally listed endangered or threatened aquatic species, or degrade the waters so that existing uses of the wetland or downstream waters are precluded.

Public hearings may be held for specific applications or group of applications prior to a Certification decision if deemed in the public's best interest by the Director of the North Carolina Division of Water Quality.

Water Quality Certification N°. 3687

Effective date: November 1, 2007

DIVISION OF WATER QUALITY

By

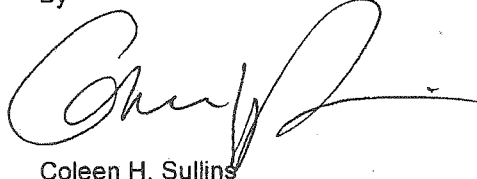

Coleen H. Sullins

Director

History Note: Water Quality Certification Number 3687 replaces Water Quality Certification Number 3376 issued on March 18, 2002, Water Quality Certification Number 3494 issued December 31, 2004, and Water Quality Certification Number 3624 issued March 2007. This General Certification is rescinded when the Corps of Engineers re-authorizes any of these Nationwide or Regional Permits or when deemed appropriate by the Director of the Division of Water Quality.

See Sheet 1-A For Index of Sheets

STATE OF NORTH CAROLINA
DIVISION OF HIGHWAYS



STATE	STATE PROJECT REFERENCE NO.	SHEET NO.	TOTAL SHEETS
N.C.	BD-51011	1	
STATE PROJ. NO.	F.A. PROJ. NO.	DESCRIPTION	
45347.1.10	BRZ-1110(7)	PE	

BERTIE COUNTY

LOCATION: BRIDGE NO. 72 OVER BRANCH OF FROG LEVEL SWAMP
ON SR 1110 QUITNSA ROAD

TYPE OF WORK: GRADING, DRAINAGE, PAVING & STRUCTURE
WETLAND/SURFACE WATER PERMIT DRAWINGS

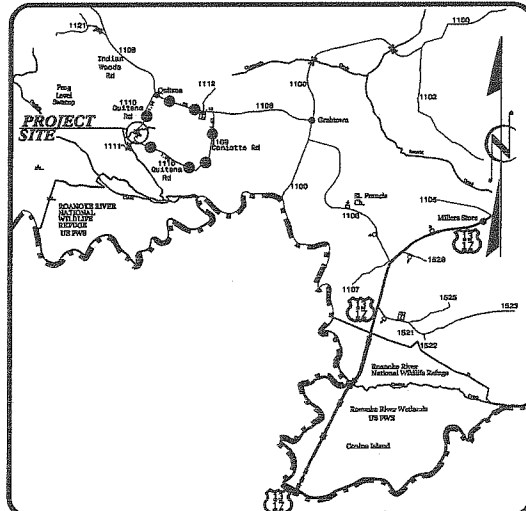

BD-51011 VICINITY MAP
OFF-SITE DETOUR

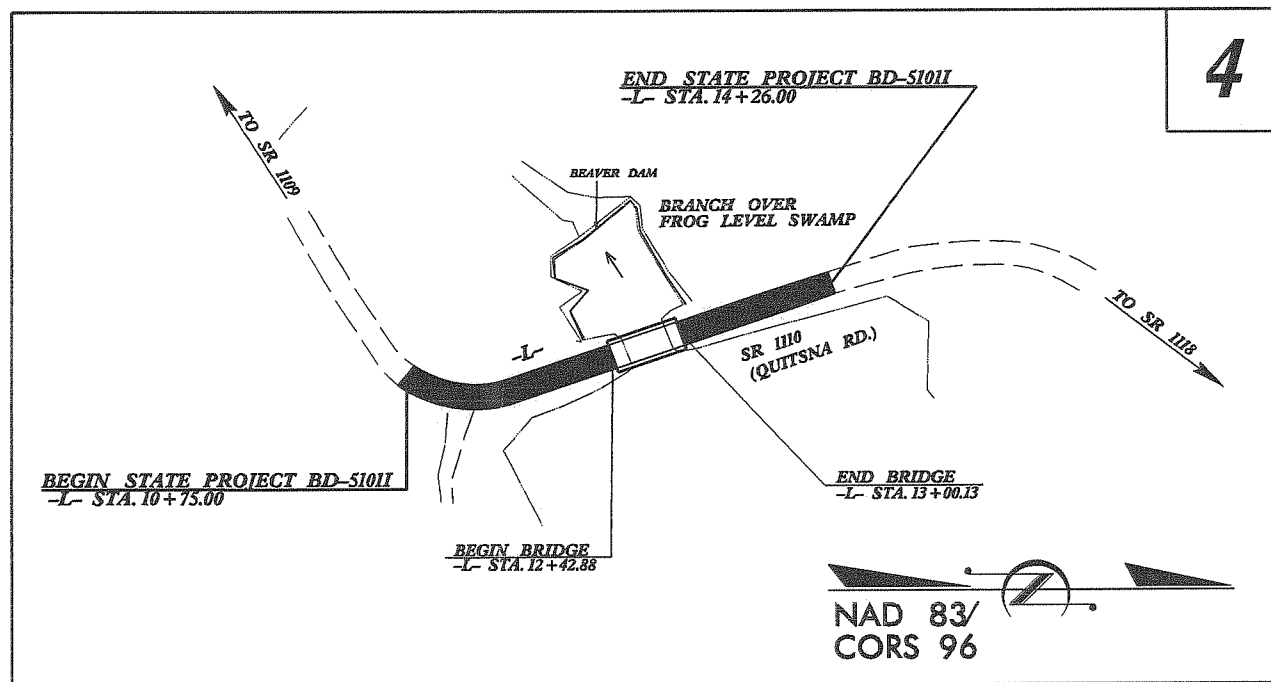

TIP PROJECT: BD-51011

CONTRACT:

CLEARING ON THIS PROJECT SHALL BE PERFORMED TO THE LIMITS ESTABLISHED BY METHOD II.

INCOMPLETE PLANS
DO NOT USE FOR R/W ACQUISITION
PRELIMINARY PLANS
DO NOT USE FOR CONSTRUCTION

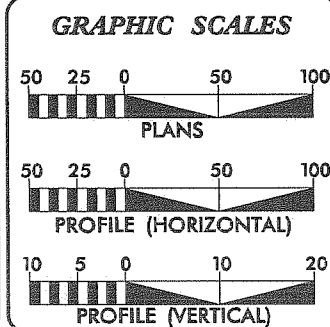

DESIGN DATA

ADT 2012 =	71
ADT 2032 =	72
DHV =	10 %
D =	50 %
T =	8 % *
V =	30 MPH
* TTST =	3% DUAL 5%
FUNC CLASS =	LOCAL
SUBREGIONAL TIER	

PROJECT LENGTH

LENGTH ROADWAY STATE PROJECT 17BP.S.R.1 =	0.056 MILES
LENGTH STRUCTURE STATE PROJECT 17BP.S.R.1 =	0.010 MILES
TOTAL LENGTH STATE PROJECT 17BP.S.R.1 =	0.066 MILES

Prepared for the North Carolina Department of Transportation in the Office of:

WETHERILL ENGINEERING
559 JONES FRANKLIN ROAD
SUITE 154
Raleigh, N.C. 27606
Licenses No. F-0277
Box: 99 851 8077
Fax: 919 851 9107

2006 STANDARD SPECIFICATIONS	
RIGHT OF WAY DATE:	EDWARD G. WETHERILL, PE PROJECT ENGINEER
LETTING DATE:	BOB A. MAY, PE PROJECT DESIGN ENGINEER

HYDRAULICS ENGINEER

SIGNATURE: _____ P.E.

ROADWAY DESIGN ENGINEER

SIGNATURE: _____ P.E.

**DIVISION OF HIGHWAYS
STATE OF NORTH CAROLINA**

STATE HIGHWAY DESIGN ENGINEER P.E.

5:24:01 AM P:\2011\BD-51011\Hydraulics\Environmental\Permit\BD51011_permit_psh.dgn 10/27/2011

8/17/99

WETLAND/SURFACE WATER PERMIT DRAWINGS



PROJECT REFERENCE NO. BD-51011	SHEET NO. 4
RAW SHEET NO.	
ROADWAY DESIGN ENGINEER	HYDRAULICS ENGINEER
INCOMPLETE PLANS DO NOT USE FOR R/W ACQUISITION PRELIMINARY PLANS DO NOT USE FOR CONSTRUCTION	
<small>359 Jones Franklin Rd. Suite 164 Raleigh, N.C. 27606 License No. 14-0377 Box: 919 851 8077 Fax: 919 851 8107</small>	
<small>TRANSPORTATION PLANNING/DESIGN - BRIDGE/STRUCTURE DESIGN CIVIL/SITE DESIGN - GIS/GPS - CONSTRUCTION OBSERVATION</small>	

EXISTING BRIDGE NO. 72
 1 @ 41'-6" SPAN, 19'0" CLEAR WIDTH
 TIMBER FLOOR ON STEEL GIRDERS

PROPOSED BRIDGE
 1 @ 55' SPAN 21" CORED SLAB
 24'-10" CLEAR WIDTH
 STA. 12+71.50
 SKEW = 90
 C GRADE ELEV. = 17.21'

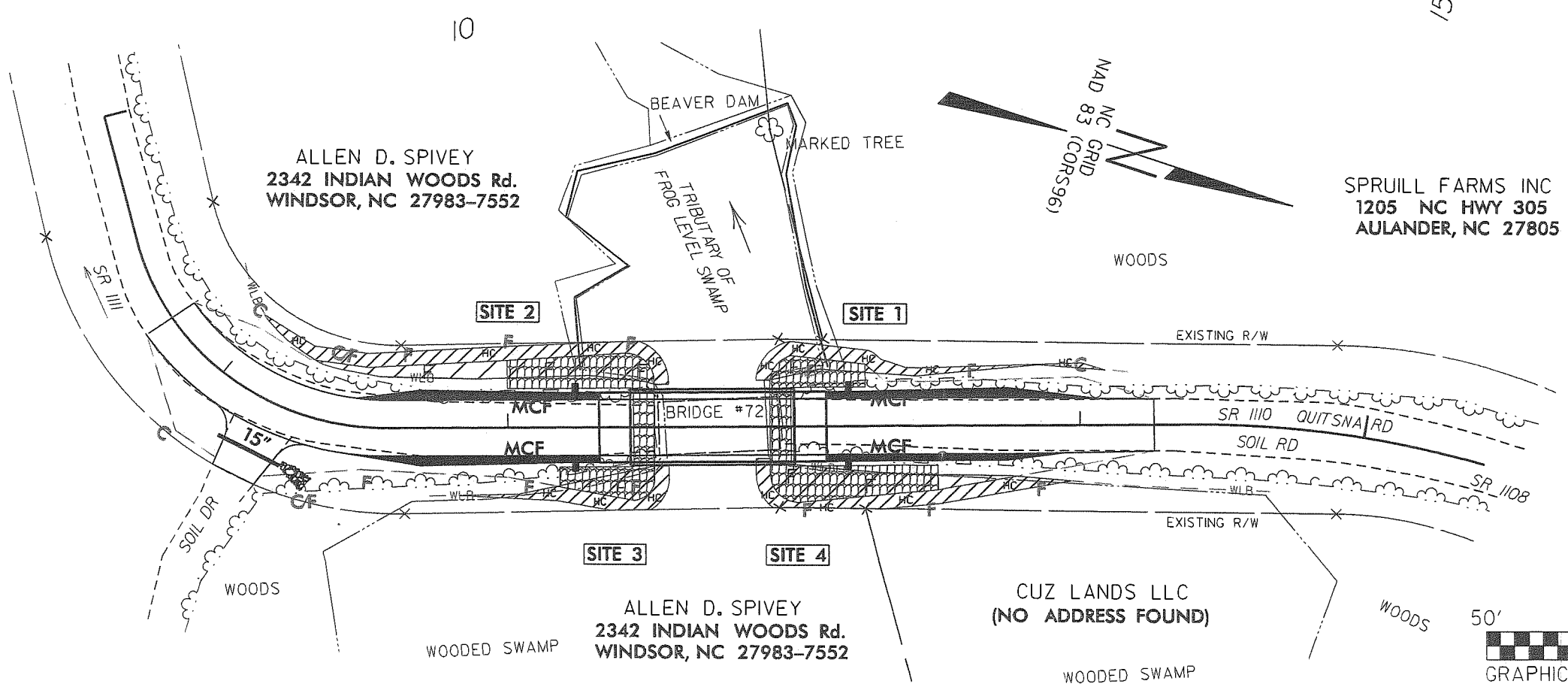
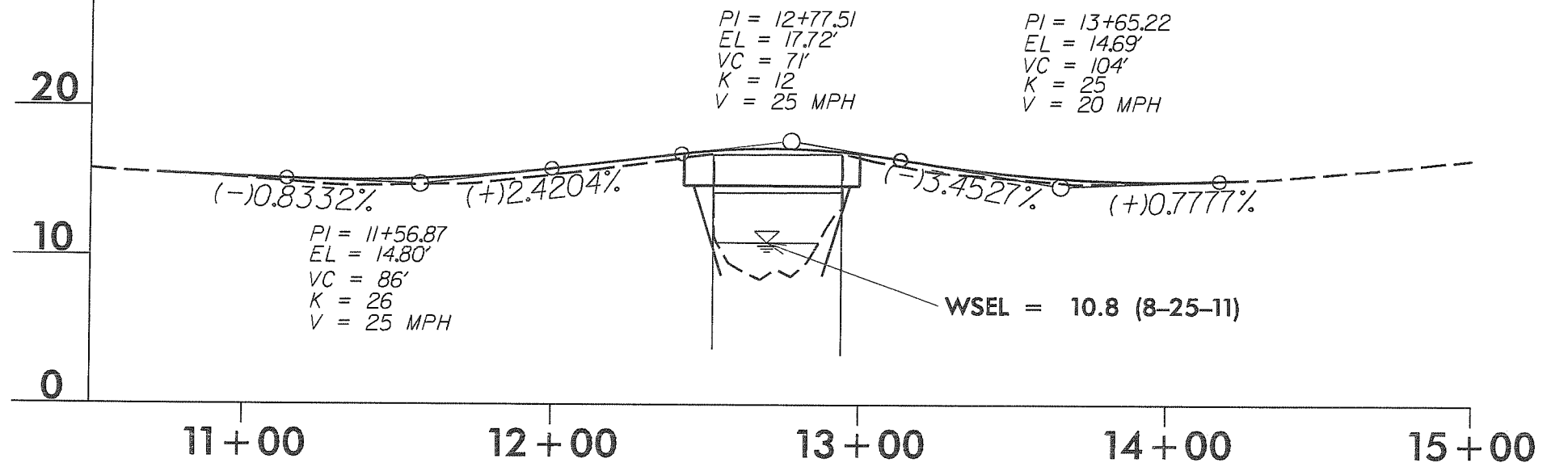

	WETLAND IMPACTS	SURFACE WATER IMPACTS	TEMP WETLAND IMPACTS (HAND CLEARING)	EXISTING CHANNEL IMPACTS
SITE 1	154 SF	0	375 SF	0
SITE 2	650 SF	0	709 SF	0
SITE 3	216 SF	0	300 SF	0
SITE 4	625 SF	0	557 SF	0

NOTE: ALL IMPACTED WETLANDS ARE COE-404 WETLANDS.

- NOTES:
- 1) MODIFIED METHOD II CLEARING (HAND CLEARING)
 - 2) LOCATED IN A CAMA COUNTY
 - 3) ROANOKE RIVER BASIN
 - 4) TRIBUTARY OF FROG LEVEL SWAMP IS A BLUE LINE ON THE USGS QUAD MAP

DENOTES FILL IN WETLAND
 DENOTES HAND CLEARING

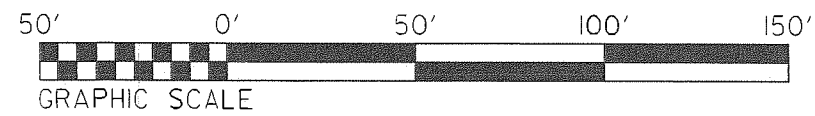

REVISIONS

85907 AM
 8/20/11 10:50
 12/22/2011
 t:\BD51011_permit.psh_50 Scale.dgn
 t:\BD51011\Hydraulics\Environmental Permi