

**ISOMETRIC VIEW**

■ PAY LIMITS FOR CURB RAMP

- NOTES:
1. DETECTABLE WARNING DOMES WILL COVER 2'-0" LENGTH AND FULL WIDTH OF THE RAMP FLOOR AS SHOWN ON THE DETAILS.
  2. DETECTABLE WARNING DOMES WILL CONTRAST VISIBILITY WITH ADJOINING SURFACE, EITHER LIGHT-ON-DARK, OR DARK-ON-LIGHT SEQUENCE COVERING THE ENTIRE RAMP.

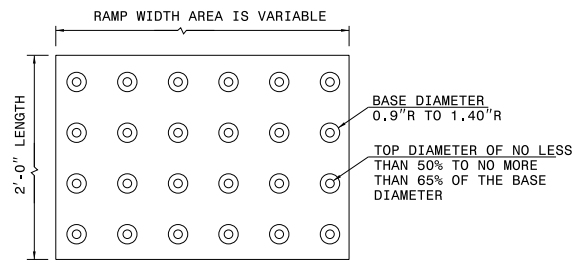

W	A	W+A+9"	X	B
5'	0.0'	5.8'	5.8'	5.0'*
6'	0.0'	6.8'	6.8'	6.0'***
7'	0.0'	7.8'	7.3'	6.5'***
8'	0.0'	8.8'	7.3'	6.5'***
5'	2.0'	7.8'	7.8'	5.0'
5'	2.5'	8.3'	8.1'	4.8'
5'	3.0'	8.8'	8.3'	4.4'
5'	3.5'	9.3'	8.4'	4.1'
5'	4.0'	9.8'	8.6'	3.8'
5'	4.5'	10.3'	8.7'	3.4'
5'	5.0'	10.8'	8.9'	3.1'

$B = X - (A + 9")$   
 B = DISTANCE FROM FRONT EDGE OF SIDEWALK TO BACK POINT OF 12:1 (8.33%) SLOPE.  
 \* BACK OF SIDEWALK DROP REQUIRED FOR ALL SIDEWALK SLOPES.  
 \*\* BACK OF SIDEWALK DROP REQUIRED FOR SIDEWALK SLOPES 0.04.

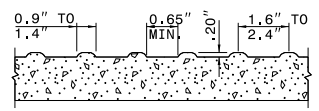

**DETECTABLE WARNING DOMES**

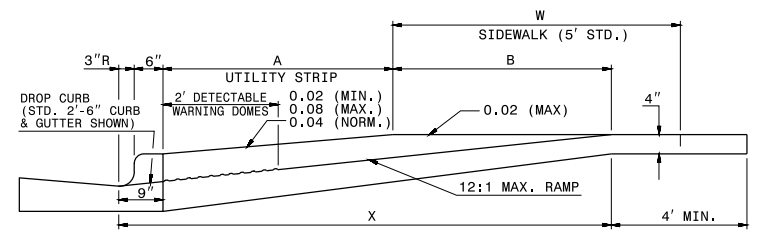

**SECTION B-B**

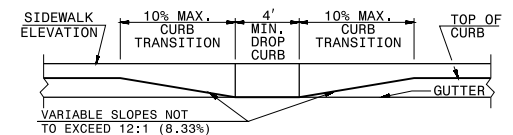

**SECTION A-A**

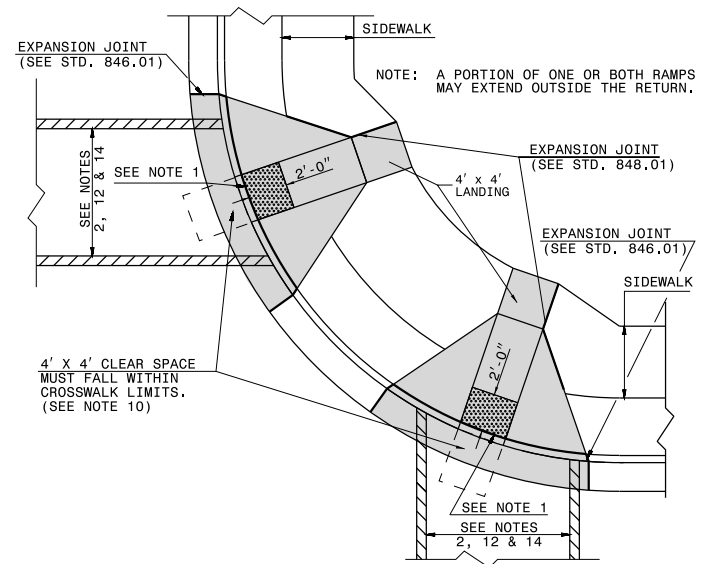

**PLAN VIEW**

DUAL RAMPS  
ANY RADIUS  
(4' MIN. FLOOR WIDTH)

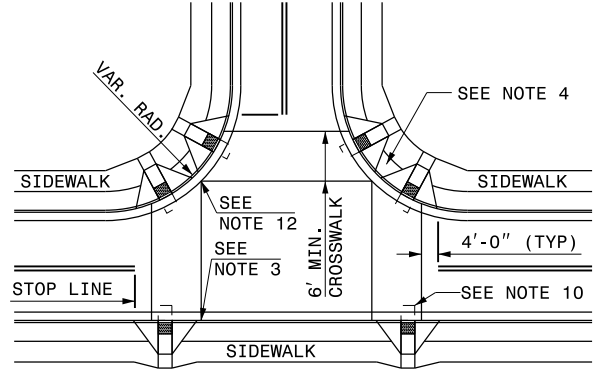

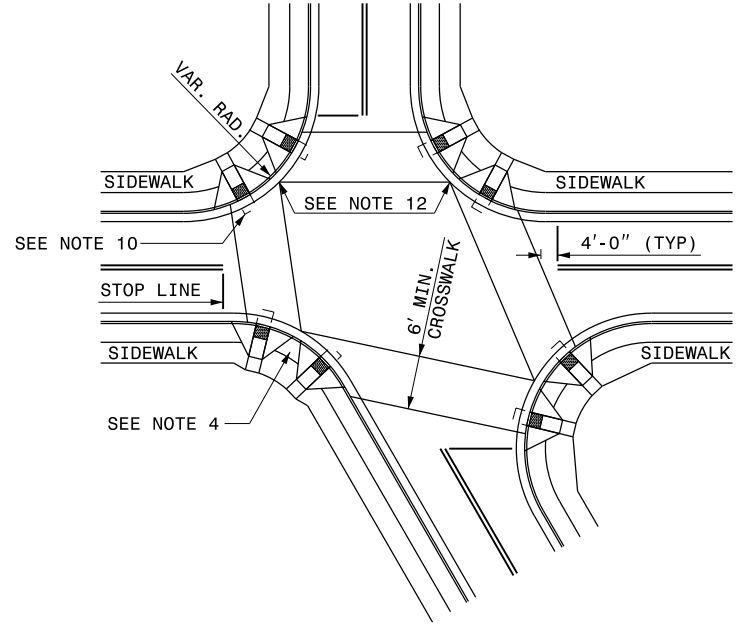

DETAIL SHOWING TYPICAL LOCATION OF CURB RAMPS, PEDESTRIAN CROSSWALKS AND STOP LINES FOR TEE INTERSECTIONS



DETAIL SHOWING TYPICAL LOCATION OF CURB RAMPS, PEDESTRIAN CROSSWALKS AND STOP LINES

ROADWAY PLAN SYMBOL  
  
 FOR PROPOSED CURB RAMP

 PROPOSED CURB RAMP W/ LANDING  
 PROPOSED OR FUTURE SIDEWALK

ALLOWABLE LOCATIONS  
 .....  
 DUAL RAMP RADII.....ANY

NOTES:

1. CONSTRUCT THE RAMP SURFACE TO BE STABLE, FIRM, SLIP RESISTANT AND MUST CONTRAST VISIBLY TO THE ADJACENT SURFACE.
2. CROSSWALK WIDTHS AND CONFIGURATION VARY BUT MUST CONFORM TO TRAFFIC DESIGN STANDARDS.
3. NORTH CAROLINA GENERAL STATUTE 136-44.14 REQUIRES THAT ALL STREET CURBS BEING CONSTRUCTED OR RECONSTRUCTED FOR MAINTENANCE PROCEDURES, TRAFFIC OPERATIONS, REPAIRS, CORRECTION OF UTILITIES OR ALTERED FOR ANY REASON AFTER SEPTEMBER 1, 1973 SHALL PROVIDE CURB RAMPS FOR THE PHYSICALLY DISABLED AT ALL INTERSECTIONS WHERE BOTH CURB AND GUTTER AND SIDEWALKS ARE PROVIDED AND AT OTHER POINTS OF PEDESTRIAN FLOW.

IN ADDITION, SECTION 228 OF THE 1973 FEDERAL AID HIGHWAY SAFETY ACT REQUIRES PROVISION OF CURB RAMPS ON ANY CURB CONSTRUCTION AFTER JULY 1, 1976 WHETHER A SIDEWALK IS PROPOSED INITIALLY OR IS PLANNED FOR A FUTURE DATE.

THE AMERICANS WITH DISABILITIES ACT (ADA) OF 1990 EXTENDS TO INDIVIDUALS WITH DISABILITIES. COMPREHENSIVE CIVIL RIGHTS PROTECTIONS SIMILAR TO THOSE PROVIDED TO PERSONS ON THE BASIS OF RACE, SEX, NATIONAL ORIGIN AND RELIGION UNDER THE CIVIL RIGHTS ACT OF 1964. THESE CURB RAMPS HAVE BEEN DESIGNED TO COMPLY WITH THE CURRENT ADA STANDARDS.

4. PROVIDE CURB RAMPS AT LOCATIONS AS SHOWN ON THE PLANS OR AS DIRECTED BY THE ENGINEER. LOCATE CURB RAMPS AS DIRECTED BY THE ENGINEER WHERE EXISTING LIGHT POLES, FIRE HYDRANTS, DROP INLETS, ETC. AFFECT PLACEMENT. PLACE DUAL RAMPS PERPENDICULAR TO THE TRAVEL LANE OR AS DIRECTED BY THE ENGINEER.
5. DO NOT EXCEED 0.08 (12:1) SLOPE ON THE RAMP.
6. CONSTRUCT CURB RAMPS A MINIMUM OF 4' FOR SINGLE RAMPS.
7. PLACE A 1/2" EXPANSION JOINT WHERE THE CONCRETE CURB RAMP JOINS THE CURB AND AS SHOWN ON STD. DWG. 848.01.
8. PLACE THE INSIDE PEDESTRIAN CROSSWALK LINES NO CLOSER IN THE INTERSECTION BY BISECTING THE INTERSECTION RADIUS, WITH ALLOWANCE OF A 4' CLEAR ZONE IN THE VEHICULAR TRAVELWAY WHEN ONE RAMP IS INSTALLED. (SEE NOTE 14)
9. COORDINATE THE CURB CUT AND THE PEDESTRIAN CROSSWALK LINES SO THE 4' X 4' CLEAR SPACE AT THE BASE OF THE CURB RAMP WILL FALL WITHIN THE PEDESTRIAN CROSSWALK LINES.
10. CONSTRUCT THE PEDESTRIAN CROSSWALK A MINIMUM OF 6 FEET IN WIDTH. A CROSSWALK WIDTH OF 10 FEET OR GREATER IS DESIRABLE.
11. USE STOP LINES, NORMALLY PERPENDICULAR TO THE LANE LINES, WHERE IT IS IMPORTANT TO INDICATE THE POINT BEHIND WHICH VEHICLES ARE REQUIRED TO STOP IN COMPLIANCE WITH A TRAFFIC SIGNAL, STOP SIGN OR OTHER LEGAL REQUIREMENT. AN UNUSUAL APPROACH SKEW MAY REQUIRE THE PLACEMENT OF THE STOP LINE TO BE PARALLEL TO THE INTERSECTING ROADWAY.
12. TERMINATE PARKING A MINIMUM OF 20 FEET BACK OF PEDESTRIAN CROSSWALK.
13. PLACE ALL PAVEMENT MARKINGS IN ACCORDANCE WITH THE LATEST EDITION OF THE MANUAL OF UNIFORM TRAFFIC CONTROL DEVICES (MUTCD) PUBLISHED BY THE FEDERAL HIGHWAY ADMINISTRATION AND THE NORTH CAROLINA SUPPLEMENT TO THE MUTCD.
14. CONSTRUCT ALL RAMPS SURFACES TO COMPLY WITH SECTIONS R301 AND R303.3.3 OF THE REVISED ADA GUIDELINES.
15. CONSTRUCT ALL RAMPS AND SIDEWALKS WITH A 2% MAXIMUM CROSS SLOPE.
16. PLACE ALL PEDESTRIAN PUSH BUTTON ACTUATORS AND CROSSING SIGNALS AS SHOWN IN THE PLANS OR AS SHOWN IN THE MUTCD.
17. CONSTRUCT ALL SIDE FLARES FOR CURB RAMPS WITH SLOPES NO GREATER THAN 10%.
18. CURB RAMPS THROUGH MEDIAN ISLANDS OR OTHER UNIQUE SITUATIONS, WILL BE HANDLED BY SPECIAL DETAILS. CONTACT THE NCDOT CONTRACT STANDARDS AND DEVELOPMENT SECTION FOR THE DETAILS OR FOR A SPECIAL DESIGN.

STATE OF NORTH CAROLINA  
DEPT. OF TRANSPORTATION  
DIVISION OF HIGHWAYS  
RALEIGH, N.C.

ENGLISH STANDARD DRAWING FOR

**CURB RAMPS**

NOTES

STATE OF NORTH CAROLINA  
DEPT. OF TRANSPORTATION  
DIVISION OF HIGHWAYS  
RALEIGH, N.C.

ENGLISH STANDARD DRAWING FOR

**CURB RAMPS**

NOTES

**CURB RAMP AND EXISTING SIDEWALK WITH GRASS STRIP**

STATE OF NORTH CAROLINA  
DEPT. OF TRANSPORTATION  
DIVISION OF HIGHWAYS  
RALEIGH, N.C.

ENGLISH STANDARD DRAWING FOR  
**CURB RAMP**  
EXISTING CURB AND GUTTER

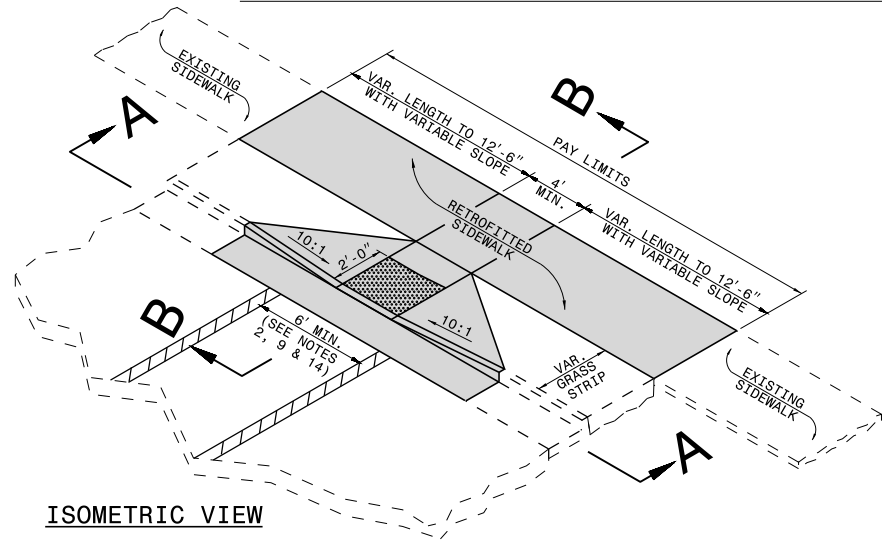

**ISOMETRIC VIEW**

PAY LIMITS OF CURB RAMP

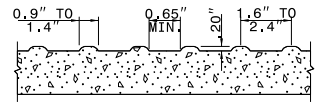
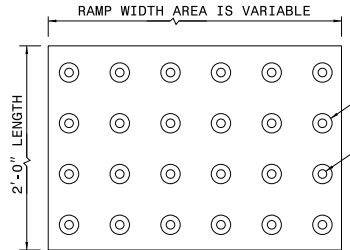

**DETECTABLE WARNING DOMES**

- NOTES:
1. PLACE DETECTABLE WARNING DOMES TO COVER 2'-0" LENGTH AND FULL WIDTH OF THE RAMP FLOOR AS SHOWN ON THE DETAILS.
  2. OBTAIN VISIBLE CONTRAST WITH ADJOINING SURFACE, EITHER LIGHT-ON-DARK, OR DARK-ON-LIGHT SEQUENCE COVERING THE ENTIRE RAMP.

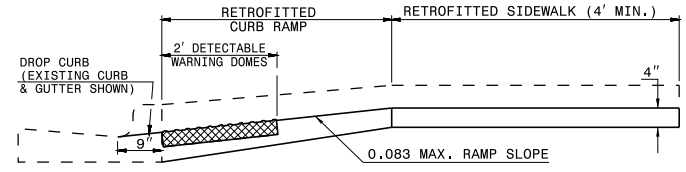

**SECTION B-B**

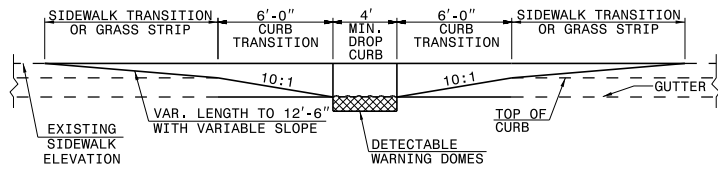

**SECTION A-A**

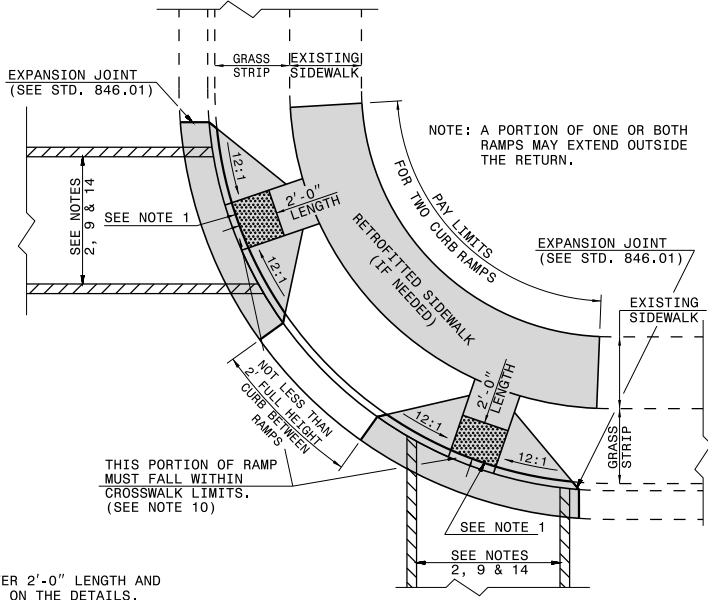

**PLAN VIEW**

DUAL RAMPS  
ANY RADII  
(40" MIN. FLOOR WIDTH)

STATE OF NORTH CAROLINA  
DEPT. OF TRANSPORTATION  
DIVISION OF HIGHWAYS  
RALEIGH, N.C.

ENGLISH STANDARD DRAWING FOR  
**CURB RAMP**  
EXISTING CURB AND GUTTER

**CURB RAMPS AND EXISTING SIDEWALK ADJACENT TO CURB**

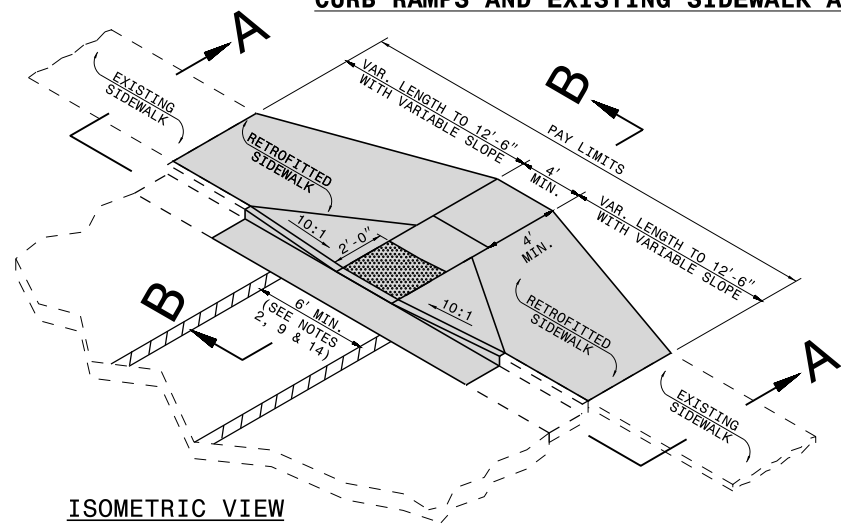

**ISOMETRIC VIEW**

PAY LIMITS OF CURB RAMP

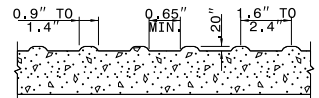
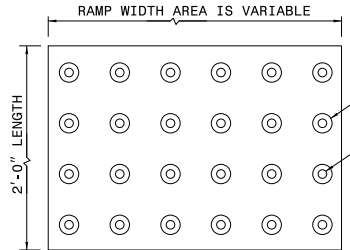

BASE DIAMETER  
0.90" R TO 1.40" R

TOP DIAMETER OF NO LESS  
THAN 50% TO NO MORE  
THAN 65% OF THE BASE  
DIAMETER

- NOTES:
1. PLACE DETECTABLE WARNING DOMES TO COVER 2'-0" LENGTH AND FULL WIDTH OF THE RAMP FLOOR AS SHOWN ON THE DETAILS.
  2. OBTAIN VISIBLE CONTRAST WITH ADJOINING SURFACE, EITHER LIGHT-ON-DARK, OR DARK-ON-LIGHT SEQUENCE COVERING THE ENTIRE RAMP.

**DETECTABLE WARNING DOMES**

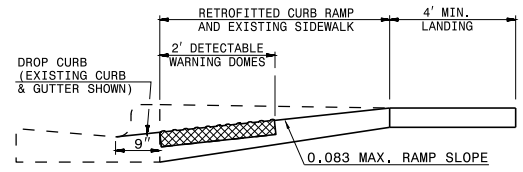

**SECTION B-B**

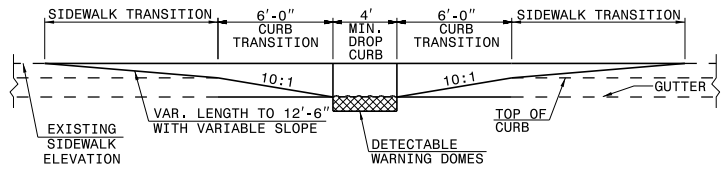

**SECTION A-A**

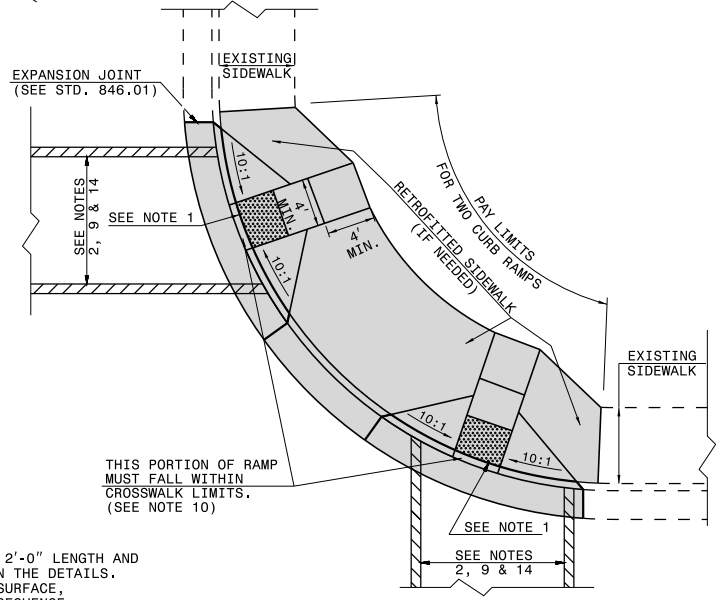

**PLAN VIEW**

DUAL RAMPS  
ANY RADII  
(40" MIN. FLOOR WIDTH)

STATE OF NORTH CAROLINA  
DEPT. OF TRANSPORTATION  
DIVISION OF HIGHWAYS  
RALEIGH, N.C.

1-12

ENGLISH STANDARD DRAWING FOR

**CURB RAMP**

EXISTING CURB AND GUTTER

STATE OF NORTH CAROLINA  
DEPT. OF TRANSPORTATION  
DIVISION OF HIGHWAYS  
RALEIGH, N.C.

1-12

ENGLISH STANDARD DRAWING FOR

**CURB RAMP**

EXISTING CURB AND GUTTER

**RETROFITTING DETECTABLE WARNING DOMES ONTO EXISTING CURB RAMP**

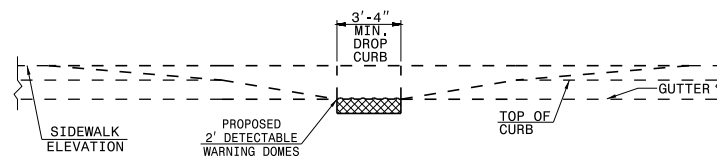
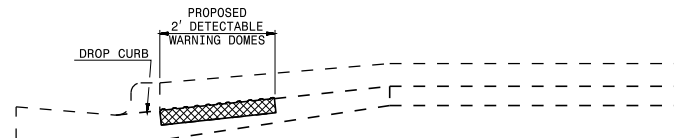
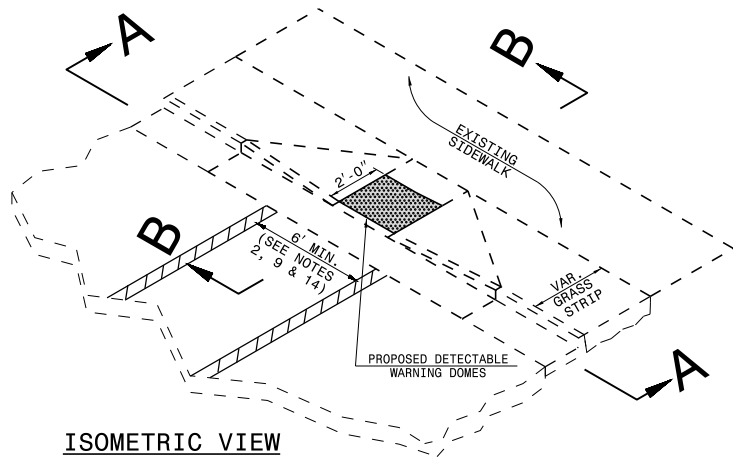

PAY LIMITS OF RETROFIT CURB RAMP

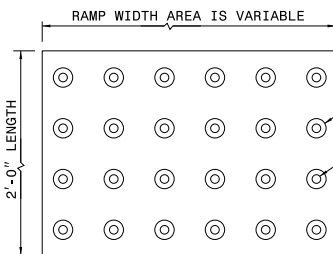

BASE DIAMETER 0.90" R TO 1.40" R

TOP DIAMETER OF NO LESS THAN 50% TO NO MORE THAN 65% OF THE BASE DIAMETER

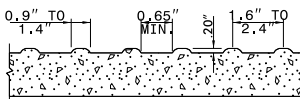

- NOTES:
1. PLACE DETECTABLE WARNING DOMES TO COVER 2'-0" LENGTH AND FULL WIDTH OF THE RAMP FLOOR AS SHOWN ON THE DETAILS.
  2. OBTAIN VISIBLE CONTRAST WITH ADJOINING SURFACE, EITHER LIGHT-ON-DARK, OR DARK-ON-LIGHT SEQUENCE COVERING THE ENTIRE RAMP.

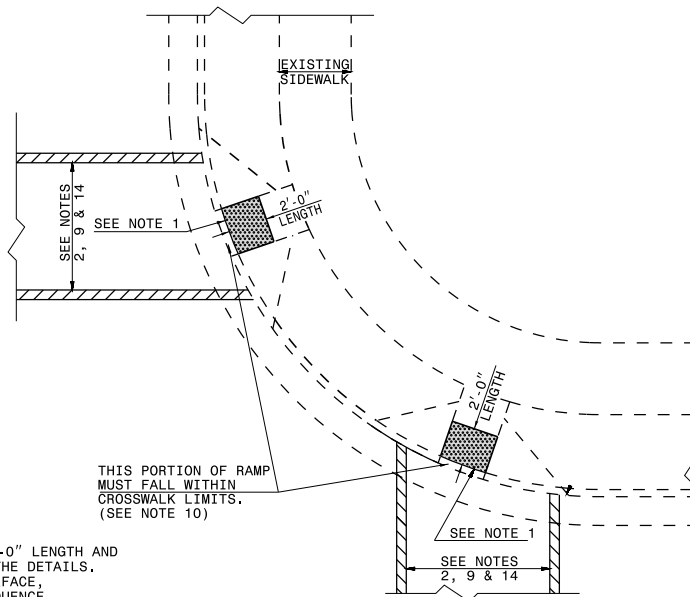

PLAN VIEW

DUAL RAMPS ANY RADII (40" MIN. FLOOR WIDTH)

**CURB RAMPS AND EXISTING SIDEWALK**

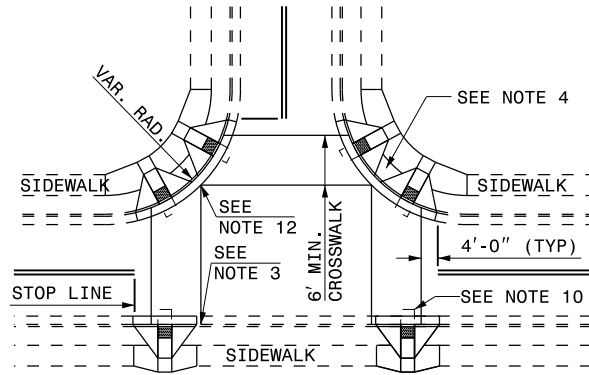

DETAIL SHOWING TYPICAL LOCATION OF CURB RAMPS,  
PEDESTRIAN CROSSWALKS AND STOP LINES FOR TEE INTERSECTIONS

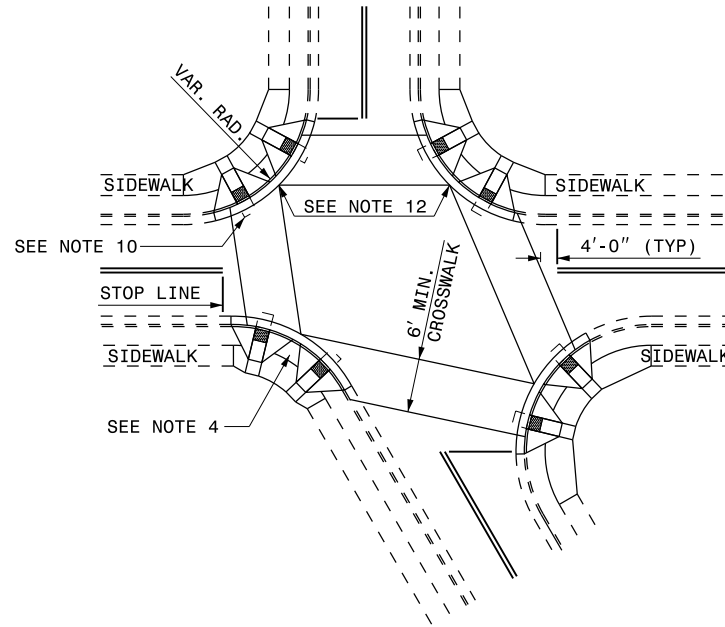

DETAIL SHOWING TYPICAL LOCATION OF CURB  
RAMPS, PEDESTRIAN CROSSWALKS AND STOP LINES

**RESURFACING PROJECTS**

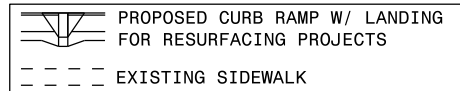

ALLOWABLE LOCATIONS  
 .....  
 DUAL RAMP RADII.....ANY

STATE OF NORTH CAROLINA  
 DEPT. OF TRANSPORTATION  
 DIVISION OF HIGHWAYS  
 RALEIGH, N.C.

**1-12**

ENGLISH STANDARD DRAWING FOR  
**CURB RAMP**  
 EXISTING CURB AND GUTTER

SHEET 4 OF 5

**848.06**

STATE OF NORTH CAROLINA  
 DEPT. OF TRANSPORTATION  
 DIVISION OF HIGHWAYS  
 RALEIGH, N.C.

**1-12**

ENGLISH STANDARD DRAWING FOR  
**CURB RAMP**  
 EXISTING CURB AND GUTTER

SHEET 4 OF 5

**848.06**

**CURB RAMP AND EXISTING SIDEWALK**

NOTES:

1. CONSTRUCT THE WALKING SURFACE WITH SLIP RESISTANCE AND A VISIBLE CONTRAST TO THE ADJACENT SURFACES.
2. CROSSWALK WIDTHS AND CONFIGURATION VARY, BUT MUST CONFORM TO TRAFFIC DESIGN STANDARDS.
3. NORTH CAROLINA GENERAL STATUTE 136-44.14 REQUIRES THAT ALL STREET CURBS BEING CONSTRUCTED OR RECONSTRUCTED FOR MAINTENANCE PROCEDURES, TRAFFIC OPERATIONS, REPAIRS, CORRECTION OF UTILITIES OR ALTERED FOR ANY REASON AFTER SEPTEMBER 1, 1973 SHALL PROVIDE CURB RAMPS FOR THE PHYSICALLY DISABLED AT ALL INTERSECTIONS WHERE BOTH CURB AND GUTTER AND SIDEWALKS ARE PROVIDED AND AT OTHER POINTS OF PEDESTRIAN FLOW.

IN ADDITION, SECTION 228 OF THE 1973 FEDERAL AID HIGHWAY SAFETY ACT REQUIRES PROVISION OF CURB RAMPS ON ANY CURB CONSTRUCTION AFTER JULY 1, 1976 WHETHER A SIDEWALK IS PROPOSED INITIALLY OR IS PLANNED FOR A FUTURE DATE.

THE AMERICANS WITH DISABILITIES ACT (ADA) OF 1990 EXTENDS TO INDIVIDUALS WITH DISABILITIES, COMPREHENSIVE CIVIL RIGHTS PROTECTIONS SIMILAR TO THOSE PROVIDED TO PERSONS ON THE BASIS OF RACE, SEX, NATIONAL ORIGIN AND RELIGION UNDER THE CIVIL RIGHTS ACT OF 1964. THESE CURB RAMPS HAVE BEEN DESIGNED TO COMPLY WITH THE CURRENT ADA STANDARDS.

4. PROVIDE CURB RAMPS AT LOCATIONS AS SHOWN ON THE PLANS OR AS DIRECTED BY THE ENGINEER. LOCATE CURB RAMPS AS DIRECTED BY THE ENGINEER WHERE EXISTING LIGHT POLES, FIRE HYDRANTS, DROP INLETS, ETC. AFFECT PLACEMENT. WHERE TWO RAMPS ARE INSTALLED PLACE NOT LESS THAN 2 FEET OF FULL HEIGHT CURB BETWEEN THE RAMPS. PLACE DUAL RAMPS AS NEAR PERPENDICULAR TO THE TRAVEL LANE BEING CROSSED AS POSSIBLE.
5. DO NOT EXCEED 0.083 (12:1) SLOPE ON THE CURB RAMP IN RELATIONSHIP TO THE GRADE OF THE STREET.
6. CONSTRUCT CURB RAMPS 48" (4') OR GREATER.
7. PLACE A 1/2" EXPANSION JOINT WHERE THE CONCRETE CURB RAMP JOINS THE CURB AND AS SHOWN ON STD. DWG. 848.01.
8. PLACE THE INSIDE PEDESTRIAN CROSSWALK LINES NO CLOSER IN THE INTERSECTION BY BISECTING THE INTERSECTION RADIUS, WITH ALLOWANCE OF A 4' CLEAR ZONE IN THE VEHICULAR TRAVELWAY WHEN ONE RAMP IS INSTALLED. (SEE NOTE 14)
9. COORDINATE THE CURB CUT AND THE PEDESTRIAN CROSSWALK LINES SO THE 4' X 4' CLEAR SPACE AT THE BASE OF THE CURB RAMP WILL FALL WITHIN THE PEDESTRIAN CROSSWALK LINES.
10. CONSTRUCT THE PEDESTRIAN CROSSWALK A MINIMUM OF 6 FEET IN WIDTH. A CROSSWALK WIDTH OF 10 FEET OR GREATER IS DESIRABLE.
11. USE STOP LINES, NORMALLY PERPENDICULAR TO THE LANE LINES, WHERE IT IS IMPORTANT TO INDICATE THE POINT BEHIND WHICH VEHICLES ARE REQUIRED TO STOP IN COMPLIANCE WITH A TRAFFIC SIGNAL, STOP SIGN OR OTHER LEGAL REQUIREMENT. AN UNUSUAL APPROACH SKEW MAY REQUIRE THE PLACEMENT OF THE STOP LINE TO BE PARALLEL TO THE INTERSECTING ROADWAY.
12. TERMINATE PARKING A MINIMUM OF 20 FEET BACK OF PEDESTRIAN CROSSWALK.
13. PLACE ALL PAVEMENT MARKINGS IN ACCORDANCE WITH THE LATEST EDITION OF THE MANUAL OF UNIFORM TRAFFIC CONTROL DEVICES (MUTCD) PUBLISHED BY THE FEDERAL HIGHWAY ADMINISTRATION AND THE NORTH CAROLINA SUPPLEMENT TO THE MUTCD.
14. CONSTRUCT ALL RAMPS SURFACES TO COMPLY WITH SECTIONS R301 AND R303.3.3 OF THE REVISED ADA GUIDELINES.
15. CONSTRUCT ALL RAMPS AND SIDEWALKS WITH A 2% MAXIMUM CROSS SLOPE.
16. PLACE ALL PEDESTRIAN PUSH BUTTON ACTUATORS AND CROSSING SIGNALS AS SHOWN IN THE PLANS OR AS SHOWN IN THE MUTCD.
17. CONSTRUCT ALL SIDE FLARES FOR CURB RAMPS WITH SLOPES NO GREATER THAN 10%.
18. CURB RAMPS THROUGH MEDIAN ISLANDS OR OTHER UNIQUE SITUATIONS, WILL BE HANDLED BY SPECIAL DETAILS. CONTACT THE NCDOT CONTRACT STANDARDS AND DEVELOPMENT SECTION FOR THE DETAILS OR FOR A SPECIAL DESIGN.

STATE OF NORTH CAROLINA  
DEPT. OF TRANSPORTATION  
DIVISION OF HIGHWAYS  
RALEIGH, N.C.

ENGLISH STANDARD DRAWING FOR  
**CURB RAMP**  
EXISTING CURB AND GUTTER

STATE OF NORTH CAROLINA  
DEPT. OF TRANSPORTATION  
DIVISION OF HIGHWAYS  
RALEIGH, N.C.

ENGLISH STANDARD DRAWING FOR  
**CURB RAMP**  
EXISTING CURB AND GUTTER



5/14/99

PROJECT REFERENCE NO. SHEET NO.

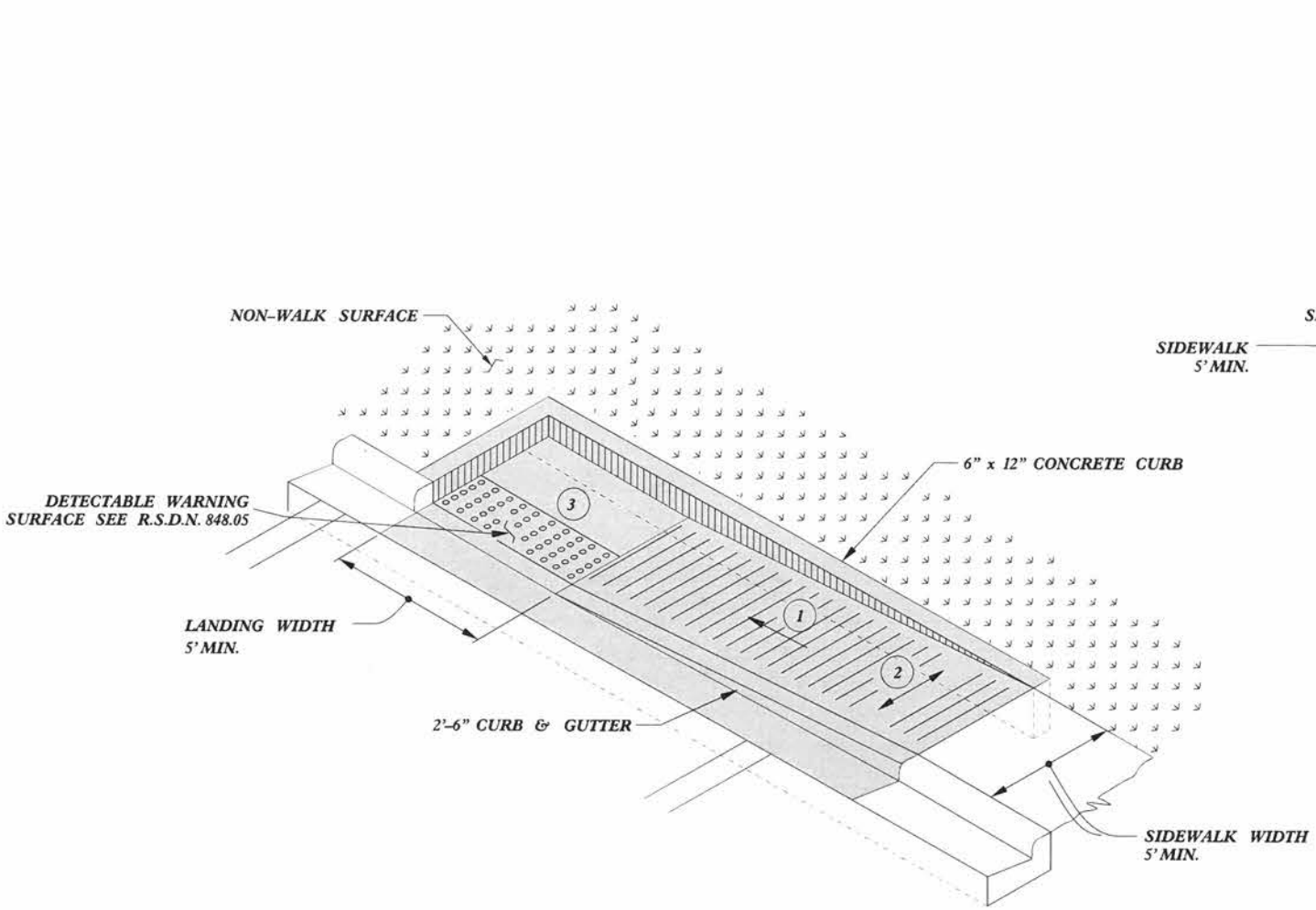

TYPE 1A

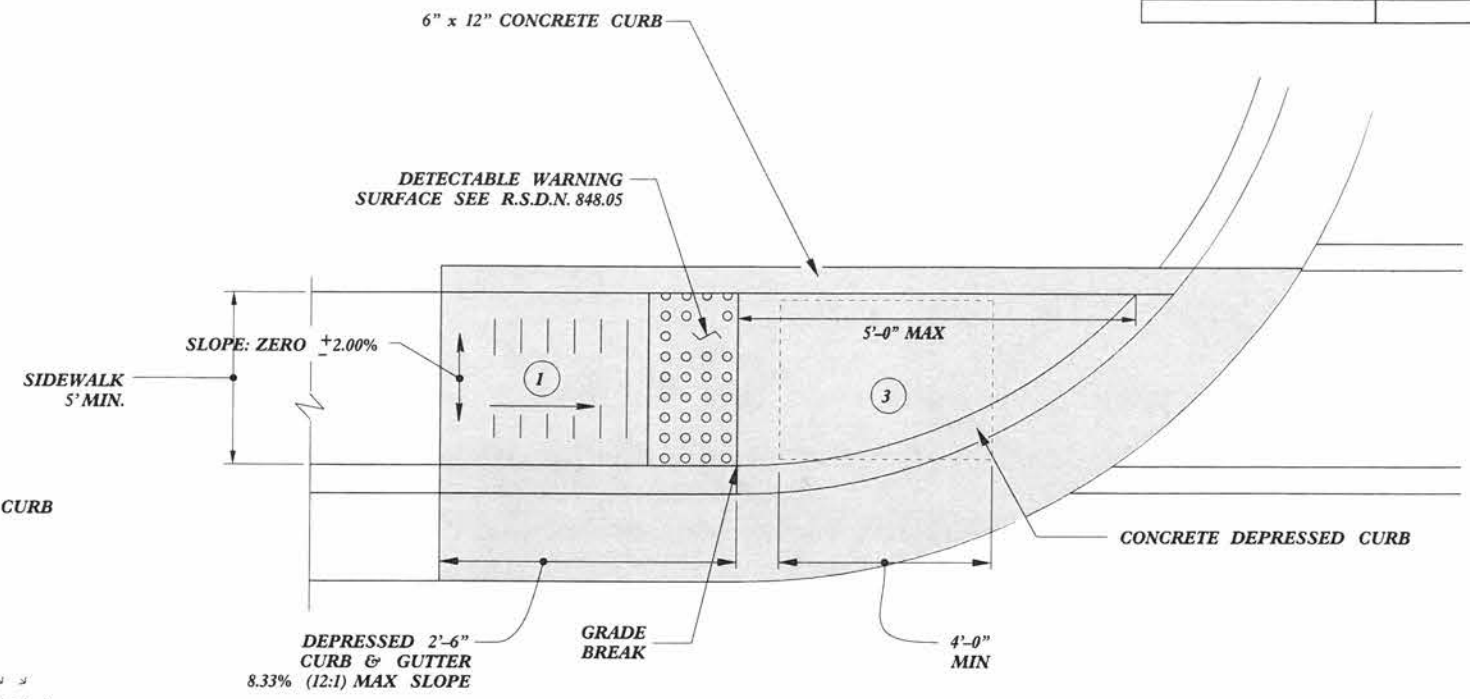

TYPE 1

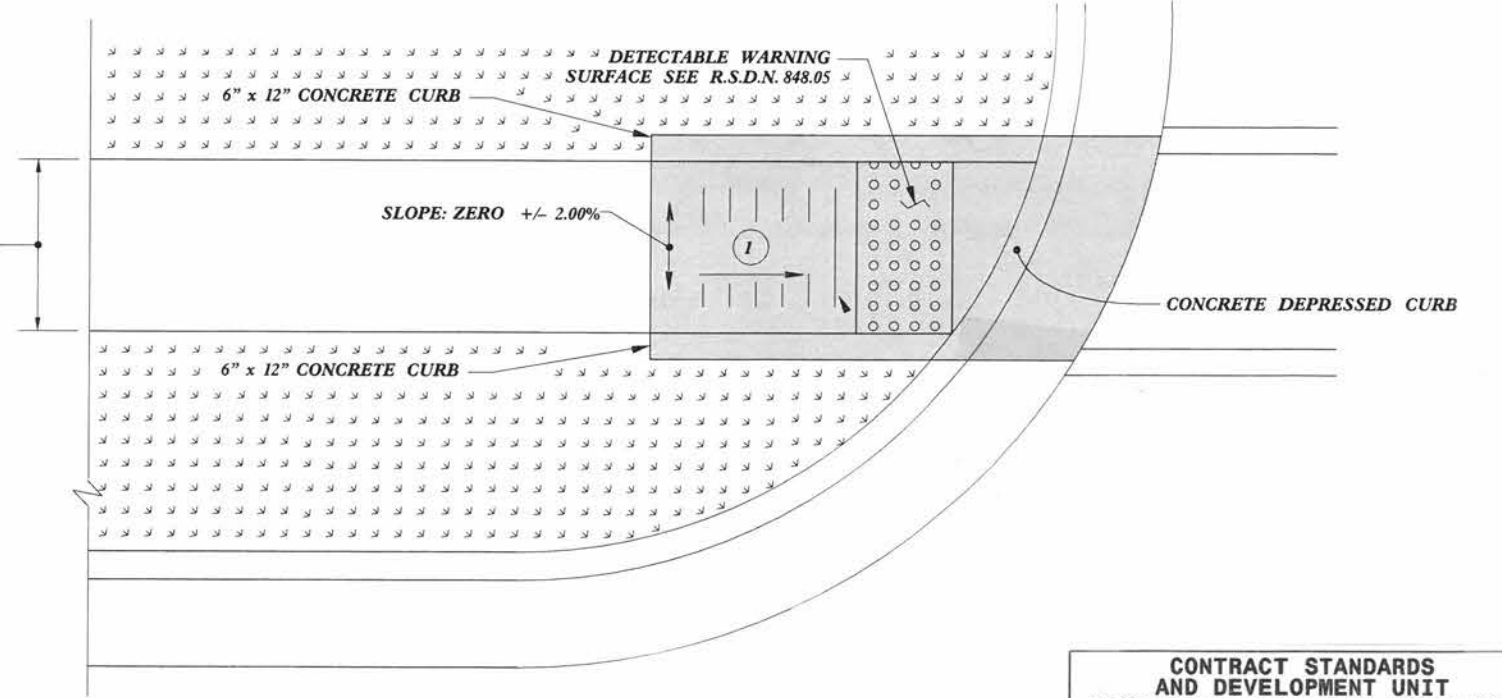

TYPE 1 Modified

- ① 8.33% (12:1) MAX RAMP SLOPE
- ② CROSS SLOPE: 2.00%
- ③ CURB RAMPS REQUIRE A (4'-0") MINIMUM LANDING WITH A MAXIMUM CROSS SLOPE AND LONGITUDINAL SLOPE OF 2.00% WHERE PEDESTRIANS PERFORM TURNING MANEUVERS. SLOPE TO DRAIN TO CURB.

PAY LIMITS FOR 1 CURB RAMP

REFER TO ROADWAY STANDARD DRAWING NUMBER 848.05 SHEET 3 OF 3 FOR ALL RAMP NOTES

<b>CONTRACT STANDARDS AND DEVELOPMENT UNIT</b>	
Office 919-707-6950 FAX 919-250-4119	
<b>CURB RAMPS</b>	
Directional Ramps	
ORIGINAL BY: J.S. HOWERTON	DATE: 7/7/11
MODIFIED BY:	DATE:
CHECKED BY:	DATE:
FILE SPEC: stds/2012CurbRamp/CurbRampDetails.dgn	

SYSTEM: PLT USER: JSH

 PAY LIMITS FOR 1 CURB RAMP

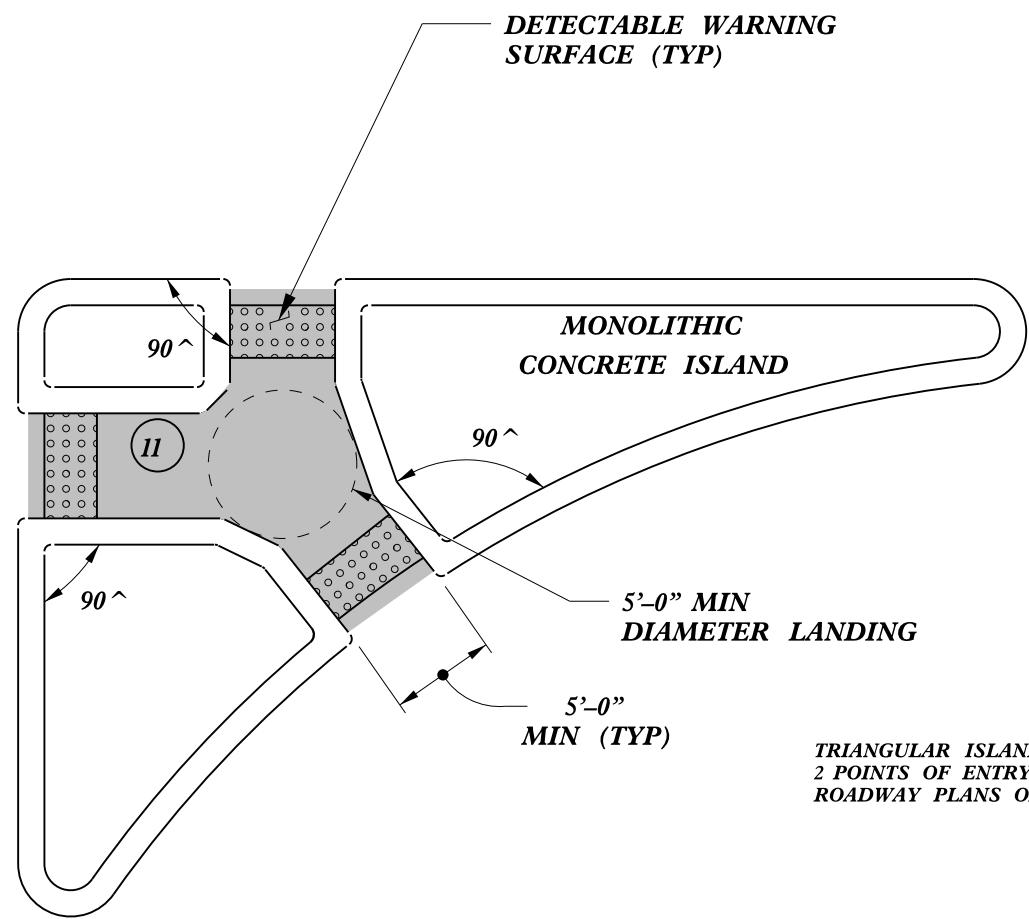

TRIANGULAR ISLANDS MAY BE CONSTRUCTED WITH ONLY 2 POINTS OF ENTRY AND EXIT AS SHOWN IN THE ROADWAY PLANS OR AS DIRECTED BY THE ENGINEER.

**TRIANGULAR ISLAND WITH CUT THROUGH**

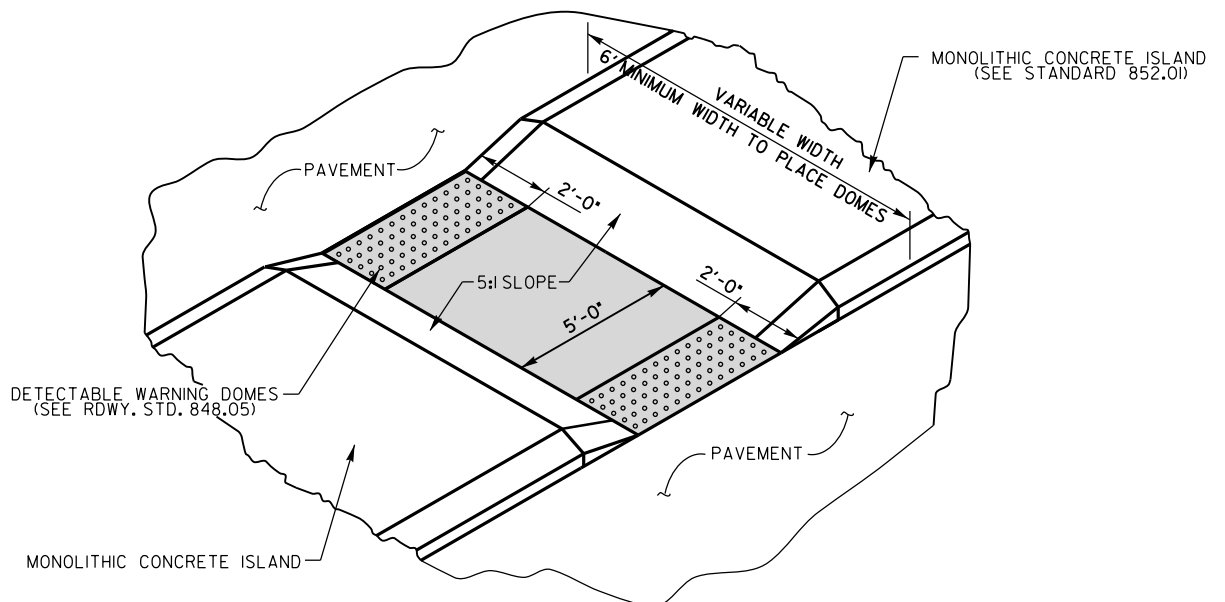

**MEDIAN ISLAND WITH CUT THROUGH**

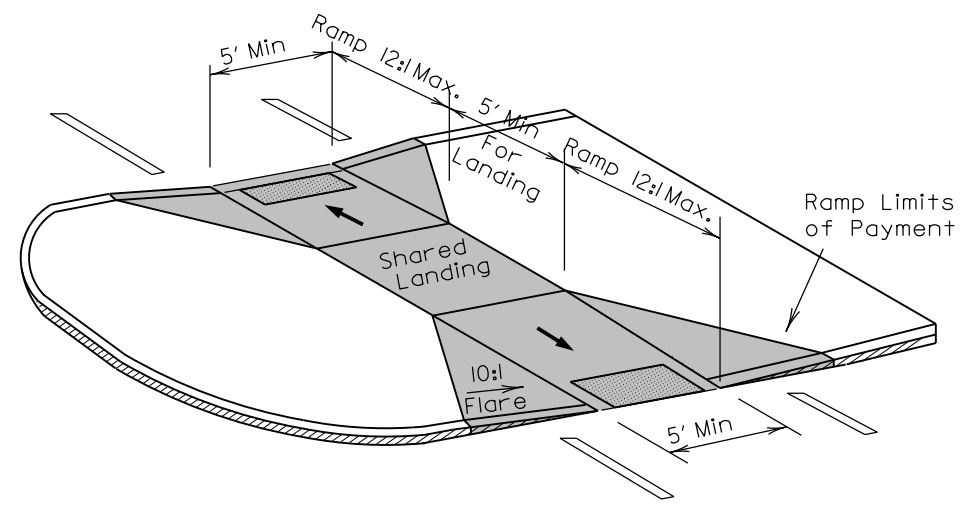

**MEDIAN ISLAND CURB RAMPS**

<b>CONTRACT STANDARDS AND DEVELOPMENT UNIT</b>	
Office 919-707-6950	FAX 919-250-4119
<b>CURB RAMPS</b>	
Median or Turn Lane Islands	
ORIGINAL BY: J.S. HOWERTON	DATE: 7/7/11
MODIFIED BY:	DATE:
CHECKED BY:	DATE:
FILE SPEC: s:\stds\2012CurbRamp\CurbRampDetails.dwg	

5/14/99  
 CONTRACT STANDARDS AND DEVELOPMENT UNIT  
 919-707-6950  
 919-250-4119  
 J.S. HOWERTON  
 7/7/11

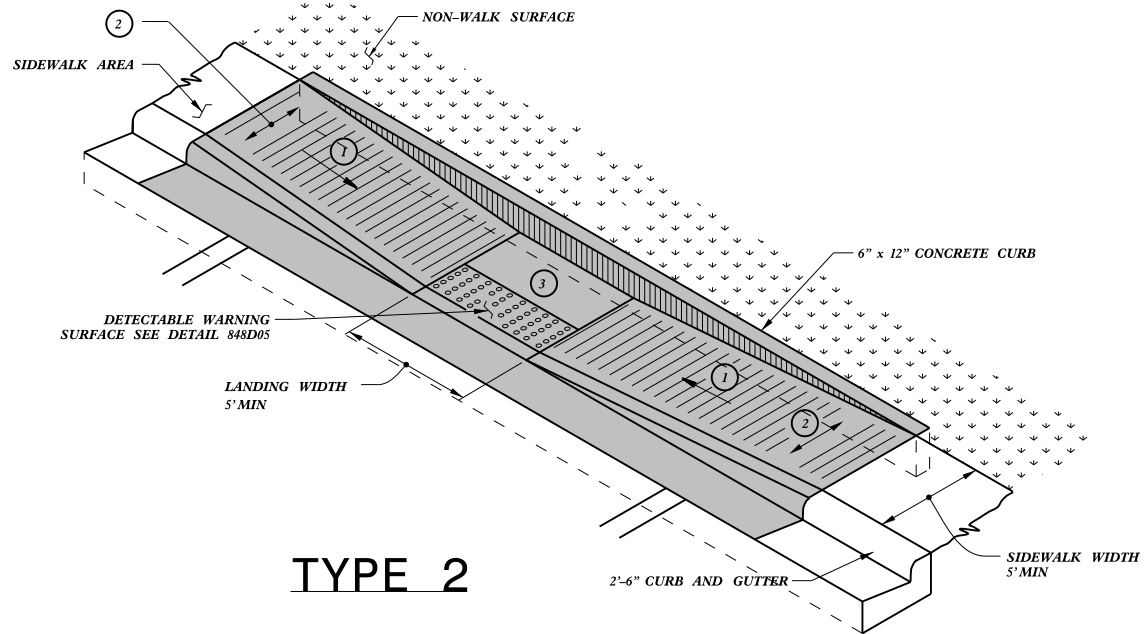

**TYPE 2**

PAY LIMITS FOR CURB RAMP

- ① 8.33% (12:1) MAX RAMP SLOPE
- ② CROSS SLOPE: 2.00%
- ③ CURB RAMPS REQUIRE A (4'-0") MINIMUM LANDING WITH A MAXIMUM CROSS SLOPE AND LONGITUDINAL SLOPE OF 2.00% WHERE PEDESTRIANS PERFORM TURNING MANEUVERS. SLOPE TO DRAIN TO CURB.

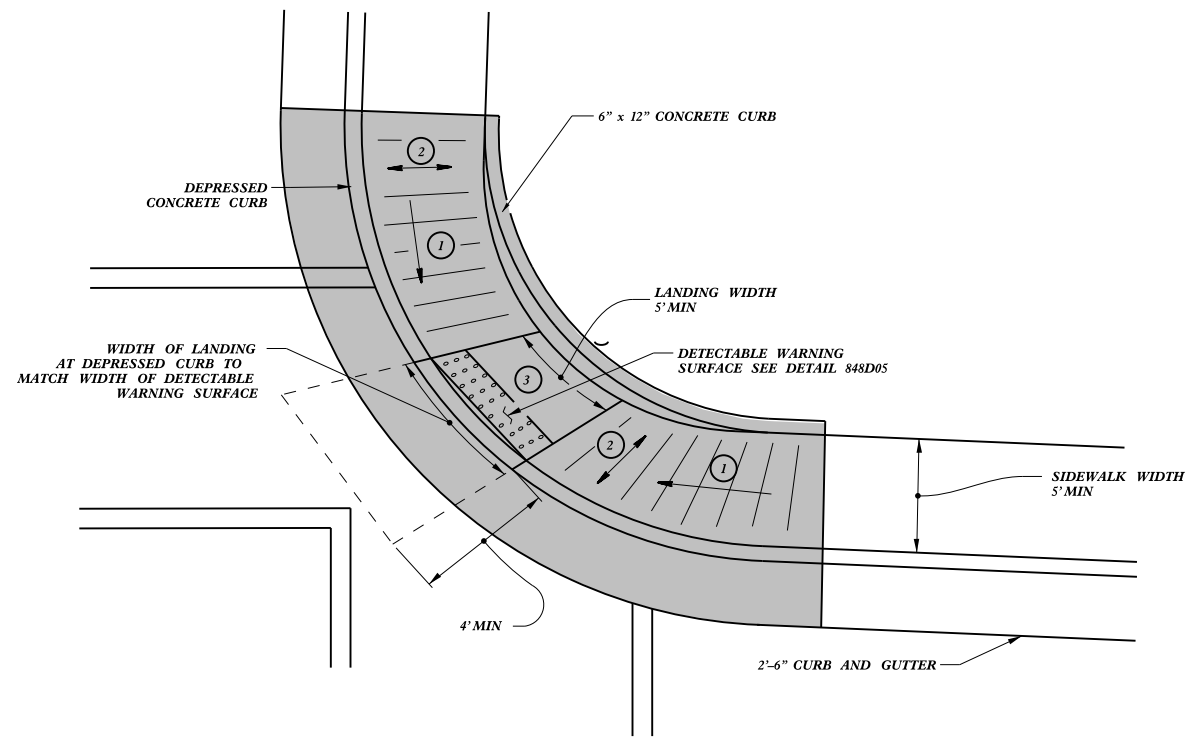

**TYPE 2A**

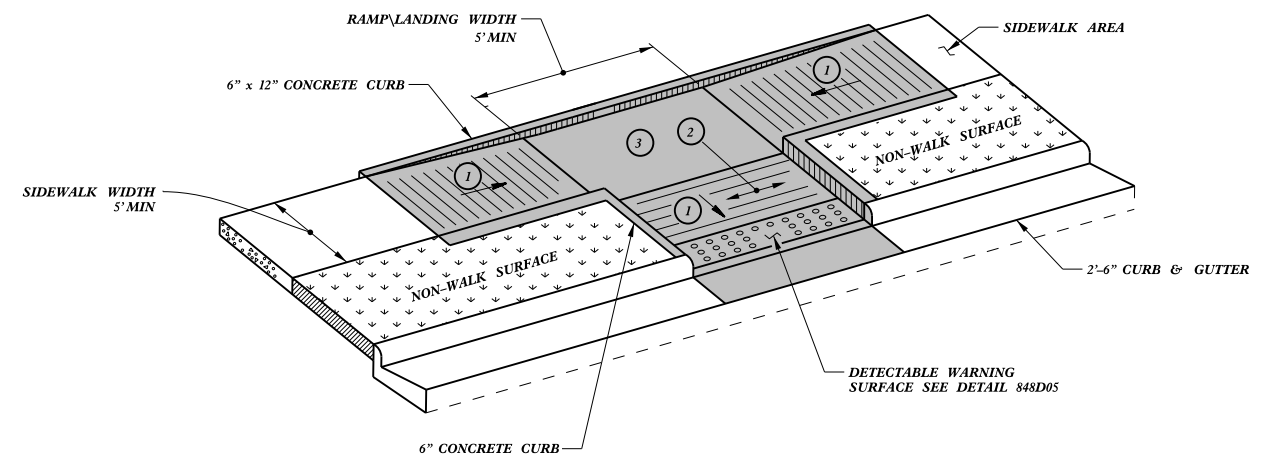

**TYPE 3**

<b>CONTRACT STANDARDS AND DEVELOPMENT UNIT</b>	
Office 919-707-6950	FAX 919-250-4119
<b>CURB RAMPS</b>	
Parallel Ramps	
ORIGINAL BY: J.S. HOWERTON	DATE: 7/7/11
MODIFIED BY:	DATE:
CHECKED BY:	DATE:
FILE SPEC: sstds/2012CurbRamp/CurbRampDetails.dwg	

REFER TO ROADWAY STANDARD DRAWING NUMBER 848.05 SHEET 3 OF 3 FOR ALL RAMP NOTES

23-MAR-2012 15:07 S:\Contracts\Special Details\Howerton\Standard Drawings\2012 Standard Drawings\Curb Ramp Details.dwg J.Howerton AT C5023750

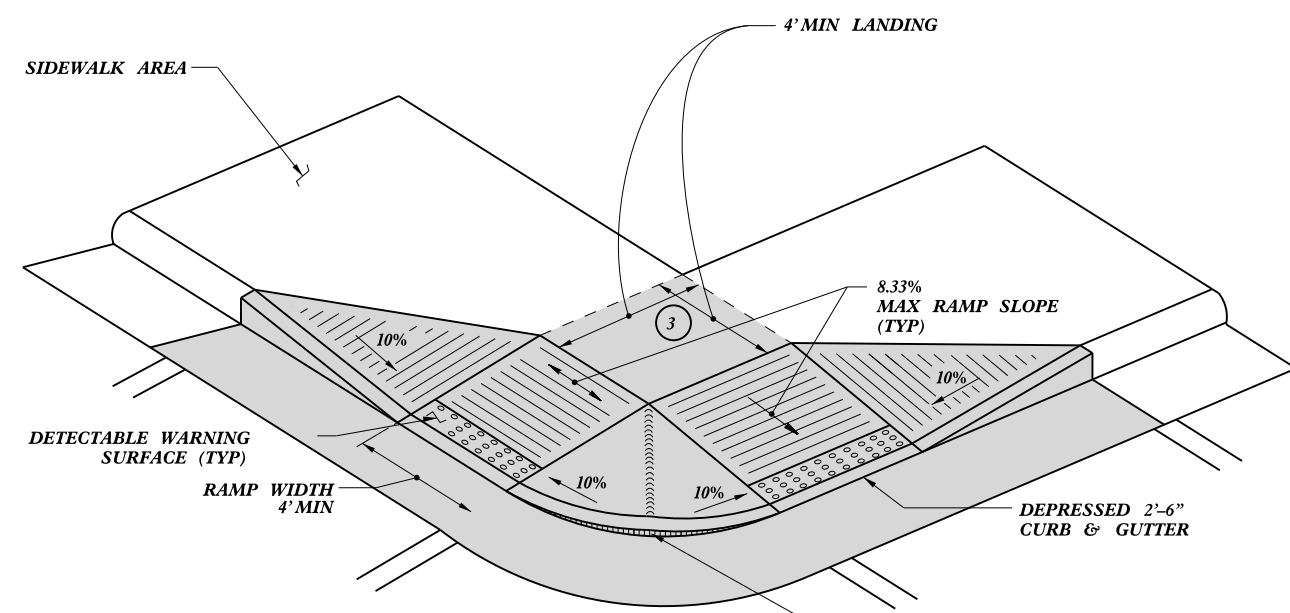

**TYPE 4**

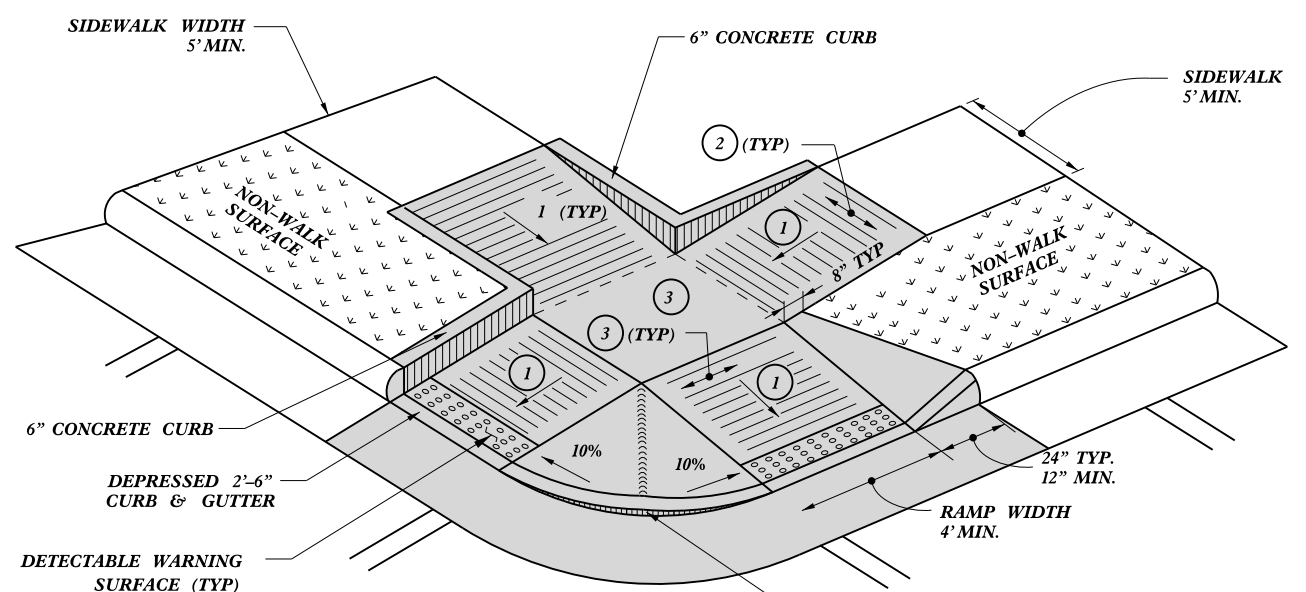

**TYPE 5**

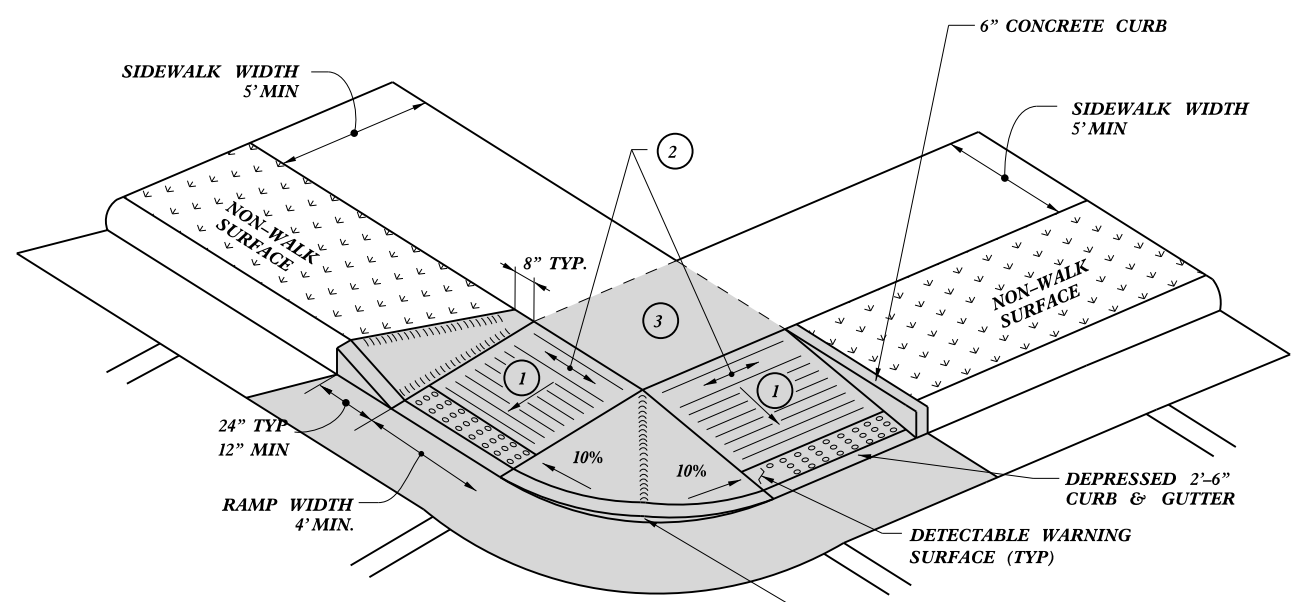

**TYPE 4A**

- 1 8.33% (12:1) MAX RAMP SLOPE
- 2 CROSS SLOPE: 2.00%
- 3 CURB RAMPS REQUIRE A (4'-0") MINIMUM LANDING WITH A MAXIMUM CROSS SLOPE AND LONGITUDINAL SLOPE OF 2.00% WHERE PEDESTRIANS PERFORM TURNING MANEUVERS. SLOPE TO DRAIN TO CURB.

PAY LIMITS FOR CURB RAMP

<b>CONTRACT STANDARDS AND DEVELOPMENT UNIT</b>	
Office 919-707-6950 FAX 919-250-4119	
<b>CURB RAMPS</b>	
Shared Landing	
ORIGINAL BY: J.S. HOWERTON	DATE: 7/7/11
MODIFIED BY:	DATE:
CHECKED BY:	DATE:
FILE SPEC: sstds/2012CurbRamp/CurbRampDetails.dwg	

REFER TO ROADWAY STANDARD DRAWING NUMBER 848.05 SHEET 3 OF 3 FOR ALL RAMP NOTES

23-MAR-2012 15:08 C:\Users\jhowerton\Documents\Standard Drawings\2012 Standard Drawings\Curb Ramp Special Details\Curb Ramp Details.dwg jhowerton AT 05023750