

**This electronic collection of documents is provided
for the convenience of the user
and is Not a Certified Document –**

**The documents contained herein were originally issued
and sealed by the individuals whose names and license
numbers appear on each page, on the dates appearing
with their signature on that page.**

**This file or an individual page
shall not be considered a certified document.**

R.115 CROSS SECTIONS

INDEX OF SHEETS

<u>TITLE</u>	<u>STATION</u>	<u>SHEET NO.</u>
CROSS SECTION INDEX		X-1
CROSS SECTION SUMMARY		X-1A
-DET-	10+00 - 15+00	X-2 thru X-10
-L-	10+00 - 15+30	X-11 thru X-26
-DWYITMP-	10+50 - 10+70	X-27
-DWY1-	10+10 - 11+10	X-28 & X-29
-DWY2-	10+10 - 11+50	X-30 & X-31

NOTE: Approximate quantities only. Clearing and Grubbing, Unclassified Excavation, Fine Grading, and Removal of Existing Asphalt Pavement will be paid for at the contract lump sum price for "Grading".

PROJ. REFERENCE NO.	SHEET NO.
17BP.14.R.115	X-1A

**STATE OF NORTH CAROLINA
DIVISION OF HIGHWAYS**

NOTE: EMBANKMENT COLUMN INCLUDES BACKFILL FOR UNDERCUT

CROSS-SECTION SUMMARY

Station	Uncl. Exc.	Embt	Station	Uncl. Exc.	Embt	Station	Uncl. Exc.	Embt	Station	Uncl. Exc.	Embt	Station	Uncl. Exc.	Embt
DET	(cu. yd.)	(cu. yd.)	DWY2	(cu. yd.)	(cu. yd.)	L	(cu. yd.)	(cu. yd.)	DRWY1	(cu. yd.)	(cu. yd.)	DET. REM	(cu. yd.)	(cu. yd.)
10+00.00	-	-	10+00.00	-	-	10+00.00	0	0	10+00.00	-	-	10+00.00	0	0
10+10.00	0	0	10+10.00	0	0	10+10.00	3	0	10+10.00	0	0	10+10.00	0	21
10+20.00	0	10	10+20.00	1	1	10+20.00	1	1	10+20.00	9	0	10+20.00	0	67
10+30.00	0	51	10+30.00	0	3	10+30.00	1	1	10+30.00	19	0	10+30.00	0	116
10+40.00	0	109	10+40.00	0	2	10+40.00	0	2	10+40.00	19	0	10+40.00	0	134
10+50.00	0	136	10+50.00	0	1	10+50.00	0	3	10+50.00	7	0	10+50.00	3	136
10+60.00	0	136	10+60.00	0	0	10+60.00	0	4	10+60.00	3	0	10+60.00	6	131
10+70.00	0	128	10+70.00	0	0	10+70.00	0	4	10+70.00	2	1	10+70.00	3	117
10+80.00	0	114	10+80.00	1	0	10+80.00	0	4	10+80.00	2	2	10+80.00	0	99
10+90.00	0	95	10+90.00	1	0	10+90.00	0	3	10+90.00	2	3	10+90.00	7	73
11+00.00	0	70	11+00.00	1	0	11+00.00	0	3	11+00.00	2	4	11+00.00	14	56
11+10.00	0	53	11+10.00	1	0	11+10.00	0	2	11+10.00	3	2	11+10.00	13	51
11+20.00	0	46	11+20.00	2	0	11+20.00	0	2				11+20.00	11	46
11+30.00	1	41	11+30.00	2	0	11+30.00	0	3				11+30.00	7	42
11+40.00	2	37	11+40.00	2	0	11+40.00	0	3				11+40.00	4	41
11+50.00	3	36	11+50.00	2	0	11+50.00	1	3				11+50.00	1	39
11+60.00	3	34				11+60.00	1	2				11+60.00	1	34
11+70.00	2	30				11+70.00	1	1				11+70.00	0	28
11+80.00	1	25				11+80.00	1	1				11+80.00	0	26
11+90.00	1	21				11+90.00	1	1				11+90.00	0	23
12+00.00	1	19				12+00.00	1	0				12+00.00	0	17
12+10.00	1	13				12+10.00	1	0				12+10.00	0	13
12+20.00	1	9				12+20.00	1	0				12+20.00	0	10
12+30.00	1	6				12+30.00	1	0				12+30.00	0	7
12+40.00	1	3				12+40.00	2	0				12+40.00	1	4
12+50.00	3	1				12+50.00	3	0				12+50.00	2	1
12+60.00	6	0				12+60.00	4	0				12+60.00	3	0
12+70.00	10	0				12+70.00	13	0				12+70.00	3	0
12+80.00	14	0				12+80.00	0	0				12+80.00	4	0
12+90.00	18	0				12+90.00	0	0						
13+00.00	21	0				13+00.00	0	0						
13+10.00	0	0				13+10.00	0	0						
13+20.00	0	0				13+20.00	0	0						
13+30.00	0	0				13+30.00	0	0						
13+40.00	0	0				13+40.00	0	0						
13+50.00	0	0				13+50.00	15	2						
13+60.00	0	0				13+60.00	8	1						
13+70.00	8	0				13+70.00	6	2						
13+80.00	8	0				13+80.00	6	2						
13+90.00	9	0				13+90.00	8	2						
14+00.00	12	0				14+00.00	4	1						
14+10.00	15	0				14+10.00	0	0						
14+20.00	15	0				14+20.00	5	0						
14+30.00	14	0				14+30.00	8	1						
14+40.00	12	0				14+40.00	9	2						
14+50.00	6	0				14+50.00	9	2						
						14+60.00	6	2						
						14+70.00	5	2						
						14+80.00	4	2						
						14+90.00	4	2						
						15+00.00	3	3						
						15+10.00	2	2						
						15+20.00	2	2						

8/23/99

0 2.5 5	PROJ. REFERENCE NO. 17BP.14.R.115	SHEET NO. X-2
---------	--------------------------------------	------------------

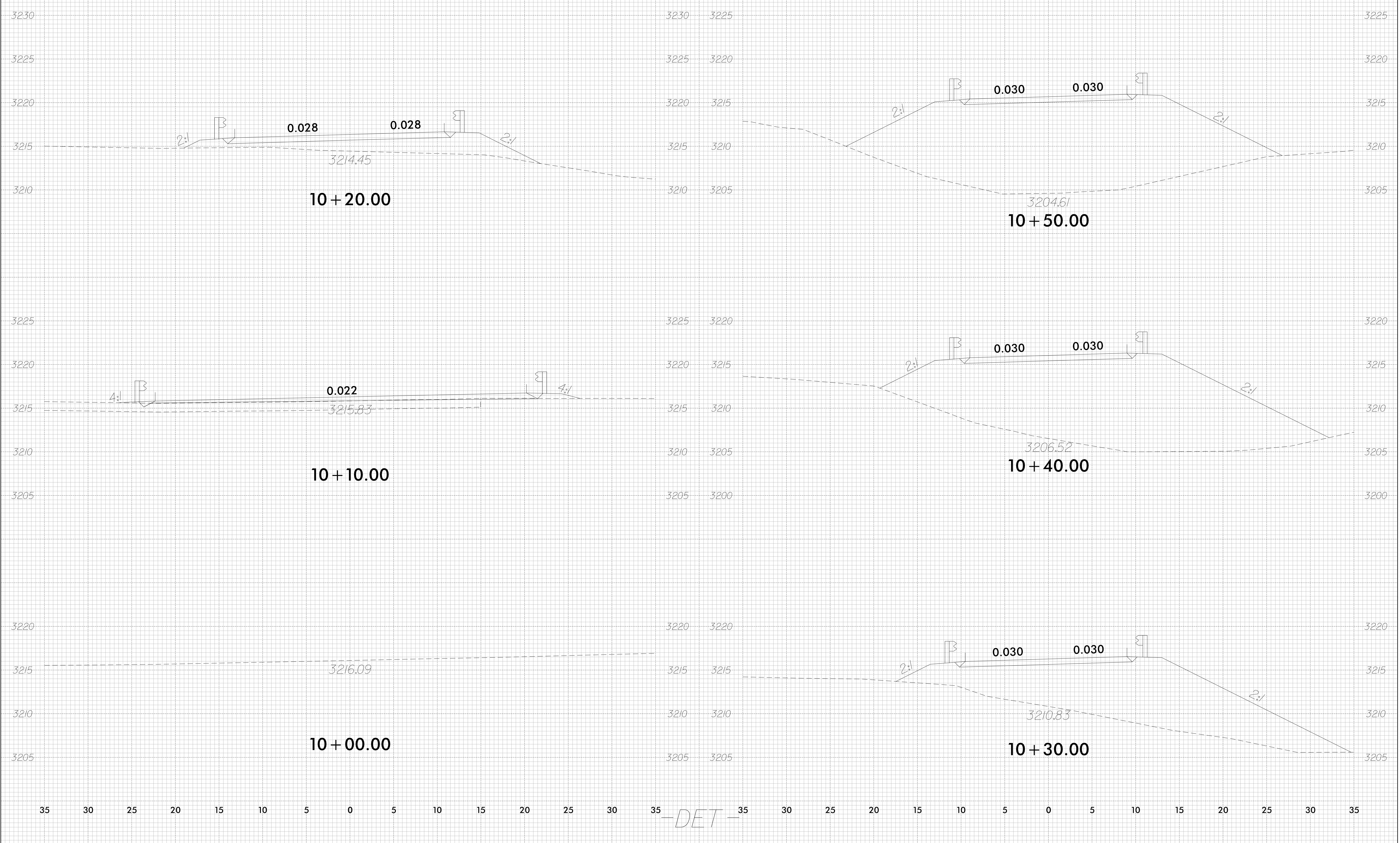

3/11/2021
X:\SC\15502029_R0Y_XPL_DET.dgn
US54635564

DET

8/23/99

	PROJ. REFERENCE NO.	SHEET NO.
	17BP.14.R.115	X-3

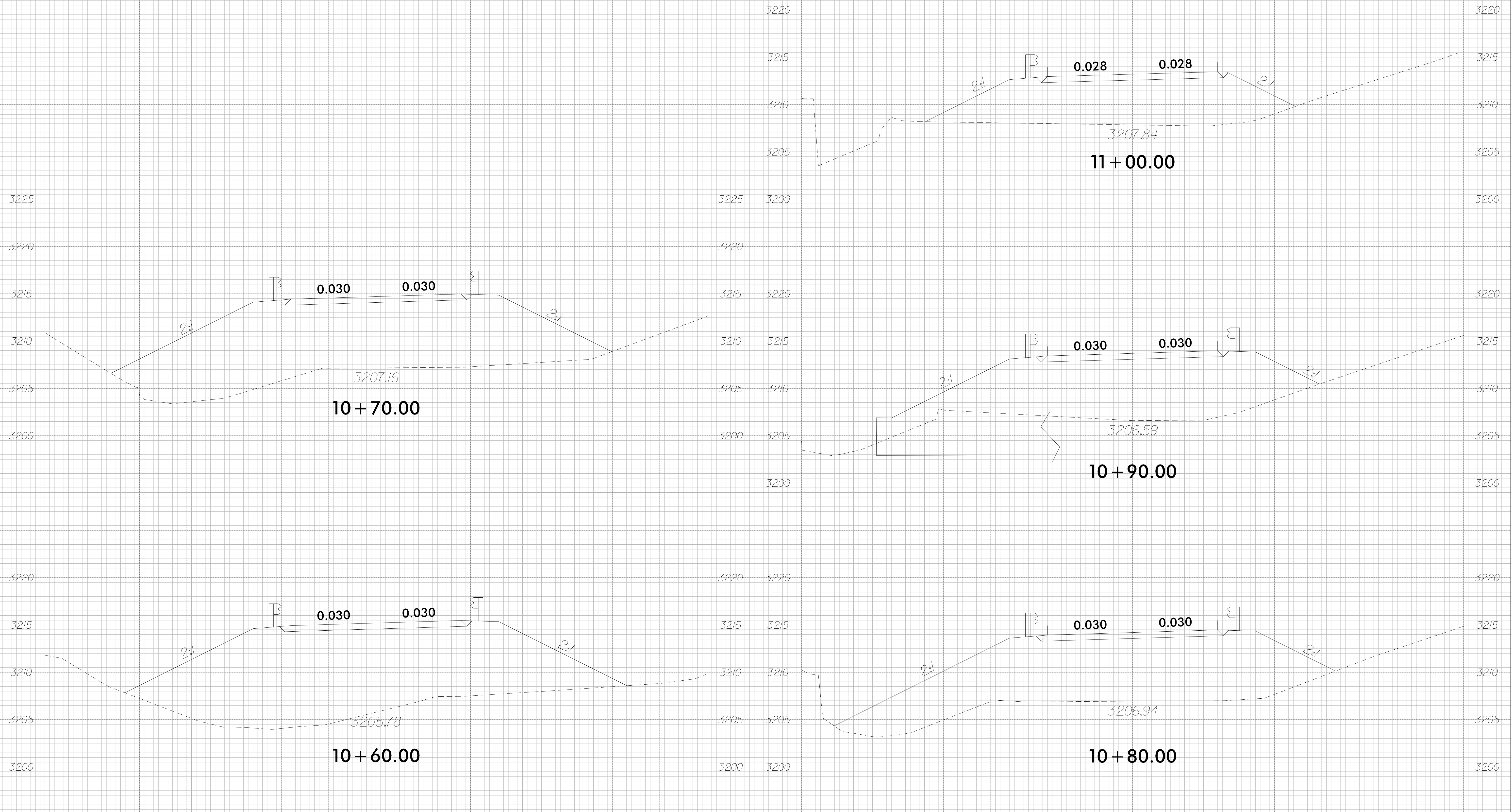

-DET-

3/1/2021 15:56:33 155663369



-DET-

8/23/99

0 2.5 5	PROJ. REFERENCE NO.	SHEET NO.
	17BP.14.R.115	X-5

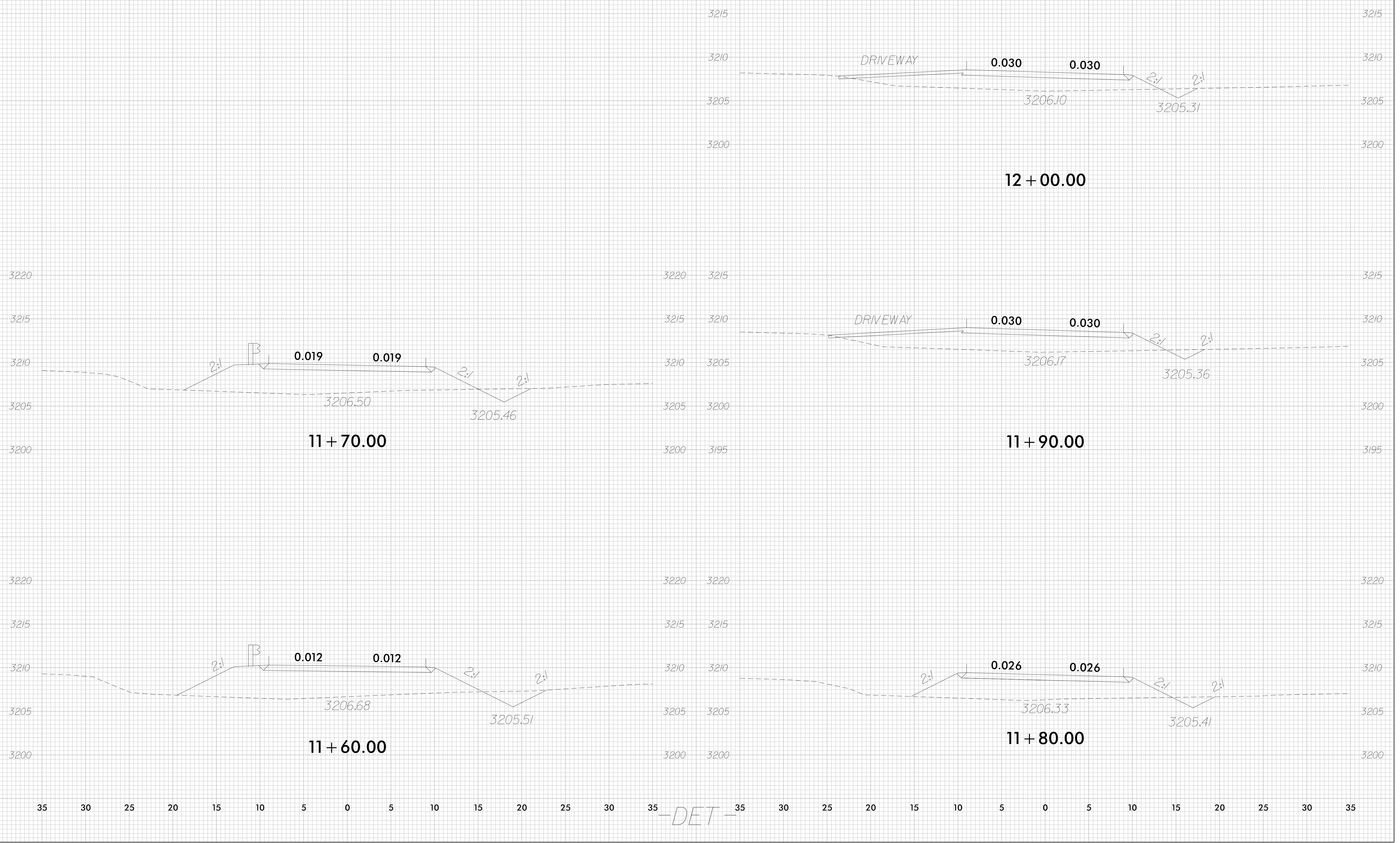

-DET-

3/1/2025 5:09:29 RDY_XPL_DET.dgn
1155663589

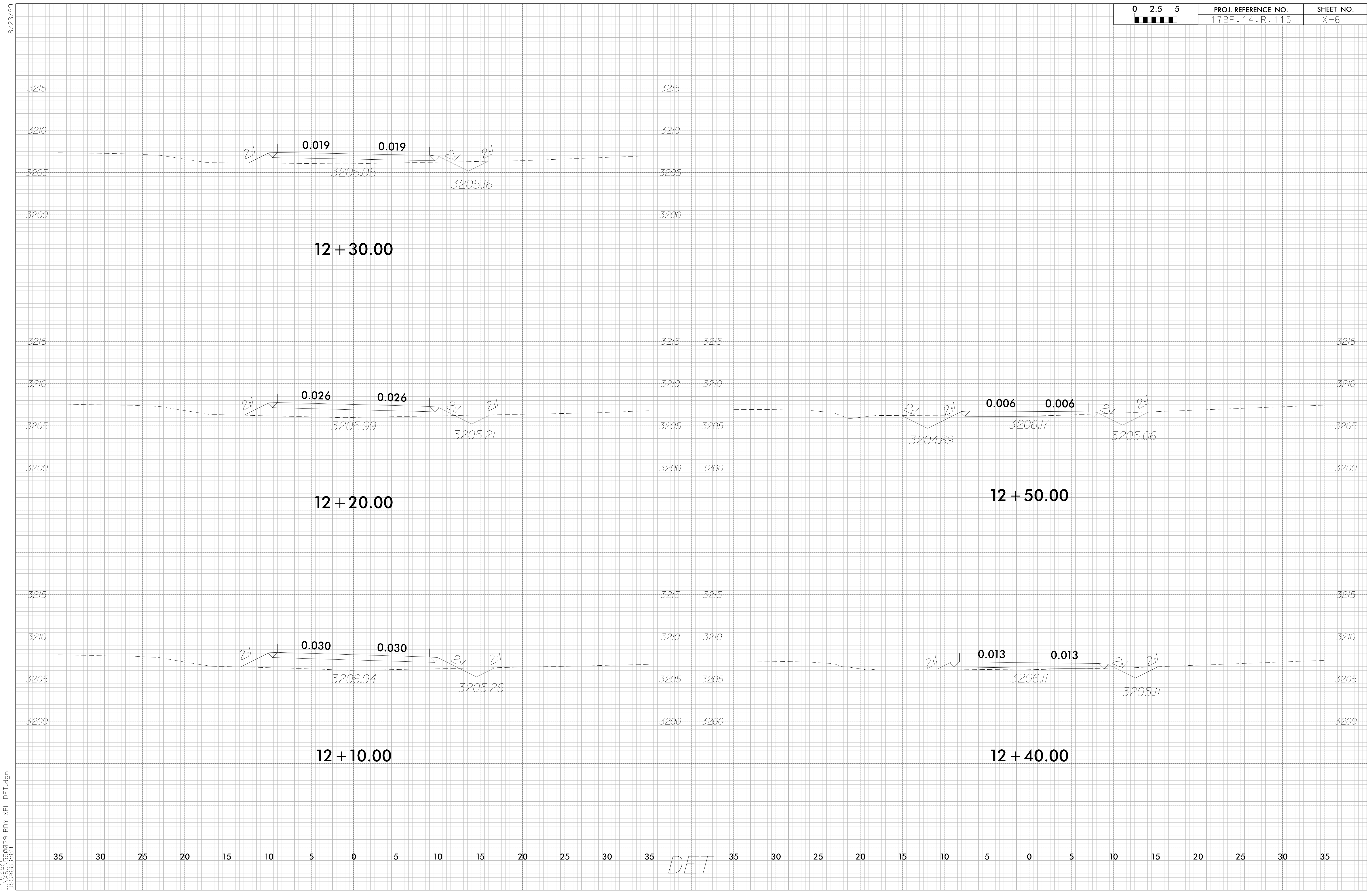

3/11/2021 15:50:29 RDY_XPL_DET.dgn

-DET-

8/23/99

0 2.5 5	PROJ. REFERENCE NO.	SHEET NO.
	17BP.14.R.115	X-7

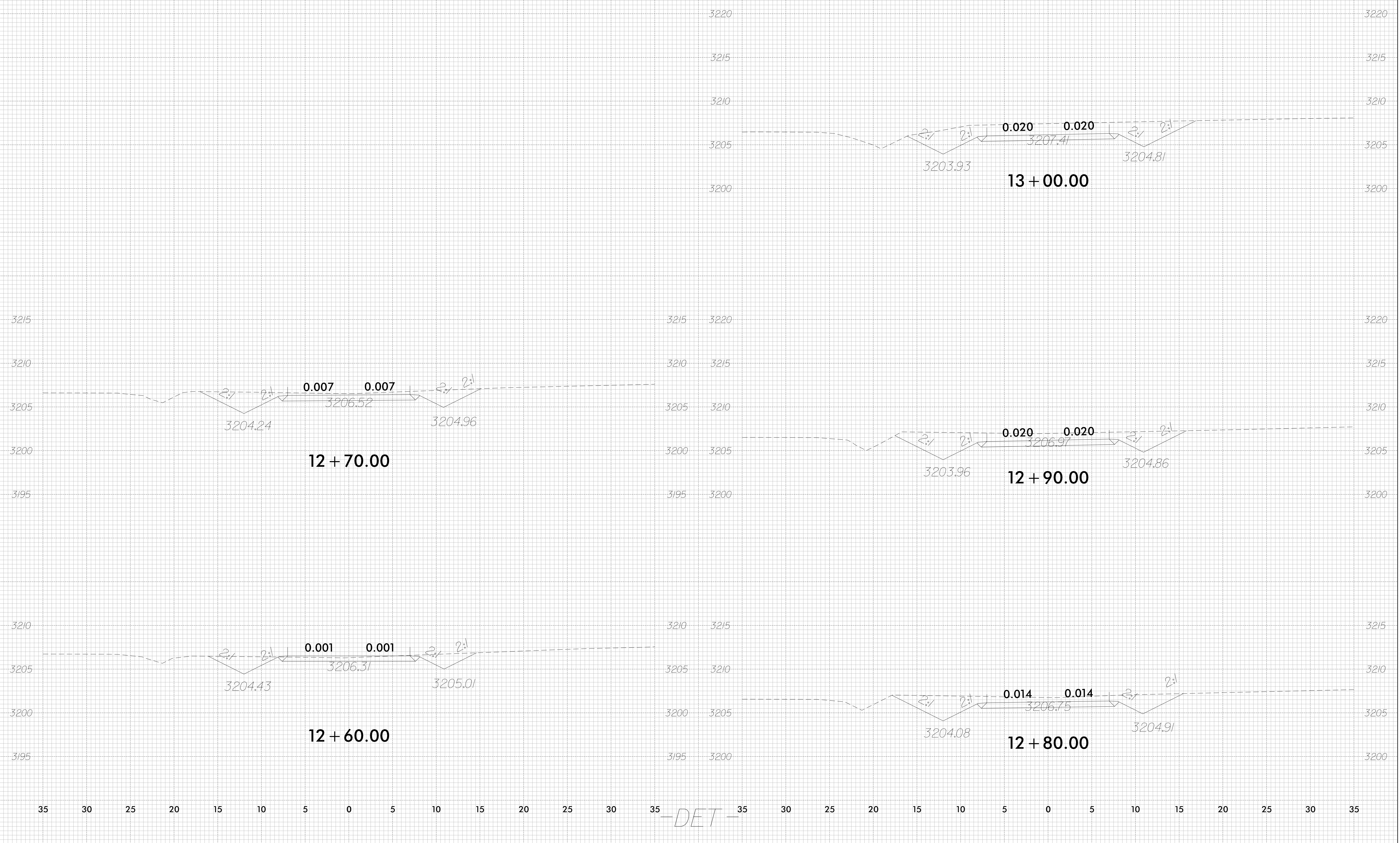

-DET-

3/11/2015 15:09:29 RDY_XPL_DET.dgn
1155463330

B/23/199

0 2.5 5	PROJ. REFERENCE NO.	SHEET NO.
	17BP.14.R.115	X-8

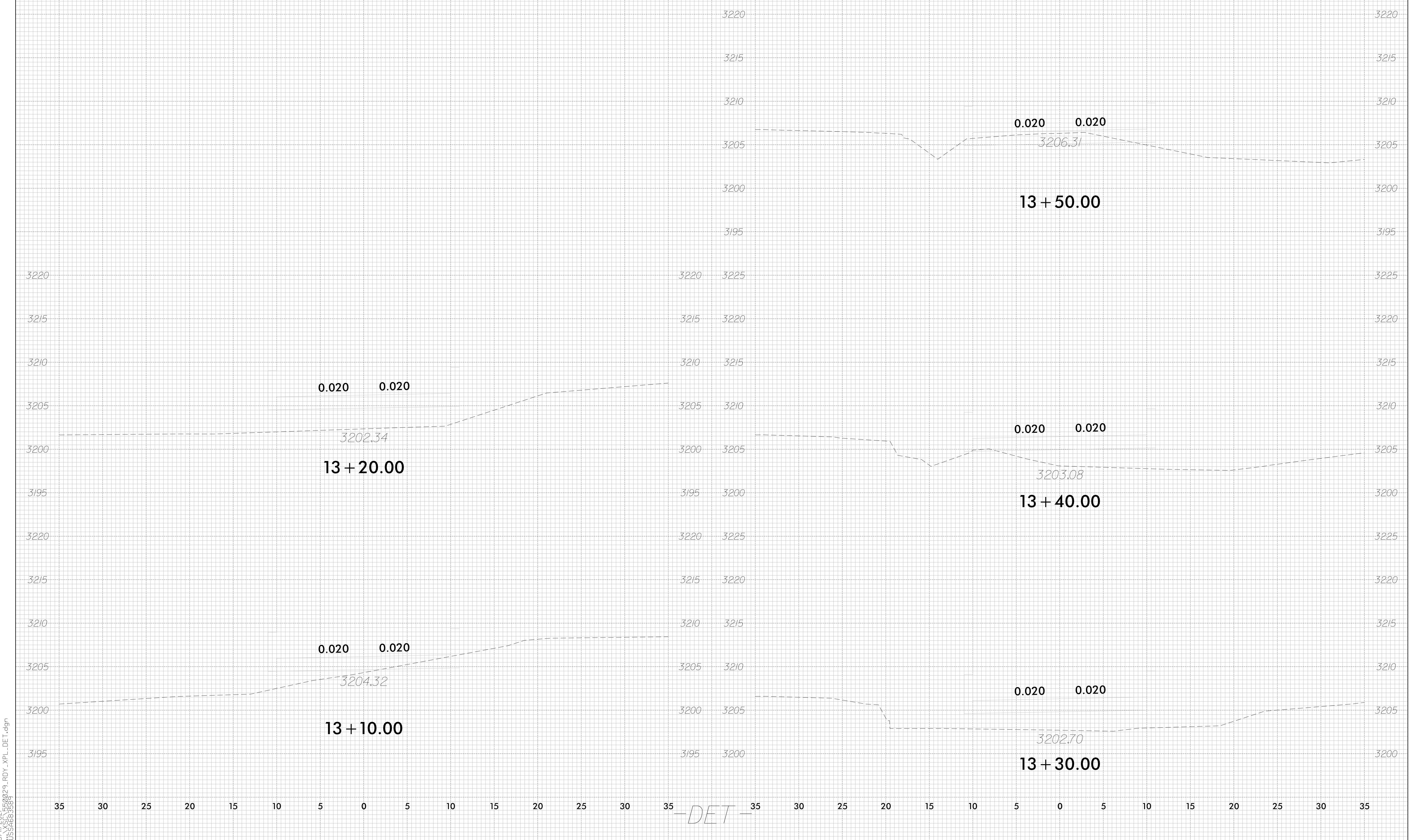

3/11/2021
X:\SSC\5509291_R0Y_XPL_DET.dgn
T:\SSA\B\5554

-DET-

8/23/99

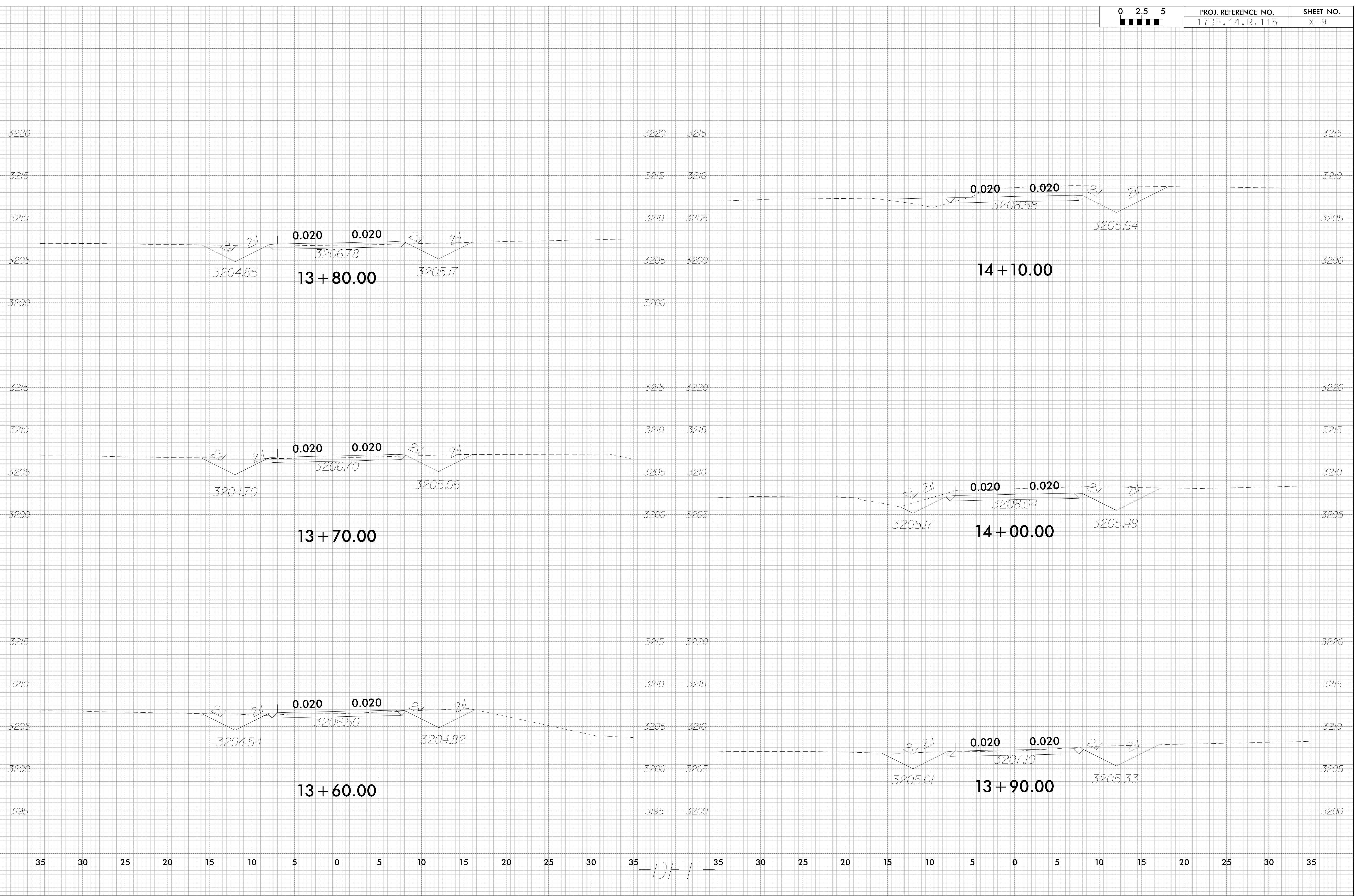

3/1/2021 10:56:00 AM RDY_XPL_DET.dgn

-DET-

8/23/19



PROJ. REFERENCE NO.	SHEET NO.
17BP.14.R.115	X-10

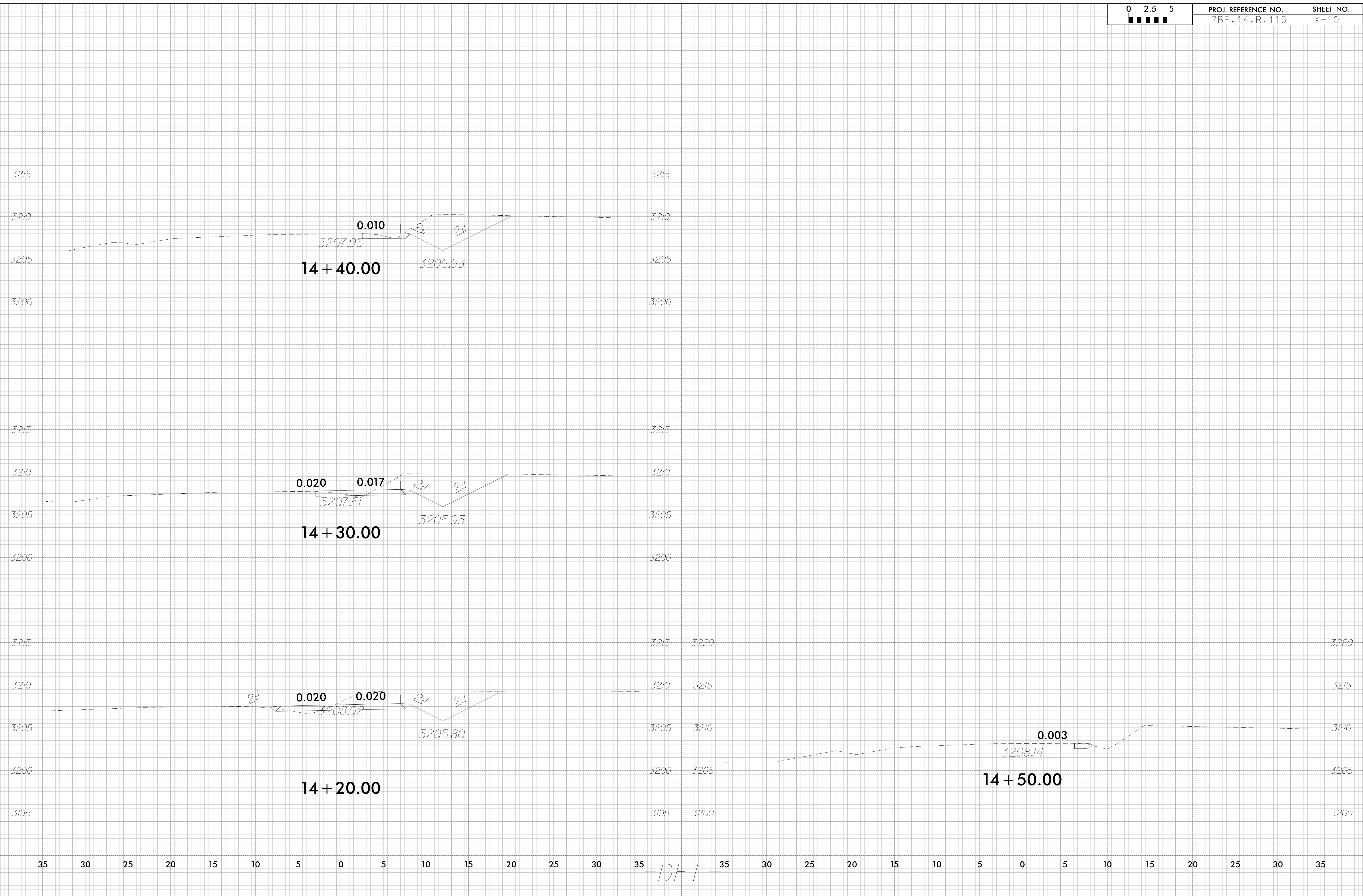

3/11/2021 11:58:35 AM 17BP.14.R.115.X-10.DWG

-DET-

8/23/99

	PROJ. REFERENCE NO.	SHEET NO.
	17BP.14.R.115	X-11

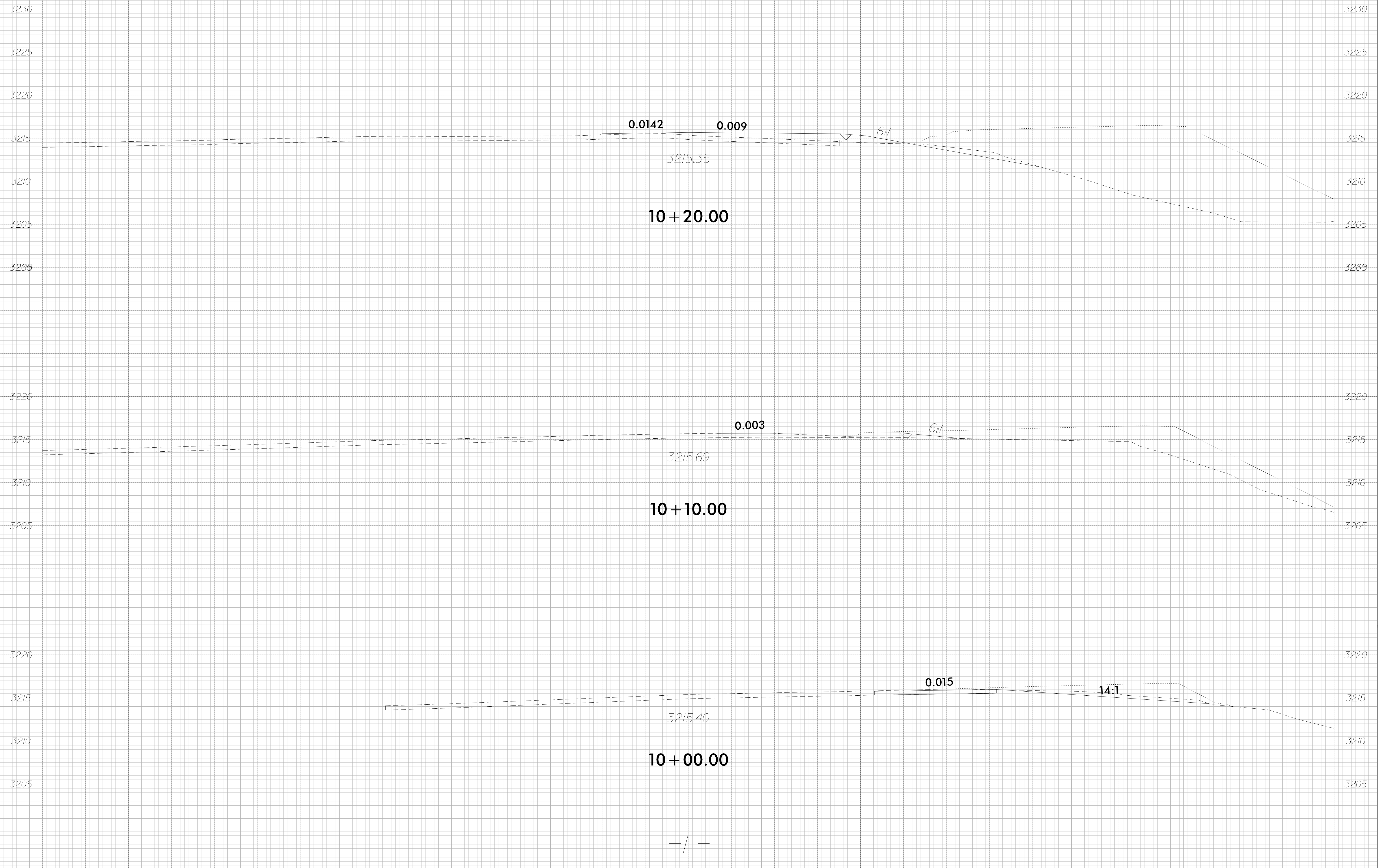

3/1/2021 11:56:33 AM 17BP.14.R.115.XPL.L-1.dgn

8/23/99



PROJ. REFERENCE NO.	SHEET NO.
17BP.14.R.115	X-12

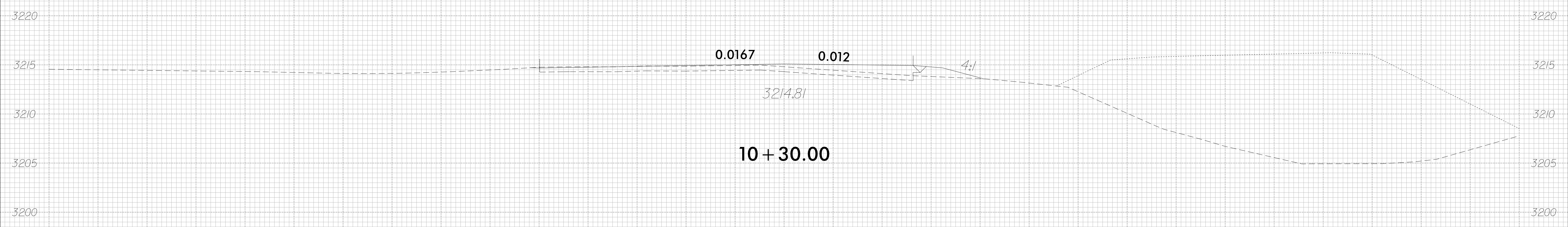
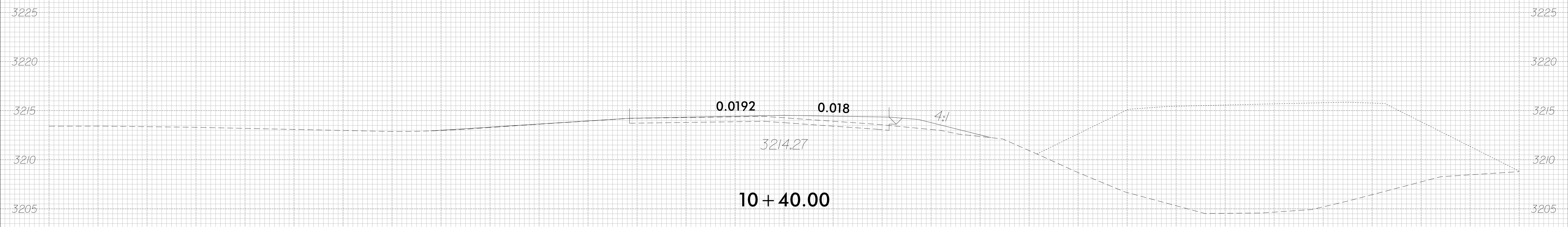

3/1/2021 11:58:55 AM 155029_RDY_XPL_L-1.dgn

—/—

8/23/99

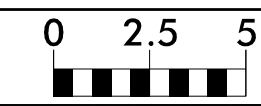

PROJ. REFERENCE NO.
17BP.14.R.115

SHEET NO.
X-13

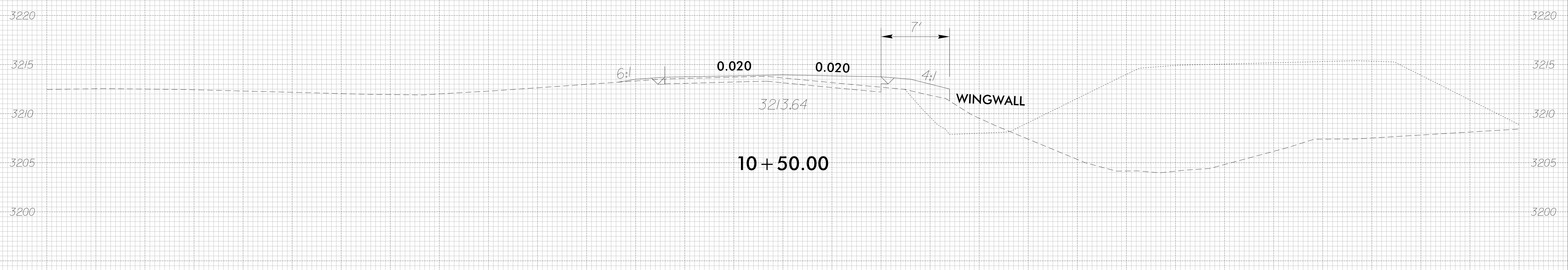
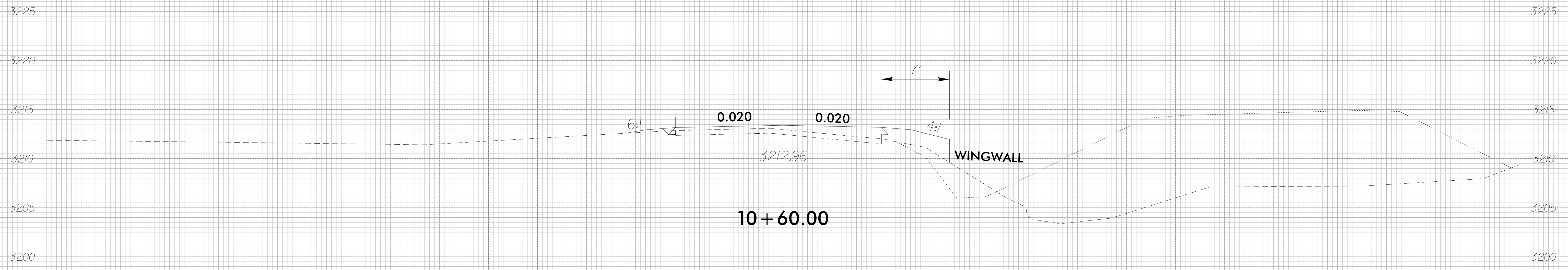

3/1/2021 11:55:02 AM RDY_XPL_L-1.dgn

—/—

8/23/99

0 2.5 5	PROJ. REFERENCE NO.	SHEET NO.
	17BP.14.R.115	X-14

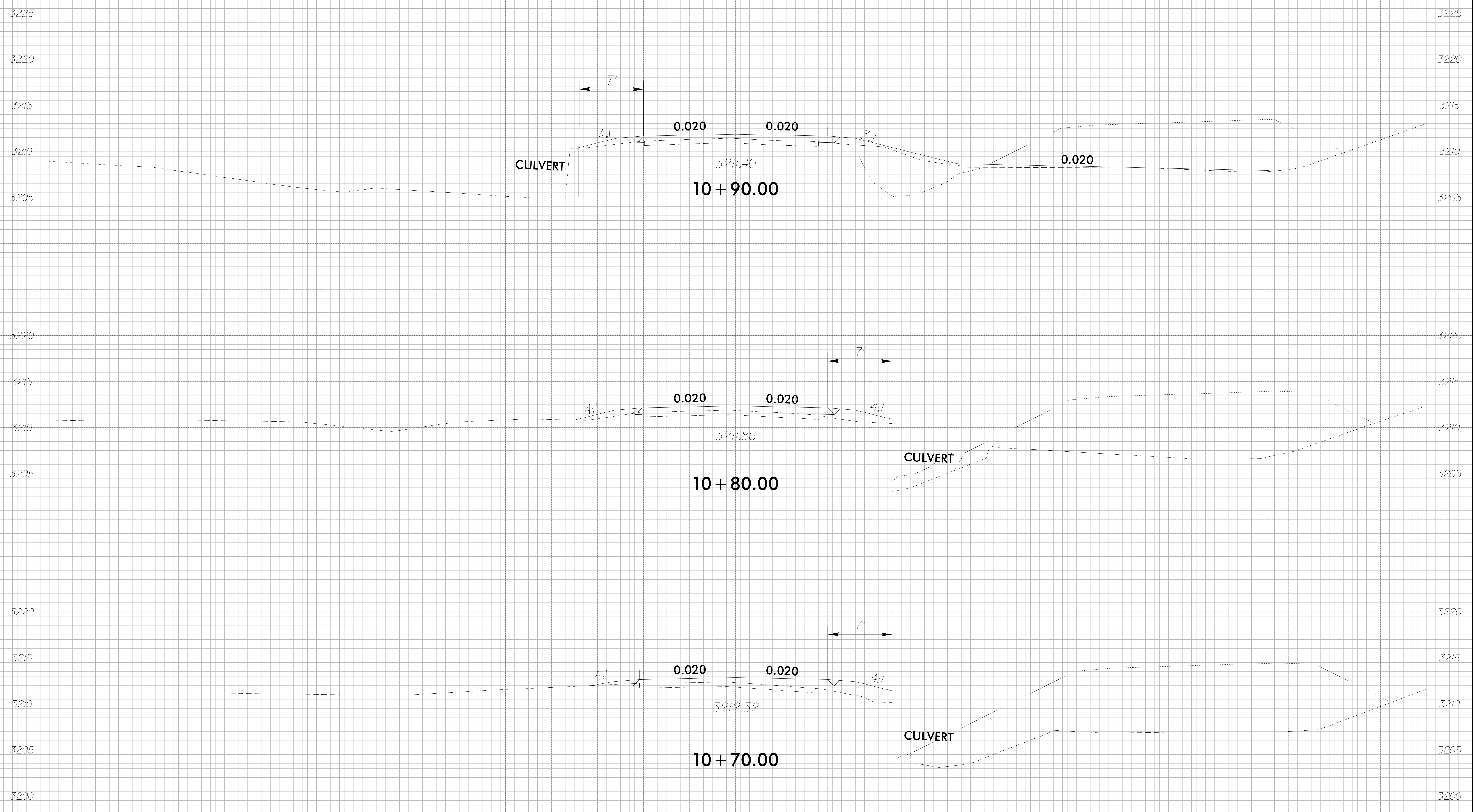

-L-

3/11/2025 05:00:29 RDY.XPL.L-1.dgn
USG 08/23/99

8/23/99

0 2.5 5	PROJ. REFERENCE NO.	SHEET NO.
	17BP.14.R.115	X-15

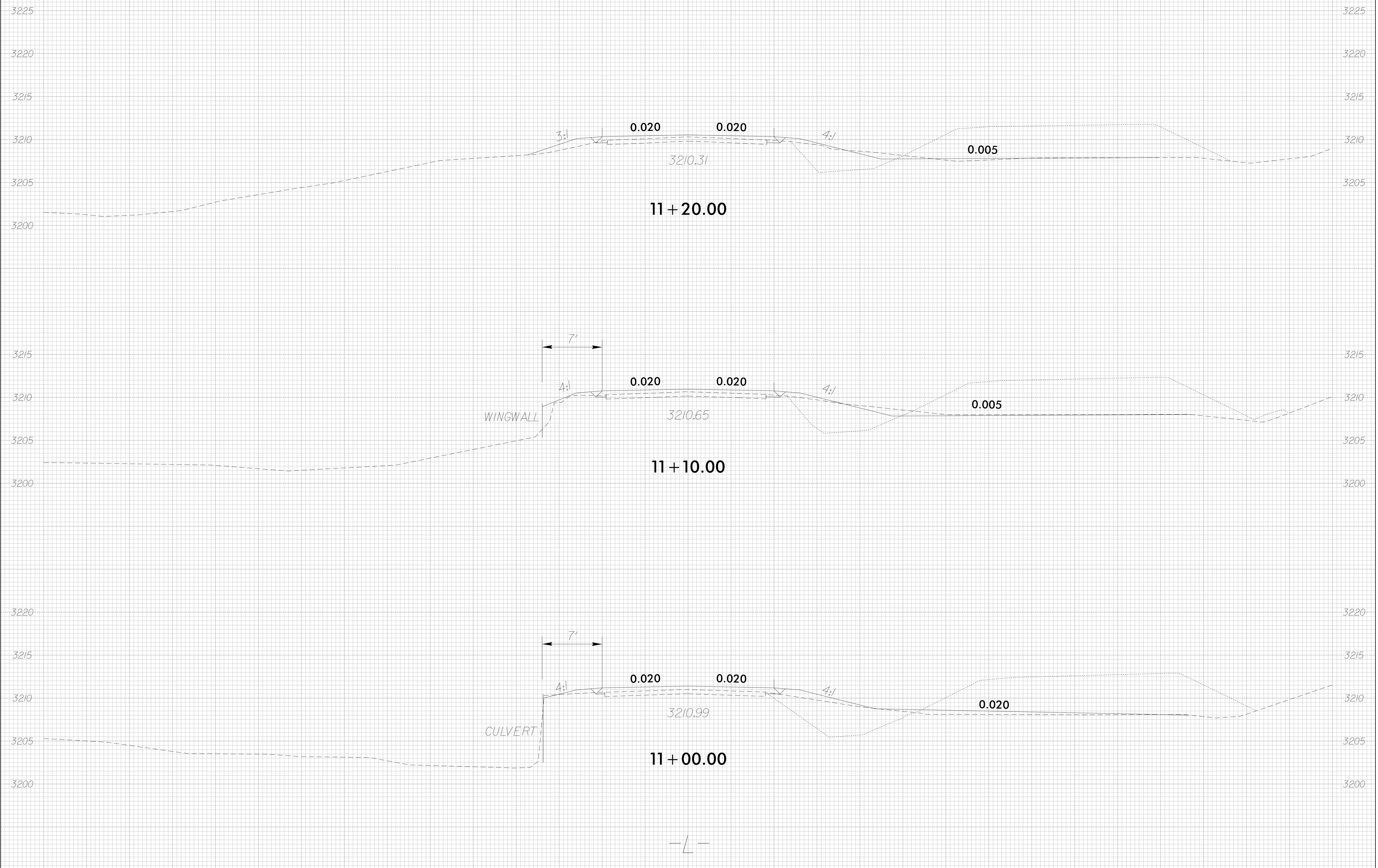

3/11/2021
X:\SCS\55029_R0Y_XPL_L-1.dgn
11:55:46.3567

—L—

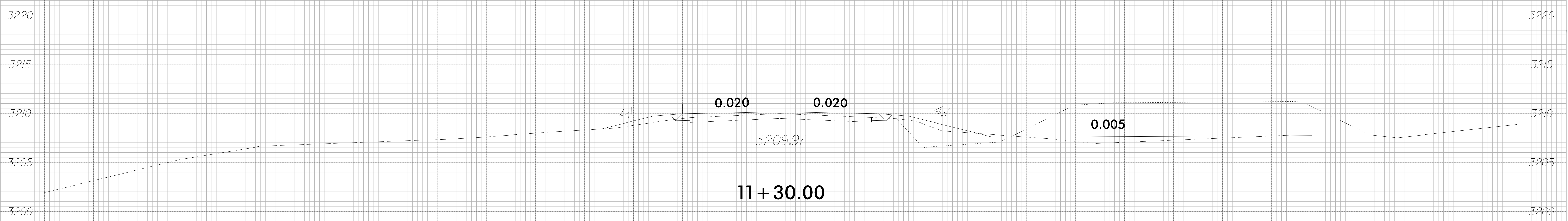
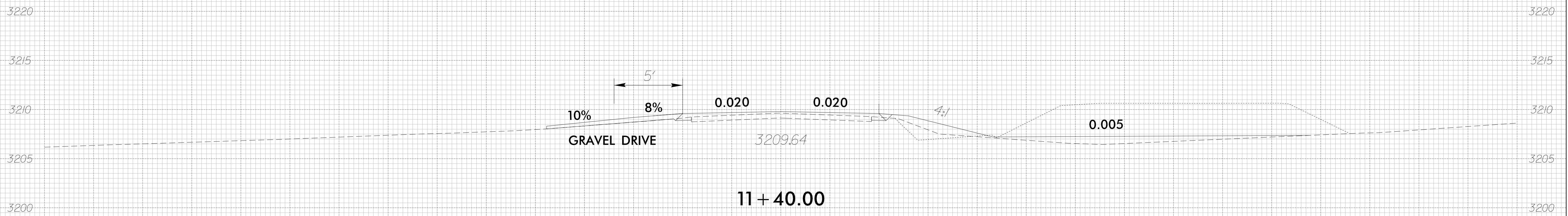

8/23/99

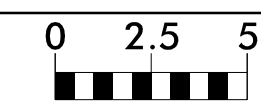

PROJ. REFERENCE NO.
17BP.14.R.115

SHEET NO.
X-17

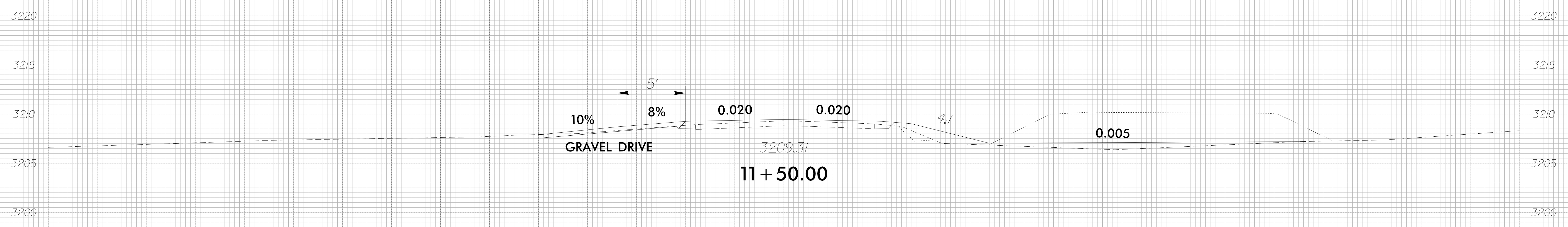

3/1/2021
15:50:29
15:50:30

— L —

8/23/99

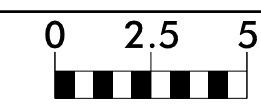

PROJ. REFERENCE NO.	SHEET NO.
17BP.14.R.115	X-18

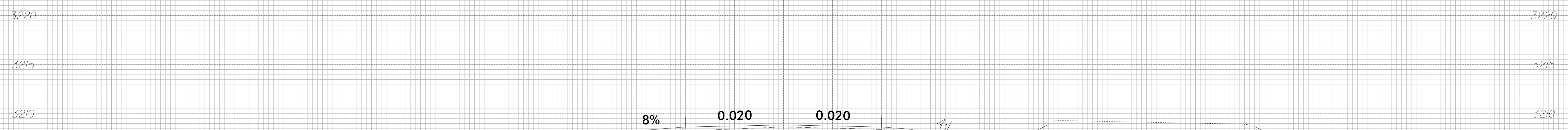
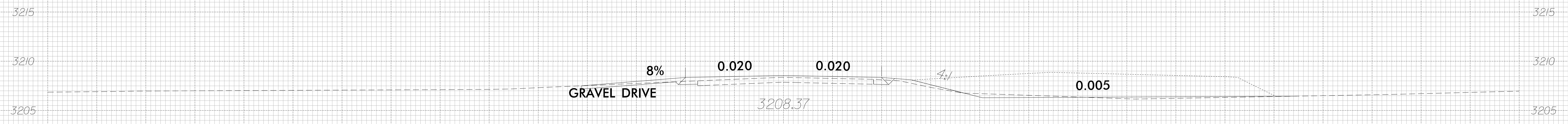
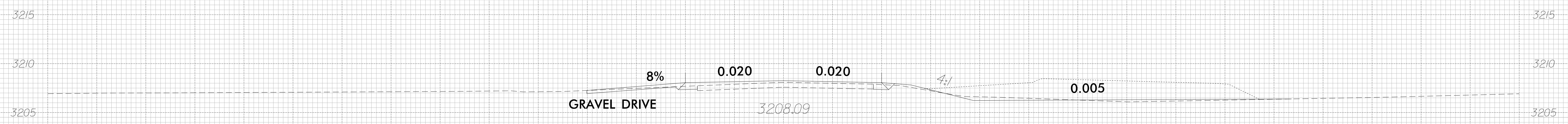

3/1/2021 5:50:29 RDY_XPL_L-1.dgn 155663359

—/—

8/23/99

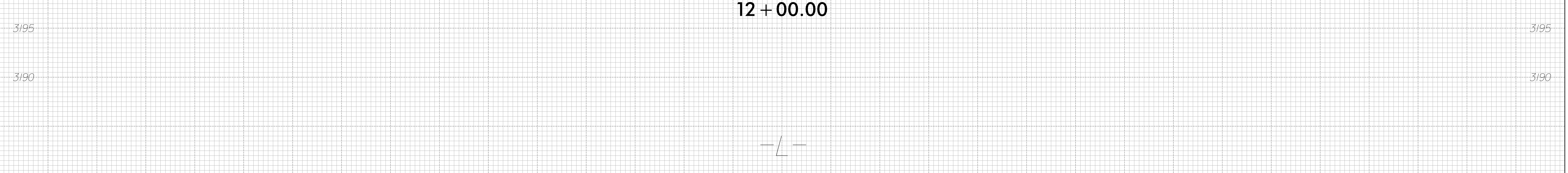
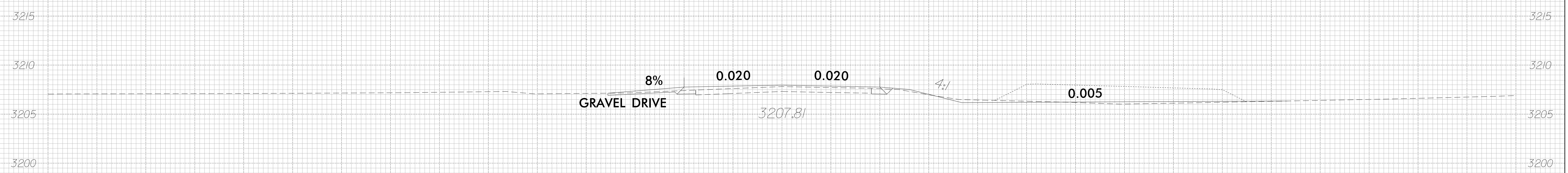
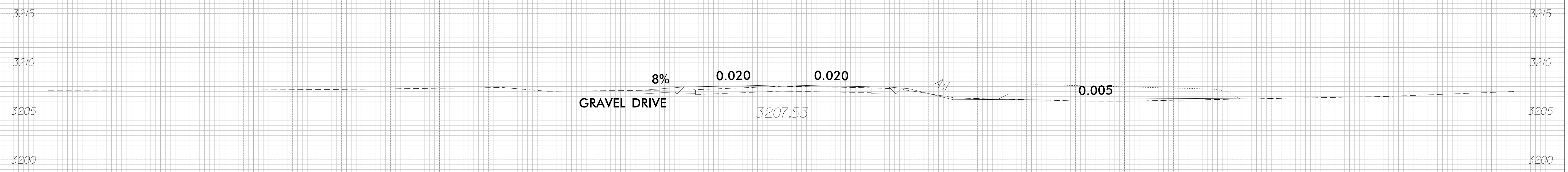
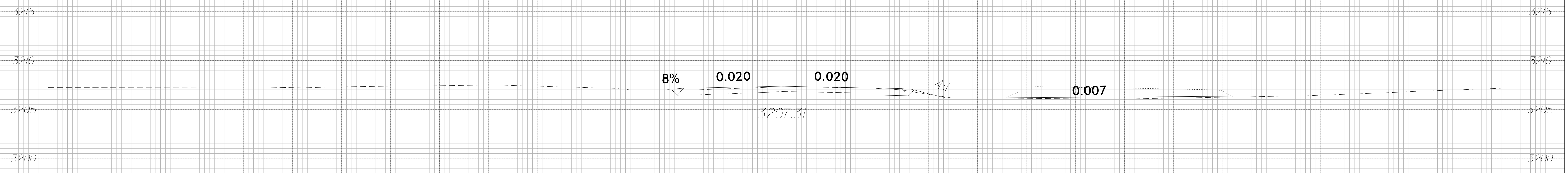

3/11/2021 15:56:33 1556633307

-L-

8/23/99

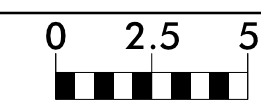

PROJ. REFERENCE NO.
17BP.14.R.115

SHEET NO.
X-20

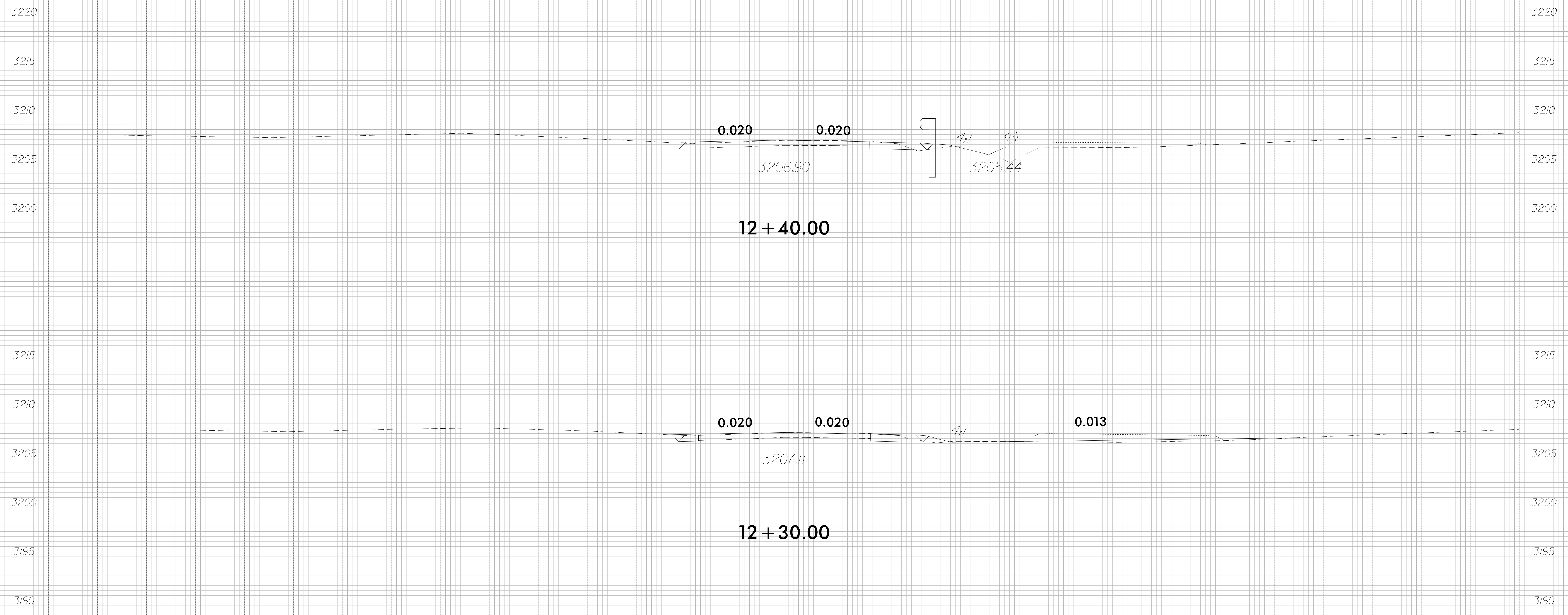

3/1/2021
11:58:33 AM
US:16033301

— / —

8/23/99

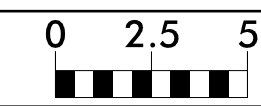

PROJ. REFERENCE NO.
17BP.14.R.115

SHEET NO.
X-21

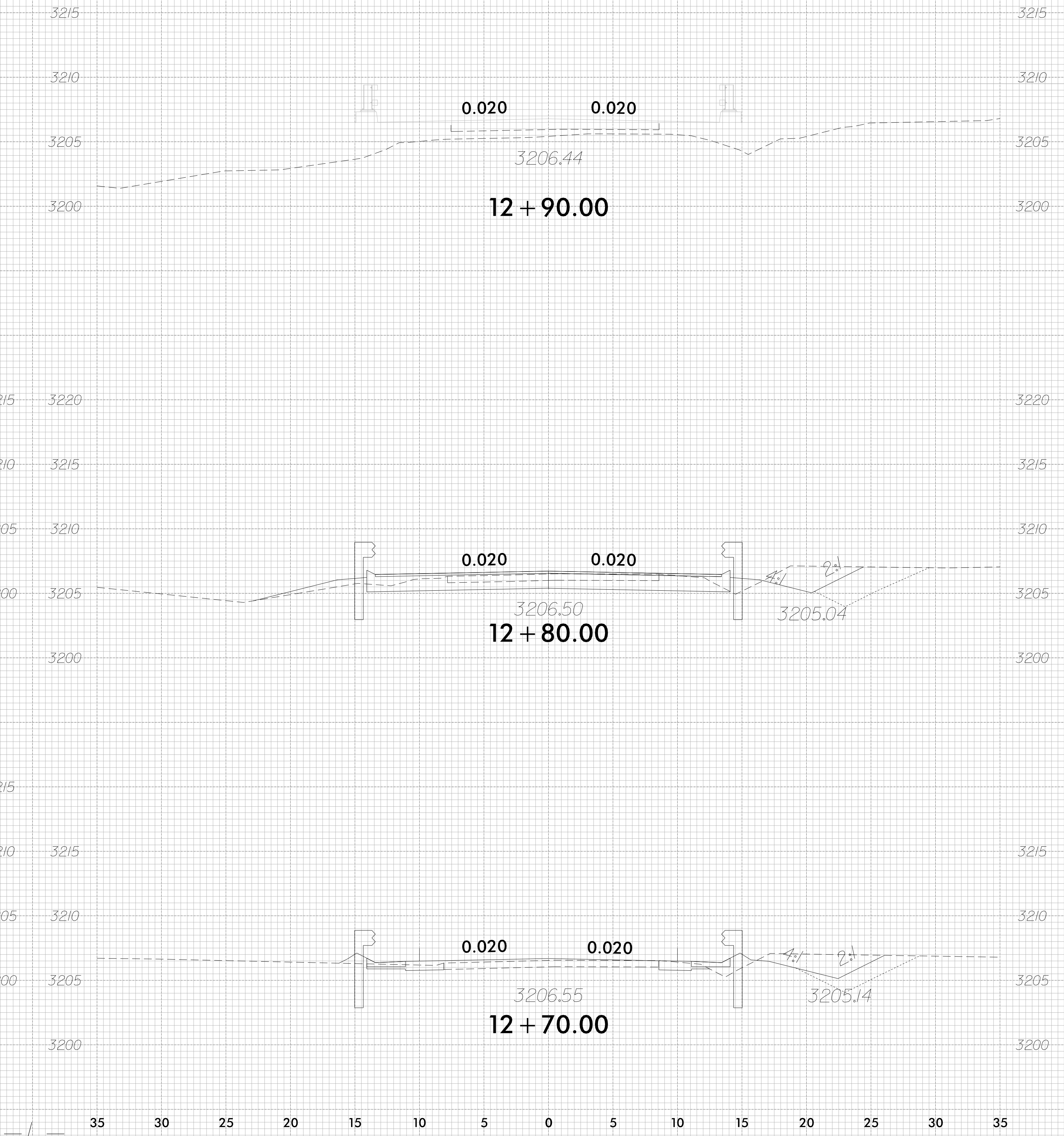
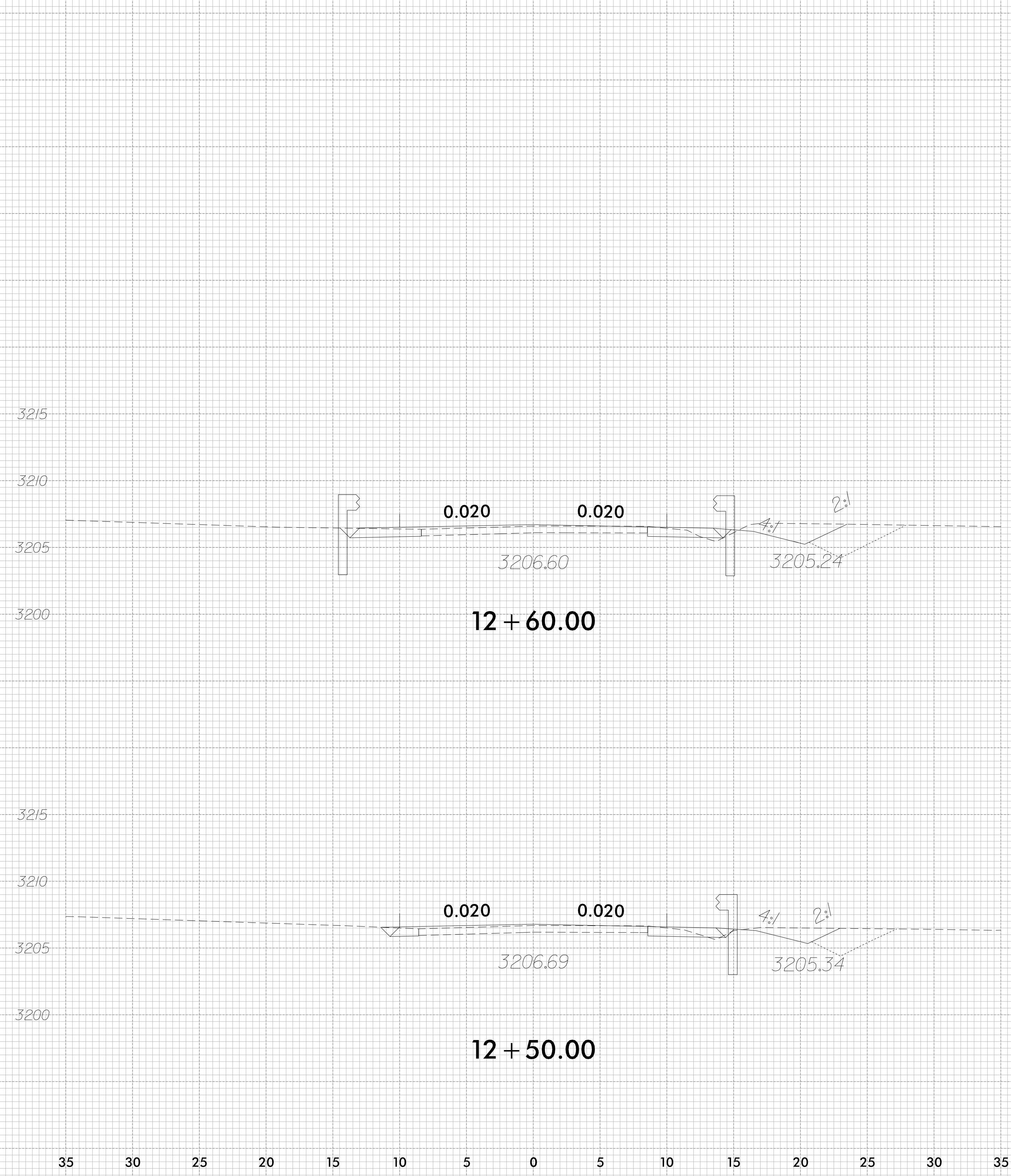

3/1/2021 15:56:33 155029_RDY_XPL_L-2.dgn

8/23/99

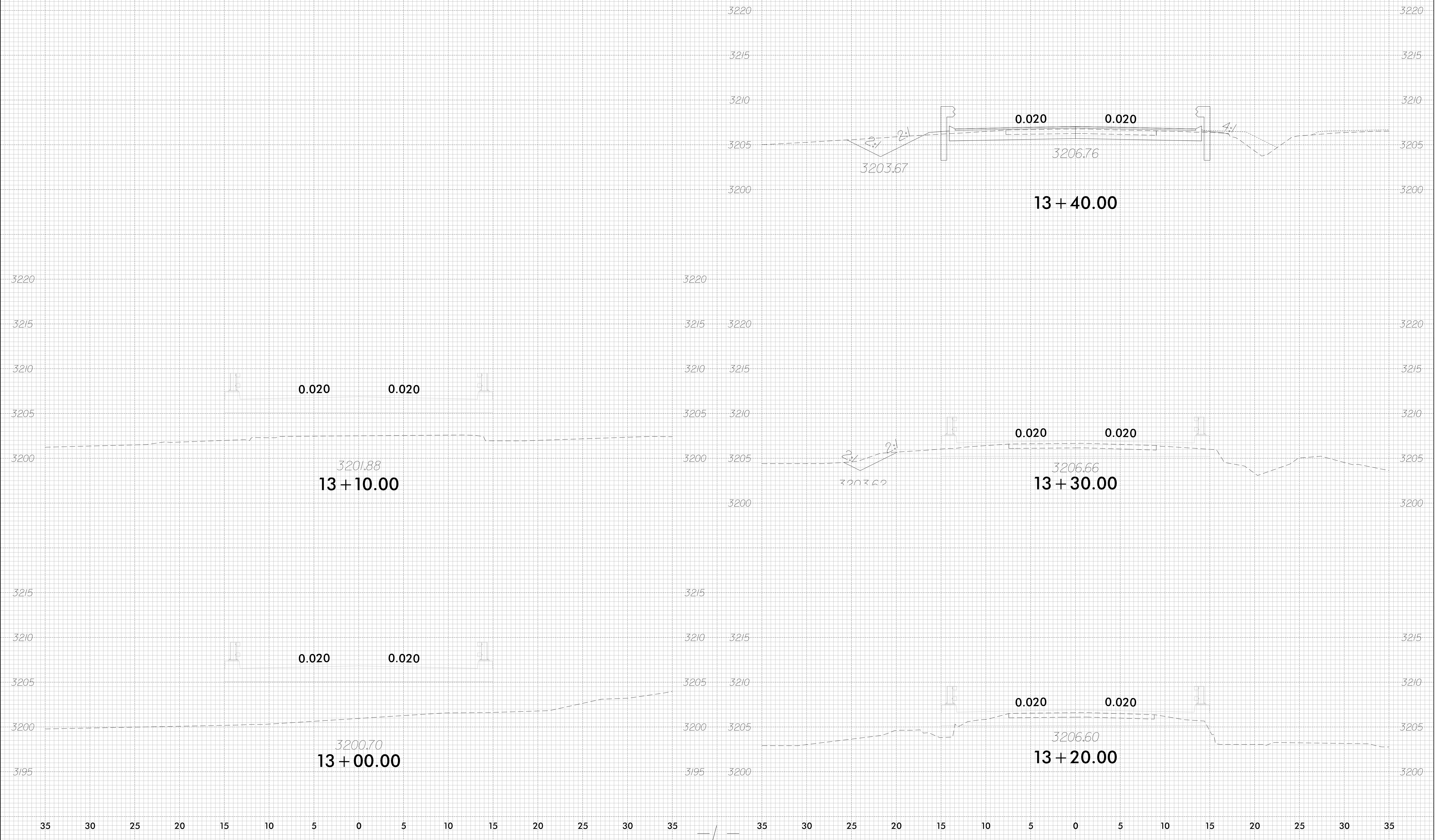

3/11/2021 15:02:29_RDY_XPL_L-2.dgn
User: SCS\35589

8/23/99

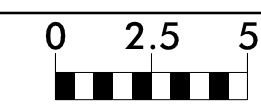

PROJ. REFERENCE NO.
17BP.14.R.115

SHEET NO.
X-23

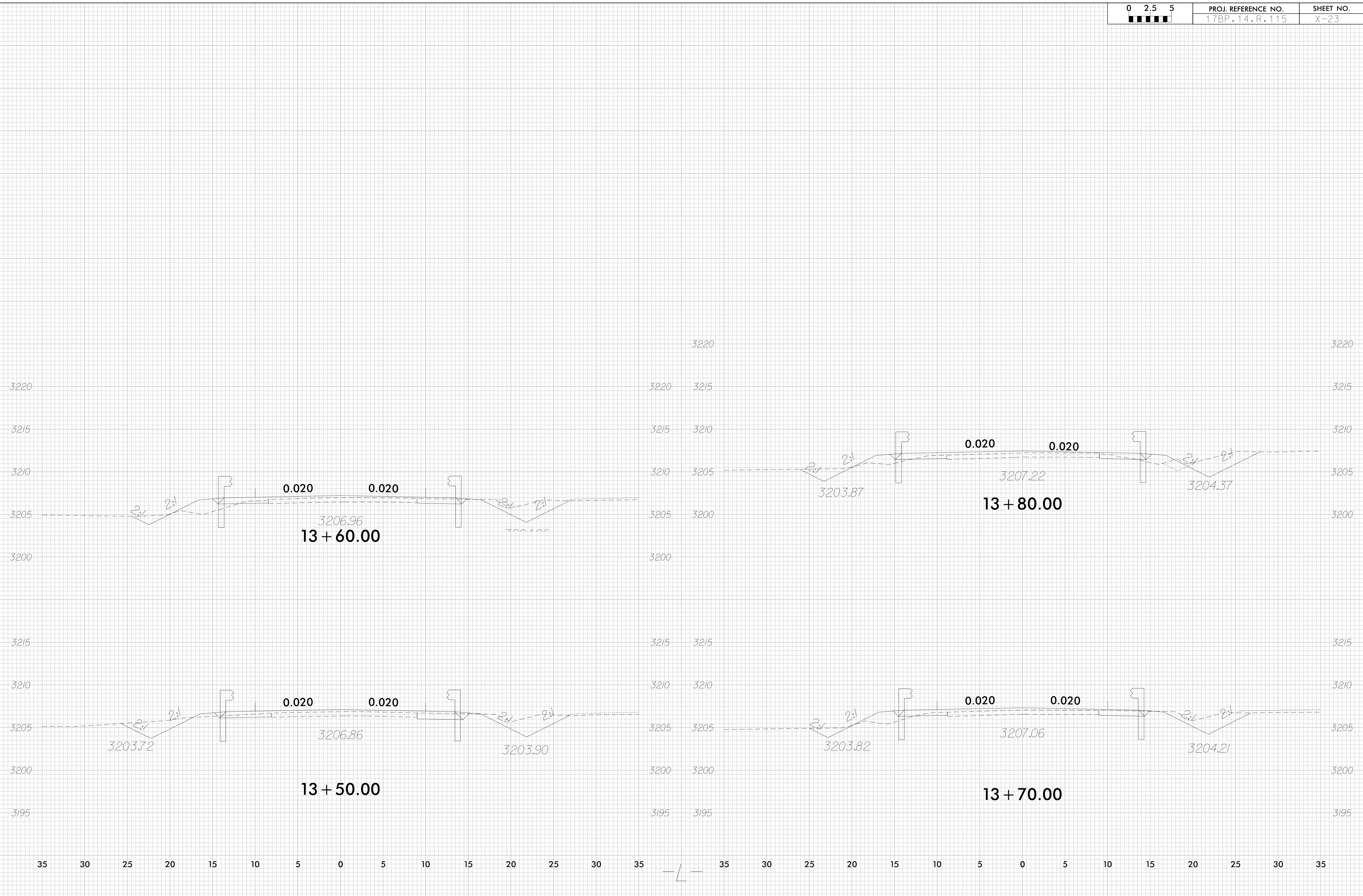

3/1/2021
1:55:00
17BP.14.R.115

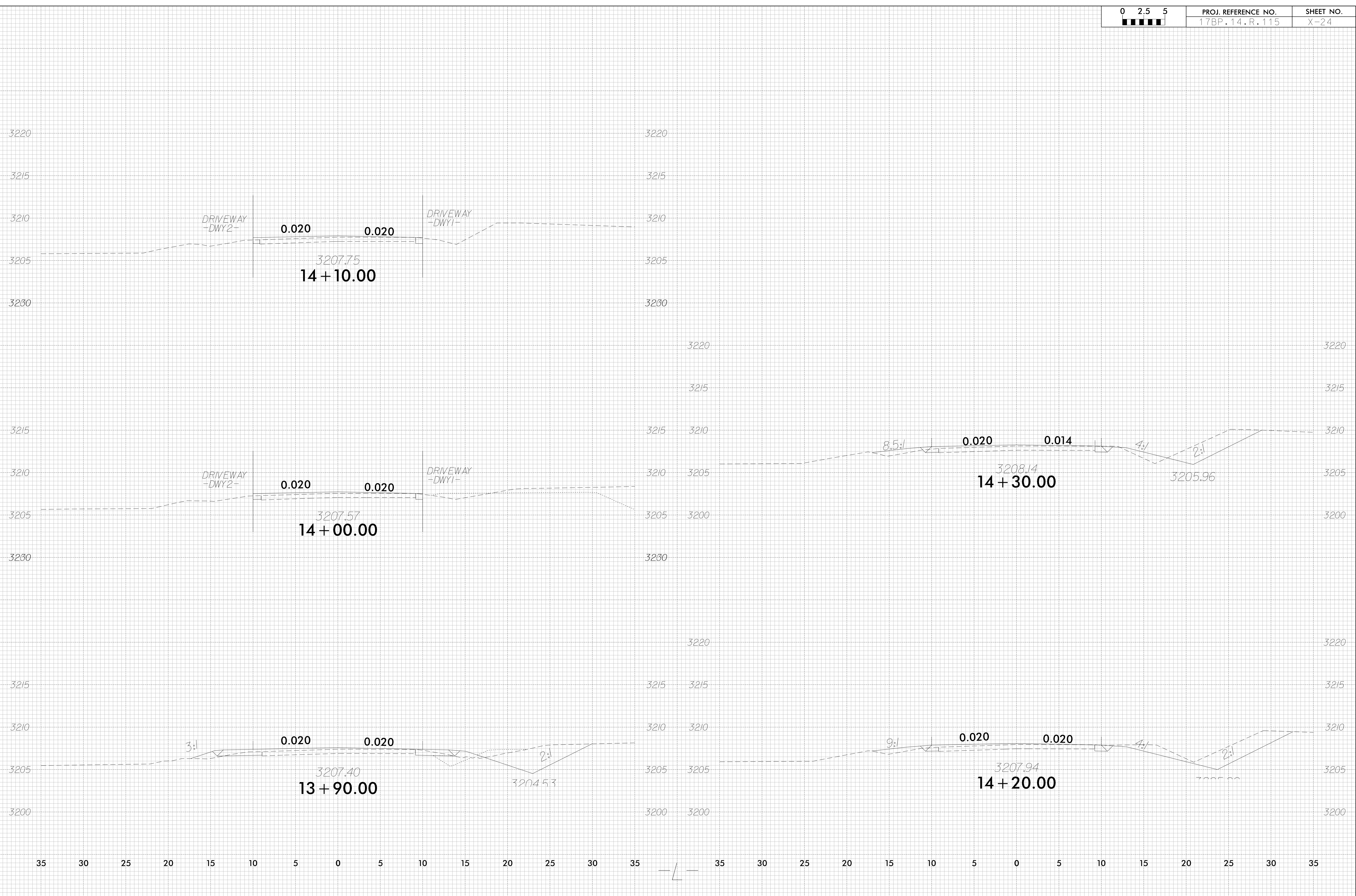

8/23/99

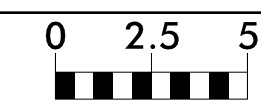

PROJ. REFERENCE NO.
17BP.14.R.115

SHEET NO.
X-25

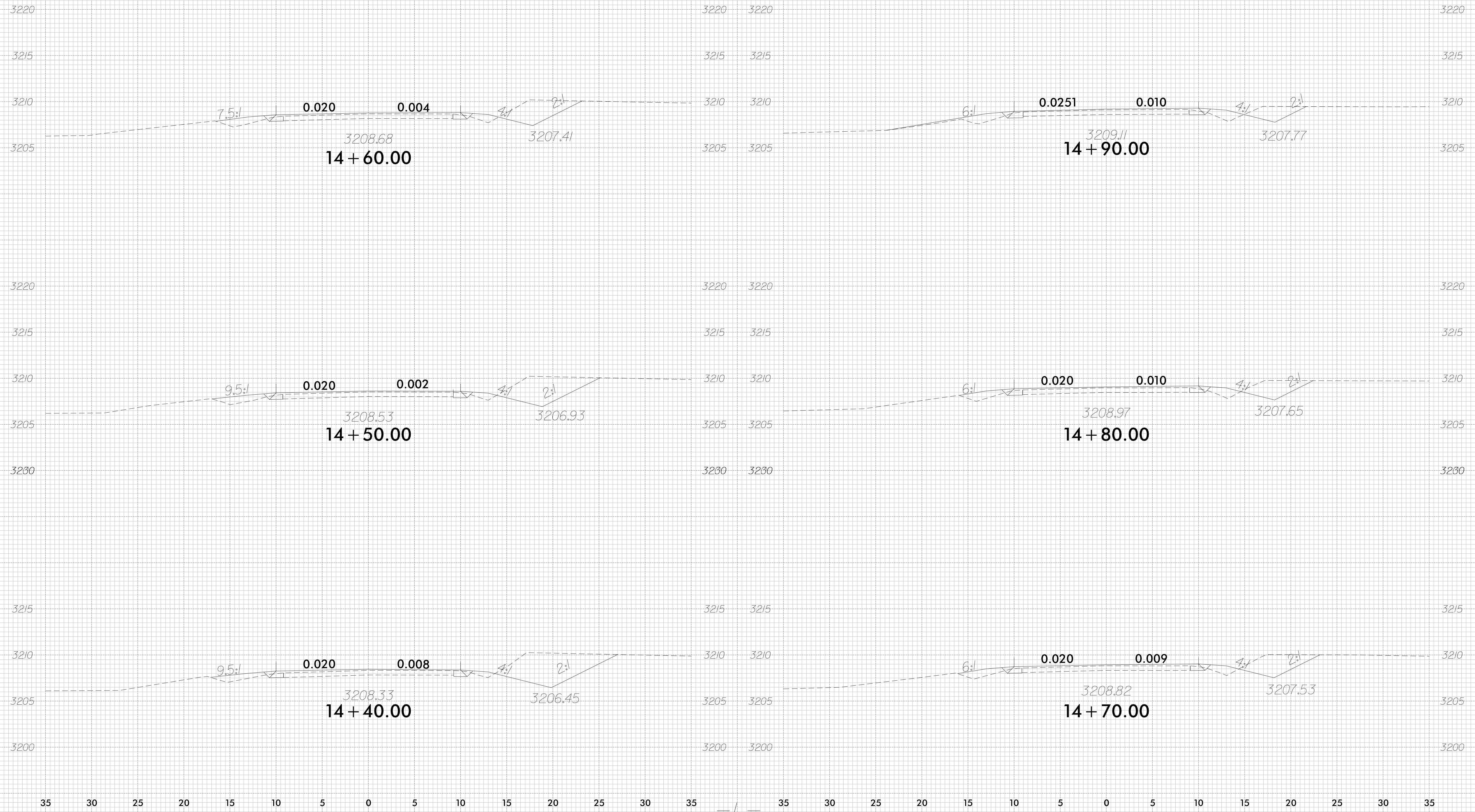

3/1/2021 11:58:33 AM 17BP.14.R.115.XPL.L-2.dgn

8/23/99

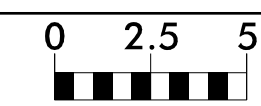

PROJ. REFERENCE NO.	SHEET NO.
17BP.14.R.115	X-26

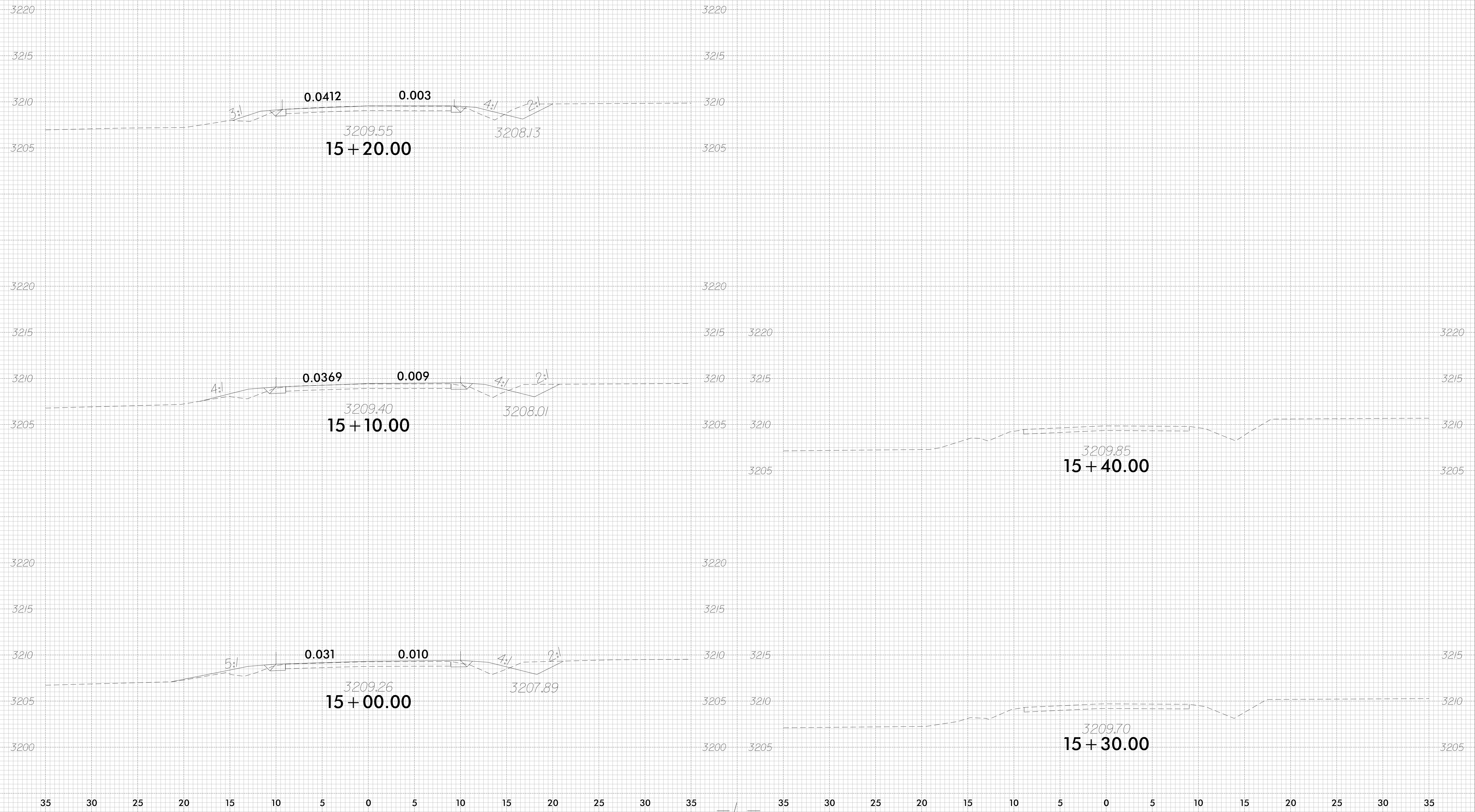

3/1/2021 11:58:33 AM 15S0603301

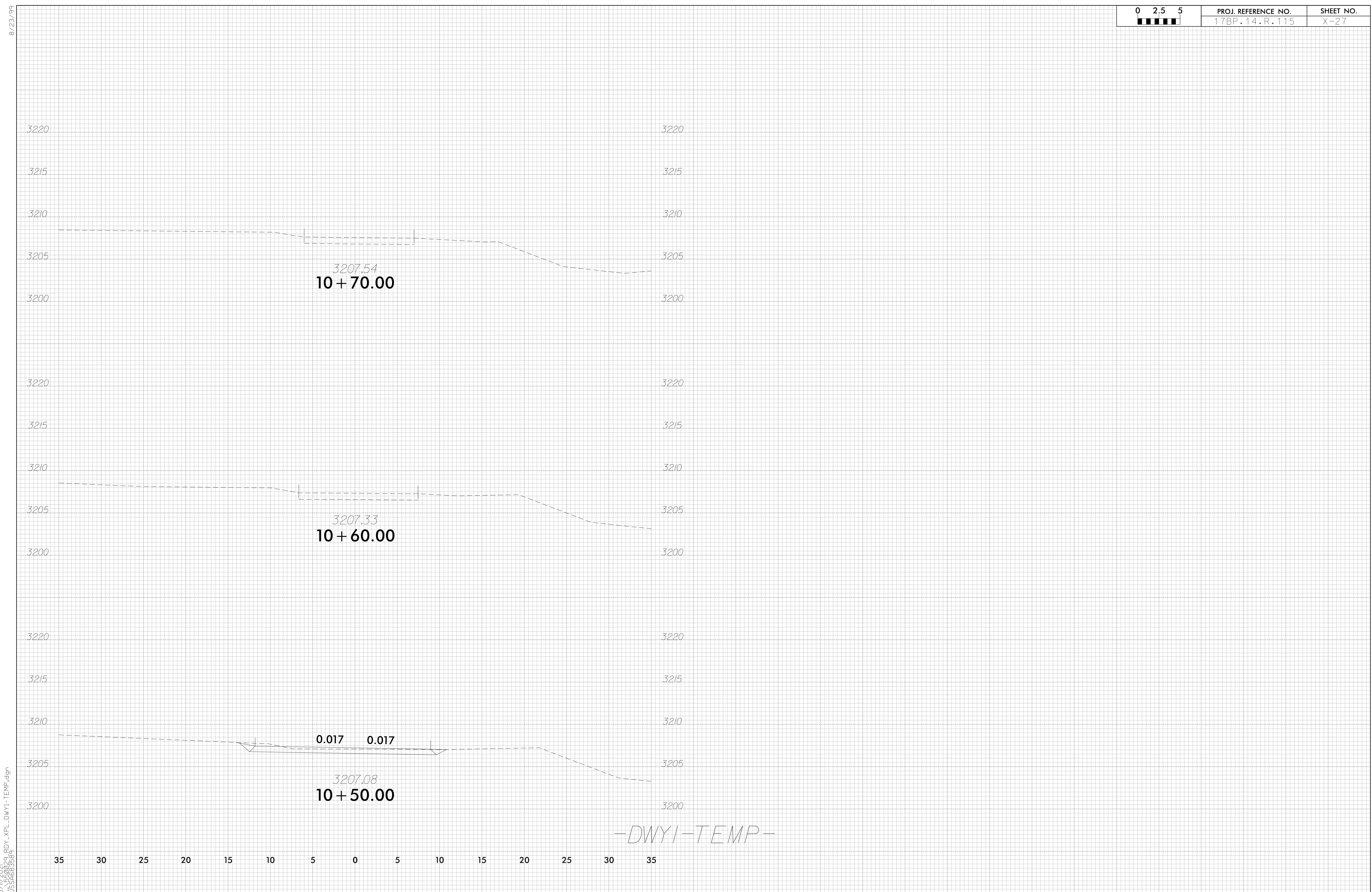

3/11/2021
 3:55:00 PM
 056683589
 ..550029_RDY_XPL_DWYI_TEMP.dgn

8/23/19



PROJ. REFERENCE NO.	SHEET NO.
17BP.14.R.115	X-28

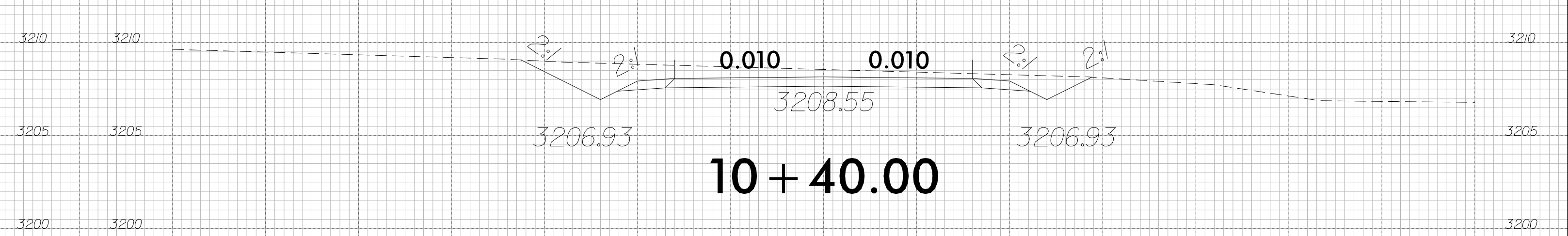
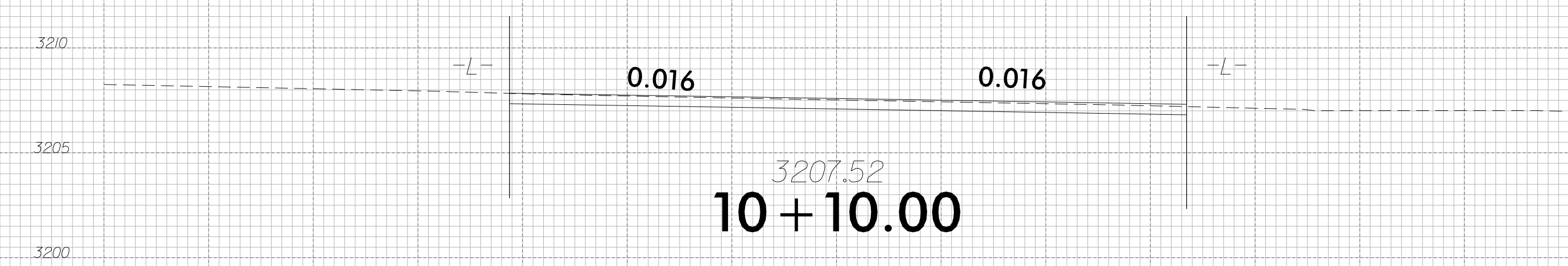
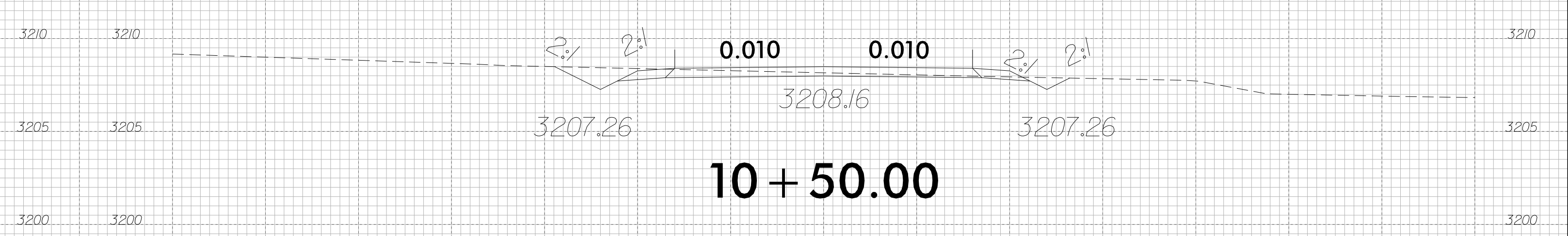
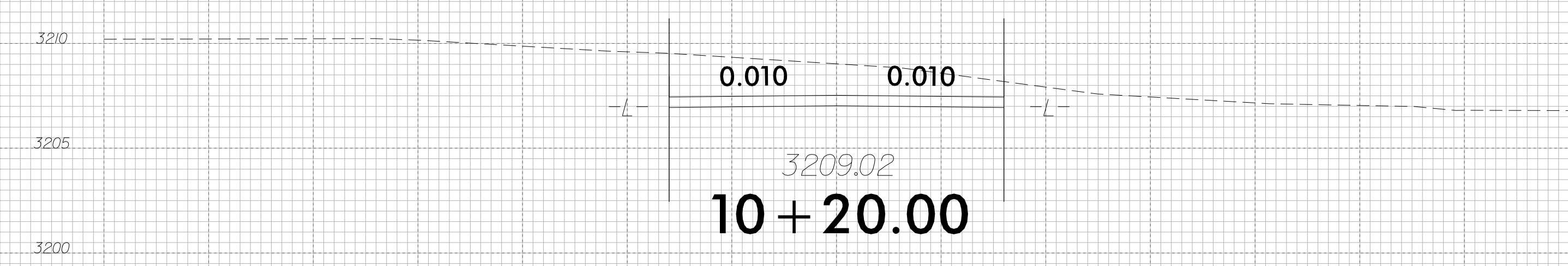
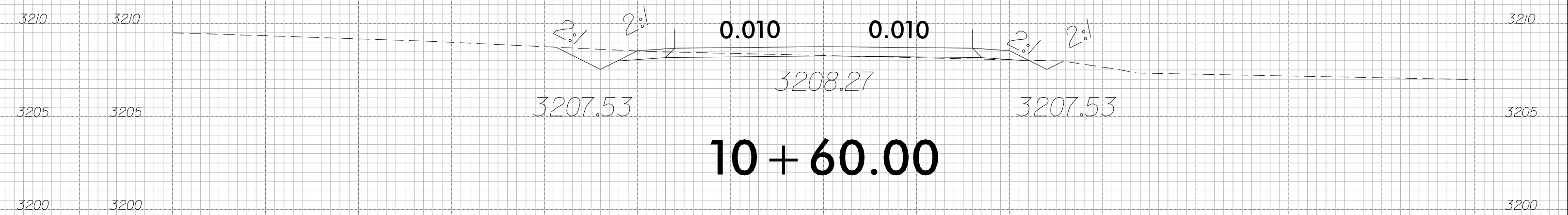
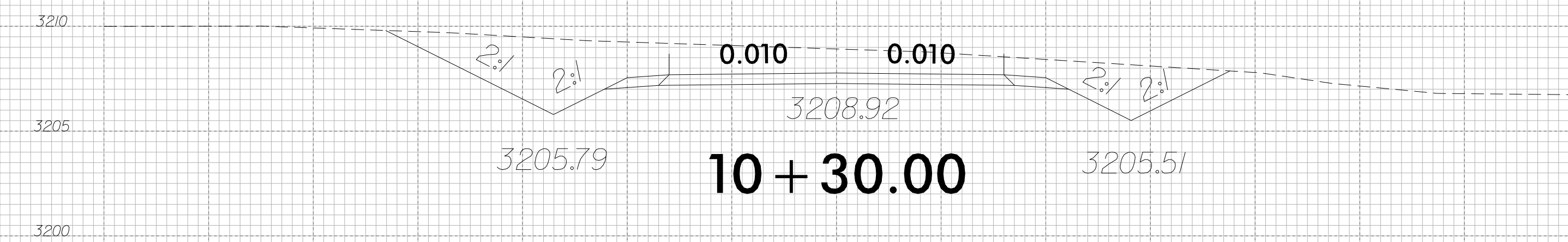

-DWYI-

3/11/2021 11:58:33 AM 17BP.14.R.115_29_RDY_XPL_DWY1.dgn

8/23/99

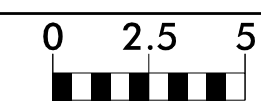

PROJ. REFERENCE NO. 17BP.14.R.115	SHEET NO. X-29
--------------------------------------	-------------------

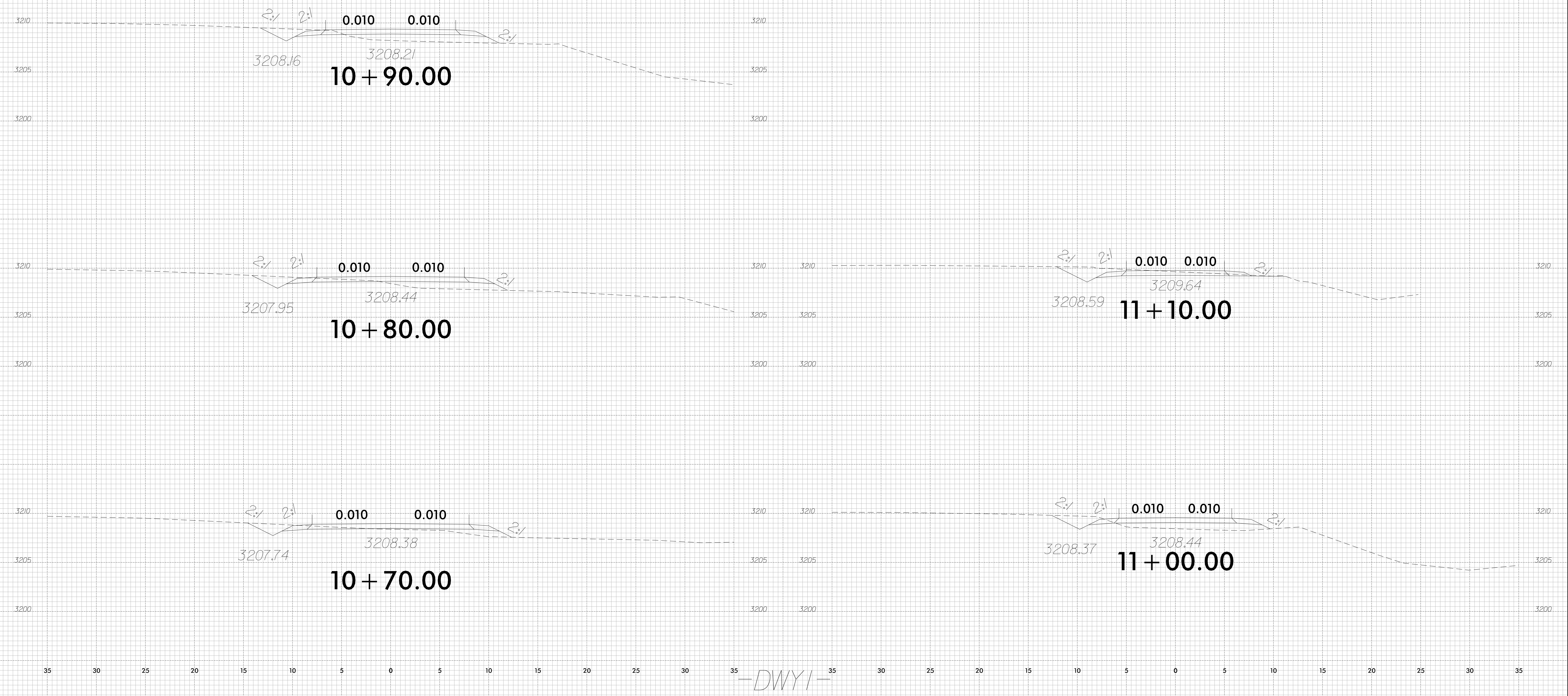

-DWYI-

3/1/2021 10:56:33 AM 105566333.dgn

8/23/99

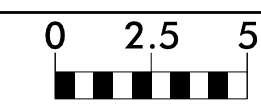

PROJ. REFERENCE NO.
17BP.14.R.115

SHEET NO.
X-30

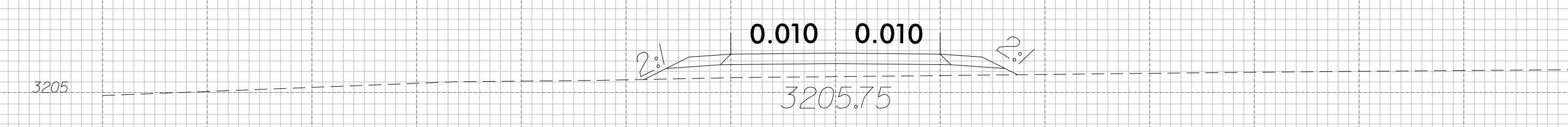

10 + 30.00

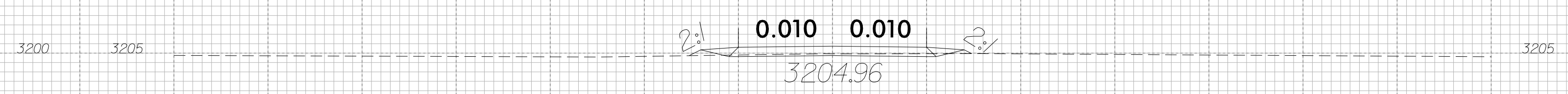

10 + 70.00

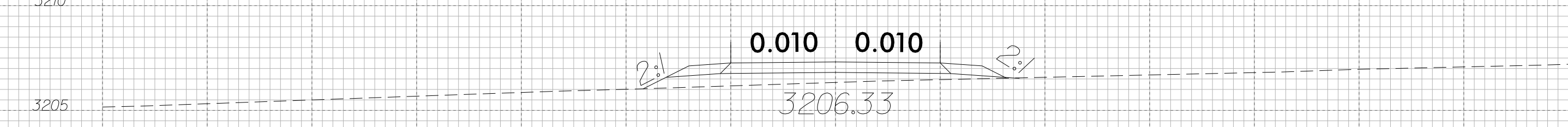

10 + 20.00

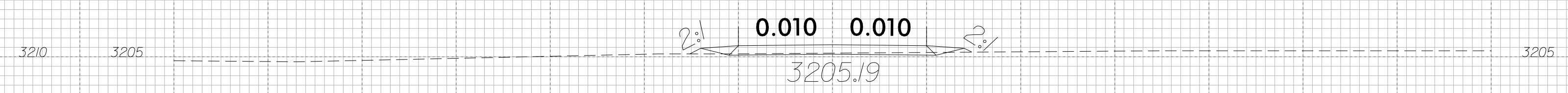

10 + 60.00

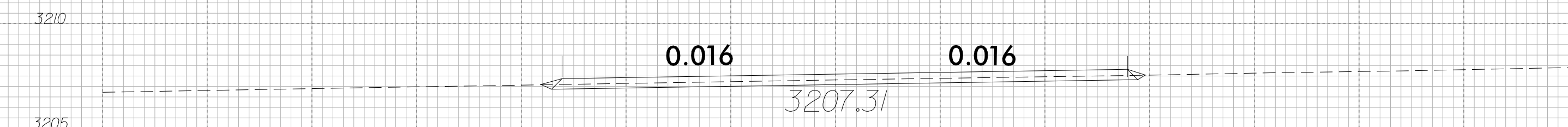

10 + 10.00

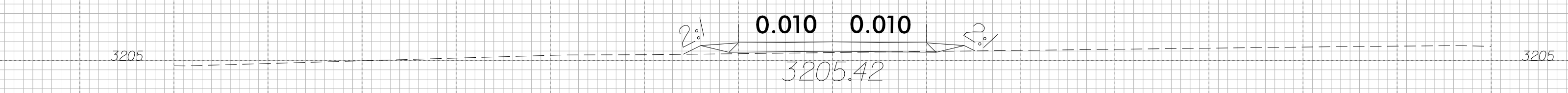

10 + 50.00

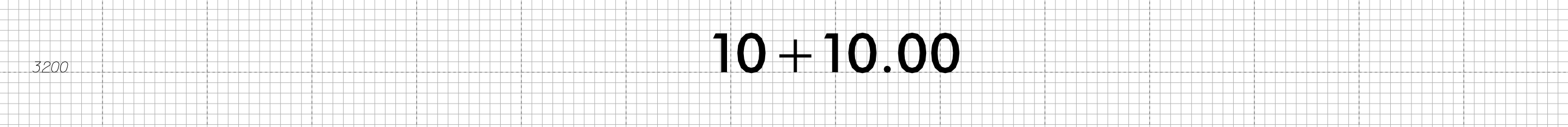

10 + 40.00

DWY2

3/1/2021 10:56:33 AM US:50029_RDY_XPL_DWY2.dgn

8/23/99

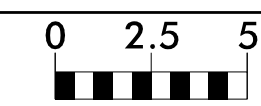

PROJ. REFERENCE NO.
17BP.14.R.115

SHEET NO.
X-31

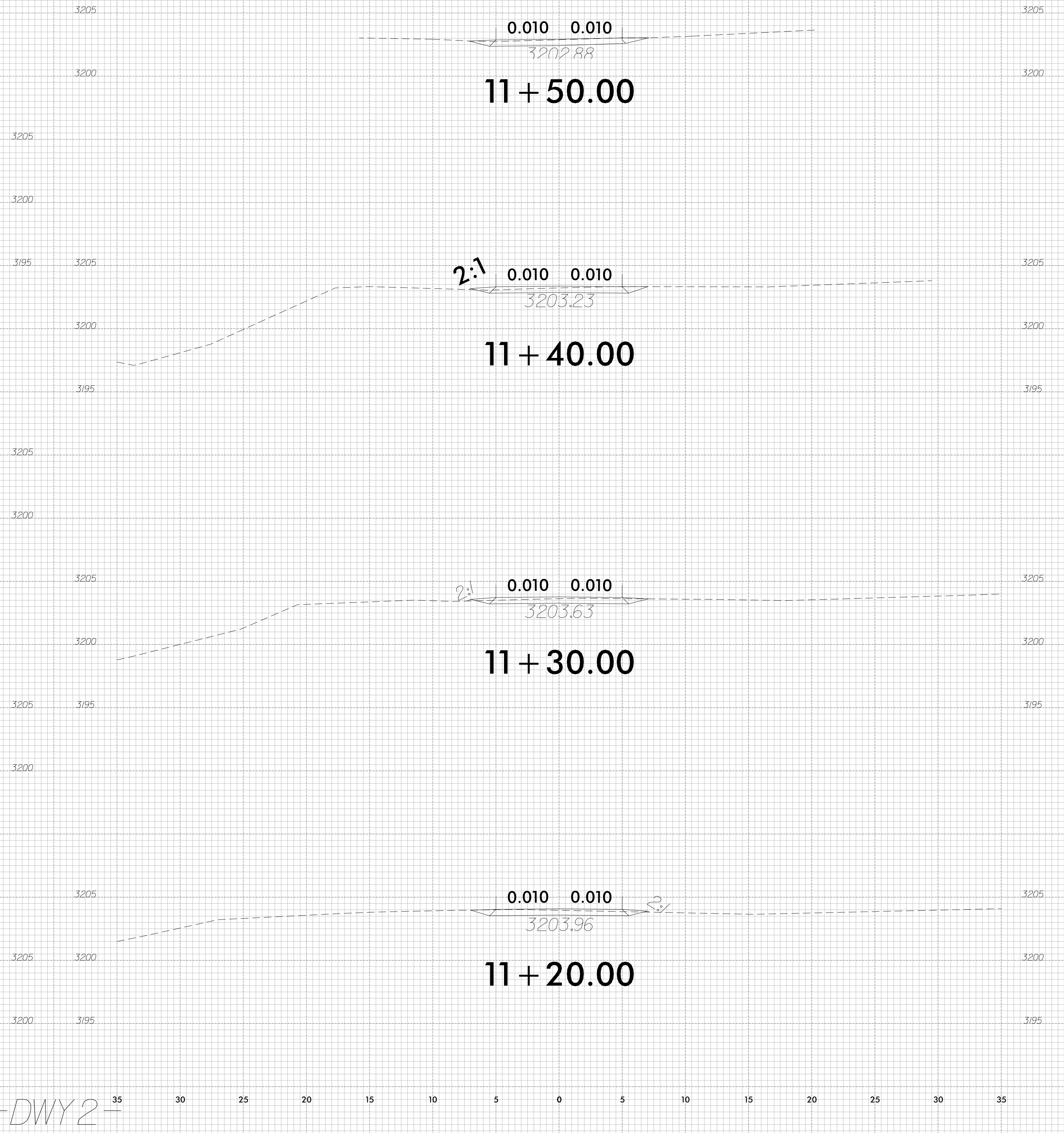
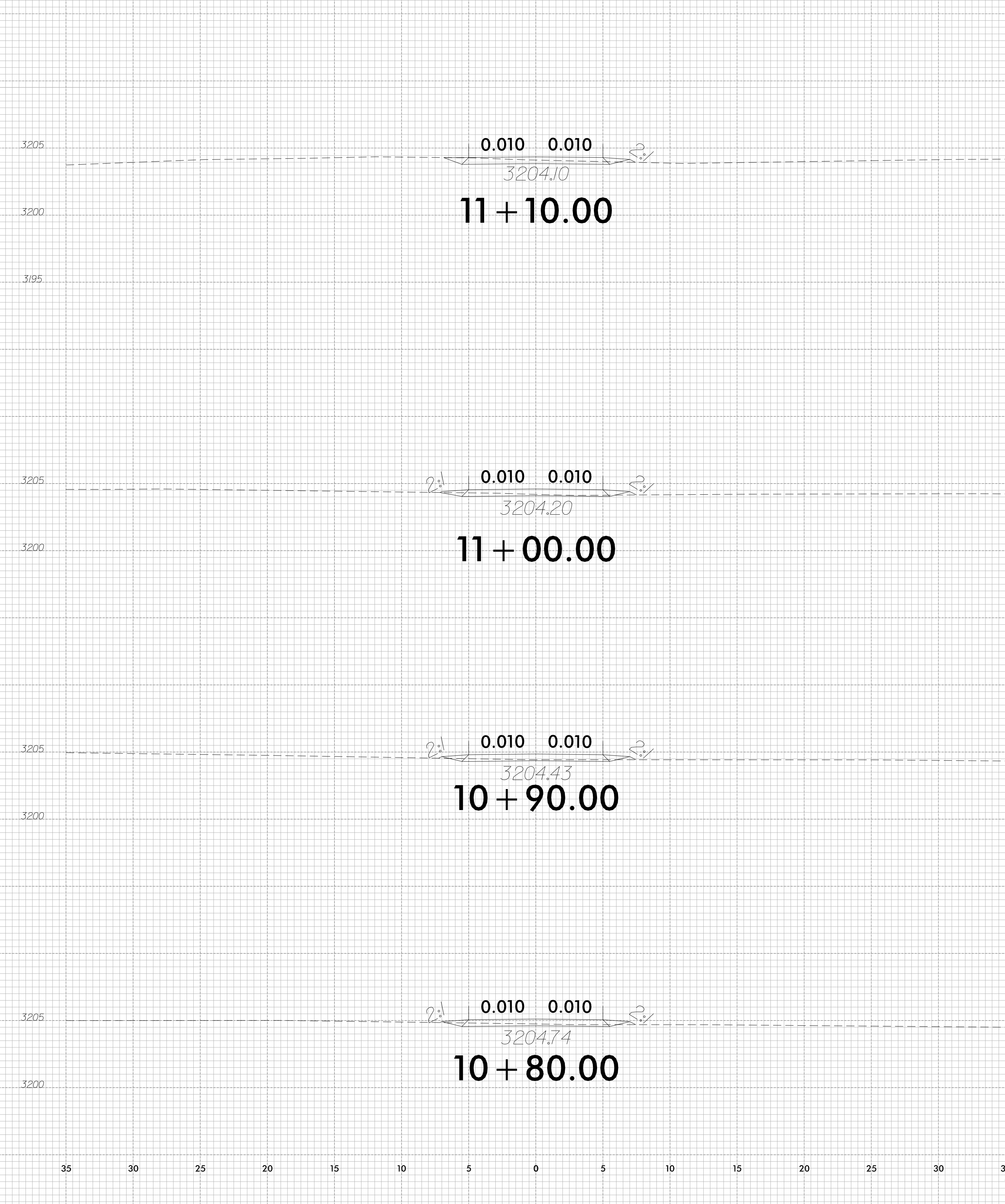

DWY2

3/1/2021 11:58:33 AM 11550029_RDY_XPL_DWY2.dgn