

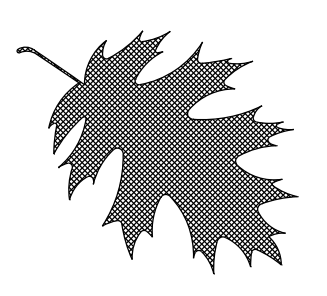

HIGHWAY LANDSCAPE DEVELOPMENT PROJECT



T.I.P. #	STATE PROJECT W.B.S. #	SHEET #	SHEET # TOTAL
R-2303C (L)	34416.3.14	L 1	11
FED. PROJ. #	DESCRIPTION	DIVISION	
-	LANDSCAPE	3	

PROJECT: R-2303 C NC 24 - ROSEBORO NC

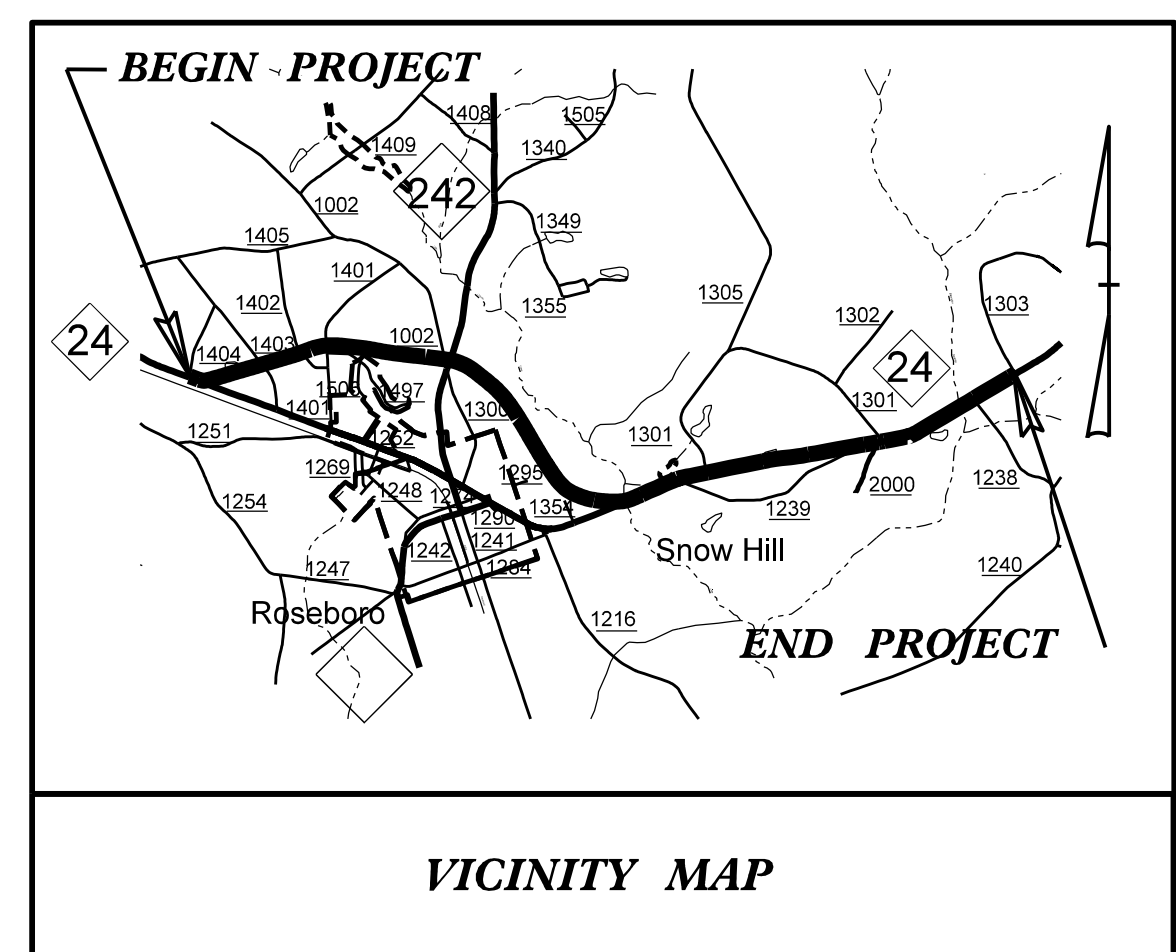

STATE OF NORTH CAROLINA DIVISION OF HIGHWAYS SAMPSON COUNTY

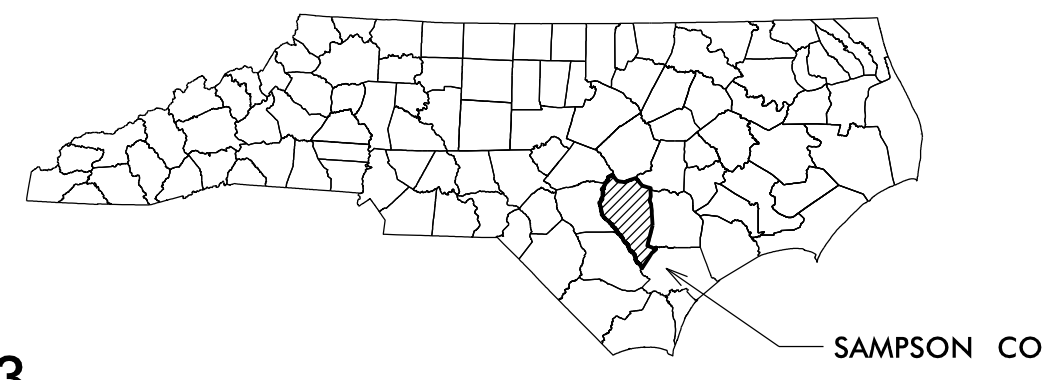

LOCATION: NC 24 FROM SR 1404 (DOWDY ROAD) TO SR 1303 (MITCHELL LOOP ROAD)

* LANDSCAPE DEVELOPMENT WORK LIMITED TO THE AREAS NOTED ON THE PLANS.

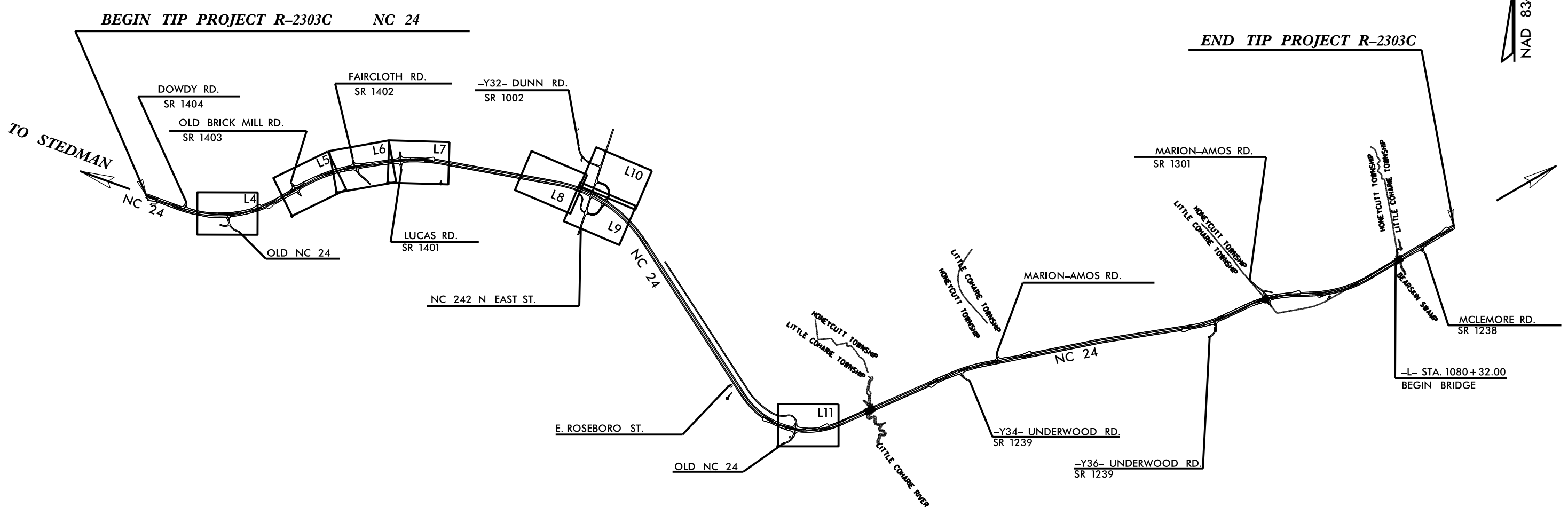

SUMMARY OF QUANTITIES

Qty.	Unit	Botanical Name/ Item Description	Common Name	Size	Caliper	Furnish	Remarks
68	EA	<i>Platanus occidentalis</i>	American Sycamore	8-10'		B&B	As Shown
180	EA	<i>Taxodium distichum</i>	Bald Cypress	8-10'		B&B	As Shown
241	EA	<i>Pinus taeda</i>	Loblolly Pine	6-8'		B&B	As Shown
115	EA	<i>Juniperus virginiana</i>	Eastern Red Cedar	5-6'		B&B	As Shown
4108	EA	<i>Muhlenbergia capillaris</i>	Pink Muhly Grass	10-12"		QT	3' O.C.
75	CY	Topsoil					
2952	CY	Mulch for Planting					
110	M/G	Water for Planting					
2650	SY	Pre emergence Herbicidal Treatment					
2650	SY	Post emergence Herbicidal Treatment					
3	EA	Sign Structure					
0.75	AC	Clearing & Grubbing					

CONVENTIONAL SYMBOLS

County Line
City or Town Line	-----
Exist. Right of Way Line Marker	-----△-----
Prop. Right of Way Line Marker (By Others)	-----▲-----
Prop Right of Way Line Marker (By Contract)	-----○-----
Exist. Control of Access Line	-----○-----
Prop. Control of Access Line	-----○-----
Property Line	-----○-----
Easement Line	-----○-----
Slope Stake Line	-----○-----
Exist. Fence	-----○-----
Prop. Woven Wire Fence	-----○-----
Prop. Chain Link Fence	-----○-----
Exist. Road	=====
Prop. Road	=====
Guardrail	=====
Survey Line	-----○-----
Denotes Line Equality	-----○-----
Bridge	=====
Culvert	=====
Railroad	=====
Woods	=====
Exist. Telephone Pole	-----○-----
Prop. Telephone Pole	-----○-----
Tower Pole and Line	-----○-----
Exist. Power Pole	-----○-----
Prop. Power Pole	-----○-----
Sanitary Sewer Line	-----○-----
Water Line	-----○-----
Gas Line	-----○-----
Picnic Shelter	-----○-----
Regeneration	-----○-----
Reforestation	-----○-----

INDEX OF SHEETS:

L1	TITLE, DESCRIPTION, & SUMMARY OF QUAN.
L2	PLANTING DETAILS
L3	SIGN DETAILS
L4- L11	LANDSCAPE DEVELOPMENT PLANS

PREPARED BY: BK DATE: 3/2020

DATE	REVISION DESCRIPTION
6-22-21	SITE REVIEW ADJUSTMENTS & REVISE SIGN DETAILS

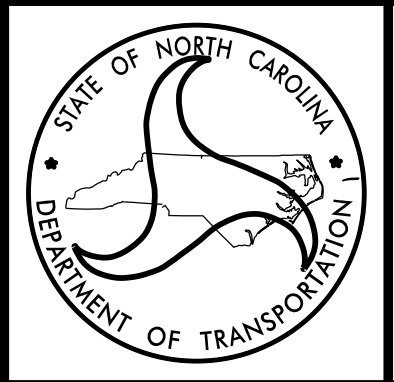

STATE OF NORTH CAROLINA
DEPARTMENT OF TRANSPORTATION

LOCATION: ROSEBORO NC
TYPE OF WORK: LANDSCAPE DEVELOPMENT
COUNTY: SAMPSON COUNTY



2014 American Standard for Nursery Stock
2018 NCDOT STANDARD SPECIFICATIONS
PREPARED IN THE OFFICE OF:
NCDOT- ROADSIDE ENVIRONMENTAL UNIT
LANDSCAPE DESIGN & DEVELOPMENT SECTION
1557 MAIL SERVICE CENTER
RALEIGH NC 27699 919-707-2920

\$\$\$\$\$SYTIME\$\$\$\$\$
\$\$\$\$\$SDGN\$\$\$\$\$
\$\$\$\$\$USERNAME\$\$\$\$\$

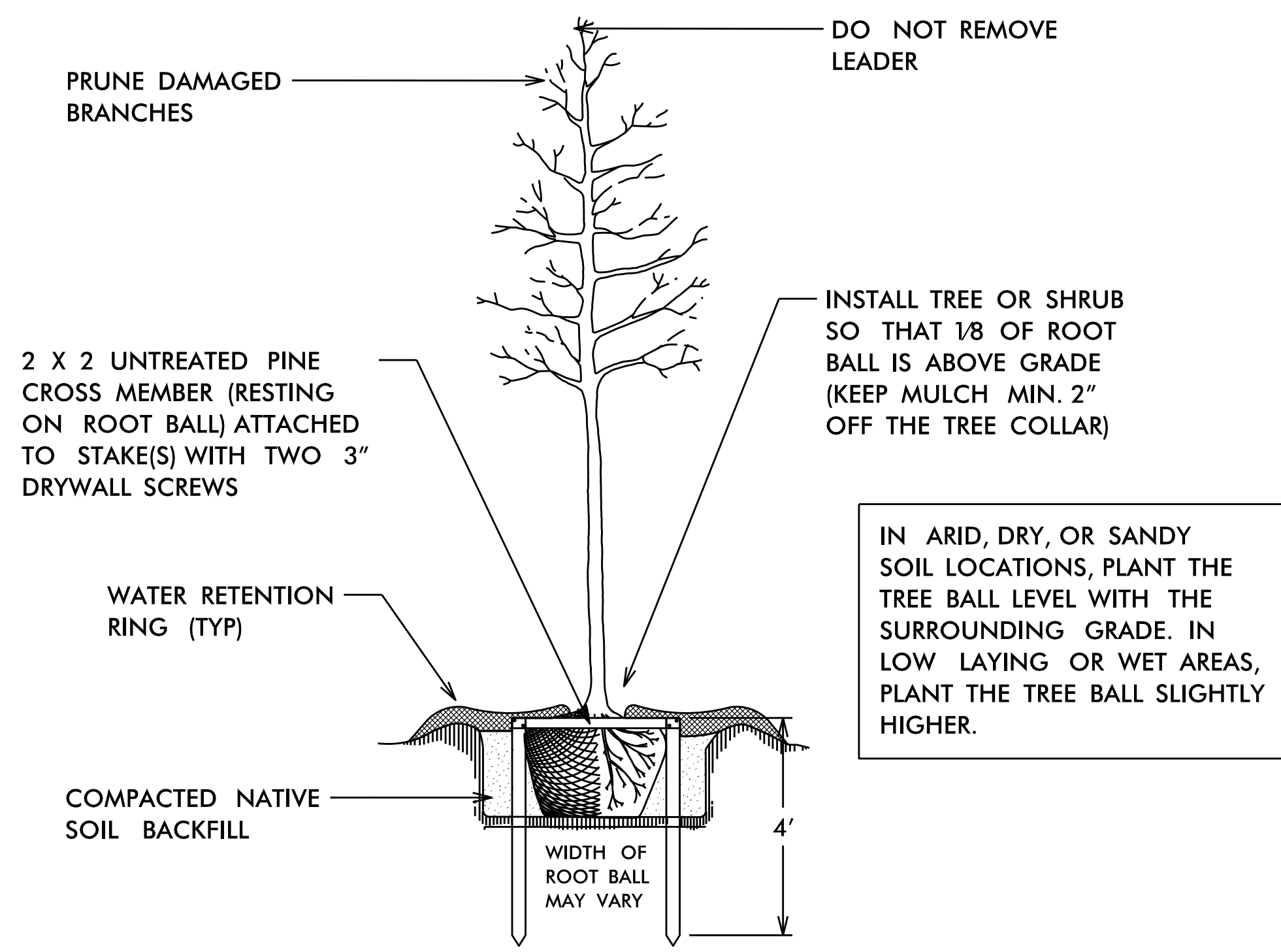

IN ARID, DRY, OR SANDY SOIL LOCATIONS, PLANT THE TREE BALL LEVEL WITH THE SURROUNDING GRADE. IN LOW LAYING OR WET AREAS, PLANT THE TREE BALL SLIGHTLY HIGHER.

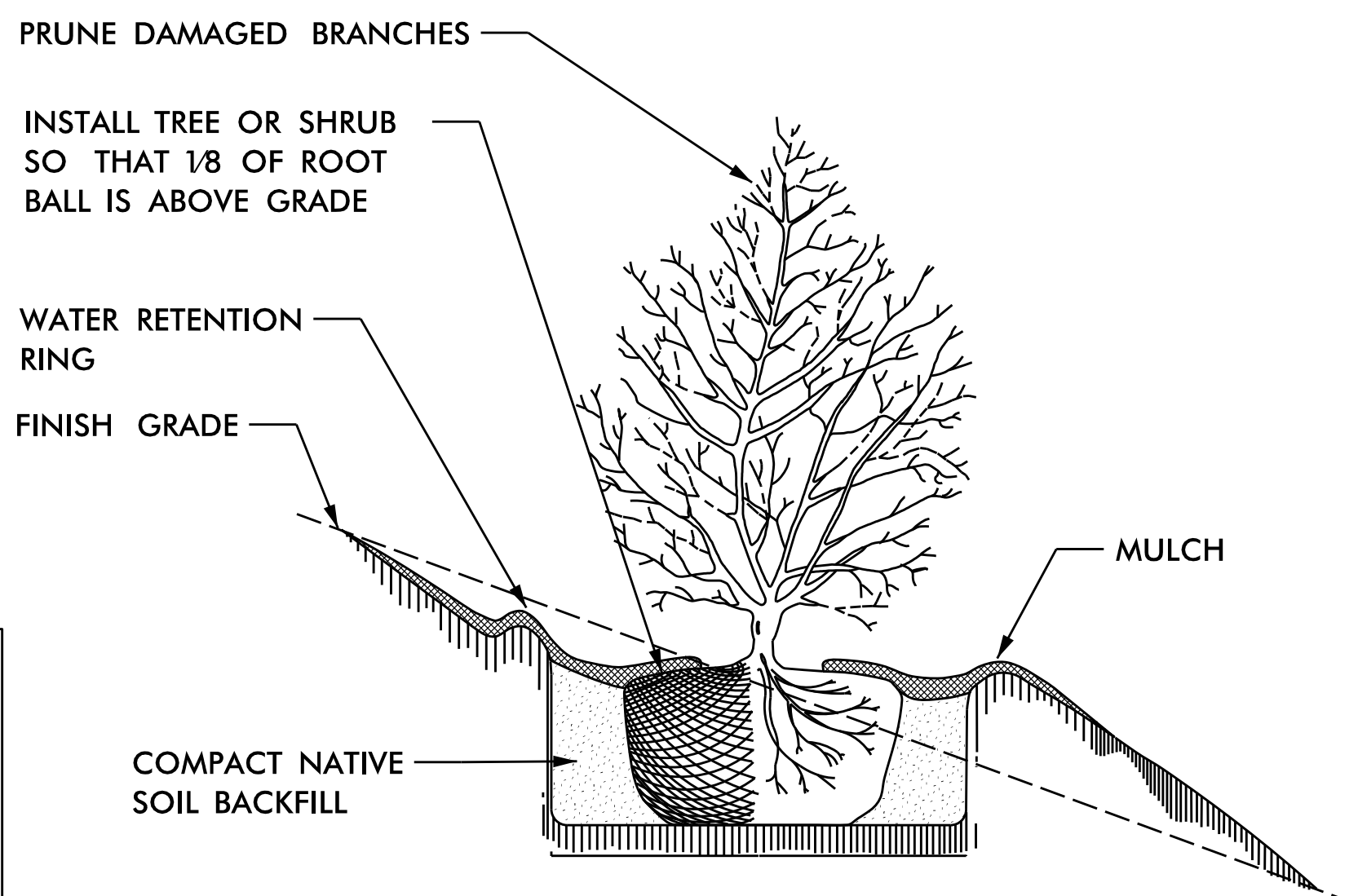

TREE OR SHRUB PLANTING DETAIL (SLOPING GROUND)

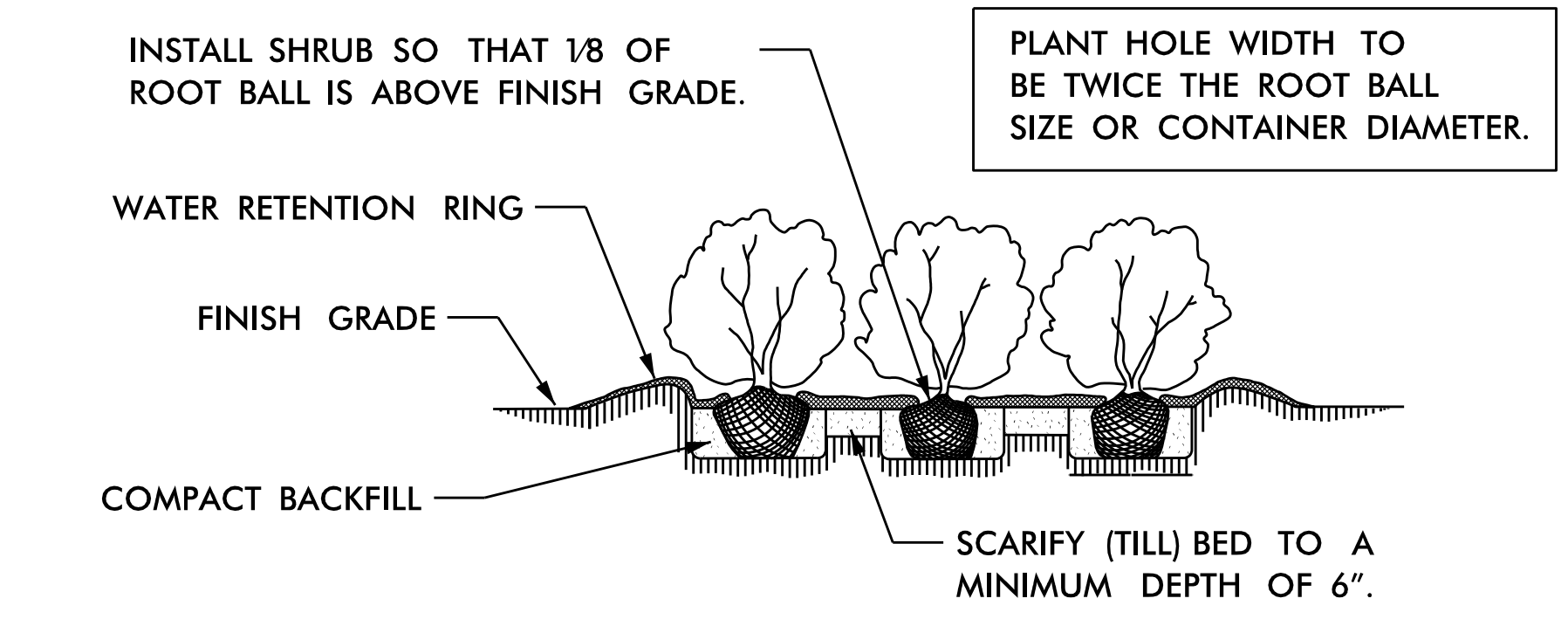

SHRUB BED PLANTING DETAIL

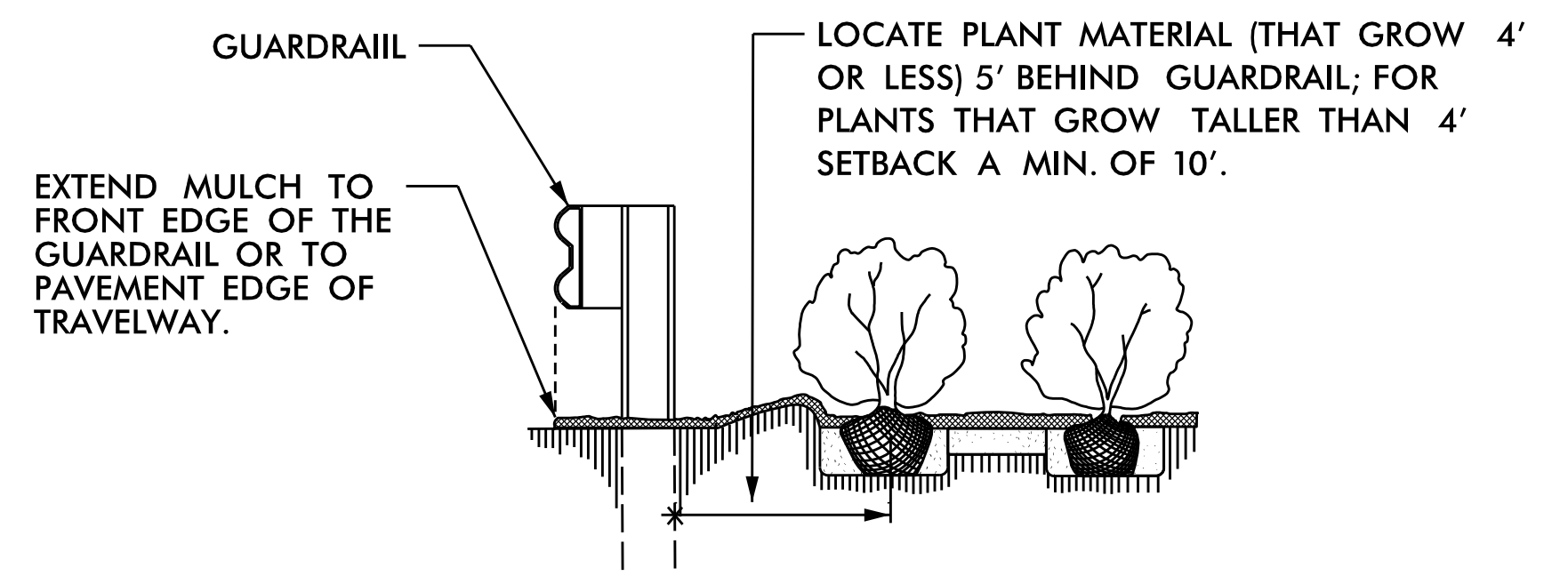

GUARDRAIL MULCHING DETAIL
USE AS DIRECTED BY FIELD ENGINEER

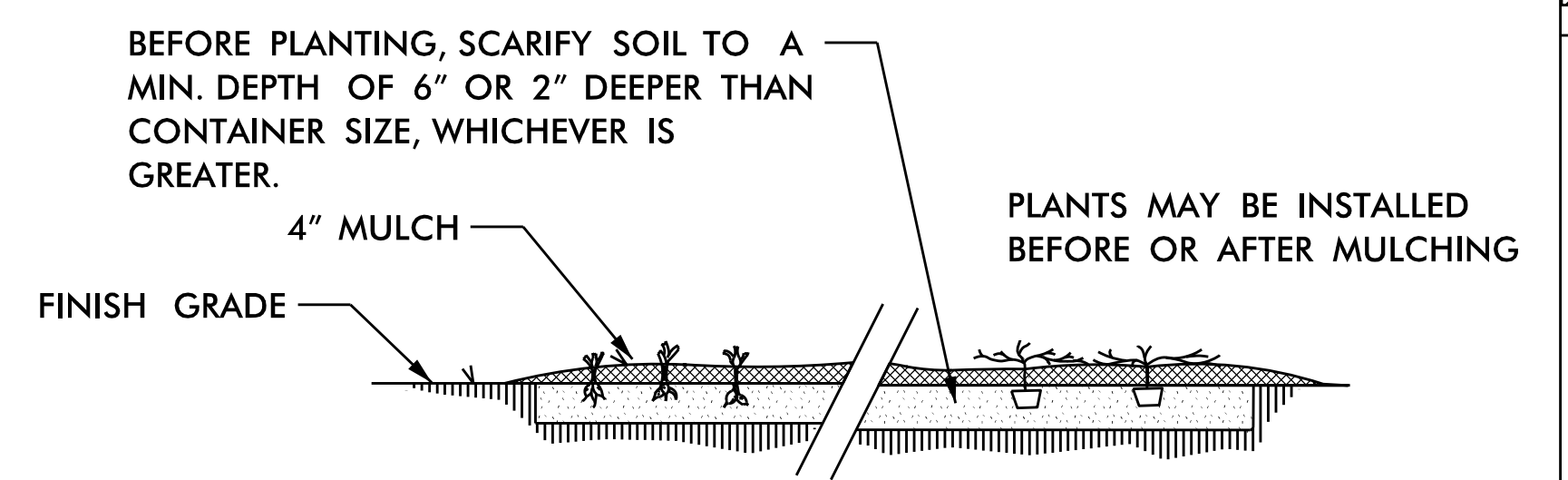

GROUND COVER/BEDDING PLANT DETAIL

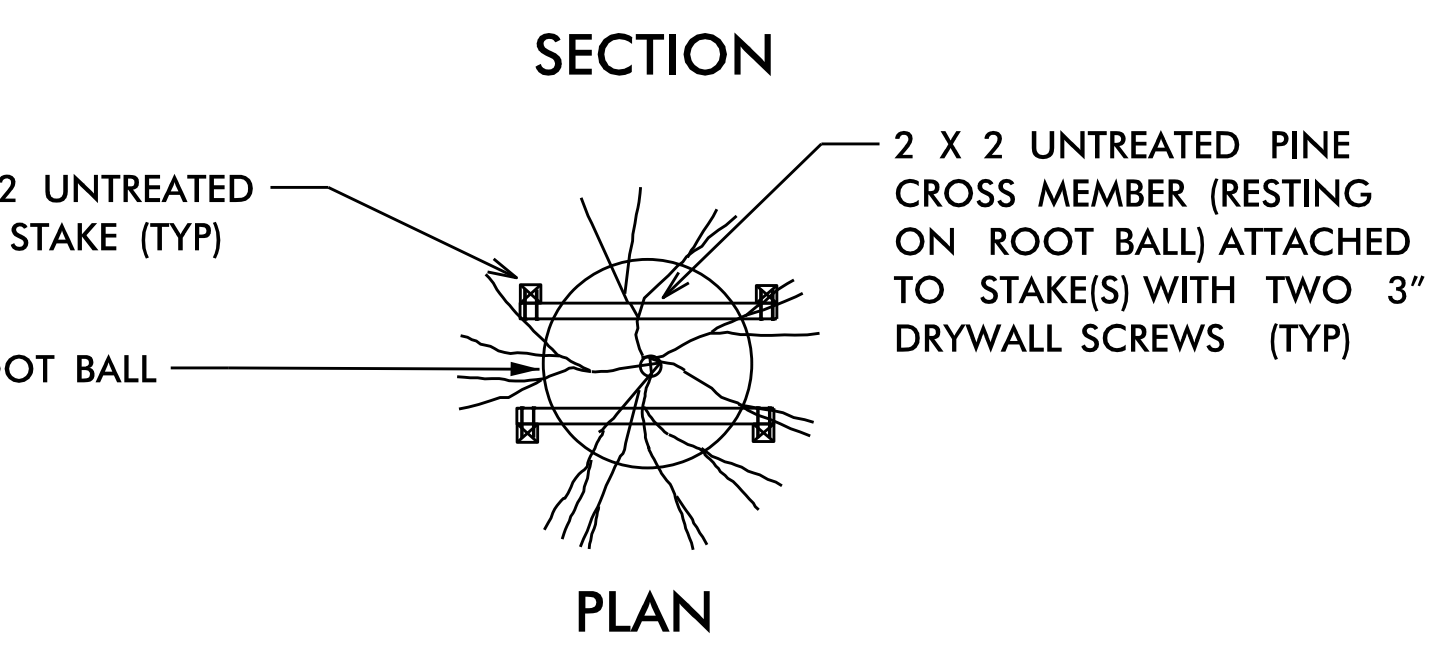

TREE PLANTING & ROOT BALL STAKING DETAIL (STAKE TREES 8' OR TALLER)

NOTES:

- PLANT HOLE WIDTH TO BE TWICE THE ROOT BALL SIZE OR CONTAINER DIAMETER.
- APPLY HERBICIDES A MIN. OF 7 DAYS PRIOR TO PLANTING, BY LABEL INSTRUCTIONS, OR AS DIRECTED BY THE NCDOT ENGINEER.
- APPLY FERTILIZER AT PLANTING TIME IN THE FORM OF A SLOW RELEASE PELLET OR TABLET. APPLY AT RATE RECOMMENDED BY MANUFACTURER, BOTH RATE AND FORMULATION MUST BE APPROVED BY FIELD ENGINEER PRIOR TO APPLICATION.
- ALL PRUNING TO FOLLOW STANDARD ARBORICULTURAL PRACTICES AS SPECIFIED BY INTERNATIONAL SOCIETY OF ARBORICULTURE.
- DO NOT ATTEMPT TO STRAIGHTEN A TREE THAT HAS BEEN PLANTED AT AN ANGLE WITH THE USE OF STAKING OR GUYING. DIG TREE AND REPLANT TO UPRIGHT POSITION.

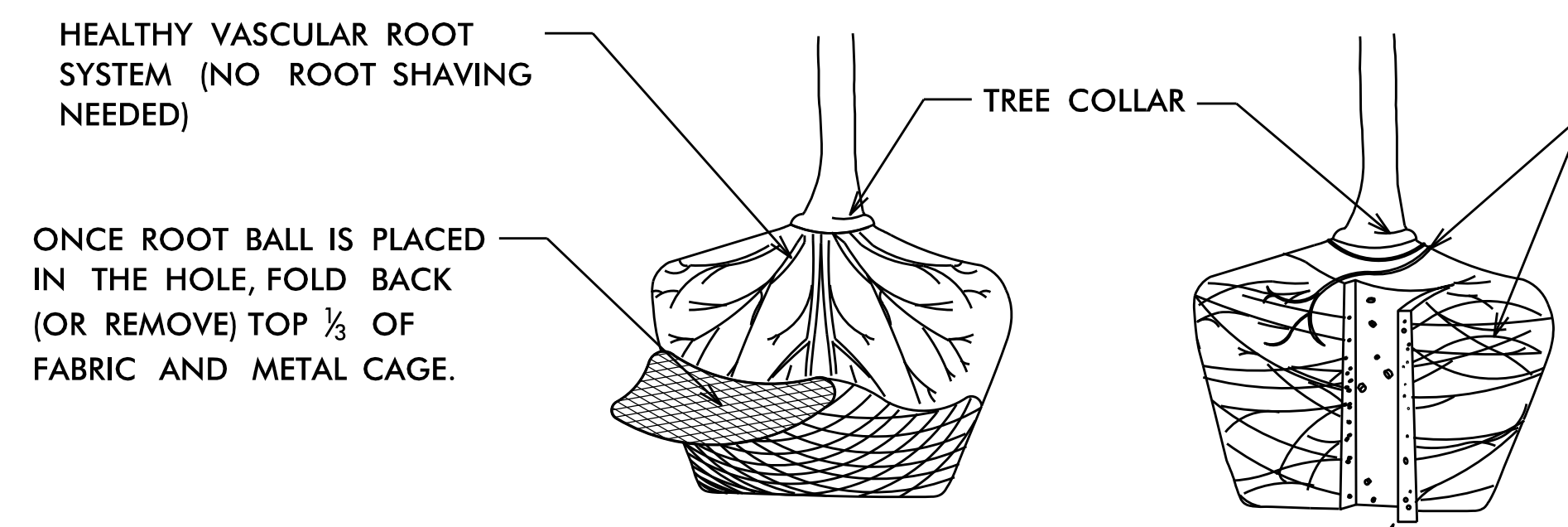

ROOT BALL SHAVING CAN BE PERFORMED JUST PRIOR TO PLANTING OR AFTER PLACING IN THE HOLE.

SHAVE OUTER PERIPHERY OF ROOT BALL (MAX. 2") WITH SHARP SPADE SHOVEL (OR HAND SAW) TO REMOVE GIRDLING ROOTS.

TREE PLANTING INSTRUCTIONS (FOR CONTAINER OR BALLED & BURLAPPED TREES)

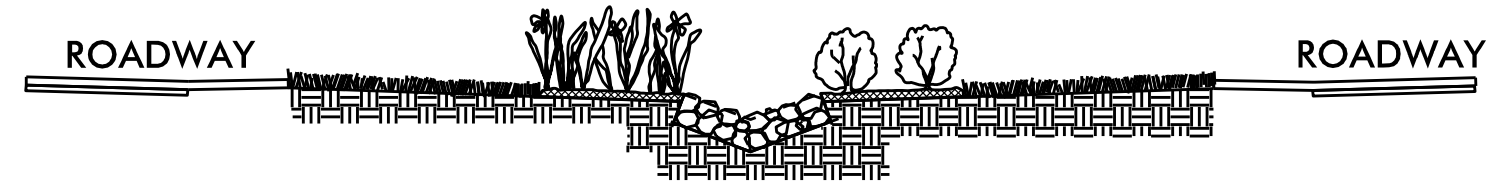

MIN. 12" DEEP CLASS "A" STONE ON FILTER FABRIC LINER IN DITCH. PLACE STONE FLUSH WITH DITCH GRADE FOR MAXIMUM WATER FLOW.

CLASS "A" STONE DITCH LINING DETAIL

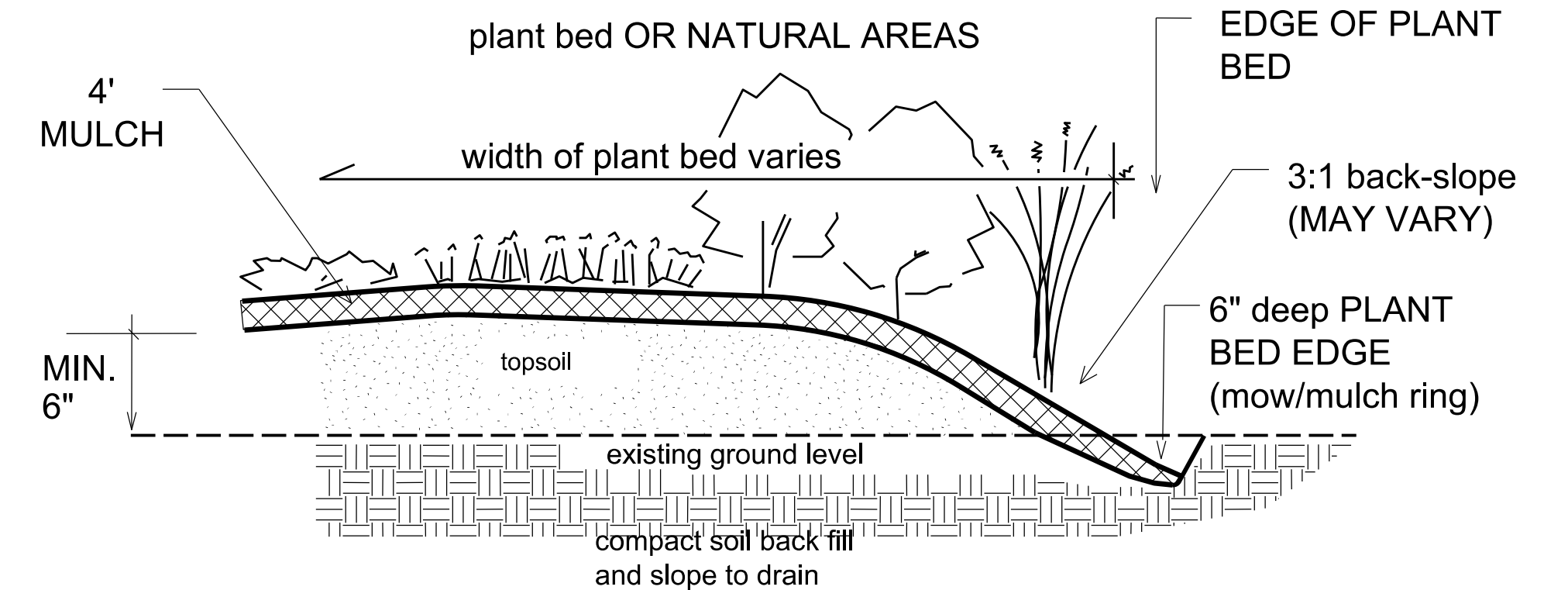

PLANT BED EDGE DETAIL

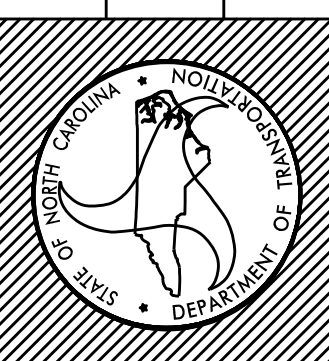
North Carolina Department of Transportation	Roadside Environmental Unit		Aesthetic Engineering Section	
				
	PROJECT TITLE: R-2303 C NC 24 LANDSCAPE DEVELOPMENT ROSEBORO NC SAMPSON CO			
Plans Drawn By:				
BK				
WBS				
34416.3.14				
Date				
3 / 22 / 2020				
Sheet Description				
Planting Details				
T.I.P. #				
R-2303 C				
Sheet #				
L 2				

Match existing post and finial presently used by the Town of Roseboro.

Post: 4" Fluted 6063 T5 Aluminum.

Height: 10' (min.- confirm with NCDOT Eng.)

Finish: Exterior Grade Black Powder Coated (min. 2 coats);
with Satin Acrylic Polurethane.

Mounting: See NCDOT Standards.

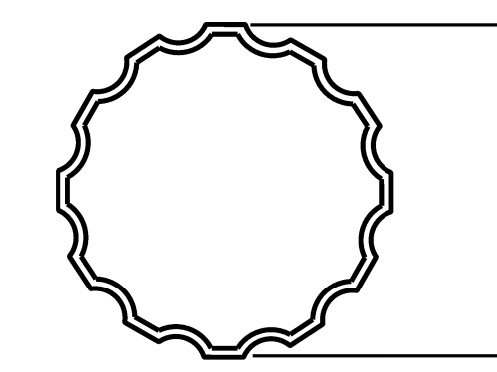

FLUTED POST SECTION



ROSEBUD FINIAL



Decorative Aluminum
2 pc Base (9" x 10")

Reference NCDOT Standard Drawings:

- 901.80 Sign Mounting Details
- 903.10 Ground Mounting Sign Supports

Refer to website:

<https://connect.ncdot.gov/resources/Specifications/2018StandardRdwyDrawings/>

The Roseboro sign will be provided by NCDOT. All other work and materials, to complete the installation, will be the responsibility of the contractor.

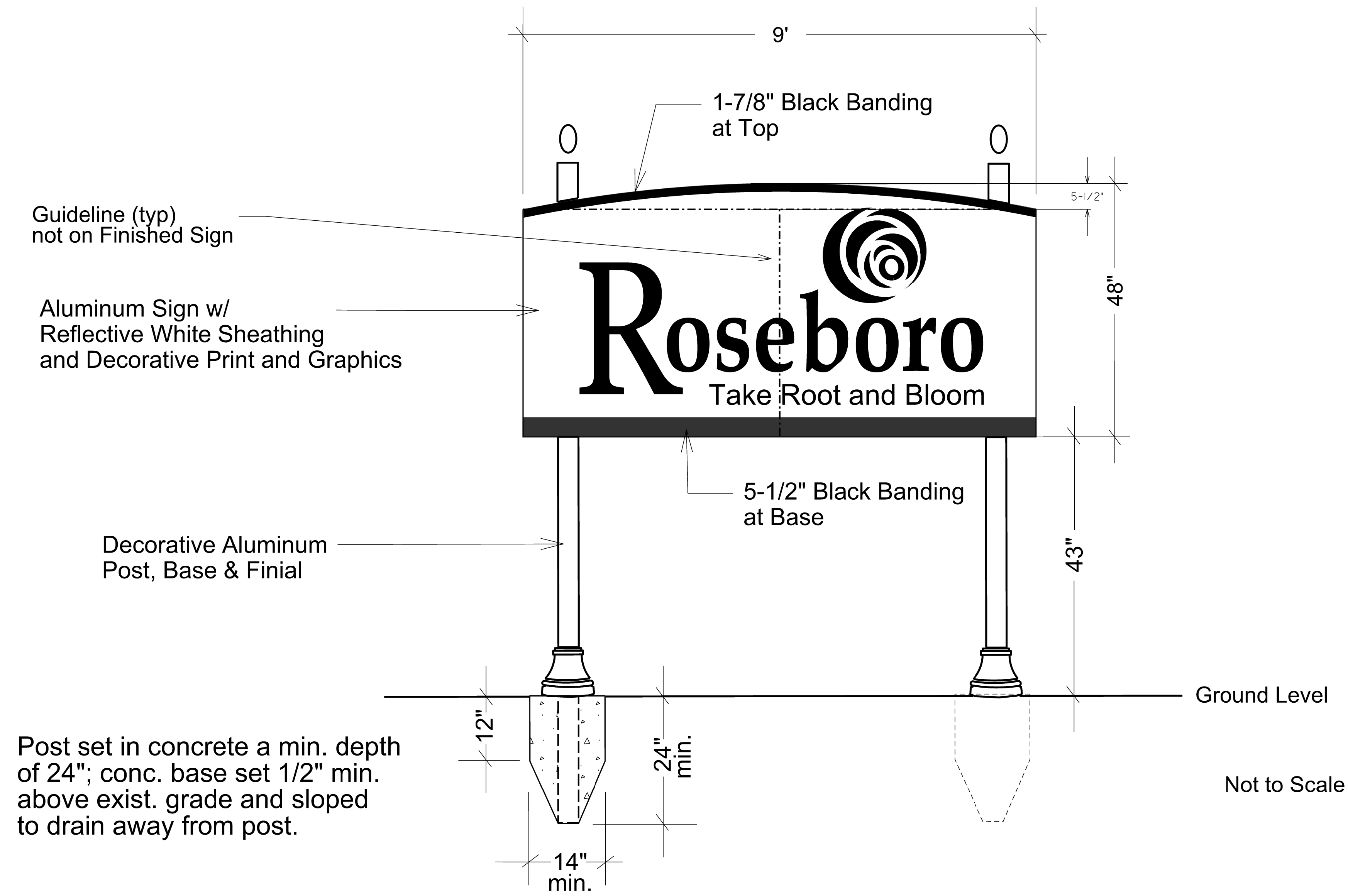

Not to Scale



WHITE REFLECTIVE SHEATHING BACKGROUND

RED (PMS 186; HTML C60C30)

BLACK
FONT: Book Antique; 'R' extended

RED (PMS 186; HTML C60C30)
FONT: Arial

Not to Scale

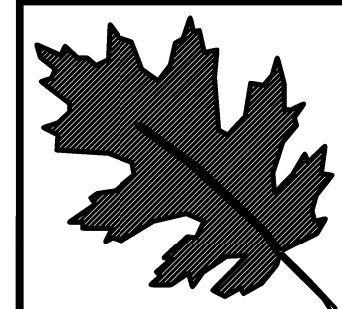

NCDOT - ROADSIDE ENVIRONMENTAL UNIT
AESTHETIC ENGINEERING SECTION
1557 MAIL SERVICE CENTER, RALEIGH, NC 27699-1557
PH: 919-707-2920 FAX: 919-715-2554
http://www.ncdot.org/doh/operations/dp_chief_eng/roadside/

NC 24 - R-2303C
Roseboro NC
WBS#: 34416.3.14

reu engineer :

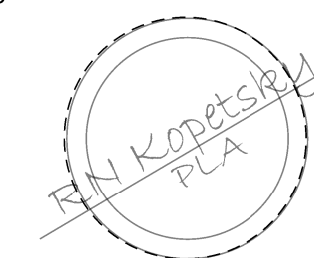

sheet description:

LANDSCAPE ENHANCEMENT

SIGN DETAILS

prel design date:

checked by & date :

final design date :

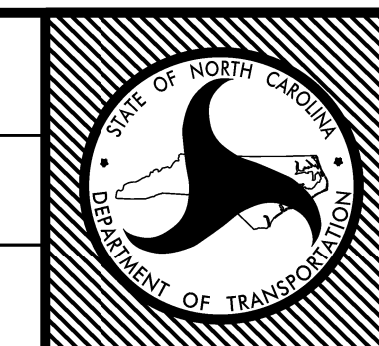

sheet no :
L3

total sheet no : 11

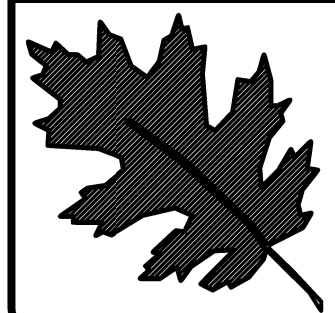
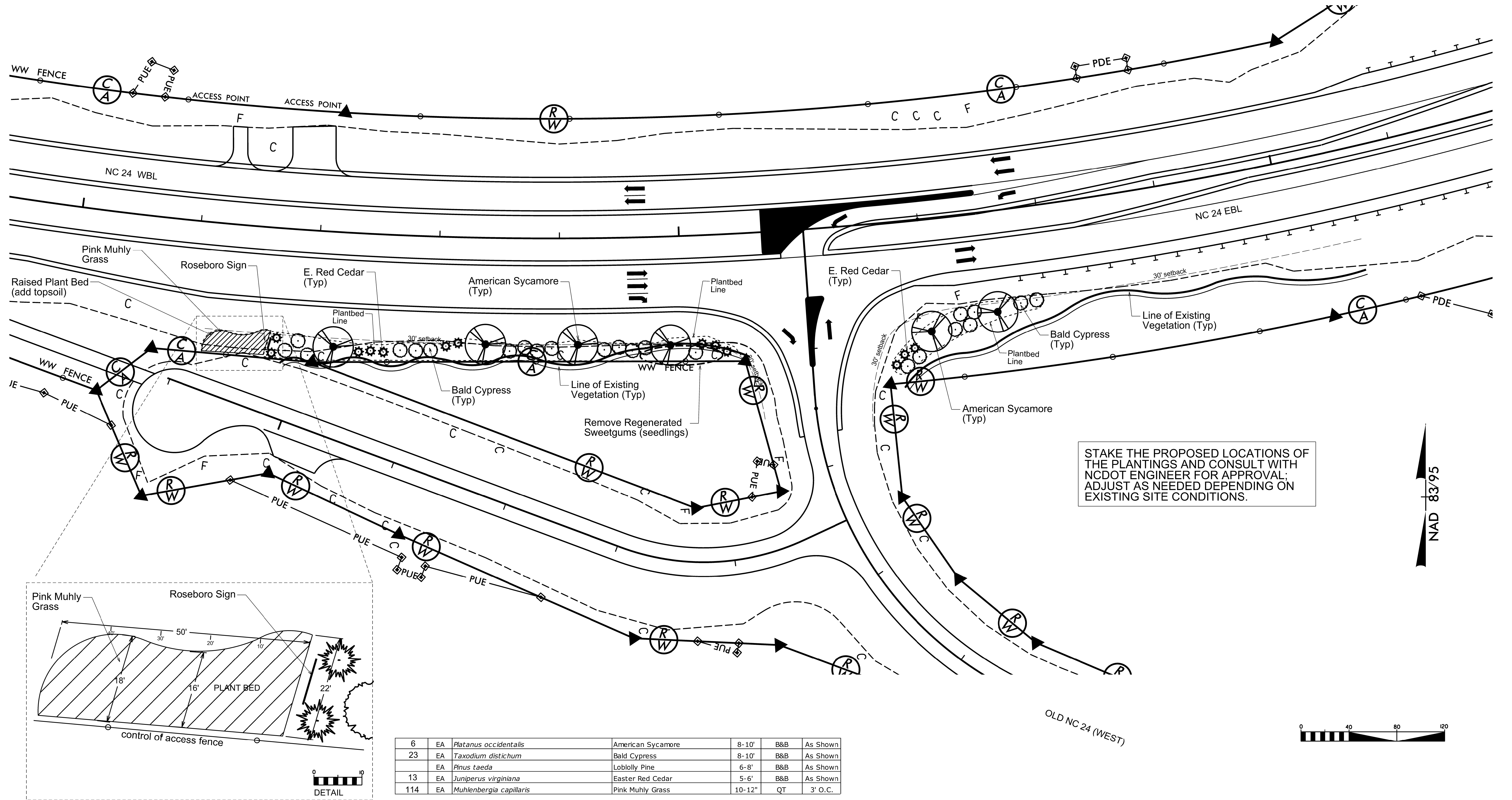

NCDOT - ROADSIDE ENVIRONMENTAL UNIT
 AESTHETIC ENGINEERING SECTION
 1557 MAIL SERVICE CENTER, RALEIGH, NC 27699-1557
 PH: 919-707-2920 FAX: 919-715-2554
http://www.ncdot.org/doh/operations/dp_chief_eng/roadside/

NC 24 - R-2303C
 Roseboro NC
 WBS#: 34416.3.14

reu engineer :

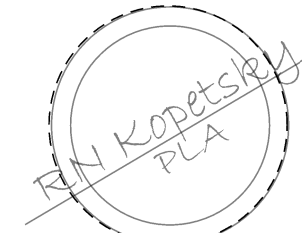

sheet description:

LANDSCAPE ENHANCEMENT
 NC 24 & OLD NC 24 (WEST)

prel design date:

checked by & date :

final design date :

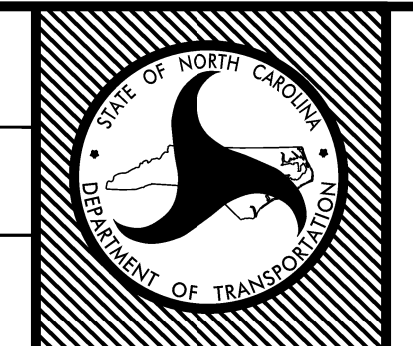

sheet no :

L4

total sheet no : 11

NAD 83/95

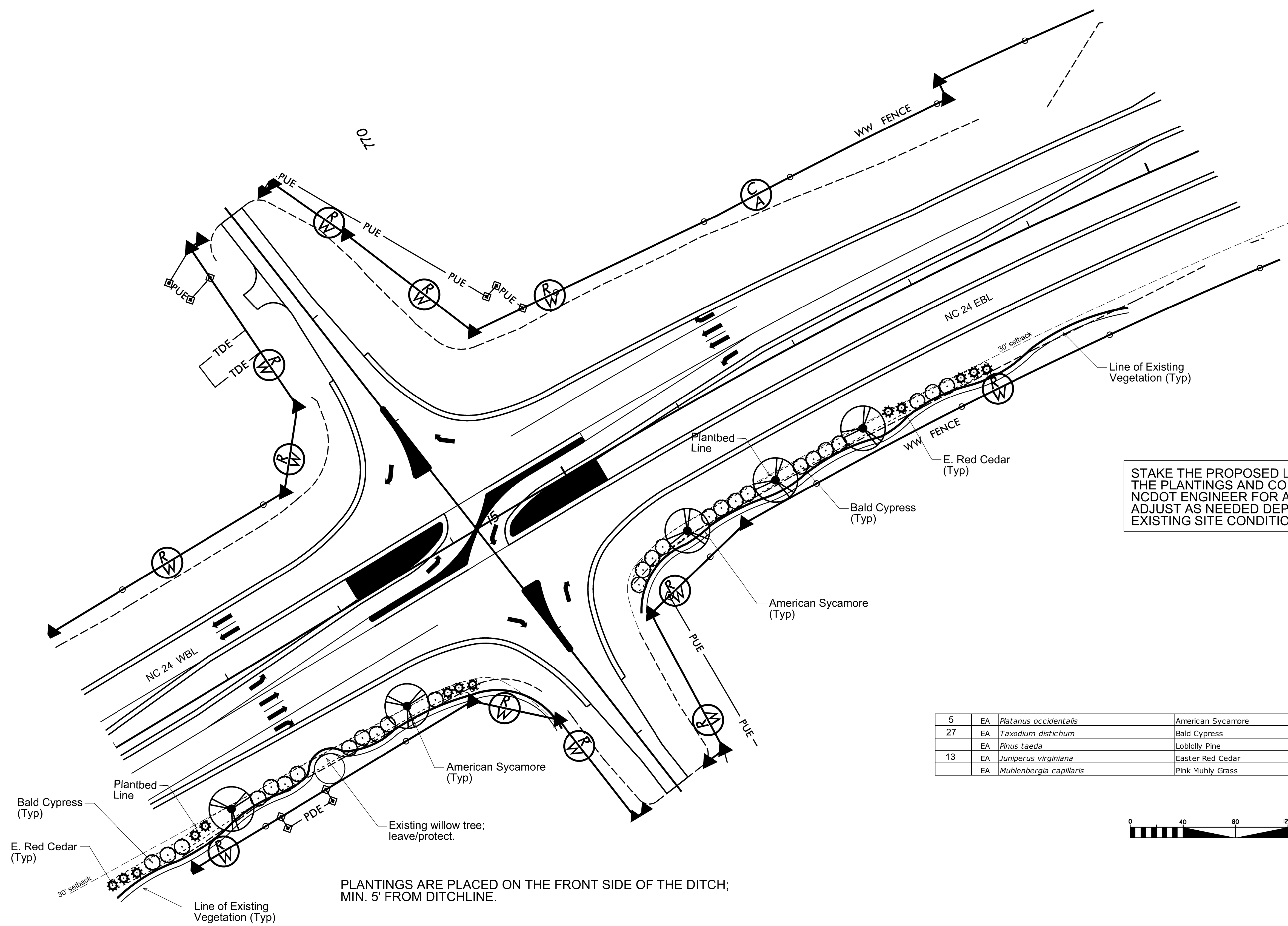

STAKE THE PROPOSED LOCATIONS OF THE PLANTINGS AND CONSULT WITH NCDOT ENGINEER FOR APPROVAL; ADJUST AS NEEDED DEPENDING ON EXISTING SITE CONDITIONS.

5	EA	<i>Platanus occidentalis</i>	American Sycamore	8-10'	B&B	As Shown
27	EA	<i>Taxodium distichum</i>	Bald Cypress	8-10'	B&B	As Shown
	EA	<i>Pinus taeda</i>	Loblolly Pine	6-8'	B&B	As Shown
13	EA	<i>Juniperus virginiana</i>	Easter Red Cedar	5-6'	B&B	As Shown
	EA	<i>Muhlenbergia capillaris</i>	Pink Muhly Grass	10-12"	QT	3' O.C.



PLANTINGS ARE PLACED ON THE FRONT SIDE OF THE DITCH; MIN. 5' FROM DITCHLINE.

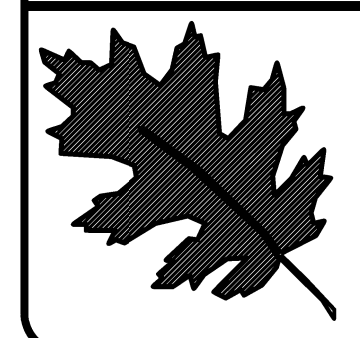

NCDOT - ROADSIDE ENVIRONMENTAL UNIT
 AESTHETIC ENGINEERING SECTION
 1557 MAIL SERVICE CENTER, RALEIGH, NC 27699-1557
 PH: 919-707-2920 FAX: 919-715-2554
http://www.ncdot.org/doh/operations/dp_chief_eng/roadside/

NC 24 - R-2303C
 Roseboro NC
 WBS#: 34416.3.14

reu engineer :

sheet description:
 LANDSCAPE ENHANCEMENT
 NC 24 & OLD BRICK RD

prel design date:
 checked by & date :
 final design date :

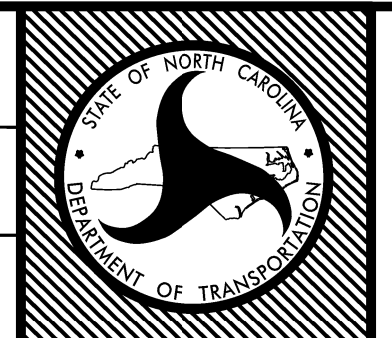

sheet no :
 L5
 total sheet no : 11

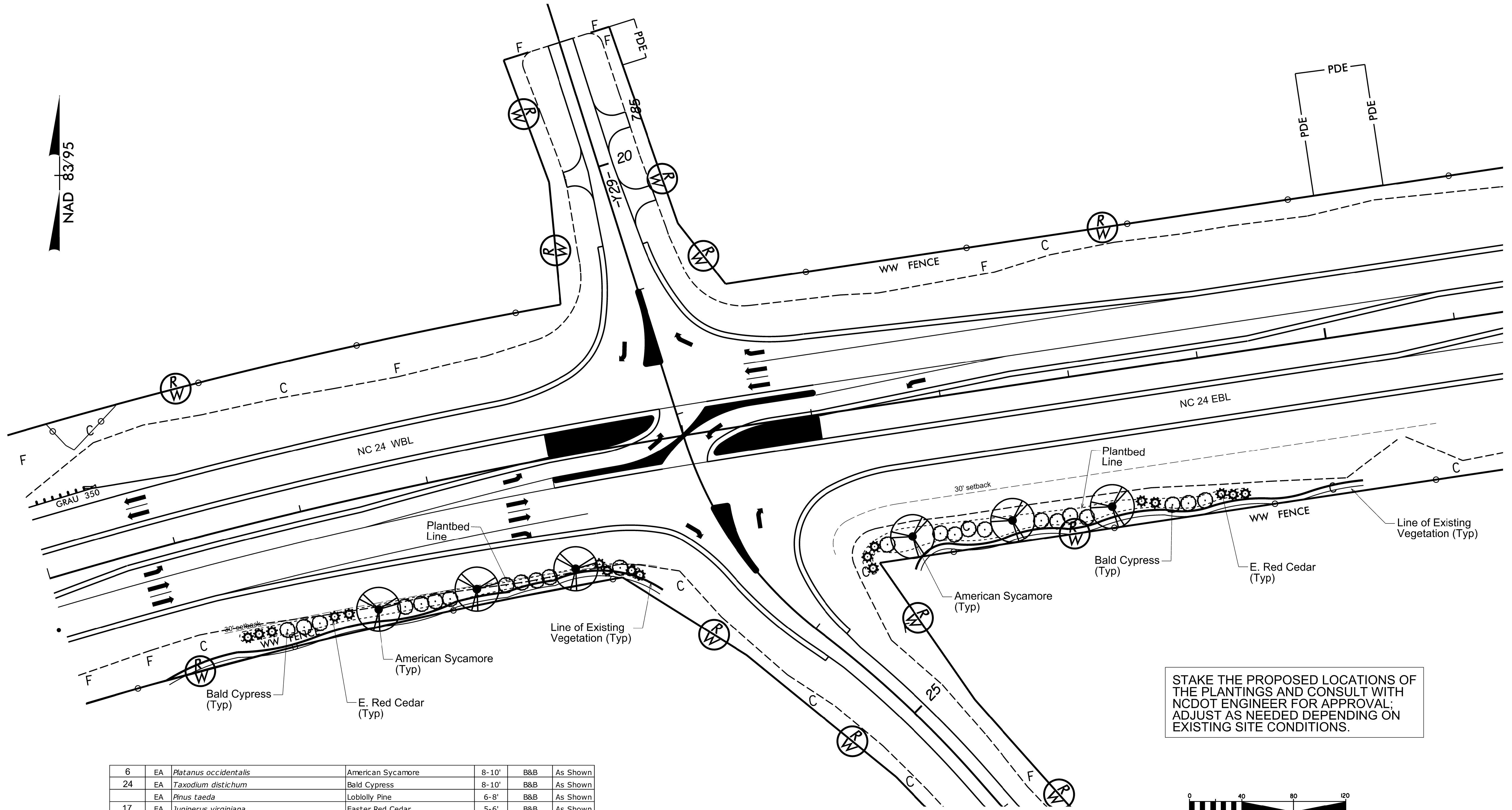
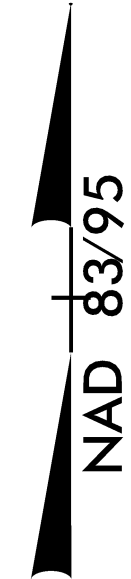

STAKE THE PROPOSED LOCATIONS OF THE PLANTINGS AND CONSULT WITH NCDOT ENGINEER FOR APPROVAL; ADJUST AS NEEDED DEPENDING ON EXISTING SITE CONDITIONS.



6	EA	<i>Platanus occidentalis</i>	American Sycamore	8-10'	B&B	As Shown
24	EA	<i>Taxodium distichum</i>	Bald Cypress	8-10'	B&B	As Shown
	EA	<i>Pinus taeda</i>	Loblolly Pine	6-8'	B&B	As Shown
17	EA	<i>Juniperus virginiana</i>	Easter Red Cedar	5-6'	B&B	As Shown
	EA	<i>Muhlenbergia capillaris</i>	Pink Muhly Grass	10-12"	QT	3' O.C.



NCDOT - ROADSIDE ENVIRONMENTAL UNIT
 AESTHETIC ENGINEERING SECTION
 1557 MAIL SERVICE CENTER, RALEIGH, NC 27699-1557
 PH: 919-707-2920 FAX: 919-715-2554
http://www.ncdot.org/doh/operations/dp_chief_eng/roadside/

NC 24 - R-2303C
 Roseboro NC
 WBS#: 34416.3.14

reu engineer :

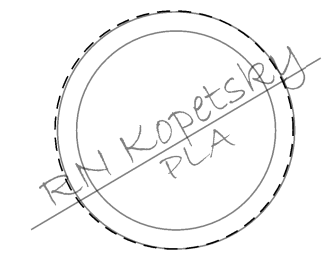

sheet description:
 LANDSCAPE ENHANCEMENT
 NC 24 & FAIRCLOTH RD

prel design date:
 checked by & date :
 final design date :

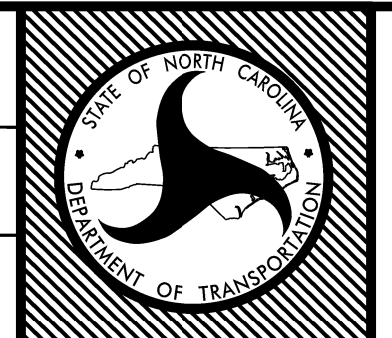

sheet no :
 L6
 total sheet no : 11

NAD 83/95

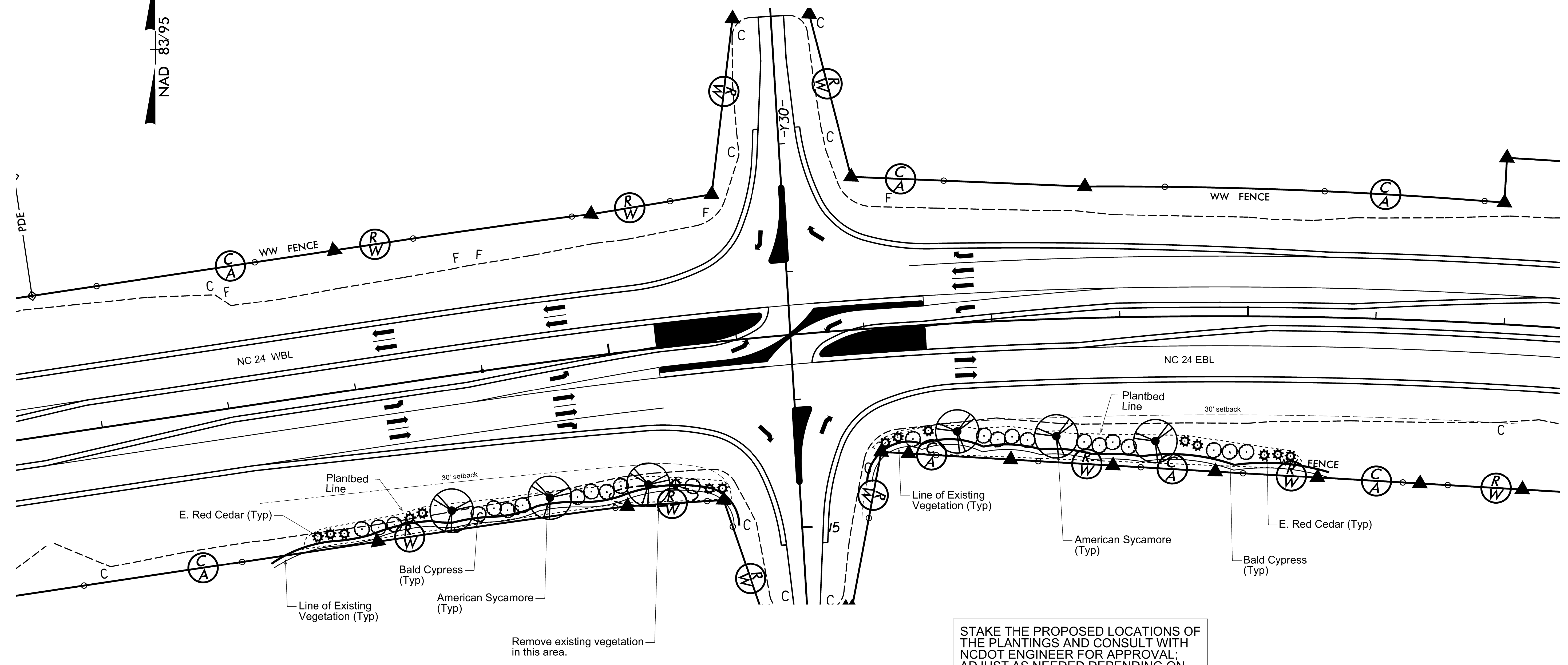

STAKE THE PROPOSED LOCATIONS OF THE PLANTINGS AND CONSULT WITH NCDOT ENGINEER FOR APPROVAL; ADJUST AS NEEDED DEPENDING ON EXISTING SITE CONDITIONS.



6	EA	<i>Platanus occidentalis</i>	American Sycamore	8-10'	B&B	As Shown
24	EA	<i>Taxodium distichum</i>	Bald Cypress	8-10'	B&B	As Shown
	EA	<i>Pinus taeda</i>	Loblolly Pine	6-8'	B&B	As Shown
16	EA	<i>Juniperus virginiana</i>	Easter Red Cedar	5-6'	B&B	As Shown
	EA	<i>Muhlenbergia capillaris</i>	Pink Muhly Grass	10-12"	QT	3' O.C.

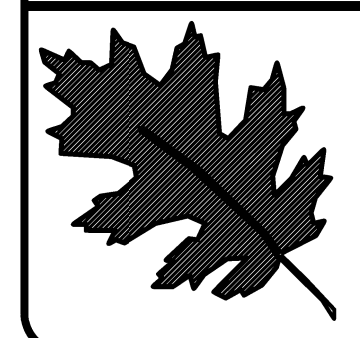

NCDOT - ROADSIDE ENVIRONMENTAL UNIT
 AESTHETIC ENGINEERING SECTION
 1557 MAIL SERVICE CENTER, RALEIGH, NC 27699-1557
 PH: 919-707-2920 FAX: 919-715-2554
http://www.ncdot.org/doh/operations/dp_chief_eng/roadside/

NC 24 - R-2303C
 Roseboro NC
 WBS#: 34416.3.14

reu engineer :

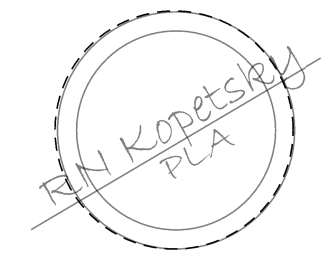

sheet description:
 LANDSCAPE ENHANCEMENT
 NC 24 & LUCAS RD

prel design date:
 checked by & date :
 final design date :

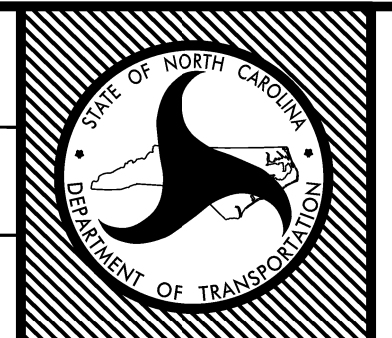

sheet no :
 L7
 total sheet no : 11

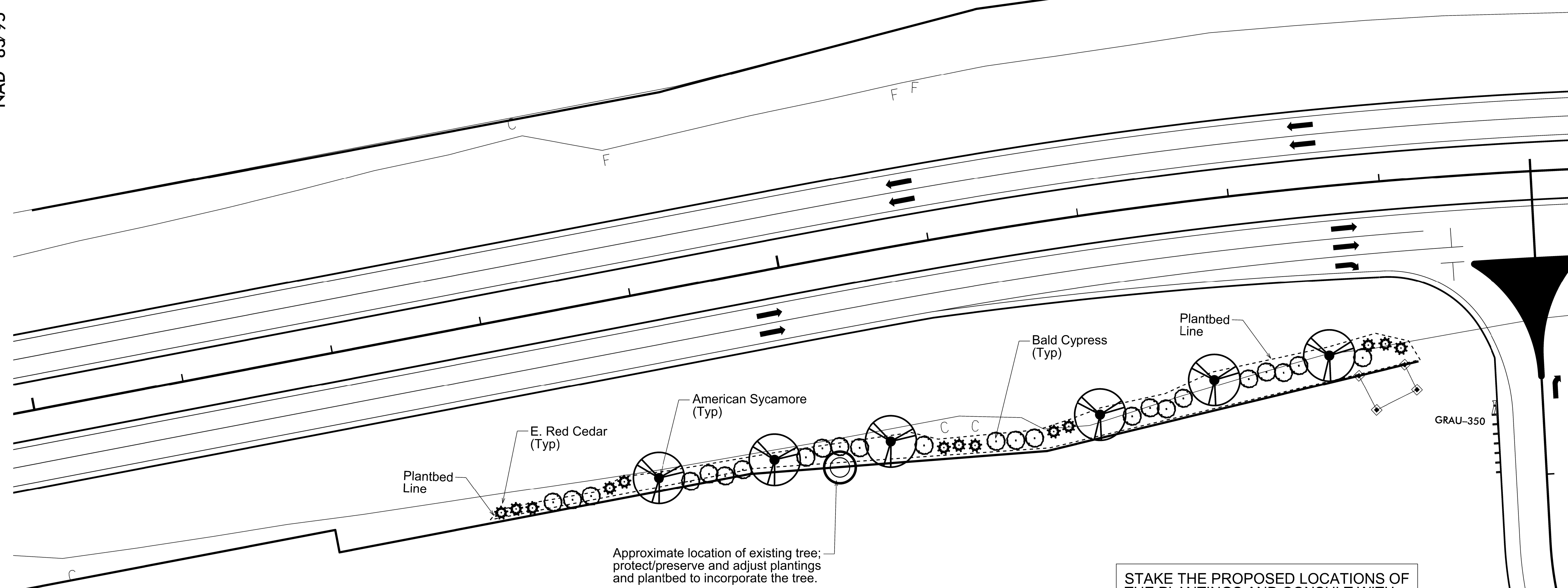
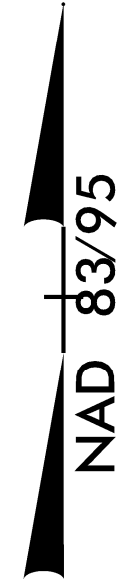

STAKE THE PROPOSED LOCATIONS OF THE PLANTINGS AND CONSULT WITH NCDOT ENGINEER FOR APPROVAL; ADJUST AS NEEDED DEPENDING ON EXISTING SITE CONDITIONS.

6	EA	<i>Platanus occidentalis</i>	American Sycamore	8-10'	B&B	As Shown
24	EA	<i>Taxodium distichum</i>	Bald Cypress	8-10'	B&B	As Shown
	EA	<i>Pinus taeda</i>	Loblolly Pine	6-8'	B&B	As Shown
13	EA	<i>Juniperus virginiana</i>	Easter Red Cedar	5-6'	B&B	As Shown
	EA	<i>Muhlenbergia capillaris</i>	Pink Muhly Grass	10-12"	QT	3' O.C.



MATCH LINE TO NC 42/NC 242 SHEET L9

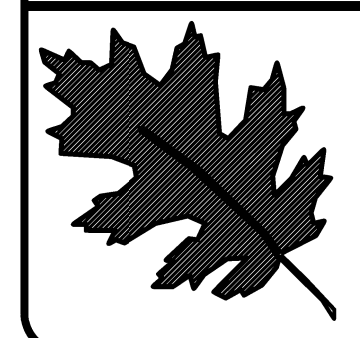

NCDOT - ROADSIDE ENVIRONMENTAL UNIT
 AESTHETIC ENGINEERING SECTION
 1557 MAIL SERVICE CENTER, RALEIGH, NC 27699-1557
 PH: 919-707-2920 FAX: 919-715-2554
<http://www.ncdot.org/doh/operations/dp.chief.eng/roadside/>

NC 24 - R-2303C
 Roseboro NC
 WBS#: 34416.3.14

reu engineer :

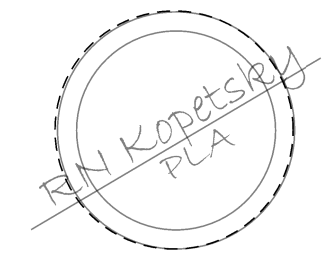

sheet description:
 LANDSCAPE ENHANCEMENT
 NC 24 & NC 242 (1)

prel design date :
 checked by & date :
 final design date :

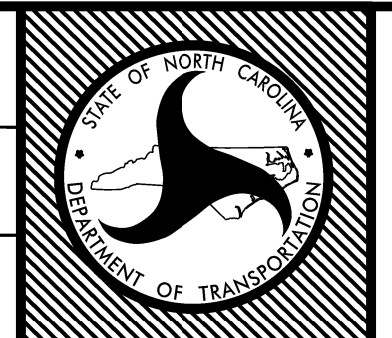

sheet no :
 L8
 total sheet no : 11

MATCH LINE TO NC 42/NC 242 SHEET L10

MATCH LINE TO NC 42/NC 242 SHEET L8

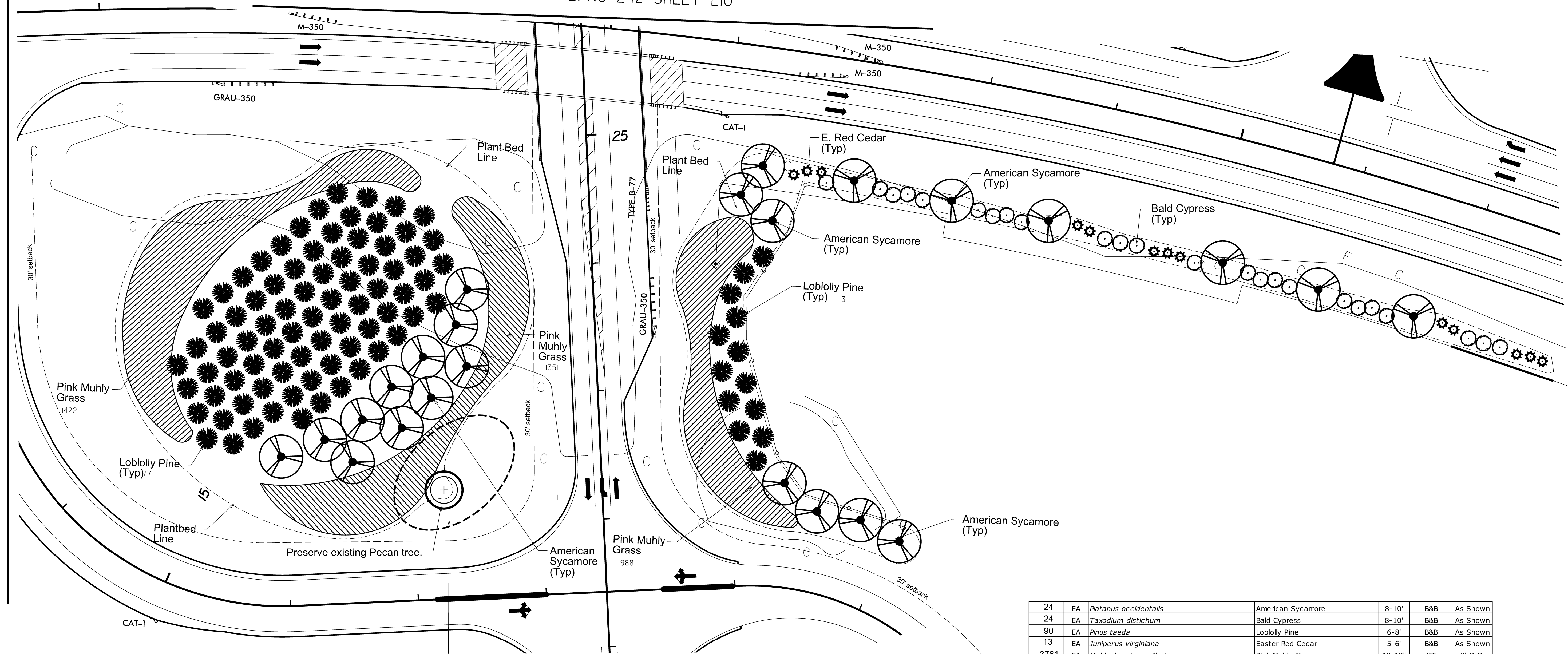

Remove Vegetation in the noted area EXCEPT preserve/protect existing Pecan tree; incorporate tree into plant bed and mulch around.

STAKE THE PROPOSED LOCATIONS OF THE PLANTINGS AND CONSULT WITH NCDOT ENGINEER FOR APPROVAL; ADJUST AS NEEDED DEPENDING ON EXISTING SITE CONDITIONS.

24	EA	<i>Platanus occidentalis</i>	American Sycamore	8-10'	B&B	As Shown
24	EA	<i>Taxodium distichum</i>	Bald Cypress	8-10'	B&B	As Shown
90	EA	<i>Pinus taeda</i>	Loblolly Pine	6-8'	B&B	As Shown
13	EA	<i>Juniperus virginiana</i>	Easter Red Cedar	5-6'	B&B	As Shown
3761	EA	<i>Muhlenbergia capillaris</i>	Pink Muhly Grass	10-12"	QT	3' O.C.

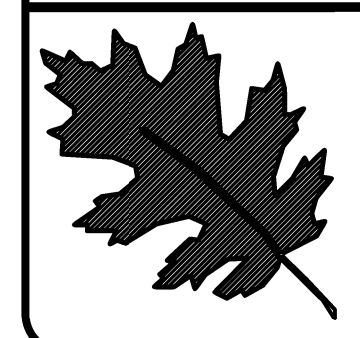

NCDOT - ROADSIDE ENVIRONMENTAL UNIT
 AESTHETIC ENGINEERING SECTION
 1557 MAIL SERVICE CENTER, RALEIGH, NC 27699-1557
 PH: 919-707-2920 FAX: 919-715-2554
http://www.ncdot.org/doh/operations/dp_chief_eng/roadside/

NC 24 - R-2303C
 Roseboro NC
 WBS#: 34416.3.14

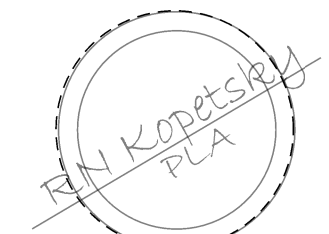
reu engineer :

sheet description:
 LANDSCAPE ENHANCEMENT
 NC 24 & NC 242 (2)

prel design date :
 checked by & date :
 final design date :

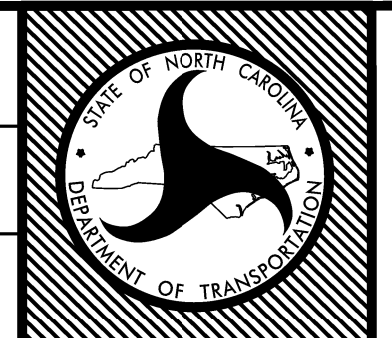

sheet no :
 L9
 total sheet no : 11

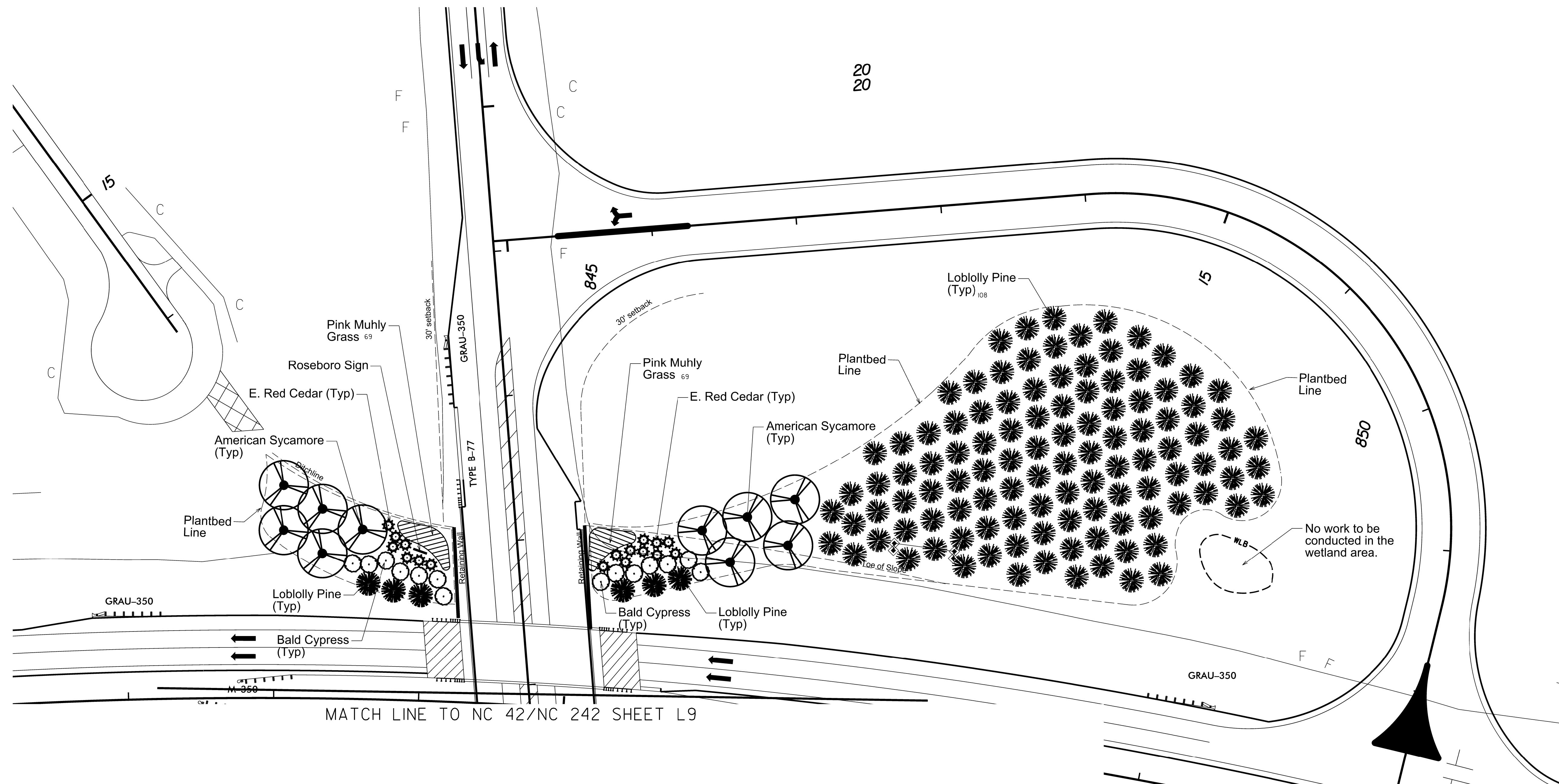

MATCH LINE TO NC 42/NC 242 SHEET L9

STAKE THE PROPOSED LOCATIONS OF THE PLANTINGS AND CONSULT WITH NCDOT ENGINEER FOR APPROVAL; ADJUST AS NEEDED DEPENDING ON EXISTING SITE CONDITIONS.

10	EA	<i>Platanus occidentalis</i>	American Sycamore	8-10'	B&B	As Shown
14	EA	<i>Taxodium distichum</i>	Bald Cypress	8-10'	B&B	As Shown
114	EA	<i>Pinus taeda</i>	Loblolly Pine	6-8'	B&B	As Shown
17	EA	<i>Juniperus virginiana</i>	Easter Red Cedar	5-6'	B&B	As Shown
138	EA	<i>Muhlenbergia capillaris</i>	Pink Muhly Grass	10-12"	QT	3' O.C.

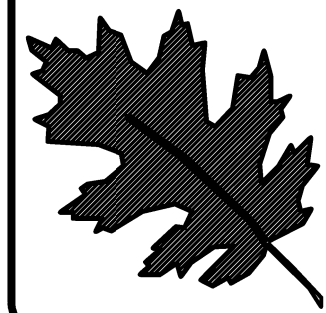

NCDOT - ROADSIDE ENVIRONMENTAL UNIT
 AESTHETIC ENGINEERING SECTION
 1557 MAIL SERVICE CENTER, RALEIGH, NC 27699-1557
 PH: 919-707-2920 FAX: 919-715-2554
http://www.ncdot.org/doh/operations/dp_chief_eng/roadside/

NC 24 - R-2303C
 Roseboro NC
 WBS#: 34416.3.14

reu engineer :

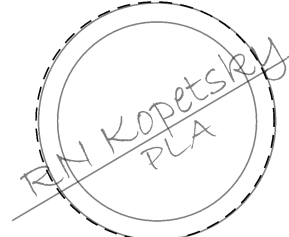

sheet description:
 LANDSCAPE ENHANCEMENT
 NC 24 & NC 242

prel design date:
 checked by & date :
 final design date :

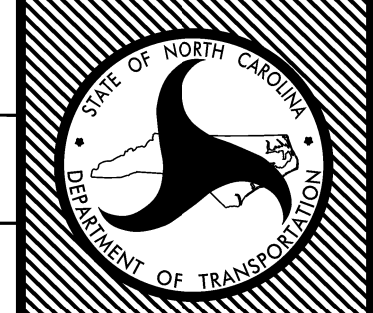

sheet no : L10
 total sheet no : 11

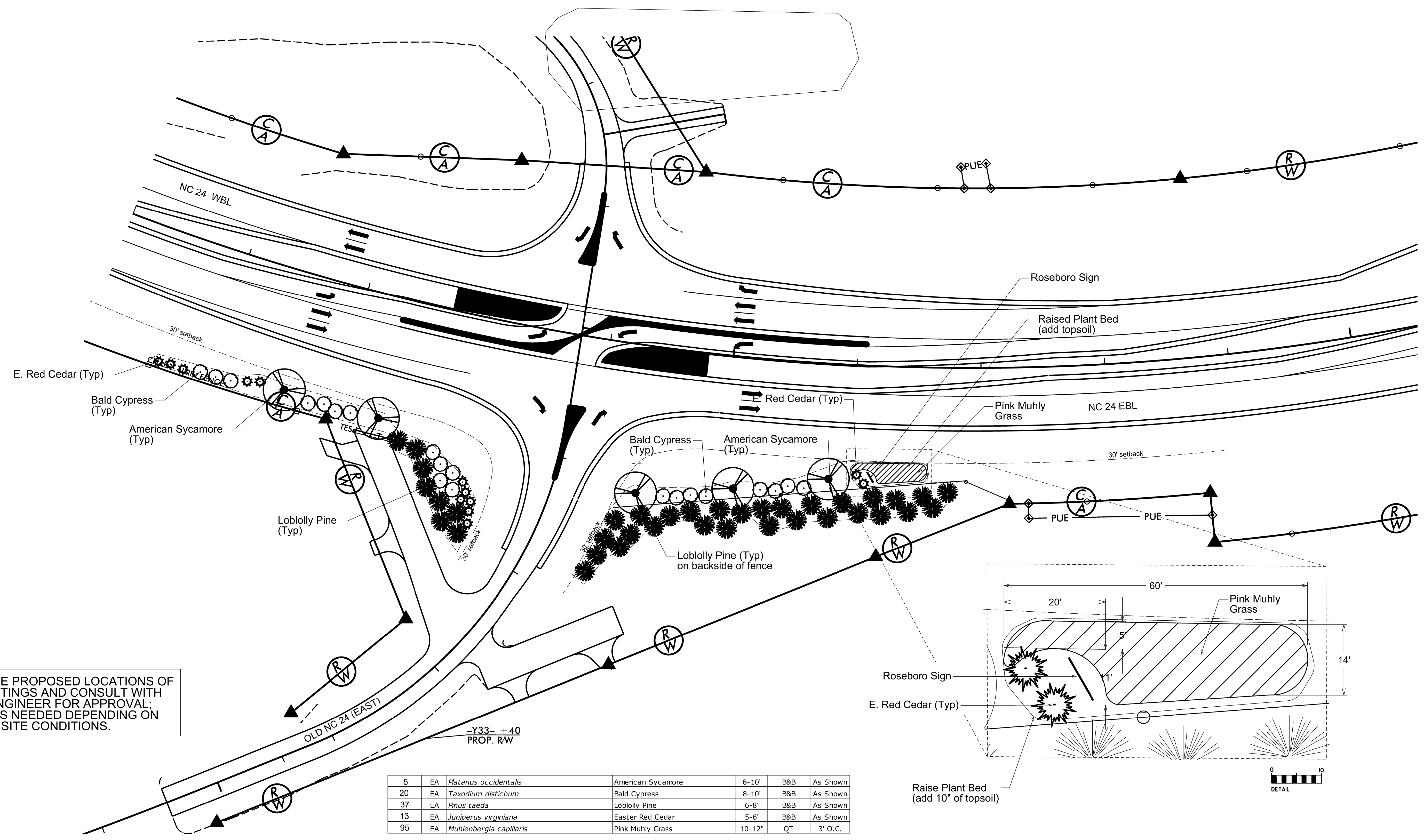

STAKE THE PROPOSED LOCATIONS OF THE PLANTINGS AND CONSULT WITH NCDOT ENGINEER FOR APPROVAL; ADJUST AS NEEDED DEPENDING ON EXISTING SITE CONDITIONS.

5	EA	<i>Platanus occidentalis</i>	American Sycamore	8-10'	B&B	As Shown
20	EA	<i>Taxodium distichum</i>	Bald Cypress	8-10'	B&B	As Shown
37	EA	<i>Pinus taeda</i>	Loblolly Pine	6-8'	B&B	As Shown
13	EA	<i>Juniperus virginiana</i>	Easter Red Cedar	5-6'	B&B	As Shown
95	EA	<i>Muhlenbergia capillaris</i>	Pink Muhly Grass	10-12"	QT	3' O.C.

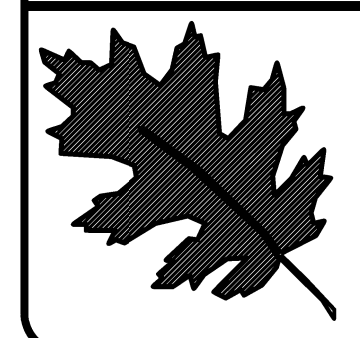
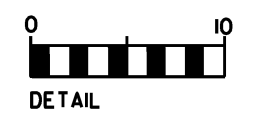
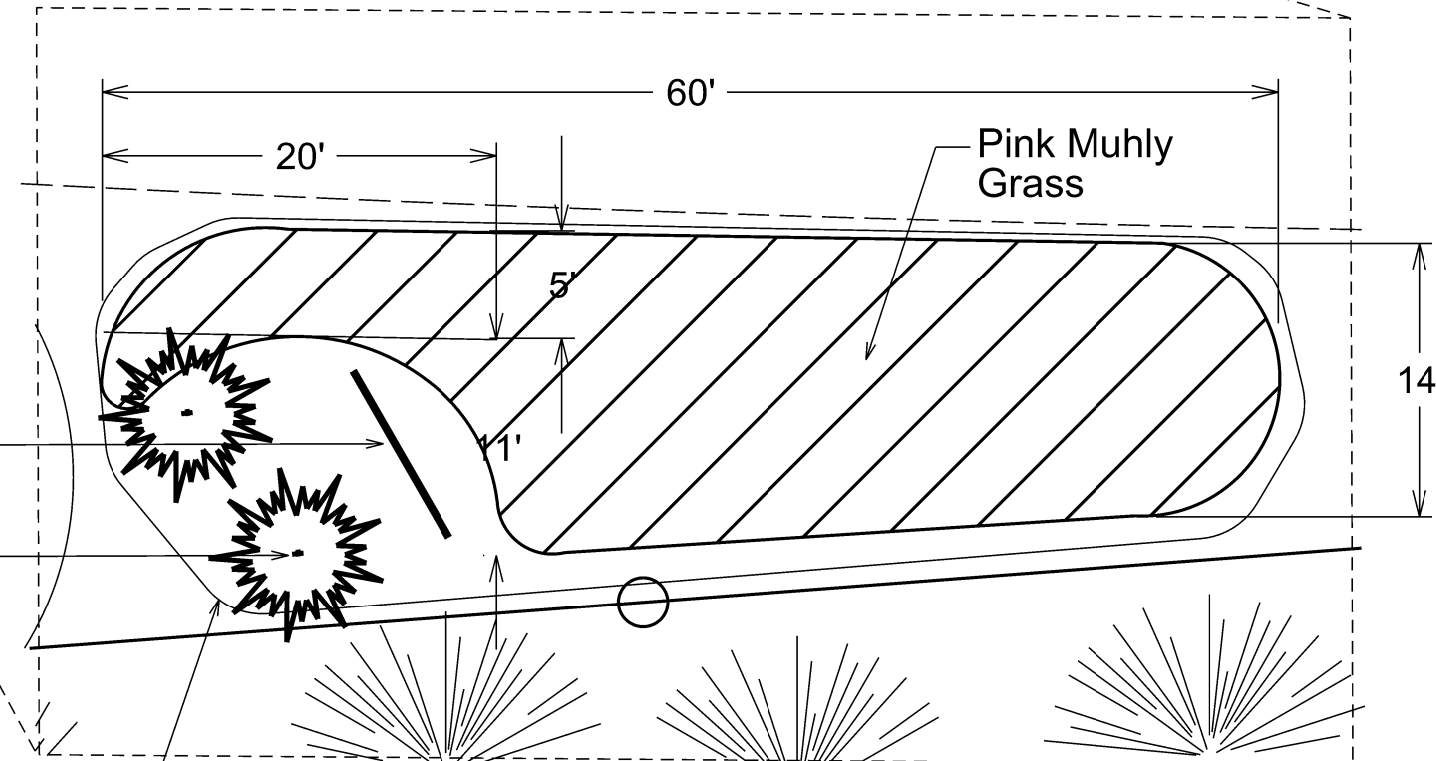

NCDOT - ROADSIDE ENVIRONMENTAL UNIT
 AESTHETIC ENGINEERING SECTION
 1557 MAIL SERVICE CENTER, RALEIGH, NC 27699-1557
 PH: 919-707-2920 FAX: 919-715-2554
http://www.ncdot.org/doh/operations/dp_chief_eng/roadside/

NC 24 - R-2303C
 Roseboro NC
 WBS#: 34416.3.14

reu engineer :

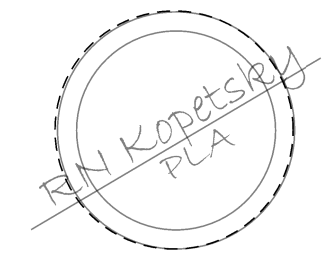

sheet description:
 LANDSCAPE ENHANCEMENT
 NC 24 & OLD NC 24 (EAST)

prel design date:
 checked by & date :
 final design date :

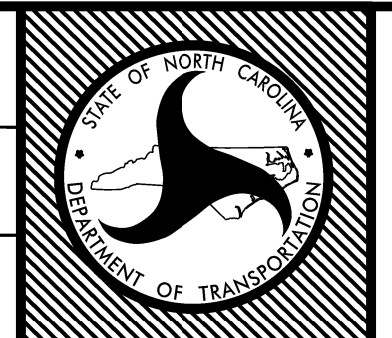

sheet no :
 L11
 total sheet no : 11