

STATE OF NORTH CAROLINA
DEPARTMENT OF TRANSPORTATION
HIGHWAY DIVISION 4

PROPOSAL

DATE AND TIME OF BID OPENING: JUNE 13, 2023 AT 2:00 PM

CONTRACT ID: DD00423

WBS ELEMENT NO.: 2023CPT.04.21.20641, 48184.01K

FEDERAL AID NO.: STATE FUNDED

COUNTY: NASH COUNTY

TIP NO.: N/A

MILES: 14.953

ROUTE NO.: VARIOUS

LOCATION: 6 SECTIONS OF SR 1310 AND DMV PARKING LOT ON US-301

TYPE OF WORK: MILLING AND RESURFACING

NOTICE:

ALL BIDDERS SHALL COMPLY WITH ALL APPLICABLE LAWS REGULATING THE PRACTICE OF GENERAL CONTRACTING AS CONTAINED IN CHAPTER 87 OF THE GENERAL STATUTES OF NORTH CAROLINA WHICH REQUIRES THE BIDDER TO BE LICENSED BY THE N.C. LICENSING BOARD FOR CONTRACTORS WHEN BIDDING ON ANY NON-FEDERAL AID PROJECT WHERE THE BID IS \$30,000 OR MORE, EXCEPT FOR CERTAIN SPECIALTY WORK AS DETERMINED BY THE LICENSING BOARD. BIDDERS SHALL ALSO COMPLY WITH ALL OTHER APPLICABLE LAWS REGULATING THE PRACTICES OF ELECTRICAL, PLUMBING, HEATING AND AIR CONDITIONING AND REFRIGERATION CONTRACTING AS CONTAINED IN CHAPTER 87 OF THE GENERAL STATUTES OF NORTH CAROLINA. NOTWITHSTANDING THESE LIMITATIONS ON BIDDING, THE BIDDER WHO IS AWARDED ANY FEDERAL - AID FUNDED PROJECT SHALL COMPLY WITH CHAPTER 87 OF THE GENERAL STATUTES OF NORTH CAROLINA FOR LICENSING REQUIREMENTS WITHIN 60 CALENDAR DAYS OF BID OPENING.

THIS IS A ROADWAY PROJECT.

BID BOND IS REQUIRED.

NAME OF BIDDER

ADDRESS OF BIDDER

**PROPOSAL FOR THE CONSTRUCTION OF
CONTRACT No. DD00423 IN NASH COUNTY, NORTH CAROLINA
DEPARTMENT OF TRANSPORTATION,
WILSON, NORTH CAROLINA**

The Bidder has carefully examined the location of the proposed work to be known as Contract No. **DD00423**; has carefully examined the plans and specifications, which are acknowledged to be part of the proposal, the special provisions, the proposal, the form of contract, and the forms of contract payment bond and contract performance bond; and thoroughly understands the stipulations, requirements and provisions. The undersigned bidder agrees to be bound upon his execution of the bid and subsequent award to him by the Department of Transportation in accordance with this proposal to provide the necessary contract payment bond and contract performance bond within fourteen days after the written notice of award is received by him. The undersigned Bidder further agrees to provide all necessary machinery, tools, labor, and other means of construction; and to do all the work and to furnish all materials, except as otherwise noted, necessary to perform and complete the said contract in accordance with *the 2018 Standard Specifications for Roads and Structures* by the dates(s) specified in the Project Special Provisions and in accordance with the requirements of the Engineer, and at the unit or lump sum prices, as the case may be, for the various items given on the sheets contained herein.

The Bidder shall provide and furnish all the materials, machinery, implements, appliances and tools, and perform the work and required labor to construct and complete State Highway Contract No. **DD00423** in **Nash County**, for the unit or lump sum prices, as the case may be, bid by the Bidder in his bid and according to the proposal, plans, and specifications prepared by said Department, which proposal, plans, and specifications show the details covering this project, and hereby become a part of this contract.

The published volume entitled *North Carolina Department of Transportation, Raleigh, Standard Specifications for Roads and Structures, January 2018* with all amendments and supplements thereto, is by reference incorporated into and made a part of this contract; that, except as herein modified, all the construction and work included in this contract is to be done in accordance with the specifications contained in said volume, and amendments and supplements thereto, under the direction of the Engineer.

If the proposal is accepted and the award is made, the contract is valid only when signed either by the Contract Officer or such other person as may be designated by the Secretary to sign for the Department of Transportation. The conditions and provisions herein cannot be changed except over the signature of the said Contract Officer or Division Engineer.

The quantities shown in the itemized proposal for the project are considered to be approximate only and are given as the basis for comparison of bids. The Department of Transportation may increase or decrease the quantity of any item or portion of the work as may be deemed necessary or expedient.

An increase or decrease in the quantity of an item will not be regarded as sufficient ground for an increase or decrease in the unit prices, nor in the time allowed for the completion of the work, except as provided for the contract.

Accompanying this bid is a bid bond secured by a corporate surety, or certified check payable to the order of the Department of Transportation, for five percent of the total bid price, which deposit is to be forfeited as liquidated damages in case this bid is accepted and the Bidder shall fail to provide the required payment and performance bonds with the Department of Transportation, under the condition of this proposal, within 14 calendar days after the written notice of award is received by him, as provided in the Standard Specifications; otherwise said deposit will be returned to the Bidder.

TABLE OF CONTENTS

**COVER SHEET
PROPOSAL SHEET**

SPECIAL PROVISIONS

CONTRACTOR PREQUALIFICATION: 5
INTERESTED PARTIES LIST: 5
BOND REQUIREMENTS:..... 6
LIABILITY INSURANCE: 6
REQUIRED PRECONSTRUCTION MEETING: 7
CONTRACT TIME AND LIQUIDATED DAMAGES:..... 7
INTERMEDIATE CONTRACT TIME NUMBER 1 AND LIQUIDATED DAMAGES:..... 7
INTERMEDIATE CONTRACT TIME NUMBER 2 AND LIQUIDATED DAMAGES 8
INTERMEDIATE CONTRACT TIME NUMBER 3 AND LIQUIDATED DAMAGES:..... 8
PROSECUTION OF WORK: 9
NO MAJOR CONTRACT ITEMS: 10
NO SPECIALTY ITEMS:..... 10
FUEL PRICE ADJUSTMENT: 10
MINORITY BUSINESS ENTERPRISE AND WOMEN BUSINESS ENTERPRISE
(DIVISIONS): 11
USE OF UNMANNED AIRCRAFT SYSTEM (UAS):..... 27
EQUIPMENT IDLING GUIDELINES: 27
ELECTRONIC BIDDING: 28
AWARD LIMITS: 29
OUTSOURCING OUTSIDE THE USA: 29
ROADWAY 30
HOT SPRAY THERMOPLASTIC PAVEMENT MARKING LINES: 43
TEMPORARY TRAFFIC CONTROL (TTC):..... 45
SUMMARY OF QUANTITIES 58
TYPICAL SECTIONS 60
DETAILS 62
MAPS 65
AVAILABILITY OF FUNDS – TERMINATION OF CONTRACTS..... 69
ERRATA 70
PLANT AND PEST QUARANTINES..... 79
MINIMUM WAGES..... 80
TITLE VI AND NONDISCRIMINATION: 81
ON-THE-JOB TRAINING 90
LISTING OF MBE/WBE SUBCONTRACTORS..... 93
AWARD LIMITS ON MULTIPLE PROJECTS 95

PROPOSAL ITEM SHEETS AND SIGNATURE SHEET

INSTRUCTIONS TO BIDDERS

**PLEASE READ ALL INSTRUCTIONS CAREFULLY
BEFORE PREPARING AND SUBMITTING YOUR BID.**

All bids shall be prepared and submitted in accordance with the following requirements. Failure to comply with any requirement may cause the bid to be considered irregular and may be grounds for rejection of the bid.

For preparing and submitting the bid electronically, refer to Article 102-8(B) of the *2018 Standard Specifications*.

Bidders that bid electronically on Raleigh Central-Let projects will need a separate Digital Signature from the approved electronic bidding provider for Division Contracts.

ELECTRONIC ON-LINE BID:

1. Download entire proposal from Connect NCDOT website. Download the electronic submittal file from the approved electronic bidding provider website.
2. If the *Interested Parties List* provision SP01 G02 is part of the proposal prior to submitting a bid on a project, the bidder shall sign up on the *Interested Parties List* in conformance with Interested Parties List provision SP01 G02.
3. Prepare and submit the electronic submittal file using the approved electronic bidding provider software.
4. Electronic bidding software necessary for electronic bid preparation may be downloaded from the Connect NCDOT website at: <https://connect.ncdot.gov/letting/Pages/Electronic-Bidding.aspx> or from the approved electronic bidding provider website.

PROJECT SPECIAL PROVISIONS

GENERAL

CONTRACTOR PREQUALIFICATION:

(10-18-22)

102

SP1 G01

Revise the *2018 Standard Specifications* as follows:

Page 1-10, Subarticle 102-2(A) Bidder Prequalification, lines 30-31, delete and replace the first sentence with the following:

Prospective bidders shall obtain prequalification approval at least two business days prior to any letting in which they intend to submit a bid. It is recommended that the prospective bidder file all required statements and documents with the State Prequalifications Engineer no less than 4 weeks before a given letting.

Page 1-11, Subarticle 102-2(B) Purchase Order Bidder Prequalification, lines 16-18, delete and replace the first sentence with the following:

Prospective bidders shall obtain prequalification approval at least two business days prior to any letting in which they intend to submit a bid. It is recommended that the applicant file all required statements and documents with the State Prequalifications Engineer no less than 4 weeks before a given bid opening for their bid to be considered.

Page 1-11, Subarticle 102-2(C) Subcontractor Prequalification, lines 44-45, delete and replace the first sentence with the following:

The subcontractor shall file all required statements and documents with the State Prequalifications Engineer no less than 4 weeks before beginning work.

Page 1-12, Subarticle 102-2(E) Renewal and Requalification, lines 38-40, delete and replace the first sentence with the following:

It is recommended that the renewing or requalifying firm file all required statements and documents with the State Prequalifications Engineer no less than 4 weeks before a given letting for their bid to be considered.

INTERESTED PARTIES LIST:

(6-21-22)(Rev. 7-19-22)

102

SP1 G02

Revise the *2018 Standard Specifications* as follows:

Page 1-12, Article 102-3 PROPOSALS AND PLAN HOLDER LISTS, lines 45-49, delete and replace with the following:

102-3 PROPOSALS AND INTERESTED PARTIES LIST

On Department projects advertised, the prospective bidder shall sign up on the *Interested Parties List* no later than one business day prior to the Letting day of that project, for which he intends to submit a bid. There is no cost for signing up on the *Interested Parties List* that can be found on the Department’s website at connect.ncdot.gov/letting.

Page 1-12, Article 102-3 PROPOSALS AND PLAN HOLDER LISTS, lines 1-3, delete and replace the first sentence of the second paragraph with the following:

The proposal will state the location of the contemplated construction and show a schedule of contract items with the approximate quantity of each of these items for which bid prices are invited.

Page 1-14, Article 102-8 PREPARATION AND SUBMISSION OF BIDS, lines 30-31, delete and replace the first paragraph with the following:

Prior to submitting a bid on a project, the bidder shall sign up on the *Interested Parties List* in conformance with Article 102-3. The bidder shall submit a unit or lump sum price for every item in the proposal other than items that are authorized alternates to those items for which a bid price has been submitted.

BOND REQUIREMENTS:

(06-01-16)

102-8, 102-10

SPD 01-420A

A Bid Bond is required in accordance with Article 102-10 of the *2018 Standard Specifications for Roads and Structures*.

Contract Payment and Performance Bonds are required in accordance with Article 103-7 of the *2018 Standard Specifications for Roads and Structures*.

LIABILITY INSURANCE:

(5-16-23)

107

SP1 G05

Revise the *2018 Standard Specifications* as follows:

Page 1-64, Article 107-15 LIABILITY INSURANCE, replace the first sentence with the following:

The Contractor shall at its sole cost and expense obtain and furnish to the Department an original standard Association for Cooperative Operations Research and Development (ACORD) certificate of liability insurance evidencing commercial general liability with a limit for bodily injury and property damage in the amount of \$5,000,000 per occurrence and \$5,000,000 general aggregate, covering the Contractor from claims or damages for bodily injury, personal injury, or for property damages that may arise from operating under the contract by the employees and agents of the Contractor.

REQUIRED PRECONSTRUCTION MEETING:

The Awarded Contractor shall contact Kim Moore, Resident Engineer, at (252)462-2580 to arrange the required pre-construction meeting. The project superintendent is required to attend.

The proposed progress schedule must be submitted to the Resident Engineer seven (7) days prior to the date of the preconstruction meeting. At the preconstruction meeting the Contractor shall supply the following information:

- Name of persons authorized to sign Supplemental Agreements
- Name of the EEO Officer and Minority Liaison Officer
- Name of the Erosion Control and Sediment Control/Storm Water Certified Supervisor, Certified Foreman, Certified Installer, and Certified Designer
- Name of the Work Zone Traffic Control Supervisor
- Buy America Certification

CONTRACT TIME AND LIQUIDATED DAMAGES:

(7-1-95) (Rev. 12-18-07)

108

SP1 G10 A

The date of availability for this contract is **July 17, 2023**.

The completion date for this contract is **December 13, 2024**.

Except where otherwise provided by the contract, observation periods required by the contract will not be a part of the work to be completed by the completion date and/or intermediate contract times stated in the contract. The acceptable completion of the observation periods that extend beyond the final completion date shall be a part of the work covered by the performance and payment bonds.

The liquidated damages for this contract are **Nine Hundred Dollars (\$900.00)** per calendar day.

INTERMEDIATE CONTRACT TIME NUMBER 1 AND LIQUIDATED DAMAGES:

(6-18-13)

108

The Contractor shall complete **all work included in this contract except for final pavement markings** and shall place and maintain traffic on same.

The date of availability for this intermediate contract time is **July 17, 2023**.

The completion date for this intermediate contract time is **November 15, 2024**.

The liquidated damages are **Nine Hundred Dollars (\$900.00)** per calendar day.

INTERMEDIATE CONTRACT TIME NUMBER 2 AND LIQUIDATED DAMAGES:

The Contractor shall adhere to the time limitations for replacement of pavement markings provided by the Contract and Standard Specifications as applicable for each map given the facility and marking type.

The date of availability for this intermediate contract time for each facility type and pavement marking type will be the date when the Contractor elects to obliterate or overlay the existing markings on any particular map or portion thereof.

The completion date for this intermediate contract time for pavement marking replacement will be the replacement deadline date based on facility type and marking type governed by the Contract and Standard Specifications after the date of availability.

The liquidated damages are **Five Hundred Dollars (\$500.00)** per calendar day.

INTERMEDIATE CONTRACT TIME NUMBER 3 AND LIQUIDATED DAMAGES:

(2-20-07)

108

SP1 G14 A

The Contractor shall complete the required work of installing, maintaining, and removing the traffic control devices for lane closures and restoring traffic to the existing traffic pattern. The Contractor shall not close or narrow a lane of traffic on **the following Maps** during the following time restrictions:

DAY AND TIME RESTRICTIONS

All Maps (Except Map #5)

Monday thru Sunday

9:00PM to 6:00AM

Map #5 – DMV Parking Lot (2617 N. Wesleyan Blvd)

Monday thru Friday

7:00 AM to 6:00 PM

In addition, the Contractor shall not close or narrow a lane of traffic on **Any Map (except Map #5)**, detain and/or alter the traffic flow on or during holidays, holiday weekends, special events, or any other time when traffic is unusually heavy, including the following schedules:

HOLIDAY AND HOLIDAY WEEKEND LANE CLOSURE RESTRICTIONS

1. For **unexpected occurrence** that creates unusually high traffic volumes, as directed by the Engineer.
2. For **New Year's Day**, between the hours of **6:00am** December 31st and **7:00pm** January 2nd. If New Year's Day is on a Friday, Saturday, Sunday or Monday, then until **7:00pm** the following Tuesday.

3. For **Easter**, between the hours of **6:00am** Thursday and **7:00pm** Monday.
4. For **Memorial Day**, between the hours of **6:00am** Friday and **7:00pm** Tuesday.
5. For **Independence Day**, between the hours of **6:00 a.m.** the day before Independence Day and **7:00 p.m.** the day after Independence Day.

If **Independence Day** is on a Friday, Saturday, Sunday or Monday, then between the hours of **6:00 a.m.** the Thursday before Independence Day and **7:00 p.m.** the Tuesday after Independence Day.

6. For **Labor Day**, between the hours of **6:00am** Friday and **7:00pm** Tuesday.
7. For **Thanksgiving Day**, between the hours of **6:00am** Tuesday and **7:00pm** Monday.
8. For **Christmas**, between the hours of **6:00am** the Friday before the week of Christmas Day and **7:00pm** the following Tuesday after the week of Christmas Day.

Holidays and holiday weekends shall include New Year's, Easter, Memorial Day, Independence Day, Labor Day, Thanksgiving, and Christmas. The Contractor shall schedule his work so that lane closures will not be required during these periods, unless otherwise directed by the Engineer.

The time of availability for this intermediate contract work shall be the time the Contractor begins to install all traffic control devices for lane closures according to the time restrictions listed herein.

The completion time for this intermediate contract work shall be the time the Contractor is required to complete the removal of all traffic control devices for lane closures according to the time restrictions stated above and place traffic in the existing traffic pattern.

The liquidated damages are **Eight Hundred Fifty Dollars (\$850.00)** per hour.

PROSECUTION OF WORK:

(7-1-95) (Rev. 8-21-12)

108

SP1 G15R

The Contractor will be required to prosecute the work in a continuous and uninterrupted manner from the time he begins the work until completion and final acceptance of the project. The Contractor will not be permitted to suspend his operations except for reasons beyond his control or except where the Engineer has authorized a suspension of the Contractor's operations in writing.

In the event that the Contractor's operations are suspended in violation of the above provisions, the sum of **\$500.00** will be charged the Contractor for each and every calendar day that such suspension takes place. The said amount is hereby agreed upon as liquidated damages due to extra engineering and maintenance costs and due to increased public hazard resulting from a suspension of the work. Liquidated damages chargeable due to suspension of the work will be additional to any liquidated damages that may become chargeable due to failure to complete the work on time.

NO MAJOR CONTRACT ITEMS:

(2-19-02) (Rev. 8-21-07) 104 SP1 G31

None of the items included in this contract will be major items.

NO SPECIALTY ITEMS:

(7-1-95) 108-6 SP1 G34

None of the items included in this contract will be specialty items (see Article 108-6 of the 2018 Standard Specifications).

FUEL PRICE ADJUSTMENT:

(11-15-05) (Rev. 11-15-22) 109-8 SP1 G43

Revise the 2018 Standard Specifications as follows:

Page 1-87, Article 109-8, Fuel Price Adjustments, add the following:

The base index price for DIESEL #2 FUEL is **\$2.6511** per gallon. Where any of the following are included as pay items in the contract, they will be eligible for fuel price adjustment.

The pay items and the fuel factor used in calculating adjustments to be made will be as follows:

| Description | Units | Fuel Usage Factor Diesel |
|---|--------------|---------------------------------|
| Unclassified Excavation | Gal/CY | 0.29 |
| Borrow Excavation | Gal/CY | 0.29 |
| Class IV Subgrade Stabilization | Gal/Ton | 0.55 |
| Aggregate Base Course | Gal/Ton | 0.55 |
| Sub-Ballast | Gal/Ton | 0.55 |
| Erosion Control Stone | Gal/Ton | 0.55 |
| Rip Rap, Class _____ | Gal/Ton | 0.55 |
| Asphalt Concrete Base Course, Type _____ | Gal/Ton | 0.90 or 2.90 |
| Asphalt Concrete Intermediate Course, Type _____ | Gal/Ton | 0.90 or 2.90 |
| Asphalt Concrete Surface Course, Type _____ | Gal/Ton | 0.90 or 2.90 |
| Open-Graded Asphalt Friction Course | Gal/Ton | 0.90 or 2.90 |
| Permeable Asphalt Drainage Course, Type _____ | Gal/Ton | 0.90 or 2.90 |
| Sand Asphalt Surface Course, Type _____ | Gal/Ton | 0.90 or 2.90 |
| Ultra-thin Bonded Wearing Course | Gal/Ton | 0.90 or 2.90 |
| Aggregate for Cement Treated Base Course | Gal/Ton | 0.55 |
| Portland Cement for Cement Treated Base Course | Gal/Ton | 0.55 |
| > 11" Portland Cement Concrete Pavement | Gal/SY | 0.327 |
| Concrete Shoulders Adjacent to > 11" Pavement | Gal/SY | 0.327 |
| 9" to 11" Portland Cement Concrete Pavement | Gal/SY | 0.272 |
| Concrete Shoulders Adjacent to 9" to 11" Pavement | Gal/SY | 0.272 |
| < 9" Portland Cement Concrete Pavement | Gal/SY | 0.245 |
| Concrete Shoulders Adjacent to < 9" Pavement | Gal/SY | 0.245 |

For the asphalt items noted in the chart as eligible for fuel adjustments, the bidder may include the *Fuel Usage Factor Adjustment Form* with their bid submission if they elect to use the fuel usage factor. The *Fuel Usage Factor Adjustment Form* is found at the following link:

<https://connect.ncdot.gov/letting/LetCentral/Fuel%20Usage%20Factor%20Adjustment%20Form%20-%20Starting%20Nov%202022%20Lettings.pdf>

Select either 2.90 Gal/Ton fuel factor or 0.90 Gal/Ton fuel factor for each asphalt line item on the *Fuel Usage Factor Adjustment Form*. The selected fuel factor for each asphalt item will remain in effect for the duration of the contract.

Failure to complete the *Fuel Usage Factor Adjustment Form* will result in using 2.90 gallons per ton as the Fuel Usage Factor for Diesel for the asphalt items noted above. The contractor will not be permitted to change the Fuel Usage Factor after the bids are submitted.

MINORITY BUSINESS ENTERPRISE AND WOMEN BUSINESS ENTERPRISE (DIVISIONS):

(10-16-07)(Rev. 8-17-21)

102-15(J)

SP1 G67

Description

The purpose of this Special Provision is to carry out the North Carolina Department of Transportation's policy of ensuring nondiscrimination in the award and administration of contracts financed in whole or in part with State funds.

Definitions

Additional MBE/WBE Subcontractors - Any MBE/WBE submitted at the time of bid that will not be used to meet the Combined MBE/WBE goal. No submittal of a Letter of Intent is required.

Combined MBE/WBE Goal: A portion of the total contract, expressed as a percentage that is to be performed by committed MBE/WBE subcontractors.

Committed MBE/WBE Subcontractor - Any MBE/WBE submitted at the time of bid that is being used to meet the Combined MBE / WBE goal by submission of a Letter of Intent. Or any MBE or WBE used as a replacement for a previously committed MBE or WBE firm.

Contract Goal Requirement - The approved participation at time of award, but not greater than the advertised Combined MBE/WBE contract goal.

Goal Confirmation Letter - Written documentation from the Department to the bidder confirming the Contractor's approved, committed participation along with a listing of the committed MBE and WBE firms.

Manufacturer - A firm that operates or maintains a factory or establishment that produces on the premises, the materials or supplies obtained by the Contractor.

MBE Participation (Anticipated) - A portion of the total contract, expressed as a percentage that is anticipated to be performed by committed MBE subcontractor(s).

Minority Business Enterprise (MBE) - A firm certified as a Disadvantaged Minority-Owned Business Enterprise through the North Carolina Unified Certification Program.

Regular Dealer - A firm that owns, operates, or maintains a store, warehouse, or other establishment in which the materials or supplies required for the performance of the contract are bought, kept in stock, and regularly sold to the public in the usual course of business. A regular dealer engages in, as its principal business and in its own name, the purchase and sale or lease of the products in question. A regular dealer in such bulk items as steel, cement, gravel, stone, and petroleum products need not keep such products in stock, if it owns and operates distribution equipment for the products. Brokers and packagers are not regarded as manufacturers or regular dealers within the meaning of this section.

Replacement / Substitution – A full or partial reduction in the amount of work subcontracted to a committed (or an approved substitute) MBE/WBE firm.

North Carolina Unified Certification Program (NCUCP) - A program that provides comprehensive services and information to applicants for MBE/WBE certification. The MBE/WBE program follows the same regulations as the federal Disadvantaged Business Enterprise (DBE) program in accordance with 49 CFR Part 26.

United States Department of Transportation (USDOT) - Federal agency responsible for issuing regulations (49 CFR Part 26) and official guidance for the DBE program.

WBE Participation (Anticipated) - A portion of the total contract, expressed as a percentage that is anticipated to be performed by committed WBE subcontractor(s).

Women Business Enterprise (WBE) - A firm certified as a Disadvantaged Women-Owned Business Enterprise through the North Carolina Unified Certification Program.

Forms and Websites Referenced in this Provision

Payment Tracking System - On-line system in which the Contractor enters the payments made to MBE and WBE subcontractors who have performed work on the project.
<https://apps.dot.state.nc.us/Vendor/PaymentTracking/>

DBE-IS Subcontractor Payment Information - Form for reporting the payments made to all MBE/WBE firms working on the project. This form is for paper bid projects only.
<https://connect.ncdot.gov/business/Turnpike/Documents/Form%20DBE-IS%20Subcontractor%20Payment%20Information.pdf>

RF-1 MBE/WBE Replacement Request Form - Form for replacing a committed MBE or WBE.

<http://connect.ncdot.gov/projects/construction/Construction%20Forms/DBE%20MBE%20WBE%20Replacement%20Request%20Form.pdf>

SAF Subcontract Approval Form - Form required for approval to sublet the contract.
<http://connect.ncdot.gov/projects/construction/Construction%20Forms/Subcontract%20Approval%20Form%20Rev.%202012.zip>

JC-1 Joint Check Notification Form - Form and procedures for joint check notification. The form acts as a written joint check agreement among the parties providing full and prompt disclosure of the expected use of joint checks.

<http://connect.ncdot.gov/projects/construction/Construction%20Forms/Joint%20Check%20Notification%20Form.pdf>

Letter of Intent - Form signed by the Contractor and the MBE/WBE subcontractor, manufacturer or regular dealer that affirms that a portion of said contract is going to be performed by the signed MBE/WBE for the estimated amount (based on quantities and unit prices) listed at the time of bid.
<http://connect.ncdot.gov/letting/LetCentral/Letter%20of%20Intent%20to%20Perform%20as%20a%20Subcontractor.pdf>

Listing of MBE and WBE Subcontractors Form - Form for entering MBE/WBE subcontractors on a project that will meet the Combined MBE/WBE goal. This form is for paper bids only.
[http://connect.ncdot.gov/municipalities/Bid%20Proposals%20for%20LGA%20Content/09%20MBE-WBE%20Subcontractors%20\(State\).docx](http://connect.ncdot.gov/municipalities/Bid%20Proposals%20for%20LGA%20Content/09%20MBE-WBE%20Subcontractors%20(State).docx)

Subcontractor Quote Comparison Sheet - Spreadsheet for showing all subcontractor quotes in the work areas where MBEs and WBEs quoted on the project. This sheet is submitted with good faith effort packages.

<http://connect.ncdot.gov/business/SmallBusiness/Documents/DBE%20Subcontractor%20Quote%20Comparison%20Example.xls>

Combined MBE/WBE Goal

The Combined MBE/WBE Goal for this project is **3.0%**

The Combined Goal was established utilizing the following anticipated participation for Minority Business Enterprises and Women Business Enterprises:

(A) **Minority Business Enterprises 1.0%**

- (1) *If the anticipated MBE participation is more than zero*, the Contractor shall exercise all necessary and reasonable steps to ensure that MBEs participate in at least the percent of the contract as set forth above.
- (2) *If the anticipated MBE participation is zero*, the Contractor shall make an effort to recruit and use MBEs during the performance of the contract. Any MBE participation obtained shall be reported to the Department.

(B) Women Business Enterprises **2.0%**

- (1) *If the anticipated WBE participation is more than zero*, the Contractor shall exercise all necessary and reasonable steps to ensure that WBEs participate in at least the percent of the contract as set forth above.
- (2) *If the anticipated WBE participation is zero*, the Contractor shall make an effort to recruit and use WBEs during the performance of the contract. Any WBE participation obtained shall be reported to the Department.

The Bidder is required to submit only participation to meet the Combined MBE/WBE Goal. The Combined Goal may be met by submitting all MBE participation, all WBE participation, or a combination of MBE and WBE participation.

Directory of Transportation Firms (Directory)

Real-time information is available about firms doing business with the Department and firms that are certified through NCUCP in the Directory of Transportation Firms. Only firms identified in the Directory as MBE and WBE certified shall be used to meet the Combined MBE / WBE goal. The Directory can be found at the following link.

<https://www.ebs.nc.gov/VendorDirectory/default.html>

The listing of an individual firm in the directory shall not be construed as an endorsement of the firm's capability to perform certain work.

Listing of MBE/WBE Subcontractors

At the time of bid, bidders shall submit all MBE and WBE participation that they anticipate to use during the life of the contract. Only those identified to meet the Combined MBE/WBE goal will be considered committed, even though the listing shall include both committed MBE/WBE subcontractors and additional MBE/WBE subcontractors. Any additional MBE/WBE subcontractor participation above the goal will follow the banking guidelines found elsewhere in this provision. All other additional MBE/WBE subcontractor participation submitted at the time of bid will be used toward the Department's overall race-neutral goals. Only those firms with current MBE and WBE certification at the time of bid opening will be acceptable for listing in the bidder's submittal of MBE and WBE participation. The Contractor shall indicate the following required information:

(A) Electronic Bids

Bidders shall submit a listing of MBE and WBE participation in the appropriate section of the electronic submittal file.

- (1) Submit the names and addresses of MBE and WBE firms identified to participate in the contract. If the bidder uses the updated listing of MBE and WBE firms shown

in the electronic submittal file, the bidder may use the dropdown menu to access the name and address of the firms.

- (2) Submit the contract line numbers of work to be performed by each MBE and WBE firm. When no figures or firms are entered, the bidder will be considered to have no MBE or WBE participation.
- (3) The bidder shall be responsible for ensuring that the MBE and WBE are certified at the time of bid by checking the Directory of Transportation Firms. If the firm is not certified at the time of the bid-letting, that MBE's or WBE's participation will not count towards achieving the Combined MBE/WBE goal.

(B) Paper Bids

- (1) *If the Combined MBE/ WBE goal is more than zero,*
 - (a) Bidders, at the time the bid proposal is submitted, shall submit a listing of MBE/WBE participation, including the names and addresses on *Listing of MBE and WBE Subcontractors* contained elsewhere in the contract documents in order for the bid to be considered responsive. Bidders shall indicate the total dollar value of the MBE and WBE participation for the contract.
 - (b) If bidders have no MBE or WBE participation, they shall indicate this on the *Listing of MBE and WBE Subcontractors* by entering the word "None" or the number "0." This form shall be completed in its entirety. **Blank forms will not be deemed to represent zero participation.** Bids submitted that do not have MBE and WBE participation indicated on the appropriate form will not be read publicly during the opening of bids. The Department will not consider these bids for award and the proposal will be rejected.
 - (c) The bidder shall be responsible for ensuring that the MBE/WBE is certified at the time of bid by checking the Directory of Transportation Firms. If the firm is not certified at the time of the bid-letting, that MBE's or WBE's participation will not count towards achieving the Combined MBE/WBE goal.
- (2) *If the Combined MBE/WBE Goal is zero,* entries on the *Listing of MBE and WBE Subcontractors* are not required for the zero goal, however any MBE or WBE participation that is achieved during the project shall be reported in accordance with requirements contained elsewhere in the special provision.

MBE or WBE Prime Contractor

When a certified MBE or WBE firm bids on a contract that contains a Combined MBE/WBE Goal, the firm is responsible for meeting the goal or making good faith efforts to meet the goal, just like any other bidder. In most cases, a MBE or WBE bidder on a contract will meet the Combined MBE/WBE goal by virtue of the work it performs on the contract with its own forces. However, all the work that is performed by the MBE or WBE bidder and any other similarly certified subcontractors will count toward the goal. The MBE or WBE bidder shall list itself along with any MBE or WBE subcontractors, if any, in order to receive credit toward the goals.

MBE/WBE prime contractors shall also follow Sections A or B listed under *Listing of MBE/WBE Subcontractors* just as a non-MBE/WBE bidder would.

Written Documentation – Letter of Intent

The bidder shall submit written documentation for each MBE/WBE that will be used to meet the Combined MBE/WBE goal of the contract, indicating the bidder's commitment to use the MBE/WBE in the contract. This documentation shall be submitted on the Department's form titled *Letter of Intent*.

The documentation shall be received in the office of the Engineer no later than 2:00 p.m. of the fifth calendar day following opening of bids, unless the fifth day falls on Saturday, Sunday or an official state holiday. In that situation, it is due in the office of the Engineer no later than 10:00 a.m. on the next official state business day.

If the bidder fails to submit the Letter of Intent from each committed MBE and WBE to be used toward the Combined MBE/WBE goal, or if the form is incomplete (i.e. both signatures are not present), the MBE/WBE participation will not count toward meeting the Combined MBE/WBE goal. If the lack of this participation drops the commitment below the Combined MBE/WBE goal, the Contractor shall submit evidence of good faith efforts for the goal not met, completed in its entirety, to the Engineer no later than 2:00 p.m. of the eighth calendar day following opening of bids, unless the eighth day falls on Saturday, Sunday or an official state holiday. In that situation, it is due in the office of the Engineer no later than 10:00 a.m. on the next official state business day.

Banking MBE/WBE Credit

If the committed MBE/WBE participation submitted exceeds the algebraic sum of the Combined MBE/WBE goal by \$1,000 or more, the excess will be placed on deposit by the Department for future use by the bidder. Separate accounts will be maintained for MBE and WBE participation and these may accumulate for a period not to exceed 24 months.

When the apparent lowest responsive bidder fails to submit sufficient participation by MBE and WBE firms to meet the advertised goal, as part of the good faith effort, the Department will consider allowing the bidder to withdraw funds to meet the Combined MBE/WBE goal as long as there are adequate funds available from the bidder's MBE and WBE bank accounts.

Submission of Good Faith Effort

If the bidder fails to meet or exceed the Combined MBE/WBE goal, the apparent lowest responsive bidder shall submit to the Department documentation of adequate good faith efforts made to reach that specific goal.

One complete set and one electronic copy (**in .PDF format**) of this information shall be received in the office of the Engineer no later than 2:00 p.m. of the fifth calendar day following opening of bids, unless the fifth day falls on Saturday, Sunday or an official state holiday. In that situation, it is due in the office of the Engineer no later than 10:00 a.m. on the next official state business day.

Note: Where the information submitted includes repetitious solicitation letters, it will be acceptable to submit a representative letter along with a distribution list of the firms that were solicited. Documentation of MBE/WBE quotations shall be a part of the good faith effort submittal. This documentation may include written subcontractor quotations, telephone log notations of verbal quotations, or other types of quotation documentation.

Consideration of Good Faith Effort for Projects with a Combined MBE/WBE Goal More Than Zero

Adequate good faith efforts mean that the bidder took all necessary and reasonable steps to achieve the goal which, by their scope, intensity, and appropriateness, could reasonably be expected to obtain sufficient MBE/WBE participation. Adequate good faith efforts also mean that the bidder actively and aggressively sought MBE/WBE participation. Mere *pro forma* efforts are not considered good faith efforts.

The Department will consider the quality, quantity, and intensity of the different kinds of efforts a bidder has made. Listed below are examples of the types of actions a bidder will take in making a good faith effort to meet the goals and are not intended to be exclusive or exhaustive, nor is it intended to be a mandatory checklist.

- (A) Soliciting through all reasonable and available means (e.g. attendance at pre-bid meetings, advertising, written notices, use of verifiable electronic means through the use of the NCDOT Directory of Transportation Firms) the interest of all certified MBEs/WBEs that are also prequalified subcontractors. The bidder must solicit this interest within at least 10 days prior to bid opening to allow the MBEs/WBEs to respond to the solicitation. Solicitation shall provide the opportunity to MBEs/WBEs within the Division and surrounding Divisions where the project is located. The bidder must determine with certainty if the MBEs/WBEs are interested by taking appropriate steps to follow up initial solicitations.

- (B) Selecting portions of the work to be performed by MBEs/WBEs in order to increase the likelihood that the Combined MBE/WBE goal will be achieved.
 - (1) Where appropriate, break out contract work items into economically feasible units to facilitate MBE/WBE participation, even when the prime contractor might otherwise prefer to perform these work items with its own forces.
 - (2) Negotiate with subcontractors to assume part of the responsibility to meet the advertised goal when the work to be sublet includes potential for MBE/WBE participation (2nd and 3rd tier subcontractors).
- (C) Providing interested certified MBEs/WBEs that are also prequalified subcontractors with adequate information about the plans, specifications, and requirements of the contract in a timely manner to assist them in responding to a solicitation.
- (D)
 - (1) Negotiating in good faith with interested MBEs/WBEs. It is the bidder's responsibility to make a portion of the work available to MBE/WBE subcontractors and suppliers and to select those portions of the work or material needs consistent with the available MBE/WBE subcontractors and suppliers, so as to facilitate MBE/WBE participation. Evidence of such negotiation includes the names, addresses, and telephone numbers of MBEs/WBEs that were considered; a description of the information provided regarding the plans and specifications for the work selected for subcontracting; and evidence as to why additional agreements could not be reached for MBEs/WBEs to perform the work.
 - (2) A bidder using good business judgment would consider a number of factors in negotiating with subcontractors, including MBE/WBE subcontractors, and would take a firm's price and capabilities as well as the advertised goal into consideration. However, the fact that there may be some additional costs involved in finding and using MBEs/WBEs is not in itself sufficient reason for a bidder's failure to meet the advertised goal, as long as such costs are reasonable. Also, the ability or desire of a prime contractor to perform the work of a contract with its own organization does not relieve the bidder of the responsibility to make good faith efforts. Bidding contractors are not, however, required to accept higher quotes from MBEs/WBEs if the price difference is excessive or unreasonable.
- (E) Not rejecting MBEs/WBEs as being unqualified without sound reasons based on a thorough investigation of their capabilities. The bidder's standing within its industry, membership in specific groups, organizations, or associates and political or social affiliations (for example, union vs. non-union employee status) are not legitimate causes for the rejection or non-solicitation of bids in the bidder's efforts to meet the project goal.
- (F) Making efforts to assist interested MBEs/WBEs in obtaining bonding, lines of credit, or insurance as required by the recipient or bidder.

- (G) Making efforts to assist interested MBEs/WBEs in obtaining necessary equipment, supplies, materials, or related assistance or services.
- (H) Effectively using the services of available minority/women community organizations; minority/women contractors' groups; Federal, State, and local minority/women business assistance offices; and other organizations as allowed on a case-by-case basis to provide assistance in the recruitment and placement of MBEs/WBEs. Contact within 7 days from the bid opening the Business Opportunity and Work Force Development Unit at BOWD@ncdot.gov to give notification of the bidder's inability to get MBE or WBE quotes.
- (I) Any other evidence that the bidder submits which shows that the bidder has made reasonable good faith efforts to meet the advertised goal.

In addition, the Department may take into account the following:

- (1) Whether the bidder's documentation reflects a clear and realistic plan for achieving the Combined MBE/WBE goal.
- (2) The bidders' past performance in meeting the contract goal.
- (3) The performance of other bidders in meeting the advertised goal. For example, when the apparent successful bidder fails to meet the goal, but others meet it, you may reasonably raise the question of whether, with additional reasonable efforts the apparent successful bidder could have met the goal. If the apparent successful bidder fails to meet the advertised goal, but meets or exceeds the average MBE and WBE participation obtained by other bidders, the Department may view this, in conjunction with other factors, as evidence of the apparent successful bidder having made a good faith effort.

If the Department does not award the contract to the apparent lowest responsive bidder, the Department reserves the right to award the contract to the next lowest responsive bidder that can satisfy to the Department that the Combined MBE/WBE goal can be met or that an adequate good faith effort has been made to meet the advertised goal.

Non-Good Faith Appeal

The Engineer will notify the contractor verbally and in writing of non-good faith. A contractor may appeal a determination of non-good faith made by the Goal Compliance Committee. If a contractor wishes to appeal the determination made by the Committee, they shall provide written notification to the Engineer. The appeal shall be made within 2 business days of notification of the determination of non-good faith.

Counting MBE/WBE Participation Toward Meeting the Combined MBE/WBE Goal

(A) Participation

The total dollar value of the participation by a committed MBE/WBE will be counted toward the contract goal requirements. The total dollar value of participation by a committed MBE/WBE will be based upon the value of work actually performed by the MBE/WBE and the actual payments to MBE/WBE firms by the Contractor.

(B) Joint Checks

Prior notification of joint check use shall be required when counting MBE/WBE participation for services or purchases that involves the use of a joint check. Notification shall be through submission of Form JC-1 (*Joint Check Notification Form*) and the use of joint checks shall be in accordance with the Department's Joint Check Procedures.

(C) Subcontracts (Non-Trucking)

A MBE/WBE may enter into subcontracts. Work that a MBE subcontracts to another MBE firm may be counted toward the anticipated MBE participation. The same holds for work that a WBE subcontracts to another WBE firm. Work that a MBE/WBE subcontracts to a non-MBE/WBE firm does not count toward the contract goal requirement. It should be noted that every effort shall be made by MBE and WBE contractors to subcontract to the same certification (i.e., MBEs to MBEs and WBEs to WBEs), in order to fulfill the MBE or WBE participation breakdown. This, however, may not always be possible due to the limitation of firms in the area. If the MBE or WBE firm shows a good faith effort has been made to reach out to similarly certified firms and there is no interest or availability, and they can get assistance from other certified firms, the Engineer will not hold the prime responsible for meeting the individual MBE or WBE breakdown. If a MBE or WBE contractor or subcontractor subcontracts a significantly greater portion of the work of the contract than would be expected on the basis of standard industry practices, it shall be presumed that the MBE or WBE is not performing a commercially useful function.

(D) Joint Venture

When a MBE or WBE performs as a participant in a joint venture, the Contractor may count toward its contract goal requirement a portion of the total value of participation with the MBE or WBE in the joint venture, that portion of the total dollar value being a distinct clearly defined portion of work that the MBE or WBE performs with its forces.

(E) Suppliers

A contractor may count toward its MBE /WBE requirement 60 percent of its expenditures for materials and supplies required to complete the contract and obtained from a MBE or

WBE regular dealer and 100 percent of such expenditures from a MBE or WBE manufacturer.

(F) Manufacturers and Regular Dealers

A contractor may count toward its MBE /WBE requirement the following expenditures to MBE/WBE firms that are not manufacturers or regular dealers:

- (1) The fees or commissions charged by a MBE/WBE firm for providing a *bona fide* service, such as professional, technical, consultant, or managerial services, or for providing bonds or insurance specifically required for the performance of a DOT-assisted contract, provided the fees or commissions are determined to be reasonable and not excessive as compared with fees and commissions customarily allowed for similar services.
- (2) With respect to materials or supplies purchased from a MBE/WBE, which is neither a manufacturer nor a regular dealer, count the entire amount of fees or commissions charged for assistance in the procurement of the materials and supplies, or fees or transportation charges for the delivery of materials or supplies required on a job site (but not the cost of the materials and supplies themselves), provided the fees are determined to be reasonable and not excessive as compared with fees customarily allowed for similar services.

Commercially Useful Function

(A) MBE/WBE Utilization

The Contractor may count toward its contract goal requirement only expenditures to MBEs and WBEs that perform a commercially useful function in the work of a contract. A MBE/WBE performs a commercially useful function when it is responsible for execution of the work of the contract and is carrying out its responsibilities by actually performing, managing, and supervising the work involved. To perform a commercially useful function, the MBE/WBE shall also be responsible with respect to materials and supplies used on the contract, for negotiating price, determining quality and quantity, ordering the material and installing (where applicable) and paying for the material itself. To determine whether a MBE/WBE is performing a commercially useful function, the Department will evaluate the amount of work subcontracted, industry practices, whether the amount the firm is to be paid under the contract is commensurate with the work it is actually performing and the MBE/WBE credit claimed for its performance of the work, and any other relevant factors. If it is determined that a MBE or WBE is not performing a Commercially Useful Function, the contractor may present evidence to rebut this presumption to the Department.

(B) MBE/WBE Utilization in Trucking

The following factors will be used to determine if a MBE or WBE trucking firm is performing a commercially useful function:

- (1) The MBE/WBE shall be responsible for the management and supervision of the entire trucking operation for which it is responsible on a particular contract, and there shall not be a contrived arrangement for the purpose of meeting the Combined MBE/WBE goal.
- (2) The MBE/WBE shall itself own and operate at least one fully licensed, insured, and operational truck used on the contract.
- (3) The MBE/WBE receives credit for the total value of the transportation services it provides on the contract using trucks it owns, insures, and operates using drivers it employs.
- (4) The MBE may subcontract the work to another MBE firm, including an owner-operator who is certified as a MBE. The same holds true that a WBE may subcontract the work to another WBE firm, including an owner-operator who is certified as a WBE. When this occurs, the MBE or WBE who subcontracts work receives credit for the total value of the transportation services the subcontracted MBE or WBE provides on the contract. It should be noted that every effort shall be made by MBE and WBE contractors to subcontract to the same certification (i.e., MBEs to MBEs and WBEs to WBEs), in order to fulfill the participation breakdown. This, however, may not always be possible due to the limitation of firms in the area. If the MBE or WBE firm shows a good faith effort has been made to reach out to similarly certified transportation service providers and there is no interest or availability, and they can get assistance from other certified providers, the Engineer will not hold the prime responsible for meeting the individual MBE or WBE participation breakdown.
- (5) The MBE/WBE may also subcontract the work to a non-MBE/WBE firm, including from an owner-operator. The MBE/WBE who subcontracts the work to a non-MBE/WBE is entitled to credit for the total value of transportation services provided by the non-MBE/WBE subcontractor not to exceed the value of transportation services provided by MBE/WBE-owned trucks on the contract. Additional participation by non-MBE/WBE subcontractors receives credit only for the fee or commission it receives as a result of the subcontract arrangement. The value of services performed under subcontract agreements between the MBE/WBE and the Contractor will not count towards the MBE/WBE contract requirement.
- (6) A MBE/WBE may lease truck(s) from an established equipment leasing business open to the general public. The lease must indicate that the MBE/WBE has exclusive use of and control over the truck. This requirement does not preclude the leased truck from working for others during the term of the lease with the consent

of the MBE/WBE, so long as the lease gives the MBE/WBE absolute priority for use of the leased truck. This type of lease may count toward the MBE/WBE's credit as long as the driver is under the MBE/WBE's payroll.

- (7) Subcontracted/leased trucks shall display clearly on the dashboard the name of the MBE/WBE that they are subcontracted/leased to and their own company name if it is not identified on the truck itself. Magnetic door signs are not permitted.

MBE/WBE Replacement

When a Contractor has relied on a commitment to a MBE or WBE subcontractor (or an approved substitute MBE or WBE subcontractor) to meet all or part of a contract goal requirement, the contractor shall not terminate the MBE/WBE subcontractor for convenience. This includes, but is not limited to, instances in which the Contractor seeks to perform the work of the terminated subcontractor with another MBE/WBE subcontractor, a non-MBE/WBE subcontractor, or with the Contractor's own forces or those of an affiliate.

The Contractor must give notice in writing both by certified mail and email to the MBE/WBE subcontractor, with a copy to the Engineer of its intent to request to terminate and/or substitute, and the reason for the request. The Contractor must give the MBE/WBE subcontractor five (5) business days to respond to the Contractor's Notice of Intent to Request Termination and/or Substitution. If the MBE/WBE subcontractor objects to the intended termination/substitution, the MBE/WBE, within five (5) business days must advise the Contractor and the Department of the reasons why the action should not be approved. The five-day notice period shall begin on the next business day after written notice is provided to the MBE/WBE subcontractor.

A committed MBE/WBE subcontractor may only be terminated after receiving the Department's written approval based upon a finding of good cause for the proposed termination and/or substitution. For purposes of this section, good cause shall include the following circumstances:

- (a) The listed MBE/WBE subcontractor fails or refuses to execute a written contract;
- (b) The listed MBE/WBE subcontractor fails or refuses to perform the work of its subcontract in a way consistent with normal industry standards. Provided, however, that good cause does not exist if the failure or refusal of the MBE/WBE subcontractor to perform its work on the subcontract results from the bad faith or discriminatory action of the prime contractor;
- (c) The listed MBE/WBE subcontractor fails or refuses to meet the prime contractor's reasonable, nondiscriminatory bond requirements;
- (d) The listed MBE/WBE subcontractor becomes bankrupt, insolvent, or exhibits credit unworthiness;
- (e) The listed MBE/WBE subcontractor is ineligible to work on public works projects because of suspension and debarment proceedings pursuant to 2 CFR Parts 180, 215 and 1,200 or applicable state law;
- (f) The listed MBE/WBE subcontractor is not a responsible contractor;
- (g) The listed MBE/WBE voluntarily withdraws from the project and provides written notice of withdrawal;

- (h) The listed MBE/WBE is ineligible to receive MBE/WBE credit for the type of work required;
- (i) A MBE/WBE owner dies or becomes disabled with the result that the listed MBE/WBE contractor is unable to complete its work on the contract;
- (j) Other documented good cause that compels the termination of the MBE/WBE subcontractor. Provided, that good cause does not exist if the prime contractor seeks to terminate a MBE/WBE it relied upon to obtain the contract so that the prime contractor can self-perform the work for which the MBE/WBE contractor was engaged or so that the prime contractor can substitute another MBE/WBE or non-MBE/WBE contractor after contract award.

The Contractor shall comply with the following for replacement of a committed MBE/WBE:

(A) Performance Related Replacement

When a committed MBE/WBE is terminated for good cause as stated above, an additional MBE/WBE that was submitted at the time of bid may be used to fulfill the MBE/WBE commitment to meet the Combined MBE/WBE Goal. A good faith effort will only be required for removing a committed MBE/WBE if there were no additional MBE/WBEs submitted at the time of bid to cover the same amount of work as the MBE/WBE that was terminated.

If a replacement MBE/WBE is not found that can perform at least the same amount of work as the terminated MBE/WBE, the Contractor shall submit a good faith effort documenting the steps taken. Such documentation shall include, but not be limited to, the following:

- (1) Copies of written notification to MBE/WBEs that their interest is solicited in contracting the work defaulted by the previous MBE/WBE or in subcontracting other items of work in the contract.
- (2) Efforts to negotiate with MBE/WBEs for specific subbids including, at a minimum:
 - (a) The names, addresses, and telephone numbers of MBE/WBEs who were contacted.
 - (b) A description of the information provided to MBE/WBEs regarding the plans and specifications for portions of the work to be performed.
- (3) A list of reasons why MBE/WBE quotes were not accepted.
- (4) Efforts made to assist the MBE/WBEs contacted, if needed, in obtaining bonding or insurance required by the Contractor.

(B) Decertification Replacement

- (1) When a committed MBE/WBE is decertified by the Department after the SAF (*Subcontract Approval Form*) has been received by the Department, the

Department will not require the Contractor to solicit replacement MBE/WBE participation equal to the remaining work to be performed by the decertified firm. The participation equal to the remaining work performed by the decertified firm will count toward the contract goal requirement.

- (2) When a committed MBE/WBE is decertified prior to the Department receiving the SAF (*Subcontract Approval Form*) for the named MBE/WBE firm, the Contractor shall take all necessary and reasonable steps to replace the MBE/WBE subcontractor with another MBE/WBE subcontractor to perform at least the same amount of work to meet the Combined MBE/WBE goal requirement. If a MBE/WBE firm is not found to do the same amount of work, a good faith effort must be submitted to NCDOT (see A herein for required documentation).
- (3) Exception: If the MBE/WBE's ineligibility is caused solely by its having exceeded the size standard during the performance of the contract, the Department will not require the Contractor to solicit replacement MBE/WBE participation equal to the remaining work to be performed by the decertified firm. The participation equal to the remaining work performed by the decertified firm will count toward the contract goal requirement and overall goal.

All requests for replacement of a committed MBE/WBE firm shall be submitted to the Engineer for approval on Form RF-1 (*DBE Replacement Request*). If the Contractor fails to follow this procedure, the Contractor may be disqualified from further bidding for a period of up to 6 months.

Changes in the Work

When the Engineer makes changes that result in the reduction or elimination of work to be performed by a committed MBE/WBE, the Contractor will not be required to seek additional participation. When the Engineer makes changes that result in additional work to be performed by a MBE/WBE based upon the Contractor's commitment, the MBE/WBE shall participate in additional work to the same extent as the MBE/WBE participated in the original contract work.

When the Engineer makes changes that result in extra work, which has more than a minimal impact on the contract amount, the Contractor shall seek additional participation by MBEs/WBEs unless otherwise approved by the Engineer.

When the Engineer makes changes that result in an alteration of plans or details of construction, and a portion or all of the work had been expected to be performed by a committed MBE/WBE, the Contractor shall seek participation by MBEs/WBEs unless otherwise approved by the Engineer.

When the Contractor requests changes in the work that result in the reduction or elimination of work that the Contractor committed to be performed by a MBE/WBE, the Contractor shall seek additional participation by MBEs/WBEs equal to the reduced MBE/WBE participation caused by the changes.

Reports and Documentation

A SAF (*Subcontract Approval Form*) shall be submitted for all work which is to be performed by a MBE/WBE subcontractor. The Department reserves the right to require copies of actual subcontract agreements involving MBE/WBE subcontractors.

When using transportation services to meet the contract commitment, the Contractor shall submit a proposed trucking plan in addition to the SAF. The plan shall be submitted prior to beginning construction on the project. The plan shall include the names of all trucking firms proposed for use, their certification type(s), the number of trucks owned by the firm, as well as the individual truck identification numbers, and the line item(s) being performed.

Within 30 calendar days of entering into an agreement with a MBE/WBE for materials, supplies or services, not otherwise documented by the SAF as specified above, the Contractor shall furnish the Engineer a copy of the agreement. The documentation shall also indicate the percentage (60% or 100%) of expenditures claimed for MBE/WBE credit.

Reporting Minority and Women Business Enterprise Participation

The Contractor shall provide the Engineer with an accounting of payments made to all MBE and WBE firms, including material suppliers and contractors at all levels (prime, subcontractor, or second tier subcontractor). This accounting shall be furnished to the Engineer for any given month by the end of the following month. Failure to submit this information accordingly may result in the following action:

- (A) Withholding of money due in the next partial pay estimate; or
- (B) Removal of an approved contractor from the prequalified bidders' list or the removal of other entities from the approved subcontractors list.

While each contractor (prime, subcontractor, 2nd tier subcontractor) is responsible for accurate accounting of payments to MBEs/WBEs, it shall be the prime contractor's responsibility to report all monthly and final payment information in the correct reporting manner.

Failure on the part of the Contractor to submit the required information in the time frame specified may result in the disqualification of that contractor and any affiliate companies from further bidding until the required information is submitted.

Failure on the part of any subcontractor to submit the required information in the time frame specified may result in the disqualification of that contractor and any affiliate companies from being approved for further work on future projects until the required information is submitted.

Contractors reporting transportation services provided by non-MBE/WBE lessees shall evaluate the value of services provided during the month of the reporting period only.

At any time, the Engineer can request written verification of subcontractor payments.

The Contractor shall report the accounting of payments through the Department's DBE Payment Tracking System.

Failure to Meet Contract Requirements

Failure to meet contract requirements in accordance with Subarticle 102-15(J) of the *2018 Standard Specifications* may be cause to disqualify the Contractor.

USE OF UNMANNED AIRCRAFT SYSTEM (UAS):

(8-20-19)

SP1 G092

The Contractor shall adhere to all Federal, State and Local regulations and guidelines for the use of Unmanned Aircraft Systems (UAS). This includes but is not limited to US 14 CFR Part 107 *Small UAS Rule*, NC GS 15A-300.2 *Regulation of launch and recovery sites*, NC GS 63-95 *Training required for the operation of unmanned aircraft systems*, NC GS 63-96 *Permit required for commercial operation of unmanned aircraft system*, and NCDOT UAS Policy. The required operator certifications include possessing a current Federal Aviation Administration (FAA) Remote Pilot Certificate, a NC UAS Operator Permit as well as operating a UAS registered with the FAA.

Prior to beginning operations, the Contractor shall complete the NCDOT UAS – Flight Operation Approval Form and submit it to the Engineer for approval. All UAS operations shall be approved by the Engineer prior to beginning the operations.

All contractors or subcontractors operating UAS shall have UAS specific general liability insurance to cover all operations under this contract.

The use of UAS is at the Contractor's discretion. No measurement or payment will be made for the use of UAS. In the event that the Department directs the Contractor to utilize UAS, payment will be in accordance with Article 104-7 Extra Work.

EQUIPMENT IDLING GUIDELINES:

(1-19-21)

107

SP1 G096

Exercise reduced fuel consumption and reduced equipment emissions during the construction of all work associated with this contract. Employees engaged in the construction of this project should turn off vehicles when stopped for more than thirty (30) minutes and off-highway equipment should idle no longer than fifteen (15) consecutive minutes.

These guidelines for turning off vehicles and equipment when idling do not apply to:

1. Idling when queuing.
2. Idling to verify the vehicle is in safe operating condition.
3. Idling for testing, servicing, repairing or diagnostic purposes.
4. Idling necessary to accomplish work for which the vehicle was designed (such as operating a crane, mixing concrete, etc.).

5. Idling required to bring the machine system to operating temperature.
6. Emergency vehicles, utility company, construction, and maintenance vehicles where the engines must run to perform needed work.
7. Idling to ensure safe operation of the vehicle.
8. Idling when the propulsion engine is providing auxiliary power for other than heating or air conditioning. (such as hydraulic systems for pavers)
9. When specific traffic, safety, or emergency situations arise.
10. If the ambient temperature is less than 32 degrees Fahrenheit. Limited idling to provide for the safety of vehicle occupants (e.g. to run the heater).
11. If the ambient temperature is greater than 90 degrees Fahrenheit. Limited idling to provide for the safety of vehicle occupants of off-highway equipment (e.g. to run the air conditioning) no more than 30 minutes.
12. Diesel powered vehicles may idle for up to 30 minutes to minimize restart problems.

Any vehicle, truck, or equipment in which the primary source of fuel is natural gas or electricity is exempt from the idling limitations set forth in this special provision.

ELECTRONIC BIDDING:

(2-19-19)

101, 102, 103

SP1 G140

Revise the *2018 Standard Specifications* as follows:

Page 1-4, Article 101-3, DEFINITIONS, BID (OR PROPOSAL) *Electronic Bid*, line 1, replace “Bid Express®” with “the approved electronic bidding provider”.

Page 1-15, Subarticle 102-8(B), Electronic Bids, lines 39-40, replace “to Bid Express®” with “via the approved electronic bidding provider”.

Page 1-15, Subarticle 102-8(B)(1), Electronic Bids, line 41, delete “from Bid Express®”

Page 1-17, Subarticle 102-9(C)(2), Electronic Bids, line 21, replace “Bid Express® miscellaneous folder within the .ebs” with “electronic submittal”.

Page 1-29, Subarticle 103-4(C)(2), Electronic Bids, line 32, replace “.ebs miscellaneous data file of Expedite” with “electronic submittal file”

AWARD LIMITS:

(4-19-22)

103

SP1 G141

Revise the *2018 Standard Specifications* as follows:

Page 1-29, Subarticle 103-4(C), Award Limits, line 4-8, delete and replace the first sentence in the first paragraph with the following:

A bidder who desires to bid on more than one project on which bids are to be opened in the same letting and who desires to avoid receiving an award of more projects than he is equipped to handle, may bid on any number of projects but may limit the total amount of work awarded to him on selected projects by completing the form Award Limits on Multiple Projects for each project subject to the award limit.

OUTSOURCING OUTSIDE THE USA:

(9-21-04) (Rev. 5-16-06)

SP1 G150

All work on consultant contracts, services contracts, and construction contracts shall be performed in the United States of America. No work shall be outsourced outside of the United States of America.

Outsourcing for the purpose of this provision is defined as the practice of subcontracting labor, work, services, staffing, or personnel to entities located outside of the United States.

The North Carolina Secretary of Transportation shall approve exceptions to this provision in writing.

PROJECT SPECIAL PROVISIONS

ROADWAY

CONSTRUCTION SEQUENCE:

(7-1-95) (Rev. 8-21-12)

560

SP1 R34R

Pave each section of roadway begun in a continuous operation. Do not begin work on another section of roadway unless satisfactory progress is being made toward completion of intersections and all other required incidental work by satisfactorily furnishing additional paving equipment and personnel, except for milling and patching operations.

INCIDENTAL STONE BASE:

(7-1-95) (Rev.8-21-12)

545

SP5 R28R

Description

Place incidental stone base on driveways, mailboxes, etc. immediately after paving and do not have the paving operations exceed stone base placement by more than one week without written permission of the Engineer.

Materials and Construction

Provide and place incidental stone base in accordance with Section 545 of the *2018 Standard Specifications*.

Measurement and Payment

Incidental Stone Base will be measured and paid in accordance with Article 545-6 of the *2018 Standard Specifications*.

INCIDENTAL MILLING:

(11-15-22)(Rev. 1-17-23)

607

SP6 R02R

Revise the *2018 Standard Specifications* as follows:

Page 6-5, Article 607-3 CONSTRUCTION METHODS, add the following paragraph after line 45:

Variable depth milling is intended to improve the cross-sectional slope of the pavement.

Page 6-6, Article 607-3 CONSTRUCTION METHODS, line 9, delete and replace the first sentence in the sixth paragraph with the following:

The Engineer may require re-milling of any area exhibiting pavement laminations, scabbing or other defects.

Page 6-6, Article 607-4 TOLERANCE, lines 17-18, delete and replace the second sentence with the following:

The Engineer may vary the depth of milling by not more than one inch. In the event the directed depth of milling cut is altered by the Engineer more than one inch, either the Department or the Contractor may request an adjustment in unit price in accordance with Article 104-3. In administering Article 104-3, the Department will give no consideration to value given to RAP due to the deletion or reduction in quantity of milling. Article 104-3 will not apply to the item of *Incidental Milling*.

Page 6-6, Subarticle 607-5(A) Milled Asphalt Pavement, lines 21-23, delete and replace the first sentence with the following:

Milled Asphalt Pavement, ___" Depth will be measured and paid as the actual number of square yards of pavement surface milled in accordance with this specification.

Page 6-6, Subarticle 607-5(A) Milled Asphalt Pavement, lines 24-28, delete and replace the third and fourth sentence with the following:

The width will be the width required by the plans or directed by the Engineer, measured along the pavement surface. Areas to be paid under this item include mainline travel lanes, full width turn lanes greater than 500 feet in length, collector lanes, shoulders, and any additional equipment necessary to remove pavement in the area of manholes, water valves, curb, gutter and other obstructions.

Page 6-6, Subarticle 607-5(B) Milled Asphalt Pavement Depth Varies from Required Depth, lines 29-37, delete and replace the title and first paragraph with the following:

(B) Variable Depth Milled Asphalt Pavement

Milling Asphalt Pavement, ___" to ___" will be measured and paid as the actual number of square yards of pavement surface milled in accordance with this specification. In measuring this quantity, the length will be the actual length milled, measured along the pavement surface. The width will be the width required by the plans or directed by the Engineer, measured along the pavement surface. Areas to be paid under this item include mainline travel lanes, full width turn lanes greater than 500 feet in length, collector lanes, shoulders, and any additional equipment necessary to remove pavement in the area of manholes, water valves, curb, gutter and other obstructions.

Page 6-6, Subarticle 607-5(C) Incidental Milling, lines 45-49, delete and replace the first and second sentence with the following:

Incidental Milling will be measured and paid as the actual number of square yards of surface milled where the Contractor is required to mill butt joints, irregular areas, full width turn lanes 500 feet or less, intersections and re-mill areas that are not due to the Contractor's negligence. In measuring this quantity, the length will be the actual length milled, measured along the pavement

surface. The width will be the width required by the plans or directed by the Engineer, measured along the pavement surface.

Page 6-7, Subarticle 607-5(D) Milling of Defects, lines 6-10, delete and replace the second sentence with the following:

If the Engineer directs re-milling of an area and is not due to the Contractor's negligence, the re-milled area will be measured as provided in Subarticle 607-5(C) and paid at the contract unit price per square yard for *Incidental Milling*.

SHOULDER WEDGE:

(9-20-11) (Rev. 8-21-12)

610

SP6 R03R

Revise the *2018 Standard Specifications* as follows:

Page 6-21, Article 610-8, SPREADING AND FINISHING, add the following after line 39:

Attach a device, mounted on screed of paving equipment, capable of constructing a shoulder wedge with an angle of 30 degrees plus or minus 4 degrees along the outside edge of the roadway, measured from the horizontal plane in place after final compaction on the final surface course. Use an approved mechanical device which will form the asphalt mixture to produce a wedge with uniform texture, shape and density while automatically adjusting to varying heights.

Payment for use of this device will be incidental to the other pay items in the contract.

PRICE ADJUSTMENT - ASPHALT BINDER FOR PLANT MIX:

(11-21-00)

620

SP6 R25

Price adjustments for asphalt binder for plant mix will be made in accordance with Section 620 of the *2018 Standard Specifications*.

The base price index for asphalt binder for plant mix is **\$639.38** per ton.

This base price index represents an average of F.O.B. selling prices of asphalt binder at supplier's terminals on **May 1, 2023**.

FINAL SURFACE TESTING NOT REQUIRED:

(5-18-04) (Rev. 2-16-16)

610

SP6 R45

Final surface testing is not required on this project in accordance with Section 610-13, *Final Surface Testing and Acceptance*.

MILLING ASPHALT PAVEMENT:

(1-15-19)

607

SP6 R59

Revise the *2018 Standard Specifications* as follows:

Page 6-5, Article 607-2, EQUIPMENT, lines 14-16, delete the seventh sentence of this Article and replace with the following:

Use either a non-contacting laser or sonar type ski system with a minimum of three referencing stations mounted on the milling machine at a length of at least 24 feet.

ASPHALT CONCRETE PLANT MIX PAVEMENTS:

(2-20-18) (Rev. 6-20-23)

610, 1012

SP6 R65

Revise the *2018 Standard Specifications* as follows:

Page 6-14, Table 609-3, LIMITS OF PRECISION FOR TEST RESULTS, replace with the following:

| TABLE 609-3 LIMITS OF PRECISION FOR TEST RESULTS | |
|--|----------------------------|
| Mix Property | Limits of Precision |
| 25.0 mm sieve (Base Mix) | ± 10.0% |
| 19.0 mm sieve (Base Mix) | ± 10.0% |
| 12.5 mm sieve (Intermediate & Type P-57) | ± 6.0% |
| 9.5 mm sieve (Surface Mix) | ± 5.0% |
| 4.75 mm sieve (Surface Mix) | ± 5.0% |
| 2.36 mm sieve (All Mixes, except S4.75A) | ± 5.0% |
| 1.18 mm sieve (S4.75A) | ± 5.0% |
| 0.075 mm sieve (All Mixes) | ± 2.0% |
| Asphalt Binder Content | ± 0.5% |
| Maximum Specific Gravity (G_{mm}) | ± 0.020 |
| Bulk Specific Gravity (G_{mb}) | ± 0.030 |
| TSR | ± 15.0% |
| QA retest of prepared QC Gyratory Compacted Volumetric Specimens | ± 0.015 |
| Retest of QC Core Sample | ± 1.2% (% Compaction) |
| Comparison QA Core Sample | ± 2.0% (% Compaction) |
| QA Verification Core Sample | ± 2.0% (% Compaction) |
| Density Gauge Comparison of QC Test | ± 2.0% (% Compaction) |
| QA Density Gauge Verification Test | ± 2.0% (% Compaction) |

Page 6-17, Table 610-1, MIXING TEMPERATURE AT THE ASPHALT PLANT, replace with the following:

| TABLE 610-1 MIXING TEMPERATURE AT THE ASPHALT PLANT | |
|--|-----------------|
| Binder Grade | JMF Temperature |
| PG 58-28; PG 64-22 | 250 - 290°F |
| PG 76-22 | 300 - 325°F |

Page 6-17, Subarticle 610-3(C), Job Mix Formula (JMF), lines 38-39, delete the fourth paragraph.

Page 6-18, Subarticle 610-3(C), Job Mix Formula (JMF), line 12, replace “SF9.5A” with “S9.5B”.

Page 6-18, Table 610-3, MIX DESIGN CRITERIA, replace with the following:

| TABLE 610-3 MIX DESIGN CRITERIA | | | | | | | | | |
|------------------------------------|--|-----------------|-------------------|------------------|---------------------|------------------------------------|-----------|-----------|--------------------|
| Mix Type | Design ESALs millions ^A | Binder PG Grade | Compaction Levels | | Max. Rut Depth (mm) | Volumetric Properties ^B | | | |
| | | | G _{mm} @ | | | VMA | VTM | VFA | %G _{mm} |
| | | | N _{ini} | N _{des} | | % Min. | % | Min.-Max. | @ N _{ini} |
| S4.75A | < 1 | 64 - 22 | 6 | 50 | 11.5 | 16.0 | 4.0 - 6.0 | 65 - 80 | ≤ 91.5 |
| S9.5B | 0 - 3 | 64 - 22 | 6 | 50 | 9.5 | 16.0 | 3.0 - 5.0 | 70 - 80 | ≤ 91.5 |
| S9.5C | 3 - 30 | 64 - 22 | 7 | 65 | 6.5 | 15.5 | 3.0 - 5.0 | 65 - 78 | ≤ 90.5 |
| S9.5D | > 30 | 76 - 22 | 8 | 100 | 4.5 | 15.5 | 3.0 - 5.0 | 65 - 78 | ≤ 90.0 |
| I19.0C | ALL | 64 - 22 | 7 | 65 | - | 13.5 | 3.0 - 5.0 | 65 - 78 | ≤ 90.5 |
| B25.0C | ALL | 64 - 22 | 7 | 65 | - | 12.5 | 3.0 - 5.0 | 65 - 78 | ≤ 90.5 |
| Design Parameter | | | | | Design Criteria | | | | |
| All Mix Types | Dust to Binder Ratio (P _{0.075} / P _{bc}) | | | | | 0.6 - 1.4 ^C | | | |
| | Tensile Strength Ratio (TSR) ^D | | | | | 85% Min. ^E | | | |

- A. Based on 20 year design traffic.
- B. Volumetric Properties based on specimens compacted to N_{des} as modified by the Department.
- C. Dust to Binder Ratio (P_{0.075} / P_{bc}) for Type S4.75A is 1.0 - 2.0.
- D. NCDOT-T-283 (No Freeze-Thaw cycle required).
- E. TSR for Type S4.75A & B25.0C mixes is 80% minimum.

Page 6-19, Table 610-5, BINDER GRADE REQUIREMENTS (BASED ON RBR%), replace with the following:

| TABLE 610-5 BINDER GRADE REQUIREMENTS (BASED ON RBR%) | | | |
|--|-----------------------|-----------------------|------------|
| Mix Type | %RBR ≤ 20% | 21% ≤ %RBR ≤ 30% | %RBR ≥ 30% |
| S4.75A, S9.5B, S9.5C, I19.0C, B25.0C | PG 64-22 | PG 64-22 ^A | PG-58-28 |
| S9.5D, OGFC | PG 76-22 ^B | n/a | n/a |

- A. If the mix contains any amount of RAS, the virgin binder shall be PG 58-28.
- B. Maximum Recycled Binder Replacement (%RBR) is 18% for mixes using PG 76-22 binder.

Page 6-20, Table 610-6, PLACEMENT TEMPERATURES FOR ASPHALT, replace with the following:

| TABLE 610-6 PLACEMENT TEMPERATURES FOR ASPHALT | |
|---|--|
| Asphalt Concrete Mix Type | Minimum Surface and Air Temperature |
| B25.0C | 35°F |
| I19.0C | 35°F |
| S4.75A, S9.5B, S9.5C | 40°F ^A |
| S9.5D | 50°F |

- A. For the final layer of surface mixes containing recycled asphalt shingles (RAS), the minimum surface and air temperature shall be 50°F.

Page 6-21, Article 610-8, SPREADING AND FINISHING, lines 34-35, delete the second sentence and replace with the following:

Use an MTV for all surface mix regardless of binder grade on Interstate, US Routes, and NC Routes (primary routes) that have 4 or more lanes and median divided.

Page 6-21, Article 610-8, SPREADING AND FINISHING, lines 36-38, delete the fourth sentence and replace with the following:

Use MTV for all ramps, loops, Y-line that have 4 or more lanes and are median divided, full width acceleration lanes, full width deceleration lanes, and full width turn lanes that are greater than 1000 feet in length.

Page 6-23, Table 610-7, DENSITY REQUIREMENTS, replace with the following:

| TABLE 610-7 DENSITY REQUIREMENTS | |
|---|--|
| Mix Type | Minimum % G_{mm} (Maximum Specific Gravity) |
| S4.75A | 85.0 ^A |
| S9.5B | 90.0 |
| S9.5C, S9.5D, I19.0C, B25.0C | 92.0 |

- A. Compaction to the above specified density will be required when the S4.75A mix is applied at a rate of 100 lbs/sy or higher.

Page 6-24, Article 610-13, FINAL SURFACE TESTING, lines 35-36, delete the second sentence and replace with the following:

Final surface testing is not required on ramps, loops and turn lanes.

Page 6-26, Subarticle 610-13(A)(1), Acceptance for New Construction, lines 29-30, delete the second sentence and replace with the following:

Areas excluded from testing by the profiler may be tested using a 10-foot straightedge in accordance with Article 610-12.

Page 6-27, Subarticle 610-13(B), Option 2- North Carolina Hearne Straightedge, lines 41-46, delete the eighth and ninth sentence of this paragraph and replace with the following:

Take profiles over the entire length of the final surface travel lane pavement exclusive of structures, approach slabs, paved shoulders, tapers, or other irregular shaped areas of pavement, unless otherwise approved by the Engineer. Test in accordance with this provision all mainline travel lanes, full width acceleration or deceleration lanes and collector lanes.

Page 6-28, Subarticle 610-13(B), Option 2- North Carolina Hearne Straightedge, lines 1-2, delete these two lines.

Page 6-32, Article 610-16 MEASUREMENT AND PAYMENT, replace with the following:

| Pay Item | Pay Unit |
|---|-----------------|
| Asphalt Concrete Base Course, Type B25.0C | Ton |
| Asphalt Concrete Intermediate Course, Type I19.0C | Ton |
| Asphalt Concrete Surface Course, Type S4.75A | Ton |
| Asphalt Concrete Surface Course, Type S9.5B | Ton |
| Asphalt Concrete Surface Course, Type S9.5C | Ton |
| Asphalt Concrete Surface Course, Type S9.5D | Ton |

Page 10-30, Table 1012-1, AGGREGATE CONSENSUS PROPERTIES, replace with the following:

**TABLE 1012-1
AGGREGATE CONSENSUS PROPERTIES^A**

| Mix Type | Coarse Aggregate Angularity^B | Fine Aggregate Angularity % Minimum | Sand Equivalent % Minimum | Flat and Elongated 5 : 1 Ratio % Maximum |
|-----------------------|--|--|----------------------------------|---|
| <i>Test Method</i> | <i>ASTM D5821</i> | <i>AASHTO T 304</i> | <i>AASHTO T 176</i> | <i>ASTM D4791</i> |
| S4.75A; S9.5B | 75 / - | 40 | 40 | - |
| S9.5C; I19.0C; B25.0C | 95 / 90 | 45 | 45 | 10 |
| S9.5D | 100 / 100 | 45 | 50 | 10 |
| OGFC | 100 / 100 | 45 | 45 | 10 |
| UBWC | 100 / 85 | 45 | 45 | 10 |

A. Requirements apply to the design aggregate blend.

B. 95 / 90 denotes that 95% of the coarse aggregate has one fractured face and 90% has 2 or more fractured faces.

Page 10-30, Subarticle 1012-1(B)(6), Toughness (Resistance to Abrasion) , line 12, replace “OGAFC” with “OGFC”.

PATCHING EXISTING PAVEMENT:

(1-15-02) (Rev. 8-16-22)

610

SP6 R88R

Description

The Contractor's attention is directed to the fact that there are areas of existing pavement on this project that will require repair prior to resurfacing. Patch the areas that, in the opinion of the Engineer, need repairing. The areas to be patched will be delineated by the Engineer prior to the Contractor performing repairs.

Materials

The patching consists of Asphalt Concrete Base Course, Asphalt Concrete Intermediate Course, Asphalt Concrete Surface Course, or a combination of base, intermediate and surface course.

Construction Methods

Remove existing pavement at locations directed by the Engineer in accordance with Section 250 of the *Standard Specifications*.

Place Asphalt Concrete Base Course, in lifts not exceeding 5.5 inches. Utilize compaction equipment suitable for compacting patches as small as 3.5 feet by 6 feet on each lift. Use an approved compaction pattern to achieve proper compaction. If patched pavement is to be open to traffic for more than 48 hours prior to overlay, use Asphalt Surface Course in the top 1.5 inches of the patch.

Schedule operations so that all areas where pavement has been removed will be repaired on the same day of the pavement removal and all lanes of traffic restored.

Measurement and Payment

Patching Existing Pavement will be measured and paid as the actual number of tons of asphalt plant mix complete in place that has been used to make completed and accepted repairs. The asphalt plant mixed material will be measured by being weighed in trucks on certified platform scales or other certified weighing devices. The above price and payment will be full compensation for all work covered by this provision, including but not limited to removal and disposal of all types of pavement; furnishing and applying tack coat; furnishing, placing, and compacting of asphalt plant mix; and furnishing scales.

Furnishing asphalt binder will be paid as provided in Article 620-4 for Asphalt Binder for Plant Mix for each grade required.

Payment will be made under:

Pay Item
Patching Existing Pavement

Pay Unit
Ton

PORTLAND CEMENT CONCRETE PRODUCTION AND DELIVERY:

(9-15-20)

1000, 1014, 1024

SP10 R01

Revise the 2018 Standard Specifications as follows:

Page 10-6, Table 1000-1, REQUIREMENTS FOR CONCRETE, replace with the following:

| TABLE 1000-1 REQUIREMENTS FOR CONCRETE | | | | | | | | | | | |
|---|---|-----------------------------------|------------|-----------------------------------|-----------|--|------------------------|-----------------------|-------------|---------------------|--------------|
| Class of Concrete | Min. Compressive Strength at 28 days | Maximum Water-Cement Ratio | | | | Consistency Maximum Slump | | Cement Content | | | |
| | | Air-Entrained Concrete | | Non-Air-Entrained Concrete | | Vibrated | Non-Vibrated | Vibrated | | Non-Vibrated | |
| | | | | | | | | | | | |
| | | <i>Units</i> | <i>psi</i> | | | | | <i>inch</i> | <i>inch</i> | <i>lb/cy</i> | <i>lb/cy</i> |
| AA | 4500 | 0.381 | 0.426 | --- | --- | 3.5 ^A | --- | 639 | 715 | --- | --- |
| AA Slip Form | 4500 | 0.381 | 0.426 | --- | --- | 1.5 | --- | 639 | 715 | --- | --- |
| Drilled Pier | 4500 | --- | --- | 0.450 | 0.450 | --- | 5 - 7 dry 7 - 9 wet | --- | --- | 640 | 800 |
| A | 3000 | 0.488 | 0.532 | 0.550 | 0.594 | 3.5 ^A | 4.0 | 564 | --- | 602 | --- |
| B | 2500 | 0.488 | 0.567 | 0.559 | 0.630 | 1.5 machine placed 2.5 ^A hand placed | 4.0 | 508 | --- | 545 | --- |
| Sand Light-weight | 4500 | --- | 0.420 | --- | --- | 4.0 ^A | --- | 715 | --- | --- | --- |
| Latex Modified | 3000 (at 7 days) | 0.400 | 0.400 | --- | --- | 6.0 | --- | 658 | --- | --- | --- |
| Flowable Fill excavatable | 150 max. (at 56 days) | as needed | as needed | as needed | as needed | --- | Flowable | --- | --- | 40 | 100 |
| Flowable Fill non-excavatable | 125 | as needed | as needed | as needed | as needed | --- | Flowable | --- | --- | 100 | as needed |

| | | | | | | | | | | | |
|-------------|---|------------------|------------------|-----|-----|--------------------------------------|-----------|-----------|-----------|-----------|-----------|
| Pavement | 4500 Design, field 650 flexural, design only | 0.559 | 0.559 | --- | --- | 1.5 slip form 3.0 hand placed | --- | 526 | --- | --- | --- |
| Precast | See Table 1077-1 | as needed | as needed | --- | --- | 6.0 | as needed | as needed | as needed | as needed | as needed |
| Prestressed | per contract | See Table 1078-1 | See Table 1078-1 | --- | --- | 8.0 | --- | 564 | as needed | --- | --- |

- A. The slump may be increased to 6 inches, provided the increase in slump is achieved by adding a chemical admixture conforming to Section 1024-3. In no case shall the water-cement ratio on the approved design be exceeded. Concrete exhibiting segregation and/or excessive bleeding will be rejected. Utilizing an Admixture to modify slump does not relinquish the contractor’s responsibility to ensure the final product quality and overall configuration meets design specifications. Caution should be taken when placing these modified mixes on steep grades to prevent unintended changes to the set slope.

THERMOPLASTIC INTERMIXED BEAD TESTING:

7-19-22

1087

SP10 R04

Revise the *2018 Standard Specifications* as follows:

Page 10-183, Subarticle 1087-7(B) Thermoplastic Pavement Marking Material Composition, delete line 34 and 35.

Page 10-184, Article 1087-8 MATERIAL CERTIFICATION, delete and replace with the following after line 34:

| | |
|----------------------|---|
| Drop-on Glass Beads | Type 3 Material Certification and Type 4 Material Certification |
| Intermix Glass Beads | Type 2 Material Certification and Type 3 Material Certification |
| Paint | Type 3 Material Certification |
| Removable Tape | Type 3 Material Certification |
| Thermoplastic | Type 3 Material Certification and Type 4 Material Certification |
| Cold Applied Plastic | Type 2 Material Certification and Type 3 Material Certification |
| Polyurea | Type 2 Material Certification and Type 3 Material Certification |

THERMOPLASTIC PAVEMENT MARKING MATERIAL – COLOR TESTING:

3-19-19

1087

SP10 R05

Revise the *2018 Standard Specifications* as follows:

Pages 10-183 and 10-184, Subarticle 1087-7(D)(1)(b) Yellow, lines 9-11, delete and replace with the following:

Obtain Color Values Y,x,y per ASTM E1349 using C/2° illuminant/observer.
Results shall be $Y \geq 45\%$, and x,y shall fall within PR#1 chart chromaticity limits.

MATERIALS FOR PORTLAND CEMENT CONCRETE:

(9-15-20)

1000, 1024

SP10 R24

Revise the *2018 Standard Specifications* as follows:

Page 10-52, Article 1024-4, WATER, lines 3-6, delete and replace with the following:

Test water from wells at all locations. Test public water supplies from all out of state locations and in the following counties: Beaufort, Bertie, Brunswick, Camden, Carteret, Chowan, Craven, Currituck, Dare, Gates, Hyde, New Hanover, Onslow, Pamlico, Pasquotank, Pender, Perquimans, Tyrell and Washington unless the Engineer waives the testing requirements.

Page 10-52, Table 1024-2, PHYSICAL PROPERTIES OF WATER, replace with the following:

| Property | Requirement | Test Method |
|--|---|--------------|
| Compression Strength, minimum percent of control at 3 and 7 days | 90% | ASTM C1602 |
| Time of set, deviation from control | From 1:00 hr. earlier to 1:30 hr. later | ASTM C1602 |
| pH | 4.5 to 8.5 | ASTM D1293 * |
| Chloride Ion Content, Max. | 250 ppm | ASTM D512 * |
| Total Solids Content (Residue), Max. | 1,000 ppm | SM 2540B * |
| Resistivity, Min. | 0.500 kohm-cm | ASTM D1125 * |

*Denotes an alternate method is acceptable. Test method used shall be referenced in the test report.

MATERIAL AND EQUIPMENT STORAGE & PARKING OF PERSONAL VEHICLES:

11-17-21(Rev. 8-16-22)

1101

SP11 R03

Revise the *2018 Standard Specifications* as follows:

Page 11-2, Article 1101-8 MATERIAL AND EQUIPMENT STORAGE, line 35-38, delete and replace with the following:

When work is not in progress, keep all personnel, equipment, machinery, tools, construction debris, materials and supplies away from active travel lanes that meets Table 1101-1.

| TABLE 1101-1 MATERIAL AND EQUIPMENT STORAGE FROM ACTIVE TRAVEL LANES | |
|---|---------------|
| Posted Speed Limit (mph) | Distance (ft) |
| 40 or less | ≥ 18 |
| 45-50 | ≥ 28 |
| 55 | ≥ 32 |
| 60 or higher | ≥ 40 |

When vehicles, equipment and materials are protected by concrete barrier or guardrail, they shall be offset at least 5 feet from the barrier or guardrail.

Page 11-2, Article 1101-9 PARKING OF PERSONAL VEHICLES, line 40-41, delete and replace with the following:

Provide staging areas for personal vehicle parking in accordance with Article 1101-8 or as directed by the Engineer before use.

WORK ZONE INSTALLER:

(7-20-21)(Rev. 8-16-22)

1101, 1150

SP11 R04

Provide the service of at least one qualified work zone installer during the setup, installation, and removal of temporary traffic control within the highway right of way. The qualified work zone installer shall serve as crew leader and shall be on site and directing the installation and removal of temporary traffic control. If multiple temporary traffic control installations or removals are occurring simultaneously, then each shall have a qualified work zone installer.

The work zone installer shall be qualified by an NCDOT approved training agency or other NCDOT approved training provider in the safe and competent set up of temporary traffic control. For a complete listing of approved training agencies, see the Work Zone Safety Training webpage.

A work zone supervisor, in accordance with Article 1101-13 of the *Standard Specifications*, may fulfill the role of the work zone installer during the setup, installation, and removal of temporary traffic control within the highway right of way provided they are on site and directing the installation and removal of temporary traffic control.

All other individuals participating in the setup, installation, and removal of temporary traffic control within the highway right of way shall be certified as a qualified flagger in accordance with Article 1150-3 of the *Standard Specifications*, even if flagging is not being performed as part of the traffic control.

Provide the name and contact information of all qualified work zone installers to the Engineer prior to or at the preconstruction conference. Additionally, provide a qualification statement that all other individuals participating in the setup, installation, and removal of temporary traffic control are qualified flaggers that have been properly trained through an NCDOT approved training agency or other NCDOT approved training provider.

All certification records for qualified work zone installers and flaggers shall be uploaded by the approved training agency or other NCDOT approved training provider to the Department’s Work Zone Education Verification App (WZ-EVA) prior to the qualified work zone installer or flagger performing any traffic control duties on the project. For more information about WZ-EVA, see the Work Zone Safety Training webpage.

EXTRUDED THERMOPLASTIC PAVEMENT MARKING THICKNESS:

3-19-19 (Rev. 6-21-22)

1205

SP12 R05

Revise the *2018 Standard Specifications* as follows:

Page 12-6, Subarticle 1205-4(A)(1) General, lines 5-8, delete the second sentence and replace with the following:

Use application equipment that provides multiple width settings ranging from 4 inches to 12 inches and multiple thickness settings to achieve the required thickness above the surface of the pavement as shown in Table 1205-3.

Page 12-7, Table 1205-3, THICKNESS REQUIREMENTS FOR THERMOPLASTIC, replace with the following:

| TABLE 1205-3 MINIMUM THICKNESS REQUIREMENTS FOR THERMOPLASTIC | |
|--|---|
| Thickness | Location |
| 240 mils | In-lane and shoulder-transverse pavement markings (rumble strips). May be placed in 2 passes. |
| 90 mils | Center lines, skip lines, transverse bands, mini-skip lines, characters, bike lane symbols, crosswalk lines, edge lines, gore lines, diagonals, and arrow symbols |



DocuSigned by:

Matthew V. Springer, PE

BC60F6E8B584403...
04/05/2022

HOT SPRAY THERMOPLASTIC PAVEMENT MARKING LINES:

(12-01-20) Rev. 04/05/22

Description

This special provision covers machine applied “hot spray” thermoplastic pavement marking material with both incorporated reflective media.

General, Color, Packing for Shipment, Storage, Materials, Construction Methods, Maintenance, Method of Measurement, and Basis of Payment shall be as described in Section 1087 and Section 1205 of the *Standard Specifications*, with the exceptions as shown below:

Revise the *2018 Standard Specifications* as follows:

Page 10-182, Subarticle 1087-4(C) Gradation & Roundness, lines 15-17, replace this subarticle with the following:

The reflective media used in all pavement marking shall be used according to the manufacturer’s recommendations in order to meet the retroreflectivity requirements as stated in Subarticles 1205-4(C) and 1205-4(D) as measured by any Department approved 30-meter geometry retroreflectivity device.

The reflective media shall be capable of flowing freely through dispensing equipment in any weather suitable for marking the pavement.

Page 12-1, Subarticle 1205-2(B) Material Qualification, line 9, add the following:

All “hot spray” thermoplastic manufacturers must be prequalified. In order to be prequalified, all “hot spray” Thermoplastic Pavement Marking manufacturers must have their material installed on the NTPEP test deck.

Page 12-6, Subarticle 1205-4(A) Application Equipment, delete lines 28-30, add the following:

Handliners shall not be allowed.

Use application equipment that provides multiple width settings ranging from 4” to 12” and multiple thickness settings to achieve a minimum 50 mil thickness in one pass.

Page 12-7, Subarticle 1205-4(C) Application, lines 2-5, delete the first paragraph and replace with the following:

All thermoplastic markings shall be of the hot, machine applied type. Application shall be accomplished by spraying methods only.

Page 12-7, Subarticle 1205-4(C) Application, lines 30-31, delete the last paragraph and replace with the following:

Produce a cross-sectional thickness of hot spray thermoplastic markings for long line markings only with a minimum thickness of 50 mils without reflective media or a minimum thickness of 55 mils with reflective media.

Extruded type thermoplastic shall not be sprayed.

The cross-sectional thickness of all “hot sprayed” thermoplastic markings above the surface of the existing pavement shall be no more than 60 mils.

The manufacturer of that material shall certify that the Contractor is trained to place the material. At least one member of each crew working on this project shall have completed this training. The Contractor shall furnish the Engineer written confirmation of this training from the material manufacturer prior to beginning the work.

If the hot sprayed thermoplastic is to be placed over milled-in rumble strips, the Contractor shall ensure that all debris is removed after milling and the surface is thoroughly cleaned to ensure optimum adhesion between the surface and the hot sprayed thermoplastic.

Page 12-12, Article 1205-10 Measurement and Payment, replace this article with the following:

Hot Spray Thermoplastic Pavement Marking Line, __ (width), __ (thickness) will be measured and paid as the actual number of linear feet of pavement marking lines satisfactorily placed and accepted by the Engineer. The quantity of solid lines will be the summation of the linear feet of solid line measured end-to-end of the line. The quantity of skip or broken lines will be the summation of the linear feet derived by multiplying the nominal length of a line by the number of marking lines satisfactorily placed. Such prices and payment will be full compensation for all work covered by this section including, but not limited to, furnishing, surface preparation, reapplication of molten pavement marking crossed by a vehicle, and removal of all pavement marking materials spilled on the roadway surface.

Payment will be made under:

| Pay Item | Pay Unit |
|--|-----------------|
| Hot Spray Thermoplastic Pavement Marking Lines, __, __ | Linear Foot |

TC-1

2023CPT.04.21.20641

NASH COUNTY

WORK ZONE TRAFFIC CONTROL GENERAL REQUIREMENTS

TEMPORARY TRAFFIC CONTROL (TTC):

(7-16-13) (Rev. 12-08-20) (Rev. 02-18-21)

RWZ-1

Maintain traffic in accordance with Divisions 10, 11 and 12 of the *2018 Standard Specifications* and the following provisions:

Install Work Zone Advance Warning Signs in accordance with the detail drawing provided in these plans prior to beginning any other work. Use a lane closure or slow moving operation to complete the work, as necessary, unless otherwise indicated. Refer to Standard Drawing No. 1101.02, 1101.11, 1110.01, 1110.02, 1130.01, 1135.01 and 1180.01 of the *2018 Roadway Standard Drawings*. Use a moving operation only if the minimum speed maintained at all times is 3 mph with no stops that narrow or close a lane of travel. If the moving operation is progressing slower than 3 mph at any time, install a lane closure. Maintain the existing traffic pattern at all times, except in the immediate work zone where lane closures are allowed as determined by the Engineer. If applicable, maintain existing pedestrian facilities in accordance with *Pedestrian Accommodation at Curb Ramp Work Locations*, found elsewhere in this Contract.

Refer to attached details and Standard Drawing No. 1101.02, 1101.03, 1101.04, 1101.05, 1101.11, 1110.01, 1110.02, 1115.01, 1130.01, 1135.01, 1145.01, 1150.01, 1165.01, and 1180.01 of the *2018 Roadway Standard Drawings* when closing a lane of travel in a stationary work zone such as pavement patching, resurfacing, curb ramp work, or pavement marking removal. Properly ballasted cones and skinny drums may be used instead of drums. However, drums are required for the upstream taper portion of lane closures in all applications. The stationary work zone shall be a maximum of 1 mile in length at any given time on 2 Lane, 2 Way facilities unless otherwise approved by the Engineer. A pilot vehicle operation may be used in conjunction with flaggers and the appropriate pilot vehicle warning signing as directed by the Engineer. During periods of construction inactivity, return the traffic pattern to the existing alignment and remove or cover any work zone signs. When covering work zone signs, use an opaque material that prevents reading of the sign at night by a driver using high beam headlights. Use material, which does not damage the sign sheeting. Replace any obliterated markings as required by other sections of the *2018 Standard Specifications* and the Engineer.

When personnel and/or equipment are working on the shoulder adjacent to and within 5 feet of an open travel lane, close the nearest open travel lane using Standard Drawing No. 1101.02 of the *2018 Roadway Standard Drawings*. When personnel and/or equipment are working within a lane of travel of an undivided facility, close the lane according to the traffic control plans, *2018 Roadway Standard Drawings* or as directed by the Engineer. Conduct the work so that all personnel and/or equipment remain within the closed travel lane. Do not work simultaneously, on

TC-2

2023CPT.04.21.20641

NASH COUNTY

both sides of an open travel way, within the same location, on a two-lane, two-way road. Perform work only when weather and visibility conditions allow safe operations as directed by the Engineer.

When utilizing a slow-moving operation for such items as pavement marking and marker placement, the operation shall consist of the vehicles and devices as shown on Roadway Standard Drawing No. 1101.02, sheet 11 or 12 of the *2018 Roadway Standard Drawings*. Traffic cones may be used when necessary to provide additional protection of wet pavement markings. Ballast all traffic cones so they will not be blown over by traffic.

PAVING OPERATIONS:

1) Paving Lift Requirements and Time Limitations:

For paving lifts of 2.0 inches or less, bring all newly resurfaced lanes to the same station and elevation within 72 hours. If not brought up to the same station and elevation within 72 hours, the Contractor shall place portable “UNEVEN PAVEMENT” signs in advance of the uneven pavement and spaced every 1/2 mile along the section of uneven pavement. Once mitigated, all portable “UNEVEN PAVEMENT” signs shall be removed. No additional compensation will be made for these signs or any other type of portable warning signs as these are included in the “Temporary Traffic Control” contract pay item.

For paving lifts greater than 2 inches, bring all newly resurfaced lanes to the same station and elevation by the end of each work day unless the Contractor utilizes the notched wedge paving methods as described below.

Failure to comply with the following requirements will result in a suspension of all other operations until all lanes of traffic are brought to the same station and elevation:

1. During paving operations, any paving lift greater than 2 inches for asphalt surface course mixes shall be mitigated by having an approved wedge apparatus on the paver that shapes the edge 1 inch vertically and the remaining at a maximum slope steepness of 2:1. For intermediate and base course mixes, use an approved wedge device that shapes the edge with a maximum slope steepness of 2:1. The maximum paving lift allowed to use this method is 3 inches.
2. At the end of the work day, the Contractor shall place portable “UNEVEN PAVEMENT” signs in advance of the uneven pavement and spaced every 1/2 mile along the section of uneven pavement. Once mitigated, all portable “UNEVEN PAVEMENT” signs shall be removed. No additional compensation will be made for these signs or any other type of

TC-3

2023CPT.04.21.20641

NASH COUNTY

portable warning signs as these are included in the “Temporary Traffic Control” contract pay item.

3. In the next day’s paving operation and not to exceed 72 hours, the Contractor shall bring up the adjacent lane to the same station and elevation before any further paving takes place on the project.

2) Asphalt Surface Treatments (AST)

For AST Operations, there is no drop-off condition to be signed. Stationary “LOOSE GRAVEL” and “UNMARKED PAVEMENT” signs shall replace “LOW/SOFT SHOULDER” signs. For placement and spacing of these signs, see the Signing Detail Sheet. All other advance warning signs are to be portable mounted. These signs are included as part of the temporary traffic control (Lump Sum) item.

3) Fine Milling/Microsurfacing (Depths less than 1”)

For fine milling operations less than 1”, paving is not required in the same work period. The paving of the fine milled area is to be conducted within the next work period and not to exceed 72 hours. No advance warning signs are necessary for these conditions unless the paving operations exceed 72 hours. If this occurs, install portable “UNMARKED PAVEMENT” signs. These signs are incidental to the other items of work included in the temporary traffic control (Lump Sum) item.

4) Shoulder Drop-Off Requirements

Whenever paving operations create an edge of pavement drop-off greater than 2 inches, within 72 hours, the Contractor shall backfill at a 6:1 slope from the edge and finished elevation of the pavement that has an edge of pavement drop-off as follows:

- (A) Drop-off that exceeds 2 inches on roadways with posted speed limits of 45 mph or greater.
- (B) Drop-off that exceeds 3 inches on roadways with posted speed limits less than 45 mph.

Backfill the edge of pavement drop-off with suitable compacted material, as approved by the Engineer. The material, equipment and labor associated with this operation will be at no expense to the Department. This work is not considered part of shoulder reconstruction.

PROJECT REQUIREMENTS:

Failure to comply with the following requirements will result in a suspension of all other operations:

TC-4

2023CPT.04.21.20641

NASH COUNTY

1. Before working on ANY MAP, the Contractor shall submit a written construction sequence for traffic control and construction lighting for ALL MAPS to the Engineer at the first pre- construction meeting and the sequence must be approved before closing a lane of traffic. If applicable, the Contractor shall also submit a description of how pedestrian access will be maintained during any curb ramp work. Refer to *Pedestrian Accommodation at Curb Ramp Work Locations*, found elsewhere in this Contract, for pedestrian maintenance requirements.
2. The temporary use of portable concrete barrier and the need for any long-term temporary traffic patterns are not anticipated and are not covered by this provision. If the Engineer determines there is a need, then coordinate with the Work Zone Traffic Control Section at 919-814-5000.
3. Obtain written approval of the Engineer before working in more than one location or setting up additional lane closures. The maximum length of any one lane closure is 1 mile unless otherwise directed by the Engineer.
4. If Lane Closure Restrictions apply, see Special Provision, “Intermediate Contract Times and Liquidated Damages”.
5. Contractor shall mill and pave lanes in an order such that water shall not accumulate.
6. Traffic Control for the milling and/or paving of ramps is to be done according to Standard Drawing Number 1101.02, Sheets 9 & 10 unless otherwise approved to be closed by the Engineer. If approved, Contractor will provide plans and devices for the detour at no additional cost to the department.
7. If milled areas are not paved back within 72 hours, the Contractor is to furnish and install portable signs to warn drivers of the conditions. These are to include, but not limited to “Rough Road” (W8-8), “Uneven Lanes” (W8-11), and “Grooved Pavement” (W8-15) w/ Motorcycle Plaque mounted below. These are to be dual indicated on Multi-Lane Roadways with speed limits 45 mph and greater where lateral clearance can be obtained within the median areas. These portable signs are incidental to the other items of work included in the temporary traffic control (Lump Sum) pay item.

WORK ZONE SIGNING:**Description**

Install advance/general warning work zone signs according to the Detail Drawing provided in these plans prior to beginning of work. Install and maintain signing in accordance with the attached drawings and Divisions 11 and 12 of the *2018 Standard Specifications*.

(A) Installation

All stationary Advance/General warning work zone signs require notification to existing Utility owners per Article 105-8 of the *2018 Standard Specifications* and Special Provision SP1 G115 within 3 to 12 full working days prior to installation.

Install Advance/General warning work zone signs before beginning work on a particular map. If signs are installed more than 7 calendar days prior to the beginning of work on a particular map, cover the signs until the work begins. Install each work zone Advance/General warning sign separately and not on the same post or stand with any other sign except where an advisory speed plate or directional arrow is used.

All stationary signing is to be installed as shown on the detail drawing(s) unless otherwise directed by the Engineer. The signs as shown on the detail drawing(s) are all that are required for a contractor to begin a resurfacing contract. Any additional signs requested by the Engineer shall be installed within 7 business days of the start of contract work. All sign locations are to be verified by the Engineer prior to installation. Once the signs have been installed and accepted, any sign relocations requested by the Department will be compensated in accordance with Article 104-7. Any additional signs other than the ones shown in the drawing will be compensated in accordance with Article 104-7.

No stationary -Y- Line advance warning signage is required unless there is more than 1,000 feet of resurfacing along the -Y- line. Whenever work proceeds through an intersection, portable signs shall be used for traffic control. There will be no direct compensation for any portable signing.

If there is a period of construction inactivity longer than 14 calendar days, remove or cover advance/general warning work zone signs. Uncover advance/general warning work zone signs no more than 7 calendar days before work resumes. All other operations may be suspended upon failure to comply with the above requirements. Such suspended operations would not be resumed until the above requirements are fulfilled.

TC-6

2023CPT.04.21.20641

NASH COUNTY

(B) Sign Removal

Once Maps on the Project are substantially complete, it is acceptable practice to remove the Stationary Work Zone Signs in lieu of waiting until all of the Maps are completed on the Project. A Map is substantially complete when the resurfacing operations are finished and the shoulders are brought up to the same elevation as the proposed pavement and when pavement markings (paint) are installed along the centerline and edge lines. The final pavement markings (ex. Thermoplastic/Polyurea) or pavement markers (Raised/Snowplowable) do not have to be installed for Maps to be considered substantially complete. Final pavement marking/markers are installed with portable signing according to Roadway Standard Drawing 1101.02, sheet 11 or 12. Any remaining punch list items requiring traffic control are compensated in the contract pay item for *Temporary Traffic Control*.

Stationary Work Zone Sign removal is a condition of final project acceptance.

(C) Lane Closure Work Zone Signs

Install any required lane closure signing needed during the life of the project in accordance with the Standard Drawing No. 1101.02, 1101.11 and 1110.02 of the *2018 Roadway Standard Drawings*. Any required portable signs for lane closures are compensated in the contract pay item for *Temporary Traffic Control*.

MEASUREMENT AND PAYMENT:

Temporary traffic control work, including, but not limited to installation and removal of portable signs, cones, drums, skinny drums, flaggers, AFAD's, changeable message boards, truck mounted attenuators, flashing arrow boards, and pilot vehicles for the sole purpose of maintaining vehicular traffic will be paid at the contract lump sum price for *Temporary Traffic Control*.

The *Temporary Traffic Control* pay item does not include work zone advance or general warning signs.

The *Temporary Traffic Control* pay item does not include Pedestrian Channelizing Devices and applicable signs, Audible Warning Devices, Temporary Curb Ramps, or a Pedestrian Transport Service required for the sole purpose of maintaining pedestrian movements. Refer to *Pedestrian Accommodation at Curb Ramp Work Locations*, found elsewhere in this Contract, for measurement and payment information for these items.

Partial payments for *Temporary Traffic Control* will be made as follows: The cumulative total of the lump sum price for temporary traffic control will be equal to the percent complete (project) as

TC-7

2023CPT.04.21.20641

NASH COUNTY

calculated for each partial pay estimate. Additional flashing arrow boards and message boards beyond those shown in the contract, detail drawings or *Roadway Standard Drawings* required by the Engineer will be paid as extra work in accordance with Article 104-7 of the *Standard Specifications*.

The work of satisfactorily installing and removing work zone advance and/or general warning signs, including, but not limited to, furnishing, locating, installing, covering, uncovering and removing stationary signs will be measured for each required sign and paid at the contract price for *Work Zone Advance/General Warning Signing (SF)*. Payment for *Work Zone Advance/General Warning Signing* will be limited to a maximum of 90% of the total installed quantity. The remaining 10% will be paid once all signs have been removed.

The Lump Sum price for *Temporary Traffic Control* will include the work of 4 flaggers per operation per map being utilized at the same time on any day. If a pilot vehicle is used for an operation, the Lump Sum Price for *Temporary Traffic Control* will include the work of five (5) flaggers. The operator of a pilot vehicle will be considered one of the five flaggers.

Any additional flagging beyond the “included” amount covered in the *Temporary Traffic Control* pay item will be considered supplemental flagging and compensated at a rate of \$35.00 per hour for each additional flagger as approved by the Engineer.

Payment will be made under:

| Pay Item | Pay Unit |
|---|-----------------|
| Temporary Traffic Control | Lump Sum |
| Work Zone Advance/General Warning Signing | Square Foot |

TC-8

2023CPT.04.21.20641

NASH COUNTY

RESURFACING OPERATIONS:

(7-15-14)

RWZ-2

Coordinate the installation of items required by the contract documents and resurfacing operations such that these operations are completed in the order as agreed upon with the Engineer at the first pre-construction meeting. Refer to the Provisions, Typicals and Details unless otherwise directed by the Engineer.

Notify the Engineer 15 consecutive calendar days before resurfacing a bridge or its approaches. Patch and make repairs to bridge surface and its approaches before resurfacing occurs. Coordinate all operations on the bridge and its approaches with the Engineer.

Notify the Engineer 48 hours before resurfacing the areas of existing pavement that require patching. Patch these areas before resurfacing occurs. Allow full depth asphalt patching to cool to the point of supporting traffic without displacement or rutting before reopening closed lane. Coordinate the resurfacing operations of the patched areas with the Engineer.

Notify the Engineer 48 hours before milling or resurfacing will interfere with the existing Signal Loops. Loops may need to be placed in milled surface before resurfacing occurs. Coordinate all signal loop operations with the Engineer.

For partial or wheel track milling operations on two-way, two-lane facilities, mill and pave back by the end of each work day. For Partial or wheel track milling operation on multi-lane facilities, the lane being milled may be left closed and paved back within 72 hours.

The following options are available during Resurfacing and milling operations on two-way, two-lane facilities when the entire roadway or entire lane is to be milled:

- (A) Mill a single lane and pave back by the end of each work day.
- (B) Mill the entire width of roadway and pave back within 72 hours.

The following options are available during Resurfacing and milling operations on multi-lane facilities when all lanes or a single lane in one direction are to be milled:

- (A) Mill a single lane and pave back by the end of each work day.
- (B) Mill the entire width of pavement for all lanes to be milled in any direction daily and pave back within 72 hours.

Slope the pavement at the beginning and ending of the daily milling operation as directed by the Engineer. Sweep and remove all milled material from the roadway as soon as the daily milling operation is completed. Continue milling operations until the particular section of roadway being milled is complete. Remove any existing pavement adjacent to the milled area that has been damaged and replace with patch material as directed by the Engineer.

TC-9

2023CPT.04.21.20641

NASH COUNTY

Operate equipment and conduct operations in the same direction as the flow of traffic. Maintain vehicular access in accordance with Article 1101-05 of the *2018 Standard Specifications* using suitable backfill material approved by the Engineer.

Provide appropriate lighting in accordance with Section 1413 of the *2018 Standard Specifications*.

Milled Rumble Strips:

When utilized, milled rumble strips shall be installed in accordance with the *2018 Standard Specifications* and the 2018 Roadway Standard Drawing 665.01.

TC-10

2023CPT.04.21.20641

NASH COUNTY

PAVEMENT MARKINGS AND MARKERS:

(7-15-14)

RWZ-3

Markings: All Facilities

Pavement markings shall be installed in accordance with Standard Drawings 1205.01 through 1205.15 of the *2018 Roadway Standard Drawings* and Section 1205 of the *2018 Standard Specifications* with the exception of the following changes underlined in Table 1205-1 in Subarticle 1205-3(D):

(D) Time Limitations for Replacement

| TABLE 1205-1 TIME LIMITATIONS FOR REPLACEMENT | | |
|---|--|---|
| Facility Type | Marking Type | Replacement Deadline |
| Full-control-of-access multi-lane roadway (4 or more total lanes) and ramps, including Interstates | All markings | By the end of each workday's operation if the lane is opened to traffic |
| Multi-lane roadways (3 or more lanes) and ramps | Center Line, Lane Line, Railroad symbols, Stop bars, school symbols and <u>crosswalk markings</u> | By the end of each workday's operation if the lane is opened to traffic (temporary paint with beads may be used) |
| | Edge Lines, gore lines and all other symbols | By the end of the 3rd calendar day after obliteration |
| Two-lane, two-way roadways | All centerline markings, railroad, Stop bars, school symbols and <u>crosswalk markings</u> | By the end of the 5th calendar day after obliteration |
| | Edge Lines and all other symbols | By the end of the <u>30th</u> calendar day after obliteration |

Prior to placing pavement marking material on concrete surfaces that are diamond ground, use an acceptable method to grind ridges smooth only where pavement marking will be installed.

TC-11

2023CPT.04.21.20641

NASH COUNTY

Type 3 Cold Applied Plastic may be used in lieu of Type 2 Cold Applied Plastic. If Type 3 Cold Applied Plastic is used, it shall be paid for using the Type 2 Cold Applied Plastic pay item.

Unless otherwise specified, Heated-in-Place Thermoplastic may be used in lieu of Extruded Thermoplastic for stop bars, symbols, characters and diagonals. If Heated-in-Place Thermoplastic is used, it shall be paid for using the Extruded Thermoplastic pay item.

Unless otherwise specified, Heated-in-Place Thermoplastic may be used in lieu of Cold Applied Plastic for stop bars, symbols, characters and diagonals on asphalt or concrete roadways. If Heated-in-Place Thermoplastic is used, it shall be paid for using the Cold Applied Plastic pay item.

Markers: All Facilities

Remove existing pavement markers in preparation for paving. Repair any pavement damage due to existing pavement marker removal prior to the end of the work day. Dispose of existing pavement markers as directed by the Engineer. No direct payment will be made for this work as it will be incidental to the paving operation.

Install permanent pavement markers within 60 calendar days after completing the resurfacing on each map. Pavement markers shall be installed in accordance with Standard Drawing 1205.12 and Standard Drawings 1250.01 through 1253.01 of the *2018 Roadway Standard Drawings* and Sections 1250 through 1253 of the *2018 Standard Specifications*.

Markings and Markers: All Facilities

Review and record the existing pavement markings and markers before resurfacing. Re-establish the new pavement markings and markers using the record of existing markings in conjunction with the *2018 Roadway Standard Drawings*. Unless otherwise directed by the engineer, new pavement markings not meeting the current standards should be updated to the *2018 Roadway Standard Drawings*. Have existing or proposed "passing zones" reviewed by the engineer before installation. Submit the record of the existing pavement markings seven calendar days before the obliteration of any pavement markings.

Mainline pavement shall not be left milled, unmarked or uneven at the end of a paving season. If the Contractor begins any map and does not complete within the seasonal restrictions, including placement of final pavement markings or permanent markers, the Contractor shall be responsible for, at his expense, Paint in accordance with Article 1205-08 and Temporary Markers in accordance with Section 1251 of the *2018 Standard Specifications*.

SIGNING FOR RESURFACING PROJECTS

LEGEND
 ┆ STATIONARY SIGN
 ← DIRECTION OF TRAFFIC FLOW

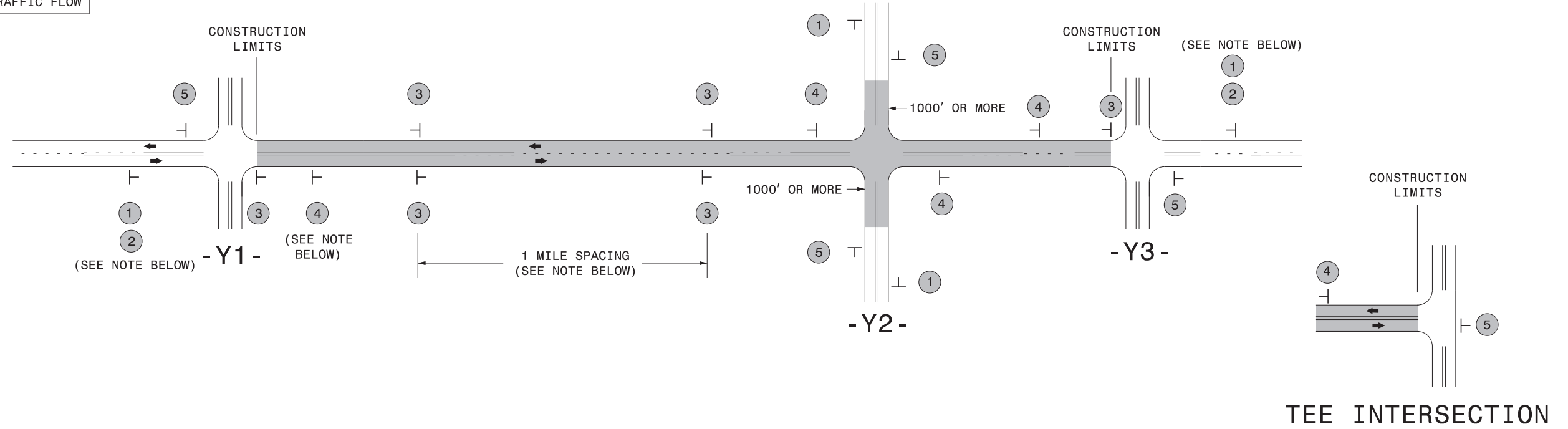

MAINLINE (-L-) SIGNING

-Y- LINE SIGNING

| | | | | |
|---|---|--|---|--|
| SIGNING NOTES AND PLACEMENT PER DIRECTION | 1 | | PLACE 1000' PRIOR TO BEGINNING OF CONSTRUCTION LIMITS. ONLY USED ON -Y- LINES IF RESURFACING LIMITS EXTEND 1000' ALONG -Y- LINE. | <p>NO REQUIRED STATIONARY SIGNING FOR THE FOLLOWING -Y- LINE CONDITIONS:</p> <ol style="list-style-type: none"> LESS THAN 1000' OF RESURFACING ALONG -Y- LINE SUBDIVISION ROADS DEAD END ROADS <p>WHEN PAVING/CONSTRUCTION ACTIVITIES PROCEED ACROSS AN UNSIGNED -Y- LINE, PORTABLE ADVANCE WARNING SIGNS SHALL BE USED ALONG THE -Y- LINE AS SHOWN BELOW. REMOVE UPON COMPLETION OF WORK.</p> <div style="display: flex; justify-content: space-around;"> <div style="text-align: center;"> PLACED 500' IN ADVANCE </div> <div style="text-align: center;"> PLACED 250' IN ADVANCE OF FLAGGER. </div> </div> |
| | 2 | | #2 SIGN ONLY USED WHEN CONSTRUCTION LIMITS ARE 2 OR MORE MILES IN LENGTH. ROUND UP TO NEXT WHOLE NUMBER. (NO FRACTIONAL OR DECIMAL NUMBERS) | |
| | 3 | | <ul style="list-style-type: none"> PLACE INITIALLY AT THE CONSTRUCTION LIMITS AND SPACE 1 MILE APART THEREAFTER. AT TEE INTERSECTIONS INSTALL INITIALLY 1/2 MILE FROM INTERSECTION AND SPACE 1 MILE APART THEREAFTER. | |
| | 4 | | <ul style="list-style-type: none"> THESE ARE FOR -Y- LINES THAT ARE "THROUGH" ROADWAYS. DEAD END AND SUBDIVISION ROADS ARE NOT "THROUGH" ROADWAYS. INSTALL 500' +/- FROM EACH -Y- LINE APPROACH AS SHOWN ABOVE. FOR MULTIPLE -Y- LINES THAT ARE SEPARATED BY 0.25 MILES OR LESS, TREAT AS A SINGLE UNIT AND INSTALL WITHIN 500' OF EACH APPROACH. A MAXIMUM OF 2 SIGN SETS PER MILE. DO NOT INSTALL WHEN -Y- LINES ARE WITHIN 0.5 MILES FROM "END ROAD WORK" SIGN. FOR TEE INTERSECTIONS, INSTALL WITHIN 500' +/- OF THE INTERSECTION ALONG -L- LINE. | |
| | 5 | | PLACE 500' FOLLOWING THE END OF CONSTRUCTION LIMITS OR AS SHOWN WHEN WORK ENDS AT A 3-WAY TEE INTERSECTION. | |

THE ABOVE SIGNS ARE ALL THAT ARE REQUIRED FOR A CONTRACTOR TO BEGIN A RESURFACING CONTRACT. ANY ADDITIONAL SIGNS REQUESTED BY NCDOT DIVISIONS SHALL BE INSTALLED WITHIN 7 BUSINESS DAYS OF THE START OF CONTRACT WORK.

MAPS LESS THAN 2 MILES

FOR RESURFACING MAPS WITH CONSTRUCTION LIMITS LESS THAN 2 MILES IN LENGTH, NO STATIONARY SIGNS ARE REQUIRED. USE PORTABLE "ROAD UNDER CONSTRUCTION" OR "ROAD WORK AHEAD" SIGNS IN LIEU OF STATIONARY ADVANCE WARNINGS SIGNS.

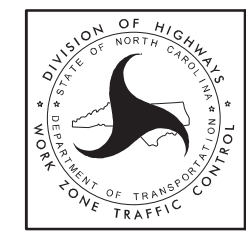

ADVANCE WARNING SIGNS FOR RURAL AND SUBURBAN 2-LANE ROADWAY RESURFACING

URBAN / SUBURBAN WORKZONES

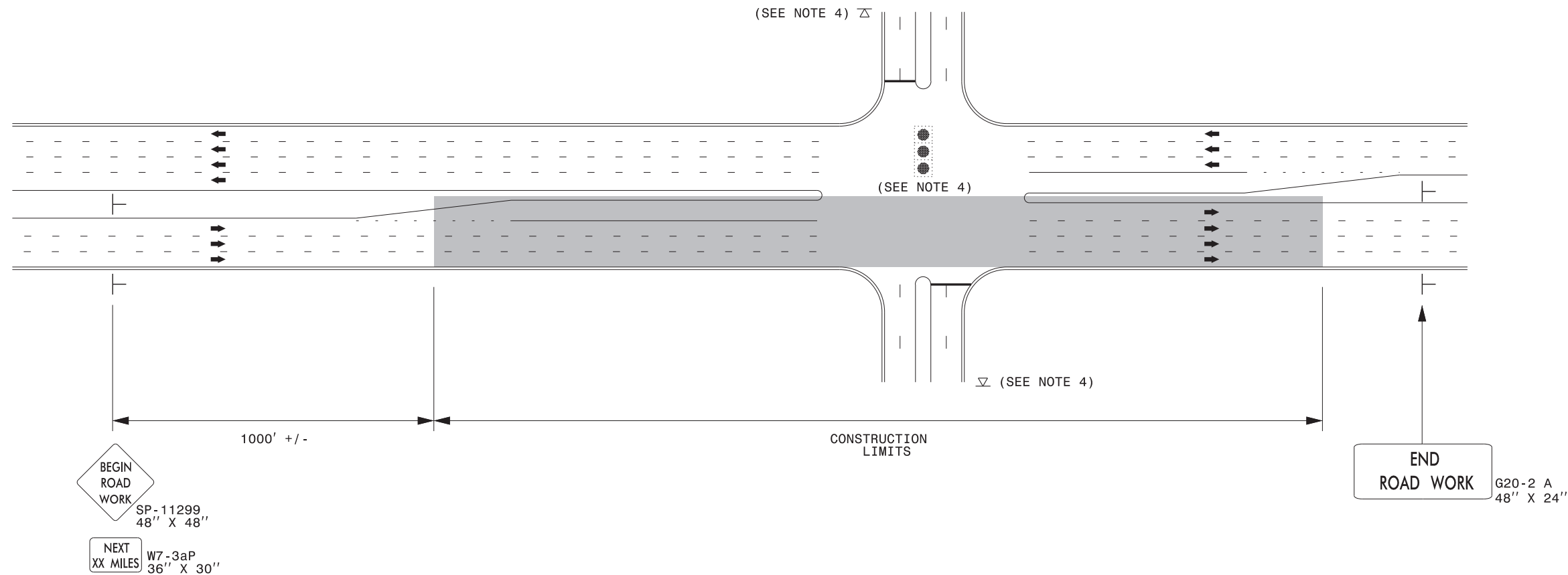

NOTES:

- 1) 48" x 48" SIZED SIGNS (SP- 11299) MAY BE REDUCED TO 36" X 36" ON ROADWAYS WITH SPEED LIMITS OF 40 MPH OR LESS.
- 2) MOUNT SIGNS THAT ARE LARGER THAN 10 SQUARE FEET IN AREA ON TWO OR MORE WOOD OR U-CHANNEL SUPPORTS. PERFORATED SQUARE TUBING SUPPORT SYSTEMS MAY SUPPORT LARGER AREAS ON A SINGLE SUPPORT. FOLLOW MANUFACTURER'S RECOMMENDATIONS. THESE SYSTEMS SHALL BE NCHRP 350 COMPLIANT AND NCDOT APPROVED.
- 3) ADVANCE WARNING SIGNS NOT REQUIRED ON NON-SIGNALIZED SIDE STREETS.
- 4) MAY USE LAW ENFORCEMENT TO CONTROL TRAFFIC AT SIGNALIZED INTERSECTIONS AS DIRECTED BY THE ENGINEER. PROVIDE PORTABLE "ROAD WORK AHEAD" (W20-1) SIGNS 500' IN ADVANCE ALONG BOTH APPROACHES FROM THE SIDE STREETS WHEN PAVING PROCEEDS THROUGH THE INTERSECTION.
- 5) LATERAL CLEARANCE AT ALL SIGN LOCATIONS SHALL BE 2' AS MEASURED FROM THE EDGE OF PAVEMENT OR THE FACE OF THE CURB. WHEN UNABLE TO OBTAIN THE LATERAL CLEARANCE WITHIN THE MEDIAN AREA USE SHOULDER MOUNTS ONLY.
- 6) SIGN MOUNT LOCATIONS SHALL NOT BLOCK SIDEWALKS OR DRIVEWAYS.
- 7) IF STATIONARY GENERAL WARNING SIGNS ARE USED, THEY WILL BE PAID FOR PER SECTION 104 OF THE NCDOT STANDARD SPECIFICATIONS AS EXTRA WORK.
- 8) IF MILLED AREAS ARE NOT PAVED BACK BY THE END OF THE WORK DAY, PORTABLE SIGNS SHALL BE USED TO WARN DRIVERS OF THE PRESENT CONDITIONS. THESE ARE TO INCLUDE, BUT NOT LIMITED TO "ROUGH ROAD" W8-8, "UNEVEN LANES" W8-11, "GROOVED PAVEMENT" W8-15 w/MOTORCYCLE PLAQUE MOUNTED BELOW. THESE ARE TO BE DOUBLE INDICATED ON MULTI-LANE ROADWAYS WITH SPEED LIMITS 45 MPH AND GREATER WHERE LATERAL CLEARANCE CAN BE OBTAINED WITHIN THE MEDIAN AREAS. THESE PORTABLE SIGNS ARE INCIDENTAL TO THE OTHER ITEMS OF WORK INCLUDED IN THE TEMPORARY TRAFFIC CONTROL (LUMP SUM) PAY ITEM.

LEGEND

- ┆ STATIONARY SIGN
- ➔ DIRECTION OF TRAFFIC FLOW



**RESURFACING ADVANCE
WARNING SIGNS FOR
URBAN / SUBURBAN
FACILITIES**

| | | |
|--------------------------------|-----------|-----------|
| PROJECT NO. | SHEET NO. | TOTAL NO. |
| 2023CPT.04.21.20641, 48184.01K | 1 | 2 |

SUMMARY OF QUANTITIES

| PROJECT NO | COUNTY | MAP NO | ROUTE | DESCRIPTION | TYP NO | LANES | LANE TYPE | FINAL SURFACE TESTING REQUIRED | WARM MIX ASPHALT REQUIRED | LENGTH | WIDTH | 1220000000-E | 1297000000-E | 1330000000-E | 1519000000-E | 1575000000-E | 1704000000-E | 2605000000-N | | |
|---|--------|--------|----------------------------|---|--------|-------|-----------|--------------------------------|---------------------------|---------------|-------|-----------------------|----------------|----------------|--------------------|-----------------------|------------------------------|----------------------------|---------------------|----------|
| | | | | | | | | | | | | INCIDENTAL STONE BASE | 1 1/4" MILLING | 1 1/2" MILLING | INCIDENTAL MILLING | SURFACE COURSE, S9.5B | ASPHALT BINDER FOR PLANT MIX | PATCHING EXISTING PAVEMENT | CONCRETE CURB RAMPS | |
| | | | | | | | | | | | | TONS | SY | SY | SY | TONS | TONS | TONS | EA | |
| 2023CPT.04.21.20641 | Nash | 1 | SR-1310 / EDWARDS RD | FROM SR-1321 TO NC-58 | 1 | 2 | 2WU | NO | NO | 6.59 | 20 | 70 | | | 525 | 5,504 | 371 | 50 | | |
| TOTAL FOR MAP NO. 1 | | | | | | | | | | 6.59 | | | 525 | 5,504 | 371 | 50 | | | | |
| 2023CPT.04.21.20641 | Nash | 2 | SR-1310 / TAYLORS GIN RD | FROM NC-58 TO SR-1004 | 1 | 2 | 2WU | NO | NO | 3.62 | 22 | 40 | | | 300 | 3,324 | 224 | 25 | | |
| TOTAL FOR MAP NO. 2 | | | | | | | | | | 3.62 | | | 300 | 3,324 | 224 | 25 | | | | |
| 2023CPT.04.21.20641 | Nash | 3 | SR-1310 / W HILLARDSTON RD | FROM SR-1004 TO START OF C&G | 1 & 2 | 2 | 2WU | NO | NO | 1.75 | 22 | 20 | | | 225 | 1,649 | 111 | 20 | | |
| TOTAL FOR MAP NO. 3 | | | | | | | | | | 1.75 | | | 225 | 1,649 | 111 | 20 | | | | |
| 2023CPT.04.21.20641 | Nash | 4 | SR-1310 / W HILLARDSTON RD | FROM START OF C&G TO END OF C&G | 3 | 2 | | NO | NO | 0.23 | 22 | 10 | 4,000 | | | 211 | 15 | 10 | | |
| TOTAL FOR MAP NO. 4 | | | | | | | | | | 0.23 | | | 4,000 | | | 211 | 15 | 10 | | |
| 2023CPT.04.21.20641 | Nash | 5 | SR-1310 / W HILLARDSTON RD | FROM END OF C&G TO NC-43 | 1 | 2 | 2WU | NO | NO | 1.6 | 22 | 20 | | | 300 | 1,498 | 102 | 25 | | |
| TOTAL FOR MAP NO. 5 | | | | | | | | | | 1.6 | | | 300 | 1,498 | 102 | 25 | | | | |
| 2023CPT.04.21.20641 | Nash | 6 | SR-1310 / E HILLARDSTON RD | FROM NC-43 TO SR-1500 | 1 | 2 | 2WU | NO | NO | 1.12 | 22 | 15 | | | 150 | 1,048 | 71 | 20 | | |
| TOTAL FOR MAP NO. 6 | | | | | | | | | | 1.12 | | | 150 | 1,048 | 71 | 20 | | | | |
| TOTAL FOR PROJ NO. 2023CPT.04.21.20641 | | | | | | | | | | 14.91 | | | 4,000 | | 1,500 | 13,234 | 894 | 150 | | |
| | | | | | | | | | | | | 4,000 | | | | | | | | |
| 48184.01K | Nash | 7 | US-301 @ DMV PARKING LOT | DMV PARKING LOT LOCATED @ 2617 N. WESLEYAN BLVD | 4 | 2 | 2WU | NO | NO | 0.043 | 140 | 10 | | | 3,945 | 331 | 22 | 4 | | |
| TOTAL FOR MAP NO. 7 | | | | | | | | | | 0.043 | | | | | 3,945 | 331 | 22 | 4 | | |
| TOTAL FOR PROJ NO. 48184.01K | | | | | | | | | | 0.043 | | | | | 3,945 | 331 | 22 | 4 | | |
| | | | | | | | | | | | | 3,945 | | | | | | | | |
| GRAND TOTAL | | | | | | | | | | 14.953 | | | 185 | 4,000 | 3,945 | 1,500 | 13,565 | 916 | 150 | 4 |
| | | | | | | | | | | | | 7,945 | | | | | | | | |

| PROJECT NO. | SHEET NO. | TOTAL NO. |
|-----------------------------------|-----------|-----------|
| 2023CPT.04.21.20641, 48184.01K | 2 | 2 |

THERMOPLASTIC AND PAINT QUANTITIES

| PROJECT NO | COUNTY | MAP NO | ROUTE | DESCRIPTION | TYP NO | LANES | LANE TYPE | 4413000000-E | | 4457000000-N | 4840000000-N | 4845000000-N | | 4890000000-E | | | |
|---|--------|--------|----------------------------|---|--------|-------|-----------|---|---------------------------|---|--|-----------------|---------------------------|----------------------------|----------------|----------------|--|
| | | | | | | | | WORK ZONE ADVANCE/GENERAL WARNING SIGNING | TEMPORARY TRAFFIC CONTROL | PAINT "RESERVED" PAVEMENT MARKING CHARACTER | PAINT HANDICAP PAVEMENT MARKING SYMBOL | PAINT STR ARROW | 4" WHITE HOT SPRAY THERMO | 4" YELLOW HOT SPRAY THERMO | | | |
| | | | | | | | | MI | FT | SF | LS | EA | EA | EA | LF | LF | |
| 2023CPT.04.1.20641 | Nash | 1 | SR-1310 / EDWARDS RD | FROM SR-1321 TO NC-58 | 1 | 2 | 2WU | 6.59 | 20 | 316 | 0.40 | | | | 69,590 | 43,494 | |
| TOTAL FOR MAP NO. 1 | | | | | | | | 6.59 | | 316 | 0.40 | | | | 69,590 | 43,494 | |
| 2023CPT.04.21.20641 | Nash | 2 | SR-1310 / TAYLORS GIN RD | FROM NC-58 TO SR-1004 | 1 | 2 | 2WU | 3.62 | 22 | 174 | 0.22 | | | | 38,227 | 23,892 | |
| TOTAL FOR MAP NO. 2 | | | | | | | | 3.62 | | 174 | 0.22 | | | | 38,227 | 23,892 | |
| 2023CPT.04.21.20641 | Nash | 3 | SR-1310 / W HILLARDSTON RD | FROM SR-1004 TO START OF C&G | 1 & 2 | 2 | 2WU | 1.75 | 22 | 84 | 0.10 | | | | 18,480 | 11,550 | |
| TOTAL FOR MAP NO. 3 | | | | | | | | 1.75 | | 84 | 0.10 | | | | 18,480 | 11,550 | |
| 2023CPT.04.21.20641 | Nash | 4 | SR-1310 / W HILLARDSTON RD | FROM START OF C&G TO END OF C&G | 3 | 2 | | 0.23 | 22 | 11 | 0.01 | | | | 2,429 | 1,518 | |
| TOTAL FOR MAP NO. 4 | | | | | | | | 0.23 | | 11 | 0.01 | | | | 2,429 | 1,518 | |
| 2023CPT.04.21.20641 | Nash | 5 | SR-1310 / W HILLARDSTON RD | FROM END OF C&G TO NC-43 | 1 | 2 | 2WU | 1.6 | 22 | 77 | 0.10 | | | | | | |
| TOTAL FOR MAP NO. 5 | | | | | | | | 1.6 | | 77 | 0.10 | | | | | | |
| 2023CPT.04.21.20641 | Nash | 6 | SR-1310 / E HILLARDSTON RD | FROM NC-43 TO SR-1500 | 1 | 2 | 2WU | 1.12 | 22 | 54 | 0.07 | | | | 11,827 | 7,392 | |
| TOTAL FOR MAP NO. 6 | | | | | | | | 1.12 | | 54 | 0.07 | | | | 11,827 | 7,392 | |
| TOTAL FOR PROJ NO. 2023CPT.04.21.20641 | | | | | | | | 14.91 | | 716 | 0.90 | | | | 140,553 | 87,846 | |
| | | | | | | | | | | | | | | 228,399 | | | |
| 48184.01K | Nash | 7 | US-301 @ DMV PARKING LOT | DMV PARKING LOT LOCATED @ 2617 N. WESLEYAN BLVD | 4 | 2 | 2WU | 0.043 | 140 | | 0.10 | 96 | 6 | 8 | 1,265 | 920 | |
| TOTAL FOR MAP NO. 7 | | | | | | | | 0.043 | | | 0.100 | 96 | 6 | 8 | 1,265 | 920 | |
| TOTAL FOR PROJ NO. 48184.01K | | | | | | | | 0.043 | | | 0.100 | 96 | 6 | 8 | 1,265 | 920 | |
| | | | | | | | | | | | | 14 | | 2,185 | | | |
| GRAND TOTAL | | | | | | | | 14.953 | | 716 | 1.000 | 96 | 6 | 8 | 141,818 | 88,766 | |
| | | | | | | | | | | | | | | 14 | | 230,584 | |

| | | |
|---|----------------|-------------------|
| PROJECT NO. 2023CPT.04.21.20641 , 48184.01K | SHEET NO. 1 | TOTAL SHEETS 2 |
|---|----------------|-------------------|

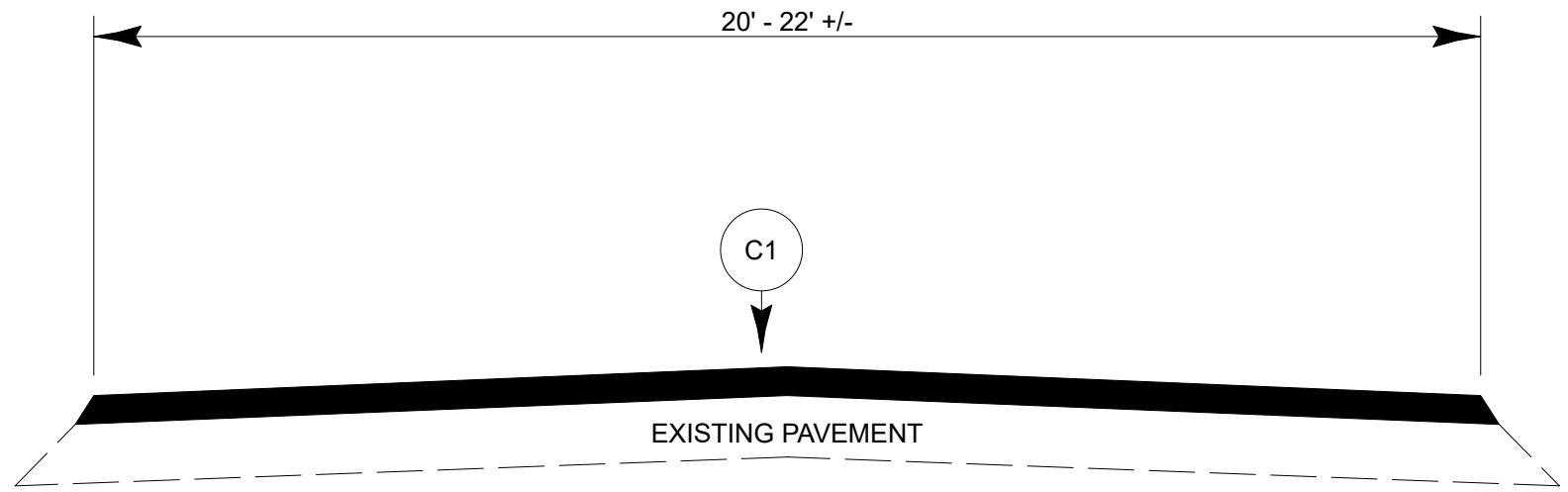

TYPICAL SECTION NO. 1
MAP # 1, 2, 3, 5, & 6

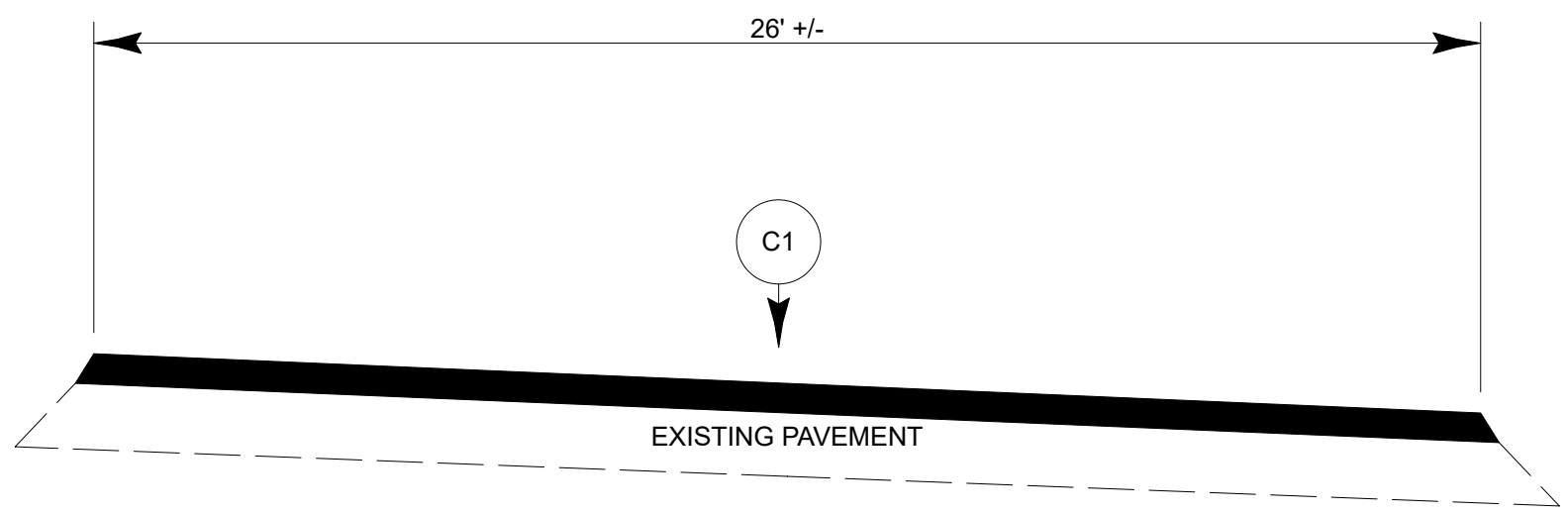

TYPICAL SECTION NO. 2
MAP # 3

| PAVEMENT SCHEDULE | |
|-------------------|--|
| C1 | PROP. APPROX. 1.25" OF S9.5B AT AN AVERAGE RATE OF 138 LBS. PER SQ. YARD |
| C2 | PROP. APPROX. 1.5" OF S9.5B AT AN AVERAGE RATE OF 165 LBS. PER SQ. YARD |
| V1 | MILL ASPHALT PAVEMENT, 1 1/4" DEPTH |
| V2 | MILL ASPHALT PAVEMENT, 1 1/2" DEPTH |

| | | |
|--|----------------|-------------------|
| PROJECT NO. 2023CPT.04.21.20641, 48184.01K | SHEET NO. 2 | TOTAL SHEETS 2 |
|--|----------------|-------------------|

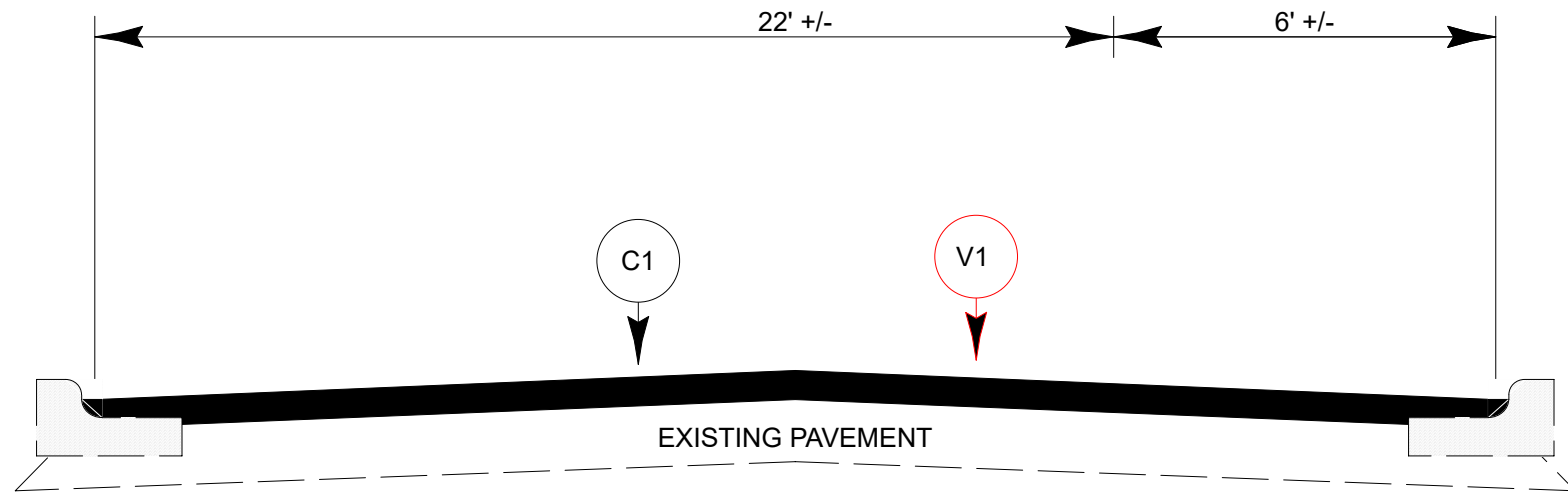

TYPICAL SECTION NO. 3
MAP # 4

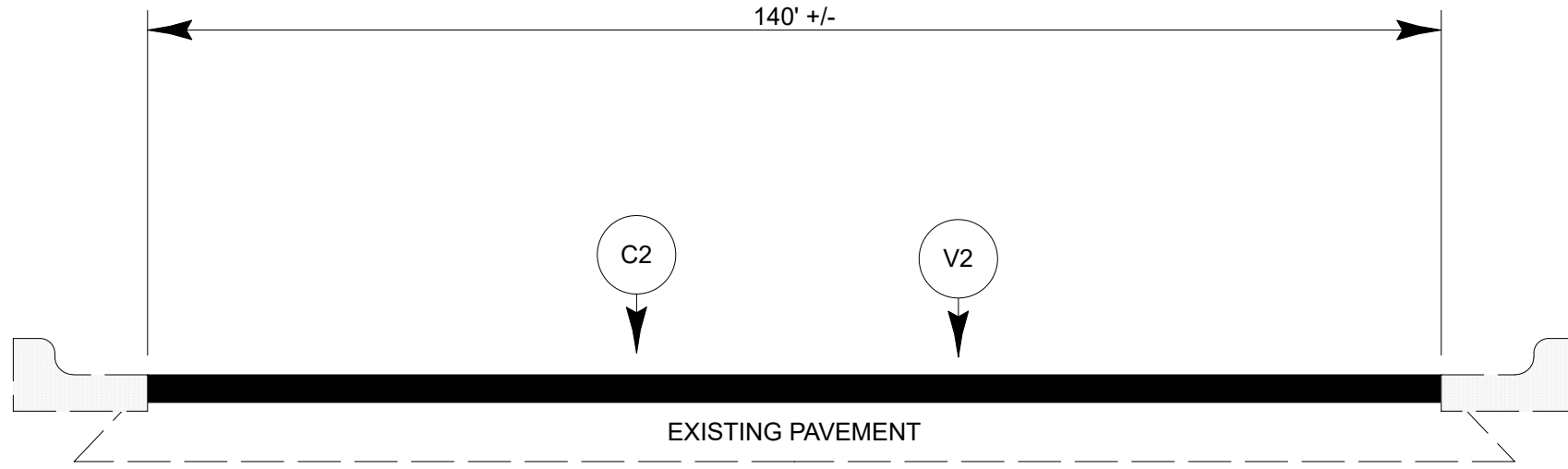

TYPICAL SECTION NO. 4
MAP # 7

| PAVEMENT SCHEDULE | |
|-------------------|--|
| C1 | PROP. APPROX. 1.25" OF S9.5B AT AN AVERAGE RATE OF 138 LBS. PER SQ. YARD |
| C2 | PROP. APPROX. 1.5" OF S9.5B AT AN AVERAGE RATE OF 165 LBS. PER SQ. YARD |
| V1 | MILL ASPHALT PAVEMENT, 1 1/4" DEPTH |
| V2 | MILL ASPHALT PAVEMENT, 1 1/2" DEPTH |

DETAILS OF PATCHING EXISTING PAVEMENT PRIOR TO RESURFACING DETAIL

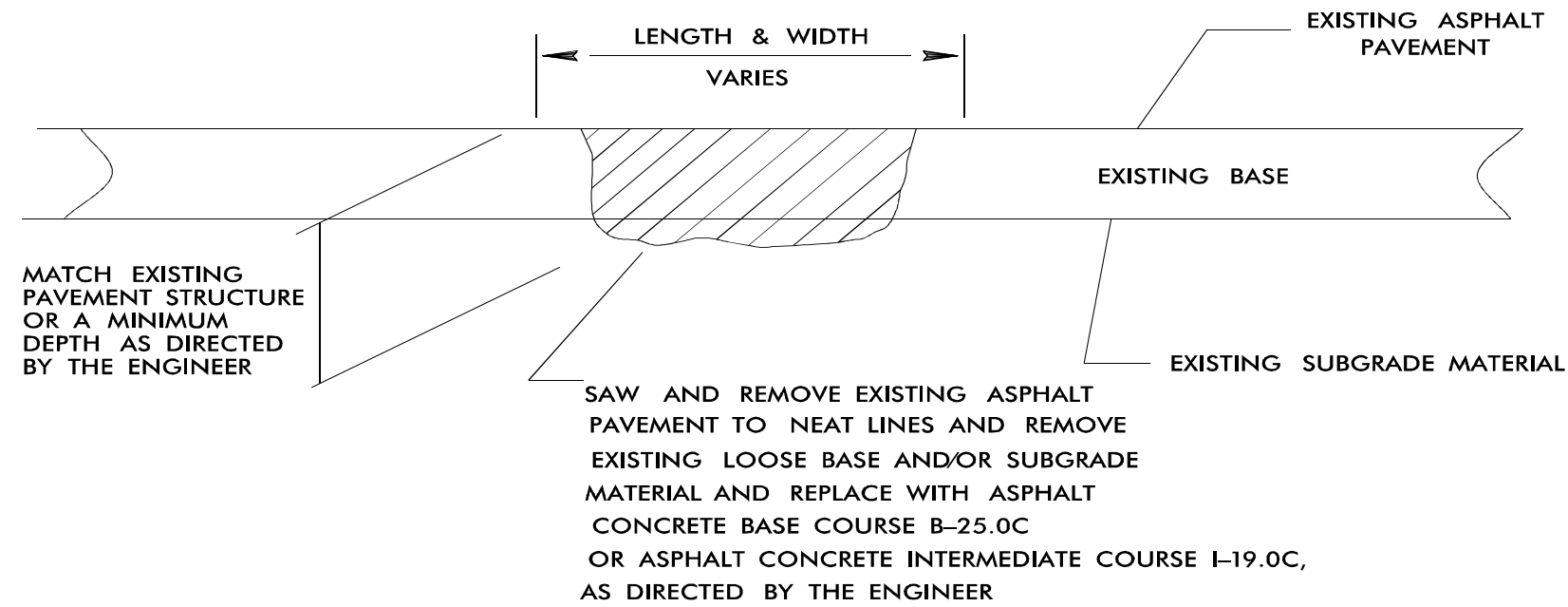

INCIDENTAL MILLING DETAIL

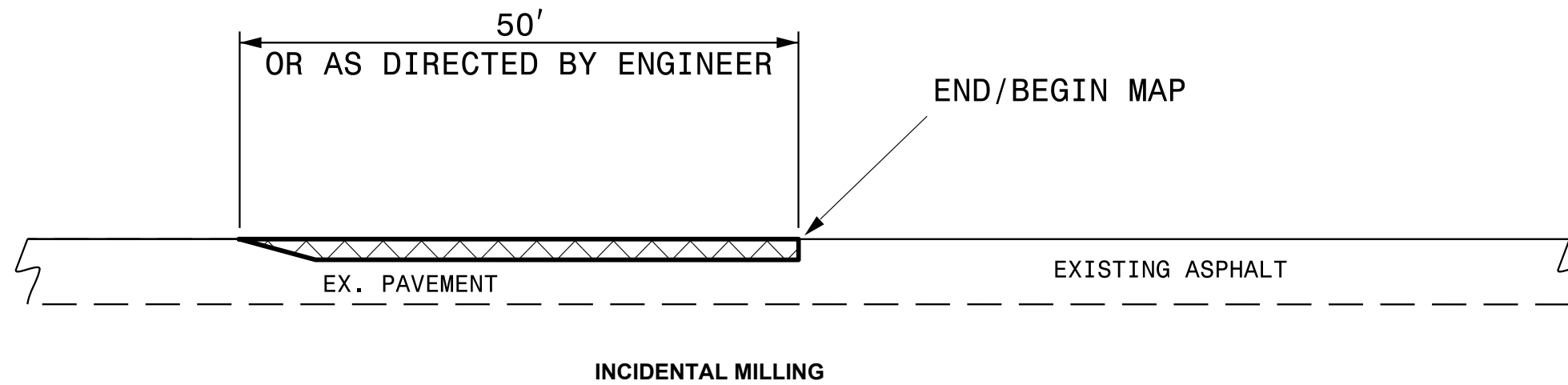

NOTE:

1. PERFORM INCIDENTAL MILLING AT THE TIE INS, RAILROADS, BRIDGE DECKS AND APPROACHES AT THE DIRECTION OF THE ENGINEER.

BRIDGE TIE-IN DETAILS

| Div 4/Dist2 Bridges in 2024 Nash Package WBS 2023CPT.04.14.20641 | | | | | | | |
|--|------|--------------|----------|-----------------|-----------------|---------------------|---|
| County | sr # | Road Name | Bridge # | Current Surface | Posted (Yes/No) | Proposed Work | Bridge Comments |
| Nash | 1310 | Edwards Road | 0126 | Asphalt | No | 1.25" S9.5B Overlay | BR # 630011 on SR 1310. Mill approaches 50' and tie to approach slabs |
| Nash | 1310 | Edwards Road | 0125 | Asphalt | No | 1.25" S9.5B Overlay | BR # 630011 on SR 1310. Mill approaches 50' and tie to approach slabs |
| Nash | 1310 | Edwards Road | 011 | Asphalt | No | 1.25" S9.5B Overlay | BR # 630011 on SR 1310. Mill approaches 50' and tie to approach slabs |

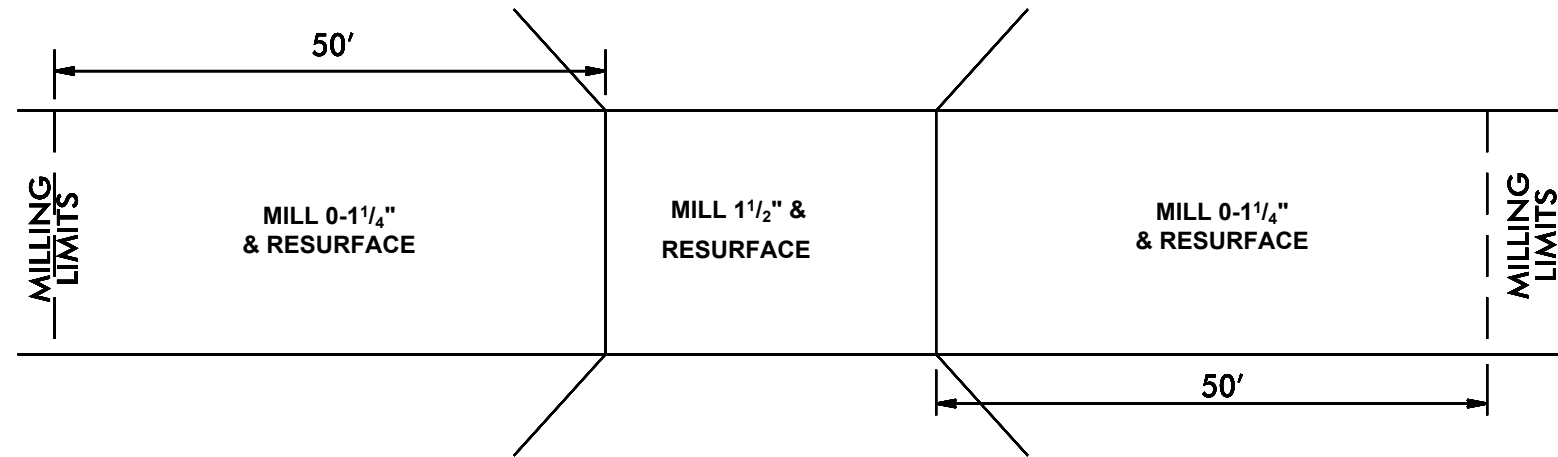

DRAWING FOR BRIDGE #0126 & #0125 & 0011
USE FOR MAP #1

* MILLING SHALL BE PAID FOR UNDER INCIDENTAL MILLING

- NOTES:
 1) DETAIL DOES NOT APPLY TO OGAFB AND ULTRA-THIN BONDED WEARING COURSE.
 2) BACKFILL SHOULDER WITH APPROVED MATERIAL.
 3) THE SHOULDER WEDGE DEVICE MAY BE DISENGAGED AT PAVED DRIVEWAYS AND SIDE STREETS.

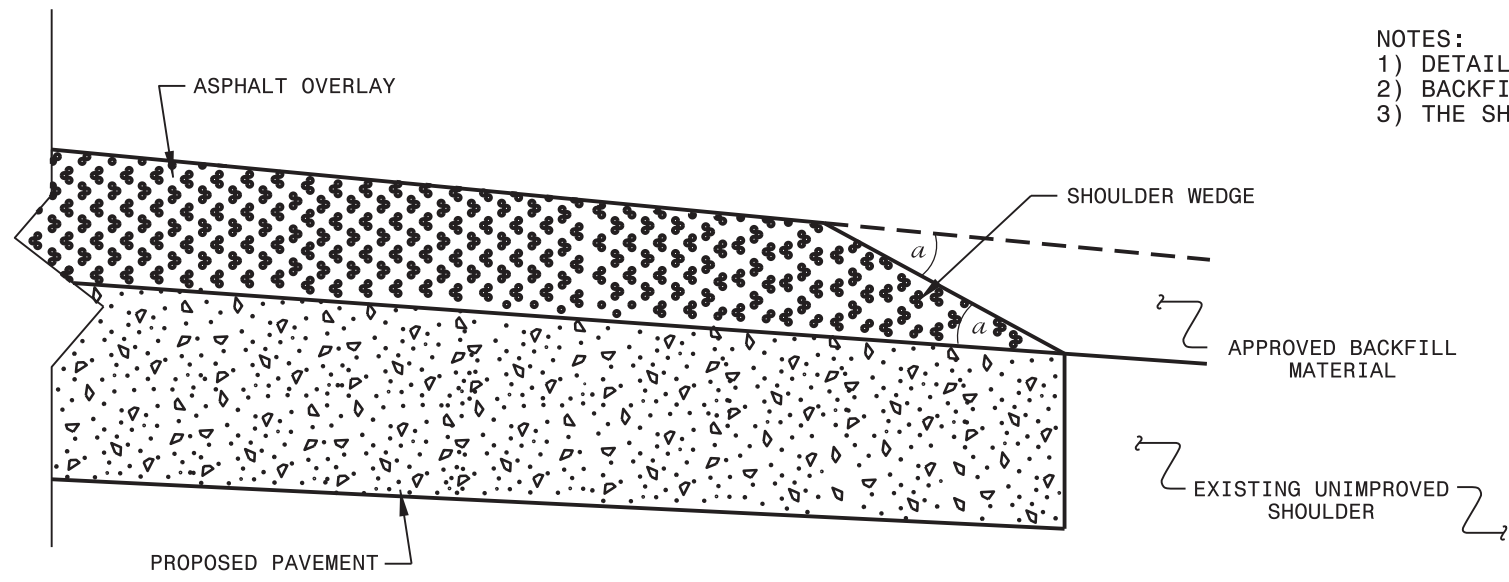

SHOULDER WEDGE DETAIL
 (Resurfacing Projects w/ Widening or
 with Existing Paved Shoulder having no dropoffs)

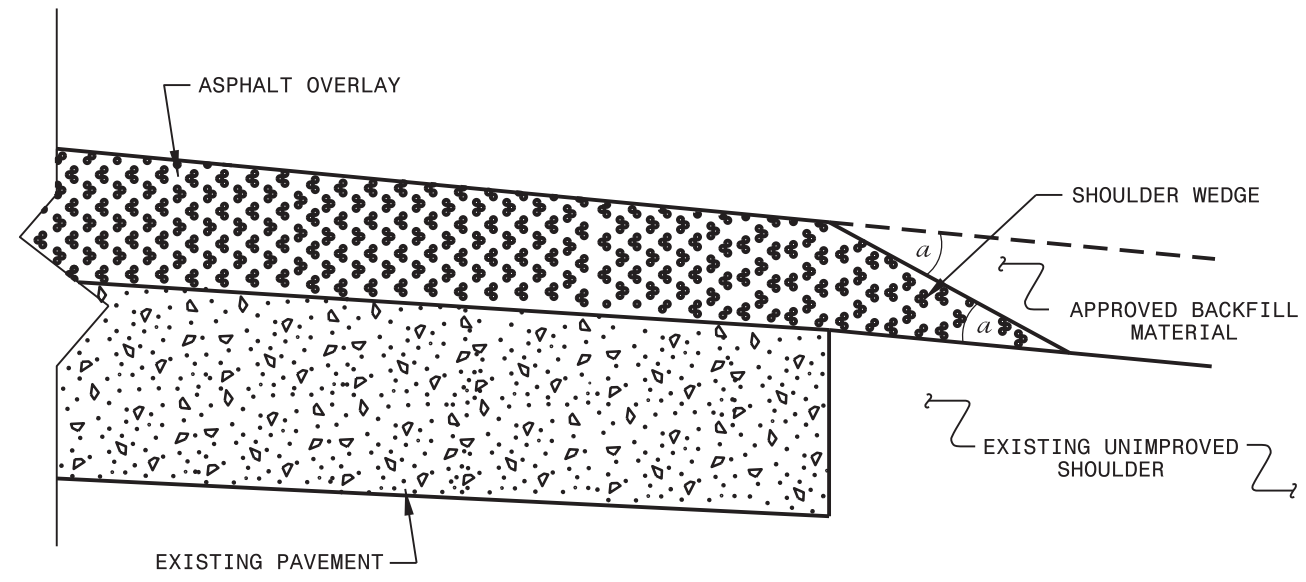

SHOULDER WEDGE DETAIL
 (Resurfacing Projects w/ NO Widening)

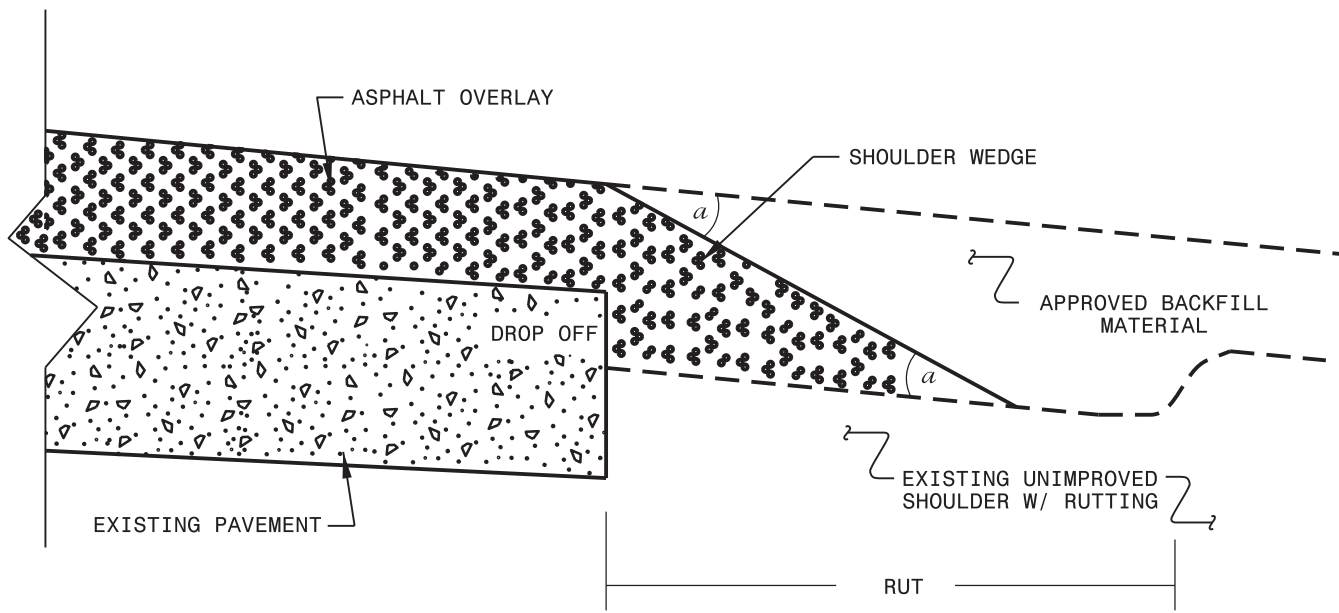

SHOULDER WEDGE DETAIL
 (Resurfacing Adjacent to
 Rutted Shoulder)

- SHOULDER WEDGE ANGLE = 30°

| | |
|--|----------------|
| CONTRACT STANDARDS AND DEVELOPMENT UNIT | |
| Office 919-707-6950 FAX 919-250-4119 | |
| SHOULDER WEDGE DETAILS | |
| ORIGINAL BY: T.SPELL | DATE: 7-19-11 |
| MODIFIED BY: | DATE: 10/16/12 |
| CHECKED BY: | DATE: |
| FILE SPEC.: susr/details/stand/shoulderwedgedetail.dgn | |

SYSTEM: 04/21/2023 10:00 AM
 USER: T.SPELL
 FILE: susr/details/stand/shoulderwedgedetail.dgn

NASH COUNTY

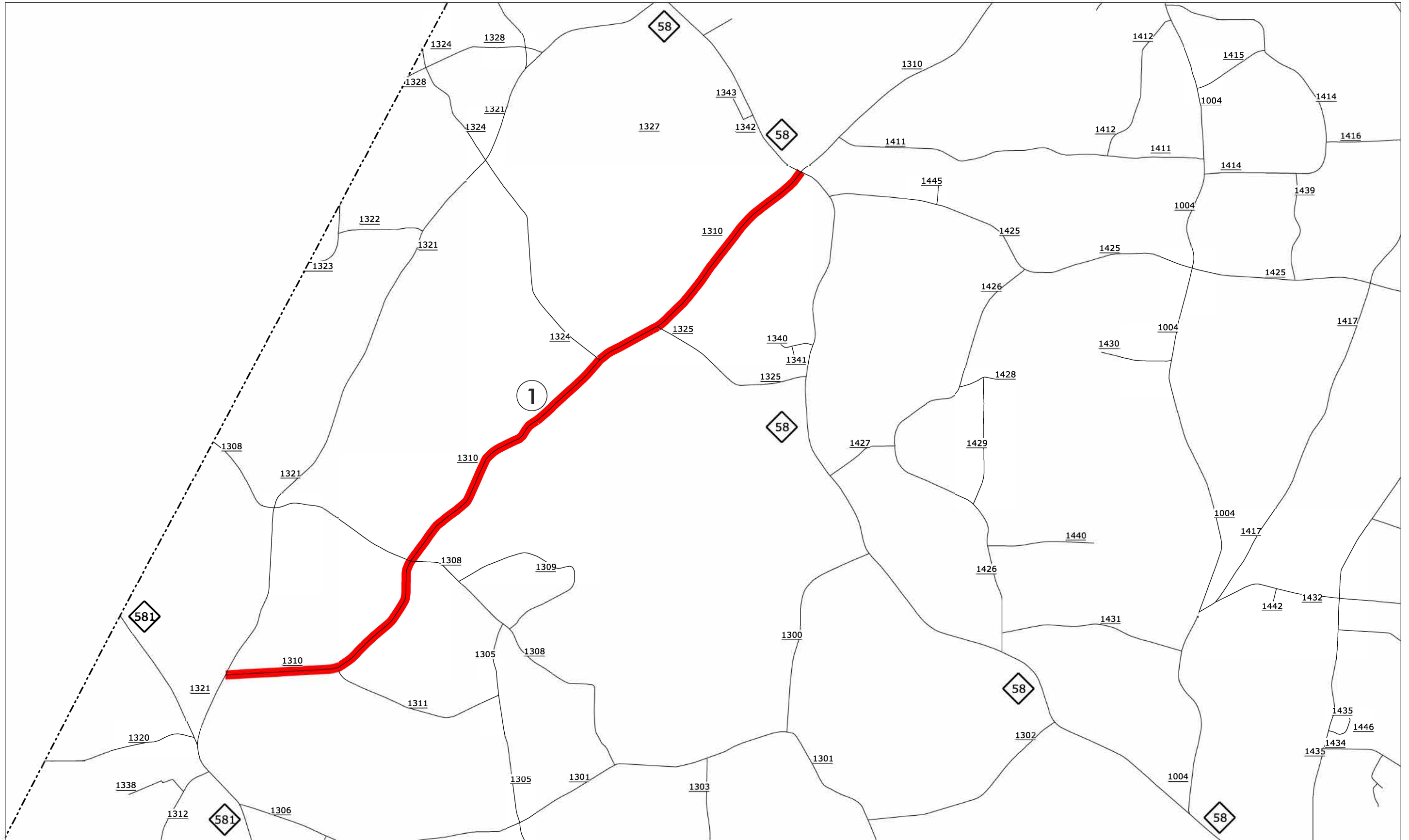

NASH COUNTY

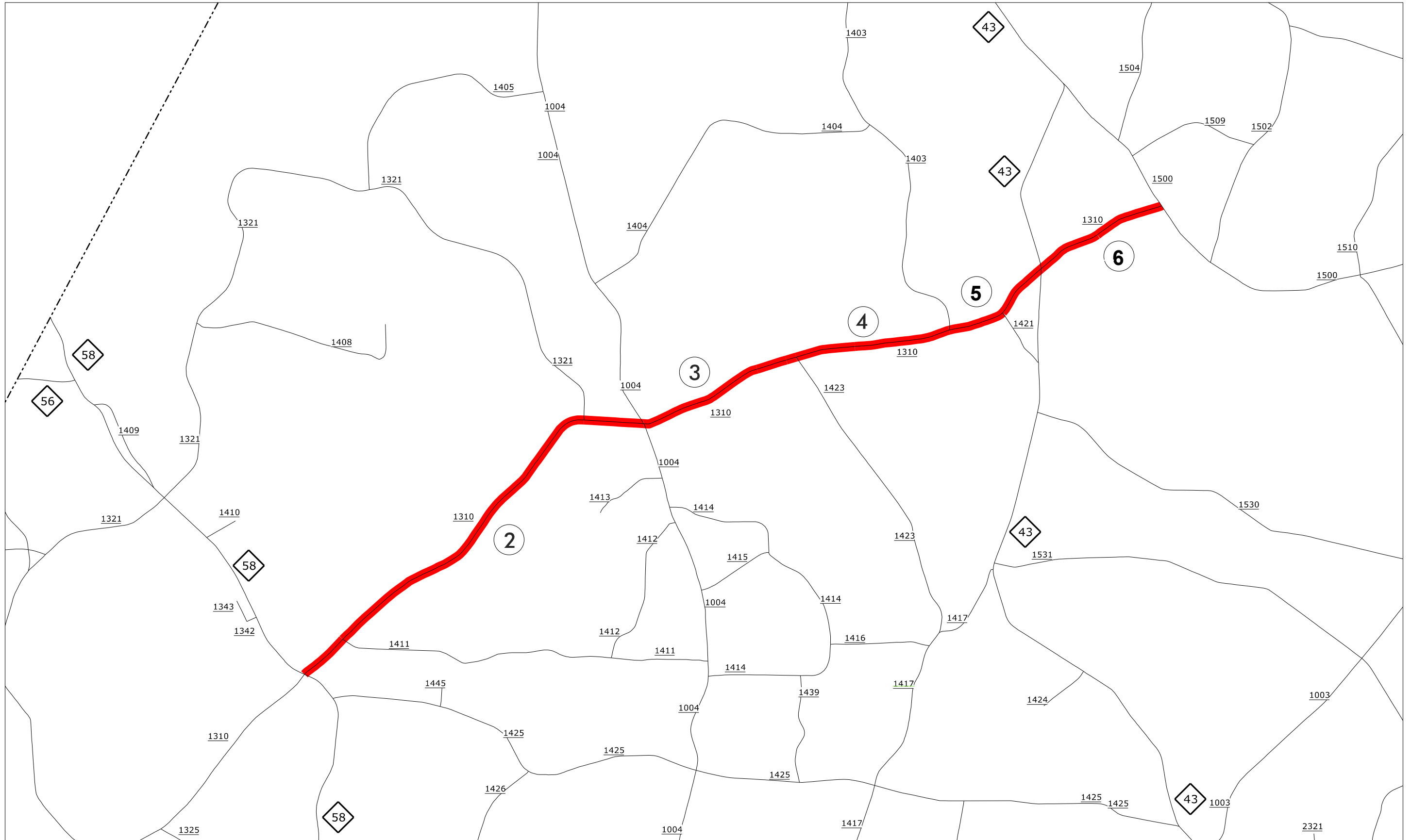

Map #7 - 2617 N Wesleyan Blvd @ Rocky Mount DMV Drivers License Office
WBS # 48184.01K - Sheet 3 of 3
Edgecombe County



STANDARD SPECIAL PROVISION
AVAILABILITY OF FUNDS – TERMINATION OF CONTRACTS

(5-20-08)

Z-2

General Statute 143C-6-11. (h) Highway Appropriation is hereby incorporated verbatim in this contract as follows:

(h) Amounts Encumbered. – Transportation project appropriations may be encumbered in the amount of allotments made to the Department of Transportation by the Director for the estimated payments for transportation project contract work to be performed in the appropriation fiscal year. The allotments shall be multiyear allotments and shall be based on estimated revenues and shall be subject to the maximum contract authority contained in *General Statute 143C-6-11(c)*. Payment for transportation project work performed pursuant to contract in any fiscal year other than the current fiscal year is subject to appropriations by the General Assembly. Transportation project contracts shall contain a schedule of estimated completion progress, and any acceleration of this progress shall be subject to the approval of the Department of Transportation provided funds are available. The State reserves the right to terminate or suspend any transportation project contract, and any transportation project contract shall be so terminated or suspended if funds will not be available for payment of the work to be performed during that fiscal year pursuant to the contract. In the event of termination of any contract, the contractor shall be given a written notice of termination at least 60 days before completion of scheduled work for which funds are available. In the event of termination, the contractor shall be paid for the work already performed in accordance with the contract specifications.

Payment will be made on any contract terminated pursuant to the special provision in accordance with Subarticle 108-13(D) of the *2018 Standard Specifications*.

STANDARD SPECIAL PROVISION

ERRATA

(10-16-18) (Rev. 6-20-23)

Z-4

Revise the *2018 Standard Specifications* as follows:

Division 1

Page 1-1, Article 101-2 Abbreviations, line 13, replace " American National Standards Institute, Inc." with "American National Standards Institute".

Page 1-1, Article 101-2 Abbreviations, line 32, replace "Equivalent Single Axis Load" with "Equivalent Single Axle Load".

Page 1-16, Subarticle 102-9(A) General, line 26, replace "10 U.S.C. 2304(g)" with "10 U.S.C. 3205".

Page 1-43, Article 104-13 RECYCLED PRODUCTS OR SOLID WASTE MATERIALS, line 4, replace "104-13(B)(2)" with "104-13(B)".

Page 1-52, Article 106-1 RECYCLED PRODUCTS OR SOLID WASTE MATERIALS, line 25, replace "13 NCAC 7CF.0101(a)(99)" with "29 CFR 1910.1200".

Page 1-79, Article 109-1 MEASUREMENT AND PAYMENT, Test Method prior to line 34, replace "AASHTO M 32" with "AASHTO M 336".

Division 2

Page 2-5, Article 210-2 CONSTRUCTION METHODS, line 21, replace " NCGS §§ 130A-444 to -452" with "NCGS §§ 130A-444 to -453".

Page 2-13, Article 225-2 EROSION CONTROL REQUIREMENTS, line 17, replace "the Sedimentation and Pollution Control Act" with "Article 107-12".

Page 2-20, Subarticle 230-4(B)(3) Reclamation Plan, line 12, replace " Department's borrow and waste site reclamation procedures for contracted projects" with "Department's *Borrow Waste and Staging Site Reclamation Procedures for Contract Projects*".

Page 2-25, Subarticle 235-3(E) Surcharges and Waiting Periods, line 21 and 27, delete "Department's Materials and Tests Unit.".

Page 2-27, Article 240-4 MEASUREMENT AND PAYMENT, line 23, replace "Section 225" with "Article 225-7".

Page 2-30, Article 275-4 MEASUREMENT AND PAYMENT, line 33, replace "Section 815" with "Article 815-4".

Division 4

Page 4-18, Subarticle 411-5(C)(3) Coring, line 11, replace “in accordance with ASTM D5079” with “with methods acceptable to the Engineer”.

Page 4-50, Article 430-2 MATERIALS, prior to line 15, replace Section “1080-9” with “1080-7”.

Page 4-53, Article 440-2 MATERIALS, prior to line 6, replace Section “1080-9” with “1080-7”.

Page 4-58, Article 442-2 MATERIALS, prior to line 15, replace Section “1080-6” with “1080-12”.

Page 4-59, Subarticle 442-7(A) Blast Cleaning, line 36, replace Article “1080-6” with “1080-12”.

Page 4-76, Article 454-2 MATERIALS, prior to line 24, replace Section “815-2” with “1044”.

Page 4-79, Article 455-2 MATERIALS, prior to line 21, replace Section “815” with “1044”.

Page 4-80, Subarticle 455-3(B) Precast Gravity Wall Designs, line 23 and lines 25-26, replace “AASHTO LRFD specifications” with “*AASHTO LRFD Bridge Design Specifications*”.

Page 4-84, Article 458-5 MEASUREMENT AND PAYMENT, line 31, replace article number “454-1” with “458-1”.

Division 6

Page 6-7, Article 609-1 DESCRIPTION, line 29, replace article number “609-10” with “609-9”.

Page 6-10, Subarticle 609-6(C) Control Charts, line 17, replace Section number “7021” with “7.20.1”.

Page 6-13, Article 609-9 QUALITY ASSURANCE, line 31, replace Section number “7.60” with “7.6”.

Page 6-26, Subarticle 610-13(A)(1) Acceptance for New Construction, line 31, replace Table number “610-7” with “610-8”.

Page 6-29, Subarticle 610-13(B) North Carolina Hearne Straightedge, line 32, replace Table number “610-8” with “610-9”.

Page 6-31, Article 610-14 DENSITY ACCEPTANCE, Specified Density prior to line 30 and line 32, replace Table number “610-6” with “610-7”.

Page 6-37, Article 650-5 CONSTRUCTION METHODS, line 10, replace Section number “9.5(E)” with “9.5.1(E)”.

Page 6-44, Subarticle 660-8(B) Asphalt Mat and Seal, line 40, replace Subarticle number “660-8(A)” with “660-8(C)”.

Page 6-44, Subarticle 660-8(B) Asphalt Mat and Seal, line 42, replace Subarticle number “660-8(C)” with “660-8(A)”.

Division 7

Page 7-11, Subarticle 700-15(E) Compressive Strength, line 5, replace “AASHTO T 23” with “AASHTO R 100”.

Page 7-24, Article 723-4 Very High Early Strength Concrete for Concrete Pavement Repair, line 4, replace “AASHTO T126” with “AASHTO R 39”.

Page 7-24, Article 723-5 MEASUREMENT AND PAYMENT, line 34, replace "Section 225" with “Article 225-7”.

Page 7-24, Article 723-5 MEASUREMENT AND PAYMENT, line 36, replace "Section 270" with “Article 270-4”.

Page 7-27, Article 725-1 MEASUREMENT AND PAYMENT, line 4, replace article number “725-1” with “724-4”.

Page 7-28, Article 725-1 MEASUREMENT AND PAYMENT, line 10, replace article number “725-1” with “725-3”.

Division 8

Page 8-11, Article 815-1 MATERIALS, after line 35, replace “1080-12” with “1080-10”.

Page 8-13, Article 816-1 MATERIALS, after line 28, replace “1080-12” with “1080-10”.

Page 8-17, Article 825-1 Description, line 5, delete “853” and “855”.

Division 10

Page 10-2, Subarticle 1000-3(B) Air Entrainment, line 33, replace “Chase” with “Chace”.

Page 10-4, Subarticle 1000-4(A) Composition and Design, after line 17, replace “T23” with “R100”.

Page 10-4, Subarticle 1000-4(B) Air Entrainment, line 31 and 33, replace “Chase” with “Chace”.

Page 10-4, Subarticle 1000-4(C) Strength of Concrete, line 39 and 41, replace “T 23” with “R 100”.

Page 10-15, Subarticle 1000-11(B) Mixing Time for Central Mixed Concrete, after line 35, replace “T 23” with “R 100”.

Page 10-22, Article 1003-3 COMPOSITION AND DESIGN, line 9, replace “Engineer” with “engineer”.

Page 10-23, Article 1003-4 GROUT REQUIREMENTS, line 16 and 18, replace “T 23” with “R 100”.

Page 10-26, Article 1005-4 TESTING, after line 26, replace “1014-2€(6)” with “1014-2€(6)” in C. of Table 1005-1 footnote and replace “Lightweight^B” with “Lightweight^C”.

Page 10-29, Subarticle 1012-1(B)(4) Flat and Elongated Pieces, line 44, delete “SF9.5A”

Page 10-36, Subarticle 1012-2(E) Toughness (Resistance to Abrasion), line 31, replace “course” with “coarse”.

Page 10-37, Article 1012-4, LIGHTWEIGHT AGGREGATE, line 4, replace Table number “1012-8” with “1012-5”.

Page 10-48, Subarticle 1020-10(A) Mineral Fibers, line 27, replace “Table 1012-5” with “Table 1020-2”.

Page 10-52, Article 1024-5 FLY ASH, line 12, replace “Table 2” with “Table 3”.

Page 10-60, Subarticle 1032-6(F) Joint Materials, line 15, replace “AASHTO M 198” with “ASTM C990” and delete “Type B”.

Page 10-61, Article 1034-3 CONCRETE SEWER PIPE, line 33, replace “AASHTO M 198” with “ASTM C990” and delete “Type A or B”.

Page 10-64, Article 1040-1 BRICK, line 12, replace “ASTM C62” with “ASTM C62 or ASTM C216”.

Page 10-67, Article 1044-7 CORRUGATED PLASTIC PIPE AND FITTINGS, line 24, replace “AASHTO M 294 for heavy duty tubing” with “Article 1032-7 and AASHTO M 252”.

Page 10-68, Subarticle 1046-3(D) Offset Blocks, lines 30-32, delete “Before beginning the installation of recycled offset block, submit the FHWA acceptance letter for each type of block to the Engineer for approval.”

Page 10-69, Subarticle 1046-3(D) Offset Blocks, before line 1, replace “WIRE DIAMETER” with “COMPOSITE OFFSET BLOCKS” as the title of Table 1046-1, delete “Testing” property and associated requirement from Table 1046-1, and replace “Approval” requirement of “Approved for use by the FHWA” with “Approved for use on the NCDOT APL” in Table 1046-1.

Page 10-80, Article 1060-2 FERTILIZER, line 18, replace “North Carolina Fertilizer Law” with “North Carolina Commercial Fertilizer Law”.

Page 10-83, Article 1060-9 WATER, line 9, replace “15 NCAC 2B.0200” with “15A NCAC 02B.0200”.

Page 10-86, Article 1070-3 COLD DRAWN STEEL WIRE AND WIRE REINFORCEMENT, line 23 and 25, replace “M 32” and “M 55” with “M 336”.

Page 10-87, Article 1070-6 DOWELS AND TIE BARS FOR PORTLAND CEMENT CONCRETE PAVEMENT, line 17, replace “AASHTO M 32” with “AASHTO M 336”.

Page 10-88, Subarticle 1070-7(D) Handling, Storage and Transportation, line 40, replace “Section” with “Subarticle”.

Page 10-89, Article 1070-8 SPIRAL COLUMN REINFORCING STEEL, line 21, replace “AASHTO M 32” with “AASHTO M 336”.

Page 10-91, Article 1072-3 BEARING PLATE ASSEMBLIES, line 44, replace “Article 1080-9” with “Article 1080-7”.

Page 10-92, Subarticle 1072-5(A) General, after line 30, replace “SAMPLING REQUIREMENTS FOR HIGH STRENGTH BOLTS, NUTS AND WASHERS” with “SAMPLING REQUIREMENTS FOR HIGH STRENGTH BOLTS, NUTS AND WASHERS TO INCLUDE DIRECT TENSION INDICATORS” as the title of Table 1072-1.

Page 10-95, Subarticle 1072-5(D)(7)(a) Mill Test Report(s), line 18, replace title with “Mill Test Report(s) (MTR)”.

Page 10-95, Subarticle 1072-5(D)(7)(b) Manufacturer Certified Test Report(s), line 24, replace title with “Manufacturer Certified Test Report(s) (MCTR)”.

Page 10-96, Subarticle 1072-5(D)(7)(c) Distributor Certified Test Report(s), line 1, replace title with “Distributor Certified Test Report(s) (DCTR)”.

Page 10-98, Subarticle 1072-5(F) Galvanized High Strength Bolts, Nuts and Washers, line 11, replace “Article 1080-9” with “Article 1080-7”.

Page 10-98, Subarticle 1072-5(F) Galvanized High Strength Bolts, Nuts and Washers, line 11, replace “Article 1080-9” with “Article 1080-7”.

Page 10-111, Subarticle 1072-18(B) General, line 24, replace “Structural Welding Code-Reinforcing Steel” with “Structural Welding Code-Steel Reinforcing Bars”.

Page 10-117, Article 1074-1 WELDING, lines 21-22, replace “Structural Welding Code-Reinforcing Steel” with “Structural Welding Code-Steel Reinforcing Bars”.

Page 10-119, Article 1074-7(B) Gray Iron Castings, line 16, replace “M306” with “AASHTO M 306”.

Page 10-121, Article 1076-7, REPAIR OF GALVANIZING, line 8, replace article number “1080-9” with “1080-7”.

Page 10-125, Subarticle 1077-5(B) Testing, line 31, replace “T 23” with “R 100”.

Page 10-136, Subarticle 1077-5(J)(2) Mixing Time for Central Mixed Concrete, after line 17, replace “T23” with “R100”.

Page 10-131, Subarticle 1078-4(A) Composition and Design, after line 23, in Table 1078-2 replace “T 23” with “R 100”.

Page 10-135, Subarticle 1078-4(J)(2) Mixing Time for Central Mixed Concrete, line 46, replace “Table 1078-2” with “Table 1078-3”

Page 10-153, Subarticle 1079-1 PREFORMED BEARING PADS, line 8, replace “MIL-C882-D” with “MIL-C-882-E”.

Page 10-154, Subarticle 1079-2(A) General, line 6, delete “and 1079-2(E)”.

Page 10-156, Article 1080-5 SELF-CURING INORGANIC ZINC PAINT, line 8, replace “AASHTO M 252” with “AASHTO M 300”.

Page 10-156, Article 1080-5 SELF-CURING INORGANIC ZINC PAINT, line 20, replace “AASHTO M 253” with “AASHTO M 300”.

Page 10-156, Subarticle 1080-9(A) Composition, line 40, replace “Tables 1080-7 through 1080-14” with “Tables 1080-1 through 1080-3”.

Page 10-157, Subarticle 1080-9(B) Properties, line 5, replace “Tables 1080-7 through 1080-14” with “Tables 1080-1 through 1080-3”.

Page 10-157, Subarticle 1080-9(B) Properties, line 35, replace “Materials and Tests Standards CLS-P-1.0” with “*Structural Steel Shop Coatings Program*”.

Page 10-159, Subarticle 1080-9(E) Color Variation, Table 1080-1, replace “ASTM D1159” with “ASTM D1199”.

Page 10-159, Subarticle 1080-9(E) Color Variation, Table 1080-1, replace “NCDOT M&T P-10” with “ASTM D6280”.

Page 10-161, Subarticle 1080-9(E) Color Variation, Table 1080-3, replace “ASTM D13278” and “ASTM D3278”.

Page 10-161, Subarticle 1080-9(E) Color Variation, Table 1080-3, replace “NCDOT M&T P-10” and “Structural Steel Shop Coatings Program”.

Page 10-161, Subarticle 1080-9(E) Color Variation, Table 1080-3, add Test Method “ASTM D4400” for the Leneta Sag Test property in Table 1080-3.

Page 10-161, Subarticle 1080-9(E) Color Variation, Table 1080-3, add Test Method “ASTM D523” for the Gloss, Specular property in Table 1080-3.

Page 10-161, Subarticle 1080-9(E) Color Variation, Table 1080-3, replace Test Method “ASTM” with “ASTM E70” for the pH property in Table 1080-3.

Page 10-162, Article 1080-50 PAINT FOR VERTICAL MARKERS, line 1, replace article number “1080-50” with “1080-10”.

Page 10-162, Article 1080-61 EPOXY RESIN FOR REINFORCING STEEL, line 5, replace article number “1080-61” with “1080-11”.

Page 10-162, Article 1080-72 ABRASIVE MATERIALS FOR BLAST CLEANING STEEL, line 22, replace article number “1080-72” with “1080-12”.

Page 10-163, Article 1080-83 FIELD PERFORMANCE AND SERVICES, line 25, replace article number “1080-83” with “1080-13”.

Page 10-166, Subarticle 1081-1(E) Prequalification, line 24, replace “Value Management Unit” with “Product Evaluation Program”.

Page 10-168, Subarticle 1081-3(A) Physical Requirements, after line 25, replace “Subarticle 1081-4(B)” with “Subarticle 1081-3(B)” in Table 1081-2.

Page 10-168, Subarticle 1087-2(A) Paint Composition, lines 19-20, replace “Federal Specification TTP 1952F” with “Federal Specification TT-P-1952”.

Page 10-200, Subarticle 1090-1(C) Anchor Bolts, line 38, replace ASTM number “A325” with “F3125”.

Page 10-202, Subarticle 1091-3(F) Solid Wall HDPE Conduit, line 5, replace “, Table 1091-1, 1091-2 and 1091-3” with “and Table 1091-1”.

Page 10-208, Subarticle 1094-1(A) Breakaway or Simple Steel Beam Sign Supports, line 19, replace ASTM number “A325” with “F3125”.

Page 10-209, Subarticle 1094-1(D) Steel Square Tube Posts, line 10, replace ASTM number “A123” with “A653”.

Page 10-209, Subarticle 1094-1(E) Wood Supports, line 17, replace “Article 1082-2 and 1082-3” with “Section 1082”.

Page 10-212, Subarticle 1098-1(H) Electrical Service, line 21, replace “NEMA Type 3R” with “NEMA 3R”.

Page 10-212, Subarticle 1098-1(H) Electrical Service, line 36, replace “UL Standard 231” with “UL Standard UL-231”.

Page 10-212, Subarticle 1098-1(H) Electrical Service, line 37, replace “UL Standard 67” with “UL Standard UL-67”.

Page 10-224, Subarticle 1098-14(H)(1) Type I – Pedestrian Pushbutton Post, line 3, replace ASTM number “325” with “F3125”.

Page 10-224, Article 1098-16 CABINET BASE ADAPTER/EXTENDER, line 33, replace Section number “6.7” with “6.8”.

Division 14

Page 14-11, Subarticle 1401-2(B) Lowering Device, line 36, replace Military Specification “MIL-W-83420E” with “MIL-DTL-83420”.

Page 14-22, Article 1412-2 MATERIALS, line 29, replace UL Standard “1572” with “1598”.

Division 15

Page 15-6, Subarticle 1510-3(B) Testing and Sterilization, line 40, replace Section number “4.4.3” with “4.4”.

Page 15-14, Article 1525-2 MATERIALS, line 9, replace “AASHTO M 198” with “ASTM C990”.

Page 15-14, Article 1525-2 MATERIALS, lines 17-18, delete “in the Grout Production and Delivery provision”.

Page 15-19, Article 1550-2 MATERIALS, line 16, replace “*AASHTO LRFD Bridge Design Specifications*” with “*AASHTO LRFD Bridge Construction Specifications*”.

Division 16

Page 16-9, Article 1630-3 MEASUREMENT AND PAYMENT, line 7, replace “Section 225” with “Article 225-7”.

Page 16-9, Article 1630-3 MEASUREMENT AND PAYMENT, line 8, replace “Section 230” with “Article 230-5”.

Page 16-16, Article 1637-5 MEASUREMENT AND PAYMENT, line 17, replace "Section 310" with "Article 310-6".

Division 17

Page 17-15, Article 1715-4 MEASUREMENT AND PAYMENT, lines 42-44, replace the second sentence with the following:

An example is an installation of a single 1.25 inch HDPE conduit would be paid as:

Directional Drill (1)(1.25") Linear Foot

Page 17-15, Subarticle 1715-3(E) Bore and Jack, line 5, replace article number "1540-4" with "1550-4".

Page 17-15, Subarticle 1715-3(E) Bore and Jack, lines 10 & 11, replace "*NCDOT Policies and Procedures for Accommodating Utilities on Highway Rights of Way*" with "*NCDOT Utilities Accommodations Manual*".

STANDARD SPECIAL PROVISION

PLANT AND PEST QUARANTINES

(Imported Fire Ant, Gypsy Moth, Witchweed, Emerald Ash Borer, Guava Root Knot Nematode, And Other Noxious Weeds)

(3-18-03) (Rev. 5-21-19)

Z-04a

Within Quarantined Area

This project may be within a county regulated for plant and/or pests. If the project or any part of the Contractor's operations is located within a quarantined area, thoroughly clean all equipment prior to moving out of the quarantined area. Comply with federal/state regulations by obtaining a certificate or limited permit for any regulated article moving from the quarantined area.

Originating in a Quarantined County

Obtain a certificate or limited permit issued by the N.C. Department of Agriculture/United States Department of Agriculture. Have the certificate or limited permit accompany the article when it arrives at the project site.

Contact

Contact the N.C. Department of Agriculture/United States Department of Agriculture at 1-800-206-9333, 919-707-3730, or <https://www.ncagr.gov/plantindustry/Plant/quaran/table2.htm> to determine those specific project sites located in the quarantined area or for any regulated article used on this project originating in a quarantined county.

Regulated Articles Include

1. Soil, sand, gravel, compost, peat, humus, muck, and decomposed manure, separately or with other articles. This includes movement of articles listed above that may be associated with cut/waste, ditch pulling, and shoulder cutting.
2. Plants with roots including grass sod.
3. Plant crowns and roots.
4. Bulbs, corms, rhizomes, and tubers of ornamental plants.
5. Hay, straw, fodder, and plant litter of any kind.
6. Clearing and grubbing debris.
7. Used agricultural cultivating and harvesting equipment.
8. Used earth-moving equipment.
9. Any other products, articles, or means of conveyance, of any character, if determined by an inspector to present a hazard of spreading imported fire ant, gypsy moth, witchweed, emerald ash borer, guava root knot nematode, or other noxious weeds.

STANDARD SPECIAL PROVISION

MINIMUM WAGES

(7-21-09)

Z-5

FEDERAL: The Fair Labor Standards Act provides that with certain exceptions every employer shall pay wages at the rate of not less than SEVEN DOLLARS AND TWENTY FIVE CENTS (\$7.25) per hour.

STATE: The North Carolina Minimum Wage Act provides that every employer shall pay to each of his employees, wages at a rate of not less than SEVEN DOLLARS AND TWENTY FIVE CENTS (\$7.25) per hour.

The minimum wage paid to all skilled labor employed on this contract shall be SEVEN DOLLARS AND TWENTY FIVE CENTS (\$7.25) per hour.

The minimum wage paid to all intermediate labor employed on this contract shall be SEVEN DOLLARS AND TWENTY FIVE CENTS (\$7.25) per hour.

The minimum wage paid to all unskilled labor on this contract shall be SEVEN DOLLARS AND TWENTY FIVE CENTS (\$7.25) per hour.

This determination of the intent of the application of this act to the contract on this project is the responsibility of the Contractor.

The Contractor shall have no claim against the Department of Transportation for any changes in the minimum wage laws, Federal or State. It is the responsibility of the Contractor to keep fully informed of all Federal and State Laws affecting his contract.

STANDARD SPECIAL PROVISION

TITLE VI AND NONDISCRIMINATION:

(6-28-77)(Rev 6/19/2018)

Z-6

Revise the *2018 Standard Specifications* as follows:

Replace Article 103-4(B) with the following:

The North Carolina Department of Transportation is committed to carrying out the U.S. Department of Transportation's policy of ensuring nondiscrimination in the award and administration of contracts.

The provisions of this section related to United States Department of Transportation (US DOT) Order 1050.2A, Title 49 Code of Federal Regulations (CFR) part 21, 23 United States Code (U.S.C.) 140 and 23 CFR part 200 (or 49 CFR 303, 49 U.S.C. 5332 or 49 U.S.C. 47123) are applicable to all North Carolina Department of Transportation (NCDOT) contracts and to all related subcontracts, material supply, engineering, architectural and other service contracts, regardless of dollar amount. Any Federal provision that is specifically required not specifically set forth is hereby incorporated by reference.

(1) Title VI Assurances (USDOT Order 1050.2A, Appendix A)

During the performance of this contract, the contractor, for itself, its assignees, and successors in interest (hereinafter referred to as the "contractor") agrees as follows:

(a) Compliance with Regulations

The contractor (hereinafter includes consultants) shall comply with the Acts and the Regulations relative to Nondiscrimination in Federally-assisted programs of the U.S. Department of Transportation, Federal Highway Administration (FHWA), as they may be amended from time to time, which are herein incorporated by reference and made a part of this contract.

(b) Nondiscrimination

The contractor, with regard to the work performed by it during the contract, shall not discriminate on the grounds of race, color, or national origin in the selection and retention of subcontractors, including procurements of materials and leases of equipment. The contractor shall not participate directly or indirectly in the discrimination prohibited by the Acts and the Regulations, including employment practices when the contract covers any activity, project, or program set forth in Appendix B of 49 CFR Part 21.

(c) Solicitations for Subcontractors, Including Procurements of Materials and Equipment

In all solicitations, either by competitive bidding, or negotiation made by the contractor for work to be performed under a subcontract, including procurements of materials, or leases of equipment, each potential subcontractor or supplier shall be notified by the contractor of the contractor's obligations under this contract and the Acts and the Regulations relative to Nondiscrimination on the grounds of race, color, or national origin.

(d) Information and Reports

The contractor shall provide all information and reports required by the Acts, the Regulations, and directives issued pursuant thereto and shall permit access to its books,

records, accounts, other sources of information, and its facilities as may be determined by the Recipient or the FHWA to be pertinent to ascertain compliance with such Acts, Regulations, and instructions. Where any information required of a contractor is in the exclusive possession of another who fails or refuses to furnish the information, the contractor shall so certify to the Recipient or the FHWA, as appropriate, and shall set forth what efforts it has made to obtain the information.

(e) Sanctions for Noncompliance:

In the event of a contractor's noncompliance with the Non-discrimination provisions of this contract, the Recipient will impose such contract sanctions as it and/or the FHWA may determine to be appropriate, including, but not limited to:

- (i) Withholding payments to the contractor under the contract until the contractor complies; and/or
- (ii) Cancelling, terminating, or suspending a contract, in whole or in part.

(f) Incorporation of Provisions

The contractor shall include the provisions of paragraphs (a) through (f) in every subcontract, including procurements of materials and leases of equipment, unless exempt by the Acts, the Regulations and directives issued pursuant thereto. The contractor shall take action with respect to any subcontract or procurement as the Recipient or the FHWA may direct as a means of enforcing such provisions including sanctions for noncompliance. Provided, that if the contractor becomes involved in, or is threatened with litigation by a subcontractor, or supplier because of such direction, the contractor may request the Recipient to enter into any litigation to protect the interests of the Recipient. In addition, the contractor may request the United States to enter into the litigation to protect the interests of the United States.

(2) Title VI Nondiscrimination Program (23 CFR 200.5(p))

The North Carolina Department of Transportation (NCDOT) has assured the USDOT that, as a condition to receiving federal financial assistance, NCDOT will comply with Title VI of the Civil Rights Act of 1964 and all requirements imposed by Title 49 CFR part 21 and related nondiscrimination authorities to ensure that no person shall, on the ground of race, color, national origin, limited English proficiency, sex, age, or disability (including religion/creed or income-level, where applicable), be excluded from participation in, be denied the benefits of, or be subjected to discrimination under any programs, activities, or services conducted or funded by NCDOT. Contractors and other organizations under contract or agreement with NCDOT must also comply with Title VI and related authorities, therefore:

(a) During the performance of this contract or agreement, contractors (e.g., subcontractors, consultants, vendors, prime contractors) are responsible for complying with NCDOT's Title VI Program. Contractors are not required to prepare or submit Title VI Programs. To comply with this section, the prime contractor shall:

1. Post NCDOT's Notice of Nondiscrimination and the Contractor's own Equal Employment Opportunity (EEO) Policy in conspicuous locations accessible to all employees, applicants and subcontractors on the jobsite.
2. Physically incorporate the required Title VI clauses into all subcontracts on federally-assisted and state-funded NCDOT projects, and ensure inclusion by subcontractors into all lower-tier subcontracts.

3. Required Solicitation Language. The Contractor shall include the following notification in all solicitations for bids and requests for work or material, regardless of funding source:

“The North Carolina Department of Transportation, in accordance with the provisions of Title VI of the Civil Rights Act of 1964 (78 Stat. 252, 42 U.S.C. §§ 2000d to 2000d-4) and the Regulations, hereby notifies all bidders that it will affirmatively ensure that any contract entered into pursuant to this advertisement, disadvantaged business enterprises will be afforded full and fair opportunity to submit bids in response to this invitation and will not be discriminated against on the grounds of race, color, or national origin in consideration for an award. In accordance with other related nondiscrimination authorities, bidders and contractors will also not be discriminated against on the grounds of sex, age, disability, low-income level, creed/religion, or limited English proficiency in consideration for an award.”
 4. Physically incorporate the FHWA-1273, in its entirety, into all subcontracts and subsequent lower tier subcontracts on Federal-aid highway construction contracts only.
 5. Provide language assistance services (i.e., written translation and oral interpretation), free of charge, to LEP employees and applicants. Contact NCDOT OCR for further assistance, if needed.
 6. For assistance with these Title VI requirements, contact the NCDOT Title VI Nondiscrimination Program at 1-800-522-0453.
- (b) Subrecipients (e.g. cities, counties, LGAs, planning organizations) may be required to prepare and submit a Title VI Plan to NCDOT, including Title VI Assurances and/or agreements. Subrecipients must also ensure compliance by their contractors and subrecipients with Title VI. (23 CFR 200.9(b)(7))
- (c) If reviewed or investigated by NCDOT, the contractor or subrecipient agrees to take affirmative action to correct any deficiencies found within a reasonable time period, not to exceed 90 calendar days, unless additional time is granted by NCDOT. (23 CFR 200.9(b)(15))
- (d) The Contractor is responsible for notifying subcontractors of NCDOT’s External Discrimination Complaints Process.
1. Applicability
Title VI and related laws protect participants and beneficiaries (e.g., members of the public and contractors) from discrimination by NCDOT employees, subrecipients and contractors, regardless of funding source.
 2. Eligibility
Any person—or class of persons—who believes he/she has been subjected to discrimination based on race, color, national origin, Limited English Proficiency (LEP), sex, age, or disability (and religion in the context of employment, aviation, or transit) may file a written complaint. The law also prohibits intimidation or retaliation of any sort.
 3. Time Limits and Filing Options
Complaints may be filed by the affected individual(s) or a representative and must be filed no later than 180 calendar days after the following:
 - (i) The date of the alleged act of discrimination; or

- (ii) The date when the person(s) became aware of the alleged discrimination; or
- (iii) Where there has been a continuing course of conduct, the date on which that conduct was discontinued or the latest instance of the conduct.

Title VI and related discrimination complaints may be submitted to the following entities:

- North Carolina Department of Transportation, Office of Civil Rights, Title VI Program, 1511 Mail Service Center, Raleigh, NC 27699-1511; toll free 1-800-522-0453
 - Federal Highway Administration, North Carolina Division Office, 310 New Bern Avenue, Suite 410, Raleigh, NC 27601, 919-747-7010
 - US Department of Transportation, Departmental Office of Civil Rights, External Civil Rights Programs Division, 1200 New Jersey Avenue, SE, Washington, DC 20590; 202-366-4070
4. Format for Complaints
Complaints must be in writing and signed by the complainant(s) or a representative, and include the complainant's name, address, and telephone number. Complaints received by fax or e-mail will be acknowledged and processed. Allegations received by telephone will be reduced to writing and provided to the complainant for confirmation or revision before processing. Complaints will be accepted in other languages, including Braille.
 5. Discrimination Complaint Form
Contact NCDOT Civil Rights to receive a full copy of the Discrimination Complaint Form and procedures.
 6. Complaint Basis
Allegations must be based on issues involving race, color, national origin (LEP), sex, age, disability, or religion (in the context of employment, aviation or transit). "Basis" refers to the complainant's membership in a protected group category.

**TABLE 103-1
COMPLAINT BASIS**

| Protected Categories | Definition | Examples | Applicable Nondiscrimination Authorities |
|--|--|--|--|
| Race and Ethnicity | An individual belonging to one of the accepted racial groups; or the perception, based usually on physical characteristics that a person is a member of a racial group | Black/African American, Hispanic/Latino, Asian, American Indian/Alaska Native, Native Hawaiian/Pacific Islander, White | Title VI of the Civil Rights Act of 1964; 49 CFR Part 21; 23 CFR 200; 49 U.S.C. 5332(b); 49 U.S.C. 47123. <i>(Executive Order 13166)</i> |
| Color | Color of skin, including shade of skin within a racial group | Black, White, brown, yellow, etc. | |
| National Origin (<i>Limited English Proficiency</i>) | Place of birth. Citizenship is not a factor. (<i>Discrimination based on language or a person's accent is also covered</i>) | Mexican, Cuban, Japanese, Vietnamese, Chinese | |
| Sex | Gender. The sex of an individual. | Women and Men | 1973 Federal-Aid Highway Act; 49 U.S.C. 5332(b); |

| | | | |
|--|--|--|---|
| | <i>Note:</i> Sex under this program does not include sexual orientation. | | 49 U.S.C. 47123. |
| Age | Persons of any age | 21-year-old person | Age Discrimination Act of 1975 49 U.S.C. 5332(b); 49 U.S.C. 47123. |
| Disability | Physical or mental impairment, permanent or temporary, or perceived. | Blind, alcoholic, para-amputee, epileptic, diabetic, arthritic | Section 504 of the Rehabilitation Act of 1973; Americans with Disabilities Act of 1990 |
| Religion (in the context of employment) <i>(Religion/ Creed in all aspects of any aviation or transit-related construction)</i> | An individual belonging to a religious group; or the perception, based on distinguishable characteristics that a person is a member of a religious group. In practice, actions taken as a result of the moral and ethical beliefs as to what is right and wrong, which are sincerely held with the strength of traditional religious views. <i>Note:</i> Does not have to be associated with a recognized religious group or church; if an individual sincerely holds to the belief, it is a protected religious practice. | Muslim, Christian, Sikh, Hindu, etc. | Title VII of the Civil Rights Act of 1964; 23 CFR 230; FHWA-1273 Required Contract Provisions. <i>(49 U.S.C. 5332(b); 49 U.S.C. 47123)</i> |

(3) Pertinent Nondiscrimination Authorities

During the performance of this contract, the contractor, for itself, its assignees, and successors in interest agrees to comply with the following non-discrimination statutes and authorities, including, but not limited to:

- (a) Title VI of the Civil Rights Act of 1964 (42 U.S.C. § 2000d et seq., 78 stat. 252), (prohibits discrimination on the basis of race, color, national origin); and 49 CFR Part 21.
- (b) The Uniform Relocation Assistance and Real Property Acquisition Policies Act of 1970, (42 U.S.C. § 4601), (prohibits unfair treatment of persons displaced or whose property has been acquired because of Federal or Federal-aid programs and projects);
- (c) Federal-Aid Highway Act of 1973, (23 U.S.C. § 324 et seq.), (prohibits discrimination on the basis of sex);
- (d) Section 504 of the Rehabilitation Act of 1973, (29 U.S.C. § 794 et seq.), as amended, (prohibits discrimination on the basis of disability) and 49 CFR Part 27;
- (e) The Age Discrimination Act of 1975, as amended, (42 U.S.C. § 6101 et seq.), (prohibits discrimination on the basis of age);
- (f) Airport and Airway Improvement Act of 1982, (49 USC § 471, Section 47123), as amended, (prohibits discrimination based on race, creed, color, national origin, or sex);
- (g) The Civil Rights Restoration Act of 1987, (PL 100-209), (Broadened the scope, coverage and applicability of Title VI of the Civil Rights Act of 1964, The Age Discrimination Act of 1975 and Section 504 of the Rehabilitation Act of 1973, by expanding the definition of the terms "programs or activities" to include all of the programs or activities of the Federal-aid recipients, sub-recipients and contractors, whether such programs or activities are Federally funded or not);

- (h) Titles II and III of the Americans with Disabilities Act, which prohibit discrimination on the basis of disability in the operation of public entities, public and private transportation systems, places of public accommodation, and certain testing entities (42 U.S.C. §§ 12131-12189) as implemented by Department of Transportation regulations at 49 C.F.R. parts 37 and 38;
 - (i) The Federal Aviation Administration's Nondiscrimination statute (49 U.S.C. § 47123) (prohibits discrimination on the basis of race, color, national origin, and sex);
 - (j) Executive Order 12898, Federal Actions to Address Environmental Justice in Minority Populations and Low-Income Populations, which ensures Nondiscrimination against minority populations by discouraging programs, policies, and activities with disproportionately high and adverse human health or environmental effects on minority and low-income populations;
 - (k) Executive Order 13166, Improving Access to Services for Persons with Limited English Proficiency, and resulting agency guidance, national origin discrimination includes discrimination because of Limited English proficiency (LEP). To ensure compliance with Title VI, you must take reasonable steps to ensure that LEP persons have meaningful access to your programs (70 Fed. Reg. at 74087 to 74100);
 - (l) Title IX of the Education Amendments of 1972, as amended, which prohibits you from discriminating because of sex in education programs or activities (20 U.S.C. 1681 et seq).
 - (m) Title VII of the Civil Rights Act of 1964 (42 U.S.C. § 2000e et seq., Pub. L. 88-352), (prohibits employment discrimination on the basis of race, color, religion, sex, or national origin).
- (4) **Additional Title VI Assurances**

***The following Title VI Assurances (Appendices B, C and D) shall apply, as applicable*

- (a) Clauses for Deeds Transferring United States Property (1050.2A, Appendix B)
The following clauses will be included in deeds effecting or recording the transfer of real property, structures, or improvements thereon, or granting interest therein from the United States pursuant to the provisions of Assurance 4.

NOW, THEREFORE, the U.S. Department of Transportation as authorized by law and upon the condition that the North Carolina Department of Transportation (NCDOT) will accept title to the lands and maintain the project constructed thereon in accordance with the North Carolina General Assembly, the Regulations for the Administration of the Federal-Aid Highway Program, and the policies and procedures prescribed by the Federal Highway Administration of the U.S. Department of Transportation in accordance and in compliance with all requirements imposed by Title 49, Code of Federal Regulations, U.S. Department of Transportation, Subtitle A, Office of the Secretary, Part 21, Nondiscrimination in Federally-assisted programs of the U.S. Department of Transportation pertaining to and effectuating the provisions of Title VI of the Civil Rights Act of 1964 (78 Stat. 252; 42 U.S.C. § 2000d to 2000d-4), does hereby remise, release, quitclaim and convey unto the NCDOT all the right, title and interest of the U.S. Department of Transportation in and to said lands described in Exhibit A attached hereto and made a part hereof.

(HABENDUM CLAUSE)

TO HAVE AND TO HOLD said lands and interests therein unto the North Carolina Department of Transportation (NCDOT) and its successors forever, subject, however, to the covenants, conditions, restrictions and reservations herein contained as follows, which will remain in effect for the period during which the real property or structures are used for a purpose for which Federal financial assistance is extended or for another purpose involving the provision of similar services or benefits and will be binding on the NCDOT, its successors and assigns.

The NCDOT, in consideration of the conveyance of said lands and interests in lands, does hereby covenant and agree as a covenant running with the land for itself, its successors and assigns, that (1) no person will on the grounds of race, color, or national origin, be excluded from participation in, be denied the benefits of, or be otherwise subjected to discrimination with regard to any facility located wholly or in part on, over, or under such lands hereby conveyed [,] [and]* (2) that the NCDOT will use the lands and interests in lands and interests in lands so conveyed, in compliance with all requirements imposed by or pursuant to Title 49, Code of Federal Regulations, U.S. Department of Transportation, Subtitle A, Office of the Secretary, Part 21, Non-discrimination in Federally-assisted programs of the U.S. Department of Transportation, Effectuation of Title VI of the Civil Rights Act of 1964, and as said Regulations and Acts may be amended [, and (3) that in the event of breach of any of the above-mentioned nondiscrimination conditions, the Department will have a right to enter or re-enter said lands and facilities on said land, and that above described land and facilities will thereon revert to and vest in and become the absolute property of the U.S. Department of Transportation and its assigns as such interest existed prior to this instruction].*

(*Reverter clause and related language to be used only when it is determined that such a clause is necessary in order to make clear the purpose of Title VI.)

(b) Clauses for Transfer of Real Property Acquired or Improved Under the Activity, Facility, or Program (1050.2A, Appendix C)

The following clauses will be included in deeds, licenses, leases, permits, or similar instruments entered into by the North Carolina Department of Transportation (NCDOT) pursuant to the provisions of Assurance 7(a):

1. The (grantee, lessee, permittee, etc. as appropriate) for himself/herself, his/her heirs, personal representatives, successors in interest, and assigns, as a part of the consideration hereof, does hereby covenant and agree [in the case of deeds and leases add "as a covenant running with the land"] that:

- (i.) In the event facilities are constructed, maintained, or otherwise operated on the property described in this (deed, license, lease, permit, etc.) for a purpose for which a U.S. Department of Transportation activity, facility, or program is extended or for another purpose involving the provision of similar services or benefits, the (grantee, licensee, lessee, permittee, etc.) will maintain and operate such facilities and services in compliance with all requirements imposed by the Acts and Regulations (as may be amended) such that no person on the grounds of race, color, or national origin, will be excluded from participation in, denied the benefits of, or be otherwise subjected to discrimination in the use of said facilities.
2. With respect to licenses, leases, permits, etc., in the event of breach of any of the above Nondiscrimination covenants, the NCDOT will have the right to terminate the (lease, license, permit, etc.) and to enter, re-enter, and repossess said lands and facilities thereon, and hold the same as if the (lease, license, permit, etc.) had never been made or issued. *
 3. With respect to a deed, in the event of breach of any of the above Nondiscrimination covenants, the NCDOT will have the right to enter or re-enter the lands and facilities thereon, and the above described lands and facilities will there upon revert to and vest in and become the absolute property of the NCDOT and its assigns. *
(*Reverter clause and related language to be used only when it is determined that such a clause is necessary to make clear the purpose of Title VI.)
- (c) Clauses for Construction/Use/Access to Real Property Acquired Under the Activity, Facility or Program (1050.2A, Appendix D)
- The following clauses will be included in deeds, licenses, permits, or similar instruments/ agreements entered into by the North Carolina Department of Transportation (NCDOT) pursuant to the provisions of Assurance 7(b):
1. The (grantee, licensee, permittee, etc., as appropriate) for himself/herself, his/her heirs, personal representatives, successors in interest, and assigns, as a part of the consideration hereof, does hereby covenant and agree (in the case of deeds and leases add, "as a covenant running with the land") that (1) no person on the ground of race, color, or national origin, will be excluded from participation in, denied the benefits of, or be otherwise subjected to discrimination in the use of said facilities, (2) that in the construction of any improvements on, over, or under such land, and the furnishing of services thereon, no person on the ground of race, color, or national origin, will be excluded from participation in, denied the benefits of, or otherwise be subjected to discrimination, (3) that the (grantee, licensee, lessee, permittee, etc.) will use the premises in compliance with all other requirements imposed by or pursuant to the Acts and Regulations, as amended, set forth in this Assurance.
 2. With respect to (licenses, leases, permits, etc.), in the event of breach of any of the above Non- discrimination covenants, the NCDOT will have the right to terminate the (license, permit, etc., as appropriate) and to enter or re-enter and repossess said land and the facilities thereon, and hold the same as if said (license, permit, etc., as appropriate) had never been made or issued. *

3. With respect to deeds, in the event of breach of any of the above Nondiscrimination covenants, the NCDOT will there upon revert to and vest in and become the absolute property of the NCDOT and its assigns. *

(*Reverter clause and related language to be used only when it is determined that such a clause is necessary to make clear the purpose of Title VI.)

STANDARD SPECIAL PROVISION

ON-THE-JOB TRAINING

(10-16-07) (Rev. 4-21-15)

Z-10

Description

The North Carolina Department of Transportation will administer a custom version of the Federal On-the-Job Training (OJT) Program, commonly referred to as the Alternate OJT Program. All contractors (existing and newcomers) will be automatically placed in the Alternate Program. Standard OJT requirements typically associated with individual projects will no longer be applied at the project level. Instead, these requirements will be applicable on an annual basis for each contractor administered by the OJT Program Manager.

On the Job Training shall meet the requirements of 23 CFR 230.107 (b), 23 USC – Section 140, this provision and the On-the-Job Training Program Manual.

The Alternate OJT Program will allow a contractor to train employees on Federal, State and privately funded projects located in North Carolina. However, priority shall be given to training employees on NCDOT Federal-Aid funded projects.

Minorities and Women

Developing, training and upgrading of minorities and women toward journeyman level status is a primary objective of this special training provision. Accordingly, the Contractor shall make every effort to enroll minority and women as trainees to the extent that such persons are available within a reasonable area of recruitment. This training commitment is not intended, and shall not be used, to discriminate against any applicant for training, whether a member of a minority group or not.

Assigning Training Goals

The Department, through the OJT Program Manager, will assign training goals for a calendar year based on the contractors' past three years' activity and the contractors' anticipated upcoming year's activity with the Department. At the beginning of each year, all contractors eligible will be contacted by the Department to determine the number of trainees that will be assigned for the upcoming calendar year. At that time the Contractor shall enter into an agreement with the Department to provide a self-imposed on-the-job training program for the calendar year. This agreement will include a specific number of annual training goals agreed to by both parties. The number of training assignments may range from 1 to 15 per contractor per calendar year. The Contractor shall sign an agreement to fulfill their annual goal for the year.\

Training Classifications

The Contractor shall provide on-the-job training aimed at developing full journeyman level workers in the construction craft/operator positions. Preference shall be given to providing training in the following skilled work classifications:

| | |
|---------------------|----------------------------------|
| Equipment Operators | Office Engineers |
| Truck Drivers | Estimators |
| Carpenters | Iron / Reinforcing Steel Workers |
| Concrete Finishers | Mechanics |
| Pipe Layers | Welders |

The Department has established common training classifications and their respective training requirements that may be used by the contractors. However, the classifications established are not all-inclusive. Where the training is oriented toward construction applications, training will be allowed in lower-level management positions such as office engineers and estimators. Contractors shall submit new classifications for specific job functions that their employees are performing. The Department will review and recommend for acceptance to FHWA the new classifications proposed by contractors, if applicable. New classifications shall meet the following requirements:

Proposed training classifications are reasonable and realistic based on the job skill classification needs, and

The number of training hours specified in the training classification is consistent with common practices and provides enough time for the trainee to obtain journeyman level status.

The Contractor may allow trainees to be trained by a subcontractor provided that the Contractor retains primary responsibility for meeting the training and this provision is made applicable to the subcontract. However, only the Contractor will receive credit towards the annual goal for the trainee.

Where feasible, 25 percent of apprentices or trainees in each occupation shall be in their first year of apprenticeship or training. The number of trainees shall be distributed among the work classifications on the basis of the contractor's needs and the availability of journeymen in the various classifications within a reasonable area of recruitment.

No employee shall be employed as a trainee in any classification in which they have successfully completed a training course leading to journeyman level status or in which they have been employed as a journeyman.

Records and Reports

The Contractor shall maintain enrollment, monthly and completion reports documenting company compliance under these contract documents. These documents and any other information as requested shall be submitted to the OJT Program Manager.

Upon completion and graduation of the program, the Contractor shall provide each trainee with a certification Certificate showing the type and length of training satisfactorily completed.

Trainee Interviews

All trainees enrolled in the program will receive an initial and Trainee/Post graduate interview conducted by the OJT program staff.

Trainee Wages

Contractors shall compensate trainees on a graduating pay scale based upon a percentage of the prevailing minimum journeyman wages (Davis-Bacon Act). Minimum pay shall be as follows:

| | |
|------------|---|
| 60 percent | of the journeyman wage for the first half of the training period |
| 75 percent | of the journeyman wage for the third quarter of the training period |
| 90 percent | of the journeyman wage for the last quarter of the training period |

In no instance shall a trainee be paid less than the local minimum wage. The Contractor shall adhere to the minimum hourly wage rate that will satisfy both the NC Department of Labor (NCDOL) and the Department.

Achieving or Failing to Meet Training Goals

The Contractor will be credited for each trainee employed by him on the contract work who is currently enrolled or becomes enrolled in an approved program and who receives training for at least 50 percent of the specific program requirement. Trainees will be allowed to be transferred between projects if required by the Contractor's scheduled workload to meet training goals.

If a contractor fails to attain their training assignments for the calendar year, they may be taken off the NCDOT's Bidders List.

Measurement and Payment

No compensation will be made for providing required training in accordance with these contract documents.

LISTING OF MBE/WBE SUBCONTRACTORS

Sheet of

| Firm Name and Address | Circle One | Item No. | Item Description | * Agreed upon Unit Price | ** Dollar Volume of Item |
|----------------------------|----------------|----------|------------------|--------------------------|--------------------------|
| Name Address | MBE WBE | | | | |
| Name Address | MBE WBE | | | | |
| Name Address | MBE WBE | | | | |
| Name Address | MBE WBE | | | | |
| Name Address | MBE WBE | | | | |
| Name Address | MBE WBE | | | | |

* The Dollar Volume shown in this column shall be the Actual Price Agreed Upon by the Prime Contractor and the MBE/WBE subcontractor, and these prices will be used to determine the percentage of the MBE/WBE participation in the contract.

** Dollar Volume of MBE/WBE Subcontractor Percentage of Total Contract Bid Price:

If firm is a Material Supplier Only, show Dollar Volume as 60% of Agreed Upon Amount from Letter of Intent.

If firm is a Manufacturer, show Dollar Volume as 100% of Agreed Upon Amount from Letter of Intent.

LISTING OF MBE/WBE SUBCONTRACTORS

Sheet _____ of _____

| Firm Name and Address | Circle One | Item No. | Item Description | * Agreed upon Unit Price | ** Dollar Volume of Item |
|-----------------------|----------------|----------|------------------|--------------------------|--------------------------|
| Name Address | MBE WBE | | | | |
| Name Address | MBE WBE | | | | |
| Name Address | MBE WBE | | | | |
| Name Address | MBE WBE | | | | |
| Name Address | MBE WBE | | | | |

**** Dollar Volume of MBE Subcontractor \$ _____**

MBE Percentage of Total Contract Bid Price _____%

**** Dollar Volume of WBE Subcontractor \$ _____**

WBE Percentage of Total Contract Bid Price _____%

***The Dollar Volume shown in this column shall be the Actual Price Agreed Upon by the Prime Contractor and the MBE/WBE subcontractor, and these prices will be used to determine the percentage of the MBE/WBE participation in the contract.**

**** Dollar Volume of MBE/WBE Subcontractor Percentage of Total Contract Bid Price.**

If firm is a Material Supplier Only, show Dollar Volume as 60% of Agreed Upon Amount from Letter of Intent.

If firm is a Manufacturer, show Dollar Volume as 100% of Agreed Upon Amount from Letter of Intent.

AWARD LIMITS ON MULTIPLE PROJECTS

It is the desire of the Proposer to be awarded contracts, the value of which will not exceed a total of \$ _____, for those projects indicated below on which bids are being opened on the same date as shown in the Proposal Form. Individual projects shall be indicated by placing the project number and county in the appropriate place below. Projects not selected will not be subject to an award limit.

(Project Number)

(County)

(Project Number)

(County)

(Project Number)

(County)

(Project Number)

(County)

*If a Proposer desires to limit the total amount of work awarded to him in this letting, he shall state such limit in the space provided above in the second line of this form.

It is agreed that in the event that I am (we are) the successful bidder on indicated projects, the total value of which is more that the above stipulated award limits, the Board of Transportation will award me (us) projects from among those indicated which have a total value not exceeding the award limit and which will result in the best advantage to the Department of Transportation.

**Signature of Authorized Person

**Only those persons authorized to sign bids under the provisions of Article 102-8, Item 7, shall be authorized to sign this form.

County: NASH

| Line # | Item Number | Sec # | Description | Quantity | Unit Cost | Amount |
|----------------------|--------------|-------|--|---------------|-----------|--------|
| ROADWAY ITEMS | | | | | | |
| 0001 | 0000100000-N | 800 | MOBILIZATION | Lump Sum | L.S. | |
| 0002 | 1220000000-E | 545 | INCIDENTAL STONE BASE | 185 TON | | |
| 0003 | 1297000000-E | 607 | MILLING ASPHALT PAVEMENT, **** DEPTH (1.5") | 4,215 SY | | |
| 0004 | 1330000000-E | 607 | INCIDENTAL MILLING | 1,500 SY | | |
| 0005 | 1519000000-E | 610 | ASPHALT CONC SURFACE COURSE, TYPE S9.5B | 13,565 TON | | |
| 0006 | 1575000000-E | 620 | ASPHALT BINDER FOR PLANT MIX | 916 TON | | |
| 0007 | 1704000000-E | SP | PATCHING EXISTING PAVEMENT | 150 TON | | |
| 0008 | 2605000000-N | 848 | CONCRETE CURB RAMPS | 4 EA | | |
| 0009 | 4413000000-E | SP | WORK ZONE ADVANCE/GENERAL WARNING SIGNING | 716 SF | | |
| 0010 | 4457000000-N | SP | TEMPORARY TRAFFIC CONTROL | Lump Sum | L.S. | |
| 0011 | 4840000000-N | 1205 | PAINT PAVEMENT MARKING CHARACTER | 96 EA | | |
| 0012 | 4845000000-N | 1205 | PAINT PAVEMENT MARKING SYMBOL | 14 EA | | |
| 0013 | 4890000000-E | SP | GENERIC PAVEMENT MARKING ITEM HOT SPRAY THERMOPLASTIC PM LINES (4", 50 MILS) | 230,584 LF | | |

0915/May19/Q251947/D34695100000/E13

Total Amount Of Bid For Entire Project :

DD00423
2023CPT.04.21.20641, 48184.01K

NASH COUNTY

Execution of Contract

Contract No: DD00423

County: NASH COUNTY

ACCEPTED BY THE DEPARTMENT

Proposals Engineer

Date

EXECUTION OF CONTRACT AND BONDS
APPROVED AS TO FORM:

for **Division Engineer**

Date

Signature Sheet (Bid) - ACCEPTANCE SHEET