

STATE OF NORTH CAROLINA
DEPARTMENT OF TRANSPORTATION
HIGHWAY DIVISION 4

PROPOSAL

DATE AND TIME OF BID OPENING: June 25, 2024 AT 2:00 PM

CONTRACT ID: DD00463

WBS ELEMENT NO.: 2024CPT.04.17.20511

FEDERAL AID NO.: STATE FUNDED

COUNTY: JOHNSTON COUNTY

TIP NO.: N/A

MILES: 32.35

ROUTE NO.: VARIOUS

LOCATION: 13 SECTIONS OF SECONDARY ROUTES

★ **TYPE OF WORK:** RESURFACING ★

NOTICE:

ALL BIDDERS SHALL COMPLY WITH ALL APPLICABLE LAWS REGULATING THE PRACTICE OF GENERAL CONTRACTING AS CONTAINED IN CHAPTER 87 OF THE GENERAL STATUTES OF NORTH CAROLINA WHICH REQUIRES THE BIDDER TO BE LICENSED BY THE N.C. LICENSING BOARD FOR CONTRACTORS WHEN BIDDING ON ANY NON-FEDERAL AID PROJECT WHERE THE BID IS \$30,000 OR MORE, EXCEPT FOR CERTAIN SPECIALTY WORK AS DETERMINED BY THE LICENSING BOARD. BIDDERS SHALL ALSO COMPLY WITH ALL OTHER APPLICABLE LAWS REGULATING THE PRACTICES OF ELECTRICAL, PLUMBING, HEATING AND AIR CONDITIONING AND REFRIGERATION CONTRACTING AS CONTAINED IN CHAPTER 87 OF THE GENERAL STATUTES OF NORTH CAROLINA. NOTWITHSTANDING THESE LIMITATIONS ON BIDDING, THE BIDDER WHO IS AWARDED ANY FEDERAL - AID FUNDED PROJECT SHALL COMPLY WITH CHAPTER 87 OF THE GENERAL STATUTES OF NORTH CAROLINA FOR LICENSING REQUIREMENTS WITHIN 60 CALENDAR DAYS OF BID OPENING.

THIS IS A ROADWAY PROJECT.

BID BOND IS REQUIRED.

NAME OF BIDDER

ADDRESS OF BIDDER

**PROPOSAL FOR THE CONSTRUCTION OF
CONTRACT No. DD00463 IN JOHNSTON COUNTY, NORTH CAROLINA
DEPARTMENT OF TRANSPORTATION,
WILSON, NORTH CAROLINA**

The Bidder has carefully examined the location of the proposed work to be known as Contract No. **DD00463**; has carefully examined the plans and specifications, which are acknowledged to be part of the proposal, the special provisions, the proposal, the form of contract, and the forms of contract payment bond and contract performance bond; and thoroughly understands the stipulations, requirements and provisions. The undersigned bidder agrees to bound upon his execution of the bid and subsequent award to him by the Department of Transportation in accordance with this proposal to provide the necessary contract payment bond and contract performance bond within fourteen days after the written notice of award is received by him. The undersigned Bidder further agrees to provide all necessary machinery, tools, labor, and other means of construction; and to do all the work and to furnish all materials, except as otherwise noted, necessary to perform and complete the said contract in accordance with the *2024 Standard Specifications for Roads and Structures* by the dates(s) specified in the Project Special Provisions and in accordance with the requirements of the Engineer, and at the unit or lump sum prices, as the case may be, for the various items given on the sheets contained herein.

The Bidder shall provide and furnish all the materials, machinery, implements, appliances and tools, and perform the work and required labor to construct and complete Contract No. **DD00463 in Johnston County**, for the unit or lump sum prices, as the case may be, bid by the Bidder in his bid and according to the proposal, plans, and specifications prepared by said Department, which proposal, plans, and specifications show the details covering this project, and hereby become a part of this contract.

The published volume entitled *North Carolina Department of Transportation, Raleigh, Standard Specifications for Roads and Structures, January 2024* with all amendments and supplements thereto, is by reference incorporated into and made a part of this contract; that, except as herein modified, all the construction and work included in this contract is to be done in accordance with the specifications contained in said volume, and amendments and supplements thereto, under the direction of the Engineer.

If the proposal is accepted and the award is made, the contract is valid only when signed either by the Contract Officer or such other person as may be designated by the Secretary to sign for the Department of Transportation. The conditions and provisions herein cannot be changed except over the signature of the said Contract Officer or Division Engineer.

The quantities shown in the itemized proposal for the project are considered to be approximate only and are given as the basis for comparison of bids. The Department of Transportation may increase or decrease the quantity of any item or portion of the work as may be deemed necessary or expedient.

An increase or decrease in the quantity of an item will not be regarded as sufficient ground for an increase or decrease in the unit prices, nor in the time allowed for the completion of the work, except as provided for the contract.

Accompanying this bid is a bid bond secured by a corporate surety, or certified check payable to the order of the Department of Transportation, for five percent of the total bid price, which deposit is to be forfeited as liquidated damages in case this bid is accepted and the Bidder shall fail to provide the required payment and performance bonds with the Department of Transportation, under the condition of this proposal, within 14 calendar days after the written notice of award is received by him, as provided in the *Standard Specifications*; otherwise said deposit will be returned to the Bidder.

TABLE OF CONTENTS

COVER SHEET
PROPOSAL SHEET

PROJECT SPECIAL PROVISIONS

BOND REQUIREMENTS:	G-1
CONTRACT TIME AND LIQUIDATED DAMAGES:	G-1
INTERMEDIATE CONTRACT TIME NUMBER 1 AND LIQUIDATED DAMAGES:	G-1
INTERMEDIATE CONTRACT TIME NUMBER 2 AND LIQUIDATED DAMAGES:	G-2
INTERMEDIATE CONTRACT TIME NUMBER 3 AND LIQUIDATED DAMAGES:	G-2
INTERMEDIATE CONTRACT TIME NUMBER 4 AND LIQUIDATED DAMAGES:	G-2
INTERMEDIATE CONTRACT TIME NUMBER 5 AND LIQUIDATED DAMAGES:	G-3
PROSECUTION OF WORK:.....	G-4
NO MAJOR CONTRACT ITEMS:.....	G-4
NO SPECIALTY ITEMS:	G-4
FUEL PRICE ADJUSTMENT:.....	G-5
MINORITY BUSINESS ENTERPRISE AND WOMEN BUSINESS ENTERPRISE (DIVISIONS):.....	G-6
RESTRICTIONS ON ITS EQUIPMENT AND SERVICES:.....	G-21
USE OF UNMANNED AIRCRAFT SYSTEM (UAS):	G-22
EQUIPMENT IDLING GUIDELINES:.....	G-22
OUTSOURCING OUTSIDE THE USA:.....	G-23
ROADWAY	R-1
SUMMARY OF QUANTITIES, TYPICAL SECTIONS, DETAILS, MAPS	R-6

UNIT PROJECT SPECIAL PROVISIONS

TRAFFIC CONTROL	TC-1
-----------------------	------

STANDARD SPECIAL PROVISIONS

AVAILABILITY OF FUNDS – TERMINATION OF CONTRACTS	SSP-1
ERRATA.....	SSP-2
PLANT AND PEST QUARANTINES	SSP-3
MINIMUM WAGES	SSP-4
TITLE VI AND NONDISCRIMINATION:	SSP-5
ON-THE-JOB TRAINING.....	SSP-14

PROPOSAL ITEM SHEET AND SIGNATURE SHEETS

INSTRUCTIONS TO BIDDERS

PLEASE READ ALL INSTRUCTIONS CAREFULLY BEFORE PREPARING AND SUBMITTING YOUR BID.

All bids shall be prepared and submitted in accordance with the following requirements. Failure to comply with any requirement may cause the bid to be considered irregular and may be grounds for rejection of the bid.

For preparing and submitting the bid electronically, refer to Article 102-8(B) of the *Standard Specifications*.

Bidders that bid electronically on Raleigh Central-Let projects will need a separate Digital Signature from the approved electronic bidding provider for Division Contracts.

ELECTRONIC ON-LINE BID:

1. Download entire proposal from Connect NCDOT website. Download the electronic submittal file from the approved electronic bidding provider website.
2. In accordance with Article 102-3 of the Standard Specifications, registration on the Interested Parties List is required unless SP1 G02 Interested Parties List Not Required provision is included in the proposal.
3. Prepare and submit the electronic submittal file using the approved electronic bidding provider software.
4. Electronic bidding software necessary for electronic bid preparation may be downloaded from the Bid Express website following the directions at: <https://connect.ncdot.gov/letting/Pages/Electronic-Bidding.aspx>.
5. Questions should be emailed 7 calendar days prior to the bid opening to **Vickie P. Gardner** at **vpgardner@ncdot.gov**. Contact with any other NCDOT personnel concerning this project is strictly prohibited, unless otherwise noted, and may result in bids being considered non-responsive.

PROJECT SPECIAL PROVISIONS

GENERAL

BOND REQUIREMENTS:

(6-1-16)(Rev.1-16-24)

102-8, 102-10

SPD 01-420A

A Bid Bond is required in accordance with Article 102-10 of the *Standard Specifications for Roads and Structures*.

Contract Payment and Performance Bonds are required in accordance with Article 103-7 of the *Standard Specifications*.

CONTRACT TIME AND LIQUIDATED DAMAGES:

(7-1-95) (Rev. 12-18-07)

108

SP1 G10 A

The date of availability for this contract is **August 5, 2024**.

The completion date for this contract is **May 1, 2026**.

Except where otherwise provided by the contract, observation periods required by the contract will not be a part of the work to be completed by the completion date and/or intermediate contract times stated in the contract. The acceptable completion of the observation periods that extend beyond the final completion date shall be a part of the work covered by the performance and payment bonds.

The liquidated damages for this contract are **One Thousand One Hundred Dollars (\$1,100.00)** per calendar day.

INTERMEDIATE CONTRACT TIME NUMBER 1 AND LIQUIDATED DAMAGES:

(6-18-13)

108

Except for final/long life pavement markings, the Contractor will be required to complete all work included in this contract and shall place and maintain traffic on same.

The date of availability for this intermediate contract time is **August 5, 2024**.

The completion date for this intermediate contract time is **April 3, 2026**.

The liquidated damages are **One Thousand One Hundred Dollars (\$1,100.00)** per calendar day.

INTERMEDIATE CONTRACT TIME NUMBER 2 AND LIQUIDATED DAMAGES:

108

The Contractor shall adhere to the time limitations for replacement of pavement markings provided by the Contract and Standard Specifications as applicable for each map given the facility and marking type.

The date of availability for this intermediate contract time for each facility type and pavement marking type will be the date when the Contractor elects to obliterate or overlay the existing markings on any particular map or portion thereof.

The completion date for this intermediate contract time for pavement marking replacement will replacement deadline date based on facility type and marking type governed by the Contract and Standard Specifications after the date of availability.

The liquidated damages are **One Thousand One Hundred Dollars (\$1,100.00)** per calendar day.

INTERMEDIATE CONTRACT TIME NUMBER 3 AND LIQUIDATED DAMAGES:

(2-20-07) (Rev. 6-18-13)

108

SP1 G14 H

The Contractor shall complete all work required of the following maps and shall place and maintain traffic on same.

**Map #3 – School Zone
From Glen Laurel RD to Heathgreen Drive**

**Map #5 – School Zone
From Buffalo RD to Archers Way**

The date of availability for this intermediate contract time is **June 2, 2025**.

The completion date for this intermediate contract time is **August 1, 2025**.

The liquidated damages are **One Thousand One Hundred Dollars (\$1,100.00)** per calendar day.

Note: This ICT will not apply to Map #3 and Map#5 if the Contractor chooses to complete this work at night.

INTERMEDIATE CONTRACT TIME NUMBER 4 AND LIQUIDATED DAMAGES:

(5-21-13)

108

SP1 G14 I

The Contractor shall complete the work required of installing each new inductive loop after the removal of each existing loop by the milling, patching or resurfacing operations and shall place and maintain traffic on same.

The date of availability for this intermediate contract time for each inductive loop installation will be the date when the Contractor elects to disturb the existing inductive loop.

The completion date for this intermediate contract time for each inductive loop installation will be the date which is seven (7) consecutive calendar days after the date of availability.

The liquidated damages are **Five Hundred Dollars (\$500.00)** per calendar day.

INTERMEDIATE CONTRACT TIME NUMBER 5 AND LIQUIDATED DAMAGES:

(2-20-07)

108

SP1 G14 A

The Contractor shall complete the required work of installing, maintaining, and removing the traffic control devices for lane closures and restoring traffic to the existing traffic pattern. The Contractor shall not close or narrow a lane of traffic on **the following Maps** during the following time restrictions:

DAY AND TIME RESTRICTIONS

All Maps Except Map #3 and Map#5
Monday thru Sunday 9:00PM to 6:00AM

In addition, the Contractor shall not close or narrow a lane of traffic on **Any Map**, detain and/or alter the traffic flow on or during holidays, holiday weekends, special events, or any other time when traffic is unusually heavy, including the following schedules:

HOLIDAY AND HOLIDAY WEEKEND LANE CLOSURE RESTRICTIONS

1. For **unexpected occurrence** that creates unusually high traffic volumes, as directed by the Engineer.
2. For **New Year's Day**, between the hours of **6:00am** December 31st and **7:00pm** January 2nd. If New Year's Day is on a Friday, Saturday, Sunday or Monday, then until **7:00pm** the following Tuesday.
3. For **Easter**, between the hours of **6:00am** Thursday and **7:00pm** Monday.
4. For **Memorial Day**, between the hours of **6:00am** Friday and **7:00pm** Tuesday.
5. For **Independence Day**, between the hours of **6:00 a.m.** the day before Independence Day and **7:00 p.m.** the day after Independence Day.

If **Independence Day** is on a Friday, Saturday, Sunday or Monday, then between the hours of **6:00 a.m.** the Thursday before Independence Day and **7:00 p.m.** the Tuesday after Independence Day.

6. For **Labor Day**, between the hours of **6:00am** Friday and **7:00pm** Tuesday.
7. For **Thanksgiving Day**, between the hours of **6:00am** Tuesday and **7:00pm** Monday.

8. For **Christmas**, between the hours of **6:00am** the Friday before the week of Christmas Day and **7:00pm** the following Tuesday after the week of Christmas Day.

Holidays and holiday weekends shall include New Year's, Easter, Memorial Day, Independence Day, Labor Day, Thanksgiving, and Christmas. The Contractor shall schedule his work so that lane closures will not be required during these periods, unless otherwise directed by the Engineer.

The time of availability for this intermediate contract work shall be the time the Contractor begins to install all traffic control devices for lane closures according to the time restrictions listed herein.

The completion time for this intermediate contract work shall be the time the Contractor is required to complete the removal of all traffic control devices for lane closures according to the time restrictions stated above and place traffic in the existing traffic pattern.

The liquidated damages are **One Thousand Dollars (\$1,000.00)** per hour.

PROSECUTION OF WORK:

(7-1-95) (Rev. 8-21-12)

108

SP1 G15R

The Contractor will be required to prosecute the work in a continuous and uninterrupted manner from the time he begins the work until completion and final acceptance of the project. The Contractor will not be permitted to suspend his operations except for reasons beyond his control or except where the Engineer has authorized a suspension of the Contractor's operations in writing.

In the event that the Contractor's operations are suspended in violation of the above provisions, the sum of **\$500.00** will be charged the Contractor for each and every calendar day that such suspension takes place. The said amount is hereby agreed upon as liquidated damages due to extra engineering and maintenance costs and due to increased public hazard resulting from a suspension of the work. Liquidated damages chargeable due to suspension of the work will be additional to any liquidated damages that may become chargeable due to failure to complete the work on time.

NO MAJOR CONTRACT ITEMS:

(2-19-02) (Rev. 8-21-07)

104

SP1 G31

None of the items included in this contract will be major items.

NO SPECIALTY ITEMS:

(7-1-95)(Rev. 1-16-24)

108-6

SP1 G34

None of the items included in this contract will be specialty items (see Article 108-6 of the *Standard Specifications*).

FUEL PRICE ADJUSTMENT:

(11-15-05)(Rev. 1-16-24)

109-8

SP1 G43

Page 1-82, Article 109-8, FUEL PRICE ADJUSTMENTS, add the following:

The base index price for DIESEL #2 FUEL is **\$2.6456** per gallon. Where any of the following are included as pay items in the contract, they will be eligible for fuel price adjustment.

The pay items and the fuel factor used in calculating adjustments to be made will be as follows:

Description	Units	Fuel Usage Factor Diesel
Unclassified Excavation	Gal/CY	0.29
Borrow Excavation	Gal/CY	0.29
Class IV Subgrade Stabilization	Gal/Ton	0.55
Aggregate Base Course	Gal/Ton	0.55
Sub-Ballast	Gal/Ton	0.55
Erosion Control Stone	Gal/Ton	0.55
Rip Rap, Class	Gal/Ton	0.55
Asphalt Concrete Base Course, Type	Gal/Ton	0.90 or 2.90
Asphalt Concrete Intermediate Course, Type	Gal/Ton	0.90 or 2.90
Asphalt Concrete Surface Course, Type _____	Gal/Ton	0.90 or 2.90
Open-Graded Asphalt Friction Course	Gal/Ton	0.90 or 2.90
Permeable Asphalt Drainage Course, Type _____	Gal/Ton	0.90 or 2.90
Sand Asphalt Surface Course, Type _____	Gal/Ton	0.90 or 2.90
Ultra-thin Bonded Wearing Course	Gal/Ton	0.90 or 2.90
Aggregate for Cement Treated Base Course	Gal/Ton	0.55
Portland Cement for Cement Treated Base Course	Gal/Ton	0.55
> 11" Portland Cement Concrete Pavement	Gal/SY	0.327
Concrete Shoulders Adjacent to > 11" Pavement	Gal/SY	0.327
9" to 11" Portland Cement Concrete Pavement	Gal/SY	0.272
Concrete Shoulders Adjacent to 9" to 11" Pavement	Gal/SY	0.272
< 9" Portland Cement Concrete Pavement	Gal/SY	0.245
Concrete Shoulders Adjacent to < 9" Pavement	Gal/SY	0.245

For the asphalt items noted in the chart as eligible for fuel adjustments, the bidder may include the *Fuel Usage Factor Adjustment Form* with their bid submission if they elect to use the fuel usage factor. The *Fuel Usage Factor Adjustment Form* is found at the following link:

<https://connect.ncdot.gov/letting/LetCentral/Fuel%20Usage%20Factor%20Adjustment%20Form%20-%20Starting%20Nov%202022%20Lettings.pdf>

Select either 2.90 Gal/Ton fuel factor or 0.90 Gal/Ton fuel factor for each asphalt line item on the *Fuel Usage Factor Adjustment Form*. The selected fuel factor for each asphalt item will remain in effect for the duration of the contract.

Failure to complete the *Fuel Usage Factor Adjustment Form* will result in using 2.90 gallons per ton as the Fuel Usage Factor for Diesel for the asphalt items noted above. The contractor will not be permitted to change the Fuel Usage Factor after the bids are submitted.

MINORITY BUSINESS ENTERPRISE AND WOMEN BUSINESS ENTERPRISE (DIVISIONS):

(10-16-07)(Rev. 1-16-24)

102-15(J)

SP1 G67

Description

The purpose of this Special Provision is to carry out the North Carolina Department of Transportation's policy of ensuring nondiscrimination in the award and administration of contracts financed in whole or in part with State funds.

Definitions

Additional MBE/WBE Subcontractors - Any MBE/WBE submitted at the time of bid that will not be used to meet the Combined MBE/WBE goal. No submittal of a Letter of Intent is required.

Combined MBE/WBE Goal: A portion of the total contract, expressed as a percentage that is to be performed by committed MBE/WBE subcontractors.

Committed MBE/WBE Subcontractor - Any MBE/WBE submitted at the time of bid that is being used to meet the Combined MBE / WBE goal by submission of a Letter of Intent. Or any MBE or WBE used as a replacement for a previously committed MBE or WBE firm.

Contract Goal Requirement - The approved participation at time of award, but not greater than the advertised Combined MBE/WBE contract goal.

Goal Confirmation Letter - Written documentation from the Department to the bidder confirming the Contractor's approved, committed participation along with a listing of the committed MBE and WBE firms.

Manufacturer - A firm that operates or maintains a factory or establishment that produces on the premises, the materials or supplies obtained by the Contractor.

MBE Participation (Anticipated) - A portion of the total contract, expressed as a percentage that is anticipated to be performed by committed MBE subcontractor(s).

Minority Business Enterprise (MBE) - A firm certified as a Disadvantaged Minority-Owned Business Enterprise through the North Carolina Unified Certification Program.

Regular Dealer - A firm that owns, operates, or maintains a store, warehouse, or other establishment in which the materials or supplies required for the performance of the contract are bought, kept in stock, and regularly sold to the public in the usual course of business. A regular dealer engages in, as its principal business and in its own name, the purchase and sale or lease of the products in question. A regular dealer in such bulk items as steel, cement, gravel, stone, and

petroleum products need not keep such products in stock, if it owns and operates distribution equipment for the products. Brokers and packagers are not regarded as manufacturers or regular dealers within the meaning of this section.

Replacement / Substitution – A full or partial reduction in the amount of work subcontracted to a committed (or an approved substitute) MBE/WBE firm.

North Carolina Unified Certification Program (NCUCP) - A program that provides comprehensive services and information to applicants for MBE/WBE certification. The MBE/WBE program follows the same regulations as the federal Disadvantaged Business Enterprise (DBE) program in accordance with 49 CFR Part 26.

United States Department of Transportation (USDOT) - Federal agency responsible for issuing regulations (49 CFR Part 26) and official guidance for the DBE program.

WBE Participation (Anticipated) - A portion of the total contract, expressed as a percentage that is anticipated to be performed by committed WBE subcontractor(s).

Women Business Enterprise (WBE) - A firm certified as a Disadvantaged Women-Owned Business Enterprise through the North Carolina Unified Certification Program.

Forms and Websites Referenced in this Provision

Payment Tracking System - On-line system in which the Contractor enters the payments made to MBE and WBE subcontractors who have performed work on the project.
<https://apps.dot.state.nc.us/Vendor/PaymentTracking/>

DBE-IS Subcontractor Payment Information - Form for reporting the payments made to all MBE/WBE firms working on the project. This form is for paper bid projects only.
<https://connect.ncdot.gov/business/Turnpike/Documents/Form%20DBE-IS%20Subcontractor%20Payment%20Information.pdf>

RF-1 MBE/WBE Replacement Request Form - Form for replacing a committed MBE or WBE.
<https://connect.ncdot.gov/projects/construction/Construction%20Forms/DBE%20MBE%20WBE%20Replacement%20Form%20and%20Instructions.pdf>

SAF Subcontract Approval Form - Form required for approval to sublet the contract.
<https://connect.ncdot.gov/projects/construction/Construction%20Forms/SAF%20Form%20-%20Subcontract%20Approval%20Form%20Revised%2004-19.xlsm>

JC-1 Joint Check Notification Form - Form and procedures for joint check notification. The form acts as a written joint check agreement among the parties providing full and prompt disclosure of the expected use of joint checks.
<http://connect.ncdot.gov/projects/construction/Construction%20Forms/Joint%20Check%20Notification%20Form.pdf>

Letter of Intent - Form signed by the Contractor and the MBE/WBE subcontractor, manufacturer or regular dealer that affirms that a portion of said contract is going to be performed by the

signed MBE/WBE for the estimated amount (based on quantities and unit prices) listed at the time of bid.

<http://connect.ncdot.gov/letting/LetCentral/Letter%20of%20Intent%20to%20Perform%20as%20a%20Subcontractor.pdf>

Listing of MBE and WBE Subcontractors Form - Form for entering MBE/WBE subcontractors on a project that will meet the Combined MBE/WBE goal. This form is for paper bids only.

[http://connect.ncdot.gov/municipalities/Bid%20Proposals%20for%20LGA%20Content/09%20MBE-WBE%20Subcontractors%20\(State\).docx](http://connect.ncdot.gov/municipalities/Bid%20Proposals%20for%20LGA%20Content/09%20MBE-WBE%20Subcontractors%20(State).docx)

Subcontractor Quote Comparison Sheet - Spreadsheet for showing all subcontractor quotes in the work areas where MBEs and WBEs quoted on the project. This sheet is submitted with good faith effort packages.

<http://connect.ncdot.gov/business/SmallBusiness/Documents/DBE%20Subcontractor%20Quote%20Comparison%20Example.xls>

Combined MBE/WBE Goal

The Combined MBE/WBE Goal for this project is **4.0%**

The Combined Goal was established utilizing the following anticipated participation for Minority Business Enterprises and Women Business Enterprises:

(A) Minority Business Enterprises **2.0%**

- (1) *If the anticipated MBE participation is more than zero*, the Contractor shall exercise all necessary and reasonable steps to ensure that MBEs participate in at least the percent of the contract as set forth above.
- (2) *If the anticipated MBE participation is zero*, the Contractor shall make an effort to recruit and use MBEs during the performance of the contract. Any MBE participation obtained shall be reported to the Department.

(B) Women Business Enterprises **2.0%**

- (1) *If the anticipated WBE participation is more than zero*, the Contractor shall exercise all necessary and reasonable steps to ensure that WBEs participate in at least the percent of the contract as set forth above.
- (2) *If the anticipated WBE participation is zero*, the Contractor shall make an effort to recruit and use WBEs during the performance of the contract. Any WBE participation obtained shall be reported to the Department.

The Bidder is required to submit only participation to meet the Combined MBE/WBE Goal. The Combined Goal may be met by submitting all MBE participation, all WBE participation, or a combination of MBE and WBE participation.

Directory of Transportation Firms (Directory)

Real-time information is available about firms doing business with the Department and firms that are certified through NCUCP in the Directory of Transportation Firms. Only firms identified in the Directory as MBE and WBE certified shall be used to meet the Combined MBE / WBE goal. The Directory can be found at the following link.
<https://www.ebs.nc.gov/VendorDirectory/default.html>

The listing of an individual firm in the directory shall not be construed as an endorsement of the firm's capability to perform certain work.

Listing of MBE/WBE Subcontractors

At the time of bid, bidders shall submit all MBE and WBE participation that they anticipate to use during the life of the contract. Only those identified to meet the Combined MBE/WBE goal will be considered committed, even though the listing shall include both committed MBE/WBE subcontractors and additional MBE/WBE subcontractors. Any additional MBE/WBE subcontractor participation above the goal will follow the banking guidelines found elsewhere in this provision. All other additional MBE/WBE subcontractor participation submitted at the time of bid will be used toward the Department's overall race-neutral goals. Only those firms with current MBE and WBE certification at the time of bid opening will be acceptable for listing in the bidder's submittal of MBE and WBE participation. The Contractor shall indicate the following required information:

(A) Electronic Bids

Bidders shall submit a listing of MBE and WBE participation in the appropriate section of the electronic submittal file.

- (1) Submit the names and addresses of MBE and WBE firms identified to participate in the contract. If the bidder uses the updated listing of MBE and WBE firms shown in the electronic submittal file, the bidder may use the dropdown menu to access the name and address of the firms.
- (2) Submit the contract line numbers of work to be performed by each MBE and WBE firm. When no figures or firms are entered, the bidder will be considered to have no MBE or WBE participation.
- (3) The bidder shall be responsible for ensuring that the MBE and WBE are certified at the time of bid by checking the Directory of Transportation Firms. If the firm is not certified at the time of the bid-letting, that MBE's or WBE's participation will not count towards achieving the Combined MBE/WBE goal.

- (1) *If the Combined MBE/ WBE goal is more than zero,*
 - (a) Bidders, at the time the bid proposal is submitted, shall submit a listing of MBE/WBE participation, including the names and addresses on *Listing of MBE and WBE Subcontractors* contained elsewhere in the contract documents in order for the bid to be considered responsive. Bidders shall indicate the total dollar value of the MBE and WBE participation for the contract.
 - (b) If bidders have no MBE or WBE participation, they shall indicate this on the *Listing of MBE and WBE Subcontractors* by entering the word “None” or the number “0.” This form shall be completed in its entirety. **Blank forms will not be deemed to represent zero participation.** Bids submitted that do not have MBE and WBE participation indicated on the appropriate form will not be read publicly during the opening of bids. The Department will not consider these bids for award and the proposal will be rejected.
 - (c) The bidder shall be responsible for ensuring that the MBE/WBE is certified at the time of bid by checking the Directory of Transportation Firms. If the firm is not certified at the time of the bid-letting, that MBE’s or WBE’s participation will not count towards achieving the Combined MBE/WBE goal.
- (2) *If the Combined MBE/WBE Goal is zero,* entries on the *Listing of MBE and WBE Subcontractors* are not required for the zero goal, however any MBE or WBE participation that is achieved during the project shall be reported in accordance with requirements contained elsewhere in the special provision.

MBE or WBE Prime Contractor

When a certified MBE or WBE firm bids on a contract that contains a Combined MBE/WBE Goal, the firm is responsible for meeting the goal or making good faith efforts to meet the goal, just like any other bidder. In most cases, a MBE or WBE bidder on a contract will meet the Combined MBE/WBE goal by virtue of the work it performs on the contract with its own forces. However, all the work that is performed by the MBE or WBE bidder and any other similarly certified subcontractors will count toward the goal. The MBE or WBE bidder shall list itself along with any MBE or WBE subcontractors, if any, in order to receive credit toward the goals.

MBE/WBE prime contractors shall also follow Sections A or B listed under *Listing of MBE/WBE Subcontractors* just as a non-MBE/WBE bidder would.

Written Documentation – Letter of Intent

The bidder shall submit written documentation for each MBE/WBE that will be used to meet the Combined MBE/WBE goal of the contract, indicating the bidder's commitment to use the MBE/WBE in the contract. This documentation shall be submitted on the Department's form titled *Letter of Intent*.

The documentation shall be received in the office of the Engineer no later than 2:00 p.m. of the fifth calendar day following opening of bids, unless the fifth day falls on Saturday, Sunday or an official state holiday. In that situation, it is due in the office of the Engineer no later than 10:00 a.m. on the next official state business day.

If the bidder fails to submit the Letter of Intent from each committed MBE and WBE to be used toward the Combined MBE/WBE goal, or if the form is incomplete (i.e. both signatures are not present), the MBE/WBE participation will not count toward meeting the Combined MBE/WBE goal. If the lack of this participation drops the commitment below the Combined MBE/WBE goal, the Contractor shall submit evidence of good faith efforts for the goal not met, completed in its entirety, to the Engineer no later than 2:00 p.m. of the eighth calendar day following opening of bids, unless the eighth day falls on Saturday, Sunday or an official state holiday. In that situation, it is due in the office of the Engineer no later than 10:00 a.m. on the next official state business day.

Banking MBE/WBE Credit

If the committed MBE/WBE participation submitted exceeds the algebraic sum of the Combined MBE/WBE goal by \$1,000 or more, the excess will be placed on deposit by the Department for future use by the bidder. Separate accounts will be maintained for MBE and WBE participation and these may accumulate for a period not to exceed 24 months.

When the apparent lowest responsive bidder fails to submit sufficient participation by MBE and WBE firms to meet the advertised goal, as part of the good faith effort, the Department will consider allowing the bidder to withdraw funds to meet the Combined MBE/WBE goal as long as there are adequate funds available from the bidder's MBE and WBE bank accounts.

Submission of Good Faith Effort

If the bidder fails to meet or exceed the Combined MBE/WBE goal, the apparent lowest responsive bidder shall submit to the Department documentation of adequate good faith efforts made to reach that specific goal.

One complete set and one electronic copy (**in .PDF format**) of this information shall be received in the office of the Engineer no later than 2:00 p.m. of the fifth calendar day following opening of bids, unless the fifth day falls on Saturday, Sunday or an official state holiday. In that situation, it is due in the office of the Engineer no later than 10:00 a.m. on the next official state business day.

Note: Where the information submitted includes repetitious solicitation letters, it will be acceptable to submit a representative letter along with a distribution list of the firms that were

solicited. Documentation of MBE/WBE quotations shall be a part of the good faith effort submittal. This documentation may include written subcontractor quotations, telephone log notations of verbal quotations, or other types of quotation documentation.

Consideration of Good Faith Effort for Projects with a Combined MBE/WBE Goal More Than Zero

Adequate good faith efforts mean that the bidder took all necessary and reasonable steps to achieve the goal which, by their scope, intensity, and appropriateness, could reasonably be expected to obtain sufficient MBE/WBE participation. Adequate good faith efforts also mean that the bidder actively and aggressively sought MBE/WBE participation. Mere *pro forma* efforts are not considered good faith efforts.

The Department will consider the quality, quantity, and intensity of the different kinds of efforts a bidder has made. Listed below are examples of the types of actions a bidder will take in making a good faith effort to meet the goals and are not intended to be exclusive or exhaustive, nor is it intended to be a mandatory checklist.

- (A) Soliciting through all reasonable and available means (e.g. attendance at pre-bid meetings, advertising, written notices, use of verifiable electronic means through the use of the NCDOT Directory of Transportation Firms) the interest of all certified MBEs/WBEs that are also prequalified subcontractors. The bidder must solicit this interest within at least 10 days prior to bid opening to allow the MBEs/WBEs to respond to the solicitation. Solicitation shall provide the opportunity to MBEs/WBEs within the Division and surrounding Divisions where the project is located. The bidder must determine with certainty if the MBEs/WBEs are interested by taking appropriate steps to follow up initial solicitations.
- (B) Selecting portions of the work to be performed by MBEs/WBEs in order to increase the likelihood that the Combined MBE/WBE goal will be achieved.
 - (1) Where appropriate, break out contract work items into economically feasible units to facilitate MBE/WBE participation, even when the prime contractor might otherwise prefer to perform these work items with its own forces.
 - (2) Negotiate with subcontractors to assume part of the responsibility to meet the advertised goal when the work to be sublet includes potential for MBE/WBE participation (2nd and 3rd tier subcontractors).
- (C) Providing interested certified MBEs/WBEs that are also prequalified subcontractors with adequate information about the plans, specifications, and requirements of the contract in a timely manner to assist them in responding to a solicitation.
- (D)
 - (1) Negotiating in good faith with interested MBEs/WBEs. It is the bidder's responsibility to make a portion of the work available to MBE/WBE subcontractors and suppliers and to select those portions of the work or material needs consistent with the available MBE/WBE subcontractors and suppliers, so as

to facilitate MBE/WBE participation. Evidence of such negotiation includes the names, addresses, and telephone numbers of MBEs/WBEs that were considered; a description of the information provided regarding the plans and specifications for the work selected for subcontracting; and evidence as to why additional agreements could not be reached for MBEs/WBEs to perform the work.

- (2) A bidder using good business judgment would consider a number of factors in negotiating with subcontractors, including MBE/WBE subcontractors, and would take a firm's price and capabilities as well as the advertised goal into consideration. However, the fact that there may be some additional costs involved in finding and using MBEs/WBEs is not in itself sufficient reason for a bidder's failure to meet the advertised goal, as long as such costs are reasonable. Also, the ability or desire of a prime contractor to perform the work of a contract with its own organization does not relieve the bidder of the responsibility to make good faith efforts. Bidding contractors are not, however, required to accept higher quotes from MBEs/WBEs if the price difference is excessive or unreasonable.
- (E) Not rejecting MBEs/WBEs as being unqualified without sound reasons based on a thorough investigation of their capabilities. The bidder's standing within its industry, membership in specific groups, organizations, or associates and political or social affiliations (for example, union vs. non-union employee status) are not legitimate causes for the rejection or non-solicitation of bids in the bidder's efforts to meet the project goal.
- (F) Making efforts to assist interested MBEs/WBEs in obtaining bonding, lines of credit, or insurance as required by the recipient or bidder.
- (G) Making efforts to assist interested MBEs/WBEs in obtaining necessary equipment, supplies, materials, or related assistance or services.
- (H) Effectively using the services of available minority/women community organizations; minority/women contractors' groups; Federal, State, and local minority/women business assistance offices; and other organizations as allowed on a case-by-case basis to provide assistance in the recruitment and placement of MBEs/WBEs. Contact within 7 days from the bid opening the Business Opportunity and Work Force Development Unit at BOWD@ncdot.gov to give notification of the bidder's inability to get MBE or WBE quotes.
- (I) Any other evidence that the bidder submits which shows that the bidder has made reasonable good faith efforts to meet the advertised goal.

In addition, the Department may take into account the following:

- (1) Whether the bidder's documentation reflects a clear and realistic plan for achieving the Combined MBE/WBE goal.
- (2) The bidders' past performance in meeting the contract goal.

- (3) The performance of other bidders in meeting the advertised goal. For example, when the apparent successful bidder fails to meet the goal, but others meet it, you may reasonably raise the question of whether, with additional reasonable efforts the apparent successful bidder could have met the goal. If the apparent successful bidder fails to meet the advertised goal, but meets or exceeds the average MBE and WBE participation obtained by other bidders, the Department may view this, in conjunction with other factors, as evidence of the apparent successful bidder having made a good faith effort.

If the Department does not award the contract to the apparent lowest responsive bidder, the Department reserves the right to award the contract to the next lowest responsive bidder that can satisfy to the Department that the Combined MBE/WBE goal can be met or that an adequate good faith effort has been made to meet the advertised goal.

Non-Good Faith Appeal

The Engineer will notify the contractor verbally and in writing of non-good faith. A contractor may appeal a determination of non-good faith made by the Goal Compliance Committee. If a contractor wishes to appeal the determination made by the Committee, they shall provide written notification to the Engineer. The appeal shall be made within 2 business days of notification of the determination of non-good faith.

Counting MBE/WBE Participation Toward Meeting the Combined MBE/WBE Goal

(A) Participation

The total dollar value of the participation by a committed MBE/WBE will be counted toward the contract goal requirements. The total dollar value of participation by a committed MBE/WBE will be based upon the value of work actually performed by the MBE/WBE and the actual payments to MBE/WBE firms by the Contractor.

(B) Joint Checks

Prior notification of joint check use shall be required when counting MBE/WBE participation for services or purchases that involves the use of a joint check. Notification shall be through submission of Form JC-1 (*Joint Check Notification Form*) and the use of joint checks shall be in accordance with the Department's Joint Check Procedures.

(C) Subcontracts (Non-Trucking)

A MBE/WBE may enter into subcontracts. Work that a MBE subcontracts to another MBE firm may be counted toward the anticipated MBE participation. The same holds for work that a WBE subcontracts to another WBE firm. Work that a MBE/WBE subcontracts to a non-MBE/WBE firm does not count toward the contract goal requirement. It should be noted that every effort shall be made by MBE and WBE contractors to subcontract to the same certification (i.e., MBEs to MBEs and WBEs to

WBEs), in order to fulfill the MBE or WBE participation breakdown. This, however, may not always be possible due to the limitation of firms in the area. If the MBE or WBE firm shows a good faith effort has been made to reach out to similarly certified firms and there is no interest or availability, and they can get assistance from other certified firms, the Engineer will not hold the prime responsible for meeting the individual MBE or WBE breakdown. If a MBE or WBE contractor or subcontractor subcontracts a significantly greater portion of the work of the contract than would be expected on the basis of standard industry practices, it shall be presumed that the MBE or WBE is not performing a commercially useful function.

(D) Joint Venture

When a MBE or WBE performs as a participant in a joint venture, the Contractor may count toward its contract goal requirement a portion of the total value of participation with the MBE or WBE in the joint venture, that portion of the total dollar value being a distinct clearly defined portion of work that the MBE or WBE performs with its forces.

(E) Suppliers

A contractor may count toward its MBE /WBE requirement 60 percent of its expenditures for materials and supplies required to complete the contract and obtained from a MBE or WBE regular dealer and 100 percent of such expenditures from a MBE or WBE manufacturer.

(F) Manufacturers and Regular Dealers

A contractor may count toward its MBE /WBE requirement the following expenditures to MBE/WBE firms that are not manufacturers or regular dealers:

- (1) The fees or commissions charged by a MBE/WBE firm for providing a *bona fide* service, such as professional, technical, consultant, or managerial services, or for providing bonds or insurance specifically required for the performance of a DOT-assisted contract, provided the fees or commissions are determined to be reasonable and not excessive as compared with fees and commissions customarily allowed for similar services.
- (2) With respect to materials or supplies purchased from a MBE/WBE, which is neither a manufacturer nor a regular dealer, count the entire amount of fees or commissions charged for assistance in the procurement of the materials and supplies, or fees or transportation charges for the delivery of materials or supplies required on a job site (but not the cost of the materials and supplies themselves), provided the fees are determined to be reasonable and not excessive as compared with fees customarily allowed for similar services.

Commercially Useful Function

(A) MBE/WBE Utilization

The Contractor may count toward its contract goal requirement only expenditures to MBEs and WBEs that perform a commercially useful function in the work of a contract. A MBE/WBE performs a commercially useful function when it is responsible for execution of the work of the contract and is carrying out its responsibilities by actually performing, managing, and supervising the work involved. To perform a commercially useful function, the MBE/WBE shall also be responsible with respect to materials and supplies used on the contract, for negotiating price, determining quality and quantity, ordering the material and installing (where applicable) and paying for the material itself. To determine whether a MBE/WBE is performing a commercially useful function, the Department will evaluate the amount of work subcontracted, industry practices, whether the amount the firm is to be paid under the contract is commensurate with the work it is actually performing and the MBE/WBE credit claimed for its performance of the work, and any other relevant factors. If it is determined that a MBE or WBE is not performing a Commercially Useful Function, the contractor may present evidence to rebut this presumption to the Department.

(B) MBE/WBE Utilization in Trucking

The following factors will be used to determine if a MBE or WBE trucking firm is performing a commercially useful function:

- (1) The MBE/WBE shall be responsible for the management and supervision of the entire trucking operation for which it is responsible on a particular contract, and there shall not be a contrived arrangement for the purpose of meeting the Combined MBE/WBE goal.
- (2) The MBE/WBE shall itself own and operate at least one fully licensed, insured, and operational truck used on the contract.
- (3) The MBE/WBE receives credit for the total value of the transportation services it provides on the contract using trucks it owns, insures, and operates using drivers it employs.
- (4) The MBE may subcontract the work to another MBE firm, including an owner-operator who is certified as a MBE. The same holds true that a WBE may subcontract the work to another WBE firm, including an owner-operator who is certified as a WBE. When this occurs, the MBE or WBE who subcontracts work receives credit for the total value of the transportation services the subcontracted MBE or WBE provides on the contract. It should be noted that every effort shall be made by MBE and WBE contractors to subcontract to the same certification (i.e., MBEs to MBEs and WBEs to WBEs), in order to fulfill the participation breakdown. This, however, may not always be possible due to the limitation of firms in the area. If the MBE or WBE firm shows a good faith effort has been made to reach out to similarly certified transportation service

providers and there is no interest or availability, and they can get assistance from other certified providers, the Engineer will not hold the prime responsible for meeting the individual MBE or WBE participation breakdown.

- (5) The MBE/WBE may also subcontract the work to a non-MBE/WBE firm, including from an owner-operator. The MBE/WBE who subcontracts the work to a non-MBE/WBE is entitled to credit for the total value of transportation services provided by the non-MBE/WBE subcontractor not to exceed the value of transportation services provided by MBE/WBE-owned trucks on the contract. Additional participation by non-MBE/WBE subcontractors receives credit only for the fee or commission it receives as a result of the subcontract arrangement. The value of services performed under subcontract agreements between the MBE/WBE and the Contractor will not count towards the MBE/WBE contract requirement.
- (6) A MBE/WBE may lease truck(s) from an established equipment leasing business open to the general public. The lease must indicate that the MBE/WBE has exclusive use of and control over the truck. This requirement does not preclude the leased truck from working for others during the term of the lease with the consent of the MBE/WBE, so long as the lease gives the MBE/WBE absolute priority for use of the leased truck. This type of lease may count toward the MBE/WBE's credit as long as the driver is under the MBE/WBE's payroll.
- (7) Subcontracted/leased trucks shall display clearly on the dashboard the name of the MBE/WBE that they are subcontracted/leased to and their own company name if it is not identified on the truck itself. Magnetic door signs are not permitted.

MBE/WBE Replacement

When a Contractor has relied on a commitment to a MBE or WBE subcontractor (or an approved substitute MBE or WBE subcontractor) to meet all or part of a contract goal requirement, the contractor shall not terminate the MBE/WBE subcontractor for convenience. This includes, but is not limited to, instances in which the Contractor seeks to perform the work of the terminated subcontractor with another MBE/WBE subcontractor, a non-MBE/WBE subcontractor, or with the Contractor's own forces or those of an affiliate.

The Contractor must give notice in writing both by certified mail and email to the MBE/WBE subcontractor, with a copy to the Engineer of its intent to request to terminate and/or substitute, and the reason for the request. The Contractor must give the MBE/WBE subcontractor five (5) business days to respond to the Contractor's Notice of Intent to Request Termination and/or Substitution. If the MBE/WBE subcontractor objects to the intended termination/substitution, the MBE/WBE, within five (5) business days must advise the Contractor and the Department of the reasons why the action should not be approved. The five-day notice period shall begin on the next business day after written notice is provided to the MBE/WBE subcontractor.

A committed MBE/WBE subcontractor may only be terminated after receiving the Department's written approval based upon a finding of good cause for the proposed termination and/or substitution. For purposes of this section, good cause shall include the following circumstances:

- (a) The listed MBE/WBE subcontractor fails or refuses to execute a written contract;
- (b) The listed MBE/WBE subcontractor fails or refuses to perform the work of its subcontract in a way consistent with normal industry standards. Provided, however, that good cause does not exist if the failure or refusal of the MBE/WBE subcontractor to perform its work on the subcontract results from the bad faith or discriminatory action of the prime contractor;
- (c) The listed MBE/WBE subcontractor fails or refuses to meet the prime contractor's reasonable, nondiscriminatory bond requirements;
- (d) The listed MBE/WBE subcontractor becomes bankrupt, insolvent, or exhibits credit unworthiness;
- (e) The listed MBE/WBE subcontractor is ineligible to work on public works projects because of suspension and debarment proceedings pursuant to 2 CFR Parts 180, 215 and 1,200 or applicable state law;
- (f) The listed MBE/WBE subcontractor is not a responsible contractor;
- (g) The listed MBE/WBE voluntarily withdraws from the project and provides written notice of withdrawal;
- (h) The listed MBE/WBE is ineligible to receive MBE/WBE credit for the type of work required;
- (i) A MBE/WBE owner dies or becomes disabled with the result that the listed MBE/WBE contractor is unable to complete its work on the contract;
- (j) Other documented good cause that compels the termination of the MBE/WBE subcontractor. Provided, that good cause does not exist if the prime contractor seeks to terminate a MBE/WBE it relied upon to obtain the contract so that the prime contractor can self-perform the work for which the MBE/WBE contractor was engaged or so that the prime contractor can substitute another MBE/WBE or non-MBE/WBE contractor after contract award.

The Contractor shall comply with the following for replacement of a committed MBE/WBE:

(A) Performance Related Replacement

When a committed MBE/WBE is terminated for good cause as stated above, an additional MBE/WBE that was submitted at the time of bid may be used to fulfill the MBE/WBE commitment to meet the Combined MBE/WBE Goal. A good faith effort will only be required for removing a committed MBE/WBE if there were no additional MBE/WBEs submitted at the time of bid to cover the same amount of work as the MBE/WBE that was terminated.

If a replacement MBE/WBE is not found that can perform at least the same amount of work as the terminated MBE/WBE, the Contractor shall submit a good faith effort documenting the steps taken. Such documentation shall include, but not be limited to, the following:

- (1) Copies of written notification to MBE/WBEs that their interest is solicited in contracting the work defaulted by the previous MBE/WBE or in subcontracting other items of work in the contract.

- (2) Efforts to negotiate with MBE/WBEs for specific subbids including, at a minimum:
 - (a) The names, addresses, and telephone numbers of MBE/WBEs who were contacted.
 - (b) A description of the information provided to MBE/WBEs regarding the plans and specifications for portions of the work to be performed.
 - (3) A list of reasons why MBE/WBE quotes were not accepted.
 - (4) Efforts made to assist the MBE/WBEs contacted, if needed, in obtaining bonding or insurance required by the Contractor.
- (B) Decertification Replacement
- (1) When a committed MBE/WBE is decertified by the Department after the SAF (*Subcontract Approval Form*) has been received by the Department, the Department will not require the Contractor to solicit replacement MBE/WBE participation equal to the remaining work to be performed by the decertified firm. The participation equal to the remaining work performed by the decertified firm will count toward the contract goal requirement.
 - (2) When a committed MBE/WBE is decertified prior to the Department receiving the SAF (*Subcontract Approval Form*) for the named MBE/WBE firm, the Contractor shall take all necessary and reasonable steps to replace the MBE/WBE subcontractor with another MBE/WBE subcontractor to perform at least the same amount of work to meet the Combined MBE/WBE goal requirement. If a MBE/WBE firm is not found to do the same amount of work, a good faith effort must be submitted to NCDOT (see A herein for required documentation).
 - (3) Exception: If the MBE/WBE's ineligibility is caused solely by its having exceeded the size standard during the performance of the contract, the Department will not require the Contractor to solicit replacement MBE/WBE participation equal to the remaining work to be performed by the decertified firm. The participation equal to the remaining work performed by the decertified firm will count toward the contract goal requirement and overall goal.

All requests for replacement of a committed MBE/WBE firm shall be submitted to the Engineer for approval on Form RF-1 (*DBE Replacement Request*). If the Contractor fails to follow this procedure, the Contractor may be disqualified from further bidding for a period of up to 6 months.

Changes in the Work

When the Engineer makes changes that result in the reduction or elimination of work to be performed by a committed MBE/WBE, the Contractor will not be required to seek additional participation. When the Engineer makes changes that result in additional work to be performed by a MBE/WBE based upon the Contractor's commitment, the MBE/WBE shall participate in additional work to the same extent as the MBE/WBE participated in the original contract work.

When the Engineer makes changes that result in extra work, which has more than a minimal impact on the contract amount, the Contractor shall seek additional participation by MBEs/WBEs unless otherwise approved by the Engineer.

When the Engineer makes changes that result in an alteration of plans or details of construction, and a portion or all of the work had been expected to be performed by a committed MBE/WBE, the Contractor shall seek participation by MBEs/WBEs unless otherwise approved by the Engineer.

When the Contractor requests changes in the work that result in the reduction or elimination of work that the Contractor committed to be performed by a MBE/WBE, the Contractor shall seek additional participation by MBEs/WBEs equal to the reduced MBE/WBE participation caused by the changes.

Reports and Documentation

A SAF (*Subcontract Approval Form*) shall be submitted for all work which is to be performed by a MBE/WBE subcontractor. The Department reserves the right to require copies of actual subcontract agreements involving MBE/WBE subcontractors.

When using transportation services to meet the contract commitment, the Contractor shall submit a proposed trucking plan in addition to the SAF. The plan shall be submitted prior to beginning construction on the project. The plan shall include the names of all trucking firms proposed for use, their certification type(s), the number of trucks owned by the firm, as well as the individual truck identification numbers, and the line item(s) being performed.

Within 30 calendar days of entering into an agreement with a MBE/WBE for materials, supplies or services, not otherwise documented by the SAF as specified above, the Contractor shall furnish the Engineer a copy of the agreement. The documentation shall also indicate the percentage (60% or 100%) of expenditures claimed for MBE/WBE credit.

Reporting Minority and Women Business Enterprise Participation

The Contractor shall provide the Engineer with an accounting of payments made to all MBE and WBE firms, including material suppliers and contractors at all levels (prime, subcontractor, or second tier subcontractor). This accounting shall be furnished to the Engineer for any given month by the end of the following month. Failure to submit this information accordingly may result in the following action:

- (A) Withholding of money due in the next partial pay estimate; or
- (B) Removal of an approved contractor from the prequalified bidders' list or the removal of other entities from the approved subcontractors list.

While each contractor (prime, subcontractor, 2nd tier subcontractor) is responsible for accurate accounting of payments to MBEs/WBEs, it shall be the prime contractor's responsibility to report all monthly and final payment information in the correct reporting manner.

Failure on the part of the Contractor to submit the required information in the time frame specified may result in the disqualification of that contractor and any affiliate companies from further bidding until the required information is submitted.

Failure on the part of any subcontractor to submit the required information in the time frame specified may result in the disqualification of that contractor and any affiliate companies from being approved for further work on future projects until the required information is submitted.

Contractors reporting transportation services provided by non-MBE/WBE lessees shall evaluate the value of services provided during the month of the reporting period only.

At any time, the Engineer can request written verification of subcontractor payments. The Contractor shall report the accounting of payments through the Department's DBE Payment Tracking System.

Failure to Meet Contract Requirements

Failure to meet contract requirements in accordance with Subarticle 102-15(J) of the *Standard Specifications* may be cause to disqualify the Contractor.

RESTRICTIONS ON ITS EQUIPMENT AND SERVICES:

(11-17-20)

SP01 G090

All telecommunications, video or other ITS equipment or services installed or utilized on this project must be in conformance with UNIFORM ADMINISTRATIVE REQUIREMENTS, COST PRINCIPLES, AND AUDIT REQUIREMENTS FOR FEDERAL AWARDS **2 CFR, § 200.216 Prohibition on certain telecommunications and video surveillance services or equipment.**

USE OF UNMANNED AIRCRAFT SYSTEM (UAS):

(8-20-19)

SP1 G092

The Contractor shall adhere to all Federal, State and Local regulations and guidelines for the use of Unmanned Aircraft Systems (UAS). This includes but is not limited to US 14 CFR Part 107 *Small UAS Rule*, NC GS 15A-300.2 *Regulation of launch and recovery sites*, NC GS 63-95 *Training required for the operation of unmanned aircraft systems*, NC GS 63-96 *Permit required for commercial operation of unmanned aircraft system*, and NCDOT UAS Policy. The required operator certifications include possessing a current Federal Aviation Administration (FAA) Remote Pilot Certificate, a NC UAS Operator Permit as well as operating a UAS registered with the FAA.

Prior to beginning operations, the Contractor shall complete the NCDOT UAS – Flight Operation Approval Form and submit it to the Engineer for approval. All UAS operations shall be approved by the Engineer prior to beginning the operations.

All contractors or subcontractors operating UAS shall have UAS specific general liability insurance to cover all operations under this contract.

The use of UAS is at the Contractor's discretion. No measurement or payment will be made for the use of UAS. In the event that the Department directs the Contractor to utilize UAS, payment will be in accordance with Article 104-7 Extra Work.

EQUIPMENT IDLING GUIDELINES:

(1-19-21)

107

SP1 G096

Exercise reduced fuel consumption and reduced equipment emissions during the construction of all work associated with this contract. Employees engaged in the construction of this project should turn off vehicles when stopped for more than thirty (30) minutes and off-highway equipment should idle no longer than fifteen (15) consecutive minutes.

These guidelines for turning off vehicles and equipment when idling do not apply to:

1. Idling when queuing.
2. Idling to verify the vehicle is in safe operating condition.
3. Idling for testing, servicing, repairing or diagnostic purposes.
4. Idling necessary to accomplish work for which the vehicle was designed (such as operating a crane, mixing concrete, etc.).
5. Idling required to bring the machine system to operating temperature.
6. Emergency vehicles, utility company, construction, and maintenance vehicles where the engines must run to perform needed work.
7. Idling to ensure safe operation of the vehicle.
8. Idling when the propulsion engine is providing auxiliary power for other than heating or air conditioning. (such as hydraulic systems for pavers)
9. When specific traffic, safety, or emergency situations arise.

10. If the ambient temperature is less than 32 degrees Fahrenheit. Limited idling to provide for the safety of vehicle occupants (e.g. to run the heater).
11. If the ambient temperature is greater than 90 degrees Fahrenheit. Limited idling to provide for the safety of vehicle occupants of off-highway equipment (e.g. to run the air conditioning) no more than 30 minutes.
12. Diesel powered vehicles may idle for up to 30 minutes to minimize restart problems.

Any vehicle, truck, or equipment in which the primary source of fuel is natural gas or electricity is exempt from the idling limitations set forth in this special provision.

OUTSOURCING OUTSIDE THE USA:

(9-21-04) (Rev. 5-16-06)

SP1 G150

All work on consultant contracts, services contracts, and construction contracts shall be performed in the United States of America. No work shall be outsourced outside of the United States of America.

Outsourcing for the purpose of this provision is defined as the practice of subcontracting labor, work, services, staffing, or personnel to entities located outside of the United States.

The North Carolina Secretary of Transportation shall approve exceptions to this provision in writing.

PROJECT SPECIAL PROVISIONS

ROADWAY

INCIDENTAL STONE BASE:

(7-1-95)(Rev.1-16-24)

545

SP5 R28R

Description

Place incidental stone base on driveways, mailboxes, etc. immediately after paving and do not have the paving operations exceed stone base placement by more than one week without written permission of the Engineer.

Materials and Construction

Provide and place incidental stone base in accordance with Section 545 of the *Standard Specifications*.

Measurement and Payment

Incidental Stone Base will be measured and paid in accordance with Article 545-6 of the *Standard Specifications*.

SHOULDER WEDGE:

(9-20-11)(Rev. 1-16-24)

610

SP6 R03R

Revise the *Standard Specifications* as follows:

Page 6-21, Article 610-8, SPREADING AND FINISHING, add the following after line 40:

Attach a device, mounted on screed of paving equipment, capable of constructing a shoulder wedge with an angle of 30 degrees plus or minus 4 degrees along the outside edge of the roadway, measured from the horizontal plane in place after final compaction on the final surface course. Use an approved mechanical device which will form the asphalt mixture to produce a wedge with uniform texture, shape and density while automatically adjusting to varying heights.

Payment for use of this device will be incidental to the other pay items in the contract.

PRICE ADJUSTMENT - ASPHALT BINDER FOR PLANT MIX:

(11-21-00)(Rev. 1-16-24)

620

SP6 R25

Price adjustments for asphalt binder for plant mix will be made in accordance with Section 620 of the *Standard Specifications*.

The base price index for asphalt binder for plant mix is **\$596.88** per ton.

This base price index represents an average of F.O.B. selling prices of asphalt binder at supplier's terminals on **May 1, 2024**.

FINAL SURFACE TESTING NOT REQUIRED:

(5-18-04) (Rev. 2-16-16)

610

SP6 R45

Final surface testing is not required on this project in accordance with Section 610-13, *Final Surface Testing and Acceptance*.

RESURFACING EXISTING BRIDGES (with Milling):

(3-20-12) (Rev. 8-21-12)

SP6 R61BR

The Contractor's attention is directed to the fact that he will be required to mill and resurface the bridges on this project if directed by the Engineer.

Place the surface so as to follow a grade line set by the Engineer with the minimum thickness as shown on the sketch herein or as directed by the Engineer. State Forces will make all necessary repairs to the bridge floors prior to the time that the Contractor places the proposed surfacing. Give the Engineer at least 15 days' notice prior to the expected time to begin operations so that State Forces will have sufficient time to complete their work.

At all bridges that are not to be resurfaced, mill a taper into existing pavement for a length of 25 feet per inch of final surface. A temporary asphalt wedge will be required immediately after milling to ensure smooth travel if the final layer of surface course is not placed on the same day as milling.

PATCHING EXISTING PAVEMENT:

(1-15-02) (Rev. 1-16-24)

610

SP6 R88R

Description

The Contractor's attention is directed to the fact that there are areas of existing pavement on this project that will require repair prior to resurfacing. Patch the areas that, in the opinion of the Engineer, need repairing. The areas to be patched will be delineated by the Engineer prior to the Contractor performing repairs.

Materials

The patching consists of Asphalt Concrete Base Course, Asphalt Concrete Intermediate Course, Asphalt Concrete Surface Course, or a combination of base, intermediate and surface course.

Construction Methods

Remove existing pavement at locations directed by the Engineer in accordance with Section 250 of the *Standard Specifications*.

Place Asphalt Concrete Base Course in lifts not exceeding 5.5 inches. Utilize compaction equipment suitable for compacting patches as small as 3.5 feet by 6 feet on each lift. Use an approved compaction pattern to achieve proper compaction. If patched pavement is to be open to traffic between December through March of the following year, use Asphalt Concrete Intermediate Course or Asphalt Concrete Surface Course as the top layer of the patch.

Schedule operations so that all areas where pavement has been removed will be repaired on the same day of the pavement removal and all lanes of traffic restored.

Measurement and Payment

Patching Existing Pavement will be measured and paid as the actual number of tons of asphalt plant mix complete in place that has been used to make completed and accepted repairs. The asphalt plant mixed material will be measured by being weighed in trucks on certified platform scales or other certified weighing devices. The above price and payment will be full compensation for all work covered by this provision, including but not limited to removal and disposal of all types of pavement; furnishing and applying tack coat; furnishing, placing, and compacting of asphalt plant mix; and furnishing scales.

Furnishing asphalt binder will be paid as provided in Article 620-4 for *Asphalt Binder for Plant Mix* for each grade required.

Payment will be made under:

Pay Item

Patching Existing Pavement

Pay Unit

Ton



DocuSigned by:
Matthew V. Springer
BC60F6E8B584403...
01/01/2024

HOT SPRAY THERMOPLASTIC PAVEMENT MARKING LINES:

(12-1-20) (Rev. 1-1-24)

Description

This special provision covers machine applied “hot spray” thermoplastic pavement marking material with both incorporated reflective media.

General, Color, Packing for Shipment, Storage, Materials, Construction Methods, Maintenance, Method of Measurement, and Basis of Payment shall be as described in Section 1087 and Section 1205 of the *Standard Specifications*, with the exceptions as shown below:

Revise the *Standard Specifications* as follows:

Page 10-187, Subarticle 1087-4(C) Gradation & Roundness, lines 4-6, replace this subarticle with the following:

The reflective media used in all pavement marking shall be used according to the manufacturer’s recommendations in order to meet the retroreflectivity requirements as stated in Subarticles 1205-4(C) and 1205-4(D) as measured by any Department approved mobile or handheld retroreflectometer.

The reflective media shall be capable of flowing freely through dispensing equipment in any weather suitable for marking the pavement.

Page 12-1, Subarticle 1205-2(B) Material Qualifications, line 9, add the following:

All “hot spray” thermoplastic manufacturers must be prequalified. In order to be prequalified, all “hot spray” Thermoplastic Pavement Marking manufacturers must have their material installed on the NTPEP test deck.

Page 12-6, Subarticle 1205-4(A)(3) Applicator Storage Kettle, delete lines 31-33, add the following:

Handliners shall not be allowed.

Use application equipment that provides multiple width settings ranging from 4 inches to 12 inches and multiple thickness settings to achieve a minimum 50 mil thickness in one pass.

Page 12-7, Subarticle 1205-4(C) Application, lines 2-5, delete the first paragraph and replace with the following:

All thermoplastic markings shall be of the hot, machine applied type. Application shall be accomplished by spraying methods only.

Page 12-7, Subarticle 1205-4(C) Application, lines 31-32, delete the last paragraph and replace with the following:

Produce a cross-sectional thickness of hot spray thermoplastic markings for long line markings only with a minimum thickness of 50 mils without reflective media or a minimum thickness of 55 mils with reflective media.

Extruded type thermoplastic shall not be sprayed.

The cross-sectional thickness of all "hot sprayed" thermoplastic markings above the surface of the existing pavement shall be no more than 60 mils.

The manufacturer of that material shall certify that the Contractor is trained to place the material. At least one member of each crew working on this project shall have completed this training. The Contractor shall furnish the Engineer written confirmation of this training from the material manufacturer prior to beginning the work.

If the hot sprayed thermoplastic is to be placed over milled-in rumble strips, the Contractor shall ensure that all debris is removed after milling and the surface is thoroughly cleaned to ensure optimum adhesion between the surface and the hot sprayed thermoplastic.

Page 12-12, Article 1205-10 Measurement and Payment, add the following:

Hot Spray Thermoplastic Pavement Marking Line, __" Width, __ mils Thick will be measured and paid as the actual number of linear feet of pavement marking lines satisfactorily placed and accepted by the Engineer. The quantity of solid lines will be the summation of the linear feet of solid line measured end-to-end of the line. The quantity of skip or broken lines will be the summation of the linear feet derived by multiplying the nominal length of a line by the number of marking lines satisfactorily placed. Such prices and payment will be full compensation for all work covered by this section including, but not limited to, furnishing, surface preparation, reapplication of molten pavement marking crossed by a vehicle, and removal of all pavement marking materials spilled on the roadway surface.

Payment will be made under:

Pay Item	Pay Unit
Hot Spray Thermoplastic Pavement Marking Lines, __", __mils	Linear Foot

PROJECT NO.	SHEET NO.	TOTAL NO.
2024CPT.04.17.20511	1	2

SUMMARY OF QUANTITIES

PROJECT NO	COUNTY	MAP NO	ROUTE	DESCRIPTION	TYP NO	LANES	LANE TYPE	FINAL SURFACE TESTING REQUIRED	WARM MIX ASPHALT REQUIRED	LENGTH	WIDTH	BEGIN MP	END MP	0000100000-N	1220000000-E	1330000000-E	1519000000-E	1575000000-E	1704000000-E	2845000000-N	7444000000-E
														MOBILIZATION	INCIDENTAL STONE BASE	INCIDENTAL MILLING	SURFACE COURSE, \$9.5B	ASPHALT BINDER FOR PLANT MIX	PATCHING EXISTING PAVEMENT	ADJ. OF METER OR VALVE BOX	INDUCTIVE LOOP
														LS	TONS	SY	TONS	TONS	TONS	EA	LF
2024CPT.04.17.20511	Johnston	1	SR-2105 / BUCK RD	FROM NASH COUNTY LINE TO NC-231 (~150 LF NORTH AT EXISTING PAVEMENT JOINT)	1	2	2WU	NO	NO	1.73	20	0	1.73	0.05	20	1,375	1,766	116	20		
TOTAL FOR MAP NO. 1										1.73				0.05	20	1,375	1,766	116	20		
2024CPT.04.17.20511	Johnston	2	SR-1718 / STOTTS MILL RD	FROM SR-1003 BUFFALO ROAD TO SR-1701 WENDELL ROAD	1	2	2WU	NO	NO	2.436	20	0	2.436	0.07	30	800	2,373	161	150		
TOTAL FOR MAP NO. 2										2.436				0.07	30	800	2,373	161	150		
2024CPT.04.17.20511	Johnston	3	SR-1903 / VINSON RD	FROM SR-1902 GLEN LAUREL ROAD TO SR-1904 SOUTHERLAND ROAD	1	2	2WU	NO	NO	3.351	20	0	3.351	0.10	30	4,250	3,400	226	105	10	
TOTAL FOR MAP NO. 3										3.351				0.10	30	4,250	3,400	226	105	10	
2024CPT.04.17.20511	Johnston	4	SR-2114 / OLLIE RD	FROM SR-2109 WOODARDS DAIRY ROAD TO SR-2112 CROCKERS NUB ROAD	1	2	2WU	NO	NO	0.9	20	0	0.9	0.03	12	125	877	57	5		
TOTAL FOR MAP NO. 4										0.9				0.03	12	125	877	57	5		
2024CPT.04.17.20511	Johnston	5	SR-1701 / WENDELL RD	FROM SR-1003 TO NC-231	1	2	2WU	NO	NO	5.126	22	0	5.126	0.17	106	2,490	5,741	382	180		140
TOTAL FOR MAP NO. 5										5.126				0.17	106	2,490	5,741	382	180		140
2024CPT.04.17.20511	Johnston	6	SR-1736 / PRICE RD	FROM SR-1735 JORDAN NARRON ROAD TO NC-96	1	2	2WU	NO	NO	2.2	20	0	2.2	0.07	24	650	2,191	144	35		
TOTAL FOR MAP NO. 6										2.2				0.07	24	650	2,191	144	35		
2024CPT.04.17.20511	Johnston	7	SR-2352 / PEACOCK RD	FROM SR-2385 PINEY GROVE CHURCH ROAD TO NC-222	1	2	2WU	NO	NO	0.92	20	0	0.92	0.03	16	250	896	59	25		
TOTAL FOR MAP NO. 7										0.92				0.03	16	250	896	59	25		
2024CPT.04.17.20511	Johnston	8	SR-2351 / POPE RD	FROM NC-222 TO SR-2385 PINEY GROVE CHURCH ROAD	1	2	2WU	NO	NO	1.25	21	0	1.25	0.04	14	250	1,278	86	70		
TOTAL FOR MAP NO. 8										1.25				0.04	14	250	1,278	86	70		
2024CPT.04.17.20511	Johnston	9	SR-2102 / FRIENDSHIP CHURCH RD	FROM NC-231 TO NASH COUNTY LINE	1	2	2WU	NO	NO	2.09	20	0	2.09	0.06	24	1,075	2,113	139	25		
TOTAL FOR MAP NO. 9										2.09				0.06	24	1,075	2,113	139	25		
2024CPT.04.17.20511	Johnston	10	SR-1943 / NEW CREECH RD	FROM SR-1720 THANKSGIVING FIRE ROAD TO SR-1941 BYRD ROAD	1	2	2WU	NO	NO	1.69	20	0	1.69	0.05	18	400	1,657	108	10		
TOTAL FOR MAP NO. 10										1.69				0.05	18	400	1,657	108	10		
2024CPT.04.17.20511	Johnston	11	SR-2109 / WOODARDS DAIRY RD	FROM SR-2110 FLOWER HILL ROAD TO NC-42	1	2	2WU	NO	NO	3.21	20	0	3.21	0.10	36	750	3,188	209	45		
TOTAL FOR MAP NO. 11										3.21				0.10	36	750	3,188	209	45		
2024CPT.04.17.20511	Johnston	12	SR-2110 / FLOWER HILL RD	FROM NC-42 TO WOODARDS DAIRY ROAD	1	2	2WU	NO	NO	3.93	20	6.43	10.36	0.12	52	700	3,974	265	140		
TOTAL FOR MAP NO. 12										3.93				0.12	52	700	3,974	265	140		
2024CPT.04.17.20511	Johnston	13	SR-2385 / PINEY GROVE CHURCH RD	FROM WAYNE COUNTY LINE TO SR-2342 PRINCETON KENLY ROAD	1	2	2WU	NO	NO	3.52	20	0	3.52	0.11	36	1,125	3,552	236	115		
TOTAL FOR MAP NO. 13										3.52				0.110	36	1,125	3,552	236	115		
TOTAL FOR PROJ NO. 2024CPT.04.17.20511										32.353				1.000	418	14,240	33,006	2,188	925	10	140
GRAND TOTAL										32.353				1.000	418	14,240	33,006	2,188	925	10	140

PROJECT NO.	SHEET NO.	TOTAL NO.
2024CPT.04.17.20511	2	2

THERMOPLASTIC AND PAINT QUANTITIES

PROJECT NO	COUNTY	MAP NO	ROUTE	DESCRIPTION	TYP NO	LANES	LANE TYPE	LENGTH	WIDTH	BEGIN MP	END MP	4413000000-E	4457000000-N	4685000000-E	4709000000-E	4720000000-E	4725000000-E			4890000000-E				
								MI	FT			WORK ZONE ADVANCE/GENERAL WARNING SIGNING	TEMPORARY TRAFFIC CONTROL	4" X 90 M WHITE THERMO	4" X 90 M YELLOW THERMO	THERMOPLASTIC PAVEMENT MARKING LINES (24", 90 MILS)	THERMO MSG SCHOOL 90 M	THERMO MSG ONLY 90 M	THERMO LT ARROW 90 M	THERMO STR ARROW 90 M	THERMO RT ARROW 90 M	THERMOPLASTIC PAVEMENT MARKING LINES - 4"X50 MILS HOT SPRAY - WHITE	THERMOPLASTIC PAVEMENT MARKING LINES - 4"X50 MILS HOT SPRAY - YELLOW	
2024CPT.04.17.20511	Johnston	1	SR-2105 / BUCK RD	FROM NASH COUNTY LINE TO NC-231 (~150 LF NORTH AT EXISTING PAVEMENT JOINT)	1	2	2WU	1.73	20	0	1.73	97	0.05							18,269	17,812			
TOTAL FOR MAP NO. 1								1.73				97	0.05								18,269	17,812		
2024CPT.04.17.20511	Johnston	2	SR-1718 / STOTTS MILL RD	FROM SR-1003 BUFFALO ROAD TO SR-1701 WENDELL ROAD	1	2	2WU	2.436	20	0	2.436	140	0.07							25,725	25,081			
TOTAL FOR MAP NO. 2								2.436				140	0.07								25,725	25,081		
2024CPT.04.17.20511	Johnston	3	SR-1903 / VINSON RD	FROM SR-1902 GLEN LAUREL ROAD TO SR-1904 SOUTHERLAND ROAD	1	2	2WU	3.351	20	0	3.351	188	0.10			180	12		17	35,387	34,502			
TOTAL FOR MAP NO. 3								3.351				188	0.10			180	12		17		35,387	34,502		
2024CPT.04.17.20511	Johnston	4	SR-2114 / OLLIE RD	FROM SR-2109 WOODARDS DAIRY ROAD TO SR-2112 CROCKERS NUB ROAD	1	2	2WU	0.9	20	0	0.9	52	0.03							9,504	9,266			
TOTAL FOR MAP NO. 4								0.9				52	0.03									9,504	9,266	
2024CPT.04.17.20511	Johnston	5	SR-1701 / WENDELL RD	FROM SR-1003 TO NC-231	1	2	2WU	5.126	22	0	5.126	288	0.17	54,131	52,101	290	12	8	8	4	4			
TOTAL FOR MAP NO. 5								5.126				288	0.17	54,131	52,101	290	12	8	8	4	4			
2024CPT.04.17.20511	Johnston	6	SR-1736 / PRICE RD	FROM SR-1735 JORDAN NARRON ROAD TO NC-96	1	2	2WU	2.2	20	0	2.2		0.07								23,232	22,070		
TOTAL FOR MAP NO. 6								2.2					0.07									23,232	22,070	
2024CPT.04.17.20511	Johnston	7	SR-2352 / PEACOCK RD	FROM SR-2385 PINEY GROVE CHURCH ROAD TO NC-222	1	2	2WU	0.92	20	0	0.92	52	0.03								9,715	8,501		
TOTAL FOR MAP NO. 7								0.92				52	0.03									9,715	8,501	
2024CPT.04.17.20511	Johnston	8	SR-2351 / POPE RD	FROM NC-222 TO SR-2385 PINEY GROVE CHURCH ROAD	1	2	2WU	1.25	21	0	1.25	72	0.04								13,200	12,540		
TOTAL FOR MAP NO. 8								1.25				72	0.04									13,200	12,540	
2024CPT.04.17.20511	Johnston	9	SR-2102 / FRIENDSHIP CHURCH RD	FROM NC-231 TO NASH COUNTY LINE	1	2	2WU	2.09	20	0	2.09	120	0.06								20,415	22,070		
TOTAL FOR MAP NO. 9								2.09				120	0.06									20,415	22,070	
2024CPT.04.17.20511	Johnston	10	SR-1943 / NEW CREECH RD	FROM SR-1720 THANKSGIVING FIRE ROAD TO SR-1941 BYRD ROAD	1	2	2WU	1.69	20	0	1.69	96	0.05								17,846	16,954		
TOTAL FOR MAP NO. 10								1.69				96	0.05									17,846	16,954	
2024CPT.04.17.20511	Johnston	11	SR-2109 / WOODARDS DAIRY RD	FROM SR-2110 FLOWER HILL ROAD TO NC-42	1	2	2WU	3.21	20	0	3.21	180	0.10								33,898	31,355		
TOTAL FOR MAP NO. 11								3.21				180	0.10									33,898	31,355	
2024CPT.04.17.20511	Johnston	12	SR-2110 / FLOWER HILL RD	FROM NC-42 TO WOODARDS DAIRY ROAD	1	2	2WU	3.93	20	6.43	10.36	224	0.12								41,501	38,907		
TOTAL FOR MAP NO. 12								3.93				224	0.12										41,501	38,907
2024CPT.04.17.20511	Johnston	13	SR-2385 / PINEY GROVE CHURCH RD	FROM WAYNE COUNTY LINE TO SR-2342 PRINCETON KENLY ROAD	1	2	2WU	3.52	20	0	3.52	200	0.11								37,171	34,848		
TOTAL FOR MAP NO. 13								3.52				200	0.110									37,171	34,848	
TOTAL FOR PROJ NO. 2024CPT.04.17.20511								32.353				1,709	1.000	54,131	52,101	470	24	8	25	4	4	285,863	273,906	
GRAND TOTAL								32.353				1,709	1.000	54,131	52,101	470	24	8	25	4	4	285,863	273,906	
														106,232			32		33		559,769			

PROJECT NO.	SHEET NO.	TOTAL SHEETS
2024CPT.04.17.20511	1	1

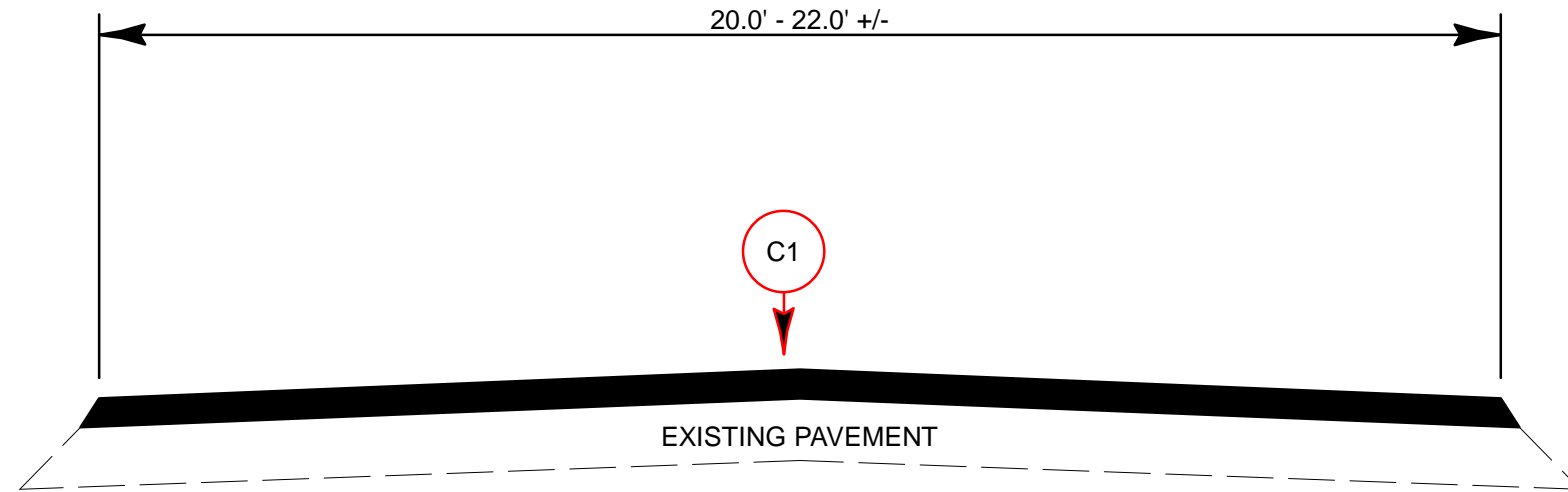

TYPICAL SECTION NO. 1
MAP(S) # 1 - 13

GENERAL NOTES	
1	State Forces Will Be Responsible for Shoulder Reconstruction for All Maps
2	Patching Existing Pavement To Be Completed by Contractor On All Maps

PAVEMENT SCHEDULE	
C1	PROP. APPROX. 1-1/2" ASPHALT CONCRETE SURFACE COURSE, TYPE S9.5B, AT AN AVERAGE RATE OF 165 LBS. PER SQ. YARD

DETAILS OF PATCHING EXISTING PAVEMENT PRIOR TO RESURFACING DETAIL

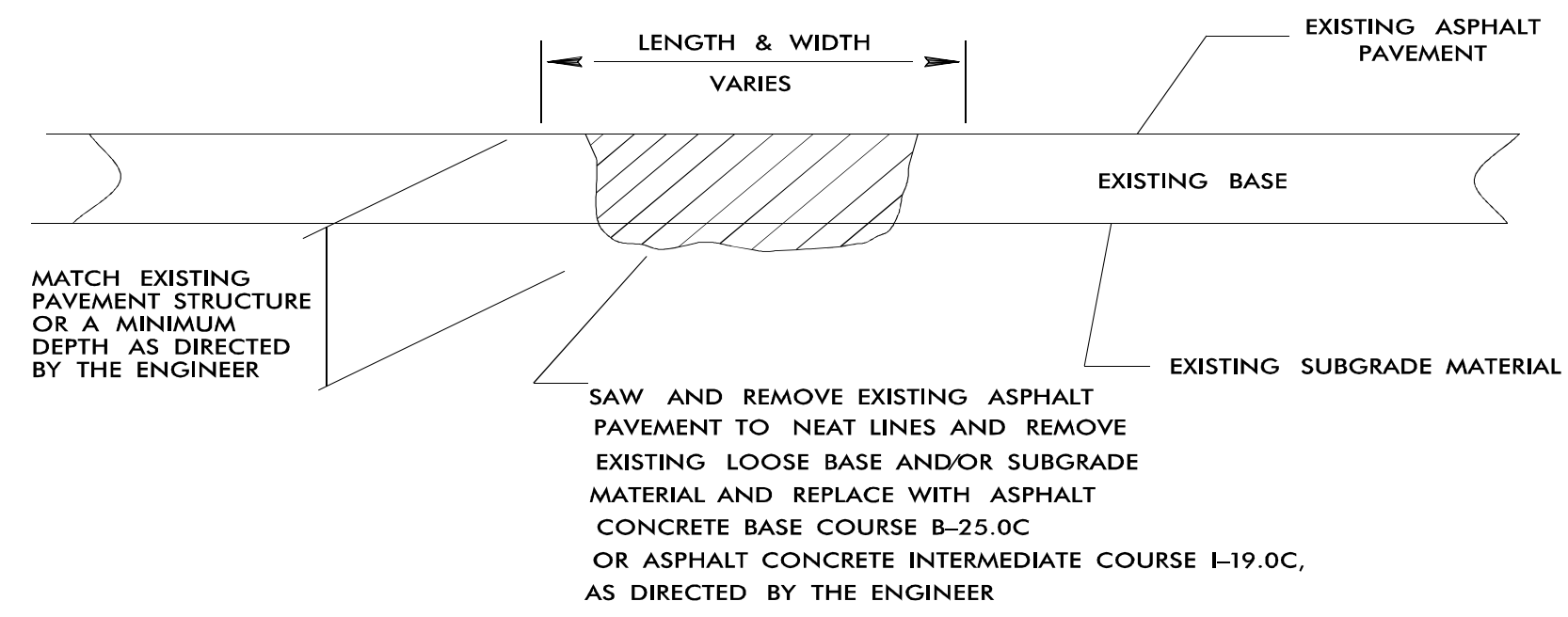

INCIDENTAL MILLING DETAIL

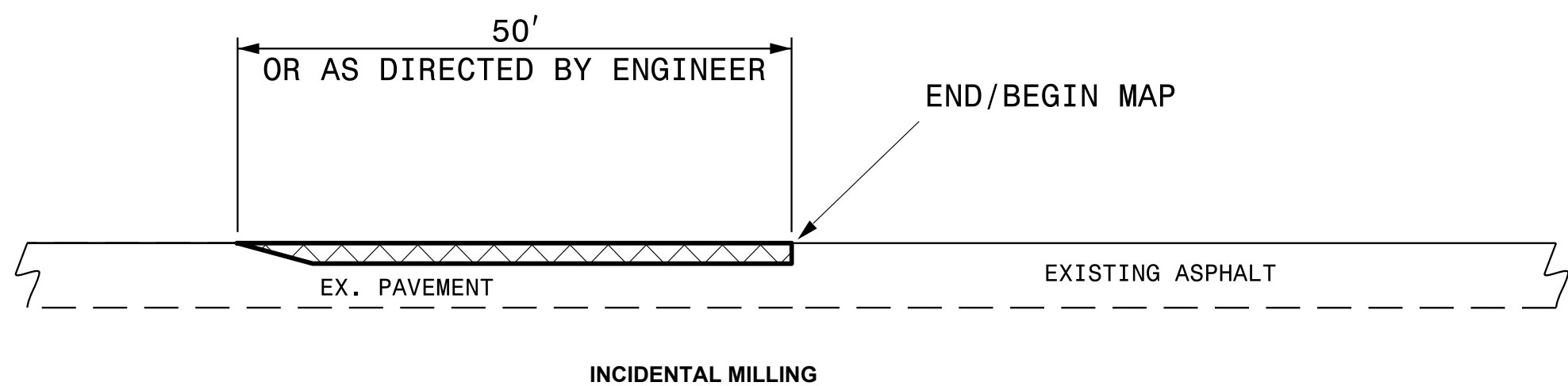

- NOTE:**
- PERFORM INCIDENTAL MILLING AT THE TIE INS, RAILROADS, BRIDGE DECKS AND APPROACHES AT THE DIRECTION OF THE ENGINEER.

- NOTES:
- 1) DETAIL DOES NOT APPLY TO OGAFc AND ULTRA-THIN BONDED WEARING COURSE.
 - 2) BACKFILL SHOULDER WITH APPROVED MATERIAL.
 - 3) THE SHOULDER WEDGE DEVICE MAY BE DISENGAGED AT PAVED DRIVEWAYS AND SIDE STREETS.

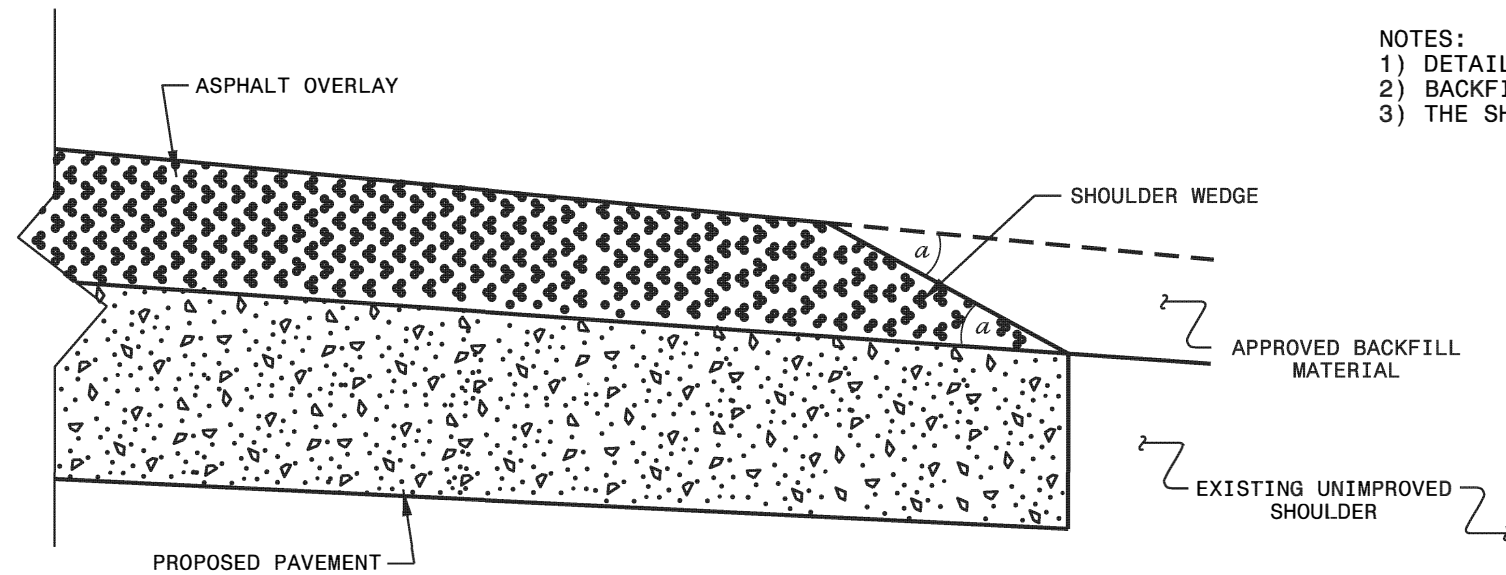

SHOULDER WEDGE DETAIL
 (Resurfacing Projects w/ Widening or
 with Existing Paved Shoulder having no dropoffs)

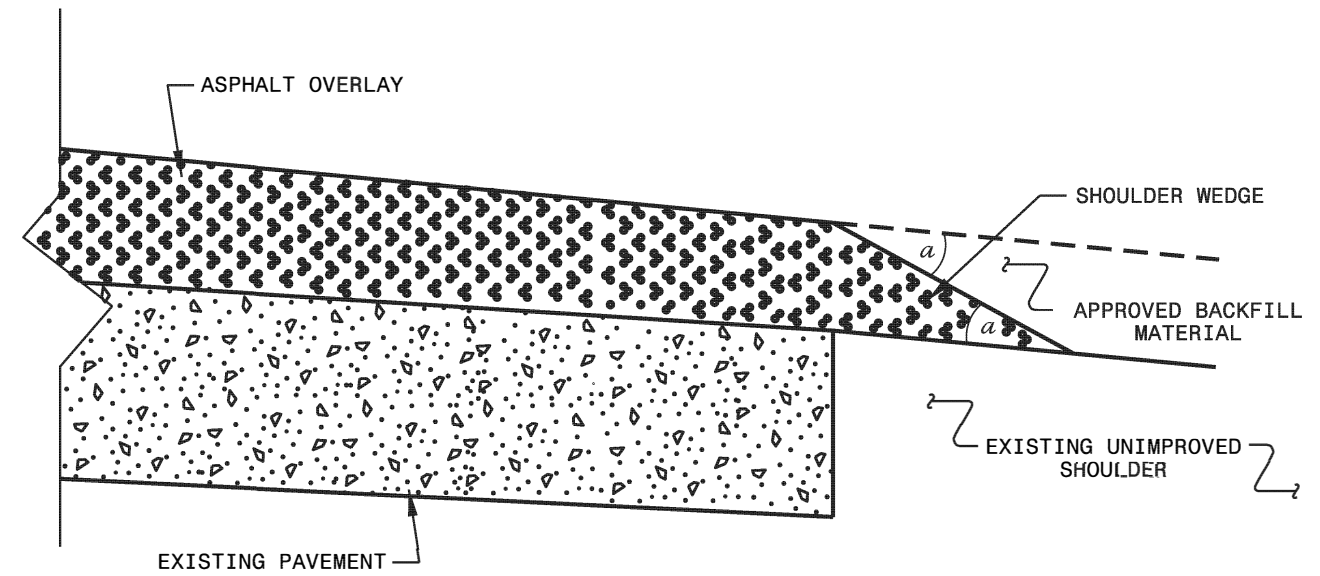

SHOULDER WEDGE DETAIL
 (Resurfacing Projects w/ NO Widening)

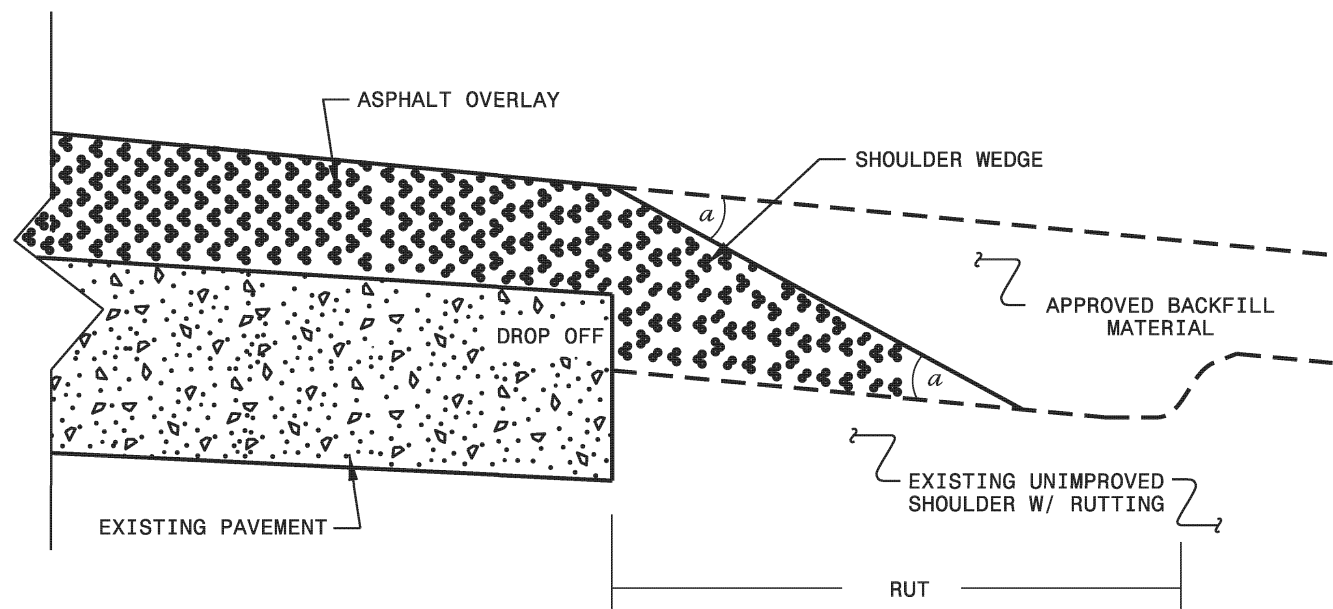

SHOULDER WEDGE DETAIL
 (Resurfacing Adjacent to
 Rutted Shoulder)

- SHOULDER WEDGE ANGLE = 30°

CONTRACT STANDARDS AND DEVELOPMENT UNIT	
Office 919-707-6950	FAX 919-250-4119
SHOULDER WEDGE DETAILS	
ORIGINAL BY: T.SPELL	DATE: 7-19-11
MODIFIED BY:	DATE: 10/18/12
CHECKED BY:	DATE:
FILE SPEC.: s:\usr\details\stand\shoulderwedge\detail.dgn	

SYSTEMS
 CONSULTANTS
 INC.

BRIDGE TREATMENT LIST						
WBS:	2024CPT.04.17.20511	WBS:	-	COUNTY :	JOHNSTON	
MAP #	ROADWAY TREATMENT	SR # (if applicable)	ROADWAY NAME	STRUCTURE #	BRIDGE SURFACE	STRUCTURE COMMENTS
1	1.5" S9.5B	SR 2105	BUCK ROAD	# 0156	ASPHALT	MILL 1.5" & PAVE 1.5" ; MILL & PAVE APPROACH SLAB FOR SMOOTH TRANSITION
2	1.5" S9.5B	SR 1718	STOTT'S MILL ROAD	# 0415	ASPHALT	MILL 1.5" & PAVE 1.5" ; MILL & PAVE APPROACH SLAB FOR SMOOTH TRANSITION
5	1.5" S9.5B	SR 1701	WENDELL ROAD	# 0169	ASPHALT	MILL 1.5" & PAVE 1.5" ; MILL & PAVE APPROACH SLAB FOR SMOOTH TRANSITION
9	1.5" S9.5B	SR 2102	FRIENDSHIP CHURCH ROAD	# 0051	CONCRETE	MILL & PAVE APPROACH SLAB ON SOUTH END OF BRIDGE STRUCTURE FOR SMOOTH TRANSITION ; DO NOT PAVE OVER CONCRETE BRIDGE DECK

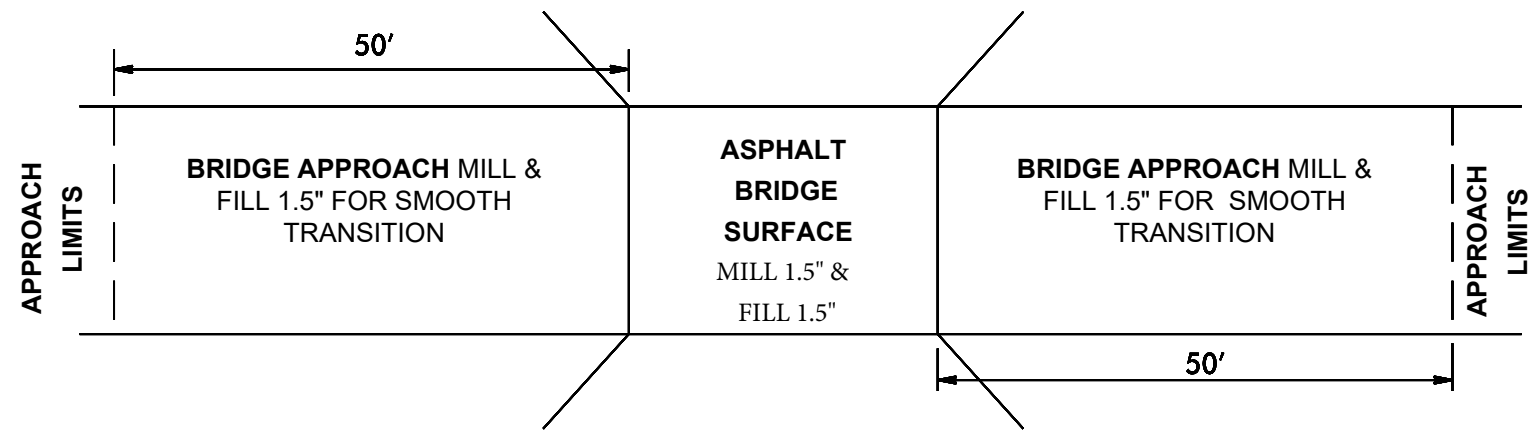

DETAIL FOR MAP # 1, 2, & 5 / STRUCTURE # 0156, # 0415, & # 0169

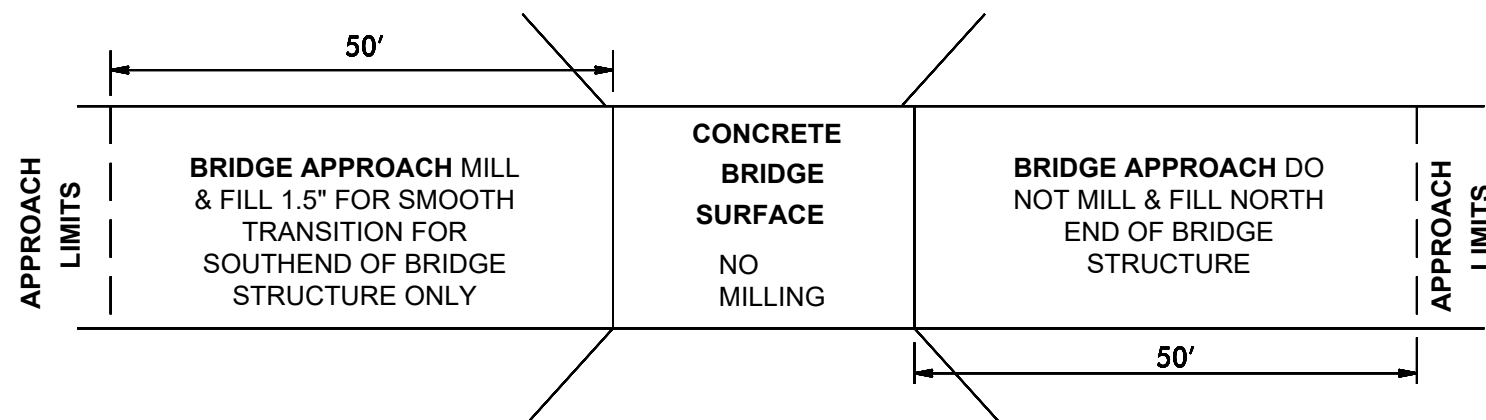

DETAIL FOR MAP # 9 / STRUCTURE # # 0051

High Speed Detection (≥40 mph)

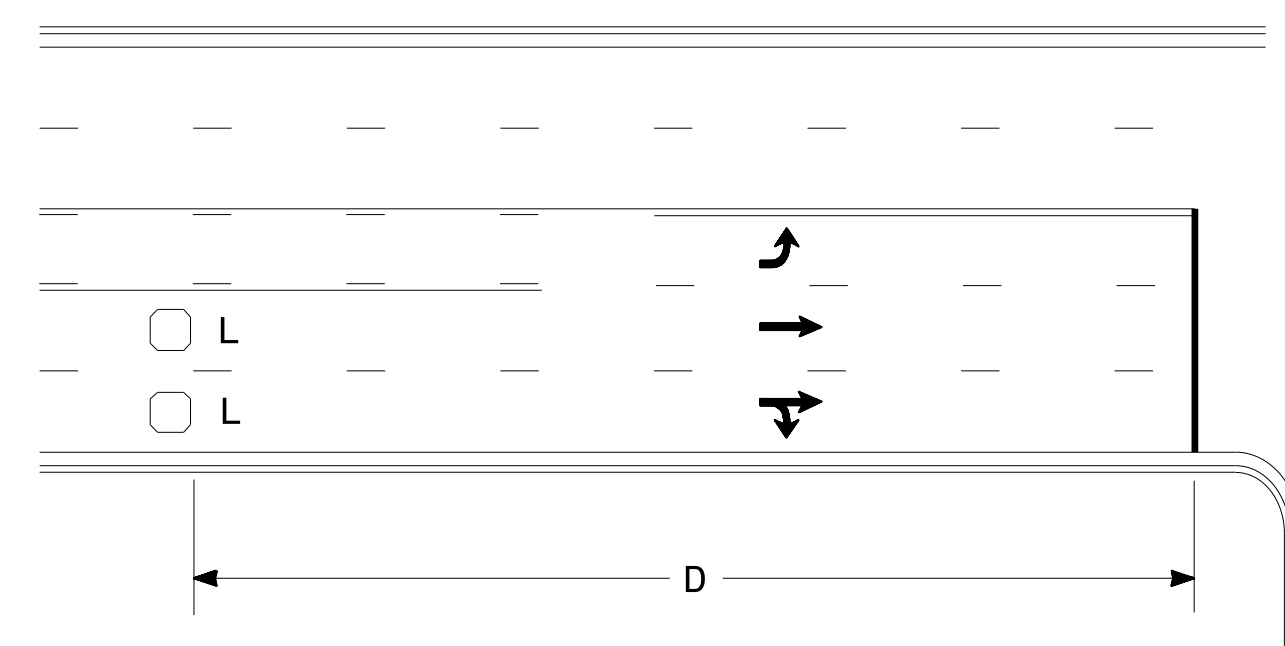

Speed Limit mph	D ft
40	250
45	300
50	355
55	420

L = 6ft X 6ft
Wired in series for TS1
Controllers
Wired separately for TS2,
170, and 2070L Controllers

Volume Density Operation

OR

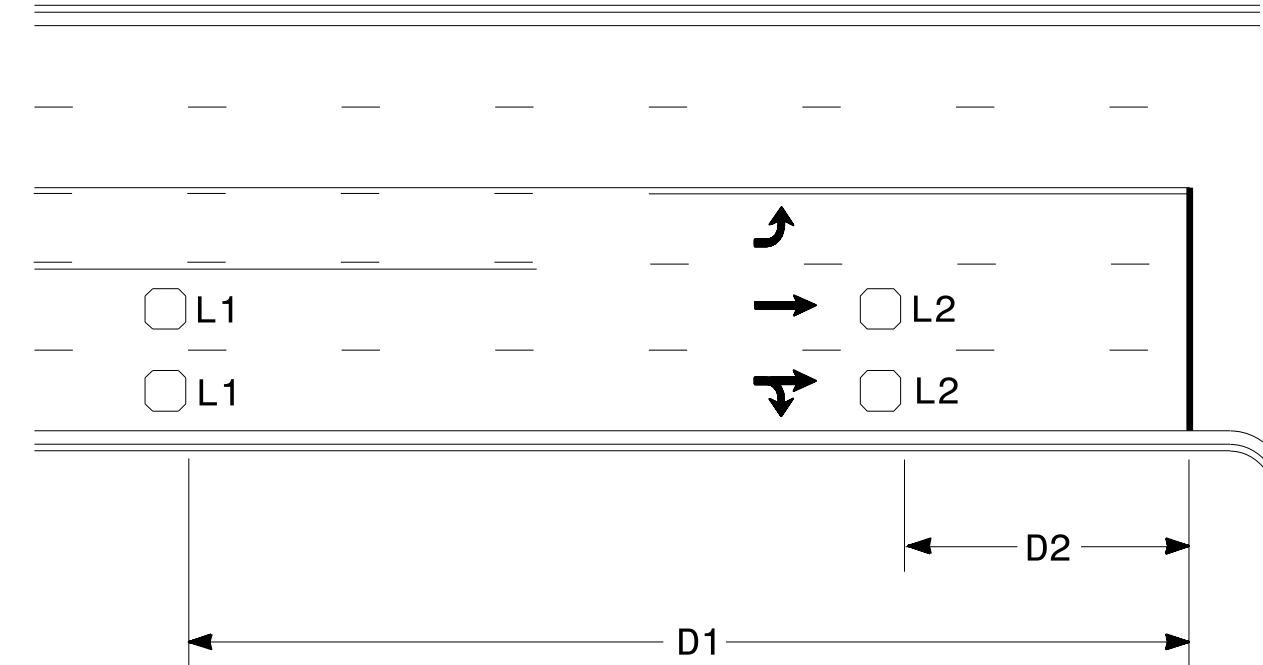

Speed Limit mph	D1 ft	D2 ft
40	250	80
45	300	90
50	355	100
55	420	110

L1 = 6ft X 6ft
Wired in series
L2 = 6ft X 6ft
Wired in series

"Stretch" Operation

Low Speed Detection (≤35 mph)

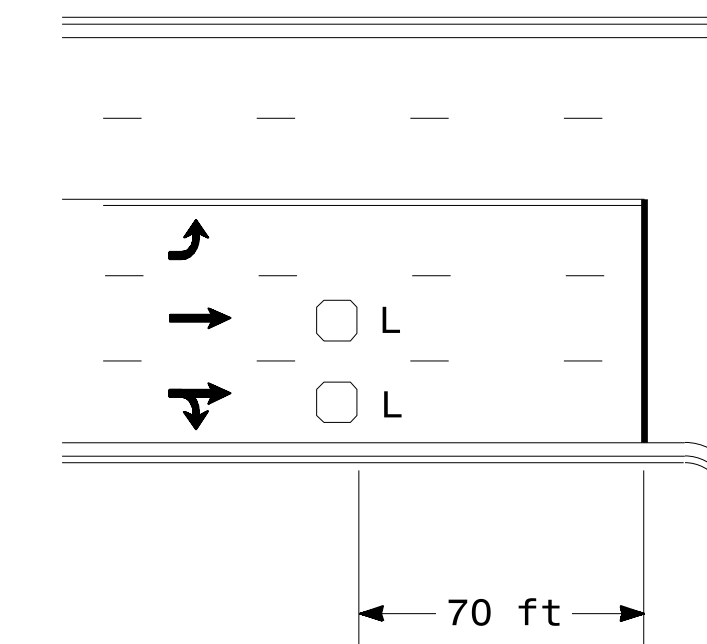

L = 6ft X 6ft
Wired in series

OR

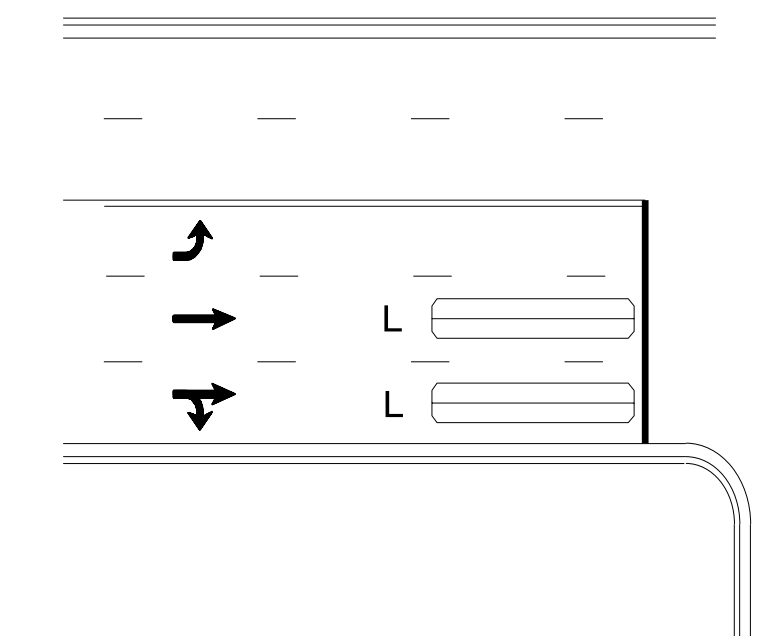

L = 6ft X 40ft
Quadrupole loop, wired separately

Left Turn Lane Detection

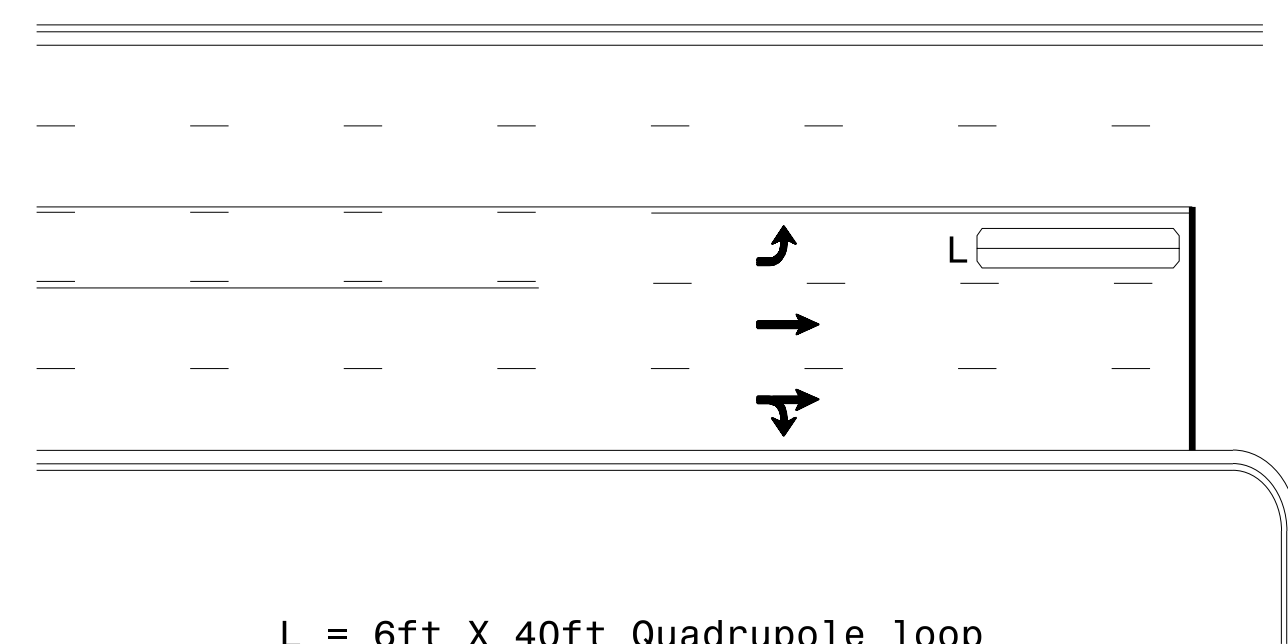

L = 6ft X 40ft Quadrupole loop

Presence Loop Detection

OR

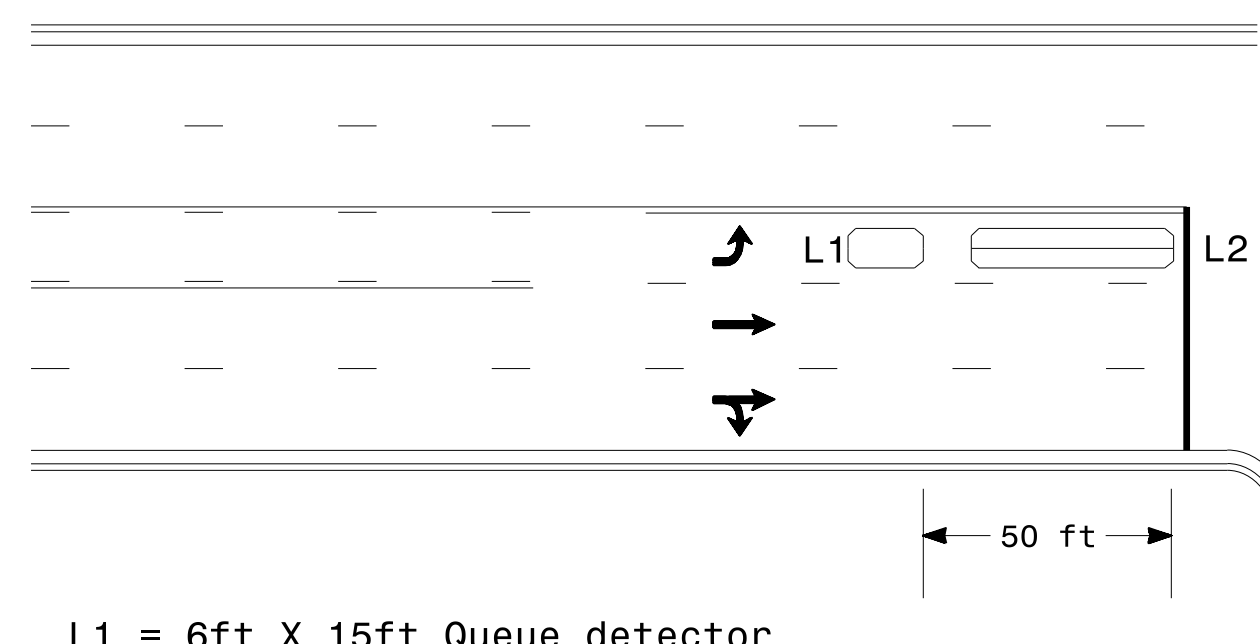

L1 = 6ft X 15ft Queue detector
L2 = 6ft X 40ft Quadrupole loop

Queue Loop Detection

Right Turn Lane Detection

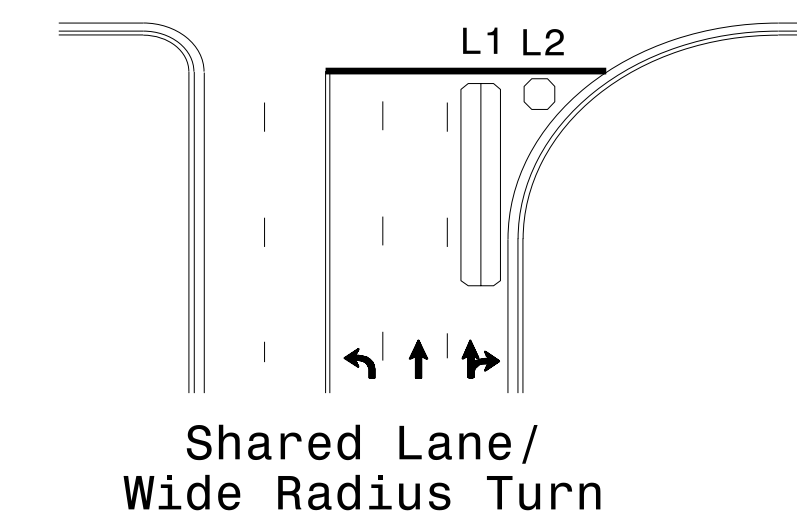

Shared Lane/
Wide Radius Turn

L1 = 6ft X 40ft Quadrupole loop
L2 = 6ft X 6ft [Minimum] Presence loop
Wired separately

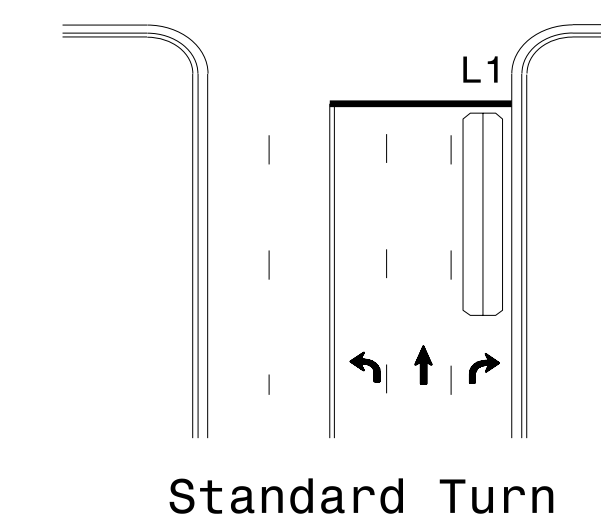

Standard Turn

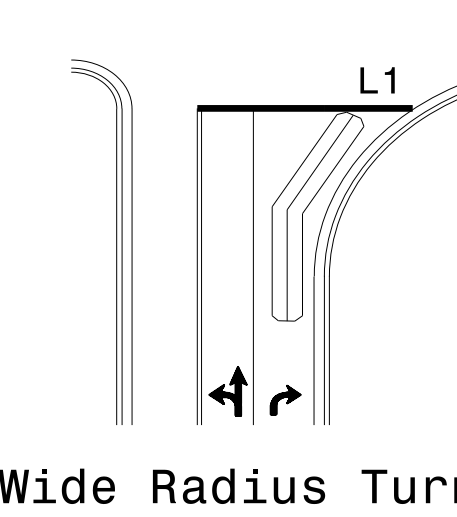

Wide Radius Turn

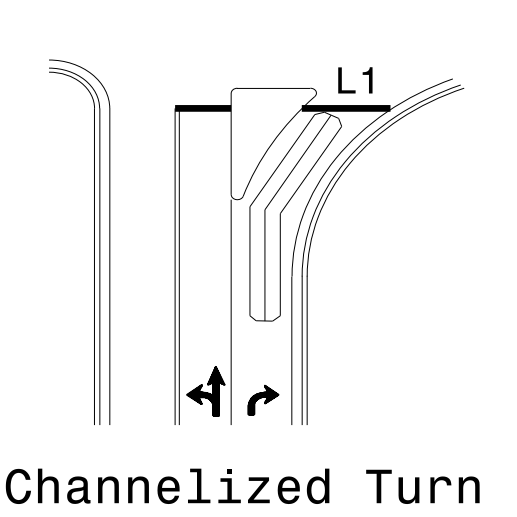

Channelized Turn

Side Street Detection

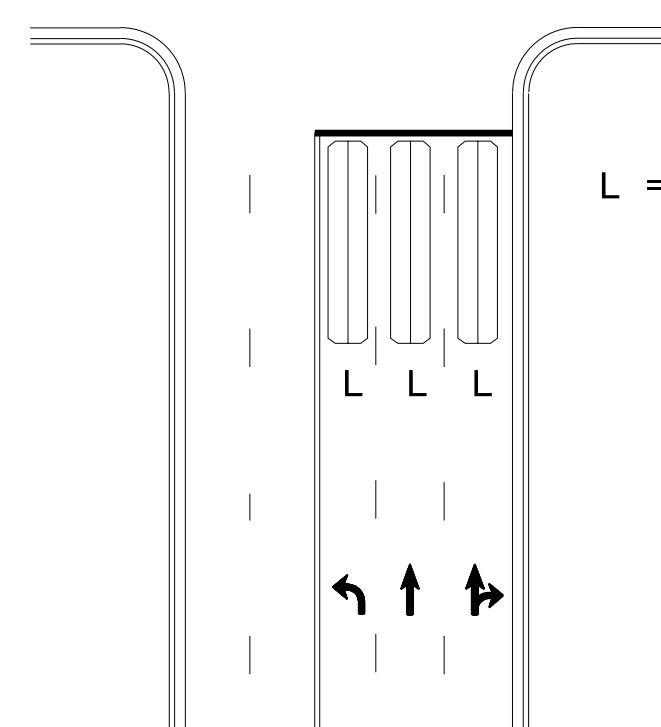

L = 6ft X 40ft
Quadrupole loop
Wired to separate
detectors/channels

Presence Loop Placement at Stop Lines

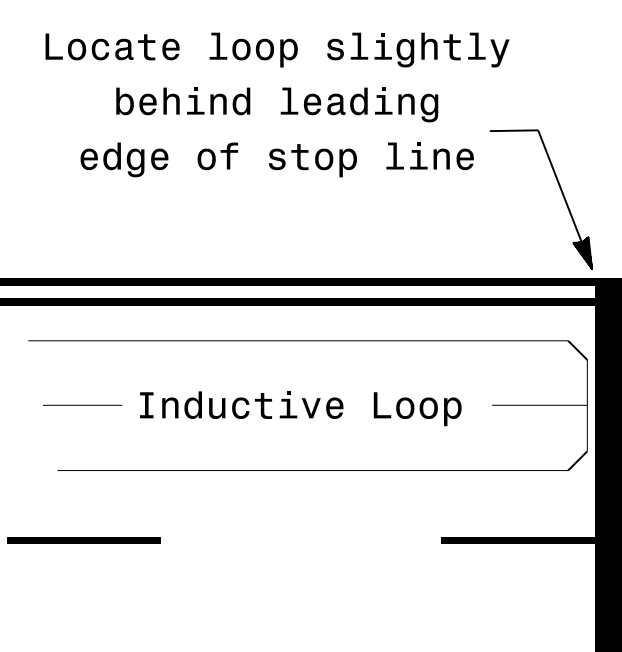

Locate loop slightly
behind leading
edge of stop line

Note:
Loop may be located in advance
of stop line under any of the
following conditions:
1) stop line is greater than 15'
from edge of intersecting
roadway
2) loop detects a permissive or
protected/permissive left turn
3) for an exclusive right turn
lane

Recommended Number of Turns

Single 6' X 6' loop
(when wired separately):

Length of Lead-in ft	Number of Turns
< 250	3
250-375	4
375-525	5
> 525	6

Quadrupole loops: Use 2-4-2 turns

6' X 15' Loops:
Lead-in < 150', use 2 turns
Lead-in > 150', use 3 turns

<p>Prepared In the Offices of: TRANSPORTATION MOBILITY AND SAFETY SOLUTIONS, INC. SIGNAL DESIGN SECTION 750 N. Greenfield Pkwy, Garner, NC 27529</p>	<p>Typical Signal Loop Locations</p>		<p>SEAL NORTH CAROLINA PROFESSIONAL ENGINEER PAMELA L. ALEXANDER 23489</p>
	<p>PLAN DATE: January 2015</p>	<p>REVIEWED BY: JPG</p>	
<p>PREPARED BY: PLA</p>	<p>REVIEWED BY:</p>	<p>REVISIONS</p>	<p>INIT. DATE</p>
<p>SIG. INVENTORY NO.</p>			<p>1/30/2015</p>

JOHNSTON COUNTY

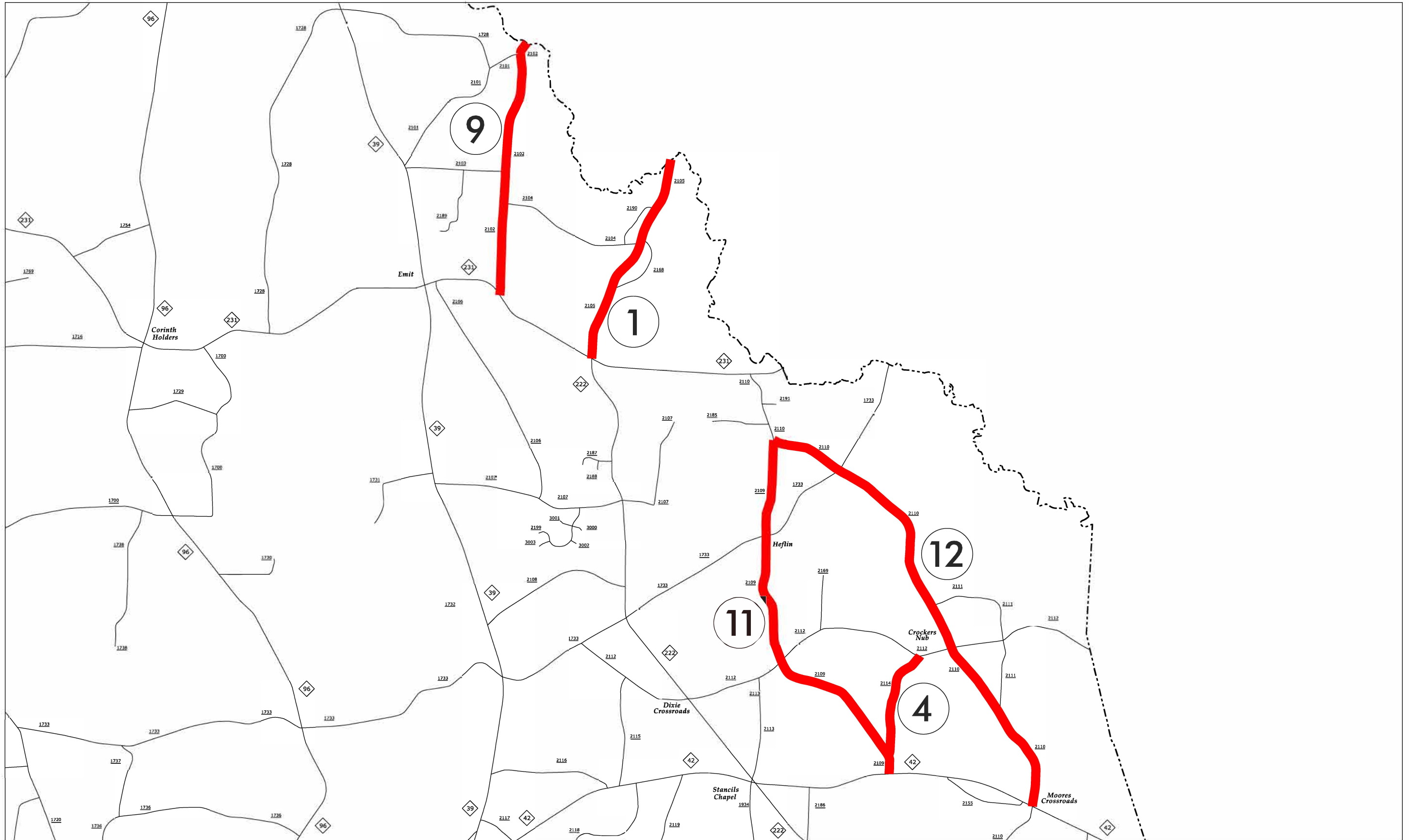

JOHNSTON COUNTY

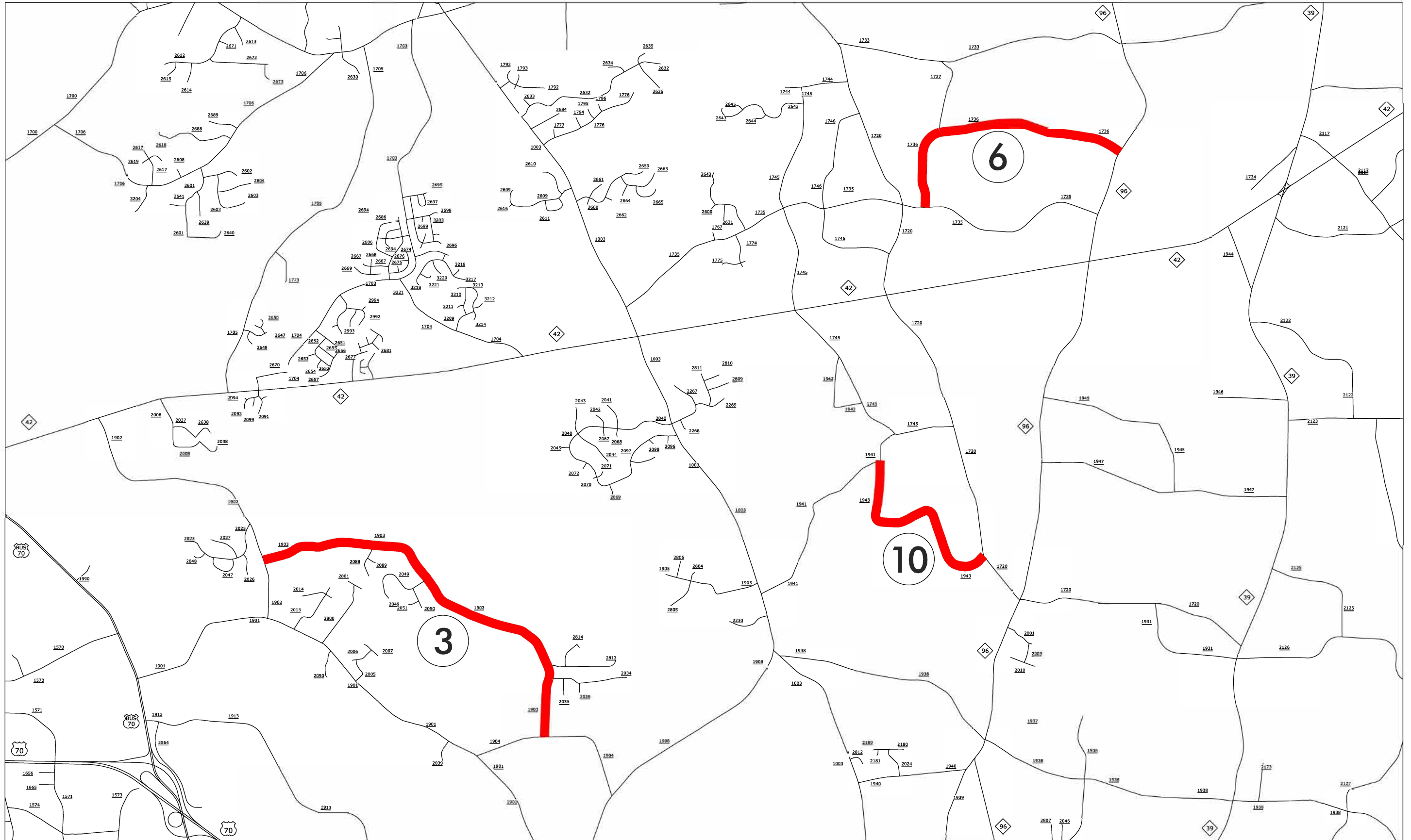

TC-1

WORK ZONE TRAFFIC CONTROL GENERAL REQUIREMENTS

TEMPORARY TRAFFIC CONTROL (TTC):

(7-16-13) (Rev. 12-08-20) (Rev. 02-18-21) (Rev. 11-13-23) (Rev. 03-27-24)

RWZ-1

Maintain traffic in accordance with Divisions 10, 11 and 12 of the *Standard Specifications* and the following provisions:

Install Work Zone Advance Warning Signs in accordance with the detail drawing provided in these plans prior to beginning any other work. Use a lane closure or slow moving operation to complete the work, as necessary, unless otherwise indicated. Refer to Standard Drawing No. 1101.02, 1101.11, 1110.01, 1110.02, 1130.01, 1135.01 and 1180.01 of the *Roadway Standard Drawings*. Use a moving operation only if the minimum speed maintained at all times is 3 mph with no stops that narrow or close a lane of travel. If the moving operation is progressing slower than 3 mph at any time, install a lane closure. Maintain the existing traffic pattern at all times, except in the immediate work zone where lane closures are allowed as determined by the Engineer. If applicable, maintain existing pedestrian facilities in accordance with *Pedestrian Accommodation at Curb Ramp Work Locations*, found elsewhere in this Contract.

Refer to attached details and Standard Drawing No. 1101.02, 1101.03, 1101.04, 1101.05, 1101.11, 1110.01, 1110.02, 1115.01, 1130.01, 1135.01, 1145.01, 1150.01, 1165.01, and 1180.01 of the *Roadway Standard Drawings* when closing a lane of travel in a stationary work zone such as pavement patching, resurfacing, curb ramp work, or pavement marking removal. Properly ballasted cones and skinny drums may be used instead of drums. However, drums are required for the upstream taper portion of lane closures in all applications. The stationary work zone shall be a maximum of 1 mile in length at any given time on 2 Lane, 2 Way facilities unless otherwise approved by the Engineer. A pilot vehicle operation may be used in conjunction with flaggers and the appropriate pilot vehicle warning signing as directed by the Engineer. During periods of construction inactivity, return the traffic pattern to the existing alignment and remove or cover any work zone signs. When covering work zone signs, use an opaque material that prevents reading of the sign at night by a driver using high beam headlights. Use material which does not damage the sign sheeting. Replace any obliterated markings as required by other sections of the *Standard Specifications* and the Engineer.

When personnel and/or equipment are working on the shoulder adjacent to and within 5 feet of an open travel lane, close the nearest open travel lane using Standard Drawing No. 1101.02 of the *Roadway Standard Drawings*. When personnel and/or equipment are working within a lane of travel of an undivided facility, close the lane according to the traffic control plans, *Roadway Standard Drawings* or as directed by the Engineer. Conduct the work so that all personnel and/or equipment remain within the closed travel lane. Do not work simultaneously, on both sides of an

TC-2

open travel way, within the same location, on a two-lane, two-way road. Perform work only when weather and visibility conditions allow safe operations as directed by the Engineer.

When utilizing a slow-moving operation for such items as pavement marking and marker placement, the operation shall consist of the vehicles and devices as shown on Roadway Standard Drawing No. 1101.02, Sheet 14 or 15, of the *Roadway Standard Drawings*. Traffic cones may be used when necessary to provide additional protection of wet pavement markings. Ballast all traffic cones so they will not be blown over by traffic.

PAVING OPERATIONS:

1) Paving Lift Requirements and Time Limitations:

For paving lifts of 2 inches or less, bring all newly resurfaced lanes to the same station and elevation within 72 hours. If not brought up to the same station and elevation within 72 hours, the Contractor shall place portable UNEVEN PAVEMENT signs in advance of the uneven pavement and spaced every 1/2 mile along the section of uneven pavement. Once mitigated, all portable UNEVEN PAVEMENT signs shall be removed. No additional compensation will be made for these signs or any other type of portable warning signs as these are included as part of the *Temporary Traffic Control* contract pay item.

For paving lifts greater than 2 inches, bring all newly resurfaced lanes to the same station and elevation by the end of each work day unless the Contractor utilizes the notched wedge paving methods as described below.

Failure to comply with the following requirements will result in a suspension of all other operations until all lanes of traffic are brought to the same station and elevation:

1. During paving operations, any paving lift greater than 2 inches for asphalt surface course mixes shall be mitigated by having an approved wedge apparatus on the paver that shapes the edge 1 inch vertically and the remaining at a maximum slope steepness of 2:1. For intermediate and base course mixes, use an approved wedge device that shapes the edge with a maximum slope steepness of 2:1. The maximum paving lift allowed to use this method is 3 inches.
2. At the end of the work day, the Contractor shall place portable UNEVEN PAVEMENT signs in advance of the uneven pavement and spaced every 1/2 mile along the section of uneven pavement. Once mitigated, all portable UNEVEN PAVEMENT signs shall be removed. No additional compensation will be made for these signs or any other type of portable warning signs as these are included as part of the *Temporary Traffic Control* contract pay item.

TC-3

3. In the next day's paving operation and not to exceed 72 hours, the Contractor shall bring up the adjacent lane to the same station and elevation before any further paving takes place on the project.

2) Asphalt Surface Treatments (AST)

For AST Operations, there is no drop-off condition to be signed. Stationary LOOSE GRAVEL and UNMARKED PAVEMENT signs shall replace LOW/SOFT SHOULDER signs. For placement and spacing of these signs, see the Signing Detail Sheet. All other advance warning signs are to be portable mounted. These signs are included as part of the *Temporary Traffic Control* contract pay item.

3) Fine Milling/Microsurfacing (Depths less than 1")

For fine milling operations less than 1", paving is not required in the same work period. The paving of the fine milled area is to be conducted within the next work period and not to exceed 72 hours. No advance warning signs are necessary for these conditions unless the paving operations exceed 72 hours. If this occurs, install portable UNMARKED PAVEMENT signs. These signs are incidental to the other items of work included as part of the *Temporary Traffic Control* contract pay item.

4) Shoulder Drop-Off Requirements

Whenever paving operations create an edge of pavement drop-off greater than 2 inches, within 72 hours, the Contractor shall backfill at a 6:1 slope from the edge and finished elevation of the pavement that has an edge of pavement drop-off as follows:

- (A) Drop-off that exceeds 2 inches on roadways with posted speed limits of 45 mph or greater.
- (B) Drop-off that exceeds 3 inches on roadways with posted speed limits less than 45 mph.

Backfill the edge of pavement drop-off with suitable compacted material, as approved by the Engineer. The material, equipment and labor associated with this operation will be paid as *Aggregate Shoulder Borrow* or *Borrow Excavation* in accordance with the *Shoulder Reconstruction Per Shoulder Mile* special provision found elsewhere in the contract. If the *Shoulder Reconstruction Per Shoulder Mile* special provision is not included in the contract, the work of pavement drop-off repair as described above will be paid as extra work in accordance with Article 104-7.

PROJECT REQUIREMENTS:

Failure to comply with the following requirements will result in a suspension of all other operations:

TC-4

1. Before working on ANY MAP, the Contractor shall submit a written construction sequence for traffic control and construction lighting for ALL MAPS to the Engineer at the first pre-construction meeting and the sequence must be approved before closing a lane of traffic. If applicable, the Contractor shall also submit a description of how pedestrian access will be maintained during any curb ramp work. Refer to *Pedestrian Accommodation at Curb Ramp Work Locations*, found elsewhere in this Contract, for pedestrian maintenance requirements.
2. The temporary use of portable concrete barrier and the need for any long-term temporary traffic patterns are not anticipated and are not covered by this provision. If the Engineer determines there is a need, then coordinate with the Work Zone Traffic Control Section at 919-814-5000.
3. Obtain written approval of the Engineer before working in more than one location or setting up additional lane closures. The maximum length of any one lane closure is 1 mile unless otherwise directed by the Engineer.
4. If Lane Closure Restrictions apply, see Intermediate Contract Times and Liquidated Damages special provision.
5. Contractor shall mill and pave lanes in an order such that water shall not accumulate.
6. Traffic Control for the milling and/or paving of ramps is to be done according to Standard Drawing No 1101.02, Sheets 10 & 11, unless otherwise approved to be closed by the Engineer. If approved, Contractor will provide plans and devices for the detour according to Standard Drawing No 1101.02, Sheets 12 & 13, at no additional cost to the department.
7. If milled areas are not paved back within 72 hours, the Contractor is to furnish and install portable signs to warn drivers of the conditions. These are to include, but not limited to ROUGH ROAD (W8-8), UNEVEN LANES (W8-11), and GROOVED PAVEMENT (W8-15) w/ Motorcycle Plaque mounted below. These are to be dual indicated on Multi-Lane Roadways with speed limits of 45 mph and greater where lateral clearance can be obtained within the median areas. These portable signs are incidental to the other items of work included as part of the *Temporary Traffic Control* contract pay item.

TC-5

WORK ZONE SIGNING:

Description

Install advance/general warning work zone signs according to the Detail Drawing provided in these plans prior to beginning of work. Install and maintain signing in accordance with the attached drawings and Divisions 11 and 12 of the *Standard Specifications*.

(A) Installation

All stationary Advance/General warning work zone signs require notification to existing Utility owners per Article 105-8 of the *Standard Specifications* within 3 to 12 full working days prior to installation.

Install Advance/General warning work zone signs before beginning work on a particular map. If signs are installed more than 7 calendar days prior to the beginning of work on a particular map, cover the signs until the work begins. Install each work zone Advance/General warning sign separately and not on the same post or stand with any other sign except where an advisory speed plate or directional arrow is used.

All stationary signing is to be installed as shown on the detail drawing(s) unless otherwise directed by the Engineer. The signs as shown on the detail drawing(s) are all that are required for a contractor to begin a resurfacing contract. Any additional signs requested by the Engineer shall be installed within 7 business days of the start of contract work. All sign locations are to be verified by the Engineer prior to installation. Once the signs have been installed and accepted, any sign relocations requested by the Department will be compensated in accordance with Article 104-7. Any additional signs other than the ones shown in the drawing will be compensated in accordance with Article 104-7.

No stationary -Y- Line advance warning signage is required unless there is more than 1,000 feet of resurfacing along the -Y- line. Whenever work proceeds through an intersection, portable signs shall be used for traffic control. There will be no direct compensation for any portable signing.

If there is a period of construction inactivity longer than 14 calendar days, remove or cover advance/general warning work zone signs. Uncover advance/general warning work zone signs no more than 7 calendar days before work resumes. All other operations may be suspended upon failure to comply with the above requirements. Such suspended operations would not be resumed until the above requirements are fulfilled.

TC-6

(B) Sign Removal

Once Maps on the Project are substantially complete, it is acceptable practice to remove the Stationary Work Zone Signs in lieu of waiting until all of the Maps are completed on the Project. A Map is substantially complete when the resurfacing operations are finished and the shoulders are brought up to the same elevation as the proposed pavement and when pavement markings (paint) are installed along the centerline and edge lines. The final pavement markings (ex. Thermoplastic/Polyurea) or pavement markers (Raised/Snowplowable) do not have to be installed for Maps to be considered substantially complete. Final pavement marking/markers are installed with portable signing according to Roadway Standard Drawing 1101.02, Sheets 14 & 15. Any remaining punch list items requiring traffic control are compensated as part of the *Temporary Traffic Control* contract pay item.

Stationary Work Zone Sign removal is a condition of final project acceptance.

(C) Lane Closure Work Zone Signs

Install any required lane closure signing needed during the life of the project in accordance with Standard Drawing No. 1101.02, 1101.11 and 1110.02 of the *Roadway Standard Drawings*. Any required portable signs for lane closures are compensated as part of the *Temporary Traffic Control* contract pay item.

MEASUREMENT AND PAYMENT:

Temporary traffic control work, including, but not limited to installation and removal of portable signs, cones, drums, skinny drums, flaggers, AFAD's, portable traffic signals, changeable message boards, truck mounted attenuators, flashing arrow boards, and pilot vehicles for the sole purpose of maintaining vehicular traffic will be paid at the contract lump sum price for *Temporary Traffic Control*.

The *Temporary Traffic Control* pay item does not include work zone advance or general warning signs.

The *Temporary Traffic Control* pay item does not include Pedestrian Channelizing Devices and applicable signs, Audible Warning Devices, Temporary Curb Ramps, or a Pedestrian Transport Service required for the sole purpose of maintaining pedestrian movements. Refer to *Pedestrian Accommodation at Curb Ramp Work Locations*, found elsewhere in this Contract, for measurement and payment information for these items.

Partial payments for *Temporary Traffic Control* will be made as follows: The cumulative total of the lump sum price for temporary traffic control will be equal to the percent complete (project) as

TC-7

calculated for each partial pay estimate. Additional flashing arrow boards and message boards beyond those shown in the contract, detail drawings or *Roadway Standard Drawings* required by the Engineer will be paid as extra work in accordance with Article 104-7 of the *Standard Specifications*.

The work of satisfactorily installing and removing work zone advance and/or general warning signs, including, but not limited to, furnishing, locating, installing, covering, uncovering and removing stationary signs will be measured for each required sign and paid at the contract price for *Work Zone Advance/General Warning Signing (SF)*. Payment for *Work Zone Advance/General Warning Signing* will be limited to a maximum of 90% of the total installed quantity. The remaining 10% will be paid once all signs have been removed.

The Lump Sum price for *Temporary Traffic Control* will include the work of 4 flaggers per operation per map being utilized at the same time on any day. If a pilot vehicle is used for an operation, the Lump Sum Price for *Temporary Traffic Control* will include the work of five (5) flaggers. The operator of a pilot vehicle will be considered one of the five flaggers.

Any additional flagging beyond the included amount covered in the *Temporary Traffic Control* pay item will be considered supplemental flagging and compensated at a rate of \$35.00 per hour for each additional flagger as approved by the Engineer. The minimum measurement for each additional flagger will be 4 hours, even if the actual additional flagger hours are less than 4 hours.

Payment will be made under:

Pay Item	Pay Unit
Temporary Traffic Control	Lump Sum
Work Zone Advance/General Warning Signing	Square Foot

TC-8

RESURFACING OPERATIONS:

(7-15-14) (11-13-23)

RWZ-2

Coordinate the installation of items required by the contract documents and resurfacing operations such that these operations are completed in the order as agreed upon with the Engineer at the first pre-construction meeting. Refer to the Provisions, Typicals and Details unless otherwise directed by the Engineer.

Notify the Engineer 15 consecutive calendar days before resurfacing a bridge or its approaches. Patch and make repairs to bridge surface and its approaches before resurfacing occurs. Coordinate all operations on the bridge and its approaches with the Engineer.

Notify the Engineer 48 hours before resurfacing the areas of existing pavement that require patching. Patch these areas before resurfacing occurs. Allow full depth asphalt patching to cool to the point of supporting traffic without displacement or rutting before reopening closed lane. Coordinate the resurfacing operations of the patched areas with the Engineer.

Notify the Engineer 48 hours before milling or resurfacing will interfere with the existing Signal Loops. Loops may need to be placed in milled surface before resurfacing occurs. Coordinate all signal loop operations with the Engineer.

For partial or wheel track milling operations on two-way, two-lane facilities, mill and pave back by the end of each work day. For Partial or wheel track milling operation on multi-lane facilities, the lane being milled may be left closed and paved back within 72 hours.

The following options are available during Resurfacing and milling operations on two-way, two-lane facilities when the entire roadway or entire lane is to be milled:

- (A) Mill a single lane and pave back by the end of each work day.
- (B) Mill the entire width of roadway and pave back within 72 hours.

The following options are available during Resurfacing and milling operations on multi-lane facilities when all lanes or a single lane in one direction are to be milled:

- (A) Mill a single lane and pave back by the end of each work day.
- (B) Mill the entire width of pavement for all lanes to be milled in any direction daily and pave back within 72 hours.

Slope the pavement at the beginning and end of the daily milling operation as directed by the Engineer. Sweep and remove all milled material from the roadway as soon as the daily milling operation is completed. Continue milling operations until the section of roadway being milled is complete. Remove any existing pavement adjacent to the milled area that has been damaged and replace it with patch material as directed by the Engineer.

Operate equipment and conduct operations in the same direction as the flow of traffic. Maintain vehicular access in accordance with Section 1101-05 of the *Standard Specifications* using suitable backfill material approved by the Engineer.

TC-9

Provide appropriate lighting in accordance with Section 1413 of the *Standard Specifications*.

Milled Rumble Strips

When utilized, milled rumble strips shall be installed in accordance with the *Standard Specifications* and the Roadway Standard Drawing 665.01.

TC-10

PAVEMENT MARKINGS AND MARKERS:

(7-15-14) (11-13-23)

RWZ-3

Markings: All Facilities

Pavement markings shall be installed in accordance with Standard Drawings 1205.01 through 1205.15 of the *Roadway Standard Drawings* and Section 1205 of the *Standard Specifications* with the exception of the following changes underlined in Table 1205-1 in Subarticle 1205-3(D):

(D) TIME LIMITATIONS FOR REPLACEMENT

TABLE 1205-1 TIME LIMITATIONS FOR REPLACEMENT		
Facility Type	Marking Type	Replacement Deadline
Full-control-of-access multi-lane roadway (4 or more total lanes) and ramps, including Interstates	All markings	By the end of each workday's operation if the lane is opened to traffic
Multi-lane roadways (3 or more lanes) and ramps	Center Line, Lane Line, Railroad symbols, Stop bars, school symbols and <u>crosswalk markings</u>	By the end of each workday's operation if the lane is opened to traffic (temporary paint with beads may be used)
	Edge Lines, gore lines and all other symbols	By the end of the 3rd calendar day after obliteration
Two-lane, two-way roadways	All centerline markings, railroad, Stop bars, school symbols and <u>crosswalk markings</u>	By the end of the 5th calendar day after obliteration
	Edge Lines and all other symbols	By the end of the <u>30th</u> calendar day after obliteration

Prior to placing pavement marking material on concrete surfaces that are diamond ground, use an acceptable method to grind ridges smooth only where pavement marking will be installed.

Type 3 Cold Applied Plastic may be used in lieu of Type 2 Cold Applied Plastic. If Type 3 Cold Applied Plastic is used, it shall be paid for using the Type 2 Cold Applied Plastic pay item.

TC-11

Unless otherwise specified, Heated-in-Place Thermoplastic may be used in lieu of Extruded Thermoplastic for stop bars, symbols, characters and diagonals. If Heated-in-Place Thermoplastic is used, it shall be paid for using the Extruded Thermoplastic pay item.

Unless otherwise specified, Heated-in-Place Thermoplastic may be used in lieu of Cold Applied Plastic for stop bars, symbols, characters and diagonals on asphalt or concrete roadways. If Heated-in-Place Thermoplastic is used, it shall be paid for using the Cold Applied Plastic pay item.

Markers: All Facilities

Remove existing pavement markers in preparation for paving. Repair any pavement damage due to existing pavement marker removal prior to the end of the work day. Dispose of existing pavement markers as directed by the Engineer. No direct payment will be made for this work as it will be incidental to the paving operation.

Install permanent pavement markers within 60 calendar days after completing the resurfacing on each map. Pavement markers shall be installed in accordance with Standard Drawing 1205.12 and Standard Drawings 1250.01 through 1253.01 of the *Roadway Standard Drawings* and Sections 1250 through 1253 of the *Standard Specifications*.

Markings and Markers: All Facilities

Review and record the existing pavement markings and markers before resurfacing. Re-establish the new pavement markings and markers using the record of existing markings in conjunction with the *Roadway Standard Drawings*. Unless otherwise directed by the Engineer, new pavement markings not meeting the current standards should be updated to the *Roadway Standard Drawings*. Have existing or proposed passing zones reviewed by the engineer before installation. Submit the record of the existing pavement markings seven calendar days before the obliteration of any pavement markings.

Mainline pavement shall not be left milled, unmarked or uneven at the end of a paving season. If the Contractor begins any map and does not complete within the seasonal restrictions, including placement of final pavement markings or permanent markers, the Contractor shall be responsible for, at his expense, Paint in accordance with Article 1205-08 and Temporary Markers in accordance with Section 1251 of the *Standard Specifications*.

SIGNING FOR RESURFACING PROJECTS

LEGEND

┆ STATIONARY SIGN

← DIRECTION OF TRAFFIC FLOW

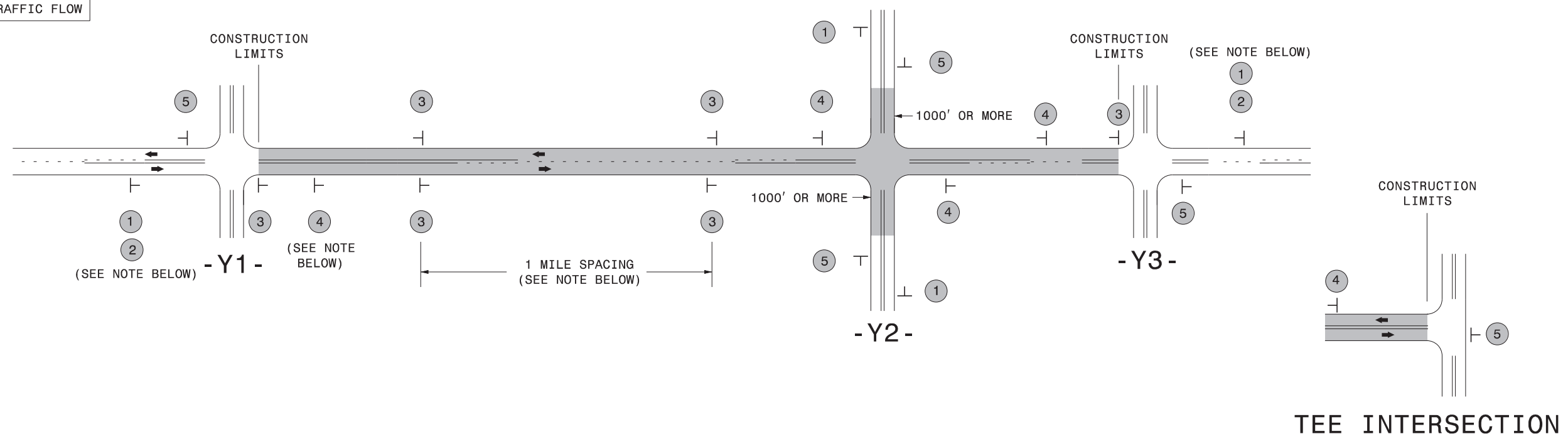

MAINLINE (-L-) SIGNING

-Y- LINE SIGNING

SIGNING NOTES AND PLACEMENT PER DIRECTION	1		PLACE 1000' PRIOR TO BEGINNING OF CONSTRUCTION LIMITS. ONLY USED ON -Y- LINES IF RESURFACING LIMITS EXTEND 1000' ALONG -Y- LINE.	<p>NO REQUIRED STATIONARY SIGNING FOR THE FOLLOWING -Y- LINE CONDITIONS:</p> <ol style="list-style-type: none"> LESS THAN 1000' OF RESURFACING ALONG -Y- LINE SUBDIVISION ROADS DEAD END ROADS <p>WHEN PAVING/CONSTRUCTION ACTIVITIES PROCEED ACROSS AN UNSIGNED -Y- LINE, PORTABLE ADVANCE WARNING SIGNS SHALL BE USED ALONG THE -Y- LINE AS SHOWN BELOW. REMOVE UPON COMPLETION OF WORK.</p> <div style="display: flex; justify-content: space-around;"> <div style="text-align: center;"> W20-1 48" X 48" PLACED 500' IN ADVANCE OF FLAGGER. </div> <div style="text-align: center;"> W20-7 A 48" X 48" PLACED 250' IN ADVANCE OF FLAGGER. </div> </div>
	2		#2 SIGN ONLY USED WHEN CONSTRUCTION LIMITS ARE 2 OR MORE MILES IN LENGTH. ROUND UP TO NEXT WHOLE NUMBER. (NO FRACTIONAL OR DECIMAL NUMBERS)	
	3		<ul style="list-style-type: none"> PLACE INITIALLY AT THE CONSTRUCTION LIMITS AND SPACE 1 MILE APART THEREAFTER. AT TEE INTERSECTIONS INSTALL INITIALLY 1/2 MILE FROM INTERSECTION AND SPACE 1 MILE APART THEREAFTER. 	
	4		<ul style="list-style-type: none"> THESE ARE FOR -Y- LINES THAT ARE "THROUGH" ROADWAYS. DEAD END AND SUBDIVISION ROADS ARE NOT "THROUGH" ROADWAYS. INSTALL 500' +/- FROM EACH -Y- LINE APPROACH AS SHOWN ABOVE. FOR MULTIPLE -Y- LINES THAT ARE SEPARATED BY 0.25 MILES OR LESS, TREAT AS A SINGLE UNIT AND INSTALL WITHIN 500' OF EACH APPROACH. A MAXIMUM OF 2 SIGN SETS PER MILE. DO NOT INSTALL WHEN -Y- LINES ARE WITHIN 0.5 MILES FROM "END ROAD WORK" SIGN. FOR TEE INTERSECTIONS, INSTALL WITHIN 500' +/- OF THE INTERSECTION ALONG -L- LINE. 	
	5		PLACE 500' FOLLOWING THE END OF CONSTRUCTION LIMITS OR AS SHOWN WHEN WORK ENDS AT A 3-WAY TEE INTERSECTION.	

THE ABOVE SIGNS ARE ALL THAT ARE REQUIRED FOR A CONTRACTOR TO BEGIN A RESURFACING CONTRACT. ANY ADDITIONAL SIGNS REQUESTED BY NCDOT DIVISIONS SHALL BE INSTALLED WITHIN 7 BUSINESS DAYS OF THE START OF CONTRACT WORK.

MAPS LESS THAN 2 MILES

FOR RESURFACING MAPS WITH CONSTRUCTION LIMITS LESS THAN 2 MILES IN LENGTH, NO STATIONARY SIGNS ARE REQUIRED. USE PORTABLE "ROAD UNDER CONSTRUCTION" OR "ROAD WORK AHEAD" SIGNS IN LIEU OF STATIONARY ADVANCE WARNINGS SIGNS.

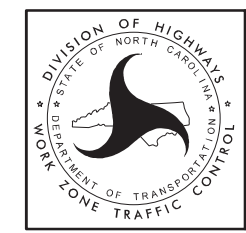

ADVANCE WARNING SIGNS FOR RURAL AND SUBURBAN 2-LANE ROADWAY RESURFACING

STANDARD SPECIAL PROVISION
AVAILABILITY OF FUNDS – TERMINATION OF CONTRACTS

(5-20-08)(Rev. 1-16-24)

Z-2

General Statute 143C-6-11. (h) Highway Appropriation is hereby incorporated verbatim in this contract as follows:

(h) Amounts Encumbered. – Transportation project appropriations may be encumbered in the amount of allotments made to the Department of Transportation by the Director for the estimated payments for transportation project contract work to be performed in the appropriation fiscal year. The allotments shall be multiyear allotments and shall be based on estimated revenues and shall be subject to the maximum contract authority contained in *General Statute 143C-6-11(c)*. Payment for transportation project work performed pursuant to contract in any fiscal year other than the current fiscal year is subject to appropriations by the General Assembly. Transportation project contracts shall contain a schedule of estimated completion progress, and any acceleration of this progress shall be subject to the approval of the Department of Transportation provided funds are available. The State reserves the right to terminate or suspend any transportation project contract, and any transportation project contract shall be so terminated or suspended if funds will not be available for payment of the work to be performed during that fiscal year pursuant to the contract. In the event of termination of any contract, the contractor shall be given a written notice of termination at least 60 days before completion of scheduled work for which funds are available. In the event of termination, the contractor shall be paid for the work already performed in accordance with the contract specifications.

Payment will be made on any contract terminated pursuant to the special provision in accordance with Subarticle 108-13(D) of the *Standard Specifications*.

STANDARD SPECIAL PROVISION
ERRATA

(1-16-24)

Z-4

Revise the *2024 Standard Specifications* as follows:

Division 3

Page 3-5, Article 305-2 MATERIALS, after line 16, replace " 1032-3(A)(7)" with "1032-3" and add the item "Galvanized Corrugated Steel Pipe" with Section "1032-3".

Page 3-6, Article 310-2 MATERIALS, after line 9, add the item "Galvanized Corrugated Steel Pipe" with Section "1032-3".

Division 9

Page 9-17, Article 904-4 MEASUREMENT AND PAYMENT, prior to line 1, replace " Sign Erection, Relocate Type (Ground Mounted)" with "Sign Erection, Relocate Type ___ (Ground Mounted)".

Division 10

Page 10-51, Article 1024-4 WATER, prior to line 1, delete the "unpopulated blank row" in Table 1024-2 between "Time of set, deviation from control" and "Chloride Ion Content, Max.".

Page 10-170, Subarticle 1081-1(C) Requirements, line 4, replace "maximum" with "minimum".

Division 11

Page 11-15, Article 1160-4 MEASUREMENT AND PAYMENT, line 24, replace "Where barrier units are moved more than one" with "Where barrier units are moved more than once".

Division 15

Page 15-10, Article 1515-4 MEASUREMENT AND PAYMENT, lines 11, replace " All piping" with "All labor, the manhole, other materials, excavation, backfilling, piping".

Division 16

Page 16-14, Article 1633-5 MEASUREMENT AND PAYMENT, line 20-24 and prior to line 25, delete and replace with the following " *Flocculant* will be measured and paid in accordance with Article 1642-5 applied to the temporary rock silt checks."

Page 16-3, Article 1609-2 MATERIALS, after line 26, replace "Type 4" with "Type 4a".

Page 16-25, Article 1644-2 MATERIALS, after line 22, replace "Type 4" with "Type 4a".

STANDARD SPECIAL PROVISION

PLANT AND PEST QUARANTINES

(Imported Fire Ant, Gypsy Moth, Witchweed, Emerald Ash Borer, Guava Root Knot Nematode, And Other Noxious Weeds)

(3-18-03) (Rev. 5-21-19)

Z-04a

Within Quarantined Area

This project may be within a county regulated for plant and/or pests. If the project or any part of the Contractor's operations is located within a quarantined area, thoroughly clean all equipment prior to moving out of the quarantined area. Comply with federal/state regulations by obtaining a certificate or limited permit for any regulated article moving from the quarantined area.

Originating in a Quarantined County

Obtain a certificate or limited permit issued by the N.C. Department of Agriculture/United States Department of Agriculture. Have the certificate or limited permit accompany the article when it arrives at the project site.

Contact

Contact the N.C. Department of Agriculture/United States Department of Agriculture at 1-800-206-9333, 919-707-3730, or <https://www.ncagr.gov/plantindustry/Plant/quaran/table2.htm> to determine those specific project sites located in the quarantined area or for any regulated article used on this project originating in a quarantined county.

Regulated Articles Include

1. Soil, sand, gravel, compost, peat, humus, muck, and decomposed manure, separately or with other articles. This includes movement of articles listed above that may be associated with cut/waste, ditch pulling, and shoulder cutting.
2. Plants with roots including grass sod.
3. Plant crowns and roots.
4. Bulbs, corms, rhizomes, and tubers of ornamental plants.
5. Hay, straw, fodder, and plant litter of any kind.
6. Clearing and grubbing debris.
7. Used agricultural cultivating and harvesting equipment.
8. Used earth-moving equipment.
9. Any other products, articles, or means of conveyance, of any character, if determined by an inspector to present a hazard of spreading imported fire ant, gypsy moth, witchweed, emerald ash borer, guava root knot nematode, or other noxious weeds.

STANDARD SPECIAL PROVISION

MINIMUM WAGES

(7-21-09)

Z-5

FEDERAL: The Fair Labor Standards Act provides that with certain exceptions every employer shall pay wages at the rate of not less than SEVEN DOLLARS AND TWENTY FIVE CENTS (\$7.25) per hour.

STATE: The North Carolina Minimum Wage Act provides that every employer shall pay to each of his employees, wages at a rate of not less than SEVEN DOLLARS AND TWENTY FIVE CENTS (\$7.25) per hour.

The minimum wage paid to all skilled labor employed on this contract shall be SEVEN DOLLARS AND TWENTY FIVE CENTS (\$7.25) per hour.

The minimum wage paid to all intermediate labor employed on this contract shall be SEVEN DOLLARS AND TWENTY FIVE CENTS (\$7.25) per hour.

The minimum wage paid to all unskilled labor on this contract shall be SEVEN DOLLARS AND TWENTY FIVE CENTS (\$7.25) per hour.

This determination of the intent of the application of this act to the contract on this project is the responsibility of the Contractor.

The Contractor shall have no claim against the Department of Transportation for any changes in the minimum wage laws, Federal or State. It is the responsibility of the Contractor to keep fully informed of all Federal and State Laws affecting his contract.

STANDARD SPECIAL PROVISION

TITLE VI AND NONDISCRIMINATION:

(6-28-77)(Rev 1/16/2024)

Z-6

The North Carolina Department of Transportation is committed to carrying out the U.S. Department of Transportation's policy of ensuring nondiscrimination in the award and administration of contracts.

The provisions of this section related to United States Department of Transportation (US DOT) Order 1050.2A, Title 49 Code of Federal Regulations (CFR) part 21, 23 United States Code (U.S.C.) 140 and 23 CFR part 200 (or 49 CFR 303, 49 U.S.C. 5332 or 49 U.S.C. 47123) are applicable to all North Carolina Department of Transportation (NCDOT) contracts and to all related subcontracts, material supply, engineering, architectural and other service contracts, regardless of dollar amount. Any Federal provision that is specifically required not specifically set forth is hereby incorporated by reference.

(1) Title VI Assurances (USDOT Order 1050.2A, Appendix A)

During the performance of this contract, the contractor, for itself, its assignees, and successors in interest (hereinafter referred to as the "contractor") agrees as follows:

(a) Compliance with Regulations

The contractor (hereinafter includes consultants) shall comply with the Acts and the Regulations relative to Nondiscrimination in Federally-assisted programs of the U.S. Department of Transportation, Federal Highway Administration (FHWA), as they may be amended from time to time, which are herein incorporated by reference and made a part of this contract.

(b) Nondiscrimination

The contractor, with regard to the work performed by it during the contract, shall not discriminate on the grounds of race, color, or national origin in the selection and retention of subcontractors, including procurements of materials and leases of equipment. The contractor shall not participate directly or indirectly in the discrimination prohibited by the Acts and the Regulations, including employment practices when the contract covers any activity, project, or program set forth in Appendix B of 49 CFR Part 21.

(c) Solicitations for Subcontractors, Including Procurements of Materials and Equipment

In all solicitations, either by competitive bidding, or negotiation made by the contractor for work to be performed under a subcontract, including procurements of materials, or leases of equipment, each potential subcontractor or supplier shall be notified by the contractor of the contractor's obligations under this contract and the Acts and the Regulations relative to Nondiscrimination on the grounds of race, color, or national origin.

(d) Information and Reports

The contractor shall provide all information and reports required by the Acts, the Regulations, and directives issued pursuant thereto and shall permit access to its

books, records, accounts, other sources of information, and its facilities as may be determined by the Recipient or the FHWA to be pertinent to ascertain compliance with such Acts, Regulations, and instructions. Where any information required of a contractor is in the exclusive possession of another who fails or refuses to furnish the information, the contractor shall so certify to the Recipient or the FHWA, as appropriate, and shall set forth what efforts it has made to obtain the information.

(e) Sanctions for Noncompliance:

In the event of a contractor's noncompliance with the Non-discrimination provisions of this contract, the Recipient will impose such contract sanctions as it and/or the FHWA may determine to be appropriate, including, but not limited to:

- (i) Withholding payments to the contractor under the contract until the contractor complies; and/or
- (ii) Cancelling, terminating, or suspending a contract, in whole or in part.

(f) Incorporation of Provisions

The contractor shall include the provisions of paragraphs (a) through (f) in every subcontract, including procurements of materials and leases of equipment, unless exempt by the Acts, the Regulations and directives issued pursuant thereto. The contractor shall take action with respect to any subcontract or procurement as the Recipient or the FHWA may direct as a means of enforcing such provisions including sanctions for noncompliance. Provided, that if the contractor becomes involved in, or is threatened with litigation by a subcontractor, or supplier because of such direction, the contractor may request the Recipient to enter into any litigation to protect the interests of the Recipient. In addition, the contractor may request the United States to enter into the litigation to protect the interests of the United States.

(2) Title VI Nondiscrimination Program (23 CFR 200.5(p))

The North Carolina Department of Transportation (NCDOT) has assured the USDOT that, as a condition to receiving federal financial assistance, NCDOT will comply with Title VI of the Civil Rights Act of 1964 and all requirements imposed by Title 49 CFR part 21 and related nondiscrimination authorities to ensure that no person shall, on the ground of race, color, national origin, limited English proficiency, sex, age, or disability (including religion/creed or income-level, where applicable), be excluded from participation in, be denied the benefits of, or be subjected to discrimination under any programs, activities, or services conducted or funded by NCDOT. Contractors and other organizations under contract or agreement with NCDOT must also comply with Title VI and related authorities, therefore:

- (a) During the performance of this contract or agreement, contractors (e.g., subcontractors, consultants, vendors, prime contractors) are responsible for complying with NCDOT's Title VI Program. Contractors are not required to prepare or submit Title VI Programs. To comply with this section, the prime contractor shall:
 1. Post NCDOT's Notice of Nondiscrimination and the Contractor's own Equal Employment Opportunity (EEO) Policy in conspicuous locations accessible to all employees, applicants and subcontractors on the jobsite.

2. Physically incorporate the required Title VI clauses into all subcontracts on federally-assisted and state-funded NCDOT projects, and ensure inclusion by subcontractors into all lower-tier subcontracts.
 3. Required Solicitation Language. The Contractor shall include the following notification in all solicitations for bids and requests for work or material, regardless of funding source:

“The North Carolina Department of Transportation, in accordance with the provisions of Title VI of the Civil Rights Act of 1964 (78 Stat. 252, 42 U.S.C. §§ 2000d to 2000d-4) and the Regulations, hereby notifies all bidders that it will affirmatively ensure that any contract entered into pursuant to this advertisement, disadvantaged business enterprises will be afforded full and fair opportunity to submit bids in response to this invitation and will not be discriminated against on the grounds of race, color, or national origin in consideration for an award. In accordance with other related nondiscrimination authorities, bidders and contractors will also not be discriminated against on the grounds of sex, age, disability, low-income level, creed/religion, or limited English proficiency in consideration for an award.”
 4. Physically incorporate the FHWA-1273, in its entirety, into all subcontracts and subsequent lower tier subcontracts on Federal-aid highway construction contracts only.
 5. Provide language assistance services (i.e., written translation and oral interpretation), free of charge, to LEP employees and applicants. Contact NCDOT OCR for further assistance, if needed.
 6. For assistance with these Title VI requirements, contact the NCDOT Title VI Nondiscrimination Program at 1-800-522-0453.
- (b) Subrecipients (e.g. cities, counties, LGAs, planning organizations) may be required to prepare and submit a Title VI Plan to NCDOT, including Title VI Assurances and/or agreements. Subrecipients must also ensure compliance by their contractors and subrecipients with Title VI. (23 CFR 200.9(b)(7))
- (c) If reviewed or investigated by NCDOT, the contractor or subrecipient agrees to take affirmative action to correct any deficiencies found within a reasonable time period, not to exceed 90 calendar days, unless additional time is granted by NCDOT. (23 CFR 200.9(b)(15))
- (d) The Contractor is responsible for notifying subcontractors of NCDOT’s External Discrimination Complaints Process.
1. Applicability

Title VI and related laws protect participants and beneficiaries (e.g., members of the public and contractors) from discrimination by NCDOT employees, subrecipients and contractors, regardless of funding source.

2. Eligibility

Any person—or class of persons—who believes he/she has been subjected to discrimination based on race, color, national origin, Limited English Proficiency (LEP), sex, age, or disability (and religion in the context of employment, aviation, or transit) may file a written complaint. The law also prohibits intimidation or retaliation of any sort.

3. Time Limits and Filing Options

Complaints may be filed by the affected individual(s) or a representative and must be filed no later than 180 calendar days after the following:

- (i) The date of the alleged act of discrimination; or
- (ii) The date when the person(s) became aware of the alleged discrimination; or
- (iii) Where there has been a continuing course of conduct, the date on which that conduct was discontinued or the latest instance of the conduct.

Title VI and related discrimination complaints may be submitted to the following entities:

- North Carolina Department of Transportation, Office of Civil Rights, Title VI Program, 1511 Mail Service Center, Raleigh, NC 27699-1511; toll free 1-800-522-0453
- Federal Highway Administration, North Carolina Division Office, 310 New Bern Avenue, Suite 410, Raleigh, NC 27601, 919-747-7010
- US Department of Transportation, Departmental Office of Civil Rights, External Civil Rights Programs Division, 1200 New Jersey Avenue, SE, Washington, DC 20590; 202-366-4070

4. Format for Complaints

Complaints must be in writing and signed by the complainant(s) or a representative, and include the complainant's name, address, and telephone number. Complaints received by fax or e-mail will be acknowledged and processed. Allegations received by telephone will be reduced to writing and provided to the complainant for confirmation or revision before processing. Complaints will be accepted in other languages, including Braille.

5. Discrimination Complaint Form

Contact NCDOT Civil Rights to receive a full copy of the Discrimination Complaint Form and procedures.

6. Complaint Basis

Allegations must be based on issues involving race, color, national origin (LEP), sex, age, disability, or religion (in the context of employment, aviation or transit). "Basis" refers to the complainant's membership in a protected group category.

TABLE 103-1 COMPLAINT BASIS			
Protected Categories	Definition	Examples	Applicable Nondiscrimination Authorities
Race and Ethnicity	An individual belonging to one of the accepted racial groups; or the perception, based usually on physical characteristics that a person is a member of a racial group	Black/African American, Hispanic/Latino, Asian, American Indian/Alaska Native, Native Hawaiian/Pacific Islander, White	Title VI of the Civil Rights Act of 1964; 49 CFR Part 21; 23 CFR 200; 49 U.S.C. 5332(b); 49 U.S.C. 47123. <i>(Executive Order 13166)</i>
Color	Color of skin, including shade of skin within a racial group	Black, White, brown, yellow, etc.	
National Origin <i>(Limited English Proficiency)</i>	Place of birth. Citizenship is not a factor. <i>(Discrimination based on language or a person's accent is also covered)</i>	Mexican, Cuban, Japanese, Vietnamese, Chinese	
Sex	Gender. The sex of an individual. <i>Note: Sex under this program does not include sexual orientation.</i>	Women and Men	1973 Federal-Aid Highway Act; 49 U.S.C. 5332(b); 49 U.S.C. 47123.
Age	Persons of any age	21-year-old person	Age Discrimination Act of 1975 49 U.S.C. 5332(b); 49 U.S.C. 47123.
Disability	Physical or mental impairment, permanent or temporary, or perceived.	Blind, alcoholic, para-amputee, epileptic, diabetic, arthritic	Section 504 of the Rehabilitation Act of 1973; Americans with Disabilities Act of 1990
Religion (in the context of employment) <i>(Religion/ Creed in all aspects of any aviation or transit-related construction)</i>	An individual belonging to a religious group; or the perception, based on distinguishable characteristics that a person is a member of a religious group. In practice, actions taken as a result of the moral and ethical beliefs as to what is right and wrong, which are sincerely held with the strength of traditional religious views. <i>Note: Does not have to be associated with a recognized religious group or church; if an individual sincerely holds to the belief, it is a protected religious practice.</i>	Muslim, Christian, Sikh, Hindu, etc.	Title VII of the Civil Rights Act of 1964; 23 CFR 230; FHWA-1273 Required Contract Provisions. <i>(49 U.S.C. 5332(b); 49 U.S.C. 47123)</i>

(3) Pertinent Nondiscrimination Authorities

During the performance of this contract, the contractor, for itself, its assignees, and successors in interest agrees to comply with the following non-discrimination statutes and authorities, including, but not limited to:

- (a) Title VI of the Civil Rights Act of 1964 (42 U.S.C. § 2000d et seq., 78 stat. 252), (prohibits discrimination on the basis of race, color, national origin); and 49 CFR Part 21.

- (b) The Uniform Relocation Assistance and Real Property Acquisition Policies Act of 1970, (42 U.S.C. § 4601), (prohibits unfair treatment of persons displaced or whose property has been acquired because of Federal or Federal-aid programs and projects);
- (c) Federal-Aid Highway Act of 1973, (23 U.S.C. § 324 et seq.), (prohibits discrimination on the basis of sex);
- (d) Section 504 of the Rehabilitation Act of 1973, (29 U.S.C. § 794 et seq.), as amended, (prohibits discrimination on the basis of disability) and 49 CFR Part 27;
- (e) The Age Discrimination Act of 1975, as amended, (42 U.S.C. § 6101 et seq.), (prohibits discrimination on the basis of age);
- (f) Airport and Airway Improvement Act of 1982, (49 USC § 471, Section 47123), as amended, (prohibits discrimination based on race, creed, color, national origin, or sex);
- (g) The Civil Rights Restoration Act of 1987, (PL 100-209), (Broadened the scope, coverage and applicability of Title VI of the Civil Rights Act of 1964, The Age Discrimination Act of 1975 and Section 504 of the Rehabilitation Act of 1973, by expanding the definition of the terms "programs or activities" to include all of the programs or activities of the Federal-aid recipients, sub-recipients and contractors, whether such programs or activities are Federally funded or not);
- (h) Titles II and III of the Americans with Disabilities Act, which prohibit discrimination on the basis of disability in the operation of public entities, public and private transportation systems, places of public accommodation, and certain testing entities (42 U.S.C. §§ 12131-12189) as implemented by Department of Transportation regulations at 49 C.F.R. parts 37 and 38;
- (i) The Federal Aviation Administration's Nondiscrimination statute (49 U.S.C. § 47123) (prohibits discrimination on the basis of race, color, national origin, and sex);
- (j) Executive Order 12898, Federal Actions to Address Environmental Justice in Minority Populations and Low-Income Populations, which ensures Nondiscrimination against minority populations by discouraging programs, policies, and activities with disproportionately high and adverse human health or environmental effects on minority and low-income populations;
- (k) Executive Order 13166, Improving Access to Services for Persons with Limited English Proficiency, and resulting agency guidance, national origin discrimination includes discrimination because of Limited English proficiency (LEP). To ensure compliance with Title VI, you must take reasonable steps to ensure that LEP persons have meaningful access to your programs (70 Fed. Reg. at 74087 to 74100);
- (l) Title IX of the Education Amendments of 1972, as amended, which prohibits you from discriminating because of sex in education programs or activities (20 U.S.C. 1681 et seq).
- (m) Title VII of the Civil Rights Act of 1964 (42 U.S.C. § 2000e et seq., Pub. L. 88-352), (prohibits employment discrimination on the basis of race, color, religion, sex, or national origin).

(4) Additional Title VI Assurances

***The following Title VI Assurances (Appendices B, C and D) shall apply, as applicable*

(a) Clauses for Deeds Transferring United States Property (1050.2A, Appendix B)

The following clauses will be included in deeds effecting or recording the transfer of real property, structures, or improvements thereon, or granting interest therein from the United States pursuant to the provisions of Assurance 4.

NOW, THEREFORE, the U.S. Department of Transportation as authorized by law and upon the condition that the North Carolina Department of Transportation (NCDOT) will accept title to the lands and maintain the project constructed thereon in accordance with the North Carolina General Assembly, the Regulations for the Administration of the Federal-Aid Highway Program, and the policies and procedures prescribed by the Federal Highway Administration of the U.S. Department of Transportation in accordance and in compliance with all requirements imposed by Title 49, Code of Federal Regulations, U.S. Department of Transportation, Subtitle A, Office of the Secretary, Part 21, Nondiscrimination in Federally-assisted programs of the U.S. Department of Transportation pertaining to and effectuating the provisions of Title VI of the Civil Rights Act of 1964 (78 Stat. 252; 42 U.S.C. § 2000d to 2000d-4), does hereby remise, release, quitclaim and convey unto the NCDOT all the right, title and interest of the U.S. Department of Transportation in and to said lands described in Exhibit A attached hereto and made a part hereof.

(HABENDUM CLAUSE)

TO HAVE AND TO HOLD said lands and interests therein unto the North Carolina Department of Transportation (NCDOT) and its successors forever, subject, however, to the covenants, conditions, restrictions and reservations herein contained as follows, which will remain in effect for the period during which the real property or structures are used for a purpose for which Federal financial assistance is extended or for another purpose involving the provision of similar services or benefits and will be binding on the NCDOT, its successors and assigns.

The NCDOT, in consideration of the conveyance of said lands and interests in lands, does hereby covenant and agree as a covenant running with the land for itself, its successors and assigns, that (1) no person will on the grounds of race, color, or national origin, be excluded from participation in, be denied the benefits of, or be otherwise subjected to discrimination with regard to any facility located wholly or in part on, over, or under such lands hereby conveyed [,] [and]* (2) that the NCDOT will use the lands and interests in lands and interests in lands so conveyed, in compliance with all requirements imposed by or pursuant to Title 49, Code of Federal Regulations, U.S. Department of Transportation, Subtitle A, Office of the Secretary, Part 21, Non-discrimination in Federally-assisted programs of the U.S. Department of Transportation, Effectuation of Title VI of the Civil Rights Act of 1964, and as said Regulations and Acts may be amended [, and (3) that in the event of breach of any of the above-mentioned nondiscrimination conditions, the Department will have a right to enter or re-enter said lands and facilities on said land, and that above described land and facilities will thereon revert to and vest in and become the absolute property of the U.S. Department of Transportation and its assigns as such interest existed prior to this instruction].*

(*Reverter clause and related language to be used only when it is determined that such a clause is necessary in order to make clear the purpose of Title VI.)

(b) Clauses for Transfer of Real Property Acquired or Improved Under the Activity, Facility, or Program (1050.2A, Appendix C)

The following clauses will be included in deeds, licenses, leases, permits, or similar instruments entered into by the North Carolina Department of Transportation (NCDOT) pursuant to the provisions of Assurance 7(a):

1. The (grantee, lessee, permittee, etc. as appropriate) for himself/herself, his/her heirs, personal representatives, successors in interest, and assigns, as a part of the consideration hereof, does hereby covenant and agree [in the case of deeds and leases add "as a covenant running with the land"] that:
 - (i.) In the event facilities are constructed, maintained, or otherwise operated on the property described in this (deed, license, lease, permit, etc.) for a purpose for which a U.S. Department of Transportation activity, facility, or program is extended or for another purpose involving the provision of similar services or benefits, the (grantee, licensee, lessee, permittee, etc.) will maintain and operate such facilities and services in compliance with all requirements imposed by the Acts and Regulations (as may be amended) such that no person on the grounds of race, color, or national origin, will be excluded from participation in, denied the benefits of, or be otherwise subjected to discrimination in the use of said facilities.
2. With respect to licenses, leases, permits, etc., in the event of breach of any of the above Nondiscrimination covenants, the NCDOT will have the right to terminate the (lease, license, permit, etc.) and to enter, re-enter, and repossess said lands and facilities thereon, and hold the same as if the (lease, license, permit, etc.) had never been made or issued. *
3. With respect to a deed, in the event of breach of any of the above Nondiscrimination covenants, the NCDOT will have the right to enter or re-enter the lands and facilities thereon, and the above described lands and facilities will there upon revert to and vest in and become the absolute property of the NCDOT and its assigns. *

(*Reverter clause and related language to be used only when it is determined that such a clause is necessary to make clear the purpose of Title VI.)

(c) Clauses for Construction/Use/Access to Real Property Acquired Under the Activity, Facility or Program (1050.2A, Appendix D)

The following clauses will be included in deeds, licenses, permits, or similar instruments/ agreements entered into by the North Carolina Department of Transportation (NCDOT) pursuant to the provisions of Assurance 7

(b):

1. The (grantee, licensee, permittee, etc., as appropriate) for himself/herself, his/her heirs, personal representatives, successors in interest, and assigns, as a part of the consideration hereof, does hereby covenant and agree (in the case of deeds and leases add, "as a covenant running with the land") that (1) no person on the ground of race, color, or national origin, will be excluded from participation in, denied the benefits of, or be otherwise subjected to discrimination in the use of said facilities, (2) that in the construction of any improvements on, over, or under such land, and the furnishing of services thereon, no person on the ground of race, color, or national origin, will be excluded from participation in, denied the benefits of, or otherwise be subjected to discrimination, (3) that the (grantee, licensee, lessee, permittee, etc.) will use the premises in compliance with all other requirements imposed by or pursuant to the Acts and Regulations, as amended, set forth in this Assurance.
2. With respect to (licenses, leases, permits, etc.), in the event of breach of any of the above Non-discrimination covenants, the NCDOT will have the right to terminate the (license, permit, etc., as appropriate) and to enter or re-enter and repossess said land and the facilities thereon, and hold the same as if said (license, permit, etc., as appropriate) had never been made or issued. *
3. With respect to deeds, in the event of breach of any of the above Nondiscrimination covenants, the NCDOT will there upon revert to and vest in and become the absolute property of the NCDOT and its assigns. *

(*Reverter clause and related language to be used only when it is determined that such a clause is necessary to make clear the purpose of Title VI.)

STANDARD SPECIAL PROVISION

ON-THE-JOB TRAINING

(10-16-07) (Rev. 4-21-15)

Z-10

Description

The North Carolina Department of Transportation will administer a custom version of the Federal On-the-Job Training (OJT) Program, commonly referred to as the Alternate OJT Program. All contractors (existing and newcomers) will be automatically placed in the Alternate Program. Standard OJT requirements typically associated with individual projects will no longer be applied at the project level. Instead, these requirements will be applicable on an annual basis for each contractor administered by the OJT Program Manager.

On the Job Training shall meet the requirements of 23 CFR 230.107 (b), 23 USC – Section 140, this provision and the On-the-Job Training Program Manual.

The Alternate OJT Program will allow a contractor to train employees on Federal, State and privately funded projects located in North Carolina. However, priority shall be given to training employees on NCDOT Federal-Aid funded projects.

Minorities and Women

Developing, training and upgrading of minorities and women toward journeyman level status is a primary objective of this special training provision. Accordingly, the Contractor shall make every effort to enroll minority and women as trainees to the extent that such persons are available within a reasonable area of recruitment. This training commitment is not intended, and shall not be used, to discriminate against any applicant for training, whether a member of a minority group or not.

Assigning Training Goals

The Department, through the OJT Program Manager, will assign training goals for a calendar year based on the contractors' past three years' activity and the contractors' anticipated upcoming year's activity with the Department. At the beginning of each year, all contractors eligible will be contacted by the Department to determine the number of trainees that will be assigned for the upcoming calendar year. At that time the Contractor shall enter into an agreement with the Department to provide a self-imposed on-the-job training program for the calendar year. This agreement will include a specific number of annual training goals agreed to by both parties. The number of training assignments may range from 1 to 15 per contractor per calendar year. The Contractor shall sign an agreement to fulfill their annual goal for the year.\

Training Classifications

The Contractor shall provide on-the-job training aimed at developing full journeyman level workers in the construction craft/operator positions. Preference shall be given to providing training in the following skilled work classifications:

Equipment Operators	Office Engineers
Truck Drivers	Estimators
Carpenters	Iron / Reinforcing Steel Workers
Concrete Finishers	Mechanics
Pipe Layers	Welders

The Department has established common training classifications and their respective training requirements that may be used by the contractors. However, the classifications established are not all-inclusive. Where the training is oriented toward construction applications, training will be allowed in lower-level management positions such as office engineers and estimators. Contractors shall submit new classifications for specific job functions that their employees are performing. The Department will review and recommend for acceptance to FHWA the new classifications proposed by contractors, if applicable. New classifications shall meet the following requirements:

Proposed training classifications are reasonable and realistic based on the job skill classification needs, and

The number of training hours specified in the training classification is consistent with common practices and provides enough time for the trainee to obtain journeyman level status.

The Contractor may allow trainees to be trained by a subcontractor provided that the Contractor retains primary responsibility for meeting the training and this provision is made applicable to the subcontract. However, only the Contractor will receive credit towards the annual goal for the trainee.

Where feasible, 25 percent of apprentices or trainees in each occupation shall be in their first year of apprenticeship or training. The number of trainees shall be distributed among the work classifications on the basis of the contractor's needs and the availability of journeymen in the various classifications within a reasonable area of recruitment.

No employee shall be employed as a trainee in any classification in which they have successfully completed a training course leading to journeyman level status or in which they have been employed as a journeyman.

Records and Reports

The Contractor shall maintain enrollment, monthly and completion reports documenting company compliance under these contract documents. These documents and any other information as requested shall be submitted to the OJT Program Manager.

Upon completion and graduation of the program, the Contractor shall provide each trainee with a certification Certificate showing the type and length of training satisfactorily completed.

Trainee Interviews

All trainees enrolled in the program will receive an initial and Trainee/Post graduate interview conducted by the OJT program staff.

Trainee Wages

Contractors shall compensate trainees on a graduating pay scale based upon a percentage of the prevailing minimum journeyman wages (Davis-Bacon Act). Minimum pay shall be as follows:

- 60 percent of the journeyman wage for the first half of the training period
- 75 percent of the journeyman wage for the third quarter of the training period
- 90 percent of the journeyman wage for the last quarter of the training period

In no instance shall a trainee be paid less than the local minimum wage. The Contractor shall adhere to the minimum hourly wage rate that will satisfy both the NC Department of Labor (NCDOL) and the Department.

Achieving or Failing to Meet Training Goals

The Contractor will be credited for each trainee employed by him on the contract work who is currently enrolled or becomes enrolled in an approved program and who receives training for at least 50 percent of the specific program requirement. Trainees will be allowed to be transferred between projects if required by the Contractor's scheduled workload to meet training goals.

If a contractor fails to attain their training assignments for the calendar year, they may be taken off the NCDOT's Bidders List.

Measurement and Payment

No compensation will be made for providing required training in accordance with these contract documents.

LISTING OF MBE/WBE SUBCONTRACTORS

Sheet of

Firm Name and Address	Circle One	Item No.	Item Description	* Agreed upon Unit Price	** Dollar Volume of Item
Name Address	MBE WBE				
Name Address	MBE WBE				
Name Address	MBE WBE				
Name Address	MBE WBE				
Name Address	MBE WBE				
Name Address	MBE WBE				

* The Dollar Volume shown in this column shall be the Actual Price Agreed Upon by the Prime Contractor and the MBE/WBE subcontractor, and these prices will be used to determine the percentage of the MBE/WBE participation in the contract.

** Dollar Volume of MBE/WBE Subcontractor Percentage of Total Contract Bid Price:

If firm is a Material Supplier Only, show Dollar Volume as 60% of Agreed Upon Amount from Letter of Intent.

If firm is a Manufacturer, show Dollar Volume as 100% of Agreed Upon Amount from Letter of Intent.

LISTING OF MBE/WBE SUBCONTRACTORS

Sheet of

Firm Name and Address	Circle One	Item No.	Item Description	* Agreed upon Unit Price	** Dollar Volume of Item
Name Address	MBE WBE				
Name Address	MBE WBE				
Name Address	MBE WBE				
Name Address	MBE WBE				
Name Address	MBE WBE				

**** Dollar Volume of MBE Subcontractor \$ _____**

MBE Percentage of Total Contract Bid Price _____%

**** Dollar Volume of WBE Subcontractor \$ _____**

WBE Percentage of Total Contract Bid Price _____%

***The Dollar Volume shown in this column shall be the Actual Price Agreed Upon by the Prime Contractor and the MBE/WBE subcontractor, and these prices will be used to determine the percentage of the MBE/WBE participation in the contract.**

**** Dollar Volume of MBE/WBE Subcontractor Percentage of Total Contract Bid Price.**

If firm is a Material Supplier Only, show Dollar Volume as 60% of Agreed Upon Amount from Letter of Intent.

If firm is a Manufacturer, show Dollar Volume as 100% of Agreed Upon Amount from Letter of Intent.

County: JOHNSTON

Line #	Item Number	Sec #	Description	Quantity	Unit Cost	Amount
ROADWAY ITEMS						
0001	0000100000-N	800	MOBILIZATION	Lump Sum	L.S.	
0002	1220000000-E	545	INCIDENTAL STONE BASE	418 TON		
0003	1330000000-E	607	INCIDENTAL MILLING	14,240 SY		
0004	1519000000-E	610	ASPHALT CONC SURFACE COURSE, TYPE S9.5B	33,006 TON		
0005	1575000000-E	620	ASPHALT BINDER FOR PLANT MIX	2,188 TON		
0006	1704000000-E	SP	PATCHING EXISTING PAVEMENT	925 TON		
0007	2845000000-N	858	ADJUSTMENT OF METER BOXES OR VALVE BOXES	10 EA		
0008	4413000000-E	SP	WORK ZONE ADVANCE/GENERAL WARNING SIGNING	1,709 SF		
0009	4457000000-N	SP	TEMPORARY TRAFFIC CONTROL	Lump Sum	L.S.	
0010	4685000000-E	1205	THERMOPLASTIC PAVEMENT MARKING LINES (4", 90 MILS)	106,232 LF		
0011	4709000000-E	1205	THERMOPLASTIC PAVEMENT MARKING LINES (24", 90 MILS)	470 LF		
0012	4720000000-E	1205	THERMOPLASTIC PAVEMENT MARKING CHARACTER (90 MILS)	32 EA		
0013	4725000000-E	1205	THERMOPLASTIC PAVEMENT MARKING SYMBOL (90 MILS)	33 EA		
0014	4890000000-E	SP	GENERIC PAVEMENT MARKING ITEM HOT SPRAY THERMOPLASTIC PAVEMENT MARKING LINES(4", 50MILS)	559,769 LF		
0015	7444000000-E	1725	INDUCTIVE LOOP SAWCUT	140 LF		

1351/Jun03/Q719174/D50236100000/E15

Total Amount Of Bid For Entire Project :

Execution of Contract

Contract No: DD00463

County: JOHNSTON COUNTY

ACCEPTED BY THE DEPARTMENT

Proposals Engineer

Date

EXECUTION OF CONTRACT AND BONDS
APPROVED AS TO FORM:

for **Division Engineer**

Date

Signature Sheet (Bid) - ACCEPTANCE SHEET