

STATE OF NORTH CAROLINA
DEPARTMENT OF TRANSPORTATION

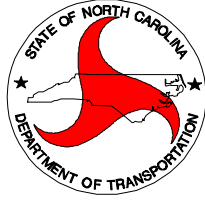

DIVISION 6

CONTRACT PROPOSAL

WORK ORDER NUMBER: 17BP.6.R.66

COUNTY: Robeson

ROUTE NO.: SR 2454, SR 2214 & SR 2422

TYPE OF WORK: Removal and Replacement of Pipe Culverts & Replacement with Aluminum Pipe with Headwalls

BID OPENING: Wednesday, June 3, 2015 at 10:00 A.M.

NOTICE:

ALL BIDDERS SHALL COMPLY WITH ALL APPLICABLE LAWS REGULATING THE PRACTICE OF GENERAL CONTRACTING AS CONTAINED IN CHAPTER 87 OF THE GENERAL STATUTES OF NORTH CAROLINA WHICH REQUIRES THE BIDDER TO BE LICENSED BY THE N.C. LICENSING BOARD FOR CONTRACTORS WHEN BIDDING ON ANY NON-FEDERAL AID PROJECT WHERE THE BID IS \$30,000 OR MORE, EXCEPT FOR CERTAIN SPECIALTY WORK AS DETERMINED BY THE LICENSING BOARD OR SBE PROJECT. BIDDERS SHALL ALSO COMPLY WITH ALL OTHER APPLICABLE LAWS REGULATING THE PRACTICES OF ELECTRICAL, PLUMBING, HEATING AND AIR CONDITIONING AND REFRIGERATION CONTRACTING AS CONTAINED IN CHAPTER 87 OF THE GENERAL STATUTES OF NORTH CAROLINA.

NAME OF BIDDER

N.C. CONTRACTOR'S LICENSE NUMBER

ADDRESS OF BIDDER

RETURN BIDS TO: N.C. DEPARTMENT OF TRANSPORTATION
Attn: R. Allen Waddell, PE, Division Proposals Engineer
PO Box 1150
Fayetteville, NC 28302

CONTENTS

INSTRUCTIONS TO BIDDERS	4
DIVISION CONTRACT GENERAL PROVISIONS	5
GENERAL	5
PRE-BID CONFERENCE	5
DIVISION LET CONTRACT PREQUALIFICATION	5
CONTRACT TIME AND LIQUIDATED DAMAGES	5
INTERMEDIATE COMPLETION DATE AND LIQUIDATED DAMAGES	6
EXTENSION OF CONTRACT TIME	6
AUTHORITY OF THE ENGINEER	6
NO MAJOR CONTRACT ITEMS	6
EMPLOYMENT	6
INSPECTION	6
PROSECUTION AND PROGRESS	7
CONFORMITY WITH THE CONTRACT	7
LIABILITY INSURANCE	7
RESPONSIBILITY FOR DAMAGE CLAIMS	7
CONTRACTOR'S LICENSE REQUIREMENTS	7
CONTRACT PAYMENT AND PERFORMANCE BOND	7
MINORITY BUSINESS ENTERPRISE AND WOMEN BUSINESS ENTERPRISE	8
CLAIMS FOR ADDITIONAL COMPENSATION OR EXTENSION OF TIME	17
TWELVE MONTH GUARANTEE	17
GIFTS FROM VENDORS AND CONTRACTORS	18
DOMESTIC STEEL	18
MATERIAL AND EQUIPMENT STORAGE AND PARKING	18
SUPERVISION BY CONTRACTOR	18
SAFETY AND ACCIDENT PROTECTION	19
SAFETY VESTS	19
SUBLETTING OF CONTRACT	19
DEFAULT OF CONTRACT	19
PRESERVATION OF PROPERTY	19
TEMPORARY SUSPENSION OF WORK	19
COORDINATION WITH OTHERS	19
COOPERATION BETWEEN CONTRACTORS	20
PAYMENT	20
NOTIFICATION OF OPERATIONS	20
EROSION, SILTATION, AND POLLUTION CONTROL	20
EROSION AND SEDIMENT CONTROL/STORMWATER CERTIFICATION	20
INTERPRETATION OF QUANTITIES IN PROPOSAL FORM	24
DRIVEWAYS AND PRIVATE PROPERTY	24
TRAFFIC SIGNS & MAILBOXES	24
DAMAGE TO EXISTING PAVEMENT, BASE, SUBGRADE, AND PROPOSED PAVEMENT	24
PLAN, DETAIL, AND QUANTITY ADJUSTMENTS	24
POSTED WEIGHT LIMITS	24
SUBMITTALS	25
MATERIALS AND TESTING	25
SUBSURFACE INFORMATION	25
PRECONSTRUCTION CONFERENCE	25
TRAFFIC CONTROL AND WORK ZONE SAFETY	25
PROJECT SPECIAL PROVISIONS	26
MOBILIZATION	26
SHOULDER AND FILL SLOPE MATERIAL	26
COMPREHENSIVE GRADING	26
STOCKPILE AREAS	28

BORROW.....	28
AGGREGATE BASE COURSE.....	28
#57 STONE / BACKFILL.....	28
PIPE REMOVAL.....	29
PAVING.....	29
ASPHALT BINDER FOR PLANT MIX.....	30
CONTRACTOR SUPPLIED PIPE AND HEADWALL (ASSEMBLE AND INSTALL)	30
DEWATERING.....	31
UTILITY RELOCATIONS.....	31
TEMPORARY SILT FENCE.....	31
EROSION CONTROL STONE.....	32
WATTLES.....	32
STABILIZATION REQUIREMENTS.....	33
SEEDING AND MULCHING.....	33
CRANE SAFETY.....	34
GENERAL ALUMINUM STRUCTURE REQUIREMENTS.....	35
SUMMARY OF QUANTITIES.....	36
BYPASS PUMPING.....	37
TEMPORARY SILT FENCE DETAIL.....	38
WATTLE DETAIL.....	39
VICINITY MAP.....	39
DRAWINGS.....	41
TYPICAL BACKFILL SECTION.....	41
STANDARD SPECIAL PROVISIONS.....	45
PERMITS.....	45
AVAILABILITY OF FUNDS – TERMINATION OF CONTRACTS.....	45
NCDOT GENERAL SEED SPECIFICATION FOR SEED QUALITY.....	46
ERRATA.....	48
PLANT AND PEST QUARANTINES.....	49
MINIMUM WAGES.....	49
ON-THE-JOB TRAINING.....	50
LISTING OF MB & WB SUBCONTRACTORS.....	52
SUBSTITUTE FORM W-9.....	53
AWARD LIMITS ON MULTIPLE PROJECTS.....	54
EXECUTION OF BID.....	55
DEBARMENT CERTIFICATION.....	61
PAYMENT REQUEST.....	63
CONTRACT BID FORM.....	65
ENVIRONMENTAL PERMIT.....	67

INSTRUCTIONS TO BIDDERS

**PLEASE READ ALL INSTRUCTIONS CAREFULLY
BEFORE PREPARING AND SUBMITTING YOUR BID.**

A Mandatory Pre-bid Conference will be held on Wednesday, May 27, 2015 at 10:00 am.

The meeting will be held at the NCDOT Division Office Conference Room, 558 Gillespie Drive, Fayetteville, North Carolina 28301.

All bids shall be prepared and submitted in accordance with the following requirements. Failure to comply with any requirement shall cause the bid to be considered irregular and shall be grounds for rejection of the bid.

1. The bid sheet furnished by NCDOT with the proposal shall be used and shall not be altered in any manner. **DO NOT SEPARATE THE BID SHEET FROM THE PROPOSAL!**
2. All entries on the bid sheet, including signatures, shall be written in ink.
3. The Bidder shall submit a unit price for every item on the bid form. The unit prices for the various contract items shall be written in figures.
4. An amount bid shall be entered on the bid sheet for every item. The amount bid for each item shall be determined by multiplying each unit bid by the quantity for that item, and shall be written in figures in the "Amount Bid" column of the sheet.
5. The total amount bid shall be written in figures in the proper place on the bid sheet. The total amount shall be determined by adding the amounts bid for each item.
6. Changes in any entry shall be made by marking through the entry in ink and making the correct entry adjacent thereto in ink. A representative of the Bidder shall initial the change in ink.
7. The bid shall be properly executed. All bids shall show the following information:
 - a. Name of individual, firm, corporation, partnership, or joint venture submitting bid.
 - b. Name and signature of individual or representative submitting bid and position or title.
 - c. Name, signature, and position or title of witness.
 - d. Federal Identification Number (or Social Security Number of Individual)
 - e. Contractor's License Number (if Applicable)
8. Bids submitted by corporations shall bear the seal of the corporation.
9. The bid shall not contain any unauthorized additions, deletions, or conditional bids.
10. The bidder shall not add any provision reserving the right to accept or reject an award, or to enter into a contract pursuant to an award.
11. The Form entitled "LISTING OF MBE & WBE SUBCONTRACTORS" must be filled out for Subcontractors submitting quotes for work on this contract. The Contractor shall then submit this form with the bid package.
12. **THE PROPOSAL WITH THE BID FORM STILL ATTACHED SHALL BE PLACED IN A SEALED ENVELOPE AND SHALL HAVE BEEN DELIVERED TO AND RECEIVED IN THE DIVISION PROPOSAL ENGINEER'S OFFICE AT 558 GILLESPIE ST, FAYETTEVILLE, NC 28301 BY 10:00 AM ON WEDNESDAY, JUNE 3, 2015.** If bids are mailed or sent by special delivery, the Contractor shall be responsible for verifying that the bid has actually been received in the Division Proposals Engineer's Office prior to the bid deadline. NCDOT shall not be responsible for bid packages that do not arrive in our office on time. Bid packages arriving after the official deadline shall not be considered responsive, and shall be returned to the Contractor unopened.
13. **The sealed bid envelope must display the bidding Contractor's name and address on the front.**
14. The sealed bid must display the following statement on the front of the sealed envelope:

**"QUOTATION FOR REMOVAL OF EXISTING PIPE CULVERTS AND REPLACEMENT
WITH ALUMINUM PIPE CULVERTS WITH HEADWALLS IN ROBESON COUNTY."
TO BE OPENED AT 10:00 AM WEDNESDAY JUNE 3, 2015**

15. If delivered by mail, the sealed envelope shall be placed in another sealed envelope and the outer envelope shall be addressed as follows:

**R. ALLEN WADDELL, PE, DIVISION PROPOSALS ENGINEER
NCDOT – DIVISION 6
P.O. BOX 1150
FAYETTEVILLE, NC 28302**

AWARD OF CONTRACT

The award of the contract, if it be awarded, will be made to the lowest responsible Bidder in accordance with Section 102 (*excluding 102-2 and 102-11*) of the Standard Specifications for Roads and Structures 2012. The lowest responsible will be notified that his bid has been accepted and that he has been awarded the contract. NCDOT reserves the right to reject all bids.

DIVISION CONTRACT GENERAL PROVISIONS

GENERAL

This contract is for the **Removal of Existing Pipe Culverts and Replacement with Aluminum Pipe Culvert and Headwalls in Robeson County**. All work and materials shall be in accordance with the provisions of the General Guidelines of this contract, the Project Special Provisions, the North Carolina Department of Transportation Standard Specifications for Roads and Structures (2012), the North Carolina Department of Transportation Roadway Standards Drawings (2012), and the current edition of the Manual of Uniform Traffic Control Devices (MUTCD).

The Contractor shall keep himself fully informed of all Federal, State and local laws, ordinances, and regulations, and shall comply with the provisions of Section 107 of the Standard Specifications.

PRE-BID CONFERENCE

All prospective Bidders shall attend a Pre-Bid Conference at the location indicated below. This conference will be conducted by Department personnel for the purpose of providing additional information about the project and to give Bidders an opportunity to ask any questions they may have. Only bids received from Bidders who have attended and properly registered at the Pre-Bid Conference will be considered.

No questions concerning the project will be answered by any Department personnel at any time except at the Pre-Bid Conference.

Attendance at the Pre-Bid Conference will not meet the requirements of proper registration unless the individual attending has registered at the Conference in accordance with the following:

1. The individual signs his or her name on the official roster;
2. The individual writes in the name and address of the company he or she represents; and
3. Only one company is shown as being represented by the individual attending

Bidders are to meet for the Pre-Bid Conference Wednesday, May 27, 2015 at 10:00A.M. The Pre-Bid Conference will be held at the NC Department of Transportation, Division Office Conference Room, 558 Gillespie Drive, Fayetteville, North Carolina 28301.

DIVISION LET CONTRACT PREQUALIFICATION

(07-01-14)(6-1-15)

SPD 01-410

Any firm that wishes to bid as a prime contractor shall be prequalified as a Bidder or PO Prime Contractor prior to submitting a bid. Information regarding prequalification can be found at:
<https://connect.ncdot.gov/business/Prequal/Pages/default.aspx>.

In addition, the prime contractor and/or subcontractor(s) shall be prequalified in the work code(s) for which they identify as work items in the prime contractor's construction progress schedule that they will complete themselves. Any contractor identified as working outside their expertise may be considered in default of contract.

CONTRACT TIME AND LIQUIDATED DAMAGES

(7-1-95)(Rev. 12-18-07)

SP1G10

The date of availability for this project is July 13, 2015. The Contractor may begin work prior to this date upon approval of the Engineer or his duly authorized representative. If such approval is given, and the Contractor begins work prior to the date of availability, the Department of Transportation will assume no responsibility for any delays caused prior to the date of availability by any reason whatsoever, and such delays, if any, will not constitute a valid reason for extending the completion date.

No work will be permitted and no purchase order will be issued until all required bonds and prerequisite conditions and certifications have been satisfied.

The completion date for this project shall be October 16, 2015. No extensions will be authorized except as authorized by Article 108-10 of the *Standard Specifications*.

The Contractor shall request a Pre-Construction Conference prior to beginning construction. To schedule the conference contact the **Division Bridge Engineer at (910) 829-6345**, to request a Pre-Construction Conference date and time.

Liquidated damages for this contract are Five Hundred Dollars (\$500.00) per calendar day.

INTERMEDIATE COMPLETION DATE AND LIQUIDATED DAMAGES

The Contractor shall be limited to three weeks for the road closure. All work requiring a road closure shall be completed during this time. **The liquidated damages for this intermediate completion date are Five Hundred Dollars (\$500.00) per calendar day.** Liquidated damages chargeable due to failure to complete this work by the intermediate completion date will be additional to any liquidated damages that may become chargeable due to failure to complete the remaining work on time.

EXTENSION OF CONTRACT TIME

Failure on the part of the Contractor to furnish bonds or certifications or to satisfy preliminary requirements necessary to issue the purchase order will not constitute grounds for extension of the contract time. If the Contractor has fulfilled all preliminary requirements for the issuance of a purchase order, and the purchase order authorization is not available by the date of availability, the Contractor shall be granted an extension equal to the number of calendar days the purchase order authorization is delayed after the date of availability.

AUTHORITY OF THE ENGINEER

The Engineer for this project shall be the Division Engineer, Division 6, Division of Highways, North Carolina Department of Transportation, acting directly or through his duly authorized representatives.

The Engineer will decide all questions which may arise as to the quality and acceptability of work performed and as to the rate of progress of the work; all questions which may arise as to the interpretation of the contract; and all questions as to the acceptable fulfillment of the contract on the part of the Contractor. His decision shall be final and he shall have executive authority to enforce and make effective such decisions and order as the Contractor fails to carry out promptly.

NO MAJOR CONTRACT ITEMS

(2-19-02) (Rev 8-21-07)

SP1 G31

None of the items included in this contract will be major items.

EMPLOYMENT

(11-15-11) (Rev. 1-17-12)

108, 102

SP1 G184

Revise the *2012 Standard Specifications* as follows:

Page 1-20, Subarticle 102-15(O), delete and replace with the following:

(O) Failure to restrict a former Department employee as prohibited by Article 108-5.

Page 1-65, Article 108-5 Character of Workmen, Methods, and Equipment, line 32, delete all of line 32, the first sentence of the second paragraph and the first word of the second sentence of the second paragraph.

INSPECTION

All work shall be subject to inspection by the Engineer at any time. Routinely, the Engineer will make periodic inspections of the completed work. It will be the responsibility of the Contractor to keep the Engineer informed of his proposed work plan and to submit written reports of work accomplished on a frequency to be determined by the Engineer.

PROSECUTION AND PROGRESS

The Contractor shall pursue the work diligently with workmen in sufficient numbers, abilities, and supervision, and with equipment, materials, and methods of construction as may be required to complete the work described in the contract by the completion date and in accordance with Section 108 of the Standard Specifications.

CONFORMITY WITH THE CONTRACT

The presence of the engineer or an inspector at the work site shall in no way lessen the contractor's responsibility for conformity with the provisions of this contract. Should the engineer or inspector fail to point out work that does not conform to the plans and specifications, whether from lack of discovery or for any other reason, it shall in no way prevent later rejection or correction to the unsatisfactory work when discovered. The contractor shall have no claim for losses suffered due to any necessary removals or repairs resulting from unsatisfactory work.

LIABILITY INSURANCE

(5-20-14)

SP1 G160

Revise the *2012 Standard Specifications* as follows:

Page 1-60, Article 107-15 LIABILITY INSURANCE, line 16, add the following as the second sentence of the third paragraph:

Prior to beginning services, all contractors shall provide proof of coverage issued by a workers' compensation insurance carrier, or a certificate of compliance issued by the Department of Insurance for self-insured subcontractors, irrespective of whether having regularly in service fewer than three employees.

RESPONSIBILITY FOR DAMAGE CLAIMS

In accordance with Article 107-15 of the Standard Specifications, the Contractor shall indemnify and save harmless the Department of Transportation and its officers, agents and employees from all suits, actions, or claims of any character brought for any injury or damages received or sustained by any person, persons or property by reason of any act of the Contractor, subcontractor, its agents or employees, in the performance of the contract. The Contractor further agrees to indemnify and save harmless the Department of Transportation and its officers, agents, and employees from any claims or amounts recovered by any of the Contractor's employees under the Worker's Compensation Act.

Pursuant to N.C.G.S. 97-19, all Contractors of the Department of Transportation are, prior to beginning services, required to show proof of coverage issued by a Worker's Compensation Insurance Carrier, or a Certificate of Compliance issued by the Department of Insurance for self-insured Subcontractors stating that it has complied with N.C.G.S. 97-93 irrespective of whether Subcontractors have regularly in service fewer than three employees in the same business within the State of North Carolina, and Subcontractors shall be hereinafter liable under the Worker's Compensation Act for payment of compensation and other benefits to its employees for any injury or death due to an accident arising out of, and in the course of performance of the work by, the Subcontractor.

CONTRACTOR'S LICENSE REQUIREMENTS

(7-1-95)

SP1G88

If the successful bidder does not hold the proper license to perform any plumbing, heating, air conditioning, or electrical work in this contract, he will be required to sublet such work to a contractor properly licensed in accordance with *Article 2 of Chapter 87 of the General Statutes* (licensing of heating, plumbing, and air conditioning contractors) and *Article 4 of Chapter 87 of the General Statutes* (licensing of electrical contractors).

CONTRACT PAYMENT AND PERFORMANCE BOND

A performance bond in the amount of one hundred percent (100%) of the contract amount, conditioned upon the faithful performance of the contract in accordance with specifications and conditions of the contract is required for Construction

contracts of \$300,000 or more. Such bond shall be solely for the protection of the North Carolina Department of Transportation and the State of North Carolina.

A payment bond in the amount of one hundred percent (100%) of the contract amount, conditioned upon the prompt payment for all labor or materials for which the Contractor, or his subcontractors, is liable is required for Construction contracts greater than \$300,000. The payment bond shall be solely for the protection of persons or firms furnishing materials or performing labor for this contract for which the Contractor is liable. The successful bidder, within fourteen (14) days after notice of award, shall provide the Department with a contract payment bond and a contract performance bond each in an amount equal to 100 percent of the amount of the contract.

PAYMENT AND PERFORMANCE BONDS WILL BE REQUIRED ON THIS CONTRACT.

MINORITY BUSINESS ENTERPRISE AND WOMEN BUSINESS ENTERPRISE

(10-16-07)(Rev. 12-17-13)

102-15(J)

SP1 G67

Description

The purpose of this Special Provision is to carry out the North Carolina Department of Transportation's policy of ensuring nondiscrimination in the award and administration of contracts financed in whole or in part with State funds.

Definitions

Additional MBE/WBE Subcontractors - Any MBE/WBE submitted at the time of bid that will not be used to meet either the MBE or WBE goal. No submittal of a Letter of Intent is required.

Committed MBE/WBE Subcontractor - Any MBE/WBE submitted at the time of bid that is being used to meet either the MBE or WBE goal by submission of a Letter of Intent. Or any MBE or WBE used as a replacement for a previously committed MBE or WBE firm.

Contract Goals Requirement - The approved MBE and WBE participation at time of award, but not greater than the advertised contract goals for each.

Goal Confirmation Letter - Written documentation from the Department to the bidder confirming the Contractor's approved, committed MBE and WBE participation along with a listing of the committed MBE and WBE firms.

Manufacturer - A firm that operates or maintains a factory or establishment that produces on the premises, the materials or supplies obtained by the Contractor.

MBE Goal - A portion of the total contract, expressed as a percentage, that is to be performed by committed MBE subcontractor(s).

Minority Business Enterprise (MBE) - A firm certified as a Disadvantaged Minority-Owned Business Enterprise through the North Carolina Unified Certification Program.

Regular Dealer - A firm that owns, operates, or maintains a store, warehouse, or other establishment in which the materials or supplies required for the performance of the contract are bought, kept in stock, and regularly sold to the public in the usual course of business. A regular dealer engages in, as its principal business and in its own name, the purchase and sale or lease of the products in question. A regular dealer in such bulk items as steel, cement, gravel, stone, and petroleum products need not keep such products in stock, if it owns and operates distribution equipment for the products. Brokers and packagers are not regarded as manufacturers or regular dealers within the meaning of this section.

North Carolina Unified Certification Program (NCUCP) - A program that provides comprehensive services and information to applicants for MBE/WBE certification. The MBE/WBE program follows the same regulations as the federal Disadvantaged Business Enterprise (DBE) program in accordance with 49 CFR Part 26.

United States Department of Transportation (USDOT) - Federal agency responsible for issuing regulations (49 CFR Part 26) and official guidance for the DBE program.

WBE Goal - A portion of the total contract, expressed as a percentage, that is to be performed by committed WBE subcontractor(s).

Women Business Enterprise (WBE) - A firm certified as a Disadvantaged Women-Owned Business Enterprise through the North Carolina Unified Certification Program.

Forms and Websites Referenced in this Provision

Payment Tracking System - On-line system in which the Contractor enters the payments made to MBE and WBE subcontractors who have performed work on the project. <https://apps.dot.state.nc.us/Vendor/PaymentTracking/>

DBE-IS Subcontractor Payment Information - Form for reporting the payments made to all MBE/WBE firms working on the project. This form is for paper bid projects only. <http://www.ncdot.org/doh/forms/files/DBE-IS.xls>

RF-1 MBE/WBE Replacement Request Form - Form for replacing a committed MBE or WBE. <http://connect.ncdot.gov/projects/construction/Construction%20Forms/DBE%20MBE%20WBE%20Replacement%20Request%20Form.pdf>

SAF Subcontract Approval Form - Form required for approval to sublet the contract. <http://connect.ncdot.gov/projects/construction/Construction%20Forms/Subcontract%20Approval%20Form%20Rev.%202012.zip>

JC-1 Joint Check Notification Form - Form and procedures for joint check notification. The form acts as a written joint check agreement among the parties providing full and prompt disclosure of the expected use of joint checks. <http://connect.ncdot.gov/projects/construction/Construction%20Forms/Joint%20Check%20Notification%20Form.pdf>

Letter of Intent - Form signed by the Contractor and the MBE/WBE subcontractor, manufacturer or regular dealer that affirms that a portion of said contract is going to be performed by the signed MBE/WBE for the amount listed at the time of bid. <http://connect.ncdot.gov/letting/LetCentral/Letter%20of%20Intent%20to%20Perform%20as%20a%20Subcontractor.pdf>

Listing of MBE and WBE Subcontractors Form - Form for entering MBE/WBE subcontractors on a project that will meet this MBE and WBE goals. This form is for paper bids only. [http://connect.ncdot.gov/municipalities/Bid%20Proposals%20for%20LGA%20Content/09%20MBE-WBE%20Subcontractors%20\(State\).doc](http://connect.ncdot.gov/municipalities/Bid%20Proposals%20for%20LGA%20Content/09%20MBE-WBE%20Subcontractors%20(State).doc)

Subcontractor Quote Comparison Sheet - Spreadsheet for showing all subcontractor quotes in the work areas where MBEs and WBEs quoted on the project. This sheet is submitted with good faith effort packages. <http://connect.ncdot.gov/business/SmallBusiness/Documents/DBE%20Subcontractor%20Quote%20Comparison%20Example.xls>

MBE and WBE Goal

The following goals for participation by Minority Business Enterprises and Women Business Enterprises are established for this contract:

- (A) Minority Business Enterprises **2.0** %
 - (1) *If the MBE goal is more than zero*, the Contractor shall exercise all necessary and reasonable steps to ensure that MBEs participate in at least the percent of the contract as set forth above as the MBE goal.
 - (2) *If the MBE goal is zero*, the Contractor shall make an effort to recruit and use MBEs during the performance of the contract. Any MBE participation obtained shall be reported to the Department.

- (B) Women Business Enterprises **2.0** %
 - (1) *If the WBE goal is more than zero*, the Contractor shall exercise all necessary and reasonable steps to ensure that WBEs participate in at least the percent of the contract as set forth above as the WBE goal.

- (2) *If the WBE goal is zero, the Contractor shall make an effort to recruit and use WBEs during the performance of the contract. Any WBE participation obtained shall be reported to the Department.*

Directory of Transportation Firms (Directory)

Real-time information is available about firms doing business with the Department and firms that are certified through NCUCP in the Directory of Transportation Firms. Only firms identified in the Directory as MBE and WBE certified shall be used to meet the MBE and WBE goals respectively. The Directory can be found at the following link. <https://partner.ncdot.gov/VendorDirectory/default.html>

The listing of an individual firm in the directory shall not be construed as an endorsement of the firm's capability to perform certain work.

Listing of MBE/WBE Subcontractors

At the time of bid, bidders shall submit all MBE and WBE participation that they anticipate to use during the life of the contract. Only those identified to meet the MBE goal and the WBE goal will be considered committed, even though the listing shall include both committed MBE/WBE subcontractors and additional MBE/WBE subcontractors. Any additional MBE/WBE subcontractor participation submitted at the time of bid will be used toward overall race-neutral goals. Only those firms with current MBE and WBE certification at the time of bid opening will be acceptable for listing in the bidder's submittal of MBE and WBE participation. The Contractor shall indicate the following required information:

- (A) *If either the MBE or WBE goal is more than zero,*
- (1) Bidders, at the time the bid proposal is submitted, shall submit a listing of MBE/WBE participation, including the names and addresses on *Listing of MBE and WBE Subcontractors* contained elsewhere in the contract documents in order for the bid to be considered responsive. Bidders shall indicate the total dollar value of the MBE and WBE participation for the contract.
 - (2) If bidders have no MBE or WBE participation, they shall indicate this on the *Listing of MBE and WBE Subcontractors* by entering the word "None" or the number "0." This form shall be completed in its entirety. **Blank forms will not be deemed to represent zero participation.** Bids submitted that do not have MBE and WBE participation indicated on the appropriate form will not be read publicly during the opening of bids. The Department will not consider these bids for award and the proposal will be rejected.
 - (3) The bidder shall be responsible for ensuring that the MBE/WBE is certified at the time of bid by checking the Directory of Transportation Firms. If the firm is not certified at the time of the bid-letting, that MBE's or WBE's participation will not count towards achieving the corresponding goal.
- (B) *If either the MBE or WBE goal is zero, entries on the Listing of MBE and WBE Subcontractors are not required for the zero goal, however any MBE or WBE participation that is achieved during the project shall be reported in accordance with requirements contained elsewhere in the special provision.*

MBE or WBE Prime Contractor

When a certified MBE or WBE firm bids on a contract that contains MBE and WBE goals, the firm is responsible for meeting the goals or making good faith efforts to meet the goals, just like any other bidder. In most cases, a MBE or WBE bidder on a contract will meet one of the goals by virtue of the work it performs on the contract with its own forces. However, all the work that is performed by the MBE or WBE bidder and any other similarly certified subcontractors will count toward the goal. The MBE or WBE bidder shall list itself along with any MBE or WBE subcontractors, if any, in order to receive credit toward the goals.

For example, on a proposed contract, the WBE goal is 10%, and the MBE goal is 8%. A WBE bidder puts in a bid where they will perform 40% of the contract work and have a WBE subcontractor which will perform another 5% of the work. Together the two WBE firms submit on the *Listing of MBE and WBE Subcontractors* a value of 45% of the contract which fulfills the WBE goal. The 8% MBE goal shall be obtained through MBE participation with MBE certified subcontractors or documented through a good faith effort. It should be noted that you cannot combine the two goals to meet an overall value. The two goals shall remain separate.

MBE/WBE prime contractors shall also follow Sections A or B listed under *Listing of MBE/WBE Subcontractors* just as a non-MBE/WBE bidder would.

Written Documentation – Letter of Intent

The bidder shall submit written documentation for each MBE/WBE that will be used to meet the MBE and WBE goals of the contract, indicating the bidder's commitment to use the MBE/WBE in the contract. This documentation shall be submitted on the Department's form titled *Letter of Intent*.

The documentation shall be received in the office of the Engineer no later than 12:00 noon of the sixth calendar day following opening of bids, unless the sixth day falls on Saturday, Sunday or an official state holiday. In that situation, it is due in the office of the Engineer no later than 12:00 noon on the next official state business day.

If the bidder fails to submit the Letter of Intent from each committed MBE and WBE to be used toward the MBE and WBE goals, or if the form is incomplete (i.e. both signatures are not present), the MBE/WBE participation will not count toward meeting the MBE/WBE goal. If the lack of this participation drops the commitment below either the MBE or WBE goal, the Contractor shall submit evidence of good faith efforts for the goal not met, completed in its entirety, to the Engineer no later than 12:00 noon of the eighth calendar day following opening of bids, unless the eighth day falls on Saturday, Sunday or an official state holiday. In that situation, it is due in the office of the Engineer no later than 12:00 noon on the next official state business day.

Submission of Good Faith Effort

If the bidder fails to meet or exceed either the MBE or the WBE goal, the apparent lowest responsive bidder shall submit to the Department documentation of adequate good faith efforts made to reach that specific goal(s).

One complete set and 7 (seven) copies of this information shall be received in the office of the Engineer no later than 12:00 noon of the sixth calendar day following opening of bids, unless the sixth day falls on Saturday, Sunday or an official state holiday. In that situation, it is due in the office of the Engineer no later than 12:00 noon on the next official state business day.

Note: Where the information submitted includes repetitious solicitation letters, it will be acceptable to submit a representative letter along with a distribution list of the firms that were solicited. Documentation of MBE/WBE quotations shall be a part of the good faith effort submittal. This documentation may include written subcontractor quotations, telephone log notations of verbal quotations, or other types of quotation documentation.

Consideration of Good Faith Effort for Projects with MBE/WBE Goals More Than Zero

Adequate good faith efforts mean that the bidder took all necessary and reasonable steps to achieve the goal which, by their scope, intensity, and appropriateness, could reasonably be expected to obtain sufficient MBE/WBE participation. Adequate good faith efforts also mean that the bidder actively and aggressively sought MBE/WBE participation. Mere *pro forma* efforts are not considered good faith efforts.

The Department will consider the quality, quantity, and intensity of the different kinds of efforts a bidder has made. Listed below are examples of the types of actions a bidder will take in making a good faith effort to meet the goals and are not intended to be exclusive or exhaustive, nor is it intended to be a mandatory checklist.

- (A) Soliciting through all reasonable and available means (e.g. attendance at pre-bid meetings, advertising, written notices, use of verifiable electronic means through the use of the NCDOT Directory of Transportation Firms) the interest of all certified MBEs/WBEs who have the capability to perform the work of the contract. The bidder must solicit this interest within at least 10 days prior to bid opening to allow the MBEs/WBEs to respond to the solicitation. Solicitation shall provide the opportunity to MBEs/WBEs within the Division and surrounding Divisions where the project is located. The bidder must determine with certainty if the MBEs/WBEs are interested by taking appropriate steps to follow up initial solicitations.

- (B) Selecting portions of the work to be performed by MBEs/WBEs in order to increase the likelihood that the MBE and WBE goals will be achieved.
 - (1) Where appropriate, break out contract work items into economically feasible units to facilitate MBE/WBE participation, even when the prime contractor might otherwise prefer to perform these work items with its own forces.
 - (2) Negotiate with subcontractors to assume part of the responsibility to meet the contract MBE/WBE goals when the work to be sublet includes potential for MBE/WBE participation (2nd and 3rd tier subcontractors).
- (C) Providing interested MBEs/WBEs with adequate information about the plans, specifications, and requirements of the contract in a timely manner to assist them in responding to a solicitation.
- (D) (1) Negotiating in good faith with interested MBEs/WBEs. It is the bidder's responsibility to make a portion of the work available to MBE/WBE subcontractors and suppliers and to select those portions of the work or material needs consistent with the available MBE/WBE subcontractors and suppliers, so as to facilitate MBE/WBE participation. Evidence of such negotiation includes the names, addresses, and telephone numbers of MBEs/WBEs that were considered; a description of the information provided regarding the plans and specifications for the work selected for subcontracting; and evidence as to why additional agreements could not be reached for MBEs/WBEs to perform the work.
 - (2) A bidder using good business judgment would consider a number of factors in negotiating with subcontractors, including MBE/WBE subcontractors, and would take a firm's price and capabilities as well as contract goals into consideration. However, the fact that there may be some additional costs involved in finding and using MBEs/WBEs is not in itself sufficient reason for a bidder's failure to meet the contract MBE or WBE goals, as long as such costs are reasonable. Also, the ability or desire of a prime contractor to perform the work of a contract with its own organization does not relieve the bidder of the responsibility to make good faith efforts. Bidding contractors are not, however, required to accept higher quotes from MBEs/WBEs if the price difference is excessive or unreasonable.
- (E) Not rejecting MBEs/WBEs as being unqualified without sound reasons based on a thorough investigation of their capabilities. The bidder's standing within its industry, membership in specific groups, organizations, or associates and political or social affiliations (for example, union vs. non-union employee status) are not legitimate causes for the rejection or non-solicitation of bids in the bidder's efforts to meet the project goal.
- (F) Making efforts to assist interested MBEs/WBEs in obtaining bonding, lines of credit, or insurance as required by the recipient or bidder.
- (G) Making efforts to assist interested MBEs/WBEs in obtaining necessary equipment, supplies, materials, or related assistance or services.
- (H) Effectively using the services of available minority/women community organizations; minority/women contractors' groups; Federal, State, and local minority/women business assistance offices; and other organizations as allowed on a case-by-case basis to provide assistance in the recruitment and placement of MBEs/WBEs. Contact within 7 days from the bid opening NCDOT's Business Development Manager in the Business Opportunity and Work Force Development Unit to give notification of the bidder's inability to get MBE or WBE quotes.
- (I) Any other evidence that the bidder submits which shows that the bidder has made reasonable good faith efforts to meet the MBE and WBE goal.

In addition, the Department may take into account the following:

- (1) Whether the bidder's documentation reflects a clear and realistic plan for achieving the MBE and WBE goals.
- (2) The bidders' past performance in meeting the MBE and WBE goals.

- (3) The performance of other bidders in meeting the MBE and WBE goals. For example, when the apparent successful bidder fails to meet the goals, but others meet it, you may reasonably raise the question of whether, with additional reasonable efforts the apparent successful bidder could have met the goals. If the apparent successful bidder fails to meet the MBE and WBE goals, but meets or exceeds the average MBE and WBE participation obtained by other bidders, the Department may view this, in conjunction with other factors, as evidence of the apparent successful bidder having made a good faith effort.

If the Department does not award the contract to the apparent lowest responsive bidder, the Department reserves the right to award the contract to the next lowest responsive bidder that can satisfy to the Department that the MBE and WBE goals can be met or that an adequate good faith effort has been made to meet the MBE and WBE goals.

Non-Good Faith Appeal

The Engineer will notify the contractor verbally and in writing of non-good faith. A contractor may appeal a determination of non-good faith made by the Goal Compliance Committee. If a contractor wishes to appeal the determination made by the Committee, they shall provide written notification to the Engineer. The appeal shall be made within 2 business days of notification of the determination of non-good faith.

Counting MBE/WBE Participation Toward Meeting MBE/WBE Goals

(A) Participation

The total dollar value of the participation by a committed MBE/WBE will be counted toward the contract goal requirements. The total dollar value of participation by a committed MBE/WBE will be based upon the value of work actually performed by the MBE/WBE and the actual payments to MBE/WBE firms by the Contractor.

(B) Joint Checks

Prior notification of joint check use shall be required when counting MBE/WBE participation for services or purchases that involves the use of a joint check. Notification shall be through submission of Form JC-1 (*Joint Check Notification Form*) and the use of joint checks shall be in accordance with the Department's Joint Check Procedures.

(C) Subcontracts (Non-Trucking)

A MBE/WBE may enter into subcontracts. Work that a MBE subcontracts to another MBE firm may be counted toward the MBE contract goal requirement. The same holds for work that a WBE subcontracts to another WBE firm. Work that a MBE subcontracts to a non-MBE firm does not count toward the MBE contract goal requirement. Again, the same holds true for the work that a WBE subcontracts to a non-WBE firm. If a MBE or WBE contractor or subcontractor subcontracts a significantly greater portion of the work of the contract than would be expected on the basis of standard industry practices, it shall be presumed that the MBE or WBE is not performing a commercially useful function. The MBE/WBE may present evidence to rebut this presumption to the Department. The Department's decision on the rebuttal of this presumption may be subject to review by the Office of Inspector General, NCDOT.

(D) Joint Venture

When a MBE or WBE performs as a participant in a joint venture, the Contractor may count toward its contract goal requirement a portion of the total value of participation with the MBE or WBE in the joint venture, that portion of the total dollar value being a distinct clearly defined portion of work that the MBE or WBE performs with its forces.

(E) Suppliers

A contractor may count toward its MBE or WBE requirement 60 percent of its expenditures for materials and supplies required to complete the contract and obtained from a MBE or WBE regular dealer and 100 percent of such expenditures from a MBE or WBE manufacturer.

(F) Manufacturers and Regular Dealers

A contractor may count toward its MBE or WBE requirement the following expenditures to MBE/WBE firms that are not manufacturers or regular dealers:

- (1) The fees or commissions charged by a MBE/WBE firm for providing a *bona fide* service, such as professional, technical, consultant, or managerial services, or for providing bonds or insurance specifically required for the performance of a DOT-assisted contract, provided the fees or commissions are determined to be reasonable and not excessive as compared with fees and commissions customarily allowed for similar services.
- (2) With respect to materials or supplies purchased from a MBE/WBE, which is neither a manufacturer nor a regular dealer, count the entire amount of fees or commissions charged for assistance in the procurement of the materials and supplies, or fees or transportation charges for the delivery of materials or supplies required on a job site (but not the cost of the materials and supplies themselves), provided the fees are determined to be reasonable and not excessive as compared with fees customarily allowed for similar services.

Commercially Useful Function

(A) MBE/WBE Utilization

The Contractor may count toward its contract goal requirement only expenditures to MBEs and WBEs that perform a commercially useful function in the work of a contract. A MBE/WBE performs a commercially useful function when it is responsible for execution of the work of the contract and is carrying out its responsibilities by actually performing, managing, and supervising the work involved. To perform a commercially useful function, the MBE/WBE shall also be responsible with respect to materials and supplies used on the contract, for negotiating price, determining quality and quantity, ordering the material and installing (where applicable) and paying for the material itself. To determine whether a MBE/WBE is performing a commercially useful function, the Department will evaluate the amount of work subcontracted, industry practices, whether the amount the firm is to be paid under the contract is commensurate with the work it is actually performing and the MBE/WBE credit claimed for its performance of the work, and any other relevant factors.

(B) MBE/WBE Utilization in Trucking

The following factors will be used to determine if a MBE or WBE trucking firm is performing a commercially useful function:

- (1) The MBE/WBE shall be responsible for the management and supervision of the entire trucking operation for which it is responsible on a particular contract, and there shall not be a contrived arrangement for the purpose of meeting the MBE or WBE goal.
- (2) The MBE/WBE shall itself own and operate at least one fully licensed, insured, and operational truck used on the contract.
- (3) The MBE/WBE receives credit for the total value of the transportation services it provides on the contract using trucks it owns, insures, and operates using drivers it employs.
- (4) The MBE may subcontract the work to another MBE firm, including an owner-operator who is certified as a MBE. The same holds true that a WBE may subcontract the work to another WBE firm, including an owner-operator who is certified as a WBE. When this occurs, the MBE or WBE who subcontracts work receives credit for the total value of the transportation services the subcontracted MBE or WBE provides on the contract. It should be noted that every effort shall be made by MBE and WBE contractors to subcontract to the same certification (i.e., MBEs to MBEs and WBEs to WBEs), in order to fulfill the goal requirement. This, however, may not always be possible due to the limitation of firms in the area. If the MBE or WBE firm shows a good faith effort has been made to reach out to similarly certified transportation service providers and there is no interest or availability, and they can get assistance from other certified providers, the Engineer will not hold the prime liable for meeting the goal.

- (5) The MBE/WBE may also subcontract the work to a non-MBE/WBE firm, including from an owner-operator. The MBE/WBE who subcontracts the work to a non-MBE/WBE is entitled to credit for the total value of transportation services provided by the non-MBE/WBE subcontractor not to exceed the value of transportation services provided by MBE/WBE-owned trucks on the contract. Additional participation by non-MBE/WBE subcontractors receives credit only for the fee or commission it receives as a result of the subcontract arrangement. The value of services performed under subcontract agreements between the MBE/WBE and the Contractor will not count towards the MBE/WBE contract requirement.
- (6) A MBE/WBE may lease truck(s) from an established equipment leasing business open to the general public. The lease must indicate that the MBE/WBE has exclusive use of and control over the truck. This requirement does not preclude the leased truck from working for others during the term of the lease with the consent of the MBE/WBE, so long as the lease gives the MBE/WBE absolute priority for use of the leased truck. This type of lease may count toward the MBE/WBE's credit as long as the driver is under the MBE/WBE's payroll.
- (7) Subcontracted/leased trucks shall display clearly on the dashboard the name of the MBE/WBE that they are subcontracted/leased to and their own company name if it is not identified on the truck itself. Magnetic door signs are not permitted.

MBE/WBE Replacement

When a Contractor has relied on a commitment to a MBE or WBE firm (or an approved substitute MBE or WBE firm) to meet all or part of a contract goal requirement, the contractor shall not terminate the MBE/WBE for convenience. This includes, but is not limited to, instances in which the Contractor seeks to perform the work of the terminated subcontractor with another MBE/WBE subcontractor, a non-MBE/WBE subcontractor, or with the Contractor's own forces or those of an affiliate. A MBE/WBE may only be terminated after receiving the Engineer's written approval based upon a finding of good cause for the termination.

All requests for replacement of a committed MBE/WBE firm shall be submitted to the Engineer for approval on Form RF-1 (*Replacement Request*). If the Contractor fails to follow this procedure, the Contractor may be disqualified from further bidding for a period of up to 6 months.

The Contractor shall comply with the following for replacement of a committed MBE/WBE:

(A) Performance Related Replacement

When a committed MBE is terminated for good cause as stated above, an additional MBE that was submitted at the time of bid may be used to fulfill the MBE commitment. The same holds true if a committed WBE is terminated for good cause, an additional WBE that was submitted at the time of bid may be used to fulfill the WBE goal. A good faith effort will only be required for removing a committed MBE/WBE if there were no additional MBEs/WBEs submitted at the time of bid to cover the same amount of work as the MBE/WBE that was terminated.

If a replacement MBE/WBE is not found that can perform at least the same amount of work as the terminated MBE/WBE, the Contractor shall submit a good faith effort documenting the steps taken. Such documentation shall include, but not be limited to, the following:

- (1) Copies of written notification to MBEs/WBEs that their interest is solicited in contracting the work defaulted by the previous MBE/WBE or in subcontracting other items of work in the contract.
- (2) Efforts to negotiate with MBEs/WBEs for specific subbids including, at a minimum:
 - (a) The names, addresses, and telephone numbers of MBEs/WBEs who were contacted.
 - (b) A description of the information provided to MBEs/WBEs regarding the plans and specifications for portions of the work to be performed.
- (3) A list of reasons why MBE/WBE quotes were not accepted.
- (4) Efforts made to assist the MBEs/WBEs contacted, if needed, in obtaining bonding or insurance required by the Contractor.

(B) Decertification Replacement

- (1) When a committed MBE/WBE is decertified by the Department after the SAF (*Subcontract Approval Form*) has been received by the Department, the Department will not require the Contractor to solicit replacement MBE/WBE participation equal to the remaining work to be performed by the decertified firm. The participation equal to the remaining work performed by the decertified firm will count toward the contract goal requirement.
- (2) When a committed MBE/WBE is decertified prior to the Department receiving the SAF (*Subcontract Approval Form*) for the named MBE/WBE firm, the Contractor shall take all necessary and reasonable steps to replace the MBE/WBE subcontractor with another similarly certified MBE/WBE subcontractor to perform at least the same amount of work to meet the MBE/WBE goal requirement. If a MBE/WBE firm is not found to do the same amount of work, a good faith effort must be submitted to NCDOT (see A herein for required documentation).

Changes in the Work

When the Engineer makes changes that result in the reduction or elimination of work to be performed by a committed MBE/WBE, the Contractor will not be required to seek additional participation. When the Engineer makes changes that result in additional work to be performed by a MBE/WBE based upon the Contractor's commitment, the MBE/WBE shall participate in additional work to the same extent as the MBE/WBE participated in the original contract work.

When the Engineer makes changes that result in extra work, which has more than a minimal impact on the contract amount, the Contractor shall seek additional participation by MBEs/WBEs unless otherwise approved by the Engineer.

When the Engineer makes changes that result in an alteration of plans or details of construction, and a portion or all of the work had been expected to be performed by a committed MBE/WBE, the Contractor shall seek participation by MBEs/WBEs unless otherwise approved by the Engineer.

When the Contractor requests changes in the work that result in the reduction or elimination of work that the Contractor committed to be performed by a MBE/WBE, the Contractor shall seek additional participation by MBEs/WBEs equal to the reduced MBE/WBE participation caused by the changes.

Reports and Documentation

A SAF (*Subcontract Approval Form*) shall be submitted for all work which is to be performed by a MBE/WBE subcontractor. The Department reserves the right to require copies of actual subcontract agreements involving MBE/WBE subcontractors.

When using transportation services to meet the contract commitment, the Contractor shall submit a proposed trucking plan in addition to the SAF. The plan shall be submitted prior to beginning construction on the project. The plan shall include the names of all trucking firms proposed for use, their certification type(s), the number of trucks owned by the firm, as well as the individual truck identification numbers, and the line item(s) being performed.

Within 30 calendar days of entering into an agreement with a MBE/WBE for materials, supplies or services, not otherwise documented by the SAF as specified above, the Contractor shall furnish the Engineer a copy of the agreement. The documentation shall also indicate the percentage (60% or 100%) of expenditures claimed for MBE/WBE credit.

Reporting Minority and Women Business Enterprise Participation

The Contractor shall provide the Engineer with an accounting of payments made to all MBE and WBE firms, including material suppliers and contractors at all levels (prime, subcontractor, or second tier subcontractor). This accounting shall be furnished to the Engineer for any given month by the end of the following month. Failure to submit this information accordingly may result in the following action:

- (A) Withholding of money due in the next partial pay estimate; or
- (B) Removal of an approved contractor from the prequalified bidders' list or the removal of other entities from the approved subcontractors list.

While each contractor (prime, subcontractor, 2nd tier subcontractor) is responsible for accurate accounting of payments to MBEs/WBEs, it shall be the prime contractor's responsibility to report all monthly and final payment information in the correct reporting manner.

Failure on the part of the Contractor to submit the required information in the time frame specified may result in the disqualification of that contractor and any affiliate companies from further bidding until the required information is submitted.

Failure on the part of any subcontractor to submit the required information in the time frame specified may result in the disqualification of that contractor and any affiliate companies from being approved for further work on future projects until the required information is submitted.

Contractors reporting transportation services provided by non-MBE/WBE lessees shall evaluate the value of services provided during the month of the reporting period only.

At any time, the Engineer can request written verification of subcontractor payments.

The Contractor shall report the accounting of payments on the Department's DBE-IS (*Subcontractor Payment Information*) with each invoice. Invoices will not be processed for payment until the DBE-IS is received.

Failure to Meet Contract Requirements

Failure to meet contract requirements in accordance with Subarticle 102-15(J) of the *2012 Standard Specifications* may be cause to disqualify the Contractor.

CLAIMS FOR ADDITIONAL COMPENSATION OR EXTENSION OF TIME

Any claims for additional compensation and/or extensions of the completion date shall be submitted to the Division Engineer with detailed justification within thirty (30) days after receipt of the final invoice payment. The failure of the Contractor to submit the claim(s) within thirty days shall be a bar to recovery.

TWELVE MONTH GUARANTEE

(7-15-03)

SP1G145

- (A) The Contractor shall guarantee materials and workmanship against latent and patent defects arising from faulty materials, faulty workmanship or negligence for a period of twelve months following the date of final acceptance of the work for maintenance and shall replace such defective materials and workmanship without cost to the Department. The Contractor will not be responsible for damage due to faulty design, normal wear and tear, for negligence on the part of the Department, and/or for use in excess of the design.
- (B) Where items of equipment or material carry a manufacturer's guarantee for any period in excess of twelve months, then the manufacturer's guarantee shall apply for that particular piece of equipment or material. The Department's first remedy shall be through the manufacturer although the Contractor is responsible for invoking the warranted repair work with the manufacturer. The Contractor's responsibility shall be limited to the term of the manufacturer's guarantee. NCDOT would be afforded the same warranty as provided by the Manufacturer.

This guarantee provision shall be invoked only for major components of work in which the Contractor would be wholly responsible for under the terms of the contract. Examples would include pavement structures, bridge components, and sign structures. This provision will not be used as a mechanism to force the Contractor to return to the project to make repairs or perform additional work that the Department would normally compensate the Contractor for. In addition, routine maintenance activities (i.e. mowing grass, debris removal, ruts in earth shoulders,) are not parts of this guarantee.

Appropriate provisions of the payment and/or performance bonds shall cover this guarantee for the project.

To ensure uniform application statewide the Division Engineer will forward details regarding the circumstances surrounding any proposed guarantee repairs to the Chief Engineer for review and approval prior to the work being performed.

GIFTS FROM VENDORS AND CONTRACTORS

(12-15-09)

SP1 G152

By Executive Order 24, issued by Governor Perdue, and N.C. G.S. § 133-32, it is unlawful for any vendor or contractor (i.e. architect, bidder, contractor, construction manager, design professional, engineer, landlord, offeror, seller, subcontractor, supplier, or vendor), to make gifts or to give favors to any State employee of the Governor's Cabinet Agencies (i.e. Administration, Commerce, Correction, Crime Control and Public Safety, Cultural Resources, Environment and Natural Resources, Health and Human Services, Juvenile Justice and Delinquency Prevention, Revenue, Transportation, and the Office of the Governor). This prohibition covers those vendors and contractors who:

- (1) Have a contract with a governmental agency; or
- (2) Have performed under such a contract within the past year; or
- (3) Anticipate bidding on such a contract in the future.

For additional information regarding the specific requirements and exemptions, vendors and contractors are encouraged to review Executive Order 24 and G.S. § 133-32.

Executive Order 24 also encouraged and invited other State Agencies to implement the requirements and prohibitions of the Executive Order to their agencies. Vendors and contractors should contact other State Agencies to determine if those agencies have adopted Executive Order 24.

DOMESTIC STEEL

(4-16-13)

106

SP1 G120

Revise the *2012 Standard Specifications* as follows:

Page 1-49, Subarticle 106-1(B) Domestic Steel, lines 2-7, replace the first paragraph with the following:

All steel and iron products that are permanently incorporated into this project shall be produced in the United States except minimal amounts of foreign steel and iron products may be used provided the combined material cost of the items involved does not exceed 0.1% of the total amount bid for the entire project or \$2,500, whichever is greater. If invoices showing the cost of the material are not provided, the amount of the bid item involving the foreign material will be used for calculations. This minimal amount of foreign produced steel and iron products permitted for use is not applicable to high strength fasteners. Domestically produced high strength fasteners are required.

MATERIAL AND EQUIPMENT STORAGE AND PARKING

When work is not in progress, keep all personnel, equipment, machinery, tools, construction debris and supplies at least 40 ft. (12.2 m) within barricades

SUPERVISION BY CONTRACTOR

At all times during the life of the project the Contractor shall provide one permanent employee who shall have the authority and capability for overall responsibility of the project and who shall be personally available at the work site within 24 hours' notice. Such employee shall be fully authorized to conduct all business with the subcontractors, to negotiate and execute all supplemental agreements, and to execute the orders or directions of the Engineer.

At all times that work is actually being performed, the Contractor shall have present on the project one competent individual who is authorized to act in a supervisory capacity over all work on the project, including work subcontracted. The individual who has been so authorized shall be experienced in the type of work being performed and shall be fully capable of managing, directing, and coordinating the work; of reading and thoroughly understanding the contract; and receiving and carrying out directions from the Engineer or his authorized representatives. He shall be an employee of the Contractor unless otherwise approved by the Engineer.

The Contractor may, at his option, designate one employee to meet the requirements of both positions. However, whenever the designated employee is absent from the work site, an authorized individual qualified to act in a supervisory capacity on the project shall be present.

SAFETY AND ACCIDENT PROTECTION

In accordance with Article 107-22 of the Standard Specifications, the Contractor shall comply with all applicable Federal, State, and local laws, ordinances, and regulations governing safety, health, and sanitation, and shall provide all safeguards, safety devices, and protective equipment, and shall take any other needed actions, on his own responsibility that are reasonably necessary to protect the life and health of employees on the job and the safety of the public, and to protect property in connection with the performance of the work covered by the contract.

SAFETY VESTS

All Contractors' personnel, all subcontractors and their personnel, and any material suppliers and their personnel shall wear a reflective vest or outer garment conforming to the requirements of MUTCD at all times while on the project.

SUBLETTING OF CONTRACT

The Contractor shall not sublet, sell, transfer, assign or otherwise dispose of this contract or any portion thereof; or his right, title, or interest therein; without written consent of the Engineer. Subletting of this contract or any portion of the contract shall conform to the requirements of Article of 108-6 of the Standard Specifications.

DEFAULT OF CONTRACT

The Department of Transportation shall have the right to declare a default of contract for breach by the Contractor of any material term or condition of the contract. Default of contract shall be in accordance with the terms, conditions, and procedures of Article 108-9 of the Standard Specifications.

PRESERVATION OF PROPERTY

The Contractor shall exercise care to avoid damage to all public and private property and facilities. Any damage to properties, such as, but not limited to, mailboxes, fences, gates, vehicles, driveways, etc. shall immediately be restored to the previously existing condition by the contractor. No payment will be made to the Contractor for such restorative work.

TEMPORARY SUSPENSION OF WORK

In accordance with Article 108-7 of the Standard Specifications, the Engineer will have the authority to suspend the work wholly or in part, any written order for such periods as he may deem necessary for any of the following reasons.

- A. Conditions considered unfavorable for the suitable prosecution of the work, or
- B. The Contractor's failure for correct conditions unsafe for workmen or the general public, or
- C. The Contractor has not carried out orders given to him by the Engineer, or
- D. The Contractor's failure to perform any provisions of the contract.

No extension of the completion date will be allowed for the above suspensions except as may be provided for in Article 108-10.

COORDINATION WITH OTHERS

The Contractor shall coordinate with the school personnel for possible conflicts and/or delays with school activities if the project is located within five miles of the school. All work shall be scheduled to minimize interference with all school traffic.

COOPERATION BETWEEN CONTRACTORS

The Contractor's attention is directed to Article 105-7 of the Standard Specifications. The Contractor on this project shall cooperate with the Contractor working within or adjacent to the limits of this project to the extent that the work can be carried out to the best advantage of all concerned.

PAYMENT

The Contractor may submit a request for partial payment on a monthly basis, or other interval as approved by the Engineer. The amount of partial payments will be based on the work accomplished and accepted as the last day of the approved pay period. The **INVOICE** shall show the quantities of items placed, unit bid price and the total cost as shown in the **SUMMARY OF QUANTITIES** sheet.

Invoices shall be submitted to:

Mr. D.K. Pittman
NCDOT
P.O. Box 1150
Fayetteville, NC 28302

NOTIFICATION OF OPERATIONS

The Contractor shall notify the Engineer two (2) weeks in advance of beginning work on this project. The Contractor shall give the Engineer sufficient notice of all operations for any sampling, inspection or acceptance testing required.

EROSION, SILTATION, AND POLLUTION CONTROL

The Contractor shall exercise every reasonable precaution and take all necessary measures throughout the life of the project to prevent erosion, siltation, and pollution in accordance with Section 107-13 of the Standard Specifications.

EROSION AND SEDIMENT CONTROL/STORMWATER CERTIFICATION

(1-16-07) (Rev 9-18-12)

105-16, 225-2, 16

SP1 G180

General

Schedule and conduct construction activities in a manner that will minimize soil erosion and the resulting sedimentation and turbidity of surface waters. Comply with the requirements herein regardless of whether or not a National Pollution discharge Elimination System (NPDES) permit for the work is required.

Establish a chain of responsibility for operations and subcontractors' operations to ensure that the *Erosion and Sediment Control/Stormwater Pollution Prevention Plan* is implemented and maintained over the life of the contract.

- (A) *Certified Supervisor* - Provide a certified Erosion and Sediment Control/Stormwater Supervisor to manage the Contractor and subcontractor operations, insure compliance with Federal, State and Local ordinances and regulations, and manage the Quality Control Program.
- (B) *Certified Foreman* - Provide a certified, trained foreman for each construction operation that increases the potential for soil erosion or the possible sedimentation and turbidity of surface waters.
- (C) *Certified Installer* - Provide a certified installer to install or direct the installation for erosion or sediment/stormwater control practices.
- (D) *Certified Designer* - Provide a certified designer for the design of the erosion and sediment control/stormwater component of reclamation plans and, if applicable, for the design of the project erosion and sediment control/stormwater plan.

Roles and Responsibilities

- (A) *Certified Erosion and Sediment Control/Stormwater Supervisor* - The Certified Supervisor shall be Level II and responsible for ensuring the erosion and sediment control/stormwater plan is adequately implemented and maintained on the project and for conducting the quality control program. The Certified Supervisor shall be on the project within 24 hours' notice from initial exposure of an erodible surface to the project's final acceptance. Perform the following duties:
- (1) Manage Operations - Coordinate and schedule the work of subcontractors so that erosion and sediment control/stormwater measures are fully executed for each operation and in a timely manner over the duration of the contract.
 - (a) Oversee the work of subcontractors so that appropriate erosion and sediment control/stormwater preventive measures are conformed to at each stage of the work.
 - (b) Prepare the required National Pollutant Discharge Elimination System (NPDES) Inspection Record and submit to the Engineer.
 - (c) Attend all weekly or monthly construction meetings to discuss the findings of the NPDES inspection and other related issues.
 - (d) Implement the erosion and sediment control/stormwater site plans requested.
 - (e) Provide any needed erosion and sediment control/stormwater practices for the Contractor's temporary work not shown on the plans, such as, but not limited to work platforms, temporary construction, pumping operations, plant and storage yards, and cofferdams.
 - (f) Acquire applicable permits and comply with requirements for borrow pits, dewatering, and any temporary work conducted by the Contractor in jurisdictional areas.
 - (g) Conduct all erosion and sediment control/stormwater work in a timely and workmanlike manner.
 - (h) Fully perform and install erosion and sediment control/stormwater work prior to any suspension of the work.
 - (i) Coordinate with Department, Federal, State and Local Regulatory agencies on resolution of erosion and sediment control/stormwater issues due to the Contractor's operations.
 - (j) Ensure that proper cleanup occurs from vehicle tracking on paved surfaces or any location where sediment leaves the Right-of-Way.
 - (k) Have available a set of erosion and sediment control/stormwater plans that are initialed and include the installation date of Best Management Practices. These practices shall include temporary and permanent groundcover and be properly updated to reflect necessary plan and field changes for use and review by Department personnel as well as regulatory agencies.
 - (2) Requirements set forth under the NPDES Permit - The Department's NPDES Stormwater permit (NCS000250) outlines certain objectives and management measures pertaining to construction activities. The permit references *NCG010000, General Permit to Discharge Stormwater* under the NPDES, and states that the Department shall incorporate the applicable requirements into its delegated Erosion and Sediment Control Program for construction activities disturbing one or more acres of land. The Department further incorporates these requirements on all contracted bridge and culvert work at jurisdictional waters, regardless of size. Some of the requirements are, but are not limited to:
 - (a) Control project site waste to prevent contamination of surface or ground waters of the state, i.e. from equipment operation/maintenance, construction materials, concrete washout, chemicals, litter, fuels, lubricants, coolants, hydraulic fluids, any other petroleum products, and sanitary waste.
 - (b) Inspect erosion and sediment control/stormwater devices and stormwater discharge outfalls at least once every 7 calendar days, twice weekly for construction related *Federal Clean Water Act, Section 303(d)* impaired streams with turbidity violations, and within 24 hours after a significant rainfall event of 0.5 inch that occurs within a 24 hour period.
 - (c) Maintain an onsite rain gauge or use the Department's Multi-Sensor Precipitation Estimate website to maintain a daily record of rainfall amounts and dates.
 - (d) Maintain erosion and sediment control/stormwater inspection records for review by Department and Regulatory personnel upon request.
 - (e) Implement approved reclamation plans on all borrow pits, waste sites and staging areas.
 - (f) Maintain a log of turbidity test results as outlined in the Department's Procedure for Monitoring Borrow Pit Discharge.
 - (g) Provide secondary containment for bulk storage of liquid materials.

- (h) Provide training for employees concerning general erosion and sediment control/stormwater awareness, the Department's NPDES Stormwater Permit NCS000250 requirements, and the applicable requirements of the *General Permit, NCG010000*.
 - (i) Report violations of the NPDES permit to the Engineer immediately who will notify the Division of Water Quality Regional Office within 24 hours of becoming aware of the violation.
- (3) Quality Control Program - Maintain a quality control program to control erosion, prevent sedimentation and follow provisions/conditions of permits. The quality control program shall:
- (a) Follow permit requirements related to the Contractor and subcontractors' construction activities.
 - (b) Ensure that all operators and subcontractors on site have the proper erosion and sediment control/stormwater certification.
 - (c) Notify the Engineer when the required certified erosion and sediment control/stormwater personnel are not available on the job site when needed.
 - (d) Conduct the inspections required by the NPDES permit.
 - (e) Take corrective actions in the proper timeframe as required by the NPDES permit for problem areas identified during the NPDES inspections.
 - (f) Incorporate erosion control into the work in a timely manner and stabilize disturbed areas with mulch/seed or vegetative cover on a section-by-section basis.
 - (g) Use flocculants approved by state regulatory authorities where appropriate and where required for turbidity and sedimentation reduction.
 - (h) Ensure proper installation and maintenance of temporary erosion and sediment control devices.
 - (i) Remove temporary erosion or sediment control devices when they are no longer necessary as agreed upon by the Engineer.
 - (j) The Contractor's quality control and inspection procedures shall be subject to review by the Engineer. Maintain NPDES inspection records and make records available at all times for verification by the Engineer.

(B) *Certified Foreman* - At least one Certified Foreman shall be onsite for each type of work listed herein during the respective construction activities to control erosion, prevent sedimentation and follow permit provisions:

- (1) Foreman in charge of grading activities
- (2) Foreman in charge of bridge or culvert construction over jurisdictional areas
- (3) Foreman in charge of utility activities

The Contractor may request to use the same person as the Level II Supervisor and Level II Foreman. This person shall be onsite whenever construction activities as described above are taking place. This request shall be approved by the Engineer prior to work beginning.

The Contractor may request to name a single Level II Foreman to oversee multiple construction activities on small bridge or culvert replacement projects. This request shall be approved by the Engineer prior to work beginning.

(C) *Certified Installers* - Provide at least one onsite, Level I Certified Installer for each of the following erosion and sediment control/stormwater crew:

- (1) Seeding and Mulching
- (2) Temporary Seeding
- (3) Temporary Mulching
- (4) Sodding
- (5) Silt fence or other perimeter erosion/sediment control device installations
- (6) Erosion control blanket installation
- (7) Hydraulic tackifier installation
- (8) Turbidity curtain installation
- (9) Rock ditch check/sediment dam installation
- (10) Ditch liner/matting installation
- (11) Inlet protection
- (12) Riprap placement
- (13) Stormwater BMP installations (such as but not limited to level spreaders, retention/detention devices)
- (14) Pipe installations within jurisdictional areas

If a Level I *Certified Installer* is not onsite, the Contractor may substitute a Level II Foreman for a Level I Installer, provided the Level II Foreman is not tasked to another crew requiring Level II Foreman oversight.

- (D) *Certified Designer* - Include the certification number of the Level III-B Certified Designer on the erosion and sediment control/stormwater component of all reclamation plans and if applicable, the certification number of the Level III-A Certified Designer on the design of the project erosion and sediment control/stormwater plan.

Preconstruction Meeting

Furnish the names of the *Certified Erosion and Sediment Control/Stormwater Supervisor*, *Certified Foremen*, *Certified Installers* and *Certified Designer* and notify the Engineer of changes in certified personnel over the life of the contract within 2 days of change.

Ethical Responsibility

Any company performing work for the North Carolina Department of Transportation has the ethical responsibility to fully disclose any reprimand or dismissal of an employee resulting from improper testing or falsification of records.

Revocation or Suspension of Certification

Upon recommendation of the Chief Engineer to the certification entity, certification for *Supervisor*, *Certified Foremen*, *Certified Installers* and *Certified Designer* may be revoked or suspended with the issuance of an *Immediate Corrective Action (ICA)*, *Notice of Violation (NOV)*, or *Cease and Desist Order* for erosion and sediment control/stormwater related issues.

The Chief Engineer may recommend suspension or permanent revocation of certification due to the following:

- (A) Failure to adequately perform the duties as defined within this certification provision.
- (B) Issuance of an ICA, NOV, or Cease and Desist Order.
- (C) Failure to fully perform environmental commitments as detailed within the permit conditions and specifications.
- (D) Demonstration of erroneous documentation or reporting techniques.
- (E) Cheating or copying another candidate's work on an examination.
- (F) Intentional falsification of records.
- (G) Directing a subordinate under direct or indirect supervision to perform any of the above actions.
- (H) Dismissal from a company for any of the above reasons.
- (I) Suspension or revocation of one's certification by another entity.

Suspension or revocation of a certification will be sent by certified mail to the certificant and the Corporate Head of the company that employs the certificant.

A certificant has the right to appeal any adverse action which results in suspension or permanent revocation of certification by responding, in writing, to the Chief Engineer within 10 calendar days after receiving notice of the proposed adverse action.

Chief Engineer
1537 Mail Service Center
Raleigh, NC 27699-1537

Failure to appeal within 10 calendar days will result in the proposed adverse action becoming effective on the date specified on the certified notice. Failure to appeal within the time specified will result in a waiver of all future appeal rights regarding the adverse action taken. The certificant will not be allowed to perform duties associated with the certification during the appeal process.

The Chief Engineer will hear the appeal and make a decision within 7 days of hearing the appeal. Decision of the Chief Engineer will be final and will be made in writing to the certificant.

If a certification is temporarily suspended, the certificant shall pass any applicable written examination and any proficiency examination, at the conclusion of the specified suspension period, prior to having the certification reinstated.

Measurement and Payment

Certified Erosion and Sediment Control/Stormwater Supervisor, Certified Foremen, Certified Installers and Certified Designer will be incidental to the project for which no direct compensation will be made.

INTERPRETATION OF QUANTITIES IN PROPOSAL FORM

The quantities appearing in the proposal form are approximate only and are to be used for establishing a contract amount. Payment to the Contractor will be made only for the actual quantities of the various items that are completed and accepted in accordance with the terms of the contract.

DRIVEWAYS AND PRIVATE PROPERTY

The Contractor shall maintain access to driveways for all residents and property owners throughout the life of the project. The Contractor shall not perform work for private citizens or agencies in conjunction with this project or within the project limits of this contract. Any driveway paved by a Contractor, which ties into a NCDOT system road being paved by the Contractor, must be paved either prior to the road paving project or after its completion.

Driveways shall be removed to a sufficient distance to provide for a smooth tie-in to future edge of pavement as directed by the Engineer. Driveways shall be saw cut. This work will be included in lump sum of grading.

TRAFFIC SIGNS & MAILBOXES

Permanent traffic signs and mailboxes that interfere with the road construction operations are to be removed during the course of a day's work, and be reinstalled at the conclusion of each work day. The Contractor shall mark the proper location of the signs and mailboxes by placing an offset stake behind the ditch line to ensure proper replacement.

DAMAGE TO EXISTING PAVEMENT, BASE, SUBGRADE, AND PROPOSED PAVEMENT

In addition to the requirements of the Standard Specifications concerning this subject, the Contractor is cautioned that he will be held responsible for all damages to the pavement, base, and subgrade caused by his operations, including but not limited to, rutting and shoving of the existing or proposed pavement and yielding or rutting of the existing base and subgrade.

The Contractor is cautioned to limit the weight of his equipment and the frequency of hauls so as to not damage the existing pavement, base, subgrade and the proposed pavement.

Any subgrade or base failures which the Contractor finds prior to the beginning of his operations or during the conditioning of the existing base are to be brought to the attention of the Engineer in writing. Repairs to those areas will be made by DOT forces. Once these deficient areas have been repaired, the requirements of this Special Provision will fully apply.

PLAN, DETAIL, AND QUANTITY ADJUSTMENTS

The Department reserves the right to make, at any time during the progress of the work, such alterations in plans or the details of construction as may be found necessary or desirable by the Engineer to complete the project.

POSTED WEIGHT LIMITS

The Contractor's attention is directed to the fact that many primary and secondary roads and bridges are posted with weight limits less than the legal limit. The Contractor will not be allowed to exceed the posted weight limits in transporting materials or equipment to the project. The Contractor should make a thorough examination of all maps and haul routes on this project.

SUBMITTALS

The Contractor shall submit an Erosion & Sediment Control Plan, Disposal Plan, Dewatering Plan and Borrow Material source within fourteen (14) calendar days prior to construction. All submittals shall be provided to the Engineer in written form.

MATERIALS AND TESTING

The Engineer reserves the right to perform all sampling and testing in accordance with Section 106 of the Standard Specifications and the Department's "Materials and Test Manual." However the Engineer may reduce the frequency of sampling and testing where he deems it appropriate for the project under construction.

The Contractor shall furnish the applicable certifications and documentation for all materials as required by the Standard Specifications. Material which is not properly certified will not be accepted.

Delivery tickets for all asphalt material shall be furnished in accordance with Section 106-7 of the Standard Specifications and shall include the following information:

1. NC DOT Work Order Number
2. Date
3. Time issued
4. Type of Material
5. Gross weight
6. Tare Weight
7. Net weight of material
8. Plant Location
9. Truck Number
10. Contractor's name
11. Public weigh master's stamp or number
12. Public weigh master's signature or initials in ink
13. Job mix formula number (if for asphalt plant mix)
14. Asphalt Plant Certification Number (if for asphalt plant mix)

SUBSURFACE INFORMATION

(7-1-95)

SP1 G112

There is **no** subsurface information available on this project. The Contractor shall make his own investigation of subsurface conditions.

PRECONSTRUCTION CONFERENCE

In accordance with Section 108-3 of the Standard Specifications, a preconstruction conference will be required prior to beginning work.

TRAFFIC CONTROL AND WORK ZONE SAFETY

Please note that Traffic Control (detours) will be provided by NCDOT. It is the responsibility of the contractor to inspect on-site barricades and to repair or notify the engineer if repairs need to be made. Furthermore, the contractor shall ensure that the work area is clearly barricaded at the end of each workday. The contractor must notify the Bridge Maintenance Engineer 2 weeks (14 calendar days) prior to beginning work so that NCDOT traffic services can fabricate and install the proper detour signs and barricades.

All personnel when working in traffic areas or areas in close proximity to traffic shall wear an approved safety vest, or shirt or jacket which meets the color requirements of the Manual of Uniform Traffic Control Devices (MUTCD).

The Contractor shall comply with all applicable Federal, State, and local laws, ordinances, and regulations governing safety, health, and sanitation, and shall provide all safeguards, safety devices, and protective equipment, and shall take

any other needed actions, on his own responsibility that are reasonably necessary to protect the life and health of employees on the job and the safety of the public, and to protect property in connection with the performance of the work covered by the contract.

Failure to comply with any of the requirements for safety and traffic control of this contract shall result in suspension of work as provided in sub article 108-7(2) of the Standard Specifications.

No direct payment shall be made for traffic control and work zone safety items, as they shall be considered incidental to other contract items.

PROJECT SPECIAL PROVISIONS

MOBILIZATION

Mobilization shall be compensated as allowed in accordance with Article 800-2 of the Standard Specifications.

Basis of payment for “Mobilization” shall be the contract unit price for lump sum.

SHOULDER AND FILL SLOPE MATERIAL

(5-21-02)

235, 560

SP2 R45 A

Description

Perform the required shoulder and slope construction for this project in accordance with the applicable requirements of Section 560 and Section 235 of the *2012 Standard Specifications*.

Measurement and Payment

Where the material has been obtained from an authorized stockpile or from a borrow source no direct payment will be made for this work, as the cost of this work will be part of the work being paid at the contract lump sum price for *Grading*.

It shall be in the best interest of the Contractor to utilize material generated for each site as a result of the work being performed.

No additional payment shall be made for Borrow Excavation for this task, as this item shall be considered incidental to the lump sum price for *Grading*.

COMPREHENSIVE GRADING

The Contractor is to grade this project to the typical sections and details shown. Grading shall be comprehensive grading as defined in Section 226 of the Standard Specifications, and shall include excavation for removal of existing pipes and end walls; excavation for the new end wall and pipe construction; compacting roadway embankment section in conformance with Section 235 of the Standard Specifications, and grading / reshaping of shoulders and ditches.

No earth material may be wasted or removed from the project unless deemed as unsuitable by the Engineer. Material may be stored on the existing roadway provided that adequate clearance is allowed.

The Contractor shall shape, compact, and grade the embankment, ditches, and shoulders to the lines, grades, and typical sections established by the plans or as directed by the Engineer. The contractor is advised to make a detailed investigation of the original state of such features prior to commencing operations.

The contractor may utilize whatever methods deemed most efficient for the project provided that the work methods comply with all applicable Federal, State, and local laws, ordinances, and regulations governing safety, health, and sanitation and that the contractor will maintain slopes of 1.5:1 or flatter in the course of excavating the existing embankment. The contractor shall provide all safeguards, safety devices, and protective equipment, and shall take any

other needed actions, on his own responsibility that are reasonably necessary to protect property in connection with the performance of the work covered by the contract.

Basis of payment for “Grading” shall be the contract unit price for lump sum.

STOCKPILE AREAS

The Contractor shall install and maintain erosion control devices sufficient to contain sediment around any erodible material stockpile areas as directed by the Engineer. Stockpile areas shall remain within existing NCDOT Right-of-Way.

BORROW

The work covered by this item consists of the furnishing and excavation of an approved material from a contractor supplied location for use as a backfill material. Payment will be on cubic yard basis by truck measurement. The quantity of borrow excavation to be paid will be the actual number of cubic yards of approved material, measured in trucks, which has been excavated from the borrow source and incorporated into the completed and accepted work. The recorded capacity of any truck used to transport the material will be adjusted by making a 25% deduction to allow for shrinkage and the adjusted capacity will be the quantity paid for. Contractor furnished borrow and waste sites shall comply with section 230 of the Standard Specifications. **A copy of the borrow source permit shall be provided to the inspector prior to hauling any materials.**

Basis of payment for "Borrow Excavation" shall be the unit bid price per cubic yard.

AGGREGATE BASE COURSE

The Contractor shall furnish and place aggregate base course in accordance with the provisions of Section 520 of the Standard Specifications. The base shall be compacted to a density equal to that obtained by compacting a sample of the material in accordance with AASHTO T180 as modified by the Department. The Contractor shall dry or add moisture to the material when required to provide a uniformly compacted and acceptable base. When completed, the base course shall be smooth, hard, dense, unyielding, and well bonded.

The Aggregate Base Course shall be placed, within the roadway section over the arch pipe, on top of the backfill material to the top of the subgrade of the roadway at an approximate depth of twelve (12) inches. The aggregate base course shall extend one (1) foot beyond the existing roadway width on each side.

Payment will be made under the item "Aggregate Base Course" and shall include, but not be limited to, furnishing aggregate and water, mixing, hauling, spreading materials, compacting, shaping, and maintaining the base course.

Basis of payment for "Aggregate Base Course" shall be the unit bid price per ton.

#57 STONE / BACKFILL

7-18-06

SPI0 -1

Description

The Contractor shall place #57 stone in accordance with the details within the details of the proposal and the following provision. Backfill material shall be #57 stone placed one (1) foot below the pipe invert to approximately two (2) foot above the top of the pipe. An NCDOT approved soil engineering fabric shall be required on top of the #57 stone prior to placing the Aggregate Base Course. The contractor shall thoroughly and carefully backfill the pipe in accordance with plans.

Materials

Item	Section
# 57 Stone	1005

Construction Methods

The stone shall be placed and compacted as directed by the Engineer.

Measurement and Payment

#57 Stone will be measured and paid in tons that are completed and accepted. The stone will be measured by being weighed in trucks on certified platform scales or other certified weighing devices. The price and payment will be full compensation for furnishing, hauling, placing, and all incidentals necessary to complete the work.

Payment will be made under:

Pay Item	Pay Unit
#57 Stone	Ton

PIPE REMOVAL

All existing corrugated metal pipe and associated headwalls shall be removed. All pipe removal will be considered waste material. It shall be the responsibility of the Contractor to dispose of waste to an approved construction landfill site or other waste disposal site provided by the contractor. **A copy of the waste site permit shall be provided to the inspector prior to hauling off any materials.**

Payment will be for all labor, material, equipment, removing, hauling, and disposal of removed pipe

Basis of payment for "Pipe Removal" shall be the contract unit bid price per linear foot.

PAVING

The production, delivery, placement, and compaction of all bituminous material shall be in accordance with Section 610 of the Standard Specifications. A currently approved North Carolina Department of Transportation job mix formula shall be used for all bituminous construction.

The air temperature 48 continuous hours prior to paving must be above 32 degrees Fahrenheit. Air temperature at the time of paving shall be in accordance with Subarticle 610-4 of the Standard Specifications.

The Contractor shall compact the bituminous material on this project in accordance with Subarticle 610-9 of the Standard Specifications and the following provision:

Compact all final wearing surfaces using a minimum of two (2) steel wheel rollers, unless otherwise approved. Pneumatic-tired rollers with 2 tandem axles and smooth tread tires may be used for intermediate rolling

Pavement shall not be placed until the base has been approved by the Engineer or his representative. A North Carolina Department of Transportation inspector shall be present during the placement of bituminous material.

The Contractor shall use a string line or other approved method to establish a uniform consistent line to locate the edge of pavement. It shall be the Contractor's responsibility to place such line, but it shall meet the approval of the Engineer or his representative.

A smooth joint shall be provided at paved driveways. The Contractor shall exercise caution when operating equipment at paved residential drives in order to avoid pavement damage. An apron or turnout will be required at unpaved driveways.

The open cut shall require full depth patching with three (3) inches of Asphalt Concrete Intermediate Course, Type I19.0B, and an overlay of one and one-half (1.5) inches of Asphalt Concrete Surface Course, Type SF9.5A. The surface course shall extend one hundred (100) feet beyond the open cut on both sides not to exceed a total length of two-hundred fifty (250) feet.

Basis of payment for "Paving" will be the contract unit price for Asphalt Concrete Intermediate Course, Type I19.0B and Asphalt Concrete Surface Course, Type SF9.5A per ton.

ASPHALT BINDER FOR PLANT MIX

The work covered by this section shall be in accordance with Section 620 of the Standard Specifications, including but not limited to furnishing of asphalt binder, with anti-strip additive when required, at an asphalt plant and incorporating the asphalt binder and anti-strip additive into the asphalt plant mix.

Asphalt Binder for Plant Mix, Grade PG 64-22, will be measured and paid for as the theoretical number of tons of the grade of asphalt binder required by the applicable job mix formula based on the actual number of tons of plant mix completed and accepted on the job. Such price and payment will be full compensation for all work covered by this section. There will be no direct payment for anti-strip additive.

Adjustments will be made to the payments due the Contractor for each grade of asphalt binder when it has been determined that the monthly average terminal F.O.B. Selling Price of asphalt binder, Grade PG 64-22, has fluctuated from the Base Price Index for Asphalt Binder included in the contract. The methods for calculating a base price index, for calculating the monthly average terminal F.O.B. selling price and for determining the terminals used are in accordance with procedures on file with the Department's Construction Unit. The Base Price Index for this contract will be the **May 1, 2015 Average at \$483.08 per ton.**

When it is determined that the monthly selling price of asphalt binder on the first business day of the calendar month during that the last day of the partial payment period occurs varies either upward or downward from the base price index, the contract unit price for asphalt binder for plant mix will be adjusted. The adjusted contract unit price will be determined by adding the difference between the selling price and the base price index to the contract unit bid price for asphalt binder. If the selling price is less than the base price index, the adjusted contract unit price will be determined by subtracting the difference between the selling price and the base price index from the contract unit price for asphalt binder. The adjusted contract unit price will then be applied to the total theoretical quantity of asphalt binder authorized for use in the plant mix placed during the partial payment period involved, including both additional new asphalt binder and salvaged asphalt binder from reclaimed asphalt materials required by the job mix formula.

Adjusted contract unit prices for all grades of asphalt binder, including additional asphalt binder materials in recycled mixtures, will be based on the average selling price and base price index for asphalt binder, Grade PG 64-22, regardless of the actual grade required by the job mix formula.

In determining the adjusted contract unit price for any material specified in this provision the following formula will be used:

$$A = B + (D - C)$$

Where A = Adjusted Contract Unit Price
B = Contract Unit Price
C = Base Price Index
D = Monthly Average Terminal F.O.B. Selling Price

In the event the Department is unable to secure an F.O.B. selling price from at least four terminals in a given month, payment will be at the contract unit price for each ton of asphalt binder used in the work during that month.

Basis of payment for "Asphalt Binder" will be the contract unit price per ton.

CONTRACTOR SUPPLIED PIPE AND HEADWALL (ASSEMBLE AND INSTALL)

Purchasing, assembling and placing the new structure will be the responsibility of the contractor. The manufacturer's representative, with at least two (2) years of experience in the installation of this type of structure, will be required to be onsite during assembly, placement and backfilling of the structure. The Contractor's responsibility shall be to excavate the streambed for placement of the toe wall of both headwalls.

The pipe is required to be buried one foot below the streambed, unless specified otherwise. The Department will provide invert pipe elevations (see "Pipe Information"). The contractor will then be responsible for backfilling in accordance with the NCDOT Standard Specifications, and as directed by the Engineer. Backfill material shall be #57 stone from one (1) foot below the pipe invert to two foot above the top and beyond the sides of the pipe. **All #57 stone backfill materials shall be encapsulated with engineering fabric (Foundation Conditioning Geotextile). Provide engineering fabric meeting the requirements of Article 1056-2 of the Standard Specifications for any type of engineering fabric.** In

addition to the engineering fabric the Contractor will be required to place one layer of geogrid (TX160 or equivalent) approximately 6" above and below the structure from headwall to headwall. All engineering fabric and geogrid will be considered incidental to "Pipe and Headwall (include assemble and install Contractor supplied pipe)" line items.

The Contractor shall thoroughly and carefully backfill the pipe in accordance with the pipe assembly plans. Backfilled areas shall be graded and maintained in such a condition that erosion or saturation will not erode or damage the pipe foundation or backfill. Heavy equipment shall not be operated over the pipe until it has been properly backfilled and minimum cover as shown on the plans or as approved by the Engineer has been placed over the pipe.

All material shall be inspected and approved by the Engineer after delivery to the project and prior to installation.

Basis of payment for "Pipe and Headwall (Assemble and Install Contractor Supplied Pipe)" will be the contract unit price per each.

DEWATERING

All sites shall require dewatering. The preferred method for dewatering will be bypass pumping. Materials used in impervious dikes include but are not limited to steel sheet piles, Aqua Barriers, etc. This will include all material, labor and equipment needed to satisfy the OSHA safety standards and also to satisfy the guidelines of the attached environmental permits. A copy of the environmental permits shall be onsite during construction activities. Any violation of the permits could result in fines. The Contractor's work shall be halted if the turbidity reaches in excess of 50 NTU's. The Contractor shall not resume work until corrections are made.

Included in this contract is a typical section for bypass pumping. The guidelines to be used for this activity can be found in the Best Management Practices for Construction and Maintenance Activities which are available as a down load on our web site. The link can be found at http://www.ncdot.org/doh/operations/BMP_manual/.

The Contractor shall furnish an Erosion Control Plan for each site, prior to beginning any work, for approval by our Roadside Environmental Specialist. The plan shall include the Level III Certification number of the designer.

Basis of payment for "Dewatering" will be the contract unit price for lump sum.

UTILITY RELOCATIONS

It shall be the responsibility of the Contractor to contact all affected utility owners and determine the precise locations of all utilities prior to beginning construction. Utility owners shall be contacted a minimum of 72 hours prior to the commencement of operations. Special care shall be used in working around or near existing utilities, protecting them when necessary to provide uninterrupted service. In the event that any utility service is interrupted, the Contractor shall notify the utility owner immediately and shall cooperate with the owner, or his representative, in the restoration of service in the shortest time possible. Existing fire hydrants shall be kept accessible to fire departments at all times.

Compensation for the "Utility Relocation" Line Item will be based on when the contractor is required to compensate the utility owner for relocation expenses due to existing encroachment agreements. All utility coordination (relocating phone, television, etc.) will be considered incidental to the contract.

The Contractor shall make a reasonable effort to prevent utility relocations. The Engineer shall be notified for approval prior to any utility relocation. The Utility Relocation Line Item will be paid per each utility (i.e., water, sewer, gas, etc.) relocated at each site.

Basis of payment for "Utility Relocations" will be the contract unit price per each.

TEMPORARY SILT FENCE

Temporary silt fence for erosion control shall be installed as directed by the Engineer. Temporary silt fence shall be installed in accordance with Section 1605 of the Standard Specifications.

Payment of this item will be to furnish all materials including posts, wire, fabrics and fasteners; and to construct, maintain, and remove temporary silt fence.

Basis of payment for “Temporary Silt Fence” shall be the contract unit bid price per linear foot.

EROSION CONTROL STONE

The work covered under this section shall be in accordance with Division 8 and Division 16 of the Standard Specifications and the following provision(s):

The work includes but is not limited to furnishing, weighing, stock piling, placing and maintaining stone; and disposal of any stone not incorporated into the project when necessary.

Stone shall be used as slope protection, or as directed by the Engineer.

The type of stone to be used shall be "Stone for Erosion Control, Class B" unless otherwise directed by the Engineer.

Basis of payment for “Stone for Erosion Control, Class B” shall be the contract unit bid price per ton.

WATTLES

Wattles are tubular products consisting of excelsior fibers encased in synthetic netting. Wattles are used on slopes or channels to intercept runoff and act as a velocity break. Wattles are to be placed at locations shown on the plans or as directed. Installation shall follow the detail provided in the plans and as directed. Work includes furnishing materials, installation of wattles, matting installation, PAM application, and removing wattles.

Materials

Wattle shall meet the following specifications:

100% Curled Wood(Excelsior) Fibers	
Minimum Diameter	12 in.
Minimum Density	2.5 lb/ft ³ +/- 10%
Net Material	Synthetic
Net Openings	1 in. x 1 in.
Net Configuration	Totally Encased
Minimum Weight	20 lb. +/- 10% per 10 ft. length

Anchors: Stakes shall be used as anchors.

Wooden Stakes:

Provide hardwood stakes a minimum of 2-ft. long with a 2 in. x 2 in. nominal square cross section. One end of the stake must be sharpened or beveled to facilitate driving down into the underlying soil.

Matting shall meet the requirements of section 1060-8 of the *Standard Specifications*, or shall meet specifications provided elsewhere in this contract.

Provide staples made of 0.125" diameter new steel wire formed into a *u* shape not less than 12" in length with a throat of 1" in width.

Construction Methods

Wattles shall be secured to the soil by wire staples approximately every 1 linear foot and at the end of each section of wattle. A minimum of 4 stakes shall be installed on the downstream side of the wattle with a maximum spacing of 2 linear feet along the wattle, and according to the detail. Install a minimum of 2 stakes on the upstream side of the wattle according to the detail provided in the plans. Stakes shall be driven into the ground a minimum of 10 in. with no more than 2 in. projecting from the top of the wattle. Drive stakes at an angle according to the detail provided in the plans.

Only install wattle(s) to a height in ditch so flow will not wash around wattle and scour ditch slopes and according to the detail provided in the plans and as directed. Overlap adjoining sections of wattles a minimum of 6 in.

Installation of matting shall be in accordance with the detail provided in the plans, and in accordance with section 1631-3(B) of the *Standard Specifications*, or in accordance with specifications provided elsewhere in this contract.

The Contractor shall maintain the wattles until the project is accepted or until the wattles are removed, and shall remove and dispose of silt accumulations at the wattles when so directed in accordance with the requirements of Section 1630 of the *Standard Specifications*.

Measurement and Payment

Wattles will be measured and paid for by the actual number of linear feet of wattles which are installed and accepted. Such price and payment will be full compensation for all work covered by this section, including, but not limited to, furnishing all materials, labor, equipment and incidentals necessary to install the *Wattles*.

Matting will be measured and paid for in accordance with section 1631-4 of the *Standard Specifications*, or in accordance with specifications provided elsewhere in this contract.

Basis of payment for “Wattle” will be the contract unit price per linear foot.

Basis of payment for “Matting” will be the contract unit price per square yard.

STABILIZATION REQUIREMENTS

(11-4-11)

S-2

Stabilization for this project shall comply with the time frame guidelines as specified by the NCG-010000 general construction permit effective August 3, 2011 issued by the North Carolina Department of Environment and Natural Resources Division of Water Quality. Temporary or permanent ground cover stabilization shall occur within 7 calendar days from the last land-disturbing activity, with the following exceptions in which temporary or permanent ground cover shall be provided in 14 calendar days from the last land-disturbing activity:

- Slopes between 2:1 and 3:1, with a slope length of 10 ft. or less
- Slopes 3:1 or flatter, with a slope of length of 50 ft. or less
- Slopes 4:1 or flatter

The stabilization timeframe for High Quality Water (HQW) Zones shall be 7 calendar days with no exceptions for slope grades or lengths. High Quality Water Zones (HQW) Zones are defined by North Carolina Administrative Code 15A NCAC 04A.0105 (25). Temporary and permanent ground cover stabilization shall be achieved in accordance with the provisions in this contract and as directed.

SEEDING AND MULCHING

All disturbed areas shall be dressed in typical sections and plowed to a depth of five (5) inches. The top two (2) inches shall be pulverized to provide a uniform seedbed. Lime should be applied before plowing operation.

Lime, seed and fertilizer shall be applied with the necessary equipment to give uniform distribution of these materials. The hand/bucket method is not acceptable.

All areas to be seeded and mulched shall be approved by the Engineer prior to preparing the seedbed. Work shall be in accordance with Section 1660 of the *Standard Specifications*. The following rates per acre shall apply:

March 1 – August 31			September 1 – February 28		
Tall Fescue	50	pounds	Tall Fescue	50	pounds
Centipede	10	pounds	Centipede	10	pounds
Bermuda grass (hulled)	25	pounds	Bermuda grass (unhulled)	35	pounds
Fertilizer10-20-20	500	pounds	Fertilizer10-20-20	500	pounds
Limestone	4000	pounds	Limestone	4000	pounds

Notes:

1. Fifty (50) pounds of Bahiagrass may be substituted for either Centipede or Bermudagrass, but only with Engineer's approval.
2. On cut and fill slopes 2:1 or steeper, Centipede shall be applied at the rate of 5 pounds per acre and add 20 pounds of Sericea Lespedeza from January 1 – December 31.

The seeded area shall be cultipacked to provide a firm seedbed and cover seed. Grain straw shall be applied over seeded areas as mulch. No bare ground shall be visible when riding by a mulched area if proper application is achieved. Thick clumps of straw are not permissible as a uniform coverage is expected. Hydroseeding, however, will be considered an acceptable means of seeding, however the hydromulch can be used as a tack but not as a mulch. **Seeding shall be done as work progresses. All disturbed areas shall be seeded in accordance with the Stabilization Requirements as mentioned above, unless otherwise directed by the Engineer. All work shall be accepted and approved by the Engineer prior to beginning construction at the next site.**

CRIMPING STRAW MULCH

Crimping shall be required on this project adjacent to any section of roadway where traffic is to be maintained or allowed during construction. In areas within six feet of the edge of pavement, straw is to be applied and then crimped. After the crimping operation is complete, an additional application of straw shall be applied and immediately tacked with a sufficient amount of undiluted emulsified asphalt.

Straw mulch shall be of sufficient length and quality to withstand the crimping operation.

Crimping equipment including power source shall be subject to the approval of the Engineer providing that maximum spacing of crimper blades shall not exceed 8".

Basis of payment for "Seeding and Mulching" will be the contract unit price per acre.

CRANE SAFETY

(8-15-05)

Comply with the manufacturer specifications and limitations applicable to the operation of any and all cranes and derricks. Prime contractors, sub-contractors, and fully operated rental companies shall comply with the current Occupational Safety and Health Administration regulations (OSHA).

Submit all items listed below to the Engineer prior to beginning crane operations involving critical lifts. A critical lift is defined as any lift that exceeds 75 percent of the manufacturer's crane chart capacity for the radius at which the load will be lifted or requires the use of more than one crane. Changes in personnel or equipment must be reported to the Engineer and all applicable items listed below must be updated and submitted prior to continuing with crane operations.

Crane Safety Submittal List

Competent Person: Provide the name and qualifications of the "Competent Person" responsible for crane safety and lifting operations. The named competent person will have the responsibility and authority to stop any work activity due to safety concerns.

Riggers: Provide the qualifications and experience of the persons responsible for rigging operations. Qualifications and experience should include, but not be limited to, weight calculations, center of gravity determinations, selection and inspection of sling and rigging equipment, and safe rigging practices.

Crane Inspections: Inspection records for all cranes shall be current and readily accessible for review upon request.

Certifications: By July 1, 2006, crane operators performing critical lifts shall be certified by NC CCO (National Commission for the Certification of Crane Operators), or satisfactorily complete the Carolinas AGC's Professional Crane Operator's Proficiency Program. Other approved nationally accredited programs will be considered upon request. All crane operators shall also have a current CDL medical card. Submit a list of anticipated critical lifts and corresponding crane operator(s). Include current certification for the type of crane operated (small hydraulic, large hydraulic, small lattice, large lattice) and medical evaluations for each operator.

GENERAL ALUMINUM STRUCTURE REQUIREMENTS

All items are incidental to **Pipe and Headwalls (Assemble and Install)**

1. ALL MATERIALS SHALL MEET THE REQUIREMENTS OF THE NORTH CAROLINA DEPARTMENT OF TRANSPORTATION STANDARD SPECIFICATIONS FOR ROADS AND STRUCTURES, LATEST EDITION.
2. Pipe material shall either be made of aluminum alloy and in dimensions per the standard specifications and hydraulic recommendations.
3. Poor quality of workmanship of any materials supplied will constitute grounds for the structure being rejected.
4. Manufacturer's representative, with at least two (2) years of experience in the installation of the type of structure, is required to provide technical assistance with the assembly of structure and headwalls as well as being on site during the installation and backfilling of pipe with headwalls through completion.
5. Detailed shop drawings and design calculations shall be submitted for acceptance. The supplier shall provide a design that meets the requirements of AASHTO and is sealed by a NC registered Professional Engineer.
6. Headwall locations shall be at or beyond the shoulder point.
7. Headwalls will be required on the inlet and outlet of all pipes.
8. All headwalls shall be parallel to the roadway.
9. Bottom of headwall elevation shall be 1' below invert.
10. Headwall invert elevations shall be 1' below streambed.
11. Headwall foundation shall be undercut and backfilled with #57 stone 1' below bottom of headwall elevation.
12. An NCDOT approved soil engineering fabric shall be required on top of the #57 stone prior to backfilling of the roadbed.
13. Pipe is to be fully welded inside and out to headwalls using two root welds and two finish welds on either side of the wall. All finish welds are to be ground to a smooth finish.
14. Headwall and pipe are to be reinforced per AASHTO specifications and structural engineer's requirements.
15. All hardware including nuts, bolts, washers, rods, etc. shall be hot dipped galvanized.
16. A 2' wide band and a continuous 3/8" thick x 2' wide flat gasket made of closed cell neoprene rubber which upon assembly provides a watertight seal at each joint will be required.
17. All holes or tears in the pipe must be repaired prior to backfilling.
18. Pipe bed will be undercut and backfilled with #57 stone 1' below pipe invert elevations.
19. Backfill material shall be #57 stone from 2' below streambed elevation to 2' above the top and sides.
20. SUPPLIER TO INCLUDE ALL NECESSARY WALE BEAMS, HEADWALL CAP, CONTINUOUS FLAT GASKETS AND GALVANIZED STEEL TIEBACK RODS WITH DMA PLATES AND ADJUSTABLE HOT DIP GALVANIZED TURNBUCKLES.
21. Material Quality and Workmanship
22. Pipe sections and bands shall be assembled and alphanumerically / alignment match-marked at the plant site before shipping to verify fit.

23. Bands shall be installed onto the pipe sections prior to shipping.
24. Pipe manufacturer must provide certification of the measured dimensions of the pipe, bands and the continuous flat gaskets. Certification must state that the bands and the gaskets have been pre-fitted and will securely tighten around the supplied pipe. Certification of the dimensions must be signed by the manufacturer's representative and dated.
- i. EXAMPLE: Supplied pipe measures ____ inches in diameter. Supplied bands and the continuous flat gaskets measure ____ inches in length and will securely fasten pipe sections, without field modification.
 - ii. Signature _____
 - iii. Date: _____
25. Poor quality of workmanship of any materials supplied will constitute grounds for the material being rejected.

SUMMARY OF QUANTITIES

SUMMARY OF QUANTITIES				
Route	SR 2214	SR 2422	SR 2454	TOTALS
	QUANTITY	QUANTITY	QUANTITY	QUANTITY
Mobilization (LS)	0.30	0.30	0.40	1
Comprehensive Grading (LS)	0.30	0.30	0.40	1
Borrow (CY)	50	50	50	150
#57 Stone / Backfill	884	908	1981	3773
Pipe Removal (LFT)	90	96	92	278
Aggregate Base Course (TONS)	93	93	123	309
ACIC, Type I 19.0B (TONS)	25	25	35	85
ACSC, Type SF9.5A (TONS)	55	55	60	170
Asphalt Binder, Grade PG 64-22	5	5	6	16
2 @ 112"x75" Corrugated Aluminum Arch Pipe with Headwalls (EA)	1	0	0	1
2 @ 95"x67"x44' Corrugated Aluminum Arch Pipe with Headwalls (EA)	0	1	0	1
2 @ 95"x67"x50' Corrugated Aluminum Arch Pipe with Headwalls (EA)	0	0	1	1
Geotextile (SY)	582	587	781	1950
Dewatering (EA)	1	1	1	3
Utility Relocation (EA)	1	1	1	3
Temporary Silt Fence (LFT)	100	100	100	300
Stone for Erosion Control - Class B (TONS)	150	150	250	550
Matting for Erosion Control (SY)	50	50	50	150
Wattle (LFT)	48	48	48	144
Seeding and Mulching (ACR)	0.5	0.5	0.5	1.5

BYPASS PUMPING

**MANAGING THE WATERCOURSE:
BYPASS PUMPING**

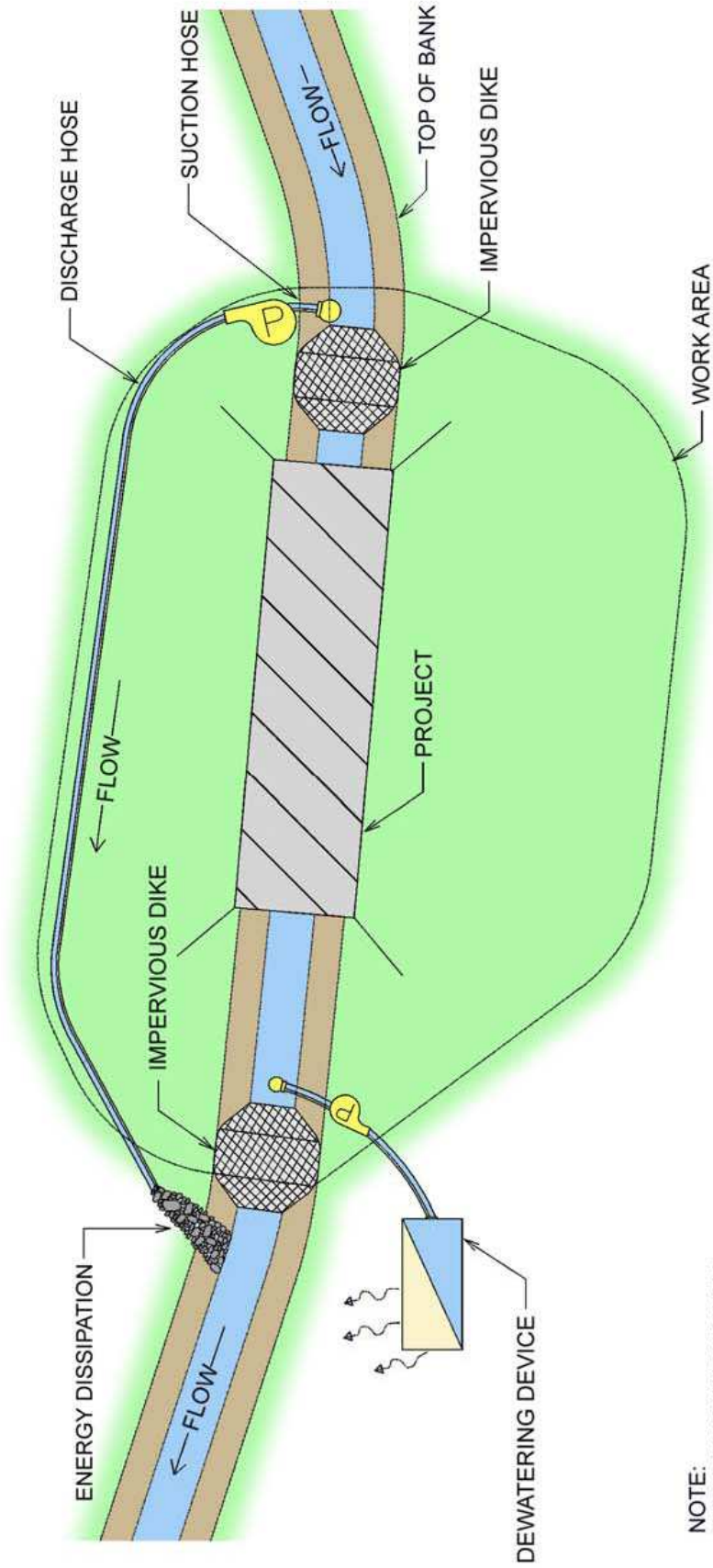

NOTE:
ENSURE TO ANCHOR ALL
PUMPS AND PIPES SECURELY.

TEMPORARY SILT FENCE DETAIL

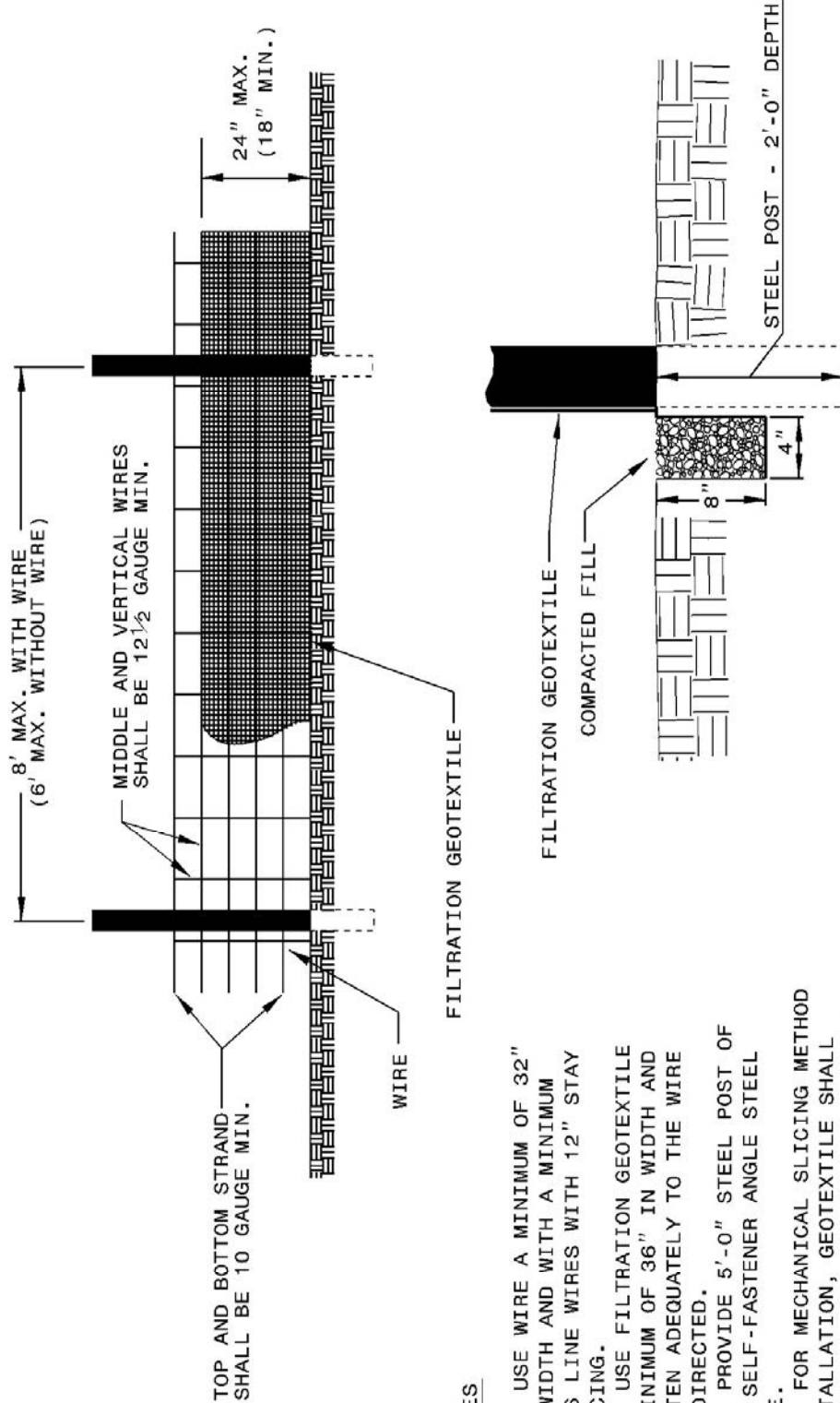

NOTES

- USE WIRE A MINIMUM OF 32" IN WIDTH AND WITH A MINIMUM OF 6 LINE WIRES WITH 12" STAY SPACING.
- USE FILTRATION GEOTEXTILE A MINIMUM OF 36" IN WIDTH AND FASTEN ADEQUATELY TO THE WIRE AS DIRECTED.
- PROVIDE 5'-0" STEEL POST OF THE SELF-FASTENER ANGLE STEEL TYPE.
- FOR MECHANICAL SLICING METHOD INSTALLATION, GEOTEXTILE SHALL BE A MAXIMUM OF 18" ABOVE GROUND SURFACE.

STATE OF NORTH CAROLINA
DEPT. OF TRANSPORTATION
DIVISION OF HIGHWAYS
RALEIGH, N.C.

1-12

ENGLISH STANDARD DRAWING FOR
TEMPORARY SILT FENCE

SHEET 1 OF 1
1605.01

WATTLE DETAIL

WATTLE DETAIL

PROJECT REFERENCE NO.	SHEET NO.
PROJECT NO.	DATE
FORWARD ORDER NUMBER	PRODUCED BY
	ENGINEER

NOTES:

- USE MINIMUM 12 IN. DIAMETER EXCELSTOR WATTLE.
- USE 2 FT. WOODEN STAKES WITH A 2 IN. BY 2 IN. NOMINAL CROSS SECTION.
- ONLY INSTALL WATTLE(S) TO A HEIGHT IN DITCH SO FLOW WILL NOT WASH AROUND WATTLE AND SCOUR DITCH SLOPES AND AS DIRECTED.
- INSTALL A MINIMUM OF 2 UPSLOPE STAKES AND 4 DOWNSLOPE STAKES AT AN ANGLE TO WEDGE WATTLE TO BOTTOM OF DITCH.
- PROVIDE STAPLES MADE OF 0.125 IN. DIAMETER STEEL WIRE FORMED INTO A U SHAPE NOT LESS THAN 12" IN LENGTH.
- INSTALL STAPLES APPROXIMATELY EVERY 1 LINEAR FOOT ON BOTH SIDES OF WATTLE AND AT EACH END TO SECURE IT TO THE SOIL.
- INSTALL MATTING IN ACCORDANCE WITH SECTION 1631 OF THE STANDARD SPECIFICATIONS.

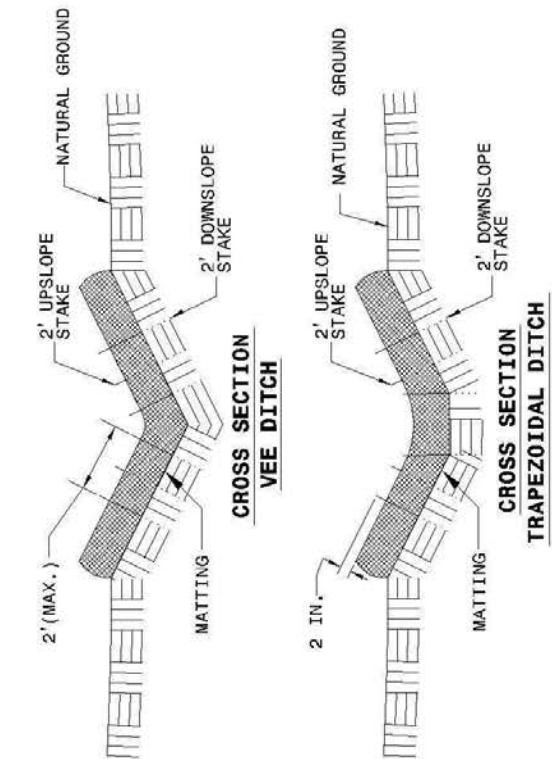
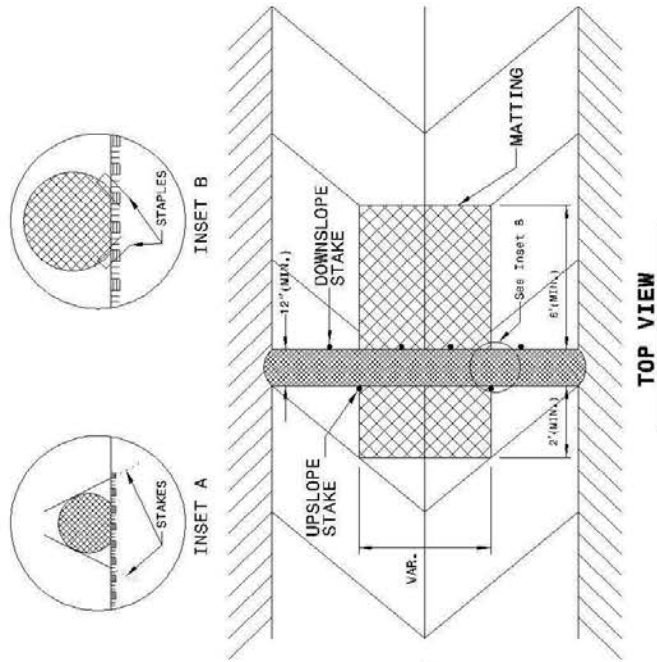
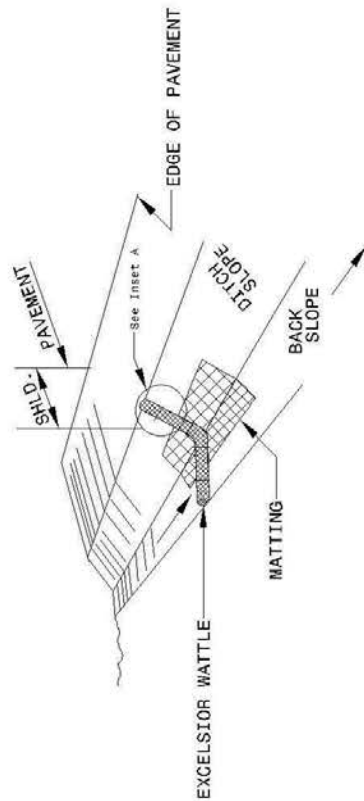

VICINITY MAP

Robeson County

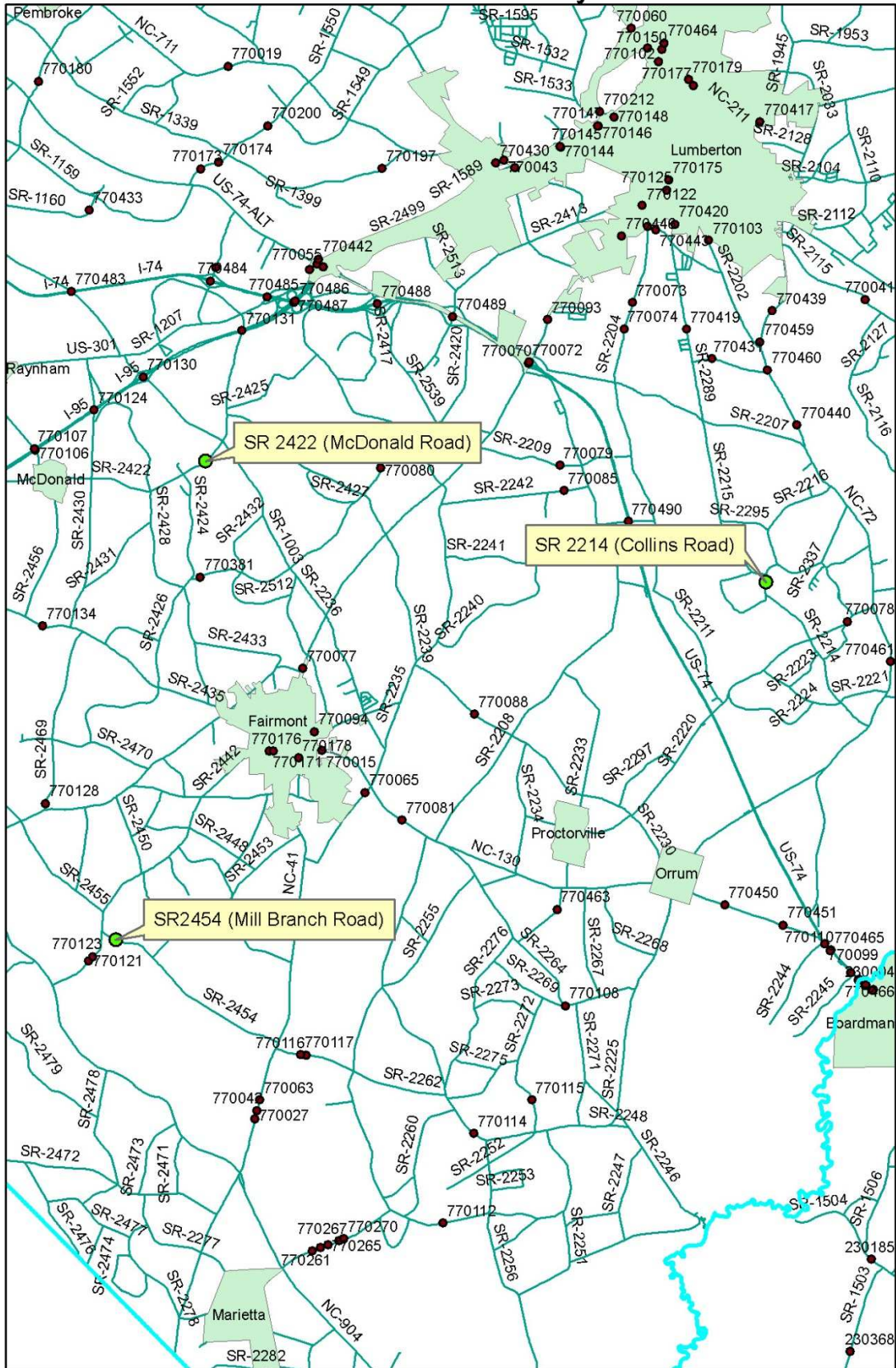

DRAWINGS

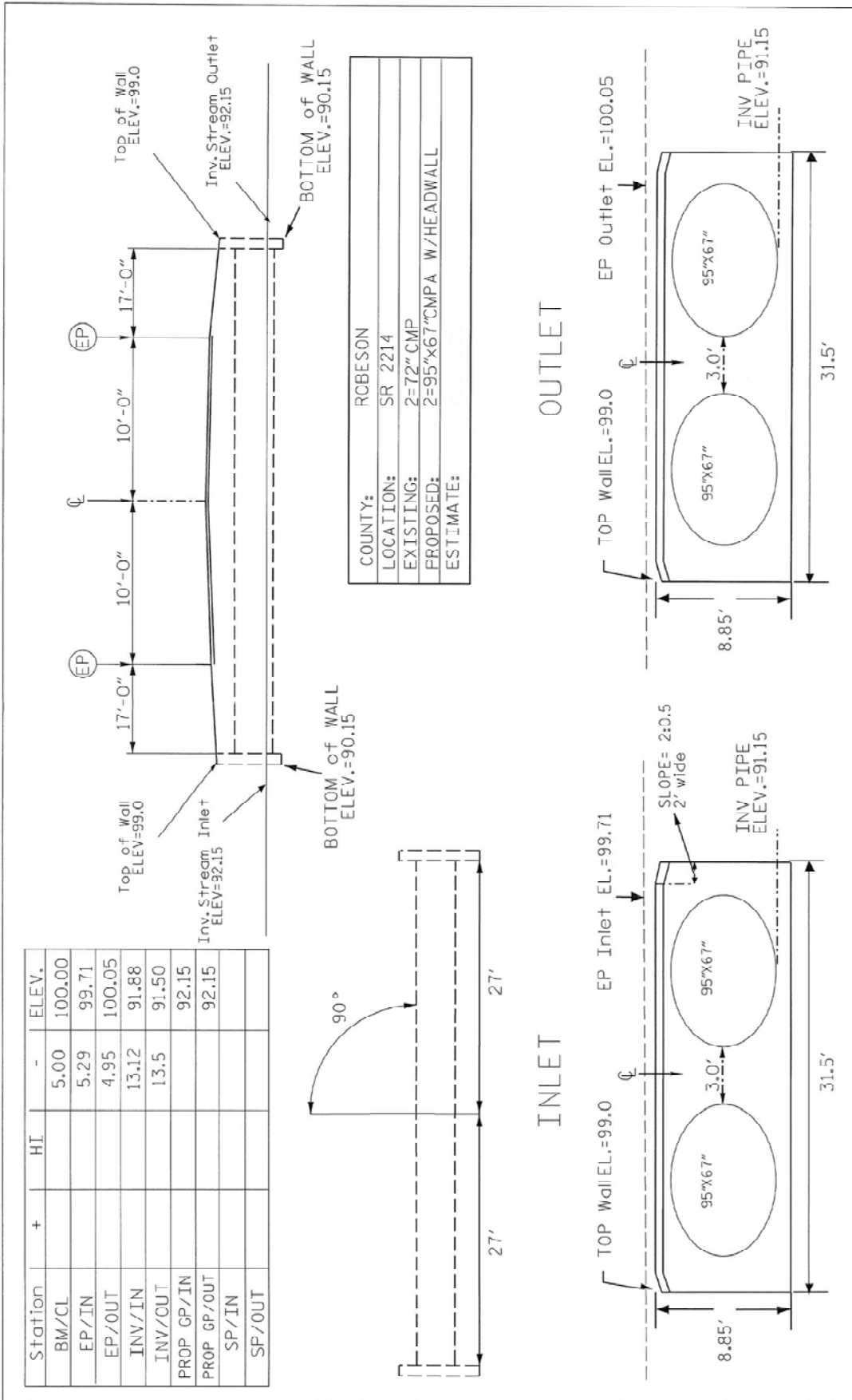

Station	+	HI	-	ELEV.
BM/CL			0.8	100.00
EP/IN			0.9	99.9
EP/OUT			1.1	99.7
INV/IN			8.14	92.7
INV/OUT			8.60	92.2
PROP GP/IN				
PROP GP/OUT				
SP/IN				
SP/OUT				

*All Elevations subject to corrugation of Pipe

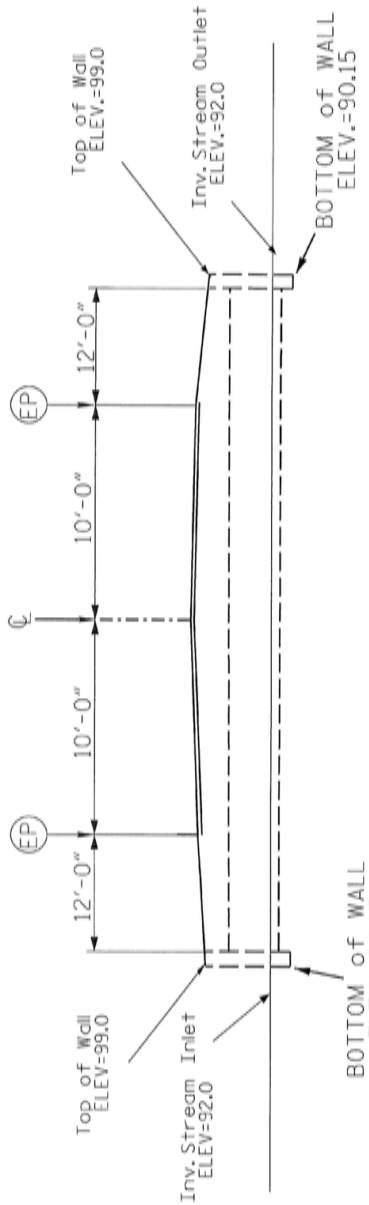

COUNTY:	ROBESON
LOCATION:	SR 2422
EXISTING:	2=72" CMP
PROPOSED:	2=95"x67" CMPA W/HEADWALL
ESTIMATE:	

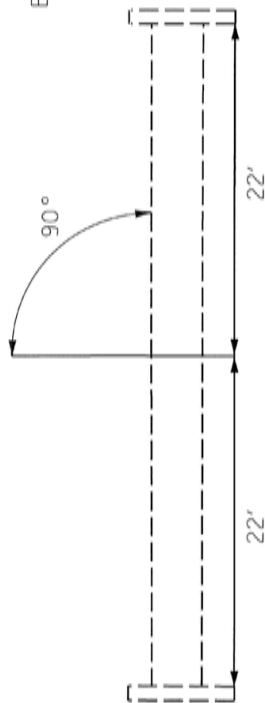

INLET

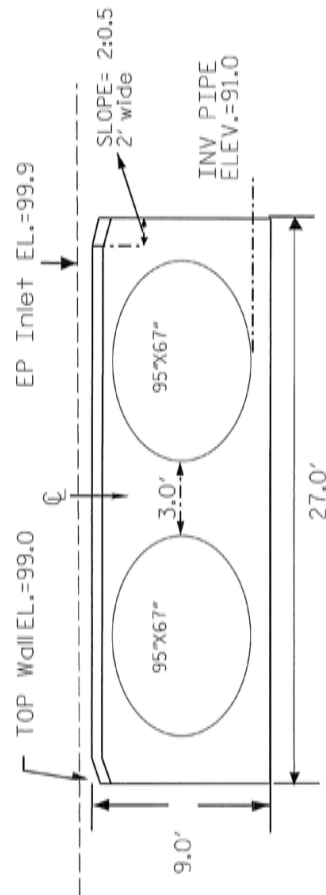

OUTLET

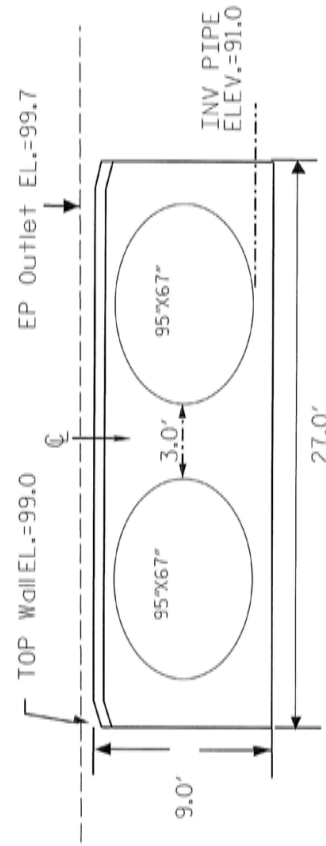

Station	+	HI	-	ELEV.
BM/CL			4.50	100.0
EP/IN			4.64	99.86
EP/OUT			4.66	99.84
INV/IN			13.44	91.06
INV/OUT			13.74	90.76
PROP GP/IN				
PROP GP/OUT				
SP/IN				
SP/OUT				

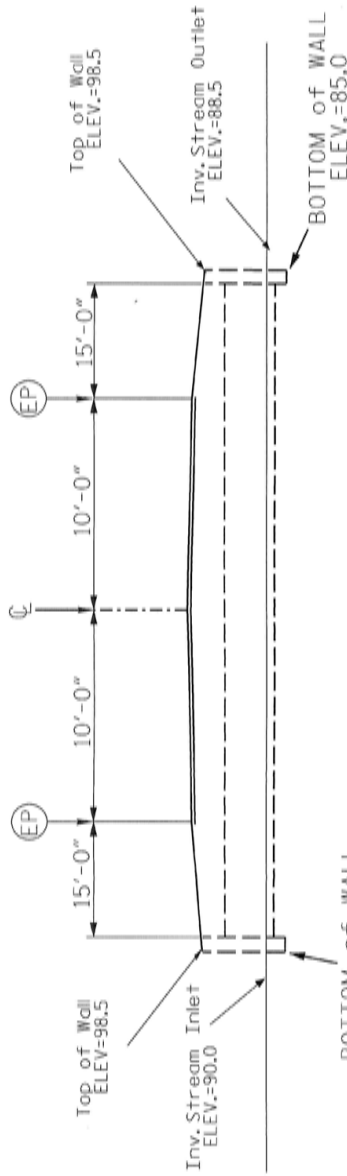

COUNTY:	ROBESON
LOCATION:	SR 2454
EXISTING:	2-72" CMP
PROPOSED:	2-112"x75" CMPA W/HEADWALL
WBS:	TBA

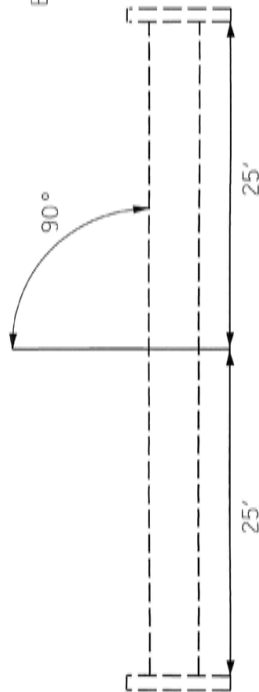

INLET

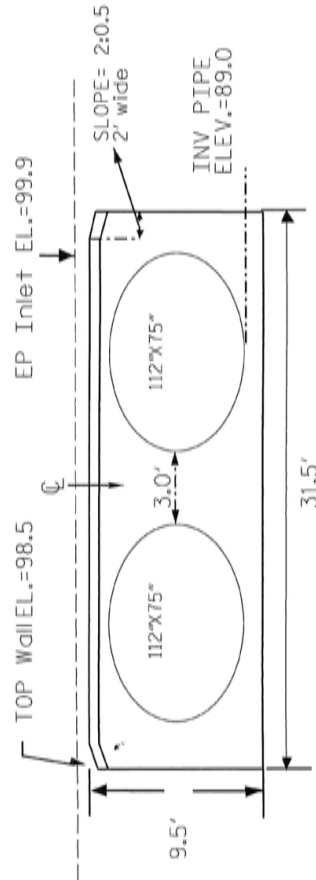

OUTLET

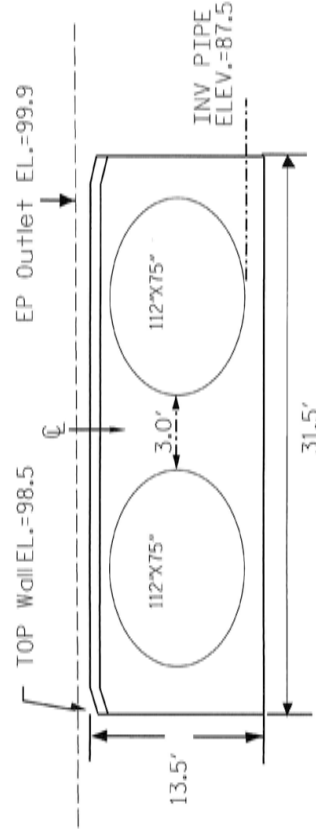

TYPICAL BACKFILL SECTION

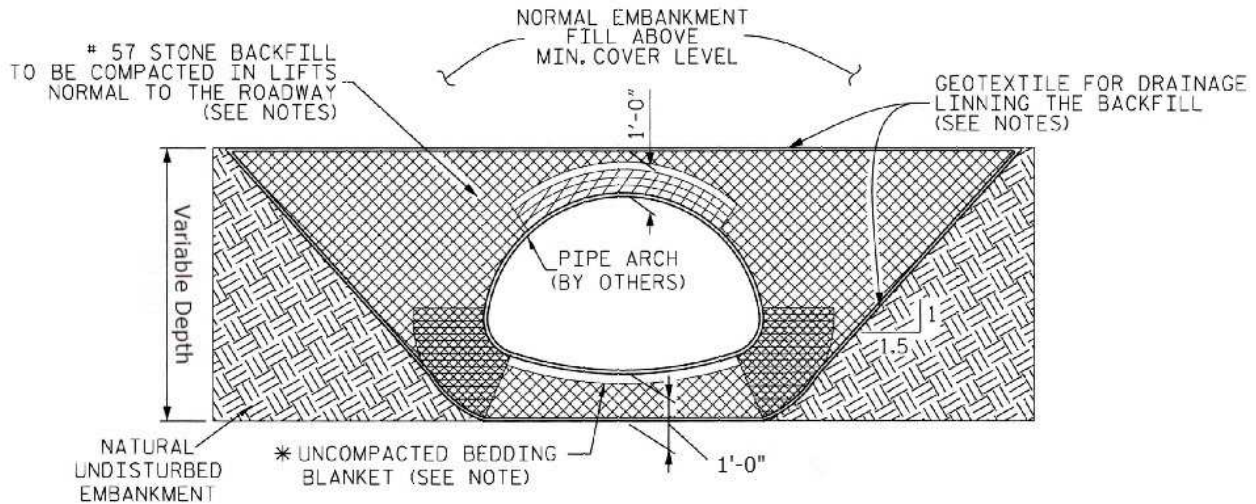

 CRITICAL BACKFILL ZONE, PRESSURE ON SOIL GREATEST HERE.

 INITIAL LIFTS OVER CROWN OF STRUCTURE AS INDICATED BY SHADED AREA TO BE COMPACTED TO REQUIRED DENSITY WITH HAND OPERATED EQUIPMENT

 # 57 STONE BACKFILL LIMITS.

NOTES:

ALL BACKFILL TO BE PLACED IN A BALANCED FASHION IN THIN LIFTS (6"-8" LOOSE TYPICALLY) AND COMPACTED TO 90 PERCENT DENSITY PER AASHTO T-180.

GEOTEXTILE FOR DRAINAGE IN FOUNDATION BEDDING AND BACKFILL IS INCIDENTAL TO COST OF PIPE ARCH.

COMPLETE AND REGULAR MONITORING OF THE CSP ARCH SHAPE IS NECESSARY DURING ALL BACKFILLING OF THE STRUCTURE.

PREVENT EXCESSIVE DISTORTION OF SHAPE AS NECESSARY BY VARYING COMPACTION METHODS AND EQUIPMENT.

* SHAPED BED FOR A MINIMUM WIDTH OF $SPAN/2$. MINIMUM BEDDING THICKNESS IS TWICE THE CORRUGATION DEPTH.

EMBANKMENT SLOPE TO BE 1.5:1 MINIMUM SUCH THAT A STABLE EMBANKMENT CAPABLE OF RESISTING SIDE PRESSURES FROM CSP PIPE-ARCH SHAPE WILL BE MAINTAINED THROUGHOUT THE LIFE OF INSTALLATION.

TYPICAL BACKFILL SECTION ALONG PIPE

NTS

STANDARD SPECIAL PROVISIONS

(10-18-95) (Rev. 10-15-13)

Z-1

PERMITS

The Contractor's attention is directed to the following permits, which have been issued to the Department of Transportation by the authority granting the permit.

<u>PERMIT</u>	<u>AUTHORITY GRANTING THE PERMIT</u>
Dredge and Fill and/or Work in Navigable Waters (404)	U. S. Army Corps of Engineers
Water Quality (401)	Division of Environmental Management, DENR State of North Carolina
Buffer Certification	Division of Environmental Management, DENR State of North Carolina
State Dredge and Fill and/or CAMA	Division of Coastal Management, DENR State of North Carolina
Navigation	U. S. Coast Guard
CCPCUA	Division of Water Resources, DENR State of North Carolina
TVA	Tennessee Valley Authority
FERC	Federal Energy Regulatory Commission

The Contractor shall comply with all applicable permit conditions during construction of this project. Those conditions marked by * are the responsibility of the Department and the Contractor has no responsibility in accomplishing those conditions.

Agents of the permitting authority will periodically inspect the project for adherence to the permits.

The Contractor's attention is also directed to Articles 107-10 and 107-13 of the *2012 Standard Specifications* and the following:

Should the Contractor propose to utilize construction methods (such as temporary structures or fill in waters and/or wetlands for haul roads, work platforms, cofferdams, etc.) not specifically identified in the permit (individual, general, or nationwide) authorizing the project it shall be the Contractor's responsibility to coordinate with the Engineer to determine what, if any, additional permit action is required. The Contractor shall also be responsible for initiating the request for the authorization of such construction method by the permitting agency. The request shall be submitted through the Engineer. The Contractor shall not utilize the construction method until it is approved by the permitting agency. The request normally takes approximately 60 days to process; however, no extensions of time or additional compensation will be granted for delays resulting from the Contractor's request for approval of construction methods not specifically identified in the permit.

Where construction moratoriums are contained in a permit condition which restricts the Contractor's activities to certain times of the year, those moratoriums will apply only to the portions of the work taking place in the waters or wetlands provided that activities outside those areas is done in such a manner as to not affect the waters or wetlands.

AVAILABILITY OF FUNDS – TERMINATION OF CONTRACTS

(5-20-08)

Z-2

General Statute 143C-6-11. (h) Highway Appropriation is hereby incorporated verbatim in this contract as follows:

(h) Amounts Encumbered. – Transportation project appropriations may be encumbered in the amount of allotments made to the Department of Transportation by the Director for the estimated payments for transportation project contract work to be performed in the appropriation fiscal year. The allotments shall be multiyear allotments and shall be based on estimated revenues and shall be subject to the maximum contract authority contained in *General Statute 143C-6-11(c)*. Payment for transportation project work performed pursuant to contract in any fiscal year other than the current fiscal year is subject to appropriations by the General Assembly. Transportation project contracts shall contain a schedule of

estimated completion progress, and any acceleration of this progress shall be subject to the approval of the Department of Transportation provided funds are available. The State reserves the right to terminate or suspend any transportation project contract, and any transportation project contract shall be so terminated or suspended if funds will not be available for payment of the work to be performed during that fiscal year pursuant to the contract. In the event of termination of any contract, the contractor shall be given a written notice of termination at least 60 days before completion of scheduled work for which funds are available. In the event of termination, the contractor shall be paid for the work already performed in accordance with the contract specifications.

Payment will be made on any contract terminated pursuant to the special provision in accordance with Subarticle 108-13(E) of the Standard Specifications.

NCDOT GENERAL SEED SPECIFICATION FOR SEED QUALITY

(5-17-11)

Z-3

Seed shall be sampled and tested by the North Carolina Department of Agriculture and Consumer Services, Seed Testing Laboratory. When said samples are collected, the vendor shall supply an independent laboratory report for each lot to be tested. Results from seed so sampled shall be final. Seed not meeting the specifications shall be rejected by the Department of Transportation and shall not be delivered to North Carolina Department of Transportation warehouses. If seed has been delivered it shall be available for pickup and replacement at the supplier’s expense.

Any re-labeling required by the North Carolina Department of Agriculture and Consumer Services, Seed Testing Laboratory, that would cause the label to reflect as otherwise specified herein shall be rejected by the North Carolina Department of Transportation.

Seed shall be free from seeds of the noxious weeds Johnsongrass, Balloonvine, Jimsonweed, Witchweed, Itchgrass, Serrated Tussock, Showy Crotalaria, Smooth Crotalaria, Sicklepod, Sandbur, Wild Onion, and Wild Garlic. Seed shall not be labeled with the above weed species on the seed analysis label. Tolerances as applied by the Association of Official Seed Analysts will NOT be allowed for the above noxious weeds except for Wild Onion and Wild Garlic.

Tolerances established by the Association of Official Seed Analysts will generally be recognized. However, for the purpose of figuring pure live seed, the found pure seed and found germination percentages as reported by the North Carolina Department of Agriculture and Consumer Services, Seed Testing Laboratory will be used. Allowances, as established by the NCDOT, will be recognized for minimum pure live seed as listed on the following pages.

The specifications for restricted noxious weed seed refers to the number per pound as follows:

<u>Restricted Noxious Weed</u>	<u>Limitations per Lb. Of Seed</u>	<u>Restricted Noxious Weed</u>	<u>Limitations per Lb. of Seed</u>
Blessed Thistle	4 seeds	Cornflower (Ragged Robin)	27 seeds
Cocklebur	4 seeds	Texas Panicum	27 seeds
Spurred Anoda	4 seeds	Bracted Plantain	54 seeds
Velvetleaf	4 seeds	Buckhorn Plantain	54 seeds
Morning-glory	8 seeds	Broadleaf Dock	54 seeds
Corn Cockle	10 seeds	Curly Dock	54 seeds
Wild Radish	12 seeds	Dodder	54 seeds
Purple Nutsedge	27 seeds	Giant Foxtail	54 seeds
Yellow Nutsedge	27 seeds	Horsenettle	54 seeds
Canada Thistle	27 seeds	Quackgrass	54 seeds
Field Bindweed	27 seeds	Wild Mustard	54 seeds
Hedge Bindweed	27 seeds		

Seed of Pensacola Bahiagrass shall not contain more than 7% inert matter, Kentucky Bluegrass, Centipede and Fine or Hard Fescue shall not contain more than 5% inert matter whereas a maximum of 2% inert matter will be allowed on all other kinds of seed. In addition, all seed shall not contain more than 2% other crop seed nor more than 1% total weed seed. The germination rate as tested by the North Carolina Department of Agriculture shall not fall below 70%, which

includes both dormant and hard seed. Seed shall be labeled with not more than 7%, 5% or 2% inert matter (according to above specifications), 2% other crop seed and 1% total weed seed.

Exceptions may be made for minimum pure live seed allowances when cases of seed variety shortages are verified. Pure live seed percentages will be applied in a verified shortage situation. Those purchase orders of deficient seed lots will be credited with the percentage that the seed is deficient.

FURTHER SPECIFICATIONS FOR EACH SEED GROUP ARE GIVEN BELOW:

Minimum 85% pure live seed; maximum 1% total weed seed; maximum 2% total other crop seed; maximum 144 restricted noxious weed seed per pound. Seed less than 83% pure live seed will not be approved.

Sericea Lespedeza
Oats (seeds)

Minimum 80% pure live seed; maximum 1% total weed seed; maximum 2% total other crop; maximum 144 restricted noxious weed seed per pound. Seed less than 78% pure live seed will not be approved.

Tall Fescue (all approved varieties)	Bermudagrass
Kobe Lespedeza	Browntop Millet
Korean Lespedeza	German Millet – Strain R
Weeping Lovegrass	Clover – Red/White/Crimson
Carpetgrass	

Minimum 78% pure live seed; maximum 1% total weed seed; maximum 2% total other crop seed; maximum 144 restricted noxious weed seed per pound. Seed less than 76% pure live seed will not be approved.

Common or Sweet Sundangrass

Minimum 76% pure live seed; maximum 1% total weed seed; maximum 2% total other crop seed; maximum 144 restricted noxious weed seed per pound. Seed less than 74% pure live seed will not be approved.

Rye (grain; all varieties)
Kentucky Bluegrass (all approved varieties)
Hard Fescue (all approved varieties)
Shrub (bicolor) Lespedeza

Minimum 70% pure live seed; maximum 1% total weed seed; maximum 2% total other crop seed; maximum 144 noxious weed seed per pound. Seed less than 70% pure live seed will not be approved.

Centipedegrass	Japanese Millet
Crownvetch	Reed Canary Grass
Pensacola Bahiagrass	Zoysia
Creeping Red Fescue	

Minimum 70% pure live seed; maximum 1% total weed seed; maximum 2% total other crop seed; maximum 5% inert matter; maximum 144 restricted noxious weed seed per pound.

Barnyard Grass
Big Bluestem
Little Bluestem
Bristly Locust
Birdsfoot Trefoil
Indiangrass
Orchardgrass
Switchgrass
Yellow Blossom Sweet Clover

ERRATA

(1-17-12) (Rev. 04-21-15)

Z-4

Revise the *2012 Standard Specifications* as follows:

Division 2

Page 2-7, line 31, Article 215-2 Construction Methods, replace "Article 107-26" with "Article 107-25".

Page 2-17, Article 226-3, Measurement and Payment, line 2, delete "pipe culverts,".

Page 2-20, Subarticle 230-4(B), Contractor Furnished Sources, change references as follows: Line 1, replace "(4) Buffer Zone" with "(c) Buffer Zone"; **Line 12**, replace "(5) Evaluation for Potential Wetlands and Endangered Species" with "(d) Evaluation for Potential Wetlands and Endangered Species"; and **Line 33**, replace "(6) Approval" with "(4) Approval".

Division 3

Page 3-1, after line 15, Article 300-2 Materials, replace "1032-9(F)" with "1032-6(F)".

Division 4

Page 4-77, line 27, Subarticle 452-3(C) Concrete Coping, replace "sheet pile" with "reinforcement".

Division 6

Page 6-7, line 31, Article 609-3 Field Verification of Mixture and Job Mix Formula Adjustments, replace "30" with "45".

Page 6-10, line 42, Subarticle 609-6(C)(2), replace "Subarticle 609-6(E)" with "Subarticle 609-6(D)".

Page 6-11, Table 609-1 Control Limits, replace "Max. Spec. Limit" for the Target Source of $P_{0.075}/P_{be}$ Ratio with "1.0".

Page 6-40, Article 650-2 Materials, replace "Subarticle 1012-1(F)" with "Subarticle 1012-1(E)".

Division 7

Page 7-1, Article 700-3, CONCRETE HAULING EQUIPMENT, line 33, replace "competion" with "completion".

Division 8

Page 8-23, line 10, Article 838-2 Materials, replace "Portland Cement Concrete, Class B" with "Portland Cement Concrete, Class A".

Division 10

Page 10-166, Article 1081-3 Hot Bitumen, replace "Table 1081-16" with "Table 1081-2", replace "Table 1081-17" with "Table 1081-3", and replace "Table 1081-18" with "Table 1081-4".

Division 12

Page 12-7, Table 1205-3, add "FOR THERMOPLASTIC" to the end of the title.

Page 12-8, Subarticle 1205-5(B), line 13, replace "Table 1205-2" with "Table 1205-4".

Page 12-8, Table 1205-4 and 1205-5, replace "THERMOPLASTIC" in the title of these tables with "POLYUREA".

Page 12-9, Subarticle 1205-6(B), line 21, replace "Table 1205-4" with "Table 1205-6".

Page 12-11, Subarticle 1205-8(C), line 25, replace "Table 1205-5" with "Table 1205-7".

Division 15

Page 15-4, Subarticle 1505-3(F) Backfilling, line 26, replace "Subarticle 235-4(C)" with "Subarticle 235-3(C)".

Page 15-6, Subarticle 1510-3(B), after line 21, replace the allowable leakage formula with the following: $W = LD\sqrt{P} \div 148,000$

Page 15-6, Subarticle 1510-3(B), line 32, delete "may be performed concurrently or" and replace with "shall be performed".

Page 15-17, Subarticle 1540-3(E), line 27, delete "Type 1".

Division 17

Page 17-26, line 42, Subarticle 1731-3(D) Termination and Splicing within Interconnect Center, delete this subarticle.

Revise the *2012 Roadway Standard Drawings* as follows:

1633.01 Sheet 1 of 1, English Standard Drawing for Matting Installation, replace "1633.01" with "1631.01".

PLANT AND PEST QUARANTINES

(Imported Fire Ant, Gypsy Moth, Witchweed, And Other Noxious Weeds)

(3-18-03) (Rev. 10-15-13)

Z-04a

Within Quarantined Area

This project may be within a county regulated for plant and/or pests. If the project or any part of the Contractor's operations is located within a quarantined area, thoroughly clean all equipment prior to moving out of the quarantined area. Comply with federal/state regulations by obtaining a certificate or limited permit for any regulated article moving from the quarantined area.

Originating in a Quarantined County

Obtain a certificate or limited permit issued by the N.C. Department of Agriculture/United States Department of Agriculture. Have the certificate or limited permit accompany the article when it arrives at the project site.

Contact

Contact the N.C. Department of Agriculture/United States Department of Agriculture at 1-800-206-9333, 919-733-6932, or <http://www.ncagr.gov/plantind/> to determine those specific project sites located in the quarantined area or for any regulated article used on this project originating in a quarantined county.

Regulated Articles Include

1. Soil, sand, gravel, compost, peat, humus, muck, and decomposed manure, separately or with other articles. This includes movement of articles listed above that may be associated with cut/waste, ditch pulling, and shoulder cutting.
2. Plants with roots including grass sod.
3. Plant crowns and roots.
4. Bulbs, corms, rhizomes, and tubers of ornamental plants.
5. Hay, straw, fodder, and plant litter of any kind.
6. Clearing and grubbing debris.
7. Used agricultural cultivating and harvesting equipment.
8. Used earth-moving equipment.
9. Any other products, articles, or means of conveyance, of any character, if determined by an inspector to present a hazard of spreading imported fire ant, gypsy moth, witchweed or other noxious weeds.

MINIMUM WAGES

(7-21-09)

Z-5

FEDERAL: The Fair Labor Standards Act provides that with certain exceptions every employer shall pay wages at the rate of not less than SEVEN DOLLARS AND TWENTY FIVE CENTS (\$7.25) per hour.

STATE: The North Carolina Minimum Wage Act provides that every employer shall pay to each of his employees, wages at a rate of not less than SEVEN DOLLARS AND TWENTY FIVE CENTS (\$7.25) per hour.

The minimum wage paid to all skilled labor employed on this contract shall be SEVEN DOLLARS AND TWENTY FIVE CENTS (\$7.25) per hour.

The minimum wage paid to all intermediate labor employed on this contract shall be SEVEN DOLLARS AND TWENTY FIVE CENTS (\$7.25) per hour.

The minimum wage paid to all unskilled labor on this contract shall be SEVEN DOLLARS AND TWENTY FIVE CENTS (\$7.25) per hour.

This determination of the intent of the application of this act to the contract on this project is the responsibility of the Contractor.

The Contractor shall have no claim against the Department of Transportation for any changes in the minimum wage laws, Federal or State. It is the responsibility of the Contractor to keep fully informed of all Federal and State Laws affecting his contract.

ON-THE-JOB TRAINING

(10-16-07) (Rev. 4-21-15)

Z-10

Description

The North Carolina Department of Transportation will administer a custom version of the Federal On-the-Job Training (OJT) Program, commonly referred to as the Alternate OJT Program. All contractors (existing and newcomers) will be automatically placed in the Alternate Program. Standard OJT requirements typically associated with individual projects will no longer be applied at the project level. Instead, these requirements will be applicable on an annual basis for each contractor administered by the OJT Program Manager.

On the Job Training shall meet the requirements of 23 CFR 230.107 (b), 23 USC – Section 140, this provision and the On-the-Job Training Program Manual.

The Alternate OJT Program will allow a contractor to train employees on Federal, State and privately funded projects located in North Carolina. However, priority shall be given to training employees on NCDOT Federal-Aid funded projects.

Minorities and Women

Developing, training and upgrading of minorities and women toward journeyman level status is a primary objective of this special training provision. Accordingly, the Contractor shall make every effort to enroll minority and women as trainees to the extent that such persons are available within a reasonable area of recruitment. This training commitment is not intended, and shall not be used, to discriminate against any applicant for training, whether a member of a minority group or not.

Assigning Training Goals

The Department, through the OJT Program Manager, will assign training goals for a calendar year based on the contractors' past three years' activity and the contractors' anticipated upcoming year's activity with the Department. At the beginning of each year, all contractors eligible will be contacted by the Department to determine the number of trainees that will be assigned for the upcoming calendar year. At that time the Contractor shall enter into an agreement with the Department to provide a self-imposed on-the-job training program for the calendar year. This agreement will include a specific number of annual training goals agreed to by both parties. The number of training assignments may range from 1 to 15 per contractor per calendar year. The Contractor shall sign an agreement to fulfill their annual goal for the year.\

Training Classifications

The Contractor shall provide on-the-job training aimed at developing full journeyman level workers in the construction craft/operator positions. Preference shall be given to providing training in the following skilled work classifications:

Equipment Operators	Office Engineers
Truck Drivers	Estimators
Carpenters	Iron / Reinforcing Steel Workers
Concrete Finishers	Mechanics
Pipe Layers	Welders

The Department has established common training classifications and their respective training requirements that may be used by the contractors. However, the classifications established are not all-inclusive. Where the training is oriented toward construction applications, training will be allowed in lower-level management positions such as office engineers and estimators. Contractors shall submit new classifications for specific job functions that their employees are performing. The Department will review and recommend for acceptance to FHWA the new classifications proposed by contractors, if applicable. New classifications shall meet the following requirements:

Proposed training classifications are reasonable and realistic based on the job skill classification needs, and

The number of training hours specified in the training classification is consistent with common practices and provides enough time for the trainee to obtain journeyman level status.

The Contractor may allow trainees to be trained by a subcontractor provided that the Contractor retains primary responsibility for meeting the training and this provision is made applicable to the subcontract. However, only the Contractor will receive credit towards the annual goal for the trainee.

Where feasible, 25 percent of apprentices or trainees in each occupation shall be in their first year of apprenticeship or training. The number of trainees shall be distributed among the work classifications on the basis of the contractor's needs and the availability of journeymen in the various classifications within a reasonable area of recruitment.

No employee shall be employed as a trainee in any classification in which they have successfully completed a training course leading to journeyman level status or in which they have been employed as a journeyman.

Records and Reports

The Contractor shall maintain enrollment, monthly and completion reports documenting company compliance under these contract documents. These documents and any other information as requested shall be submitted to the OJT Program Manager.

Upon completion and graduation of the program, the Contractor shall provide each trainee with a certification Certificate showing the type and length of training satisfactorily completed.

Trainee Interviews

All trainees enrolled in the program will receive an initial and Trainee/Post graduate interview conducted by the OJT program staff.

Trainee Wages

Contractors shall compensate trainees on a graduating pay scale based upon a percentage of the prevailing minimum journeyman wages (Davis-Bacon Act). Minimum pay shall be as follows:

60 percent	of the journeyman wage for the first half of the training period
75 percent	of the journeyman wage for the third quarter of the training period
90 percent	of the journeyman wage for the last quarter of the training period

In no instance shall a trainee be paid less than the local minimum wage. The Contractor shall adhere to the minimum hourly wage rate that will satisfy both the NC Department of Labor (NCDOL) and the Department.

Achieving or Failing to Meet Training Goals

The Contractor will be credited for each trainee employed by him on the contract work who is currently enrolled or becomes enrolled in an approved program and who receives training for at least 50 percent of the specific program requirement. Trainees will be allowed to be transferred between projects if required by the Contractor's scheduled workload to meet training goals.

If a contractor fails to attain their training assignments for the calendar year, they may be taken off the NCDOT's Bidders List.

Measurement and Payment

No compensation will be made for providing required training in accordance with these contract documents.

LISTING OF MB & WB SUBCONTRACTORS

Sheet ___ of ___

FIRM NAME AND ADDRESS	MBE or WBE	ITEM NO.	ITEM DESCRIPTION	*AGREED UPON UNIT PRICE	DOLLAR VOL. OF SUBLET ITEM

DOLLAR VOLUME OF WB SUBCONTRACTOR _____

WB PERCENTAGE OF TOTAL CONTRACT BID PRICE _____

DOLLAR VOLUME OF MB SUBCONTRACTOR _____

MB PERCENTAGE OF TOTAL CONTRACT BID PRICE _____

* THE DOLLAR VOLUME SHOWN IN THIS COLUMN SHALL BE THE ACTUAL PRICE AGREED UPON BY THE PRIME CONTRACTOR AND THE MB\WB SUBCONTRACTOR. THESE PRICES WILL BE USED TO DETERMINE THE PERCENTAGES OF MB\WB PARTICIPATION IN THE CONTRACT.

This form must be completed in order for the Bid to be considered responsive and be publicly read. Bidders with no MBE and/or WBE participation must so indicate this on the form by entering the word or number zero.

SUBSTITUTE FORM W-9
VENDOR REGISTRATION FORM NORTH CAROLINA DEPARTMENT OF TRANSPORTATION

Pursuant to Internal Revenue Service (IRS) Regulations, vendors must furnish their Taxpayer Identification Number (TIN) to the State. If this number is not provided, you may be subject to a 20% withholding on each payment. To avoid this 20% withholding and to insure that accurate tax information is reported to the Internal Revenue Service and the State, please use this form to provide the requested information exactly as it appears on file with the IRS.

INDIVIDUAL AND SOLE PROPRIETOR: ENTER NAME AS SHOWN ON SOCIAL SECURITY CARD
 CORPORATION OR PARTNERSHIP : ENTER YOUR LEGAL BUSINESS NAME

NAME: _____

MAILING ADDRESS: STREET/PO BOX: _____

CITY, STATE, ZIP: _____

DBA / TRADE NAME (IF APPLICABLE): _____

BUSINESS DESIGNATION: INDIVIDUAL (use Social Security No.) SOLE PROPRIETOR (use SS No. or Fed ID No.)
 CORPORATION (use Federal ID No.) PARTNERSHIP (use Federal ID No.)
 ESTATE/TRUST (use Federal ID no.) STATE OR LOCAL GOVT. (use Federal ID No.)
 OTHER / SPECIFY _____

SOCIAL SECURITY NO. _____ - _____ - _____ (Social Security #)

OR

FED.EMPLOYER IDENTIFICATION NO. _____ - _____ - _____ (Employer Identification #)

COMPLETE THIS SECTION IF PAYMENTS ARE MADE TO AN ADDRESS OTHER THAN THE ONE LISTED ABOVE:

REMIT TO ADDRESS: STREET / PO BOX: _____
CITY, STATE, ZIP: _____

Participation in this section is voluntary. You are not required to complete this section to become a registered vendor. The information below will in no way affect the vendor registration process and its sole purpose is to collect statistical data on those vendors doing business with NCDOT. If you choose to participate, circle the answer that best fits your firm's group definition.

What is your firm's ethnicity? (Prefer Not To Answer, African American, Native American, Caucasian American, Asian American, Hispanic American, Asian-Indian American, Other: _____)

What is your firm's gender? (Prefer Not to Answer, Male, Female) Disabled-Owned Business? (Prefer Not to Answer, Yes, No)

IRS Certification

Under penalties of perjury, I certify that:

1. The number shown on this form is my correct taxpayer identification and
2. I am not subject to backup withholding because: (a) I am exempt from backup withholding, or (b) I have not been notified by the IRS that I am subject to backup withholding as a result of a failure to report all interest or dividends, or (c) the IRS has notified me that I am no longer subject to backup withholding, and
3. I am a U.S. person (including a U.S. resident alien).

The IRS does not require your consent to any provision of this document other than the certifications required to avoid backup withholding. For complete certification instructions please see IRS FORM W-9 at <http://www.irs.gov/pub/irs-pdf/fw9.pdf> .

 NAME (Print or Type)

 TITLE (Print or Type)

 SIGNATURE

 DATE

 PHONE NUMBER

To avoid payment delays, completed forms should be returned promptly to:

**NC Department of Transportation
 Fiscal /Commercial Accounts
 1514 Mail Service Center
 Raleigh, North Carolina 27699-1514**

PHONE (919) 733-3624 FAX (919) 715-3700

AWARD LIMITS ON MULTIPLE PROJECTS

It is the desire of the Proposer to be awarded contracts, the value of which will not exceed a total of \$ _____, for those projects indicated below on which bids are being opened on the same date as shown in the Proposal Form. Individual projects shall be indicated by placing the project number and county in the appropriate place below. Projects not selected will not be subject to an award limit.

_____ (Project Number)	_____ (County)
_____ (Project Number)	_____ (County)
_____ (Project Number)	_____ (County)
_____ (Project Number)	_____ (County)

*If a Proposer desires to limit the total amount of work awarded to him in this letting, he shall state such limit in the space provided above in the second line of this form.

It is agreed that in the event that I am (we are) the successful bidder on indicated projects, the total value of which is more than the above stipulated award limits, the Board of Transportation will award me (us) projects from among those indicated which have a total value not exceeding the award limit and which will result in the best advantage to the Department of Transportation.

**Signature of Authorized Person

**Only those persons authorized to sign bids under the provisions of Article 102-8, Item 7, shall be authorized to sign this form.

EXECUTION OF BID

EXECUTION OF BID

NON-COLLUSION AFFIDAVIT, DEBARMENT CERTIFICATION AND GIFT BAN CERTIFICATION

CORPORATION

The person executing the bid, on behalf of the Bidder, being duly sworn, solemnly swears (or affirms) that neither he, nor any official, agent or employee of the bidder has entered into any agreement, participated in any collusion, or otherwise taken any action which is in restraint of free competitive bidding in connection with any bid or contract, that the bidder has not been convicted of violating *N.C.G.S. § 133-24* within the last three years, and that the Bidder intends to do the work with its own bonafide employees or subcontractors and is not bidding for the benefit of another contractor.

In addition, execution of this bid in the proper manner also constitutes the Bidder's certification of status under penalty of perjury under the laws of the United States in accordance with the Debarment Certification attached, provided that the Debarment Certification also includes any required statements concerning exceptions that are applicable.

N.C.G.S. § 133-32 and Executive Order 24 prohibit the offer to, or acceptance by, any State Employee of any gift from anyone with a contract with the State, or from any person seeking to do business with the State. By execution of any response in this procurement, you attest, for your entire organization and its employees or agents, that you are not aware that any such gift has been offered, accepted, or promised by any employees of your organization.

SIGNATURE OF CONTRACTOR

Full name of Corporation

Address as prequalified

Attest _____

Secretary/Assistant Secretary
Select appropriate title

By _____

President/Vice President/Assistant Vice President
Select appropriate title

Print or type Signer's name

Print or type Signer's name

CORPORATE SEAL

AFFIDAVIT MUST BE NOTARIZED

Subscribed and sworn to before me this the

_____ day of _____ 20__.

NOTARY SEAL

Signature of Notary Public

of _____ County

State of _____

My Commission Expires: _____

**EXECUTION OF BID
NON-COLLUSION AFFIDAVIT, DEBARMENT CERTIFICATION AND GIFT BAN CERTIFICATION
PARTNERSHIP**

The person executing the bid, on behalf of the Bidder, being duly sworn, solemnly swears (or affirms) that neither he, nor any official, agent or employee of the bidder has entered into any agreement, participated in any collusion, or otherwise taken any action which is in restraint of free competitive bidding in connection with any bid or contract, that the bidder has not been convicted of violating *N.C.G.S. § 133-24* within the last three years, and that the Bidder intends to do the work with its own bonafide employees or subcontractors and is not bidding for the benefit of another contractor.

In addition, execution of this bid in the proper manner also constitutes the Bidder's certification of status under penalty of perjury under the laws of the United States in accordance with the Debarment Certification attached, provided that the Debarment Certification also includes any required statements concerning exceptions that are applicable.

N.C.G.S. § 133-32 and Executive Order 24 prohibit the offer to, or acceptance by, any State Employee of any gift from anyone with a contract with the State, or from any person seeking to do business with the State. By execution of any response in this procurement, you attest, for your entire organization and its employees or agents, that you are not aware that any such gift has been offered, accepted, or promised by any employees of your organization.

SIGNATURE OF CONTRACTOR

Full Name of Partnership

Address as Prequalified

Signature of Witness

By _____
Signature of Partner

Print or type Signer's name

Print or type Signer's name

AFFIDAVIT MUST BE NOTARIZED

Subscribed and sworn to before me this the _____
_____ day of _____ 20__.

NOTARY SEAL

Signature of Notary Public

of _____ County

State of _____

My Commission Expires: _____

**EXECUTION OF BID
NON-COLLUSION AFFIDAVIT, DEBARMENT CERTIFICATION AND GIFT BAN CERTIFICATION
LIMITED LIABILITY COMPANY**

The person executing the bid, on behalf of the Bidder, being duly sworn, solemnly swears (or affirms) that neither he, nor any official, agent or employee of the bidder has entered into any agreement, participated in any collusion, or otherwise taken any action which is in restraint of free competitive bidding in connection with any bid or contract, that the bidder has not been convicted of violating *N.C.G.S. § 133-24* within the last three years, and that the Bidder intends to do the work with its own bonafide employees or subcontractors and is not bidding for the benefit of another contractor.

In addition, execution of this bid in the proper manner also constitutes the Bidder's certification of status under penalty of perjury under the laws of the United States in accordance with the Debarment Certification attached, provided that the Debarment Certification also includes any required statements concerning exceptions that are applicable.

N.C.G.S. § 133-32 and Executive Order 24 prohibit the offer to, or acceptance by, any State Employee of any gift from anyone with a contract with the State, or from any person seeking to do business with the State. By execution of any response in this procurement, you attest, for your entire organization and its employees or agents, that you are not aware that any such gift has been offered, accepted, or promised by any employees of your organization.

SIGNATURE OF CONTRACTOR

_____ Full Name of Firm

_____ Address as Prequalified

_____ Signature of Manager _____ Individually
Signature of Witness

_____ Print or type Signer's name _____ Print or type Signer's Name

AFFIDAVIT MUST BE NOTARIZED

Subscribed and sworn to before me this the **NOTARY SEAL**
_____ day of _____ 20__.

_____ Signature of Notary Public

of _____ County

State of _____

My Commission Expires: _____

**EXECUTION OF BID
NON-COLLUSION AFFIDAVIT, DEBARMENT CERTIFICATION AND GIFT BAN CERTIFICATION
JOINT VENTURE (2) or (3)**

The person executing the bid, on behalf of the Bidder, being duly sworn, solemnly swears (or affirms) that neither he, nor any official, agent or employee of the bidder has entered into any agreement, participated in any collusion, or otherwise taken any action which is in restraint of free competitive bidding in connection with any bid or contract, that the bidder has not been convicted of violating *N.C.G.S. § 133-24* within the last three years, and that the Bidder intends to do the work with its own bonafide employees or subcontractors and is not bidding for the benefit of another contractor.

In addition, execution of this bid in the proper manner also constitutes the Bidder's certification of status under penalty of perjury under the laws of the United States in accordance with the Debarment Certification attached, provided that the Debarment Certification also includes any required statements concerning exceptions that are applicable.

N.C.G.S. § 133-32 and Executive Order 24 prohibit the offer to, or acceptance by, any State Employee of any gift from anyone with a contract with the State, or from any person seeking to do business with the State. By execution of any response in this procurement, you attest, for your entire organization and its employees or agents, that you are not aware that any such gift has been offered, accepted, or promised by any employees of your organization.

SIGNATURE OF CONTRACTOR

Instructions: **2 Joint Venturers** Fill in lines (1), (2) and (3) and execute. **3 Joint Venturers** Fill in lines (1), (2), (3) and (4) and execute. On Line (1), fill in the name of the Joint Venture Company. On Line (2), fill in the name of one of the joint venturers and execute below in the appropriate manner. On Line (3), print or type the name of the other joint venturer and execute below in the appropriate manner. On Line (4), fill in the name of the third joint venturer, if applicable and execute below in the appropriate manner.

(1) _____
Name of Joint Venture

(2) _____
Name of Contractor

_____ Address as prequalified

Signature of Witness or Attest	By	Signature of Contractor
Print or type Signer's name		Print or type Signer's name

If Corporation, affix Corporate Seal and

(3) _____
Name of Contractor

_____ Address as prequalified

Signature of Witness or Attest	By	Signature of Contractor
Print or type Signer's name		Print or type Signer's name

If Corporation, affix Corporate Seal and

(4) _____
Name of Contractor (*for 3 Joint Venture only*)

_____ Address as prequalified

Signature of Witness or Attest	By	Signature of Contractor
Print or type Signer's name		Print or type Signer's name

If Corporation, affix Corporate Seal

NOTARY SEAL

Affidavit must be notarized for Line (2)

Subscribed and sworn to before me this _____ day of _____ 20____

Signature of Notary Public
of _____ County

State of _____

My Commission Expires: _____

NOTARY SEAL

Affidavit must be notarized for Line (3)

Subscribed and sworn to before me this _____ day of _____ 20____

Signature of Notary Public
of _____ County

State of _____

My Commission Expires: _____

NOTARY SEAL

Affidavit must be notarized for Line (4)

Subscribed and sworn to before me this _____ day of _____ 20____

Signature of Notary Public
of _____ County

State of _____

My Commission Expires: _____

**EXECUTION OF BID
NON-COLLUSION AFFIDAVIT, DEBARMENT CERTIFICATION AND GIFT BAN CERTIFICATION**

INDIVIDUAL DOING BUSINESS UNDER A FIRM NAME

The person executing the bid, on behalf of the Bidder, being duly sworn, solemnly swears (or affirms) that neither he, nor any official, agent or employee of the bidder has entered into any agreement, participated in any collusion, or otherwise taken any action which is in restraint of free competitive bidding in connection with any bid or contract, that the bidder has not been convicted of violating *N.C.G.S. § 133-24* within the last three years, and that the Bidder intends to do the work with its own bonafide employees or subcontractors and is not bidding for the benefit of another contractor.

In addition, execution of this bid in the proper manner also constitutes the Bidder's certification of status under penalty of perjury under the laws of the United States in accordance with the Debarment Certification attached, provided that the Debarment Certification also includes any required statements concerning exceptions that are applicable.

N.C.G.S. § 133-32 and Executive Order 24 prohibit the offer to, or acceptance by, any State Employee of any gift from anyone with a contract with the State, or from any person seeking to do business with the State. By execution of any response in this procurement, you attest, for your entire organization and its employees or agents, that you are not aware that any such gift has been offered, accepted, or promised by any employees of your organization.

SIGNATURE OF CONTRACTOR

Name of Contractor

_____ Individual name

Trading and doing business as

_____ Full name of Firm

_____ Address as Prequalified

_____ Signature of Witness

_____ Signature of Contractor, Individually

_____ Print or type Signer's name

_____ Print or type Signer's name

AFFIDAVIT MUST BE NOTARIZED

Subscribed and sworn to before me this the

NOTARY SEAL

_____ day of _____ 20__.

_____ Signature of Notary Public

of _____ County

State of _____

My Commission Expires: _____

**EXECUTION OF BID
NON-COLLUSION AFFIDAVIT, DEBARMENT CERTIFICATION AND GIFT BAN CERTIFICATION**

INDIVIDUAL DOING BUSINESS IN HIS OWN NAME

The person executing the bid, on behalf of the Bidder, being duly sworn, solemnly swears (or affirms) that neither he, nor any official, agent or employee of the bidder has entered into any agreement, participated in any collusion, or otherwise taken any action which is in restraint of free competitive bidding in connection with any bid or contract, that the bidder has not been convicted of violating *N.C.G.S. § 133-24* within the last three years, and that the Bidder intends to do the work with its own bonafide employees or subcontractors and is not bidding for the benefit of another contractor.

In addition, execution of this bid in the proper manner also constitutes the Bidder's certification of status under penalty of perjury under the laws of the United States in accordance with the Debarment Certification attached, provided that the Debarment Certification also includes any required statements concerning exceptions that are applicable.

N.C.G.S. § 133-32 and Executive Order 24 prohibit the offer to, or acceptance by, any State Employee of any gift from anyone with a contract with the State, or from any person seeking to do business with the State. By execution of any response in this procurement, you attest, for your entire organization and its employees or agents, that you are not aware that any such gift has been offered, accepted, or promised by any employees of your organization.

SIGNATURE OF CONTRACTOR

Name of Contractor _____
Print or type Individual name

Address as Prequalified

Signature of Contractor, Individually

Print or type Signer's Name

Signature of Witness

Print or type Signer's name

AFFIDAVIT MUST BE NOTARIZED

Subscribed and sworn to before me this the _____
_____ day of _____ 20__.

NOTARY SEAL

Signature of Notary Public

of _____ County

State of _____

My Commission Expires: _____

DEBARMENT CERTIFICATION

Conditions for certification:

1. The prequalified bidder shall provide immediate written notice to the Department if at any time the bidder learns that his certification was erroneous when he submitted his debarment certification or explanation that is file with the Department, or has become erroneous because of changed circumstances.
2. The terms *covered transaction*, *debarred*, *suspended*, *ineligible*, *lower tier covered transaction*, *participant*, *person*, *primary covered transaction*, *principal*, *proposal*, and *voluntarily excluded*, as used in this provision, have the meanings set out in the Definitions and Coverage sections of the rules implementing Executive Order 12549. A copy of the Federal Rules requiring this certification and detailing the definitions and coverages may be obtained from the Contract Officer of the Department.
3. The prequalified bidder agrees by submitting this form, that he will not knowingly enter into any lower tier covered transaction with a person who is debarred, suspended, declared ineligible, or voluntarily excluded from participation in NCDOT contracts, unless authorized by the Department.
4. For Federal Aid projects, the prequalified bidder further agrees that by submitting this form he will include the Federal-Aid Provision titled *Required Contract Provisions Federal-Aid Construction Contract (Form FHWA PR 1273)* provided by the Department, without subsequent modification, in all lower tier covered transactions.
5. The prequalified bidder may rely upon a certification of a participant in a lower tier covered transaction that he is not debarred, suspended, ineligible, or voluntarily excluded from the covered transaction, unless he knows that the certification is erroneous. The bidder may decide the method and frequency by which he will determine the eligibility of his subcontractors.
6. Nothing contained in the foregoing shall be construed to require establishment of a system of records in order to render in good faith the certification required by this provision. The knowledge and information of a participant is not required to exceed that which is normally possessed by a prudent person in the ordinary course of business dealings.
7. Except as authorized in paragraph 6 herein, the Department may terminate any contract if the bidder knowingly enters into a lower tier covered transaction with a person who is suspended, debarred, ineligible, or voluntarily excluded from participation in this transaction, in addition to other remedies available by the Federal Government.

DEBARMENT CERTIFICATION

The prequalified bidder certifies to the best of his knowledge and belief, that he and his principals:

- a. Are not presently debarred, suspended, proposed for debarment, declared ineligible, or voluntarily excluded from covered transactions by any Federal department or agency;
- b. Have not within a three-year period preceding this proposal been convicted of or had a civil judgment rendered against them for commission of fraud or a criminal offense in connection with obtaining, attempting to obtain, or performing a public (Federal, State or local) transaction or contract under a public transaction; violation of Federal or State antitrust statutes or commission of embezzlement, theft, forgery, bribery, falsification or destruction of records; making false statements; or receiving stolen property;
- c. Are not presently indicted for or otherwise criminally or civilly charged by a governmental entity (Federal, State or local) with commission of any of the offenses enumerated in paragraph b. of this certification; and
- d. Have not within a three-year period preceding this proposal had one or more public transactions (Federal, State or local) terminated for cause or default.
- e. Will submit a revised Debarment Certification immediately if his status changes and will show in his bid proposal an explanation for the change in status.

If the prequalified bidder cannot certify that he is not debarred, he shall provide an explanation with this submittal. An explanation will not necessarily result in denial of participation in a contract.

Failure to submit a non-collusion affidavit and debarment certification will result in the prequalified bidder's bid being considered non-responsive.

Check here if an explanation is attached to this certification.

PAYMENT REQUEST

WBS ELEMENT NO. _____ PARTIAL FINAL

Bill To: _____

Pay Request No. _____

Contractor's Name and Mailing Address

Period from: _____ to _____

Purchase Order Number: _____
 Purchase Order Amount: \$ _____
 Supplementals: \$ _____

FUNC CODE	LINE	ITEM DESCRIPTION	CONTRACT QUANTITY	UNIT	PREVIOUS QUANTITY	CURRENT QUANTITY	TOTAL QUANTITY	UNIT PRICE	TOTAL AMOUNT

Total Amount to Date \$ _____
 Less _____ % Retainage _____
 Less Previous Payments **(A)** _____
 Less Anticip. Liq. Dam. _____
AMOUNT DUE THIS PAYMENT \$

PAYMENTS TO DBE/MBE/WBE SUBCONTRACTORS

Payor Fed Tax Id:	Name:	Payee Fed Tax Id:	Name:	Amount Paid

Contractor's Authorized Representative: _____ (Date)
 Payment Recommended By: _____ (Date)

State of North Carolina
Department of Transportation
Subcontractor Payment Information

Submit with Invoice To: Invoice Coordinator
North Carolina Department of Transportation
Division 6 – District 1
PO BOX 2157
Lumberton, NC 28359

Firm Invoice No. Reference: _____
 NCDOT PO / Contract Number: _____
 WBS No. / Map No.: _____
 Date of Invoice: _____

Invoice Line Item Reference	Payer Name	Payer Federal Tax ID	Subcontractor/ Subconsultant/ Material Supplier Name	Subcontractor/ Subconsultant/ Material Supplier Federal Tax ID	Amount Paid To Subcontractor/ Subconsultant/ Material Supplier This Invoice	Date Paid To Subcontractor/ Subconsultant/ Material Supplier This Invoice
Total Amount Paid to Subcontractor Firms: \$						

Note: These documents are scanned into the NCDOT Fiscal Program. Please do not highlight or shade the figures.

Certification of Firm

I certify that this information accurately reflects actual payments made and the dates the payments were made to Subcontractors/Subconsultants/Material Suppliers on the above referenced project.

Signature: _____
 Print Name: _____

Title: _____
 Date: _____

North Carolina Department of Transportation

CONTRACT BID FORM

WBS NUMBER: 17BP.6.R.66
COUNTY: ROBESON
LOCATION: SR 2214
DESCRIPTION: PIPE REMOVAL AND REPLACEMENT

ITEM	DESC NO.	SECT	DESCRIPTION	QTY	UNIT	UNIT PRICE	AMOUNT BID
1	0001000000-N	800	Mobilization	1	LS		
2	0043000000-N	SP	Comprehensive Grading	1	LS		
3	0106000000-E	230	Borrow	50	CY		
4	0995000000-E	340	Pipe Removal	90	LF		
5	1077000000-E	SP	#57 Stone / Backfill	884	TON		
6	1121000000-E	520	Aggregate Base Course	93	TON		
7	1498000000-E	610	ACIC, Type I19.0B	25	TON		
8	1525000000-E	610	ACSC, Type SF9.5A	55	TON		
9	1575000000-E	620	Asphalt Binder, Grade PG 64-22	5	TON		
10	2473000000-N	SP	Pipe & Headwall (2 @ 95" x 67" x 54')	1	EA		
11	3691000000-N	SP	Dewatering	1	EA		
12	5890000000-N	SP	Utility Relocations	1	EA		
13	6000000000-E	1605	Temporary Silt Fence	100	LF		
14	6009000000-E	1610	Stone for Erosion Control -Class B	150	TON		
15	6036000000-E	1631	Matting for Erosion Control	50	SY		
16	6071010000-E	SP	Wattle	48	LF		
17	6084000000-E	1660	Seeding and Mulching	0.5	AC		
SUBTOTAL:							

WBS NUMBER: 17BP.6.R.66
COUNTY: ROBESON
LOCATION: SR 2422
DESCRIPTION: PIPE REMOVAL AND REPLACEMENT

ITEM	DESC NO.	SECT	DESCRIPTION	QTY	UNIT	UNIT PRICE	AMOUNT BID
1	0001000000-N	800	Mobilization	1	LS		
2	0043000000-N	SP	Comprehensive Grading	1	LS		
3	0106000000-E	230	Borrow	50	CY		
4	0995000000-E	340	Pipe Removal	96	LF		
5	1077000000-E	SP	#57 Stone / Backfill	908	TON		
6	1121000000-E	520	Aggregate Base Course	93	TON		
7	1498000000-E	610	ACIC, Type I19.0B	25	TON		
8	1525000000-E	610	ACSC, Type SF9.5A	55	TON		
9	1575000000-E	620	Asphalt Binder, Grade PG 64-22	5	TON		
10	2473000000-N	SP	Pipe & Headwall (2 @ 95" x 67" x 44')	1	EA		
11	3691000000-N	SP	Dewatering	1	EA		
12	5890000000-N	SP	Utility Relocations	1	EA		
13	6000000000-E	1605	Temporary Silt Fence	100	LF		
14	6009000000-E	1610	Stone for Erosion Control -Class B	150	TON		
15	6036000000-E	1631	Matting for Erosion Control	50	SY		
16	6071010000-E	SP	Wattle	48	LF		
17	6084000000-E	1660	Seeding and Mulching	0.5	AC		
SUBTOTAL:							

North Carolina Department of Transportation

CONTRACT BID FORM

WBS NUMBER: 17BP.6.R.66
COUNTY: ROBESON
LOCATION: SR 2454
DESCRIPTION: PIPE REMOVAL AND REPLACEMENT

ITEM	DESC NO.	SECT	DESCRIPTION	QTY	UNIT	UNIT PRICE	AMOUNT BID
1	0001000000-N	800	Mobilization	1	LS		
2	0043000000-N	SP	Comprehensive Grading	1	LS		
3	0106000000-E	230	Borrow	50	CY		
4	0995000000-E	340	Pipe Removal	92	LF		
5	1077000000-E	SP	#57 Stone / Backfill	1981	TON		
6	1121000000-E	520	Aggregate Base Course	123	TON		
7	1498000000-E	610	ACIC, Type I19.0B	31	TON		
8	1525000000-E	610	ACSC, Type SF9.5A	59	TON		
9	1575000000-E	620	Asphalt Binder, Grade PG 64-22	6	TON		
10	2473000000-N	SP	Pipe & Headwall (2 @ 112" x 75")	1	EA		
11	3691000000-N	SP	Dewatering	1	EA		
12	5890000000-N	SP	Utility Relocations	1	EA		
13	6000000000-E	1605	Temporary Silt Fence	100	LF		
14	6009000000-E	1610	Stone for Erosion Control -Class B	250	TON		
15	6036000000-E	1631	Matting for Erosion Control	50	SY		
16	6071010000-E	SP	Wattle	48	LF		
17	6084000000-E	1660	Seeding and Mulching	0.5	AC		
SUBTOTAL:							

TOTAL BID FOR PROJECT:
 (NOTE: Sum of subtotals placed here.)

CONTRACTOR _____

STREET ADDRESS _____

CITY, STATE, ZIP _____

Federal Identification Number _____ Contractors License Number _____

Authorized Agent _____ Title _____

Signature _____ Date _____

Witness _____ Title _____

Signature _____ Date _____

THIS SECTION TO BE COMPLETED BY NORTH CAROLINA DEPARTMENT OF TRANSPORTATION
 This bid has been reviewed in accordance with Article 103-1 of the current edition of the Standard Specifications.

Reviewed by _____ (date) _____
 Division Proposals Engineer

Accepted by _____ (date) _____
 Division Engineer

ENVIRONMENTAL PERMIT



STATE OF NORTH CAROLINA
DEPARTMENT OF TRANSPORTATION

PAT L. MCCRORY
GOVERNOR

ANTHONY J. TATA
SECRETARY

MARCH 30, 2015

Department of Transportation
Division 6 Bridge Engineer
Attn: Darren Pittman
558 Gillespie St
Fayetteville, NC 28301

RE: ACOE Nationwide Permit #3 (Maintenance)
Culvert Replacements Robeson County

Dear Mr. Pittman:

The replacement of the crossline culvert pipes in Robeson County has been determined to be consistent with the U.S. Army Corps of Engineers Nationwide Permit #3 for Maintenance.

State Road Number/Location	Existing Culvert	Proposed Culvert	Stream Impact
SR 2454 0.3mi E SR 2455	2 (46 LF 72" CMP)	50 LF (112"x75") CMPA w/ Headwalls	4 LF
SR 2214 0.2mi S SR 2212	2 (45 LF 72" CMP)	2 (54 LF 95" x 67" CMPA)	9 LF
SR 2422 0.2mi W SR 1003	2 (48 LF 72" CMP)	2 (48 LF 95" x 67" CMPA)	0 LF

The proposed work is authorized by James J. Rerko, PWS, Division 6 Environmental Officer, provided that it is accomplished in strict accordance with the attached conditions (COE General and Regional Conditions and NCDENR 401 WQC#3883). Notification to the U.S. Army Corps of Engineers will be via a Completion Report, of which, the Corps of Engineers will conduct a field inspection of the completed work to ensure compliance.

A copy of the U.S. Army Corps of Engineers General and Regional Conditions are enclosed, along with the NCDENR Division of Water Quality 401 General Certification #3883. If you should have any questions regarding this notification, please feel free to contact me.

Sincerely,

James J. Rerko, PWS
Division 6 Environmental Officer

NATIONWIDE PERMIT 3
DEPARTMENT OF THE ARMY
CORPS OF ENGINEERS
FINAL NOTICE OF ISSUANCE AND MODIFICATION OF NATIONWIDE PERMITS
FEDERAL REGISTER
AUTHORIZED MARCH 19, 2012

Maintenance. (a) The repair, rehabilitation, or replacement of any previously authorized, currently serviceable structure, or fill, or of any currently serviceable structure or fill authorized by 33 CFR 330.3, provided that the structure or fill is not to be put to uses differing from those uses specified or contemplated for it in the original permit or the most recently authorized modification. Minor deviations in the structure's configuration or filled area, including those due to changes in materials, construction techniques, requirements of other regulatory agencies, or current construction codes or safety standards that are necessary to make the repair, rehabilitation, or replacement are authorized. Any stream channel modification is limited to the minimum necessary for the repair, rehabilitation, or replacement of the structure or fill; such modifications, including the removal of material from the stream channel, must be immediately adjacent to the project or within the boundaries of the structure or fill. This NWP also authorizes the repair, rehabilitation, or replacement of those structures or fills destroyed or damaged by storms, floods, fire or other discrete events, provided the repair, rehabilitation, or replacement is commenced, or is under contract to commence, within two years of the date of their destruction or damage. In cases of catastrophic events, such as hurricanes or tornadoes, this two-year limit may be waived by the district engineer, provided the permittee can demonstrate funding, contract, or other similar delays.

(b) This NWP also authorizes the removal of accumulated sediments and debris in the vicinity of existing structures (e.g., bridges, culverted road crossings, water intake structures, etc.) and/or the placement of new or additional riprap to protect the structure. The removal of sediment is limited to the minimum necessary to restore the waterway in the vicinity of the structure to the approximate dimensions that existed when the structure was built, but cannot extend farther than 200 feet in any direction from the structure. This 200 foot limit does not apply to maintenance dredging to remove accumulated sediments blocking or restricting outfall and intake structures or to maintenance dredging to remove accumulated sediments from canals associated with outfall and intake structures. All dredged or excavated materials must be deposited and retained in an area that has no waters of the United States unless otherwise specifically approved by the district engineer under separate authorization. The placement of new or additional riprap must be the minimum necessary to protect the structure or to ensure the safety of the structure. Any bank stabilization measures not directly associated with the structure will require a separate authorization from the district engineer.

(c) This NWP also authorizes temporary structures, fills, and work necessary to conduct the maintenance activity. Appropriate measures must be taken to maintain normal downstream flows and minimize flooding to the maximum extent practicable, when temporary structures, work, and discharges, including cofferdams, are necessary for construction activities, access fills, or dewatering of construction sites. Temporary fills must consist of materials, and be placed in a manner, that will not be eroded by expected high flows. Temporary fills must be removed in

**NATIONWIDE PERMIT 3
DEPARTMENT OF THE ARMY
CORPS OF ENGINEERS
FINAL NOTICE OF ISSUANCE AND MODIFICATION OF NATIONWIDE PERMITS
FEDERAL REGISTER
AUTHORIZED MARCH 19, 2012**

Maintenance. (a) The repair, rehabilitation, or replacement of any previously authorized, currently serviceable structure, or fill, or of any currently serviceable structure or fill authorized by 33 CFR 330.3, provided that the structure or fill is not to be put to uses differing from those uses specified or contemplated for it in the original permit or the most recently authorized modification. Minor deviations in the structure's configuration or filled area, including those due to changes in materials, construction techniques, requirements of other regulatory agencies, or current construction codes or safety standards that are necessary to make the repair, rehabilitation, or replacement are authorized. Any stream channel modification is limited to the minimum necessary for the repair, rehabilitation, or replacement of the structure or fill; such modifications, including the removal of material from the stream channel, must be immediately adjacent to the project or within the boundaries of the structure or fill. This NWP also authorizes the repair, rehabilitation, or replacement of those structures or fills destroyed or damaged by storms, floods, fire or other discrete events, provided the repair, rehabilitation, or replacement is commenced, or is under contract to commence, within two years of the date of their destruction or damage. In cases of catastrophic events, such as hurricanes or tornadoes, this two-year limit may be waived by the district engineer, provided the permittee can demonstrate funding, contract, or other similar delays.

(b) This NWP also authorizes the removal of accumulated sediments and debris in the vicinity of existing structures (e.g., bridges, culverted road crossings, water intake structures, etc.) and/or the placement of new or additional riprap to protect the structure. The removal of sediment is limited to the minimum necessary to restore the waterway in the vicinity of the structure to the approximate dimensions that existed when the structure was built, but cannot extend farther than 200 feet in any direction from the structure. This 200 foot limit does not apply to maintenance dredging to remove accumulated sediments blocking or restricting outfall and intake structures or to maintenance dredging to remove accumulated sediments from canals associated with outfall and intake structures. All dredged or excavated materials must be deposited and retained in an area that has no waters of the United States unless otherwise specifically approved by the district engineer under separate authorization. The placement of new or additional riprap must be the minimum necessary to protect the structure or to ensure the safety of the structure. Any bank stabilization measures not directly associated with the structure will require a separate authorization from the district engineer.

(c) This NWP also authorizes temporary structures, fills, and work necessary to conduct the maintenance activity. Appropriate measures must be taken to maintain normal downstream flows and minimize flooding to the maximum extent practicable, when temporary structures, work, and discharges, including cofferdams, are necessary for construction activities, access fills, or dewatering of construction sites. Temporary fills must consist of materials, and be placed in a manner, that will not be eroded by expected high flows. Temporary fills must be removed in

their entirety and the affected areas returned to pre-construction elevations. The areas affected by temporary fills must be revegetated, as appropriate.

(d) This NWP does not authorize maintenance dredging for the primary purpose of navigation. This NWP does not authorize beach restoration. This NWP does not authorize new stream channelization or stream relocation projects.

Notification: For activities authorized by paragraph (b) of this NWP, the permittee must submit a pre-construction notification to the district engineer prior to commencing the activity (see general condition 31). The pre-construction notification must include information regarding the original design capacities and configurations of the outfalls, intakes, small impoundments, and canals. (Sections 10 and 404)

Note: This NWP authorizes the repair, rehabilitation, or replacement of any previously authorized structure or fill that does not qualify for the Clean Water Act Section 404(f) exemption for maintenance.

NATIONWIDE PERMIT CONDITIONS

The following General Conditions must be followed in order for any authorization by a NWP to be valid:

1. Navigation. (a) No activity may cause more than a minimal adverse effect on navigation.

(b) Any safety lights and signals prescribed by the U.S. Coast Guard, through regulations or otherwise, must be installed and maintained at the permittee's expense on authorized facilities in navigable waters of the United States.

(c) The permittee understands and agrees that, if future operations by the United States require the removal, relocation, or other alteration, of the structure or work herein authorized, or if, in the opinion of the Secretary of the Army or his authorized representative, said structure or work shall cause unreasonable obstruction to the free navigation of the navigable waters, the permittee will be required, upon due notice from the Corps of Engineers, to remove, relocate, or alter the structural work or obstructions caused thereby, without expense to the United States. No claim shall be made against the United States on account of any such removal or alteration.

2. Aquatic Life Movements. No activity may substantially disrupt the necessary life cycle movements of those species of aquatic life indigenous to the waterbody, including those species that normally migrate through the area, unless the activity's primary purpose is to impound water. All permanent and temporary crossings of waterbodies shall be suitably culverted, bridged, or otherwise designed and constructed to maintain low flows to sustain the movement of those aquatic species.

3. Spawning Areas. Activities in spawning areas during spawning seasons must be avoided to the maximum extent practicable. Activities that result in the physical destruction (e.g., through excavation, fill, or downstream smothering by substantial turbidity) of an important spawning area are not authorized.

4. Migratory Bird Breeding Areas. Activities in waters of the United States that serve as breeding areas for migratory birds must be avoided to the maximum extent practicable.

5. Shellfish Beds. No activity may occur in areas of concentrated shellfish populations, unless the activity is directly related to a shellfish harvesting activity authorized by NWPs 4 and 48, or is a shellfish seeding or habitat restoration activity authorized by NWP 27.

6. Suitable Material. No activity may use unsuitable material (e.g., trash, debris, car bodies, asphalt, etc.). Material used for construction or discharged must be free from toxic pollutants in toxic amounts (see Section 307 of the Clean Water Act).

7. Water Supply Intakes. No activity may occur in the proximity of a public water supply intake, except where the activity is for the repair or improvement of public water supply intake structures or adjacent bank stabilization.

8. Adverse Effects From Impoundments. If the activity creates an impoundment of water, adverse effects to the aquatic system due to accelerating the passage of water, and/or restricting its flow must be minimized to the maximum extent practicable.

9. Management of Water Flows. To the maximum extent practicable, the pre-construction course, condition, capacity, and location of open waters must be maintained for each activity, including stream channelization and storm water management activities, except as provided below. The activity must be constructed to withstand expected high flows. The activity must not restrict or impede the passage of normal or high flows, unless the primary purpose of the activity is to impound water or manage high flows. The activity may alter the pre-construction course, condition, capacity, and location of open waters if it benefits the aquatic environment (e.g., stream restoration or relocation activities).

10. Fills Within 100-Year Floodplains. The activity must comply with applicable FEMA-approved state or local floodplain management requirements.

11. Equipment. Heavy equipment working in wetlands or mudflats must be placed on mats, or other measures must be taken to minimize soil disturbance.

12. Soil Erosion and Sediment Controls. Appropriate soil erosion and sediment controls must be used and maintained in effective operating condition during construction, and all exposed soil and other fills, as well as any work below the ordinary high water mark or high tide line, must be permanently stabilized at the earliest practicable date. Permittees are encouraged to perform work within waters of the United States during periods of low-flow or no-flow.

13. Removal of Temporary Fills. Temporary fills must be removed in their entirety and the affected areas returned to pre-construction elevations. The affected areas must be revegetated, as appropriate.

14. Proper Maintenance. Any authorized structure or fill shall be properly maintained, including maintenance to ensure public safety and compliance with applicable NWP general conditions, as well as any activity-specific conditions added by the district engineer to an NWP authorization.

15. Single and Complete Project. The activity must be a single and complete project. The same NWP cannot be used more than once for the same single and complete project.

16. Wild and Scenic Rivers. No activity may occur in a component of the National Wild and Scenic River System, or in a river officially designated by Congress as a “study river” for possible inclusion in the system while the river is in an official study status, unless the appropriate Federal agency with direct management responsibility for such river, has determined in writing that the proposed activity will not adversely affect the Wild and Scenic River designation or study status. Information on Wild and Scenic Rivers may be obtained from the appropriate Federal land management agency responsible for the designated Wild and Scenic River or study river (e.g., National Park Service, U.S. Forest Service, Bureau of Land Management, U.S. Fish and Wildlife Service).

17. Tribal Rights. No activity or its operation may impair reserved tribal rights, including, but not limited to, reserved water rights and treaty fishing and hunting rights.

18. Endangered Species. (a) No activity is authorized under any NWP which is likely to directly or indirectly jeopardize the continued existence of a threatened or endangered species or a species proposed for such designation, as identified under the Federal Endangered Species Act (ESA), or which will directly or indirectly destroy or adversely modify the critical habitat of such species. No activity is authorized under any NWP which “may affect” a listed species or critical habitat, unless Section 7 consultation addressing the effects of the proposed activity has been completed.

(b) Federal agencies should follow their own procedures for complying with the requirements of the ESA. Federal permittees must provide the district engineer with the appropriate documentation to demonstrate compliance with those requirements. The district engineer will review the documentation and determine whether it is sufficient to address ESA compliance for the NWP activity, or whether additional ESA consultation is necessary.

(c) Non-federal permittees must submit a pre-construction notification to the district engineer if any listed species or designated critical habitat might be affected or is in the vicinity of the project, or if the project is located in designated critical habitat, and shall not begin work on the activity until notified by the district engineer that the requirements of the ESA have been satisfied and that the activity is authorized. For activities that might affect Federally-listed endangered or threatened species or designated critical habitat, the pre-construction notification must include the name(s) of the endangered or threatened species that might be affected by the proposed work or that utilize the designated critical habitat that might be affected by the proposed work. The district engineer will determine whether the proposed activity “may affect” or will have “no effect” to listed species and designated critical habitat and will notify the non-Federal applicant of the Corps’ determination within 45 days of receipt of a complete pre-construction notification. In cases where the non-Federal applicant has identified listed species or critical habitat that might be affected or is in the vicinity of the project, and has so notified the Corps, the applicant shall not begin work until the Corps has provided notification the proposed activities will have “no effect” on listed species or critical habitat, or until Section 7 consultation has been completed. If the non-Federal applicant has not heard back from the Corps within 45 days, the applicant must still wait for notification from the Corps.

(d) As a result of formal or informal consultation with the FWS or NMFS the district engineer may add species-specific regional endangered species conditions to the NWPs.

(e) Authorization of an activity by a NWP does not authorize the “take” of a threatened or endangered species as defined under the ESA. In the absence of separate authorization (e.g., an ESA Section 10 Permit, a Biological Opinion with “incidental take” provisions, etc.) from the U.S. FWS or the NMFS, The Endangered Species Act prohibits any person subject to the jurisdiction of the United States to take a listed species, where “take” means to harass, harm, pursue, hunt, shoot, wound, kill, trap, capture, or collect, or to attempt to engage in any such conduct. The word “harm” in the definition of “take” means an act which actually kills or injures wildlife. Such an act may include significant habitat modification or degradation where it actually kills or injures wildlife by significantly impairing essential behavioral patterns, including breeding, feeding or sheltering.

(f) Information on the location of threatened and endangered species and their critical habitat can be obtained directly from the offices of the U.S. FWS and NMFS or their world wide web pages at <http://www.fws.gov/> or <http://www.fws.gov/ipac> and <http://www.noaa.gov/fisheries.html> respectively.

19. Migratory Birds and Bald and Golden Eagles. The permittee is responsible for obtaining any “take” permits required under the U.S. Fish and Wildlife Service’s regulations governing compliance with the Migratory Bird Treaty Act or the Bald and Golden Eagle Protection Act. The permittee should contact the appropriate local office of the U.S. Fish and Wildlife Service to determine if such “take” permits are required for a particular activity.

20. Historic Properties. (a) In cases where the district engineer determines that the activity may affect properties listed, or eligible for listing, in the National Register of Historic Places, the activity is not authorized, until the requirements of Section 106 of the National Historic Preservation Act (NHPA) have been satisfied.

(b) Federal permittees should follow their own procedures for complying with the requirements of Section 106 of the National Historic Preservation Act. Federal permittees must provide the district engineer with the appropriate documentation to demonstrate compliance with those requirements. The district engineer will review the documentation and determine whether it is sufficient to address section 106 compliance for the NWP activity, or whether additional section 106 consultation is necessary.

(c) Non-federal permittees must submit a pre-construction notification to the district engineer if the authorized activity may have the potential to cause effects to any historic properties listed on, determined to be eligible for listing on, or potentially eligible for listing on the National Register of Historic Places, including previously unidentified properties. For such activities, the pre-construction notification must state which historic properties may be affected by the proposed work or include a vicinity map indicating the location of the historic properties or the potential for the presence of historic properties. Assistance regarding information on the location of or potential for the presence of historic resources can be sought from the State Historic Preservation Officer or Tribal Historic Preservation Officer, as appropriate, and the National Register of Historic Places (see 33 CFR 330.4(g)). When reviewing pre-construction notifications, district engineers will comply with the current procedures for addressing the requirements of Section 106 of the National Historic Preservation Act. The district engineer shall make a reasonable and good faith effort to carry out appropriate identification efforts, which may include background research, consultation, oral history interviews, sample field investigation, and field survey. Based on the information submitted and these efforts, the district engineer shall determine whether the proposed activity has the potential to cause an effect on the historic properties. Where the non-Federal applicant has identified historic properties on which the activity may have the potential to cause effects and so notified the Corps, the non-Federal applicant shall not begin the activity until notified by the district engineer either that the activity has no potential to cause effects or that consultation under Section 106 of the NHPA has been completed.

(d) The district engineer will notify the prospective permittee within 45 days of receipt of a complete pre-construction notification whether NHPA Section 106 consultation is required. Section 106 consultation is not required when the Corps determines that the activity does not have the potential to cause effects on historic properties (see 36 CFR §800.3(a)). If NHPA

section 106 consultation is required and will occur, the district engineer will notify the non-Federal applicant that he or she cannot begin work until Section 106 consultation is completed. If the non-Federal applicant has not heard back from the Corps within 45 days, the applicant must still wait for notification from the Corps.

(e) Prospective permittees should be aware that section 110k of the NHPA (16 U.S.C. 470h-2(k)) prevents the Corps from granting a permit or other assistance to an applicant who, with intent to avoid the requirements of Section 106 of the NHPA, has intentionally significantly adversely affected a historic property to which the permit would relate, or having legal power to prevent it, allowed such significant adverse effect to occur, unless the Corps, after consultation with the Advisory Council on Historic Preservation (ACHP), determines that circumstances justify granting such assistance despite the adverse effect created or permitted by the applicant. If circumstances justify granting the assistance, the Corps is required to notify the ACHP and provide documentation specifying the circumstances, the degree of damage to the integrity of any historic properties affected, and proposed mitigation. This documentation must include any views obtained from the applicant, SHPO/THPO, appropriate Indian tribes if the undertaking occurs on or affects historic properties on tribal lands or affects properties of interest to those tribes, and other parties known to have a legitimate interest in the impacts to the permitted activity on historic properties.

21. Discovery of Previously Unknown Remains and Artifacts. If you discover any previously unknown historic, cultural or archeological remains and artifacts while accomplishing the activity authorized by this permit, you must immediately notify the district engineer of what you have found, and to the maximum extent practicable, avoid construction activities that may affect the remains and artifacts until the required coordination has been completed. The district engineer will initiate the Federal, Tribal and state coordination required to determine if the items or remains warrant a recovery effort or if the site is eligible for listing in the National Register of Historic Places.

22. Designated Critical Resource Waters. Critical resource waters include, NOAA-managed marine sanctuaries and marine monuments, and National Estuarine Research Reserves. The district engineer may designate, after notice and opportunity for public comment, additional waters officially designated by a state as having particular environmental or ecological significance, such as outstanding national resource waters or state natural heritage sites. The district engineer may also designate additional critical resource waters after notice and opportunity for public comment.

(a) Discharges of dredged or fill material into waters of the United States are not authorized by NWP 7, 12, 14, 16, 17, 21, 29, 31, 35, 39, 40, 42, 43, 44, 49, 50, 51, and 52 for any activity within, or directly affecting, critical resource waters, including wetlands adjacent to such waters.

(b) For NWPs 3, 8, 10, 13, 15, 18, 19, 22, 23, 25, 27, 28, 30, 33, 34, 36, 37, and 38, notification is required in accordance with general condition 31, for any activity proposed in the designated critical resource waters including wetlands adjacent to those waters. The district engineer may authorize activities under these NWPs only after it is determined that the impacts to the critical resource waters will be no more than minimal.

23. Mitigation. The district engineer will consider the following factors when determining appropriate and practicable mitigation necessary to ensure that adverse effects on the aquatic environment are minimal:

(a) The activity must be designed and constructed to avoid and minimize adverse effects, both temporary and permanent, to waters of the United States to the maximum extent practicable at the project site (i.e., on site).

(b) Mitigation in all its forms (avoiding, minimizing, rectifying, reducing, or compensating for resource losses) will be required to the extent necessary to ensure that the adverse effects to the aquatic environment are minimal.

(c) Compensatory mitigation at a minimum one-for-one ratio will be required for all wetland losses that exceed 1/10-acre and require pre-construction notification, unless the district engineer determines in writing that either some other form of mitigation would be more environmentally appropriate or the adverse effects of the proposed activity are minimal, and provides a project-specific waiver of this requirement. For wetland losses of 1/10-acre or less that require pre-construction notification, the district engineer may determine on a case-by-case basis that compensatory mitigation is required to ensure that the activity results in minimal adverse effects on the aquatic environment. Compensatory mitigation projects provided to offset losses of aquatic resources must comply with the applicable provisions of 33 CFR part 332.

(1) The prospective permittee is responsible for proposing an appropriate compensatory mitigation option if compensatory mitigation is necessary to ensure that the activity results in minimal adverse effects on the aquatic environment.

(2) Since the likelihood of success is greater and the impacts to potentially valuable uplands are reduced, wetland restoration should be the first compensatory mitigation option considered.

(3) If permittee-responsible mitigation is the proposed option, the prospective permittee is responsible for submitting a mitigation plan. A conceptual or detailed mitigation plan may be used by the district engineer to make the decision on the NWP verification request, but a final mitigation plan that addresses the applicable requirements of 33 CFR 332.4(c)(2) – (14) must be approved by the district engineer before the permittee begins work in waters of the United States, unless the district engineer determines that prior approval of the final mitigation plan is not practicable or not necessary to ensure timely completion of the required compensatory mitigation (see 33 CFR 332.3(k)(3)).

(4) If mitigation bank or in-lieu fee program credits are the proposed option, the mitigation plan only needs to address the baseline conditions at the impact site and the number of credits to be provided.

(5) Compensatory mitigation requirements (e.g., resource type and amount to be provided as compensatory mitigation, site protection, ecological performance standards, monitoring requirements) may be addressed through conditions added to the NWP authorization, instead of components of a compensatory mitigation plan.

(d) For losses of streams or other open waters that require pre-construction notification, the district engineer may require compensatory mitigation, such as stream rehabilitation, enhancement, or preservation, to ensure that the activity results in minimal adverse effects on the aquatic environment.

(e) Compensatory mitigation will not be used to increase the acreage losses allowed by the acreage limits of the NWPs. For example, if an NWP has an acreage limit of 1/2-acre, it cannot be used to authorize any project resulting in the loss of greater than 1/2-acre of waters of

the United States, even if compensatory mitigation is provided that replaces or restores some of the lost waters. However, compensatory mitigation can and should be used, as necessary, to ensure that a project already meeting the established acreage limits also satisfies the minimal impact requirement associated with the NWP.

(f) Compensatory mitigation plans for projects in or near streams or other open waters will normally include a requirement for the restoration or establishment, maintenance, and legal protection (e.g., conservation easements) of riparian areas next to open waters. In some cases, riparian areas may be the only compensatory mitigation required. Riparian areas should consist of native species. The width of the required riparian area will address documented water quality or aquatic habitat loss concerns. Normally, the riparian area will be 25 to 50 feet wide on each side of the stream, but the district engineer may require slightly wider riparian areas to address documented water quality or habitat loss concerns. If it is not possible to establish a riparian area on both sides of a stream, or if the waterbody is a lake or coastal waters, then restoring or establishing a riparian area along a single bank or shoreline may be sufficient. Where both wetlands and open waters exist on the project site, the district engineer will determine the appropriate compensatory mitigation (e.g., riparian areas and/or wetlands compensation) based on what is best for the aquatic environment on a watershed basis. In cases where riparian areas are determined to be the most appropriate form of compensatory mitigation, the district engineer may waive or reduce the requirement to provide wetland compensatory mitigation for wetland losses.

(g) Permittees may propose the use of mitigation banks, in-lieu fee programs, or separate permittee-responsible mitigation. For activities resulting in the loss of marine or estuarine resources, permittee-responsible compensatory mitigation may be environmentally preferable if there are no mitigation banks or in-lieu fee programs in the area that have marine or estuarine credits available for sale or transfer to the permittee. For permittee-responsible mitigation, the special conditions of the NWP verification must clearly indicate the party or parties responsible for the implementation and performance of the compensatory mitigation project, and, if required, its long-term management.

(h) Where certain functions and services of waters of the United States are permanently adversely affected, such as the conversion of a forested or scrub-shrub wetland to a herbaceous wetland in a permanently maintained utility line right-of-way, mitigation may be required to reduce the adverse effects of the project to the minimal level.

24. Safety of Impoundment Structures. To ensure that all impoundment structures are safely designed, the district engineer may require non-Federal applicants to demonstrate that the structures comply with established state dam safety criteria or have been designed by qualified persons. The district engineer may also require documentation that the design has been independently reviewed by similarly qualified persons, and appropriate modifications made to ensure safety.

25. Water Quality. Where States and authorized Tribes, or EPA where applicable, have not previously certified compliance of an NWP with CWA Section 401, individual 401 Water Quality Certification must be obtained or waived (see 33 CFR 330.4(c)). The district engineer or State or Tribe may require additional water quality management measures to ensure that the authorized activity does not result in more than minimal degradation of water quality.

26. Coastal Zone Management. In coastal states where an NWP has not previously received a state coastal zone management consistency concurrence, an individual state coastal zone management consistency concurrence must be obtained, or a presumption of concurrence must occur (see 33 CFR 330.4(d)). The district engineer or a State may require additional measures to ensure that the authorized activity is consistent with state coastal zone management requirements.

27. Regional and Case-By-Case Conditions. The activity must comply with any regional conditions that may have been added by the Division Engineer (see 33 CFR 330.4(e)) and with any case specific conditions added by the Corps or by the state, Indian Tribe, or U.S. EPA in its section 401 Water Quality Certification, or by the state in its Coastal Zone Management Act consistency determination.

28. Use of Multiple Nationwide Permits. The use of more than one NWP for a single and complete project is prohibited, except when the acreage loss of waters of the United States authorized by the NWPs does not exceed the acreage limit of the NWP with the highest specified acreage limit. For example, if a road crossing over tidal waters is constructed under NWP 14, with associated bank stabilization authorized by NWP 13, the maximum acreage loss of waters of the United States for the total project cannot exceed 1/3-acre.

29. Transfer of Nationwide Permit Verifications. If the permittee sells the property associated with a nationwide permit verification, the permittee may transfer the nationwide permit verification to the new owner by submitting a letter to the appropriate Corps district office to validate the transfer. A copy of the nationwide permit verification must be attached to the letter, and the letter must contain the following statement and signature:

“When the structures or work authorized by this nationwide permit are still in existence at the time the property is transferred, the terms and conditions of this nationwide permit, including any special conditions, will continue to be binding on the new owner(s) of the property. To validate the transfer of this nationwide permit and the associated liabilities associated with compliance with its terms and conditions, have the transferee sign and date below.”

(Transferee)

(Date)

30. Compliance Certification. Each permittee who receives an NWP verification letter from the Corps must provide a signed certification documenting completion of the authorized activity and any required compensatory mitigation. The success of any required permittee-responsible mitigation, including the achievement of ecological performance standards, will be addressed separately by the district engineer. The Corps will provide the permittee the certification document with the NWP verification letter. The certification document will include:

- (a) A statement that the authorized work was done in accordance with the NWP authorization, including any general, regional, or activity-specific conditions;
- (b) A statement that the implementation of any required compensatory mitigation was completed in accordance with the permit conditions. If credits from a mitigation bank or in-lieu fee program are used to satisfy the compensatory mitigation requirements, the certification must include the documentation required by 33 CFR 332.3(l)(3) to confirm that the permittee secured the appropriate number and resource type of credits; and
- (c) The signature of the permittee certifying the completion of the work and mitigation.

31. Pre-Construction Notification. (a) Timing. Where required by the terms of the NWP, the prospective permittee must notify the district engineer by submitting a pre-construction notification (PCN) as early as possible. The district engineer must determine if the PCN is complete within 30 calendar days of the date of receipt and, if the PCN is determined to be incomplete, notify the prospective permittee within that 30 day period to request the additional information necessary to make the PCN complete. The request must specify the information needed to make the PCN complete. As a general rule, district engineers will request additional information necessary to make the PCN complete only once. However, if the prospective permittee does not provide all of the requested information, then the district engineer will notify the prospective permittee that the PCN is still incomplete and the PCN review process will not commence until all of the requested information has been received by the district engineer. The prospective permittee shall not begin the activity until either:

- (1) He or she is notified in writing by the district engineer that the activity may proceed under the NWP with any special conditions imposed by the district or division engineer; or
- (2) 45 calendar days have passed from the district engineer's receipt of the complete PCN and the prospective permittee has not received written notice from the district or division engineer. However, if the permittee was required to notify the Corps pursuant to general condition 18 that listed species or critical habitat might be affected or in the vicinity of the project, or to notify the Corps pursuant to general condition 20 that the activity may have the potential to cause effects to historic properties, the permittee cannot begin the activity until receiving written notification from the Corps that there is "no effect" on listed species or "no potential to cause effects" on historic properties, or that any consultation required under Section 7 of the Endangered Species Act (see 33 CFR 330.4(f)) and/or Section 106 of the National Historic Preservation (see 33 CFR 330.4(g)) has been completed. Also, work cannot begin under NWPs 21, 49, or 50 until the permittee has received written approval from the Corps. If the proposed activity requires a written waiver to exceed specified limits of an NWP, the permittee may not begin the activity until the district engineer issues the waiver. If the district or division engineer notifies the permittee in writing that an individual permit is required within 45 calendar days of receipt of a complete PCN, the permittee cannot begin the activity until an individual permit has been obtained. Subsequently, the permittee's right to proceed under the NWP may be modified, suspended, or revoked only in accordance with the procedure set forth in 33 CFR 330.5(d)(2).

(b) Contents of Pre-Construction Notification: The PCN must be in writing and include the following information:

- (1) Name, address and telephone numbers of the prospective permittee;
- (2) Location of the proposed project;

(3) A description of the proposed project; the project's purpose; direct and indirect adverse environmental effects the project would cause, including the anticipated amount of loss of water of the United States expected to result from the NWP activity, in acres, linear feet, or other appropriate unit of measure; any other NWP(s), regional general permit(s), or individual permit(s) used or intended to be used to authorize any part of the proposed project or any related activity. The description should be sufficiently detailed to allow the district engineer to determine that the adverse effects of the project will be minimal and to determine the need for compensatory mitigation. Sketches should be provided when necessary to show that the activity complies with the terms of the NWP. (Sketches usually clarify the project and when provided results in a quicker decision. Sketches should contain sufficient detail to provide an illustrative description of the proposed activity (e.g., a conceptual plan), but do not need to be detailed engineering plans);

(4) The PCN must include a delineation of wetlands, other special aquatic sites, and other waters, such as lakes and ponds, and perennial, intermittent, and ephemeral streams, on the project site. Wetland delineations must be prepared in accordance with the current method required by the Corps. The permittee may ask the Corps to delineate the special aquatic sites and other waters on the project site, but there may be a delay if the Corps does the delineation, especially if the project site is large or contains many waters of the United States. Furthermore, the 45 day period will not start until the delineation has been submitted to or completed by the Corps, as appropriate;

(5) If the proposed activity will result in the loss of greater than 1/10-acre of wetlands and a PCN is required, the prospective permittee must submit a statement describing how the mitigation requirement will be satisfied, or explaining why the adverse effects are minimal and why compensatory mitigation should not be required. As an alternative, the prospective permittee may submit a conceptual or detailed mitigation plan.

(6) If any listed species or designated critical habitat might be affected or is in the vicinity of the project, or if the project is located in designated critical habitat, for non-Federal applicants the PCN must include the name(s) of those endangered or threatened species that might be affected by the proposed work or utilize the designated critical habitat that may be affected by the proposed work. Federal applicants must provide documentation demonstrating compliance with the Endangered Species Act; and

(7) For an activity that may affect a historic property listed on, determined to be eligible for listing on, or potentially eligible for listing on, the National Register of Historic Places, for non-Federal applicants the PCN must state which historic property may be affected by the proposed work or include a vicinity map indicating the location of the historic property. Federal applicants must provide documentation demonstrating compliance with Section 106 of the National Historic Preservation Act.

(c) Form of Pre-Construction Notification: The standard individual permit application form (Form ENG 4345) may be used, but the completed application form must clearly indicate that it is a PCN and must include all of the information required in paragraphs (b)(1) through (7) of this general condition. A letter containing the required information may also be used.

(d) Agency Coordination: (1) The district engineer will consider any comments from Federal and state agencies concerning the proposed activity's compliance with the terms and conditions of the NWPs and the need for mitigation to reduce the project's adverse environmental effects to a minimal level.

(2) For all NWP activities that require pre-construction notification and result in the loss of greater than 1/2-acre of waters of the United States, for NWP 21, 29, 39, 40, 42, 43, 44, 50, 51, and 52 activities that require pre-construction notification and will result in the loss of greater than 300 linear feet of intermittent and ephemeral stream bed, and for all NWP 48 activities that require pre-construction notification, the district engineer will immediately provide (e.g., via e-mail, facsimile transmission, overnight mail, or other expeditious manner) a copy of the complete PCN to the appropriate Federal or state offices (U.S. FWS, state natural resource or water quality agency, EPA, State Historic Preservation Officer (SHPO) or Tribal Historic Preservation Office (THPO), and, if appropriate, the NMFS). With the exception of NWP 37, these agencies will have 10 calendar days from the date the material is transmitted to telephone or fax the district engineer notice that they intend to provide substantive, site-specific comments. The comments must explain why the agency believes the adverse effects will be more than minimal. If so contacted by an agency, the district engineer will wait an additional 15 calendar days before making a decision on the pre-construction notification. The district engineer will fully consider agency comments received within the specified time frame concerning the proposed activity's compliance with the terms and conditions of the NWPs, including the need for mitigation to ensure the net adverse environmental effects to the aquatic environment of the proposed activity are minimal. The district engineer will provide no response to the resource agency, except as provided below. The district engineer will indicate in the administrative record associated with each pre-construction notification that the resource agencies' concerns were considered. For NWP 37, the emergency watershed protection and rehabilitation activity may proceed immediately in cases where there is an unacceptable hazard to life or a significant loss of property or economic hardship will occur. The district engineer will consider any comments received to decide whether the NWP 37 authorization should be modified, suspended, or revoked in accordance with the procedures at 33 CFR 330.5.

(3) In cases of where the prospective permittee is not a Federal agency, the district engineer will provide a response to NMFS within 30 calendar days of receipt of any Essential Fish Habitat conservation recommendations, as required by Section 305(b)(4)(B) of the Magnuson-Stevens Fishery Conservation and Management Act.

(4) Applicants are encouraged to provide the Corps with either electronic files or multiple copies of pre-construction notifications to expedite agency coordination.

D. District Engineer's Decision

1. In reviewing the PCN for the proposed activity, the district engineer will determine whether the activity authorized by the NWP will result in more than minimal individual or cumulative adverse environmental effects or may be contrary to the public interest. For a linear project, this determination will include an evaluation of the individual crossings to determine whether they individually satisfy the terms and conditions of the NWP(s), as well as the cumulative effects caused by all of the crossings authorized by NWP. If an applicant requests a waiver of the 300 linear foot limit on impacts to intermittent or ephemeral streams or of an otherwise applicable limit, as provided for in NWPs 13, 21, 29, 36, 39, 40, 42, 43, 44, 50, 51 or 52, the district engineer will only grant the waiver upon a written determination that the NWP activity will result in minimal adverse effects. When making minimal effects determinations the district engineer will consider the direct and indirect effects caused by the NWP activity. The district engineer will also consider site specific factors, such as the environmental setting in the

vicinity of the NWP activity, the type of resource that will be affected by the NWP activity, the functions provided by the aquatic resources that will be affected by the NWP activity, the degree or magnitude to which the aquatic resources perform those functions, the extent that aquatic resource functions will be lost as a result of the NWP activity (e.g., partial or complete loss), the duration of the adverse effects (temporary or permanent), the importance of the aquatic resource functions to the region (e.g., watershed or ecoregion), and mitigation required by the district engineer. If an appropriate functional assessment method is available and practicable to use, that assessment method may be used by the district engineer to assist in the minimal adverse effects determination. The district engineer may add case-specific special conditions to the NWP authorization to address site-specific environmental concerns.

2. If the proposed activity requires a PCN and will result in a loss of greater than 1/10-acre of wetlands, the prospective permittee should submit a mitigation proposal with the PCN. Applicants may also propose compensatory mitigation for projects with smaller impacts. The district engineer will consider any proposed compensatory mitigation the applicant has included in the proposal in determining whether the net adverse environmental effects to the aquatic environment of the proposed activity are minimal. The compensatory mitigation proposal may be either conceptual or detailed. If the district engineer determines that the activity complies with the terms and conditions of the NWP and that the adverse effects on the aquatic environment are minimal, after considering mitigation, the district engineer will notify the permittee and include any activity-specific conditions in the NWP verification the district engineer deems necessary. Conditions for compensatory mitigation requirements must comply with the appropriate provisions at 33 CFR 332.3(k). The district engineer must approve the final mitigation plan before the permittee commences work in waters of the United States, unless the district engineer determines that prior approval of the final mitigation plan is not practicable or not necessary to ensure timely completion of the required compensatory mitigation. If the prospective permittee elects to submit a compensatory mitigation plan with the PCN, the district engineer will expeditiously review the proposed compensatory mitigation plan. The district engineer must review the proposed compensatory mitigation plan within 45 calendar days of receiving a complete PCN and determine whether the proposed mitigation would ensure no more than minimal adverse effects on the aquatic environment. If the net adverse effects of the project on the aquatic environment (after consideration of the compensatory mitigation proposal) are determined by the district engineer to be minimal, the district engineer will provide a timely written response to the applicant. The response will state that the project can proceed under the terms and conditions of the NWP, including any activity-specific conditions added to the NWP authorization by the district engineer.

3. If the district engineer determines that the adverse effects of the proposed work are more than minimal, then the district engineer will notify the applicant either: (a) That the project does not qualify for authorization under the NWP and instruct the applicant on the procedures to seek authorization under an individual permit; (b) that the project is authorized under the NWP subject to the applicant's submission of a mitigation plan that would reduce the adverse effects on the aquatic environment to the minimal level; or (c) that the project is authorized under the NWP with specific modifications or conditions. Where the district engineer determines that mitigation is required to ensure no more than minimal adverse effects occur to the aquatic environment, the activity will be authorized within the 45-day PCN period, with activity-specific

conditions that state the mitigation requirements. The authorization will include the necessary conceptual or detailed mitigation or a requirement that the applicant submit a mitigation plan that would reduce the adverse effects on the aquatic environment to the minimal level. When mitigation is required, no work in waters of the United States may occur until the district engineer has approved a specific mitigation plan or has determined that prior approval of a final mitigation plan is not practicable or not necessary to ensure timely completion of the required compensatory mitigation.

FURTHER INFORMATION

1. District Engineers have authority to determine if an activity complies with the terms and conditions of an NWP.
2. NWPs do not obviate the need to obtain other federal, state, or local permits, approvals, or authorizations required by law.
3. NWPs do not grant any property rights or exclusive privileges.
4. NWPs do not authorize any injury to the property or rights of others.
5. NWPs do not authorize interference with any existing or proposed Federal project.

DEFINITIONS

Best management practices (BMPs): Policies, practices, procedures, or structures implemented to mitigate the adverse environmental effects on surface water quality resulting from development. BMPs are categorized as structural or non-structural.

Compensatory mitigation: The restoration (re-establishment or rehabilitation), establishment (creation), enhancement, and/or in certain circumstances preservation of aquatic resources for the purposes of offsetting unavoidable adverse impacts which remain after all appropriate and practicable avoidance and minimization has been achieved.

Currently serviceable: Useable as is or with some maintenance, but not so degraded as to essentially require reconstruction.

Direct effects: Effects that are caused by the activity and occur at the same time and place.

Discharge: The term “discharge” means any discharge of dredged or fill material.

Enhancement: The manipulation of the physical, chemical, or biological characteristics of an aquatic resource to heighten, intensify, or improve a specific aquatic resource function(s). Enhancement results in the gain of selected aquatic resource function(s), but may also lead to a decline in other aquatic resource function(s). Enhancement does not result in a gain in aquatic resource area.

Ephemeral stream: An ephemeral stream has flowing water only during, and for a short duration after, precipitation events in a typical year. Ephemeral stream beds are located above the water table year-round. Groundwater is not a source of water for the stream. Runoff from rainfall is the primary source of water for stream flow.

Establishment (creation): The manipulation of the physical, chemical, or biological characteristics present to develop an aquatic resource that did not previously exist at an upland site. Establishment results in a gain in aquatic resource area.

High Tide Line: The line of intersection of the land with the water’s surface at the maximum height reached by a rising tide. The high tide line may be determined, in the absence

of actual data, by a line of oil or scum along shore objects, a more or less continuous deposit of fine shell or debris on the foreshore or berm, other physical markings or characteristics, vegetation lines, tidal gages, or other suitable means that delineate the general height reached by a rising tide. The line encompasses spring high tides and other high tides that occur with periodic frequency but does not include storm surges in which there is a departure from the normal or predicted reach of the tide due to the piling up of water against a coast by strong winds such as those accompanying a hurricane or other intense storm.

Historic Property: Any prehistoric or historic district, site (including archaeological site), building, structure, or other object included in, or eligible for inclusion in, the National Register of Historic Places maintained by the Secretary of the Interior. This term includes artifacts, records, and remains that are related to and located within such properties. The term includes properties of traditional religious and cultural importance to an Indian tribe or Native Hawaiian organization and that meet the National Register criteria (36 CFR part 60).

Independent utility: A test to determine what constitutes a single and complete non-linear project in the Corps regulatory program. A project is considered to have independent utility if it would be constructed absent the construction of other projects in the project area. Portions of a multi-phase project that depend upon other phases of the project do not have independent utility. Phases of a project that would be constructed even if the other phases were not built can be considered as separate single and complete projects with independent utility.

Indirect effects: Effects that are caused by the activity and are later in time or farther removed in distance, but are still reasonably foreseeable.

Intermittent stream: An intermittent stream has flowing water during certain times of the year, when groundwater provides water for stream flow. During dry periods, intermittent streams may not have flowing water. Runoff from rainfall is a supplemental source of water for stream flow.

Loss of waters of the United States: Waters of the United States that are permanently adversely affected by filling, flooding, excavation, or drainage because of the regulated activity. Permanent adverse effects include permanent discharges of dredged or fill material that change an aquatic area to dry land, increase the bottom elevation of a waterbody, or change the use of a waterbody. The acreage of loss of waters of the United States is a threshold measurement of the impact to jurisdictional waters for determining whether a project may qualify for an NWP; it is not a net threshold that is calculated after considering compensatory mitigation that may be used to offset losses of aquatic functions and services. The loss of stream bed includes the linear feet of stream bed that is filled or excavated. Waters of the United States temporarily filled, flooded, excavated, or drained, but restored to pre-construction contours and elevations after construction, are not included in the measurement of loss of waters of the United States. Impacts resulting from activities eligible for exemptions under Section 404(f) of the Clean Water Act are not considered when calculating the loss of waters of the United States.

Non-tidal wetland: A non-tidal wetland is a wetland that is not subject to the ebb and flow of tidal waters. The definition of a wetland can be found at 33 CFR 328.3(b). Non-tidal wetlands contiguous to tidal waters are located landward of the high tide line (i.e., spring high tide line).

Open water: For purposes of the NWPs, an open water is any area that in a year with normal patterns of precipitation has water flowing or standing above ground to the extent that an ordinary high water mark can be determined. Aquatic vegetation within the area of standing or

flowing water is either non-emergent, sparse, or absent. Vegetated shallows are considered to be open waters. Examples of “open waters” include rivers, streams, lakes, and ponds.

Ordinary High Water Mark: An ordinary high water mark is a line on the shore established by the fluctuations of water and indicated by physical characteristics, or by other appropriate means that consider the characteristics of the surrounding areas (see 33 CFR 328.3(e)).

Perennial stream: A perennial stream has flowing water year-round during a typical year. The water table is located above the stream bed for most of the year. Groundwater is the primary source of water for stream flow. Runoff from rainfall is a supplemental source of water for stream flow.

Practicable: Available and capable of being done after taking into consideration cost, existing technology, and logistics in light of overall project purposes.

Pre-construction notification: A request submitted by the project proponent to the Corps for confirmation that a particular activity is authorized by nationwide permit. The request may be a permit application, letter, or similar document that includes information about the proposed work and its anticipated environmental effects. Pre-construction notification may be required by the terms and conditions of a nationwide permit, or by regional conditions. A pre-construction notification may be voluntarily submitted in cases where pre-construction notification is not required and the project proponent wants confirmation that the activity is authorized by nationwide permit.

Preservation: The removal of a threat to, or preventing the decline of, aquatic resources by an action in or near those aquatic resources. This term includes activities commonly associated with the protection and maintenance of aquatic resources through the implementation of appropriate legal and physical mechanisms. Preservation does not result in a gain of aquatic resource area or functions.

Re-establishment: The manipulation of the physical, chemical, or biological characteristics of a site with the goal of returning natural/historic functions to a former aquatic resource. Re-establishment results in rebuilding a former aquatic resource and results in a gain in aquatic resource area and functions.

Rehabilitation: The manipulation of the physical, chemical, or biological characteristics of a site with the goal of repairing natural/historic functions to a degraded aquatic resource. Rehabilitation results in a gain in aquatic resource function, but does not result in a gain in aquatic resource area.

Restoration: The manipulation of the physical, chemical, or biological characteristics of a site with the goal of returning natural/historic functions to a former or degraded aquatic resource. For the purpose of tracking net gains in aquatic resource area, restoration is divided into two categories: re-establishment and rehabilitation.

Riffle and pool complex: Riffle and pool complexes are special aquatic sites under the 404(b)(1) Guidelines. Riffle and pool complexes sometimes characterize steep gradient sections of streams. Such stream sections are recognizable by their hydraulic characteristics. The rapid movement of water over a coarse substrate in riffles results in a rough flow, a turbulent surface, and high dissolved oxygen levels in the water. Pools are deeper areas associated with riffles. A slower stream velocity, a streaming flow, a smooth surface, and a finer substrate characterize pools.

Riparian areas: Riparian areas are lands adjacent to streams, lakes, and estuarine-marine shorelines. Riparian areas are transitional between terrestrial and aquatic ecosystems, through

which surface and subsurface hydrology connects riverine, lacustrine, estuarine, and marine waters with their adjacent wetlands, non-wetland waters, or uplands. Riparian areas provide a variety of ecological functions and services and help improve or maintain local water quality. (See general condition 23.)

Shellfish seeding: The placement of shellfish seed and/or suitable substrate to increase shellfish production. Shellfish seed consists of immature individual shellfish or individual shellfish attached to shells or shell fragments (i.e., spat on shell). Suitable substrate may consist of shellfish shells, shell fragments, or other appropriate materials placed into waters for shellfish habitat.

Single and complete linear project: A linear project is a project constructed for the purpose of getting people, goods, or services from a point of origin to a terminal point, which often involves multiple crossings of one or more waterbodies at separate and distant locations. The term “single and complete project” is defined as that portion of the total linear project proposed or accomplished by one owner/developer or partnership or other association of owners/developers that includes all crossings of a single water of the United States (i.e., a single waterbody) at a specific location. For linear projects crossing a single or multiple waterbodies several times at separate and distant locations, each crossing is considered a single and complete project for purposes of NWP authorization. However, individual channels in a braided stream or river, or individual arms of a large, irregularly shaped wetland or lake, etc., are not separate waterbodies, and crossings of such features cannot be considered separately.

Single and complete non-linear project: For non-linear projects, the term “single and complete project” is defined at 33 CFR 330.2(i) as the total project proposed or accomplished by one owner/developer or partnership or other association of owners/developers. A single and complete non-linear project must have independent utility (see definition of “independent utility”). Single and complete non-linear projects may not be “piecemealed” to avoid the limits in an NWP authorization.

Stormwater management: Stormwater management is the mechanism for controlling stormwater runoff for the purposes of reducing downstream erosion, water quality degradation, and flooding and mitigating the adverse effects of changes in land use on the aquatic environment.

Stormwater management facilities: Stormwater management facilities are those facilities, including but not limited to, stormwater retention and detention ponds and best management practices, which retain water for a period of time to control runoff and/or improve the quality (i.e., by reducing the concentration of nutrients, sediments, hazardous substances and other pollutants) of stormwater runoff.

Stream bed: The substrate of the stream channel between the ordinary high water marks. The substrate may be bedrock or inorganic particles that range in size from clay to boulders. Wetlands contiguous to the stream bed, but outside of the ordinary high water marks, are not considered part of the stream bed.

Stream channelization: The manipulation of a stream’s course, condition, capacity, or location that causes more than minimal interruption of normal stream processes. A channelized stream remains a water of the United States.

Structure: An object that is arranged in a definite pattern of organization. Examples of structures include, without limitation, any pier, boat dock, boat ramp, wharf, dolphin, weir, boom, breakwater, bulkhead, revetment, riprap, jetty, artificial island, artificial reef, permanent

mooring structure, power transmission line, permanently moored floating vessel, piling, aid to navigation, or any other manmade obstacle or obstruction.

Tidal wetland: A tidal wetland is a wetland (i.e., water of the United States) that is inundated by tidal waters. The definitions of a wetland and tidal waters can be found at 33 CFR 328.3(b) and 33 CFR 328.3(f), respectively. Tidal waters rise and fall in a predictable and measurable rhythm or cycle due to the gravitational pulls of the moon and sun. Tidal waters end where the rise and fall of the water surface can no longer be practically measured in a predictable rhythm due to masking by other waters, wind, or other effects. Tidal wetlands are located channelward of the high tide line, which is defined at 33 CFR 328.3(d).

Vegetated shallows: Vegetated shallows are special aquatic sites under the 404(b)(1) Guidelines. They are areas that are permanently inundated and under normal circumstances have rooted aquatic vegetation, such as seagrasses in marine and estuarine systems and a variety of vascular rooted plants in freshwater systems.

Waterbody: For purposes of the NWPs, a waterbody is a jurisdictional water of the United States. If a jurisdictional wetland is adjacent – meaning bordering, contiguous, or neighboring – to a waterbody determined to be a water of the United States under 33 CFR 328.3(a)(1)-(6), that waterbody and its adjacent wetlands are considered together as a single aquatic unit (see 33 CFR 328.4(c)(2)). Examples of “waterbodies” include streams, rivers, lakes, ponds, and wetlands.

Final Regional Conditions 2012

NOTICE ABOUT WEB LINKS IN THIS DOCUMENT:

The web links (both internal to our District and any external links to collaborating agencies) in this document are valid at the time of publication. However, the Wilmington District Regulatory Program web page addresses, as with other agency web sites, may change over the timeframe of the five-year Nationwide Permit renewal cycle, in response to policy mandates or technology advances. While we will make every effort to check on the integrity of our web links and provide re-direct pages whenever possible, we ask that you report any broken links to us so we can keep the page information current and usable. We apologize in advanced for any broken links that you may encounter, and we ask that you navigate from the regulatory home page (wetlands and stream permits) of the Wilmington District Corps of Engineers, to the "Permits" section of our web site to find links for pages that cannot be found by clicking directly on the listed web link in this document.

Final 2012 Regional Conditions for Nationwide Permits (NWP) in the Wilmington District

1.0 Excluded Waters

The Corps has identified waters that will be excluded from the use of all NWP's during certain timeframes. These waters are:

1.1 Anadromous Fish Spawning Areas

Waters of the United States identified by either the North Carolina Division of Marine Fisheries (NCDMF) or the North Carolina Wildlife Resources Commission (NCWRC) as anadromous fish spawning areas are excluded during the period between February 15 and June 30, without prior written approval from NCDMF or NCWRC and the Corps.

1.2 Trout Waters Moratorium

Waters of the United States in the twenty-five designated trout counties of North Carolina are excluded during the period between October 15 and April 15 without prior written approval from the NCWRC. (See Section 2.7 for a list of the twenty-five trout counties).

1.3 Sturgeon Spawning Areas as Designated by the National Marine Fisheries Service (NMFS)

Waters of the United States designated as sturgeon spawning areas are excluded during the period between February 1 and June 30, without prior written approval from the NMFS.

2.0 Waters Requiring Additional Notification

The Corps has identified waters that will be subject to additional notification requirements for activities authorized by all NWP's. These waters are:

2.1 Western NC Counties that Drain to Designated Critical Habitat

For proposed activities within Waters of the U.S. that require a Pre-Construction Notification pursuant to General Condition 31 (PCN) and are located in the sixteen counties listed below, applicants must provide a copy of the PCN to the US Fish and Wildlife Service, 160 Zillicoa Street, Asheville, North Carolina 28801. This PCN must be sent concurrently to the US Fish and Wildlife Service and the Corps Asheville Regulatory Field Office. Please see General Condition 18 for specific notification requirements related to Federally Endangered Species and the following website for information on the location of designated critical habitat.

Counties with tributaries that drain to designated critical habitat that require notification to the Asheville US Fish and Wildlife Service: Avery, Cherokee, Forsyth, Graham, Haywood, Henderson, Jackson, Macon Mecklenburg, Mitchell, Stokes, Surry, Swain, Transylvania, Union and Yancey.

Website and office addresses for Endangered Species Act Information:

The Wilmington District has developed the following website for applicants which provides guidelines on how to review linked websites and maps in order to fulfill NWP general condition 18 requirements: <http://www.saw.usace.army.mil/wetlands/ESA>

Applicants who do not have internet access may contact the appropriate US Fish and Wildlife Service offices listed below or the US Army Corps of Engineers at (910) 251- 4633:

US Fish and Wildlife Service
Asheville Field Office
160 Zillicoa Street
Asheville, NC 28801
Telephone: (828) 258-3939

Asheville US Fish and Wildlife Service Office counties: All counties west of and including Anson, Stanly, Davidson, Forsyth and Stokes Counties

US Fish and Wildlife Service
Raleigh Field Office
Post Office Box 33726
Raleigh, NC 27636-3726
Telephone: (919) 856-4520

Raleigh US Fish and Wildlife Service Office counties: all counties east of and including Richmond, Montgomery, Randolph, Guilford, and Rockingham Counties.

2.2 Special Designation Waters

Prior to the use of any NWP in any of the following identified waters and contiguous wetlands in North Carolina, applicants must comply with Nationwide Permit General Condition 31 (PCN). The North Carolina waters and contiguous wetlands that require additional notification requirements are:

“Outstanding Resource Waters” (ORW) or “High Quality Waters” (HQW) as designated by the North Carolina Environmental Management Commission; “Inland Primary Nursery Areas” (IPNA) as designated by the NCWRC; “Contiguous Wetlands” as defined by the North Carolina Environmental Management Commission; or “Primary Nursery Areas” (PNA) as designated by the North Carolina Marine Fisheries Commission.

2.3 Coastal Area Management Act (CAMA) Areas of Environmental Concern

Non-federal applicants for any NWP in a designated “Area of Environmental Concern” (AEC) in the twenty (20) counties of Eastern North Carolina covered by the North Carolina Coastal Area Management Act (CAMA) must also obtain the required CAMA permit. Development activities for non-federal projects may not commence until a copy of the approved CAMA permit is furnished to the appropriate Wilmington District Regulatory Field Office (Wilmington Field Office – 69 Darlington Avenue, Wilmington, NC 28403 or Washington Field Office – 2407 West 5th Street, Washington, NC 27889).

2.4 Barrier Islands

Prior to the use of any NWP on a barrier island of North Carolina, applicants must comply with Nationwide Permit General Condition 31 (PCN).

2.5 Mountain or Piedmont Bogs

Prior to the use of any NWP in a Bog classified by the North Carolina Wetland Assessment Methodology (NCWAM), applicants shall comply with Nationwide Permit General Condition 31 (PCN). The latest version of NCWAM is located on the NC DWQ web site at: <http://portal.ncdenr.org/web/wq/swp/ws/pdu/ncwam> .

2.6 Animal Waste Facilities

Prior to use of any NWP for construction of animal waste facilities in waters of the US, including wetlands, applicants shall comply with Nationwide Permit General Condition 31 (PCN).

2.7 Trout Waters

Prior to any discharge of dredge or fill material into streams or waterbodies within the twenty-five (25) designated trout counties of North Carolina, the applicant shall comply with Nationwide Permit General Condition 31 (PCN). The applicant shall also provide a copy of the notification to the appropriate NCWRC office to facilitate the determination of any potential

impacts to designated Trout Waters. Notification to the Corps of Engineers will include a statement with the name of the NCWRC biologist contacted, the date of the notification, the location of work, a delineation of wetlands, a discussion of alternatives to working in the mountain trout waters, why alternatives were not selected, and a plan to provide compensatory mitigation for all unavoidable adverse impacts to mountain trout waters.

NCWRC and NC Trout Counties

Western Piedmont Region Coordinator	Alleghany	Caldwell	Watauga
20830 Great Smoky Mtn. Expressway	Ashe	Mitchell	Wilkes
Waynesville, NC 28786	Avery	Stokes	
Telephone: (828) 452-2546	Burke	Surry	

Mountain Region Coordinator	Buncombe	Henderson	Polk
20830 Great Smoky Mtn. Expressway	Cherokee	Jackson	Rutherford
Waynesville, NC 28786	Clay	Macon	Swain
Telephone: (828) 452-2546	Graham	Madison	Transylvania
Fax: (828) 452-7772	Haywood	McDowell	Yancey

3.0 List of Corps Regional Conditions for All Nationwide Permits

The following conditions apply to all Nationwide Permits in the Wilmington District:

3.1 Limitation of Loss of Perennial Stream Bed

NWPs may not be used for activities that may result in the loss or degradation of greater than 300 total linear feet of perennial, intermittent or ephemeral stream, unless the District Commander has waived the 300 linear foot limit for ephemeral and intermittent streams on a case-by-case basis and he determines that the proposed activity will result in minimal individual and cumulative adverse impacts to the aquatic environment. Loss of stream includes the linear feet of stream bed that is filled, excavated, or flooded by the proposed activity. Waivers for the loss of ephemeral and intermittent streams must be in writing and documented by appropriate/accepted stream quality assessments*. This waiver only applies to the 300 linear feet threshold for NWPs.

*NOTE: Applicants should utilize the most current methodology prescribed by Wilmington District to assess stream function and quality. Information can be found at:

<http://www.saw.usace.army.mil/wetlands/permits/nwp/nwp2012> (see “Quick Links”)

3.2 Mitigation for Loss of Stream Bed

For any NWP that results in a loss of more than 150 linear feet of perennial and/or ephemeral/intermittent stream, the applicant shall provide a mitigation proposal to compensate for more than minimal individual and cumulative adverse impacts to the aquatic environment. For stream losses less than 150 linear feet, that require a PCN, the District Commander may determine, on a case-by-case basis that compensatory mitigation is required to ensure that the activity results in minimal adverse effect on the aquatic environment.

3.3 Pre-construction Notification for Loss of Streambed Exceeding 150 Feet.

Prior to use of any NWP for any activity which impacts more than 150 total linear feet of perennial stream or ephemeral/ intermittent stream, the applicant must comply with Nationwide Permit General Condition 31 (PCN). This applies to NWPs that do not have specific notification requirements. If a NWP has specific notification requirements, the requirements of the NWP should be followed.

3.4 Restriction on Use of Live Concrete

For all NWPs which allow the use of concrete as a building material, live or fresh concrete, including bags of uncured concrete, may not come into contact with the water in or entering into waters of the US. Water inside coffer dams or casings that has been in contact with wet concrete shall only be returned to waters of the US when it is no longer poses a threat to aquatic organisms.

3.5 Requirements for Using Riprap for Bank Stabilization

For all NWPs that allow for the use of riprap material for bank stabilization, the following measures shall be applied:

3.5.1. Filter cloth must be placed underneath the riprap as an additional requirement of its use in North Carolina waters.

3.5.2. The placement of riprap shall be limited to the areas depicted on submitted work plan drawings.

3.5.3. The riprap material shall be clean and free from loose dirt or any pollutant except in trace quantities that would not have an adverse environmental effect.

3.5.4. It shall be of a size sufficient to prevent its movement from the authorized alignment by natural forces under normal conditions.

3.5.5. The riprap material shall consist of clean rock or masonry material such as, but not limited to, granite, marl, or broken concrete.

3.5.6. A waiver from the specifications in this Regional Condition may be requested in writing. The waiver will only be issued if it can be demonstrated that the impacts of complying with this Regional condition would result in greater adverse impacts to the aquatic environment.

3.6 Safe Passage Requirements for Culvert Placement

For all NWP's that involve the construction/installation of culverts, measures will be included in the construction/installation that will promote the safe passage of fish and other aquatic organisms. The dimension, pattern, and profile of the stream above and below a pipe or culvert should not be modified by widening the stream channel or by reducing the depth of the stream in connection with the construction activity. The width, height, and gradient of a proposed culvert should be such as to pass the average historical low flow and spring flow without adversely altering flow velocity. Spring flow should be determined from gage data, if available. In the absence of such data, bankfull flow can be used as a comparable level.

In the twenty (20) counties of North Carolina designated as coastal counties by the Coastal Area Management Act (CAMA): All pipes/culverts must be sufficiently sized to allow for the burial of the bottom of the pipe/culvert at least one foot below normal bed elevation when they are placed within the Public Trust Area of Environmental Concern (AEC) and/or the Estuarine Waters AEC as designated by CAMA, and/or all streams appearing as blue lines on United States Geological Survey (USGS) 7.5-minute quadrangle maps.

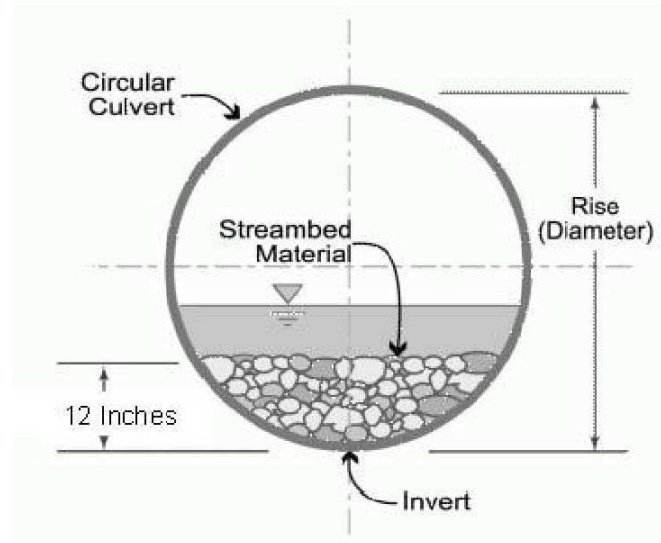

In all other counties: Culverts greater than 48 inches in diameter will be buried at least one foot below the bed of the stream. Culverts 48 inches in diameter or less shall be buried or placed on the stream bed as practicable and appropriate to maintain aquatic passage, and every effort shall be made to maintain the existing channel slope. The bottom of the culvert must be placed at a

depth below the natural stream bottom to provide for passage during drought or low flow conditions.

Culverts are to be designed and constructed in a manner that minimizes destabilization and head cutting. Destabilizing the channel and head cutting upstream should be considered and appropriate actions incorporated in the design and placement of the culvert.

A waiver from the depth specifications in this condition may be requested in writing. The waiver will be issued if it can be demonstrated that the proposal would result in the least impacts to the aquatic environment.

All counties: Culverts placed within riparian and/or riverine wetlands must be installed in a manner that does not restrict the flow and circulation patterns of waters of the United States. Culverts placed across wetland fills purely for the purposes of equalizing surface water do not have to be buried.

3.7 Notification to NCDENR Shellfish Sanitation Section

Applicants shall notify the NCDENR Shellfish Sanitation Section prior to dredging in or removing sediment from an area closed to shell fishing where the effluent may be released to an area open for shell fishing or swimming in order to avoid contamination from the disposal area and cause a temporary shellfish closure to be made. Such notification shall also be provided to the appropriate Corps of Engineers Regulatory Field Office. Any disposal of sand to the ocean beach should occur between November 1 and April 30 when recreational usage is low. Only clean sand should be used and no dredged sand from closed shell fishing areas may be used. If beach disposal were to occur at times other than stated above or if sand from a closed shell fishing area is to be used, a swimming advisory shall be posted, and a press release shall be issued by the permittee.

3.8 Preservation of Submerged Aquatic Vegetation

Adverse impacts to Submerged Aquatic Vegetation (SAV) are not authorized by any NWP within any of the twenty coastal counties defined by North Carolina's Coastal Area Management Act of 1974 (CAMA).

3.9 Sedimentation and Erosion Control Structures and Measures

3.9.1. All PCNs will identify and describe sedimentation and erosion control structures and measures proposed for placement in waters of the US. The structures and measures should be depicted on maps, surveys or drawings showing location and impacts to jurisdictional wetlands and streams.

Water Quality Certification No. 3883

GENERAL CERTIFICATION FOR PROJECTS ELIGIBLE FOR U.S. ARMY CORPS OF ENGINEERS NATIONWIDE PERMIT NUMBERS: 3 (MAINTENANCE), 4 (FISH AND WILDLIFE HARVESTING, ENHANCEMENT, AND ATTRACTION DEVICES AND ACTIVITIES), 5 (SCIENTIFIC MEASUREMENT DEVICES—25 CUBIC YARDS FOR WEIRS AND FLUMES), 6 (SURVEY ACTIVITIES—25 CUBIC YARDS FOR TEMPORARY PADS), 7 (OUTFALL STRUCTURES AND ASSOCIATED INTAKE STRUCTURES), 19 (MINOR DREDGING), 20 (OIL SPILL CLEANUP), 22 (REMOVAL OF VESSELS), 25 (STRUCTURAL DISCHARGE), 30(MOIST SOIL MANAGEMENT FOR WILDLIFE), 32 (COMPLETED ENFORCEMENT ACTIONS), 36 (BOAT RAMPS [IN NONWETLAND SITES]), AND REGIONAL PERMIT 197800056 (PIERS, DOCKS AND BOATHOUSES), AND REGIONAL PERMIT 197800125 (BOAT RAMPS) AND RIPARIAN AREA PROTECTION RULES (BUFFER RULES)

Water Quality Certification Number 3883 is issued in conformity with the requirements of Section 401, Public Laws 92-500 and 95-217 of the United States and subject to the North Carolina Division of Water Quality (DWQ) Regulations in 15 NCAC 02H .0500 and 15 NCAC 02B .0200 for the discharge of fill material to waters and wetland areas which are waters of the United States as described in 33 CFR 330 Appendix A (B) (3, 4, 5, 6, 7, 19, 20, 22, 25, 30, 32, and 36) and Regional Permits 197800056 and 19780125 and for the Riparian Area Protection Rules (Buffer Rules) in 15A NCAC 02B .0200.

The State of North Carolina certifies that the specified category of activity will not violate applicable portions of Sections 301, 302, 303, 306 and 307 of the Public Laws 92-500 and 95-217 if conducted in accordance with the conditions hereinafter set forth.

Activities meeting any one (1) of the following thresholds or circumstances require *written approval* for a 401 Water Quality Certification from the Division of Water Quality (the "Division"):

- a. Impacts equal to or greater than 40 linear feet of additional permanent stream impact (including stream relocations) at an existing stream impact location; or
- b. Temporary or permanent impacts equal to or greater than one-tenth (1/10) of an acre of wetlands; or
- c. Any impact associated with a Notice of Violation or an enforcement action for violation(s) of DWQ Wetland Rules (15A NCAC 02H .0500), Isolated Wetland Rules (15A NCAC 02H .1300), DWQ Surface Water or Wetland Standards, or Riparian Buffer Rules (15A NCAC 02B .0200); or
- d. Any impacts to streams and/or buffers in the Neuse, Tar-Pamlico, or Catawba River Basins or in the Randleman, Jordan or Goose Creek Watersheds (or any other basin or watershed with Riparian Area Protection Rules [Buffer Rules] in effect at the time of application) *unless* the activities are listed as "EXEMPT" from these rules or a Buffer Authorization Certificate is issued through N.C. Division of Coastal Management (DCM) delegation for "ALLOWABLE" activities.

In accordance with North Carolina General Statute 143-215.3D(e), written approval for a 401 Water Quality General Certification must include the appropriate fee. If a project also requires a CAMA Permit, then one payment to both agencies shall be submitted and will be the higher of the two fees.

Activities included in this General Certification that do not meet one of the thresholds listed above do not require written approval from the Division as long as they comply with the Conditions of Certification listed below. If any of these Conditions cannot be met, then written approval from the Division is required.

Water Quality Certification No. 3883

Conditions of Certification:

1. No Impacts Beyond those Authorized in the Written Approval or Beyond the Threshold of Use of this Certification

No waste, spoil, solids, or fill of any kind shall occur in wetlands, waters, or riparian areas beyond the footprint of the impacts depicted in the Pre-Construction Notification, as authorized in the written approval from the Division or beyond the thresholds established for use of this Certification without written authorization, including incidental impacts. All construction activities, including the design, installation, operation, and maintenance of sediment and erosion control Best Management Practices shall be performed so that no violations of state water quality standards, statutes, or rules occur. Approved plans and specifications for this project are incorporated by reference and are enforceable parts of this permit.

2. Standard Erosion and Sediment Control Practices

Erosion and sediment control practices must be in full compliance with all specifications governing the proper design, installation and operation and maintenance of such Best Management Practices and if applicable, comply with the specific conditions and requirements of the NPDES Construction Stormwater Permit issued to the site:

- a. Design, installation, operation, and maintenance of the sediment and erosion control measures must be such that they equal or exceed the requirements specified in the most recent version of the *North Carolina Sediment and Erosion Control Manual*. The devices shall be maintained on all construction sites, borrow sites, and waste pile (spoil) projects, including contractor-owned or leased borrow pits associated with the project.
- b. For borrow pit sites, the erosion and sediment control measures must be designed, installed, operated, and maintained in accordance with the most recent version of the *North Carolina Surface Mining Manual*.
- c. Reclamation measures and implementation must comply with the reclamation in accordance with the requirements of the Sedimentation Pollution Control Act and the Mining Act of 1971.
- d. Sufficient materials required for stabilization and/or repair of erosion control measures and stormwater routing and treatment shall be on site at all times.
- e. If the project occurs in waters or watersheds classified as Primary Nursery Areas (PNAs), SA, WS-I, WS-II, High Quality (HQW), or Outstanding Resource (ORW) waters, then the sedimentation and erosion control designs must comply with the requirements set forth in 15A NCAC 04B .0124, *Design Standards in Sensitive Watersheds*.

3. No Sediment and Erosion Control Measures in Wetlands or Waters

Sediment and erosion control measures shall not be placed in wetlands or waters. Exceptions to this condition require application submittal to and written approval by the Division. If placement of sediment and erosion control devices in wetlands and waters is unavoidable, then design and placement of temporary erosion control measures shall not be conducted in a manner that may result in dis-equilibrium of wetlands, stream beds, or banks, adjacent to or upstream and downstream of the above structures. All sediment and erosion control devices shall be removed and the natural grade restored within two (2) months of the date that the Division of Land Resources (DLR) or locally delegated program has released the specific area within the project.

Water Quality Certification No. 3883

4. Construction Stormwater Permit NCG010000

An NPDES Construction Stormwater Permit is required for construction projects that disturb one (1) or more acres of land. This Permit allows stormwater to be discharged during land disturbing construction activities as stipulated in the conditions of the permit. If your project is covered by this permit, full compliance with permit conditions including the erosion & sedimentation control plan, inspections and maintenance, self-monitoring, record keeping and reporting requirements is required. A copy of the general permit (NCG010000), inspection log sheets, and other information may be found at <http://portal.ncdenr.org/web/wq/ws/su/npdessw#tab-w>.

The North Carolina Department of Transportation (NCDOT) shall be required to be in full compliance with the conditions related to construction activities within the most recent version of their individual NPDES (NCS000250) stormwater permit.

5. Work in the Dry

All work in or adjacent to stream waters shall be conducted so that the flowing stream does not come in contact with the disturbed area. Approved best management practices from the most current version of the NC Sediment and Erosion Control Manual, or the NC DOT Construction and Maintenance Activities Manual, such as sandbags, rock berms, cofferdams, and other diversion structures shall be used to minimize excavation in flowing water. Exceptions to this condition require application submittal to and written approval by the Division.

6. Construction Moratoriums and Coordination

If activities must occur during periods of high biological activity (i.e. sea turtle nesting, fish spawning, or bird nesting), then biological monitoring may be required at the request of other state or federal agencies and coordinated with these activities.

All moratoriums on construction activities established by the NC Wildlife Resources Commission (WRC), US Fish and Wildlife Service (USFWS), NC Division of Marine Fisheries (DMF), or National Marine Fisheries Service (NMFS) to lessen impacts on trout, anadromous fish, larval/post-larval fishes and crustaceans, or other aquatic species of concern shall be implemented. Exceptions to this condition require written approval by the resource agency responsible for the given moratorium.

Work within the twenty-five (25) designated trout counties or identified state or federal endangered or threatened species habitat shall be coordinated with the appropriate WRC, USFWS, NMFS, and/or DMF personnel.

7. Riparian Area Protection Rules (Buffer Rules)

Activities located in the protected riparian areas (whether jurisdictional wetlands or not), within the Neuse, Tar-Pamlico, or Catawba River Basins or in the Randleman, Jordan, or Goose Creek Watersheds (or any other basin or watershed with buffer rules) shall be limited to "uses" identified within and constructed in accordance with 15A NCAC 02B .0233, .0259, .0243, .0250, .0267 and .0605, and shall be located, designed, constructed, and maintained to have minimal disturbance to protect water quality to the maximum extent practicable through the use of best management practices. All buffer rule requirements, including diffuse flow requirements, must be met.

Water Quality Certification No. 3883

8. Placement of Culverts and Other Structures in Waters and Wetlands

Culverts required for this project shall be designed and installed in such a manner that the original stream profiles are not altered and allow for aquatic life movement during low flows. Existing stream dimensions (including the cross section dimensions, pattern, and longitudinal profile) must be maintained above and below locations of each culvert.

Placement of culverts and other structures in waters and streams must be below the elevation of the streambed by one foot for all culverts with a diameter greater than 48 inches, and 20 percent of the culvert diameter for culverts having a diameter less than or equal to 48 inches, to allow low flow passage of water and aquatic life.

When topographic constraints indicate culvert slopes of greater than 5%, culvert burial is not required, provided that all alternative options for flattening the slope have been investigated and aquatic life movement/ connectivity has been provided when possible (rock ladders, crossvanes, etc). Notification to the Division including supporting documentation to include a location map of the culvert, culvert profile drawings, and slope calculations shall be provided to the Division 60 days prior to the installation of the culvert.

When bedrock is present in culvert locations, culvert burial is not required provided that there is sufficient documentation of the presence of bedrock. Notification to the Division including supporting documentation such as, but not limited to, a location map of the culvert, geotechnical reports, photographs, etc shall be provided to the Division a minimum of 60 days prior to the installation of the culvert. If bedrock is discovered during construction, then the Division shall be notified by phone or email within 24 hours of discovery.

If other site-specific topographic constraints preclude the ability to bury the culverts as described above and/or it can be demonstrated that burying the culvert would result in destabilization of the channel, then exceptions to this condition require application submittal to, and written approval by, the Division of Water Quality, regardless of the total impacts to streams or wetlands from the project.

Installation of culverts in wetlands must ensure continuity of water movement and be designed to adequately accommodate high water or flood conditions. Additionally, when roadways, causeways, or other fill projects are constructed across FEMA-designated floodways or wetlands, openings such as culverts or bridges must be provided to maintain the natural hydrology of the system as well as prevent constriction of the floodway that may result in destabilization of streams or wetlands.

The establishment of native, woody vegetation and other soft stream bank stabilization techniques must be used where practicable instead of riprap or other bank hardening methods.

9. If concrete is used during the construction, then all necessary measures shall be taken to prevent direct contact between uncured or curing concrete and waters of the state. Water that inadvertently contacts uncured concrete shall not be discharged to waters of the state due to the potential for elevated pH and possible aquatic life/ fish kills.
10. Applications for riprap groins proposed in accordance with 15A NCAC 07H .1401 (NC Division of Coastal Management General Permit for construction of Wooden and Riprap Groins in Estuarine and Public Trust Waters) must meet all the specific conditions for design and construction specified in 15A NCAC 07H .1405.

Water Quality Certification No. 3883

11. Bridge deck drains shall not discharge directly into the stream. Stormwater shall be directed across the bridge and pre-treated through site-appropriate means (grassed swales, pre-formed scour holes, vegetated buffers, etc.) before entering the stream. Please refer to the most current version of *Stormwater Best Management Practices*. Exceptions to this condition require written approval by the Division.
12. Compensatory Mitigation

In accordance with 15A NCAC 02H .0506 (h), compensatory mitigation may be required for losses of equal to or greater than 150 linear feet of streams (intermittent and perennial) and/or equal to or greater than one (1) acre of wetlands. For linear public transportation projects, impacts equal to or exceeding 150 linear feet per stream shall require mitigation.

Buffer mitigation may be required for any project with Buffer Rules in effect at the time of application for activities classified as "Allowable with Mitigation" or "Prohibited" within the Table of Uses.

A determination of buffer, wetland, and stream mitigation requirements shall be made for any General Water Quality Certification for this Nationwide and/or Regional General Permit. Design and monitoring protocols shall follow the US Army Corps of Engineers Wilmington District *Stream Mitigation Guidelines* (April 2003) or its subsequent updates. Compensatory mitigation plans shall be submitted to the Division for written approval as required in those protocols. The mitigation plan must be implemented and/or constructed before any impacts occur on site. Alternatively, the Division will accept payment into an in-lieu fee program or a mitigation bank. In these cases, proof of payment shall be provided to the Division before any impacts occur on site.
13. All temporary fill and culverts shall be removed and the impacted area returned to natural conditions within 60 days of the determination that the temporary impact is no longer necessary. The impacted areas shall be restored to original grade, including each stream's original cross sectional dimensions, plan form pattern, and longitudinal bed and bed profile, and the various sites shall be stabilized with natural woody vegetation (except for the approved maintenance areas) and restored to prevent erosion.
14. All temporary pipes/ culverts/ riprap pads etc, shall be installed in all streams as outlined in the most recent edition of the *North Carolina Sediment and Erosion Control Planning and Design Manual* or the *North Carolina Surface Mining Manual* so as not to restrict stream flow or cause dis-equilibrium during use of this General Certification.
15. Any riprap required for proper culvert placement, stream stabilization, or restoration of temporarily disturbed areas shall be restricted to the area directly impacted by the approved construction activity. All rip-rap shall be buried and/or "keyed in" such that the original stream elevation and streambank contours are restored and maintained. Placement of rip-rap or other approved materials shall not result in de-stabilization of the stream bed or banks upstream or downstream of the area.
16. Any rip-rap used for stream stabilization shall be of a size and density so as not to be able to be carried off by wave, current action, or stream flows and consist of clean rock or masonry material free of debris or toxic pollutants. Rip-rap shall not be installed in the streambed except in specific areas required for velocity control and to ensure structural integrity of bank stabilization measures.
17. A one-time application of fertilizer to re-establish vegetation is allowed in disturbed areas including riparian buffers, but is restricted to no closer than 10 feet from top of bank of streams. Any fertilizer application must comply with all other Federal, State and Local regulations.

Water Quality Certification No. 3883

18. If an environmental document is required under the National or State Environmental Policy Act (NEPA or SEPA), then this General Certification is not valid until a Finding of No Significant Impact (FONSI) or Record of Decision (ROD) is issued by the State Clearinghouse.
19. In the twenty (20) coastal counties, the appropriate DWQ Regional Office must be contacted to determine if Coastal Stormwater Regulations will be required.
20. This General Certification does not relieve the applicant of the responsibility to obtain all other required Federal, State, or Local approvals.
21. The applicant/permittee and their authorized agents shall conduct all activities in a manner consistent with State water quality standards (including any requirements resulting from compliance with §303(d) of the Clean Water Act), and any other appropriate requirements of State and Federal Law. If the Division determines that such standards or laws are not being met, including failure to sustain a designated or achieved use, or that State or Federal law is being violated, or that further conditions are necessary to assure compliance, then the Division may reevaluate and modify this General Water Quality Certification.
22. When written authorization is required for use of this certification, upon completion of all permitted impacts included within the approval and any subsequent modifications, the applicant shall be required to return the certificate of completion attached to the approval. One copy of the certificate shall be sent to the DWQ Central Office in Raleigh at 1650 Mail Service Center, Raleigh, NC, 27699-1650.
23. Additional site-specific conditions, including monitoring and/or modeling requirements, may be added to the written approval letter for projects proposed under this Water Quality Certification in order to ensure compliance with all applicable water quality and effluent standards.
24. This certification grants permission to the director, an authorized representative of the Director, or DENR staff, upon the presentation of proper credentials, to enter the property during normal business hours.

This General Certification shall expire on the same day as the expiration date of the corresponding Nationwide and/or Regional General Permit. The conditions in effect on the date of issuance of Certification for a specific project shall remain in effect for the life of the project, regardless of the expiration date of this Certification.

Non-compliance with or violation of the conditions herein set forth by a specific project may result in revocation of this General Certification for the project and may also result in criminal and/or civil penalties.

The Director of the North Carolina Division of Water Quality may require submission of a formal application for Individual Certification for any project in this category of activity if it is determined that the project is likely to have a significant adverse effect upon water quality, including state or federally listed endangered or threatened aquatic species, or degrade the waters so that existing uses of the wetland or downstream waters are precluded.

Water Quality Certification No. 3883

Public hearings may be held for specific applications or group of applications prior to a Certification decision if deemed in the public's best interest by the Director of the North Carolina Division of Water Quality.

Effective date: March 19, 2012

DIVISION OF WATER QUALITY

By

A handwritten signature in blue ink that reads "Charles Wakild for".

Charles Wakild, P.E.

Director

History Note: Water Quality Certification (WQC) Number 3883 issued March 19, 2012 replaces WQC Number 3687 issued November 1, 2007; WQC Number 3624 issued March 19, 2007; WQC Number 3494 issued December 31, 2004; and WQC Number 3376 issued March 18, 2002. This General Certification is rescinded when the Corps of Engineers reauthorizes any of the corresponding Nationwide and/or Regional General Permits or when deemed appropriate by the Director of the Division of Water Quality.