

PROJECT: HOPE MILLS CUMBERLAND COUNTY U-2810A

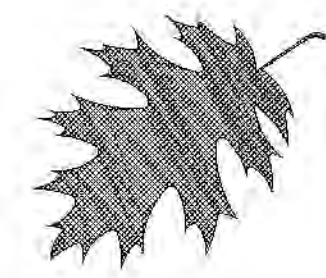

HIGHWAY LANDSCAPE DEVELOPMENT PROJECT

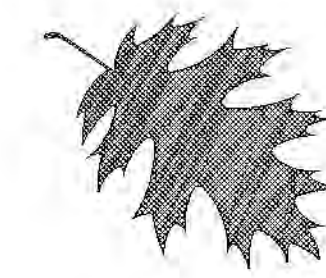

T.I.P. #	STATE PROJECT W.B.S. #	SHEET #	SHEET # TOTAL
U-2810A	34866.3.1	L1.0	6
FED. PROJ. #	DESCRIPTION	DIVISION	
-	PLANTING	6	

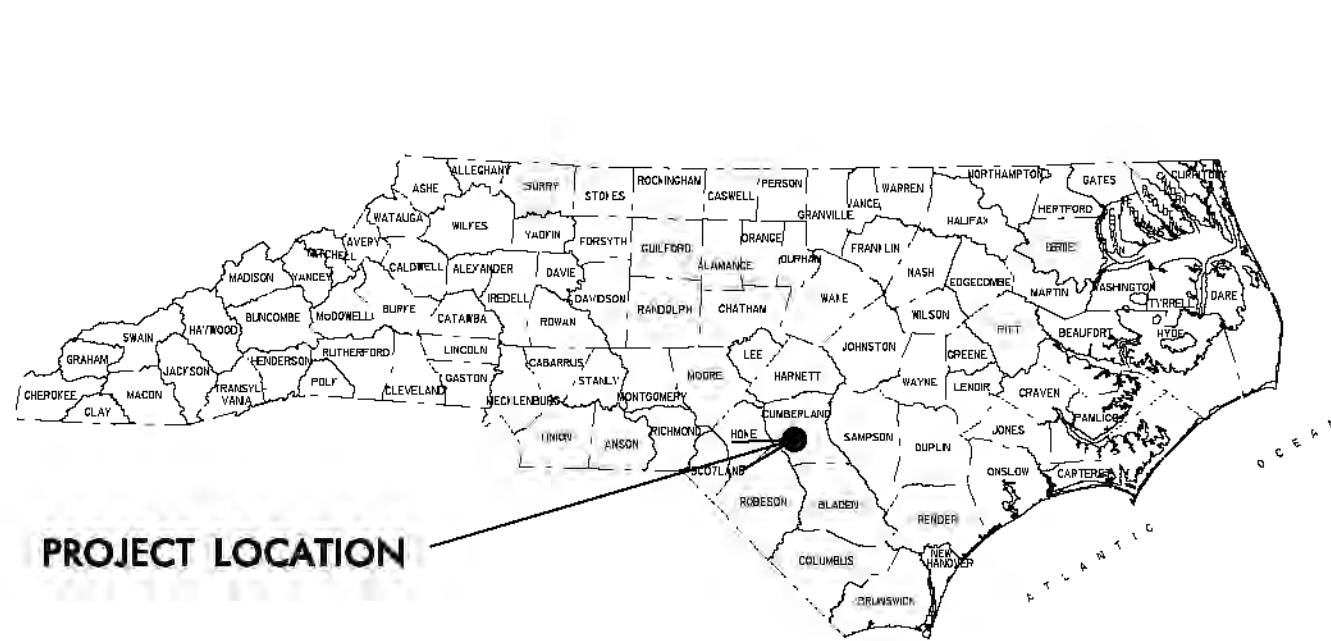

STATE OF NORTH CAROLINA
DIVISION OF HIGHWAYS

**LOCATION: SR 1003 (CAMDEN ROAD) FROM NC 59
(HOPE MILLS ROAD) TO HOPE MILLS BYPASS**

TYPE OF WORK: LANDSCAPE ENHANCEMENT

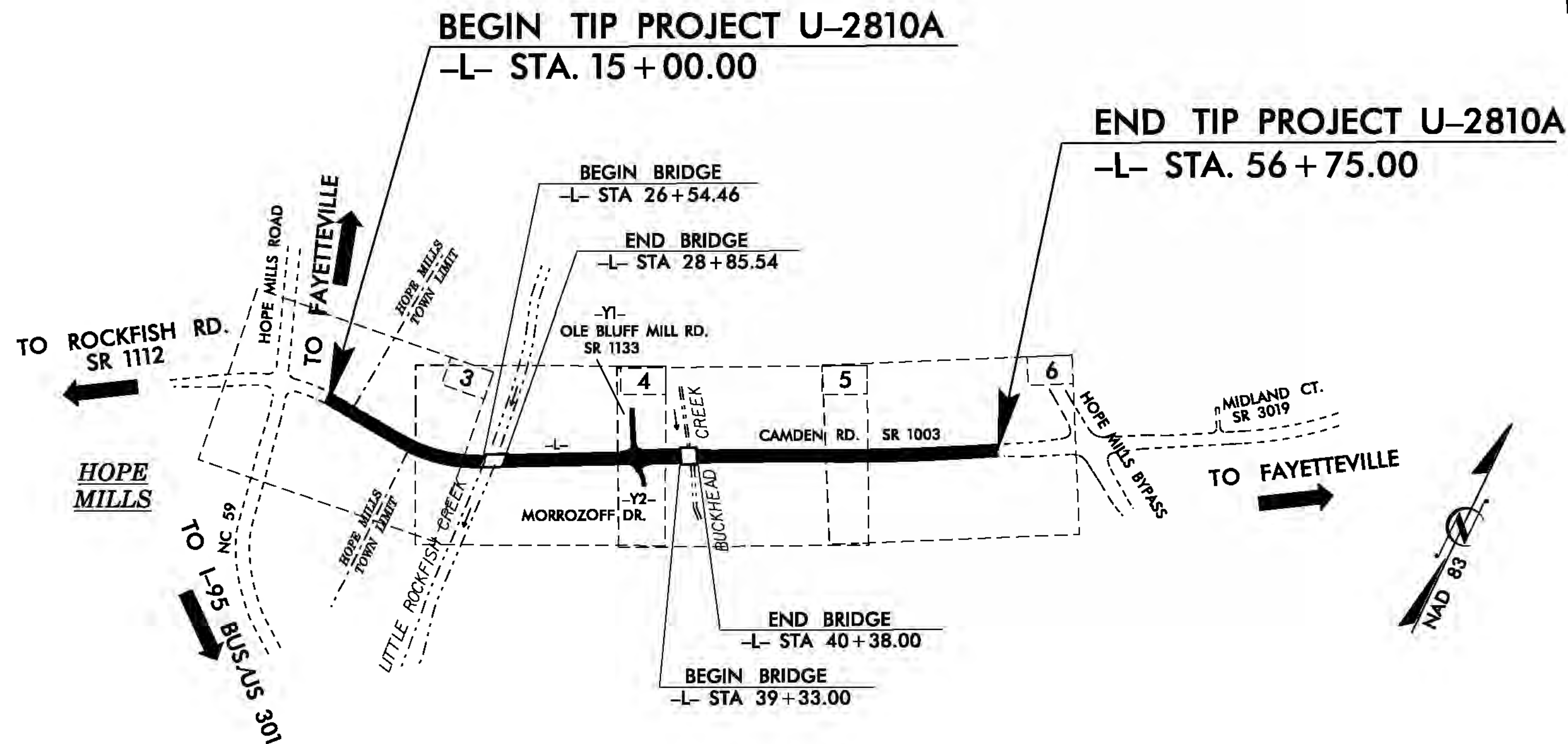
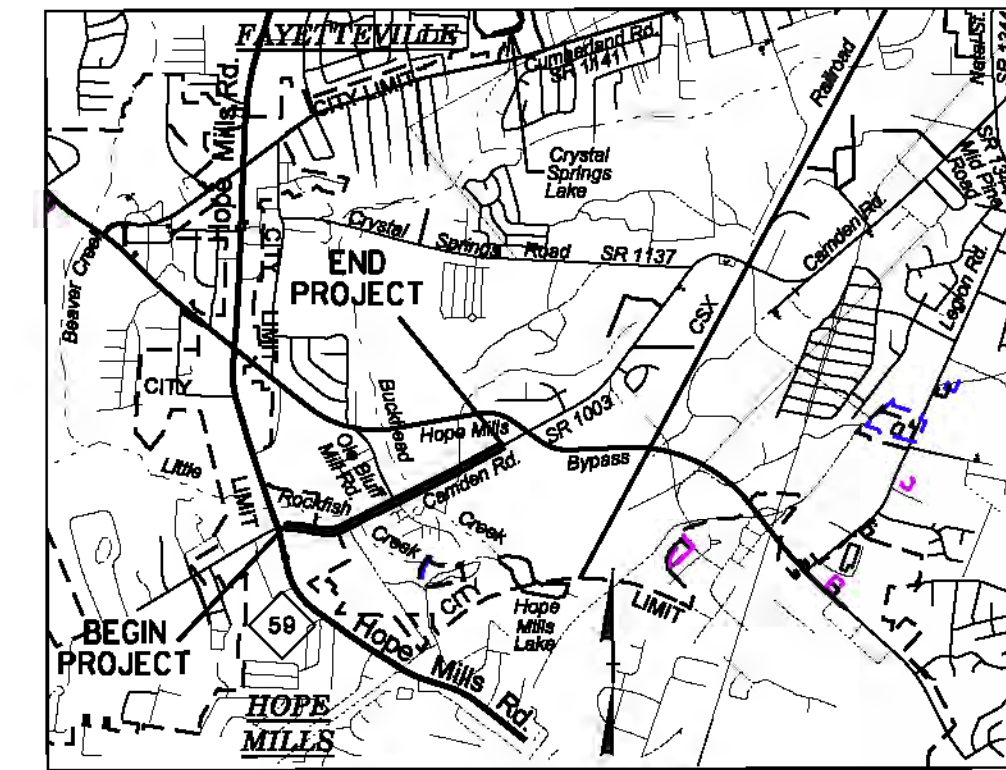

Summary of Quantities

DES	SEC	QTY	UNIT	KEY	BOTANICAL NAME	COMMON NAME	SIZE	FURNISH	A.S.N.S.	REMARKS
L	1670	2624	EA	HB	Hemerocallis 'Buttered Popcorn'	Buttered Popcorn Daylily		#1 cont.	12.2.3	2' o.c.
L	1670	15	EA	IA	Ilex X attenuata 'Savannah'	Savannah Holly	5-6'	#15 cont.	4.2.4	As Shown
L	1670	15	EA	LC	Lagerstroemia indica 'Catawba'	Catawba Crape Myrtle	5-6'	#15 cont.	2.2.4	As Shown
L	1670	492	EA	RD	Rosa X 'Double Knock Out'	Red Double Knock Out Rose	18-24"	#3 cont.	5.2	As Shown
L	1670	228	CY		Mulch for Planting					
L	1670	30	M/G		Water for Planting					
L	1670	2382	SY		Pre emergence Herbicidal Treatment					
L	1670	2382	SY		Post emergence Herbicidal Treatment					

CONVENTIONAL SYMBOLS

County Line	-----
City or Town Line	-----
Exist. Right of Way Line Marker	-----
Prop. Right of Way Line Marker (By Others)	-----
Prop Right of Way Line Marker (By Contract)	-----
Exist. Control of Access Line	-----
Prop. Control of Access Line	-----
Property Line	-----
Easement Line	-----
Slope Stake Line	-----
Exist. Fence	-----
Prop. Woven Wire Fence	-----
Prop. Chain Link Fence	-----
Exist. Road	-----
Prop. Road	-----
Guardrail	-----
Survey Line	-----
Denotes Line Equality	-----
Bridge	-----
Culvert	-----
Railroad	-----
Woods	-----
Exist. Telephone Pole	-----
Prop. Telephone Pole	-----
Tower Pole and Line	-----
Exist. Power Pole	-----
Prop. Power Pole	-----
Sanitary Sewer Line	-----
Water Line	-----
Gas Line	-----
Picnic Shelter	-----
Regeneration	-----
Reforestation	-----

INDEX OF L SHEETS:
L 1.0 ... TITLE, DESCRIPTION, LOCATION
L 2.0 ... PLANTING DETAILS
L 3.0 - L-6 ... PLANTING PLANS

PREPARED BY: **BM** DATE: 12/2014

REVISIONS

DATE	DESCRIPTION

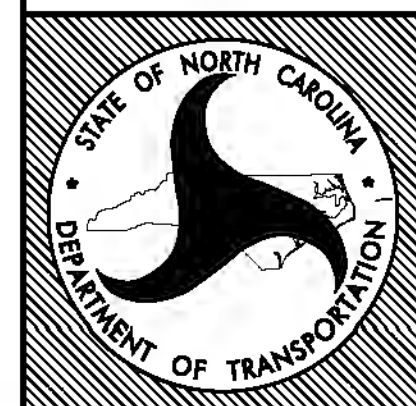

STATE OF NORTH CAROLINA
DEPARTMENT OF TRANSPORTATION

LOCATION: Hope Mill By - Pass
TYPE of WORK: Landscape Planting
COUNTY: Cumberland County

2004 American Standard for Nursery Stock
2012 NCDOT STANDARD SPECIFICATIONS
PREPARED IN THE OFFICE OF:
NCDOT- ROADSIDE ENVIRONMENTAL UNIT
LANDSCAPE DESIGN & DEVELOPMENT SECTION
1557 MAIL SERVICE CENTER
RALEIGH NC 27699 919-707-2920

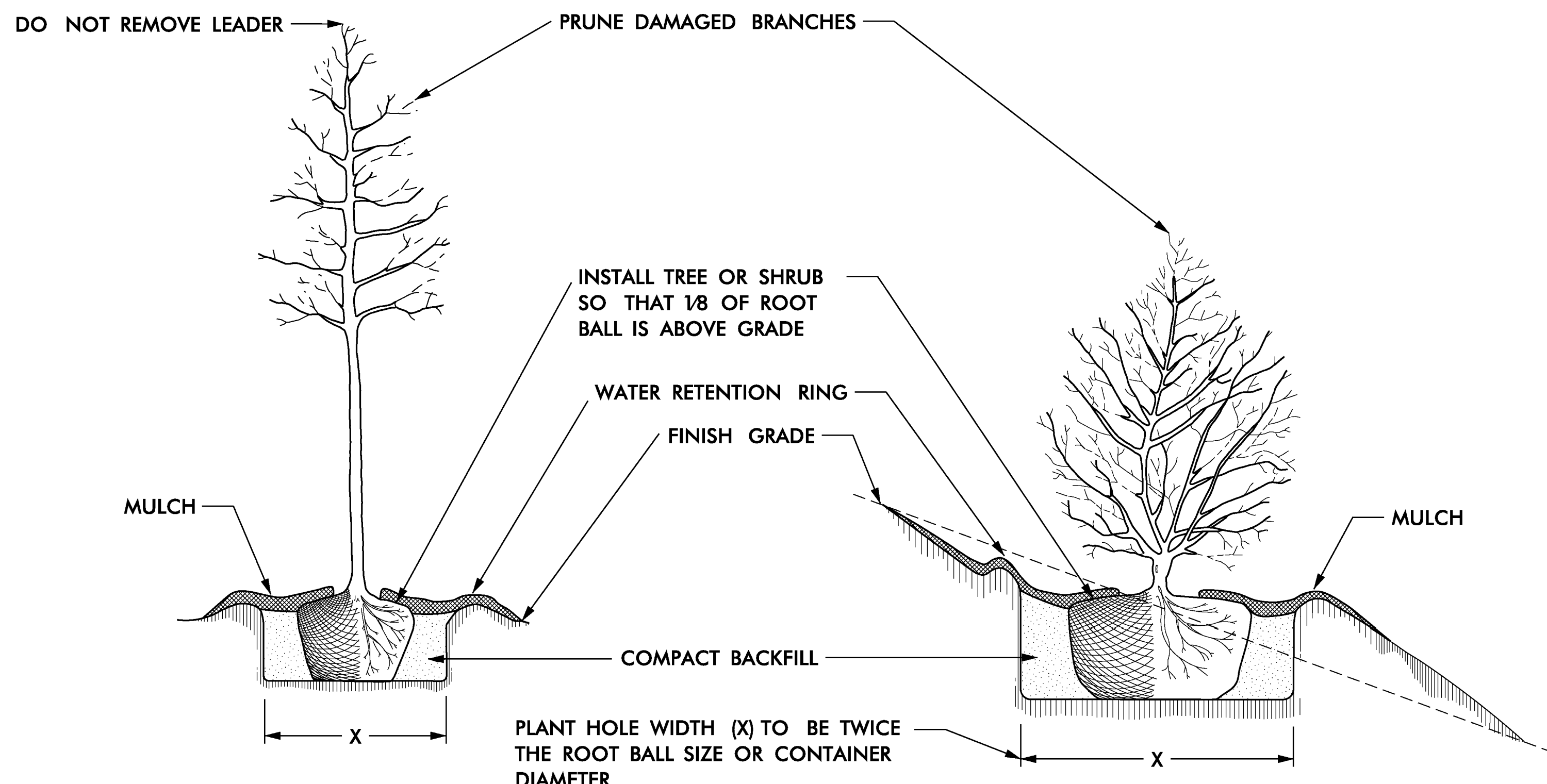

TREE OR SHRUB PLANTING DETAIL
(LEVEL GROUND)

TREE OR SHRUB PLANTING DETAIL
(SLOPING GROUND)

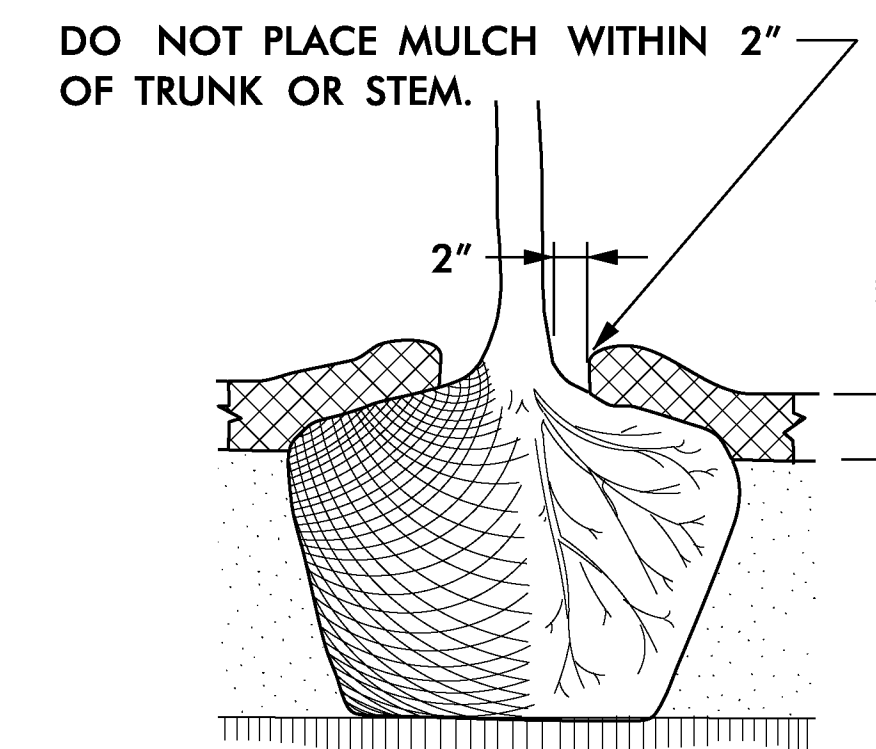
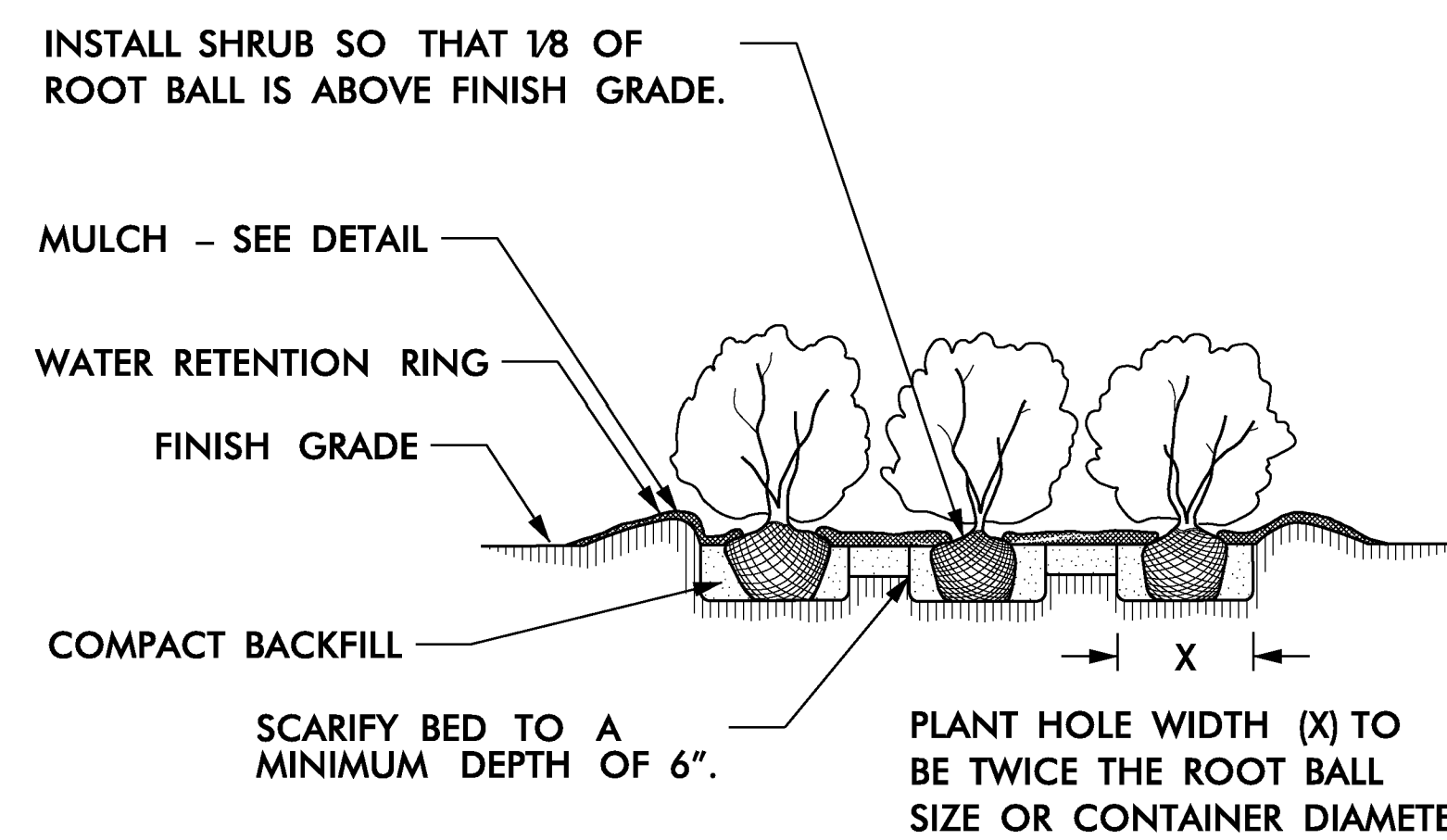
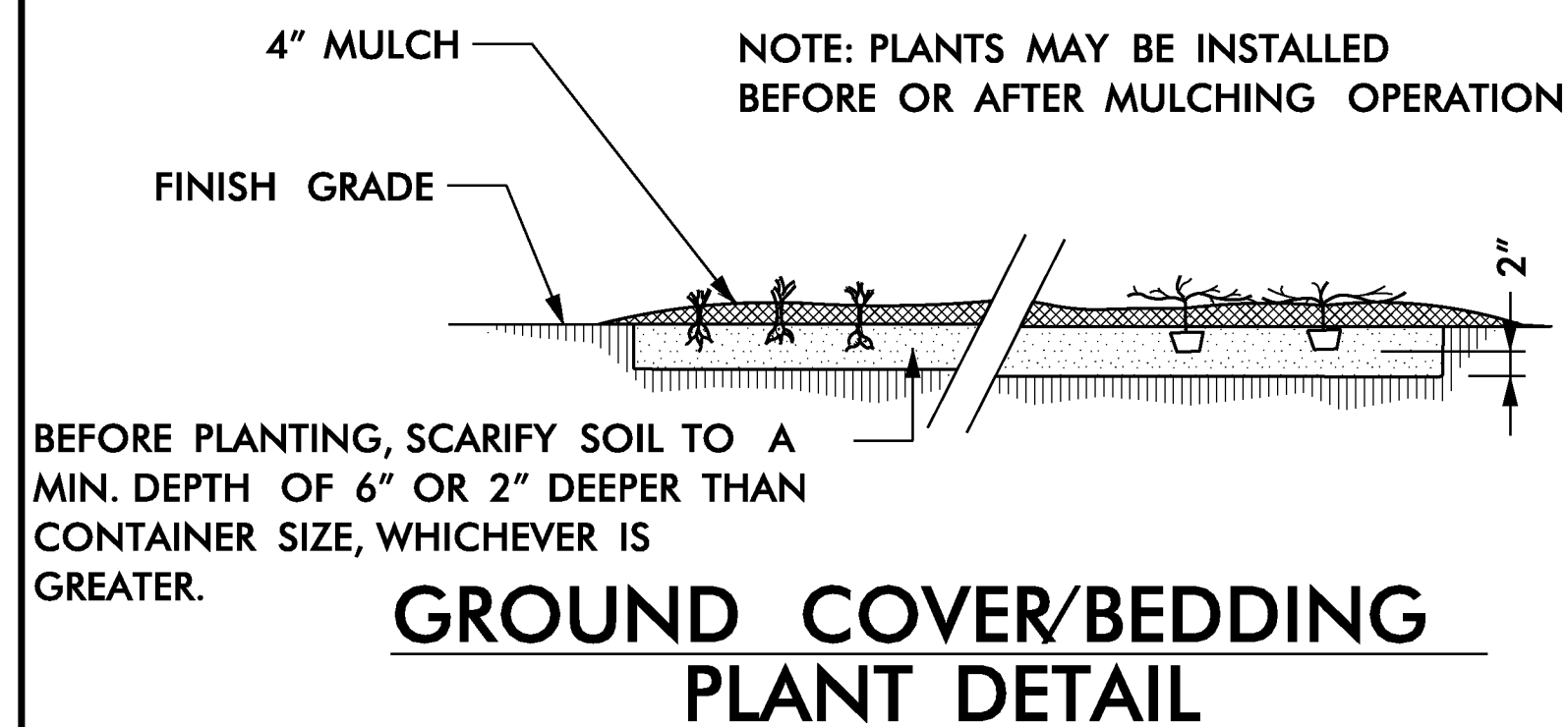

NOTES:

- SCHEDULE FOR PLANT HOLE SIZE: PLANT HOLE WIDTH (X) TO BE TWICE THE ROOT BALL SIZE OR CONTAINER DIAMETER.
- SEE STANDARD SPECIFICATIONS FOR PLANT BED FUMIGATION AND HERBICIDAL TREATMENT.
- APPLY FERTILIZER AT PLANTING TIME IN THE FORM OF A SLOW RELEASE PELLET OR TABLET. APPLY AT RATE RECOMMENDED BY MANUFACTURER. BOTH RATE AND FORMULATION MUST BE APPROVED BY FIELD ENGINEER PRIOR TO APPLICATION.
- REMOVE WIRE BASKET AND FOLD BURLAP BACK FROM TOP OF ROOT BALL BEFORE BACKFILLING IS COMPLETE.
- ALL PRUNING TO FOLLOW STANDARD ARBORICULTURAL PRACTICES AS SPECIFIED BY INTERNATIONAL SOCIETY OF ARBORICULTURE.
- DO NOT ATTEMPT TO STRAIGHTEN A TREE THAT HAS BEEN PLANTED AT AN ANGLE WITH THE USE OF STAKING OR GUYING. DIG TREE AND REPLANT TO UPRIGHT POSITION.

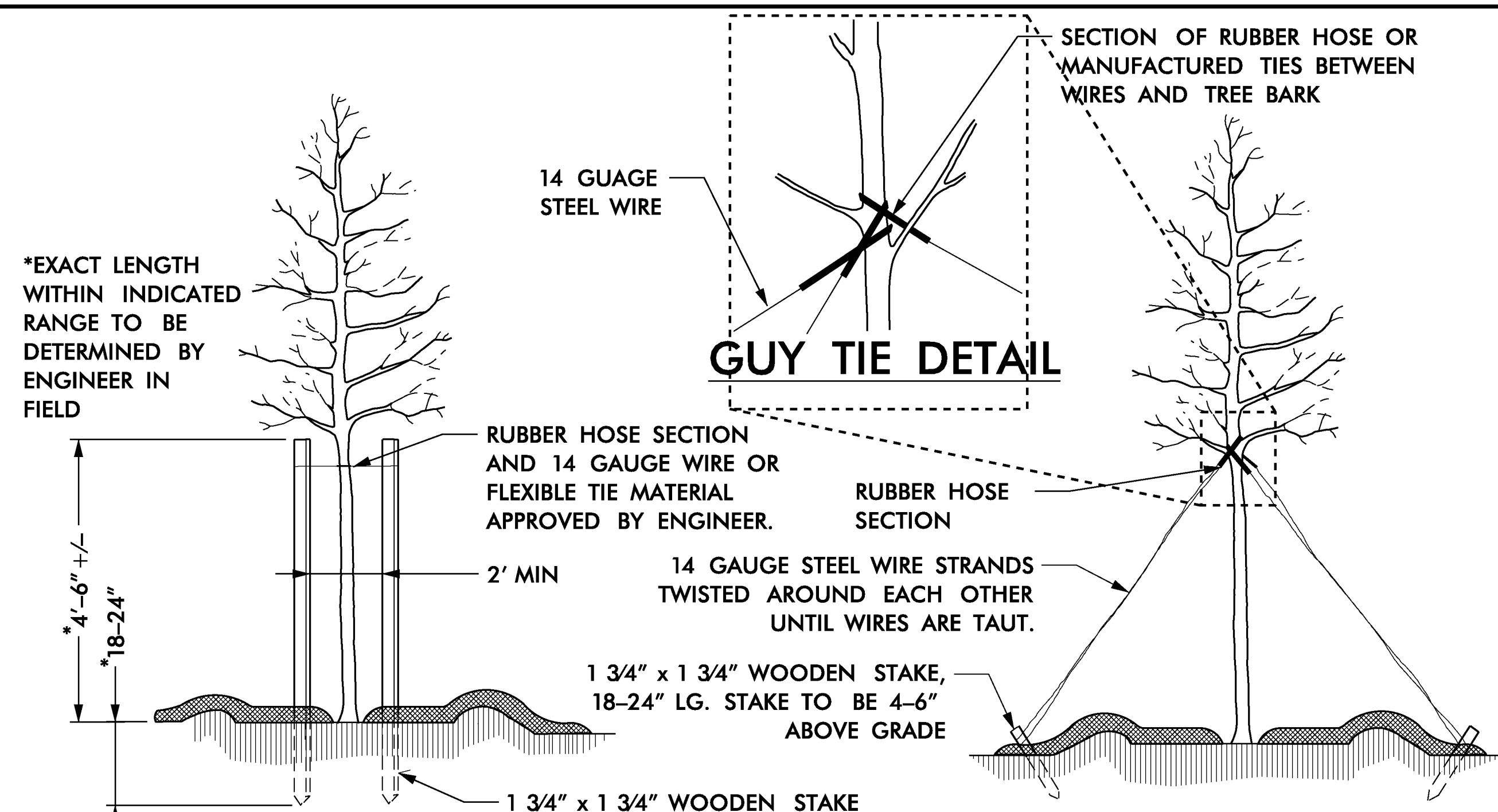

PLAN VIEW
STAKING DETAIL
(TREES 6'-10')
USE AS DIRECTED BY FIELD ENGINEER

PLAN VIEW
GUYING DETAIL
(TREES 10' OR LARGER)
USE AS DIRECTED BY FIELD ENGINEER

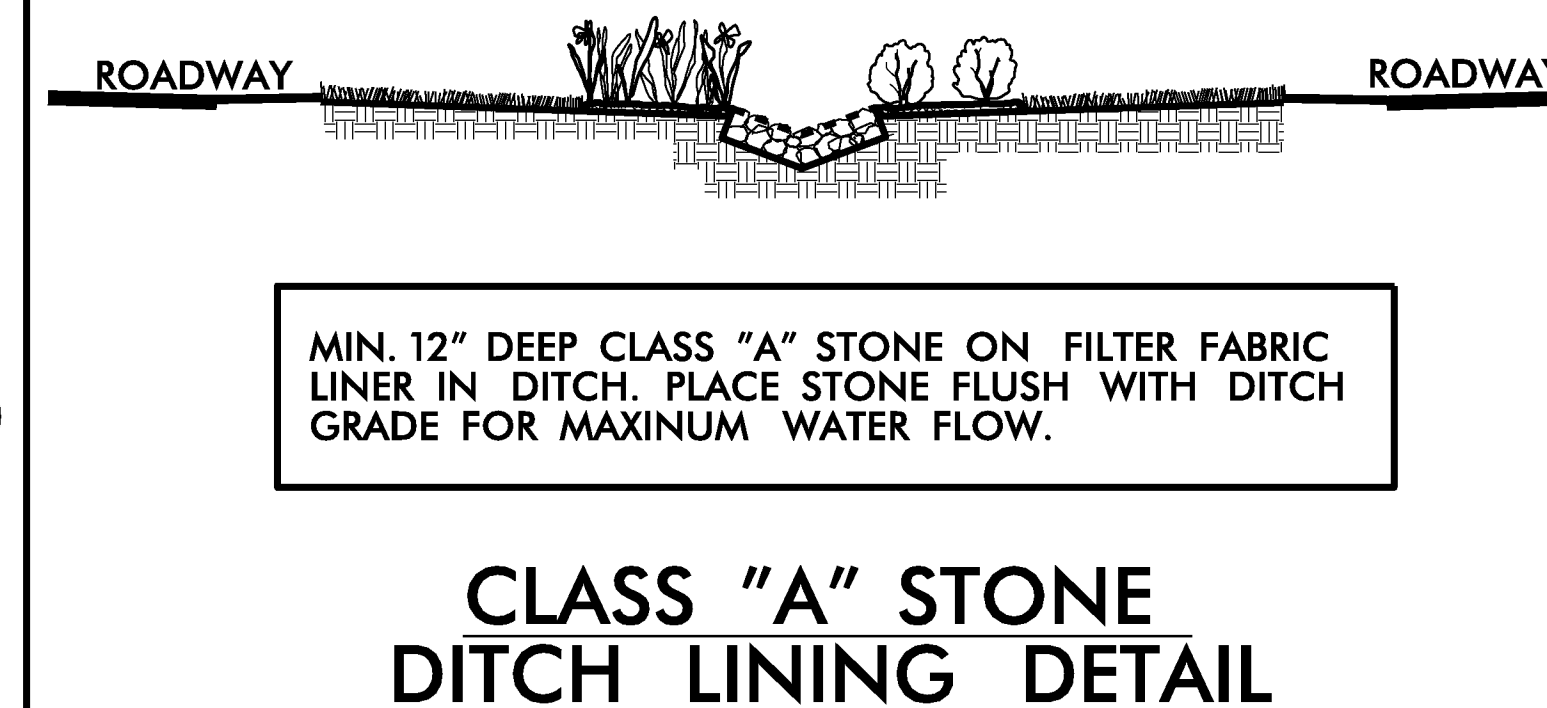
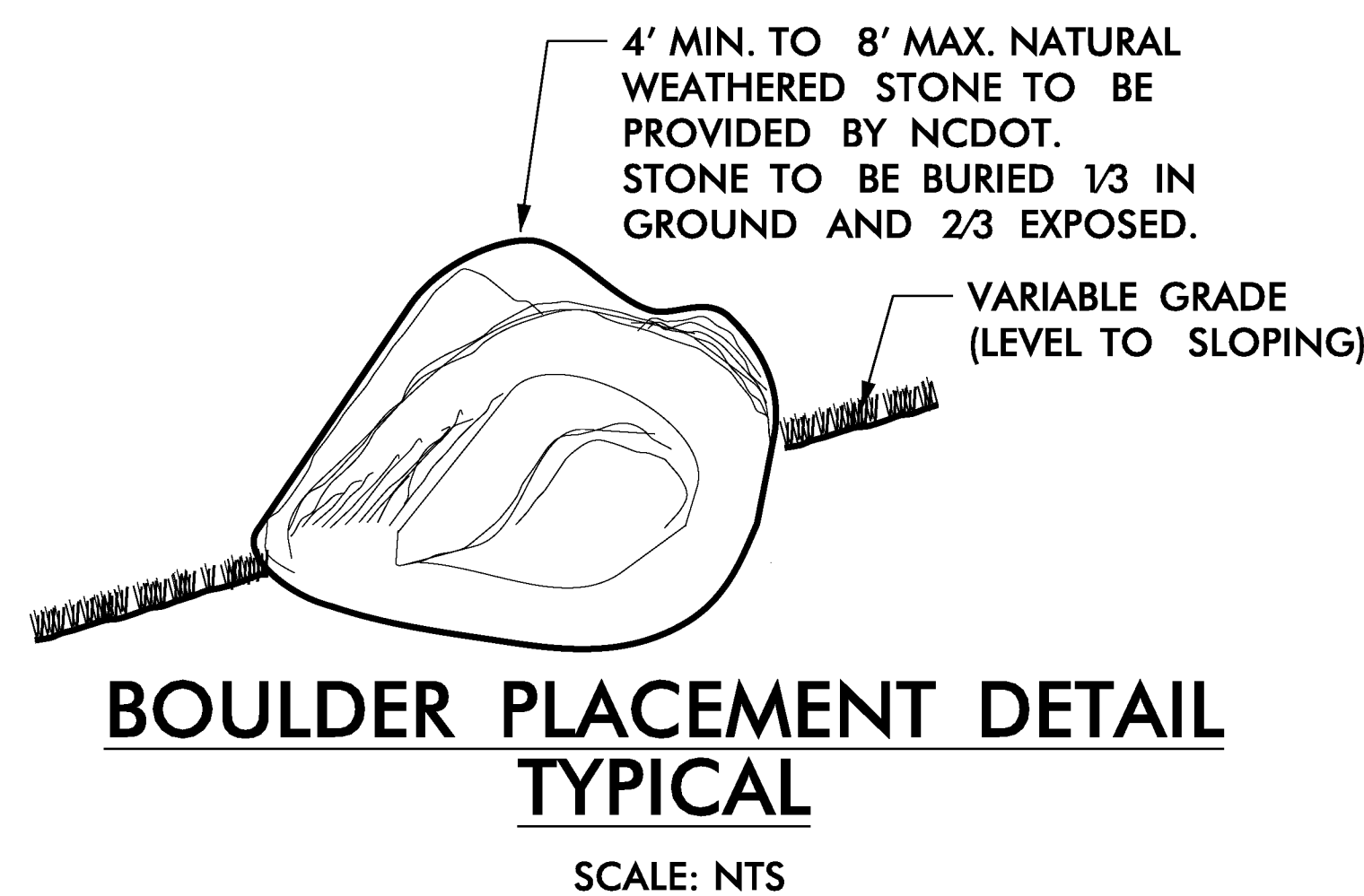
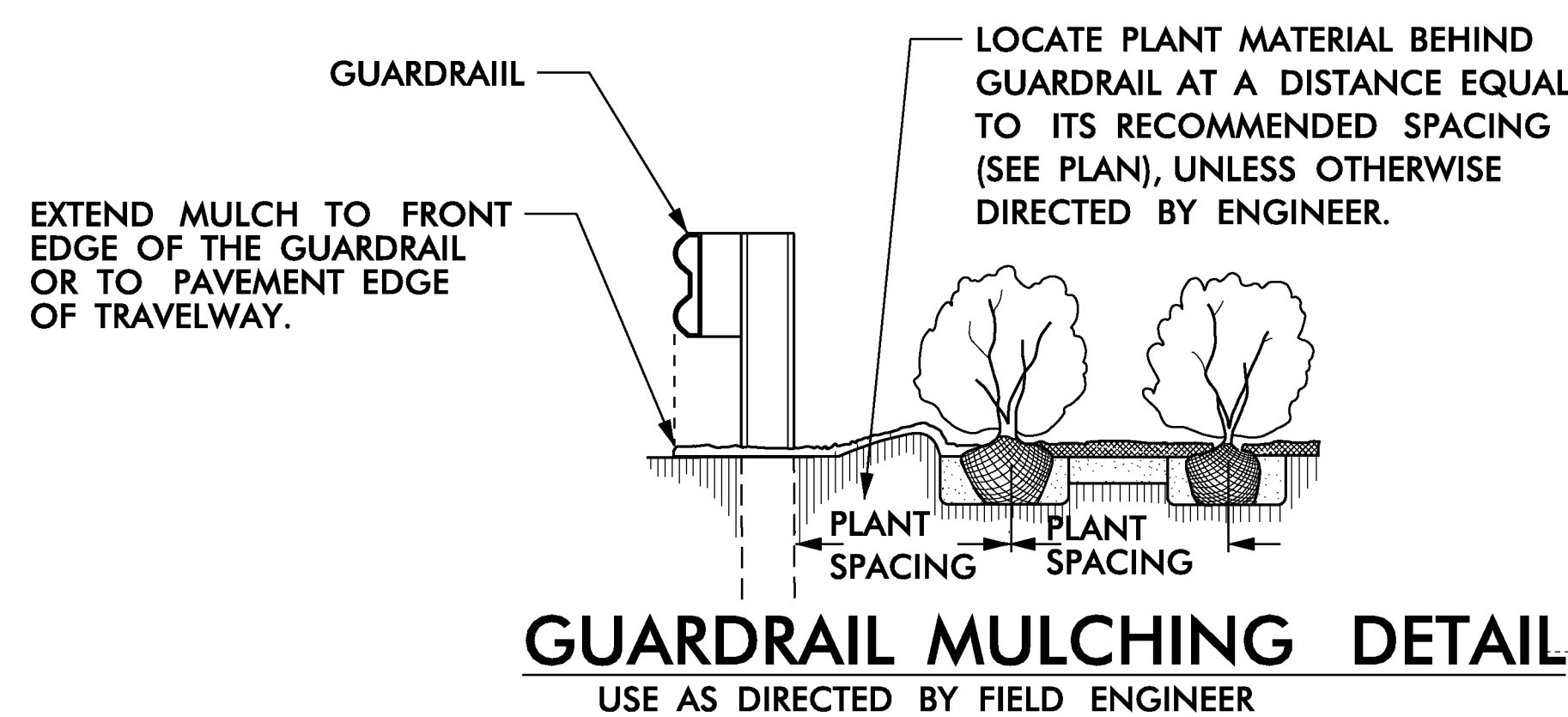

Planting Details

06-JAN-2015 13:55
C:\Users\koberley\Desktop\Documents\Projects\Town of Hope Mills\Camden Rd & Hope Mills By-Pass\Hope Mills Planting.dgn
\$\$\$\$\$BENNAME\$\$\$\$\$

North Carolina Department of Transportation
Roadside Environmental Unit
Landscape Design & Development Section

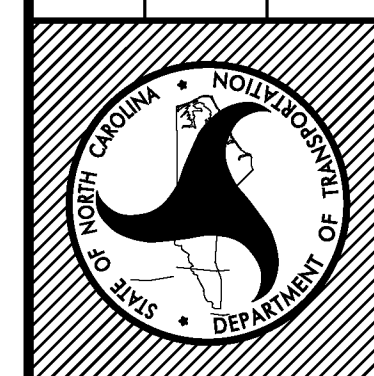

Hope Mills By-Pass
Cumberland County

PROJECT TITLE:

Plans Drawn By:	BM
Scale:	AS NOTED
Date:	12/29/2014
Sheet Description:	
T.I.P. #:	U-2810A
Sheet #:	L-2

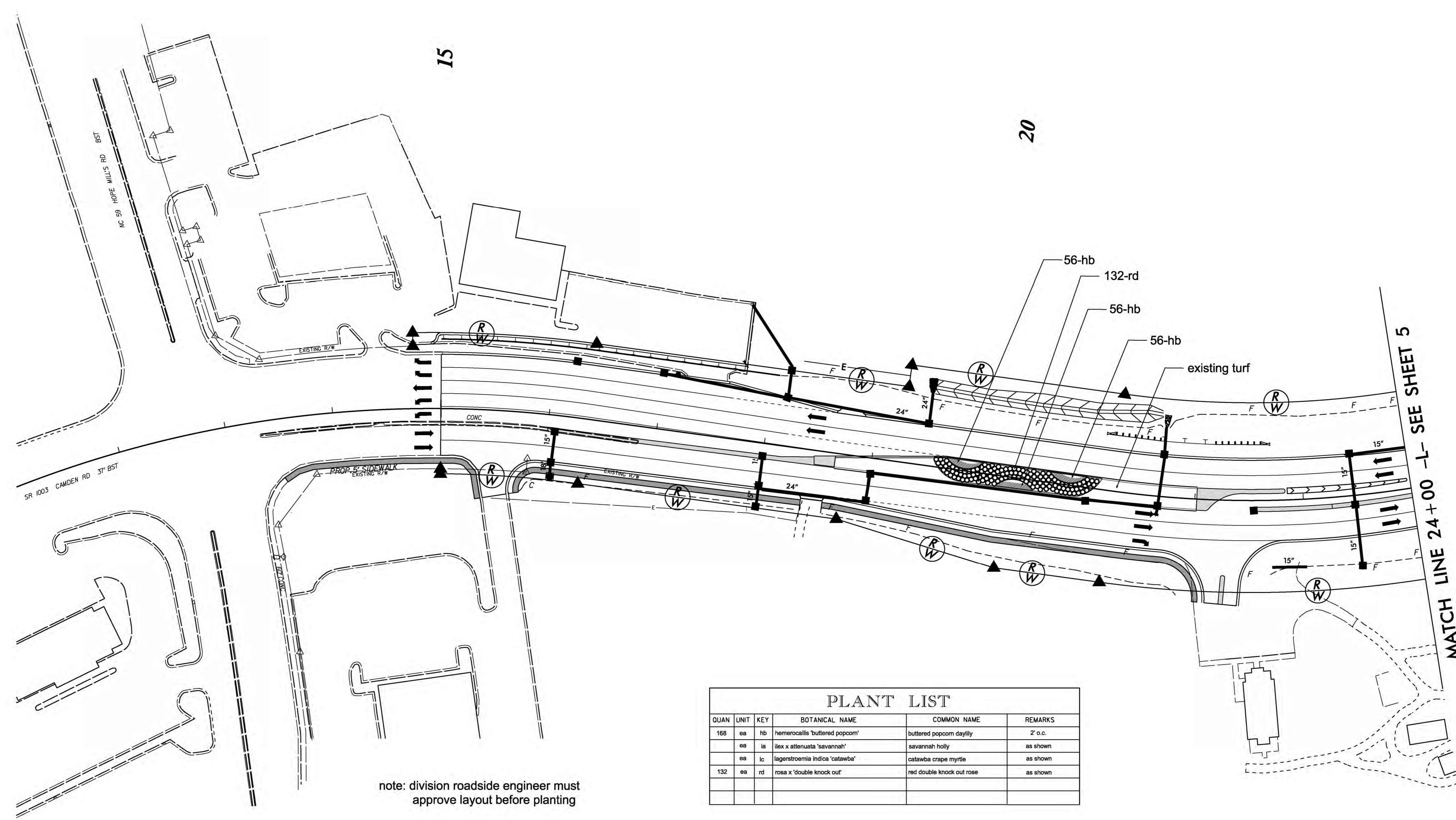

PLANT LIST

QUAN	UNIT	KEY	BOTANICAL NAME	COMMON NAME	REMARKS
168	ea	hb	hemerocallis 'buttered popcorn'	buttered popcorn daylily	2' o.c.
	ea	la	ilex x attenuata 'savannah'	savannah holly	as shown
	ea	lc	lagerstroemia indica 'catawba'	catawba crape myrtle	as shown
132	ea	rd	rosa x 'double knock out'	red double knock out rose	as shown



 NCDOT - ROADSIDE ENVIRONMENTAL UNIT
LANDSCAPE DESIGN & DEVELOPMENT
 1557 MAIL SERVICE CENTER, RALEIGH, NC 27699-1557
 PH: 919-707-2920 FAX: 919-715-2554
http://www.ncdot.org/doh/operations/dp_chief_eng/roadside/

Hope Mills Cumberland Co
Camden Road
 project #: 34866.1.1

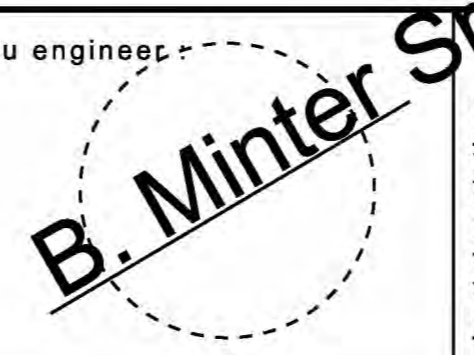
re: engineer

 sheet description: enhancement Planting
 planting plan

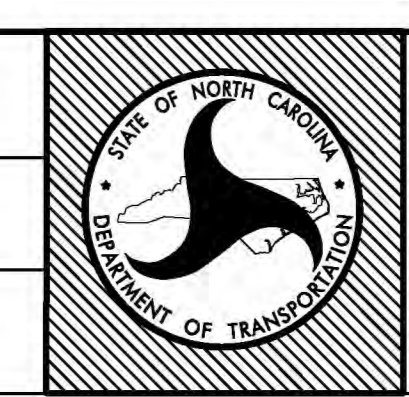
prel design date: oct 2014
 checked by & date: k cooper
 final design date: dec 2014

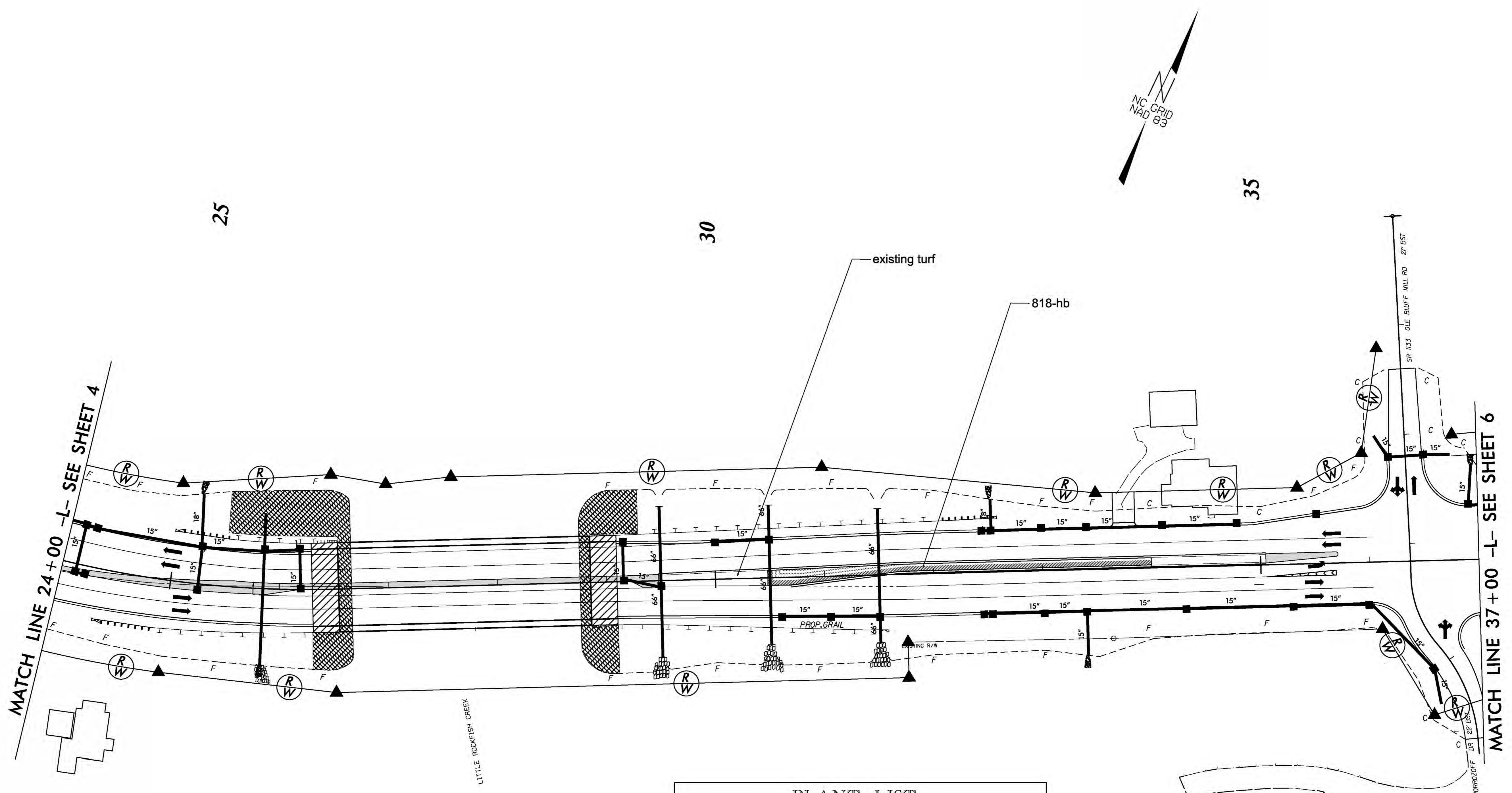

sheet no: **L-3**
 total sheet no: 6



note: division roadside engineer must approve layout before planting

PLANT LIST							
QUAN	UNIT	KEY	BOTANICAL NAME	COMMON NAME	REMARKS		
		818	ea	hb	hemerocallis 'buttered popcorn'	buttered popcorn daylily	2' o.c.
			ea	ia	ilex x attenuata 'savannah'	savannah holly	as shown
			ea	lc	lagerstroemia indica 'catawba'	catawba crape myrtle	as shown
			ea	rd	rosa x 'double knock out'	red double knock out rose	as shown

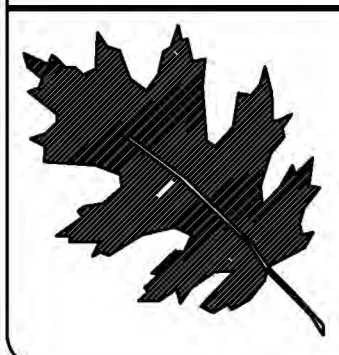

NCDOT - ROADSIDE ENVIRONMENTAL UNIT
 LANDSCAPE DESIGN & DEVELOPMENT
 1557 MAIL SERVICE CENTER, RALEIGH, NC 27699-1557
 PH: 919-707-2920 FAX: 919-715-2554
http://www.ncdot.org/doh/operations/dp_chief_eng/roadside/

Hope Mills Cumberland Co
 Camden Road
 project #: 34866.1.1

re engineered by
B. Minter Sr.

enhancement planting
 planting plan

prel design date: oct 2014
 checked by & date: k cooper
 final design date: dec 2014



sheet no: **L-4**
 total sheet no: 6

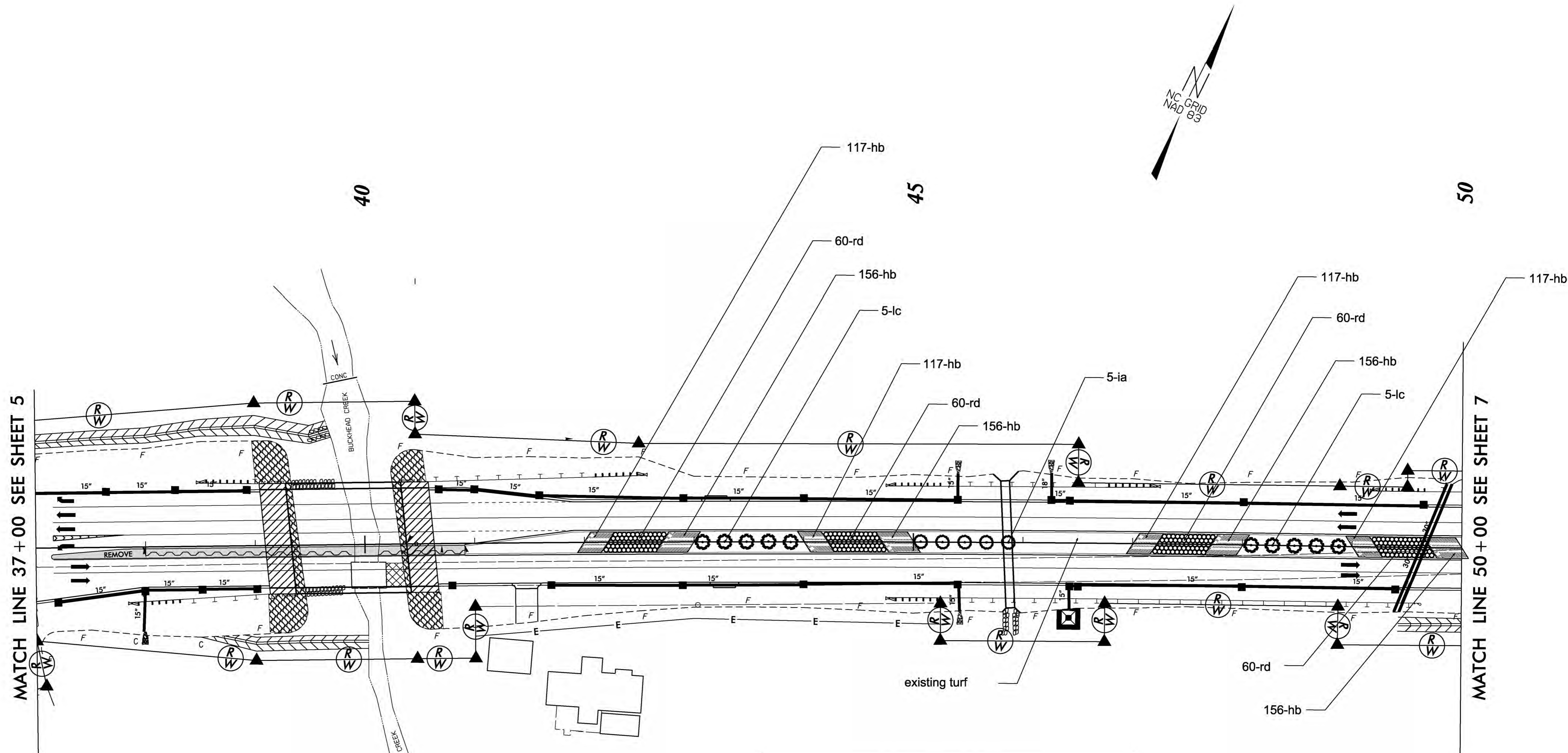

note: division roadside engineer must approve layout before planting

PLANT LIST					
QUAN	UNIT	KEY	BOTANICAL NAME	COMMON NAME	REMARKS
1092	ea	hb	hemerocallis 'buttered popcorn'	buttered popcorn daylily	2' o.c.
5	ea	ia	illex x attenuata 'savannah'	savannah holly	as shown
10	ea	lc	lagerstroemia indica 'catawba'	catawba crepe myrtle	as shown
240	ea	rd	rosa x 'double knock out'	red double knock out rose	as shown

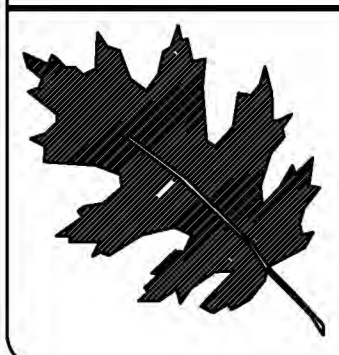

NCDOT - ROADSIDE ENVIRONMENTAL UNIT
 LANDSCAPE DESIGN & DEVELOPMENT
 1557 MAIL SERVICE CENTER, RALEIGH, NC 27699-1557
 PH: 919-707-2920 FAX: 919-715-2554
http://www.ncdot.org/doh/operations/dp_chief_eng/roadside/

Hope Mills Cumberland Co
 Camden Road
 project #: 34866.1.1

re: engineer
 B. Minter Sr.

enhancement planting
 planting plan

prel design date: oct 2014
 checked by & date: k cooper
 final design date: dec 2014

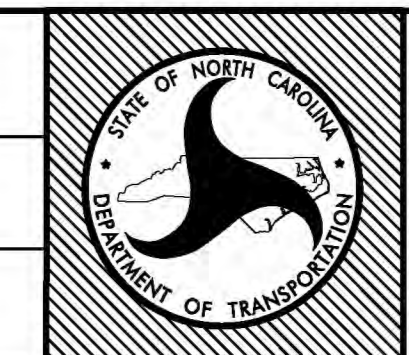

sheet no: **L-5**
 total sheet no: 6

MATCH LINE 50+00 -L- SEE SHEET 6

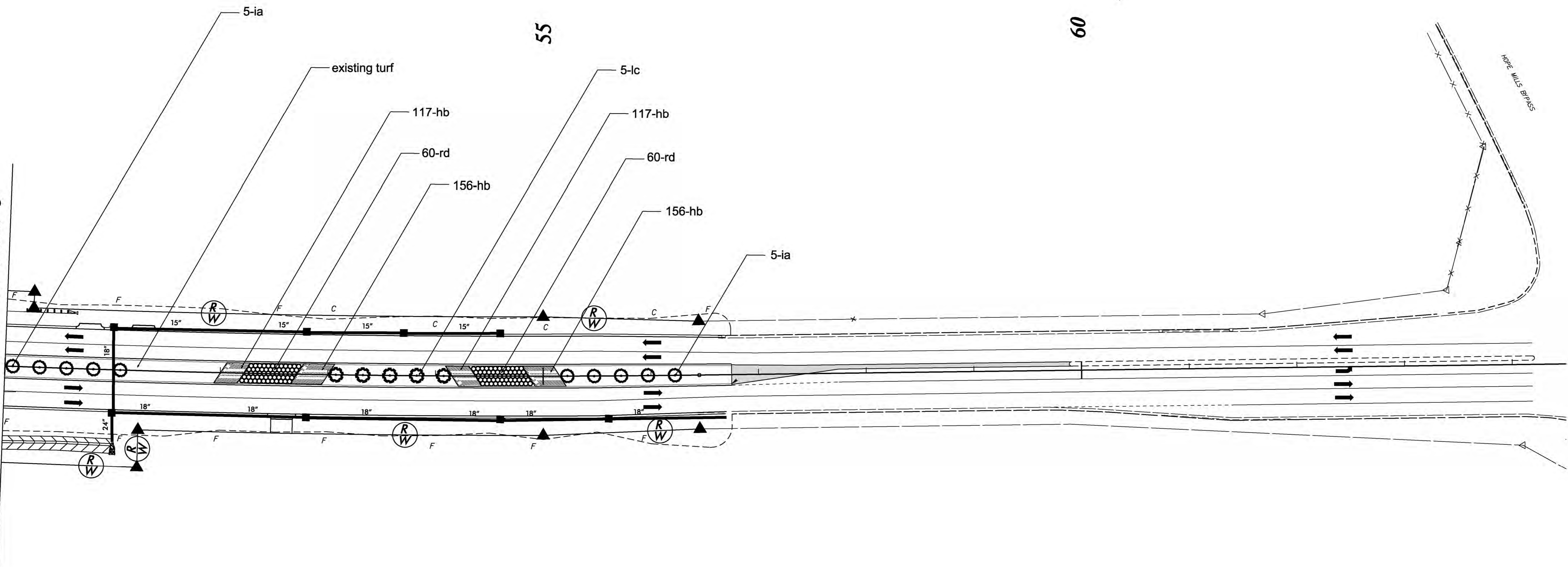

note: division roadside engineer must approve layout before planting

PLANT LIST

QUAN	UNIT	KEY	BOTANICAL NAME	COMMON NAME	REMARKS
546	ea	hb	hemerocallis 'buttered popcorn'	buttered popcorn daylily	2' o.c.
10	ea	ia	ilex x attenuata 'savannah'	savannah holly	as shown
5	ea	ic	lagerstroemia indica 'catawba'	catawba crape myrtle	as shown
120	ea	rd	rosa x 'double knock out'	red double knock out rose	as shown

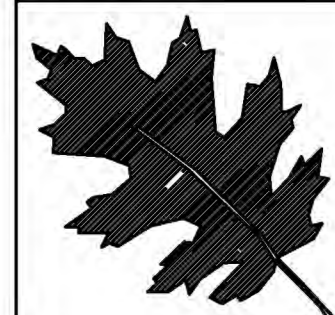

NCDOT - ROADSIDE ENVIRONMENTAL UNIT
 LANDSCAPE DESIGN & DEVELOPMENT
 1557 MAIL SERVICE CENTER, RALEIGH, NC 27699-1557
 PH: 919-707-2920 FAX: 919-715-2554
http://www.ncdot.org/doh/operations/dp_chief_eng/roadside/

Hope Mills Cumberland Co
 Camden road
 project #: 34866.1.1

re engineer
 B. Minter Sr.

enhancement planting
 planting plan

prel design date: oct 2014
 checked by & date: k cooper
 final design date: dec 2014

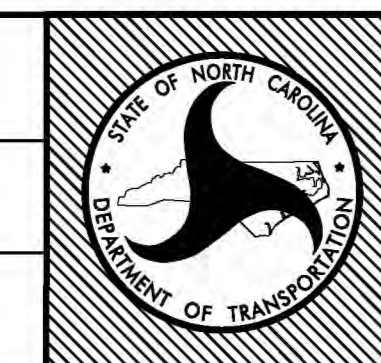

sheet no :
L-6
 total sheet no :
 6