

STATE OF NORTH CAROLINA  
DEPARTMENT OF TRANSPORTATION  
HIGHWAY DIVISION 6

**PLANS - REV 10-24-2023**  
**Letting Date: November 1, 2023**

**CONTRACT ID: DF00455**

**TIP NO.: -----**

**FEDERAL AID NO.: STATE FUNDED**

**WBS ELEMENT NO.: 2024CPT.06.07.20091.1 & 2024CPT.06.07.20241.1**

**ROUTE NO.: VARIES**

**LOCATION: VARIES**

**COUNTY: BLADEN & COLUMBUS**

**LENGTH OF PROJECT: 5.94 MILES**

**TYPE OF WORK: RESURFACING, WIDENING & PAVEMENT MARKINGS**

# Bladen County Resurfacing- DF00455

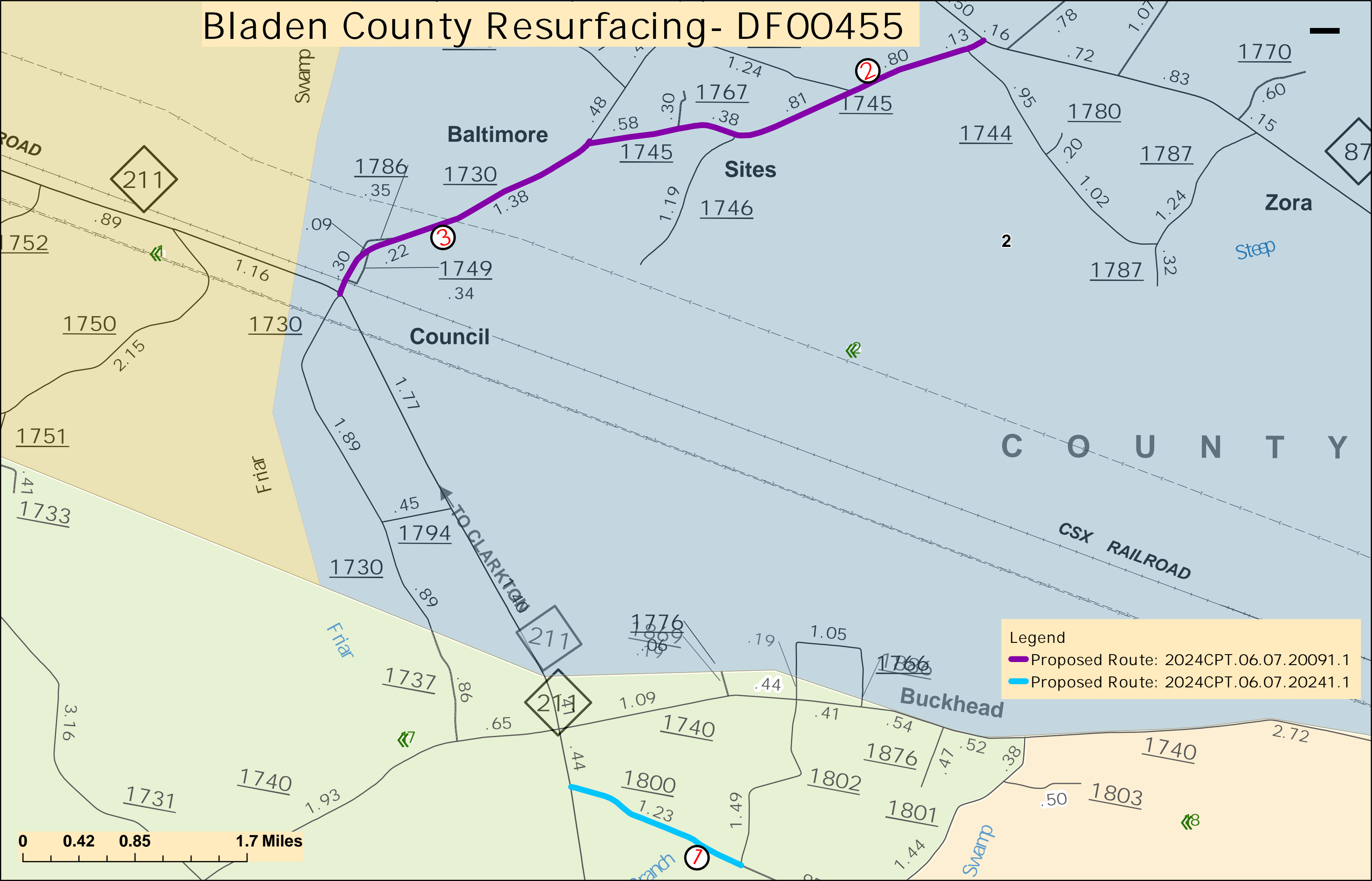

Legend

- Proposed Route: 2024CPT.06.07.20091.1
- Proposed Route: 2024CPT.06.07.20241.1

0 0.42 0.85 1.7 Miles

# PAVEMENT SCHEDULE

C1	1½" ASPHALT CONCRETE SURFACE COURSE, TYPE S9.5B, AT AN AVERAGE RATE OF 168 LBS. PER SQ. YD.
D1	4" ASPHALT CONCRETE INTERMEDIATE COURSE, TYPE I19.0B, AT AN AVERAGE RATE OF 456 LBS. PER SQ. YD.
E1	4" ASPHALT CONCRETE BASE COURSE, TYPE B25.0C, AT AN AVERAGE RATE OF 456 LBS. PER SQ. YD.
T1	SHOULDER RECONSTRUCTION WITH AGGREGATE SHOULDER BORROW
U	EXISTING ASPHALT PAVEMENT

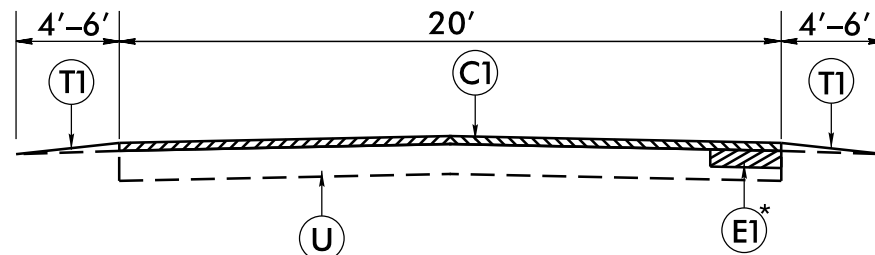

TYPICAL SECTION NO. 1

\*2' INSIDE CURVE WIDENING (SEE DETAIL)

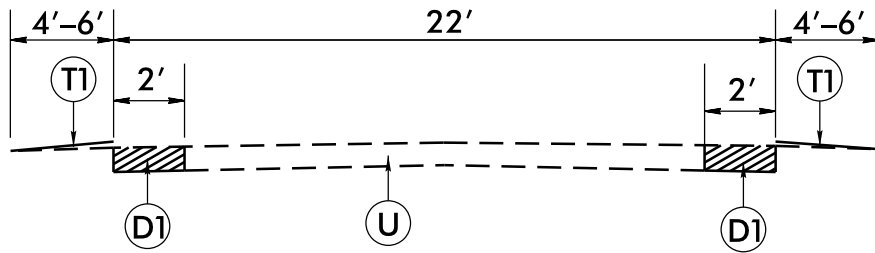

TYPICAL SECTION NO. 2

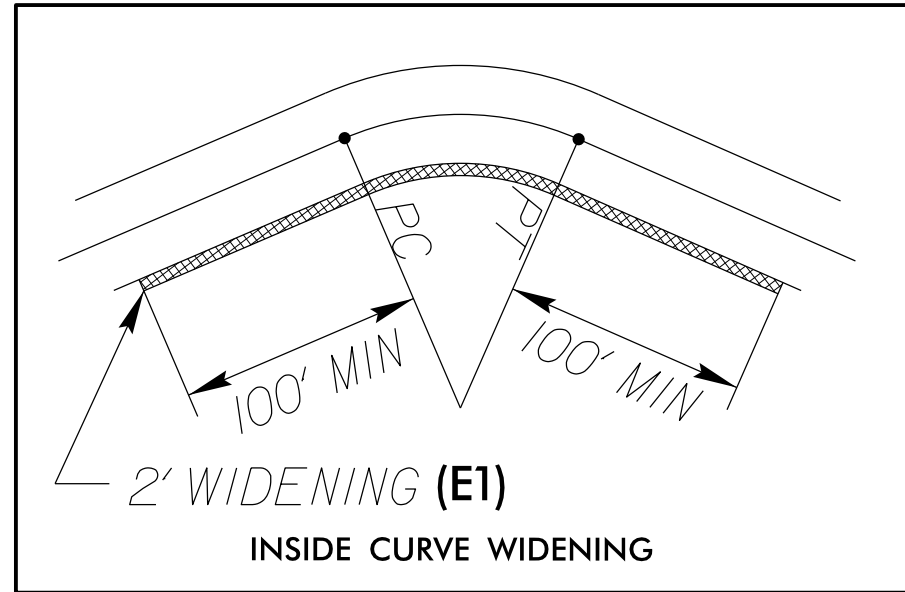

6/2/99  
I:\OCT-2023\0652 Work Files\Projects\Resurfacing\2023 Fall\1\1\3\typ2.dgn

### PAVEMENT SCHEDULE

C1	1 1/2" ASPHALT CONCRETE SURFACE COURSE, TYPE S9.5B, AT AN AVERAGE RATE OF 168 LBS. PER SQ. YD.
D1	4" ASPHALT CONCRETE INTERMEDIATE COURSE, TYPE I19.0B, AT AN AVERAGE RATE OF 456 LBS. PER SQ. YD.
E1	4" ASPHALT CONCRETE BASE COURSE, TYPE B25.0C, AT AN AVERAGE RATE OF 456 LBS. PER SQ. YD.
T1	SHOULDER RECONSTRUCTION WITH AGGREGATE SHOULDER BORROW
U	EXISTING ASPHALT PAVEMENT

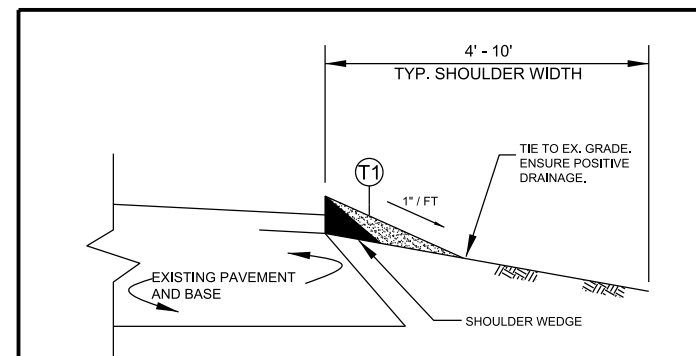

### SHOULDER RECONSTRUCTION

**NOTES:**

- SHOULDER SHALL BE RECONSTRUCTED AS SHOWN IN STD. DWG. NO. 560.01 & 560.02, WITH A MINIMUM SLOPE OF 1" PER FOOT TO ENSURE POSITIVE DRAINAGE AWAY FROM ROADWAY.
- AGGREGATE SHOULDER BORROW (ASB) MATERIAL SHALL BE PLACED USING A WIDENING MACHINE OR SIMILAR DEVICE AND COMPACTED USING A ROLLER ASB SHALL TIE FLUSH TO PAVEMENT AND EXISTING SHOULDER.

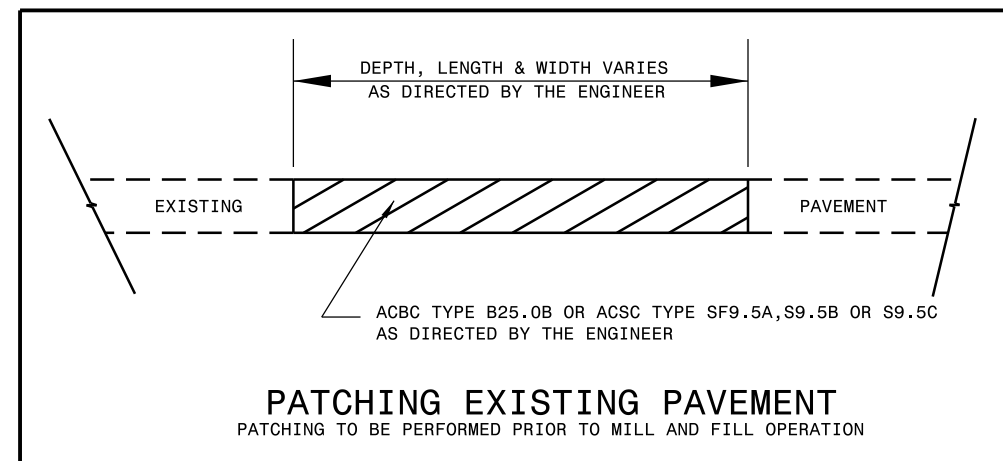

### PATCHING EXISTING PAVEMENT

PATCHING TO BE PERFORMED PRIOR TO MILL AND FILL OPERATION

**NOTES TO CONTRACTOR**

FOR SURFACE MIXES OVER 1" IN THICKNESS, MILL THE EXISTING PAVEMENT IN ACCORDANCE WITH THE FOLLOWING SKETCH AS DIRECTED BY THE ENGINEER.

LOCATIONS SHALL INCLUDE TIES INTO EXISTING CONCRETE PAVEMENT, AT BRIDGE APPROACHES WHERE THE BRIDGE WILL NOT BE RESURFACED, AND AT THE BEGINNING AND ENDING POINT OF EACH RESURFACING MAP.

PERFORM THE WORK IN ACCORDANCE WITH SECTION 607 OF THE JANUARY 2018 NORTH CAROLINA DEPARTMENT OF TRANSPORTATION STANDARD SPECIFICATIONS FOR ROADS AND STRUCTURES. RESURFACING WILL BE ACCOMPLISHED AT THE SAME TIME AS THE MILLING OPERATION.

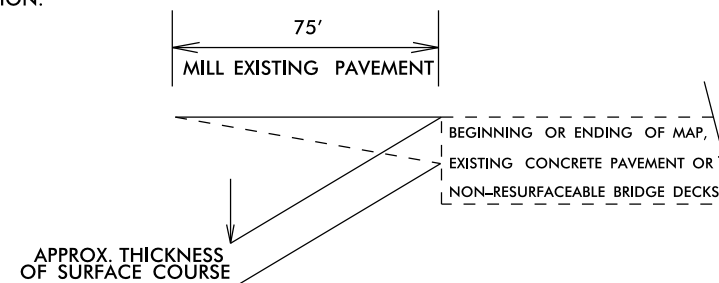

### MILLING AT PAVEMENT TIE-INS DETAIL

- NOTES:
- 1) DETAIL DOES NOT APPLY TO OGAFc AND ULTRA-THIN BONDED WEARING COURSE.
  - 2) BACKFILL SHOULDER WITH APPROVED MATERIAL.
  - 3) THE SHOULDER WEDGE DEVICE MAY BE DISENGAGED AT PAVED DRIVEWAYS AND SIDE STREETS.

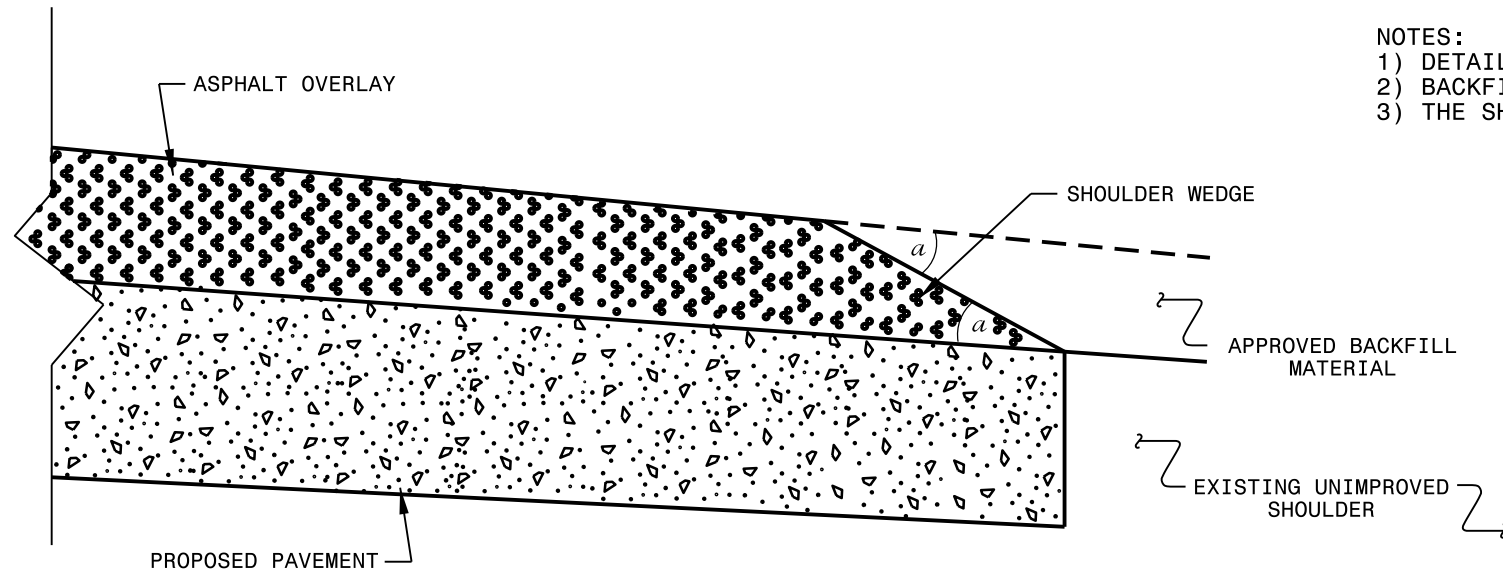

**SHOULDER WEDGE DETAIL**  
(Resurfacing Projects w/ Widening or  
with Existing Paved Shoulder having no dropoffs)

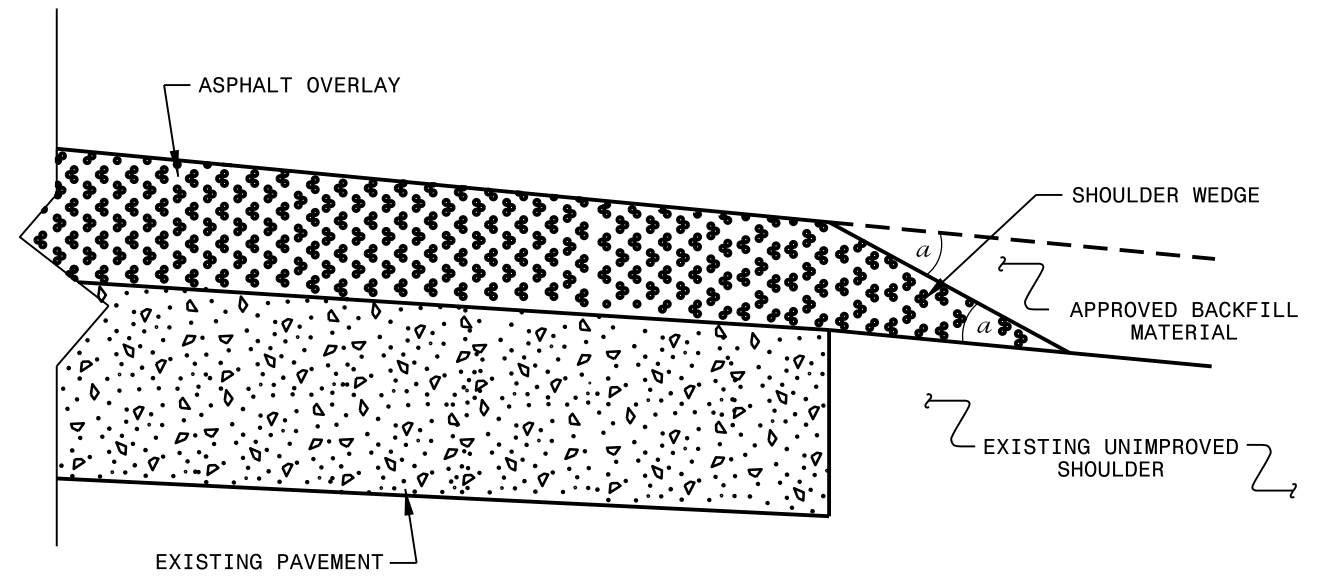

**SHOULDER WEDGE DETAIL**  
(Resurfacing Projects w/ NO Widening)

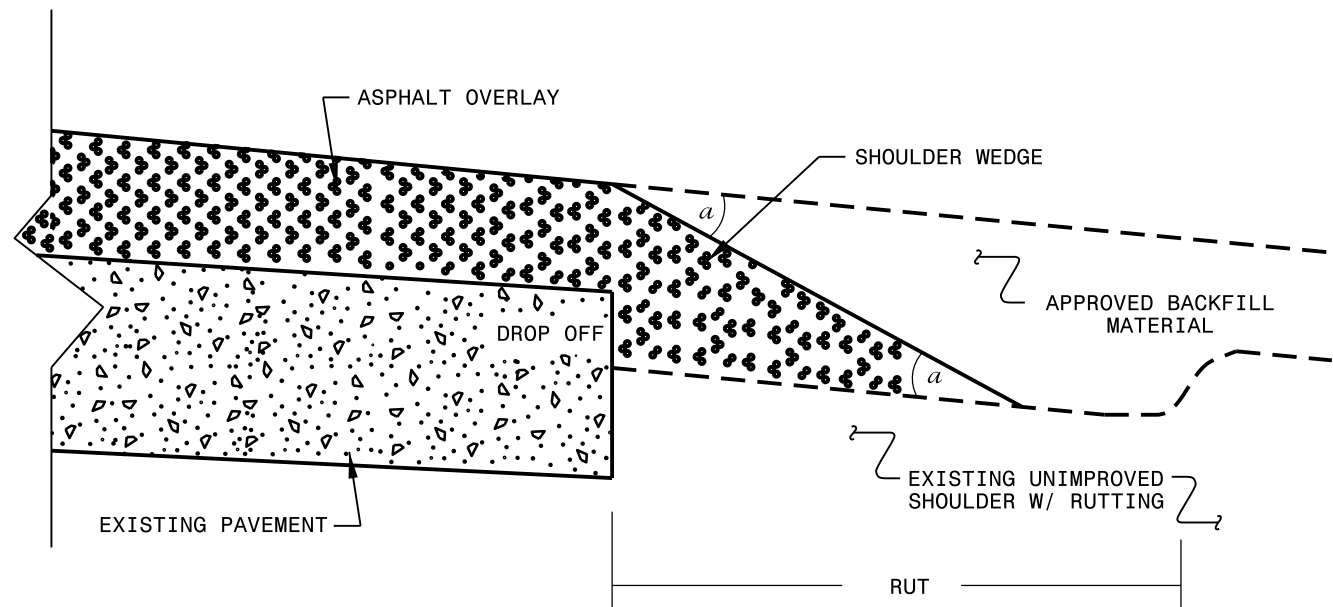

**SHOULDER WEDGE DETAIL**  
(Resurfacing Adjacent to  
Rutted Shoulder)

- SHOULDER WEDGE ANGLE = 30°

<b>CONTRACT STANDARDS AND DEVELOPMENT UNIT</b>			
Office 919-707-6950		FAX 919-250-4119	
<b>SHOULDER WEDGE DETAILS</b>			
ORIGINAL BY: T.SPELL	DATE: 7-19-11		
MODIFIED BY:	DATE: 10/16/12		
CHECKED BY:	DATE:		
FILE SPEC.: susr/details/stand/shoulderwedgedetail.dgn			

SYSTEM: 06/07/2009  
 USER: T.SPELL  
 FILE: susr/details/stand/shoulderwedgedetail.dgn

# SIGNING FOR RESURFACING PROJECTS

**LEGEND**

┆ STATIONARY SIGN

← DIRECTION OF TRAFFIC FLOW

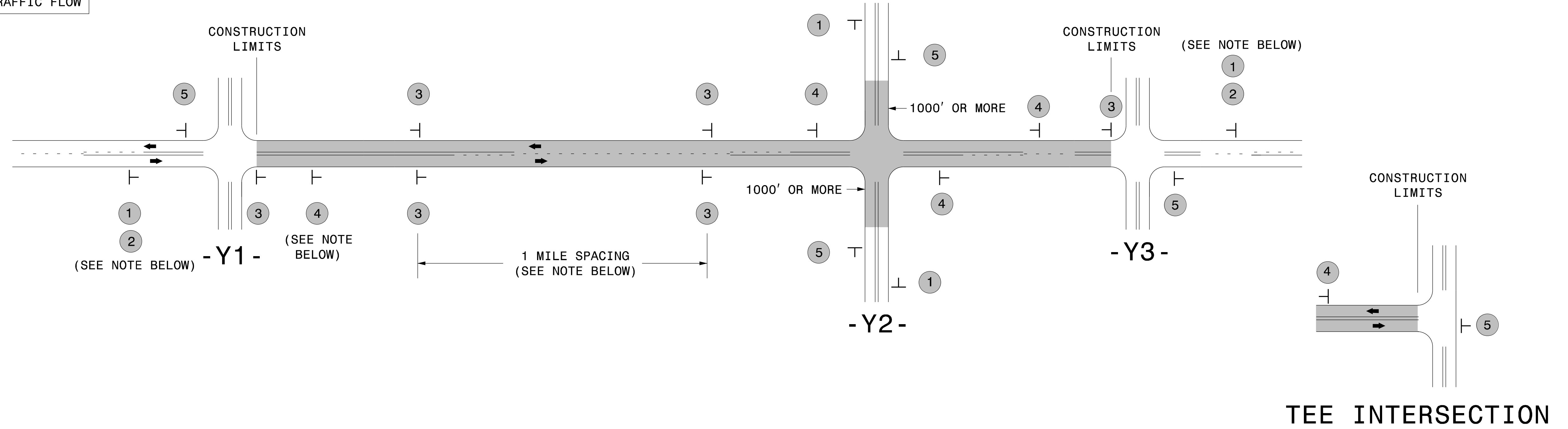

## MAINLINE (-L-) SIGNING

## -Y- LINE SIGNING

SIGNING NOTES AND PLACEMENT PER DIRECTION	1	 W20-1 48" X 48"	PLACE 1000' PRIOR TO BEGINNING OF CONSTRUCTION LIMITS. ONLY USED ON -Y- LINES IF RESURFACING LIMITS EXTEND 1000' ALONG -Y- LINE.	<p>NO REQUIRED STATIONARY SIGNING FOR THE FOLLOWING -Y- LINE CONDITIONS:</p> <ol style="list-style-type: none"> <li>1) LESS THAN 1000' OF RESURFACING ALONG -Y- LINE</li> <li>2) SUBDIVISION ROADS</li> <li>3) DEAD END ROADS</li> </ol> <p>WHEN PAVING/CONSTRUCTION ACTIVITIES PROCEED ACROSS AN UNSIGNED -Y- LINE, PORTABLE ADVANCE WARNING SIGNS SHALL BE USED ALONG THE -Y- LINE AS SHOWN BELOW. REMOVE UPON COMPLETION OF WORK.</p> <div style="display: flex; justify-content: space-around;"> <div style="text-align: center;"> <p>W20-1 48" X 48"</p> <p>PLACED 500' IN ADVANCE OF FLAGGER.</p> </div> <div style="text-align: center;"> <p>W20-7 A 48" X 48"</p> <p>PLACED 250' IN ADVANCE OF FLAGGER.</p> </div> </div>
	2	 NEXT XX MILES W7-3aP 24" X 18"	#2 SIGN ONLY USED WHEN CONSTRUCTION LIMITS ARE 2 OR MORE MILES IN LENGTH. ROUND UP TO NEXT WHOLE NUMBER. (NO FRACTIONAL OR DECIMAL NUMBERS)	
	3	 LOW/SOFT SHOULDER SP 13107 48" X 48"	<ul style="list-style-type: none"> <li>- PLACE INITIALLY AT THE CONSTRUCTION LIMITS AND SPACE 1 MILE APART THEREAFTER.</li> <li>- AT TEE INTERSECTIONS INSTALL INITIALLY 1/2 MILE FROM INTERSECTION AND SPACE 1 MILE APART THEREAFTER.</li> </ul>	
	4	 ROAD UNDER CONST SP 13106 48" X 48"	<ul style="list-style-type: none"> <li>- THESE ARE FOR -Y- LINES THAT ARE "THROUGH" ROADWAYS.</li> <li>- DEAD END AND SUBDIVISION ROADS ARE NOT "THROUGH" ROADWAYS.</li> <li>- INSTALL 500' +/- FROM EACH -Y- LINE APPROACH AS SHOWN ABOVE.</li> <li>- FOR MULTIPLE -Y- LINES THAT ARE SEPARATED BY 0.25 MILES OR LESS, TREAT AS A SINGLE UNIT AND INSTALL WITHIN 500' OF EACH APPROACH.</li> <li>- A MAXIMUM OF 2 SIGN SETS PER MILE. DO NOT INSTALL WHEN -Y- LINES ARE WITHIN 0.5 MILES FROM "END ROAD WORK" SIGN.</li> <li>- FOR TEE INTERSECTIONS, INSTALL WITHIN 500' +/- OF THE INTERSECTION ALONG -L- LINE.</li> </ul>	
	5	 END ROAD WORK G20-2 A 48" X 24"	PLACE 500' FOLLOWING THE END OF CONSTRUCTION LIMITS OR AS SHOWN WHEN WORK ENDS AT A 3-WAY TEE INTERSECTION.	

THE ABOVE SIGNS ARE ALL THAT ARE REQUIRED FOR A CONTRACTOR TO BEGIN A RESURFACING CONTRACT. ANY ADDITIONAL SIGNS REQUESTED BY NCDOT DIVISIONS SHALL BE INSTALLED WITHIN 7 BUSINESS DAYS OF THE START OF CONTRACT WORK.

## MAPS LESS THAN 2 MILES

FOR RESURFACING MAPS WITH CONSTRUCTION LIMITS LESS THAN 2 MILES IN LENGTH, NO STATIONARY SIGNS ARE REQUIRED. USE PORTABLE "ROAD UNDER CONSTRUCTION" OR "ROAD WORK AHEAD" SIGNS IN LIEU OF STATIONARY ADVANCE WARNINGS SIGNS.

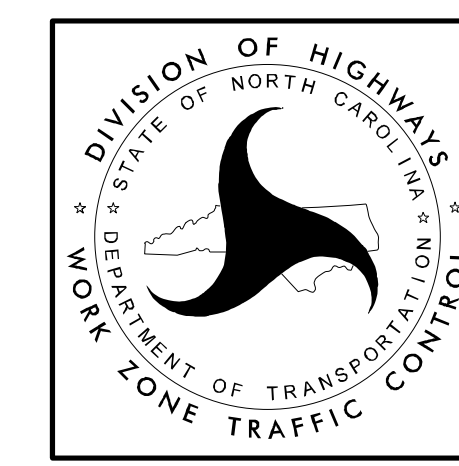

ADVANCE WARNING SIGNS FOR RURAL AND SUBURBAN 2-LANE ROADWAY RESURFACING

## URBAN / SUBURBAN WORKZONES

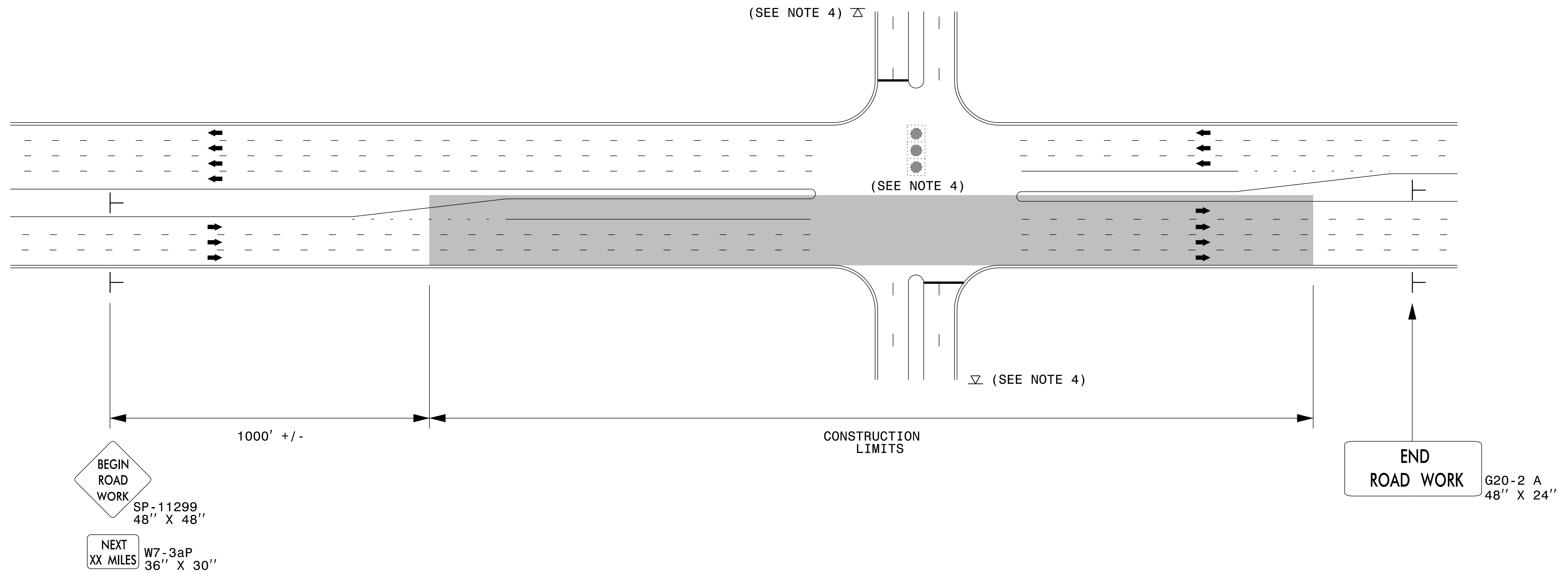

### NOTES:

- 1) 48" x 48" SIZED SIGNS (SP- 11299) MAY BE REDUCED TO 36" X 36" ON ROADWAYS WITH SPEED LIMITS OF 40 MPH OR LESS.
- 2) MOUNT SIGNS THAT ARE LARGER THAN 10 SQUARE FEET IN AREA ON TWO OR MORE WOOD OR U-CHANNEL SUPPORTS. PERFORATED SQUARE TUBING SUPPORT SYSTEMS MAY SUPPORT LARGER AREAS ON A SINGLE SUPPORT. FOLLOW MANUFACTURER'S RECOMMENDATIONS. THESE SYSTEMS SHALL BE NCHRP 350 COMPLIANT AND NCDOT APPROVED.
- 3) ADVANCE WARNING SIGNS NOT REQUIRED ON NON-SIGNALIZED SIDE STREETS.
- 4) MAY USE LAW ENFORCEMENT TO CONTROL TRAFFIC AT SIGNALIZED INTERSECTIONS AS DIRECTED BY THE ENGINEER. PROVIDE PORTABLE "ROAD WORK AHEAD" (W20-1) SIGNS 500' IN ADVANCE ALONG BOTH APPROACHES FROM THE SIDE STREETS WHEN PAVING PROCEEDS THROUGH THE INTERSECTION.
- 5) LATERAL CLEARANCE AT ALL SIGN LOCATIONS SHALL BE 2' AS MEASURED FROM THE EDGE OF PAVEMENT OR THE FACE OF THE CURB. WHEN UNABLE TO OBTAIN THE LATERAL CLEARANCE WITHIN THE MEDIAN AREA USE SHOULDER MOUNTS ONLY.
- 6) SIGN MOUNT LOCATIONS SHALL NOT BLOCK SIDEWALKS OR DRIVEWAYS.
- 7) IF STATIONARY GENERAL WARNING SIGNS ARE USED, THEY WILL BE PAID FOR PER SECTION 104 OF THE NCDOT STANDARD SPECIFICATIONS AS EXTRA WORK.
- 8) IF MILLED AREAS ARE NOT PAVED BACK BY THE END OF THE WORK DAY, PORTABLE SIGNS SHALL BE USED TO WARN DRIVERS OF THE PRESENT CONDITIONS. THESE ARE TO INCLUDE, BUT NOT LIMITED TO "ROUGH ROAD" W8-8, "UNEVEN LANES" W8-11, "GROOVED PAVEMENT" W8-15 w/MOTORCYCLE PLAQUE MOUNTED BELOW. THESE ARE TO BE DOUBLE INDICATED ON MULTI-LANE ROADWAYS WITH SPEED LIMITS 45 MPH AND GREATER WHERE LATERAL CLEARANCE CAN BE OBTAINED WITHIN THE MEDIAN AREAS. THESE PORTABLE SIGNS ARE INCIDENTAL TO THE OTHER ITEMS OF WORK INCLUDED IN THE TEMPORARY TRAFFIC CONTROL (LUMP SUM) PAY ITEM.

### LEGEND

- ┆ STATIONARY SIGN
- ➔ DIRECTION OF TRAFFIC FLOW

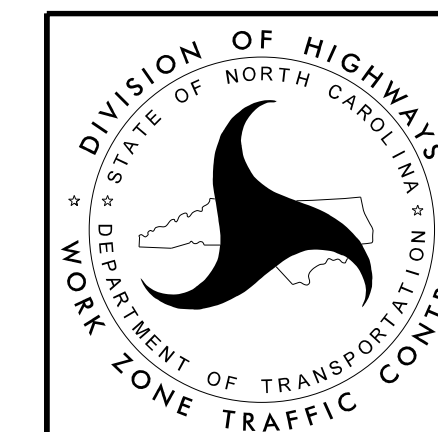

**RESURFACING ADVANCE  
WARNING SIGNS FOR  
URBAN / SUBURBAN  
FACILITIES**



### High Speed Detection (≥40 mph)

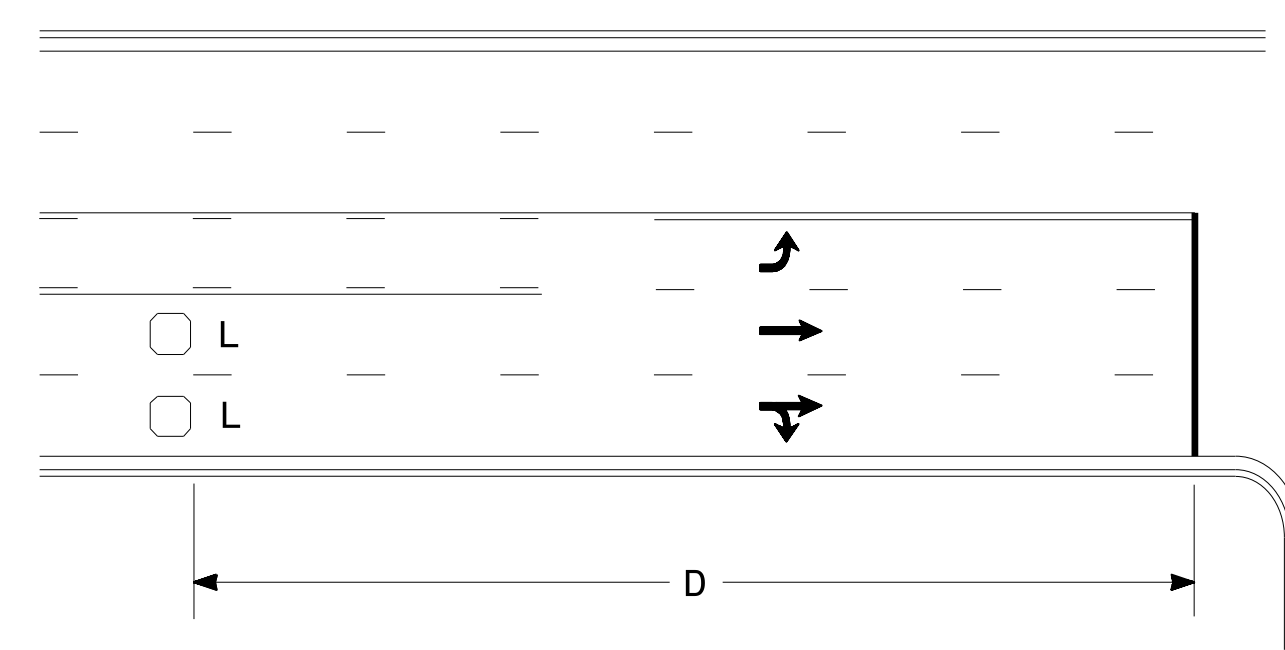

Speed Limit mph	D ft
40	250
45	300
50	355
55	420

L = 6ft X 6ft  
Wired in series for TS1  
Controllers  
Wired separately for TS2,  
170, and 2070L Controllers

Volume Density Operation

OR

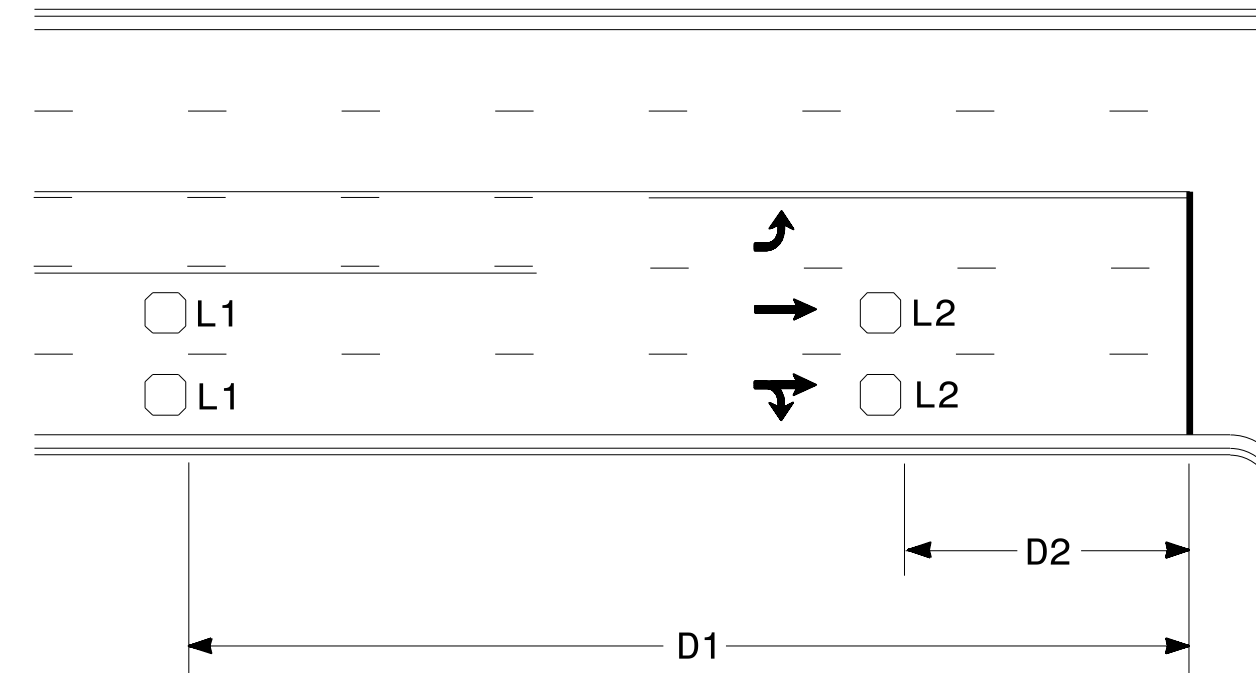

Speed Limit mph	D1 ft	D2 ft
40	250	80
45	300	90
50	355	100
55	420	110

L1 = 6ft X 6ft  
Wired in series  
L2 = 6ft X 6ft  
Wired in series

"Stretch" Operation

### Low Speed Detection (≤35 mph)

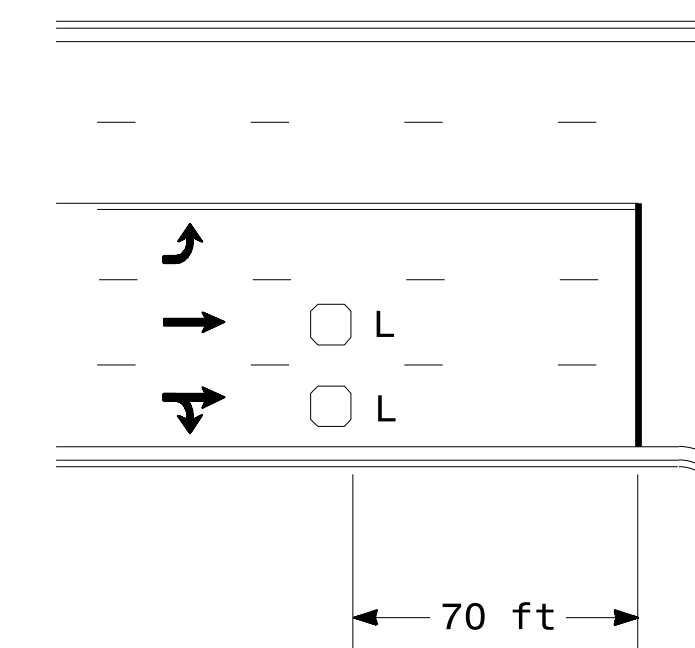

L = 6ft X 6ft  
Wired in series

OR

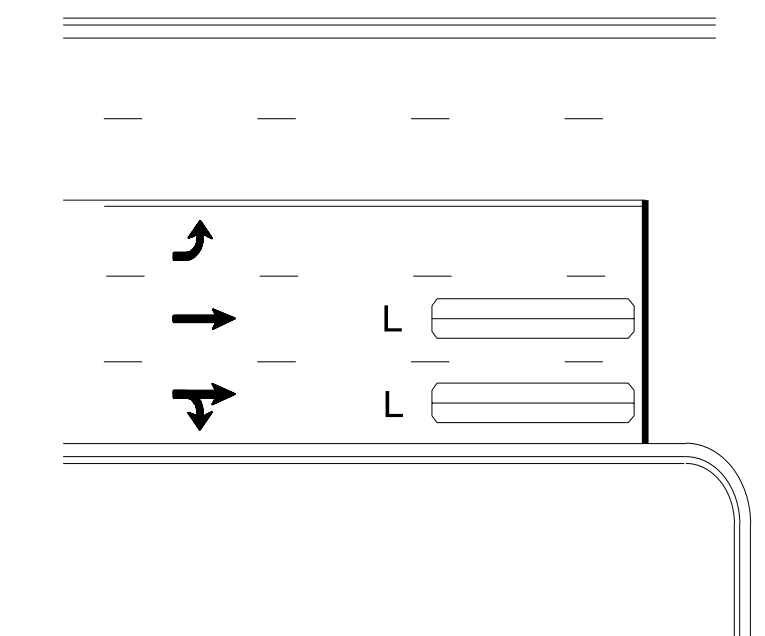

L = 6ft X 40ft  
Quadrupole loop, wired separately

### Left Turn Lane Detection

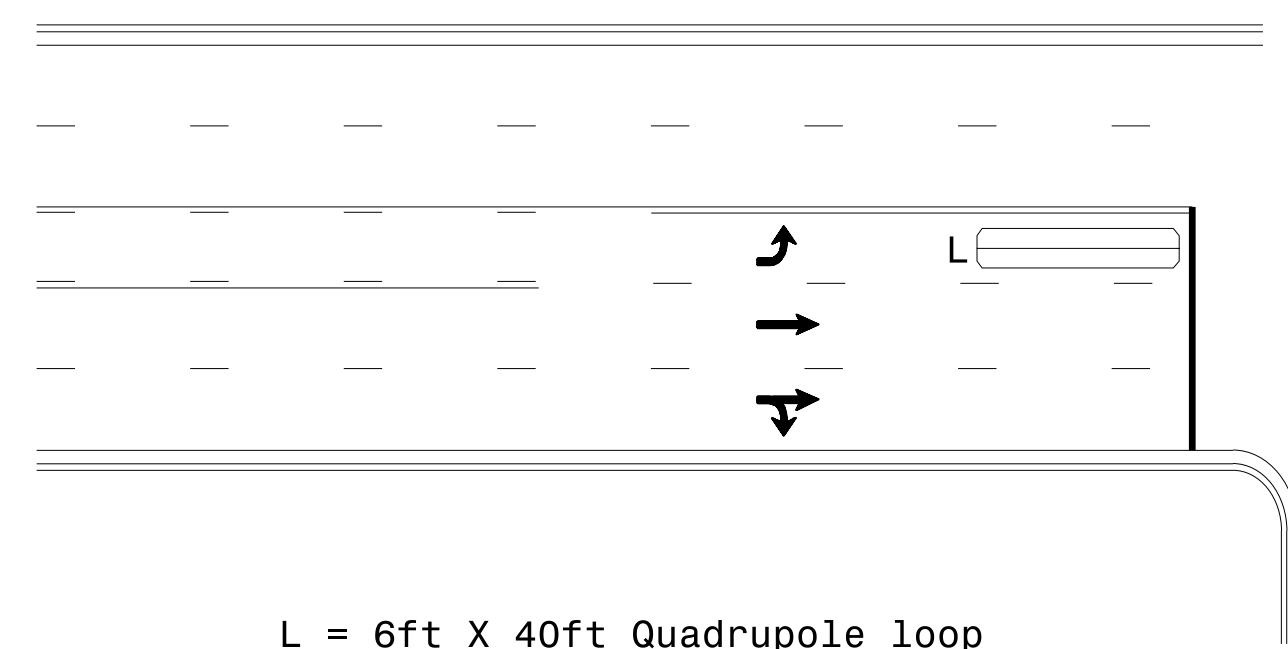

L = 6ft X 40ft Quadrupole loop

Presence Loop Detection

OR

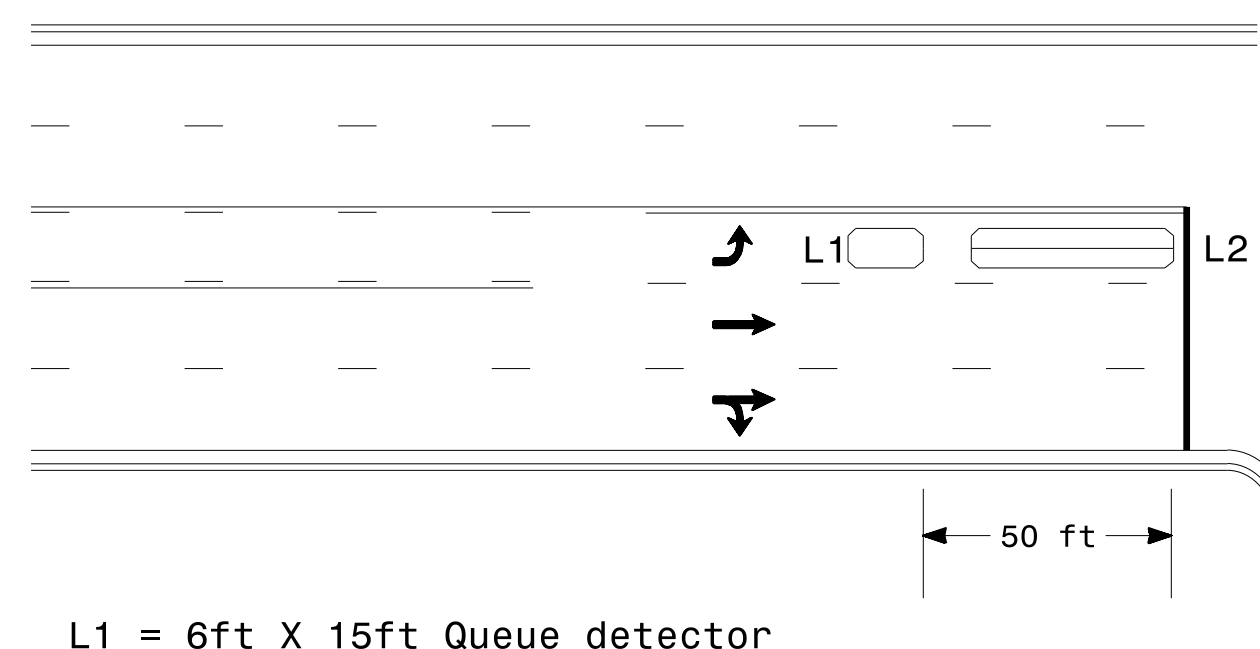

L1 = 6ft X 15ft Queue detector  
L2 = 6ft X 40ft Quadrupole loop

Queue Loop Detection

### Right Turn Lane Detection

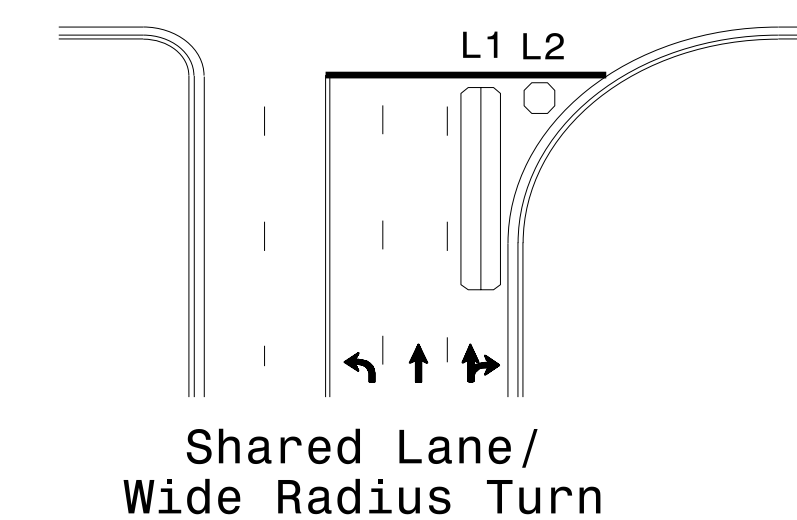

Shared Lane/  
Wide Radius Turn

L1 = 6ft X 40ft Quadrupole loop  
L2 = 6ft X 6ft [Minimum] Presence loop  
Wired separately

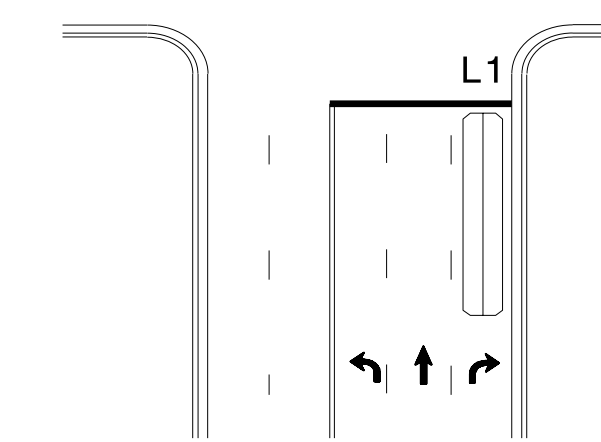

Standard Turn

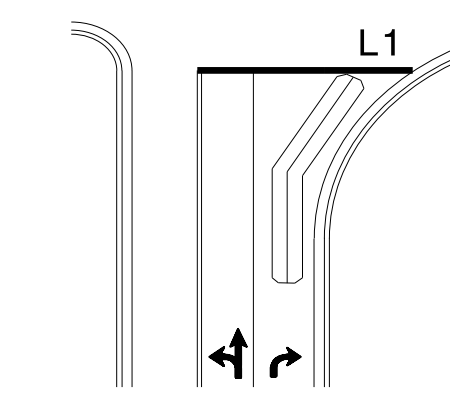

Wide Radius Turn

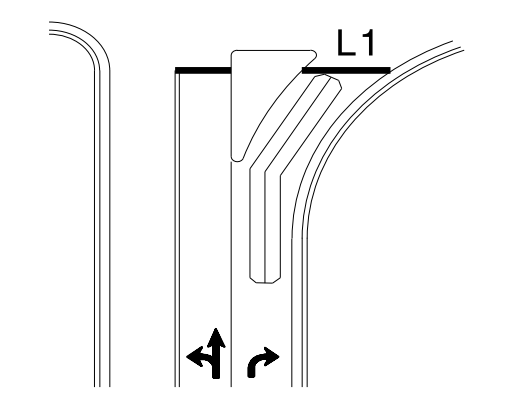

Channelized Turn

### Side Street Detection

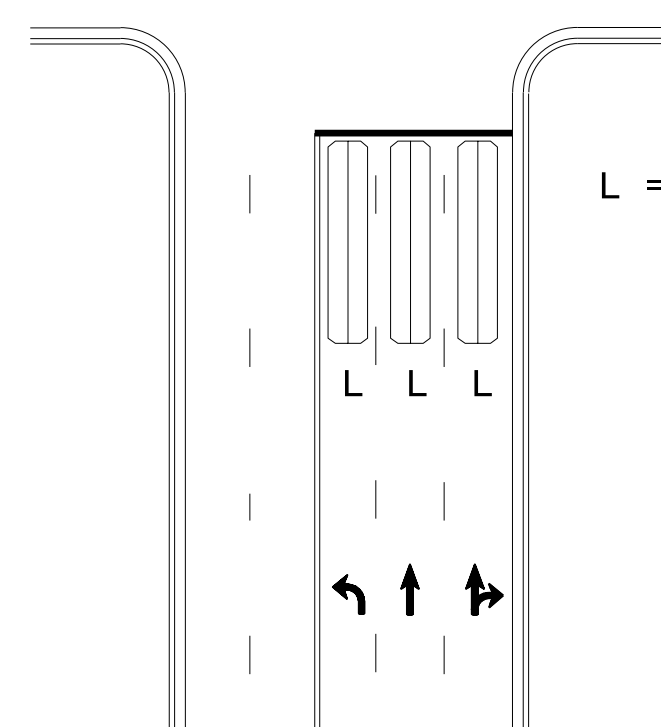

L = 6ft X 40ft  
Quadrupole loop  
Wired to separate  
detectors/channels

### Presence Loop Placement at Stop Lines

Locate loop slightly  
behind leading  
edge of stop line

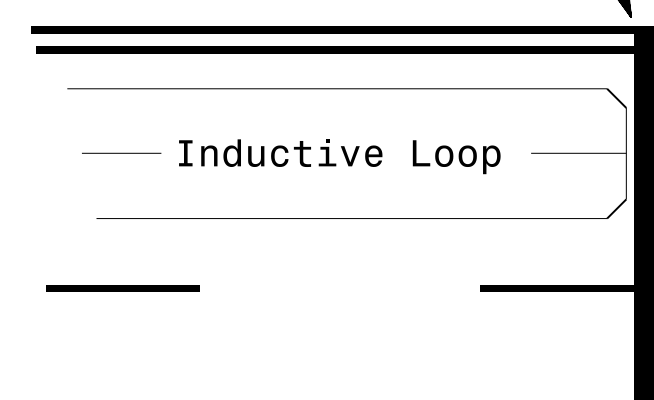

Note:

- Loop may be located in advance of stop line under any of the following conditions:
- 1) stop line is greater than 15' from edge of intersecting roadway
  - 2) loop detects a permissive or protected/permissive left turn
  - 3) for an exclusive right turn lane

### Recommended Number of Turns

Single 6' X 6' loop  
(when wired separately):

Length of Lead-in ft	Number of Turns
< 250	3
250-375	4
375-525	5
> 525	6

Quadrupole loops: Use 2-4-2 turns

6' X 15' Loops:

- Lead-in < 150', use 2 turns
- Lead-in > 150', use 3 turns

	<p>Prepared In the Offices of:</p> <p>TRANSPORTATION MOBILITY AND SAFETY DIVISION DEPARTMENT OF TRANSPORTATION SIGNAL DESIGN SECTION</p> <p>750 N. Greenfield Pkwy, Garner, NC 27529</p>		<p>SEAL NORTH CAROLINA PROFESSIONAL ENGINEER PAMELA L. ALEXANDER 23489</p>	
	<p>PLAN DATE: January 2015</p> <p>REVIEWED BY: JPG</p>		<p>REVISIONS</p> <p>INIT. DATE</p>	
<p>SCALE N/A</p>		<p>PREPARED BY: PLA</p> <p>REVIEWED BY:</p>		<p>DocuSigned by: P. Alexander 1/30/2015 10:44:44 AM</p>
		<p>SIG. INVENTORY NO.</p>		



**GUIDELINES FOR LANE WIDTHS ON RESURFACING PROJECTS**

Contractor shall place the new pavement markings in accordance with this table and detail unless otherwise directed by the Engineer.

<b>TWO LANE - TWO WAY ROADWAY - 55 MPH</b>		
ROADWAY WIDTH	LANE WIDTH	SHOULDER WIDTH
18'	9' *	0'
20'	10' *	0'
22'	10'	1'
24'	10'	2'
26'	11'	2'
28'	12'	2'
32'	12'	4'

\* May vary due to pavement width

<b>TWO LANE - TWO WAY ROADWAY</b>		<b>50</b>
<b>MPH OR LESS</b>		
ROADWAY WIDTH	LANE WIDTH	SHOULDER WIDTH
18'	9' *	0'
20'	10' *	0'
22'	10'	1'
24'	10'	2'
26'	11'	2'
28'	11'	3'
32'	11'	5'

\* May vary due to pavement width

**SCHEMATIC OF ROADWAY**

(NOT TO SCALE)

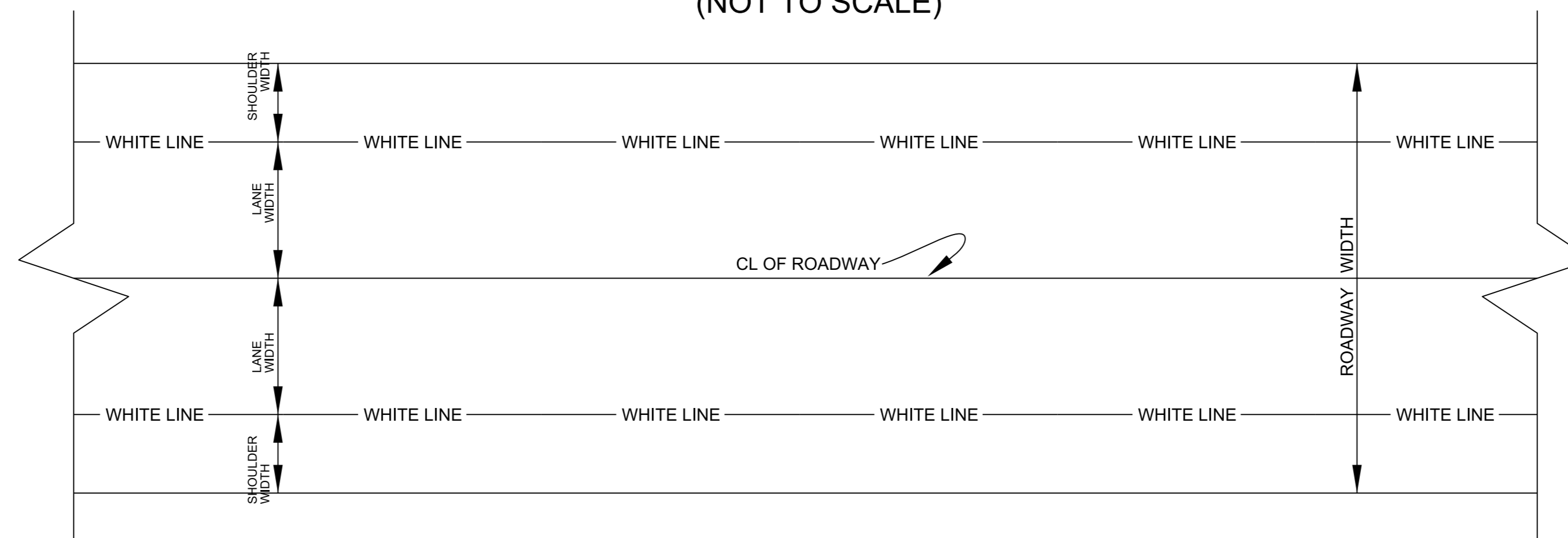

PROJECT NO.	SHEET NO.	TOTAL NO.
PT.06.07.20091.1, 2024CPT.06.07.2		

### SUMMARY OF QUANTITIES

PROJECT NO	COUNTY	MAP NO	ROUTE	DESCRIPTION	TYP NO	LANES	LANE TYPE	FINAL SURFACE TESTING REQUIRED	WARM MIX ASPHALT REQUIRED	LENGTH	WIDTH	BEGIN MP	END MP	1220000000-E	1245000000-E	1260000000-E	1330000000-E	1491000000-E	1503000000-E	1519000000-E	1520000000-E	1575000000-E	1704000000-E	
														INCIDENTAL STONE BASE	SHOULDER RECONSTRUCTION	AGGREGATE SHOULDER BORROW	INCIDENTAL MILLING	BASE COURSE, B25.0C	INTERMEDIATE COURSE, I19.0C	SURFACE COURSE, S9.5B	LEVELING COURSE, S9.5B	ASPHALT BINDER FOR PLANT MIX	PATCHING EXISTING PAVEMENT	
														TONS	SMI	TON	SY	TONS	TONS	TONS	TONS	TONS	TONS	
2024CPT.06.07.20091.1	Bladen	2	SR-1745 / BALTIMORE RD	FROM SR 1730 TO NC 87	2	2		NO	NO	2.69	22	0	2.69	10	5.38	807			1,637			79		
<b>TOTAL FOR MAP NO. 2</b>										<b>2.69</b>				<b>10</b>	<b>5.38</b>	<b>807</b>			<b>1,637</b>			<b>79</b>		
2024CPT.06.07.20091.1	Bladen	3	SR-1730 / S ELWELL FERRY RD	FROM NC 211 TO SR 1745	1	2	2WU	NO	NO	2.01	20	2.78	4.79	10	4.02	603	170	260		2,216	20	158	10	
<b>TOTAL FOR MAP NO. 3</b>										<b>2.01</b>				<b>10</b>	<b>4.02</b>	<b>603</b>	<b>170</b>	<b>260</b>		<b>2,216</b>	<b>20</b>	<b>158</b>	<b>10</b>	
<b>TOTAL FOR PROJ NO. 2024CPT.06.07.20091.1</b>										<b>4.7</b>				<b>20</b>	<b>9.40</b>	<b>1,410</b>	<b>170</b>	<b>260</b>		<b>1,637</b>	<b>2,216</b>	<b>20</b>	<b>237</b>	<b>10</b>
2024CPT.06.07.20241.1	Columbus	1	SR-1800 / BLACKSMITH RD	SR 1800 FROM SR 1802 TO NC 211	1	2	2WU	NO	NO	1.24	20	3.15	4.39	10	2.48	409	170	170		1,268		90		
<b>TOTAL FOR MAP NO. 1</b>										<b>1.24</b>				<b>10</b>	<b>2.48</b>	<b>409</b>	<b>170</b>	<b>170</b>		<b>1,268</b>		<b>90</b>		
<b>TOTAL FOR PROJ NO. 2024CPT.06.07.20241.1</b>										<b>1.24</b>				<b>10</b>	<b>2.48</b>	<b>409</b>	<b>170</b>	<b>170</b>		<b>1,268</b>		<b>90</b>		
<b>GRAND TOTAL</b>										<b>5.94</b>				<b>30</b>	<b>11.88</b>	<b>1,819</b>	<b>340</b>	<b>430</b>		<b>1,637</b>	<b>3,484</b>	<b>20</b>	<b>327</b>	<b>10</b>

PROJECT NO.	SHEET NO.	TOTAL NO.
.06.07.20091.1, 2024CPT.06.07		

## THERMOPLASTIC AND PAINT QUANTITIES

PROJECT NO	COUNTY	MAP NO	ROUTE	DESCRIPTION	TYP NO	LANES	LANE TYPE	LENGTH	WIDTH	BEGIN MP	END MP	4413000000-E	4457000000-N	4685000000-E		4720000000-E	4830000000-E	4835000000-E	4840000000-N	4709000000-E	4891000000-E	4900000000-N	
												WORK ZONE ADVANCE/GENERAL WARNING SIGNING	TEMPORARY TRAFFIC CONTROL	4" X 90 M WHITE THERMO	4" X 90 M YELLOW THERMO	THERMO MSG RXR 90 M	16" WHITE PAINT	24" WHITE PAINT	PAINT MSG RXR	24" X 90 M WHITE THERMO	16" X 90 M WHITE THERMO(RXR CROSSBUCK)	YELLOW & YELLOW MARKERS	
								MI	FT			SF	LS	LF	LF	EA	LF	LF	EA	LF	LF	EA	
2024CPT.06.07.20091.1	Bladen	2	SR-1745 / BALTIMORE RD	FROM SR 1730 TO NC 87	2	2		2.69	22	0	2.69	184	1.00										
<b>TOTAL FOR MAP NO. 2</b>								<b>2.69</b>				<b>184</b>	<b>1</b>										
2024CPT.06.07.20091.1	Bladen	3	SR-1730 / S ELWELL FERRY RD	FROM NC 211 TO SR 1745	1	2	2WU	2.01	20	2.78	4.79	144		21,808	14,673	8	80	50	8	50	80	141	
<b>TOTAL FOR MAP NO. 3</b>								<b>2.01</b>				<b>144</b>		<b>21,808</b>	<b>14,673</b>	<b>8</b>	<b>80</b>	<b>50</b>	<b>8</b>	<b>50</b>	<b>80</b>	<b>141</b>	
<b>TOTAL FOR PROJ NO. 2024CPT.06.07.20091.1</b>								<b>4.7</b>				<b>328</b>	<b>1.000</b>	<b>21,808</b>	<b>14,673</b>	<b>8</b>	<b>80</b>	<b>50</b>	<b>8</b>	<b>50</b>	<b>80</b>	<b>141</b>	
												<b>36,481</b>											
2024CPT.06.07.20241.1	Columbus	1	SR-1800 / BLACKSMITH RD	SR 1800 FROM SR 1802 TO NC 211	1	2	2WU	1.24	20	3.15	4.39	96		10,560	9,300							93	
<b>TOTAL FOR MAP NO. 1</b>								<b>1.24</b>				<b>96</b>		<b>10,560</b>	<b>9,300</b>								<b>93</b>
<b>TOTAL FOR PROJ NO. 2024CPT.06.07.20241.1</b>								<b>1.24</b>				<b>96</b>		<b>10,560</b>	<b>9,300</b>								<b>93</b>
												<b>19,860</b>											
<b>GRAND TOTAL</b>								<b>5.94</b>				<b>424</b>	<b>1.000</b>	<b>32,368</b>	<b>23,973</b>	<b>8</b>	<b>80</b>	<b>50</b>	<b>8</b>	<b>50</b>	<b>80</b>	<b>234</b>	
												<b>56,341</b>											