

**This electronic collection of documents is provided
for the convenience of the user
and is Not a Certified Document –**

**The documents contained herein were originally issued
and sealed by the individuals whose names and license
numbers appear on each page, on the dates appearing
with their signature on that page.**

**This file or an individual page
shall not be considered a certified document.**

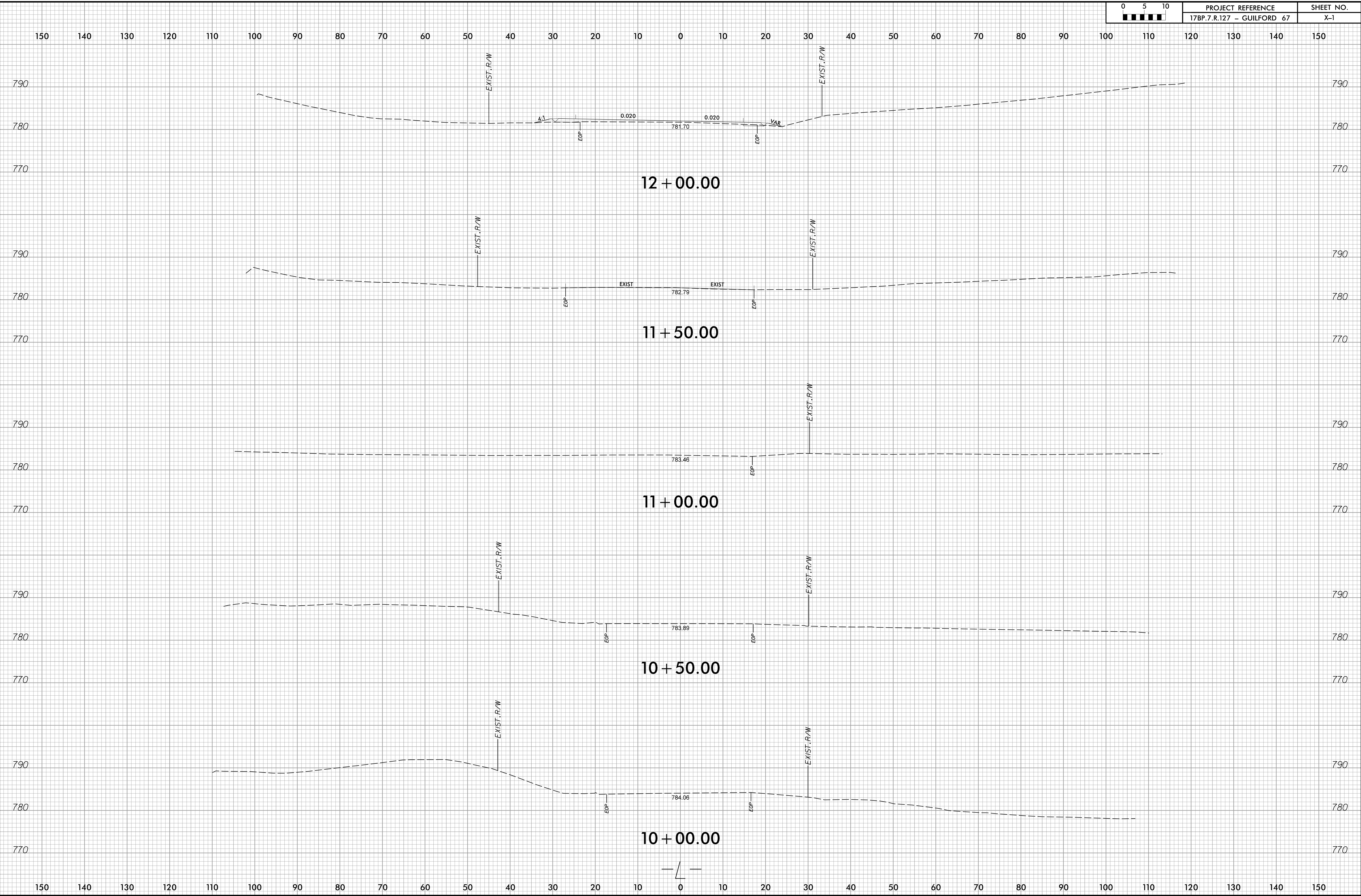

150 140 130 120 110 100 90 80 70 60 50 40 30 20 10 0 10 20 30 40 50 60 70 80 90 100 110 120 130 140 150

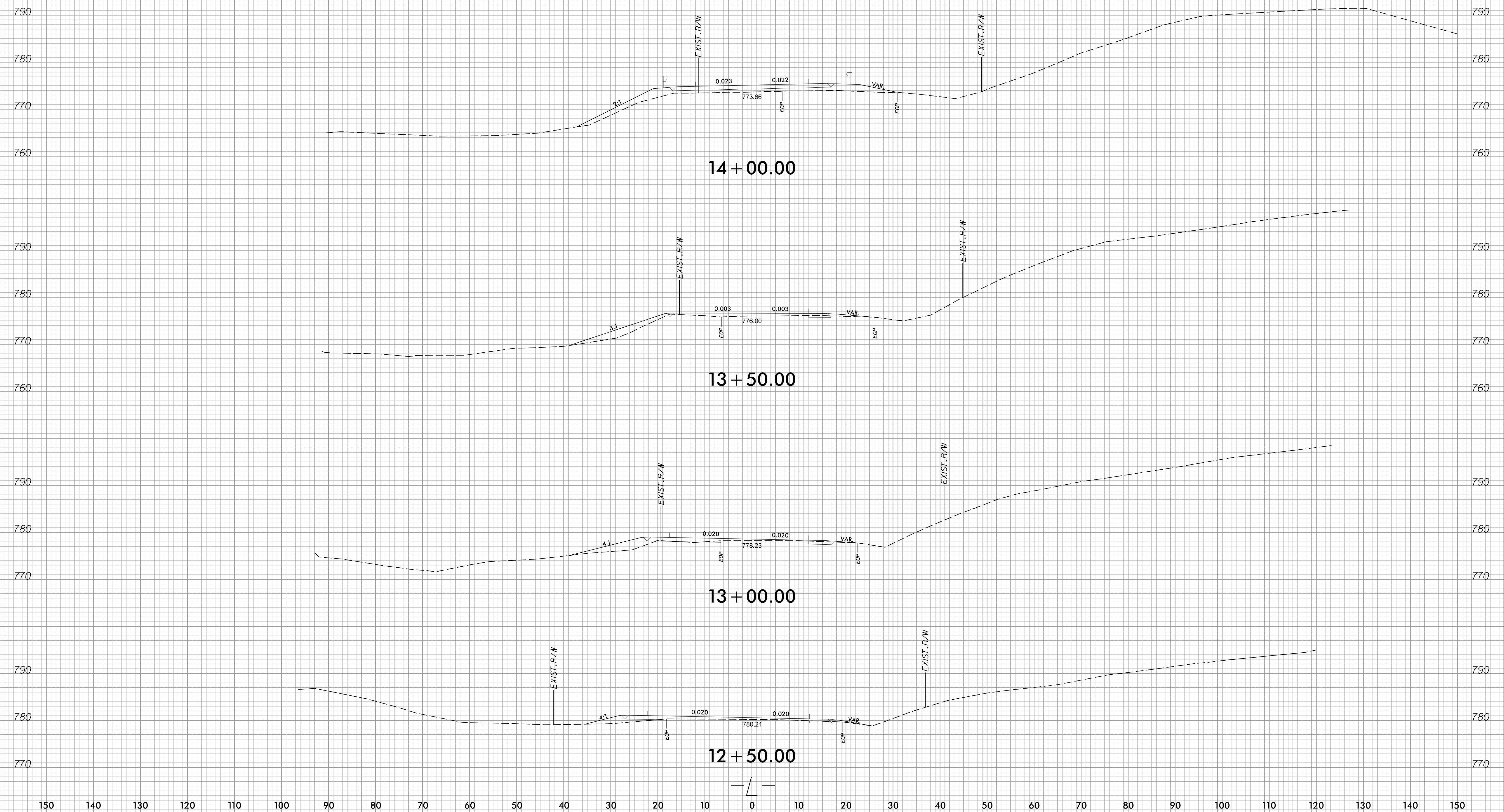

4/26/2021 7:13:52 AM
 R:\cadd\proj\17BP.7.R.127\17BP.7.R.127.dgn
 00863165

150 140 130 120 110 100 90 80 70 60 50 40 30 20 10 0 10 20 30 40 50 60 70 80 90 100 110 120 130 140 150

150 140 130 120 110 100 90 80 70 60 50 40 30 20 10 0 10 20 30 40 50 60 70 80 90 100 110 120 130 140 150

END BRIDGE 16 + 09.29

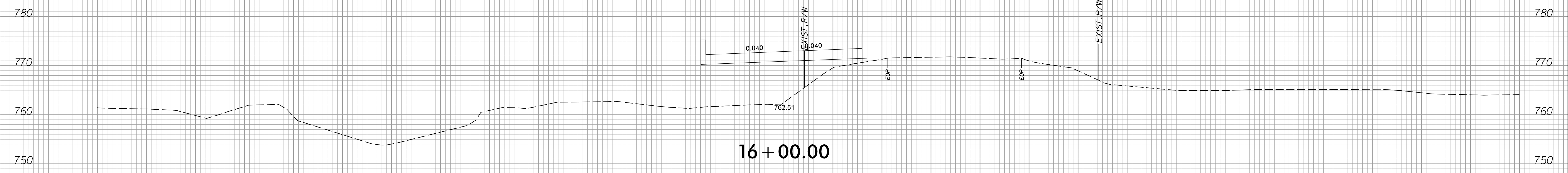

16 + 00.00

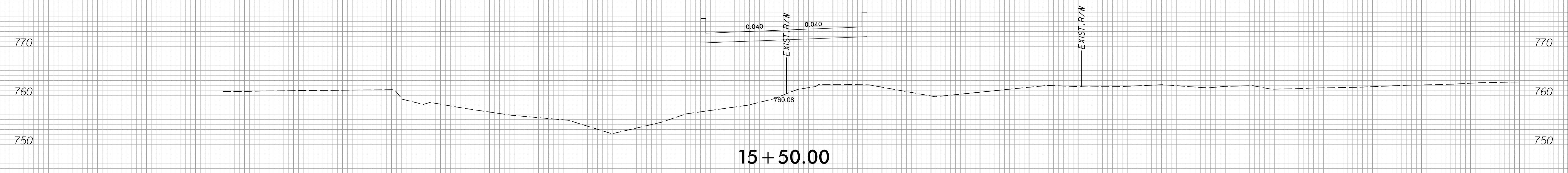

15 + 50.00

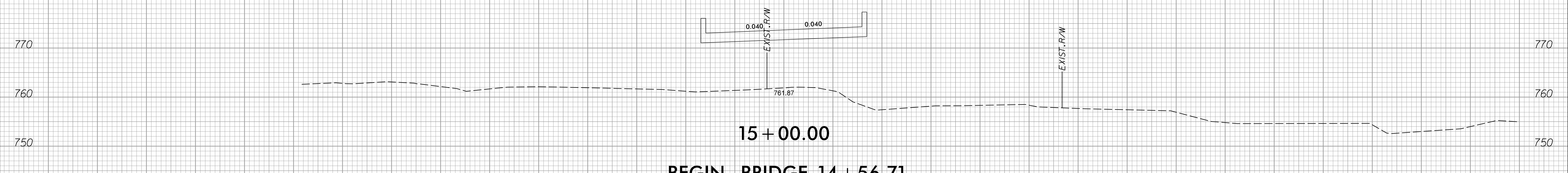

15 + 00.00

BEGIN BRIDGE 14 + 56.71

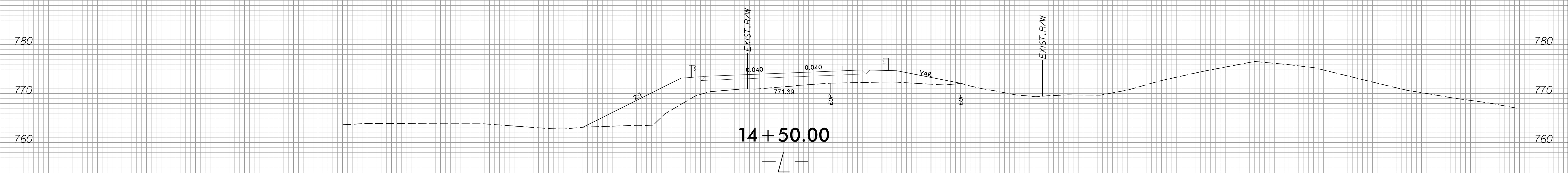

14 + 50.00

4/26/2021 7:13:56 AM
 R:\cadd\proj\17BP.7.R.127\17BP.7.R.127.dgn

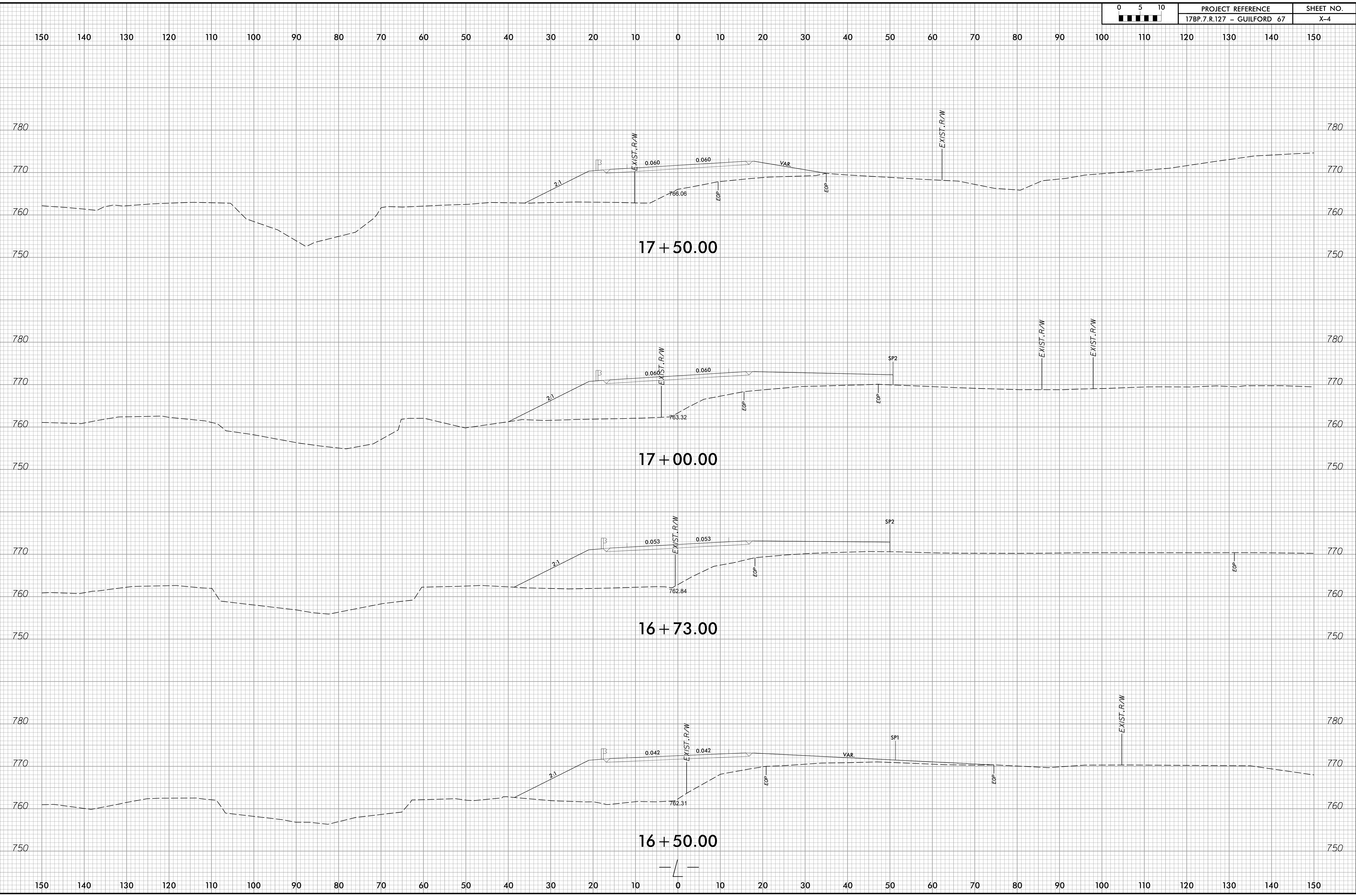

4/26/2021 7:13:59 AM
 R:\cadd\proj\17BP.7.R.127\17BP.7.R.127.dgn
 00863165

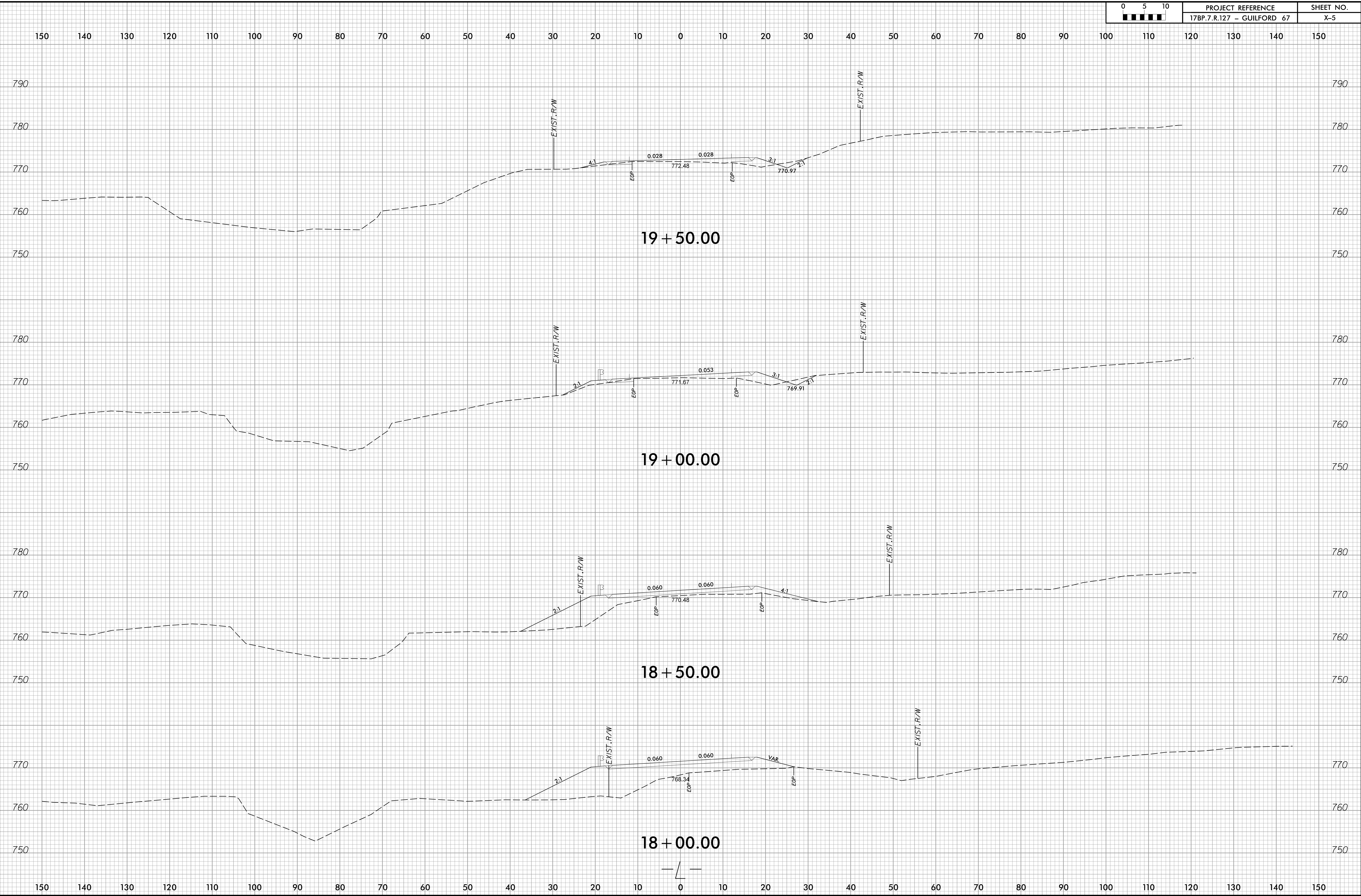

4/26/2021 7:44:02 AM
 R:\caddkey\Xsc\Xp\185714_rdy_xp1.L.dgn
 0086365

150 140 130 120 110 100 90 80 70 60 50 40 30 20 10 0 10 20 30 40 50 60 70 80 90 100 110 120 130 140 150

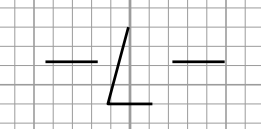
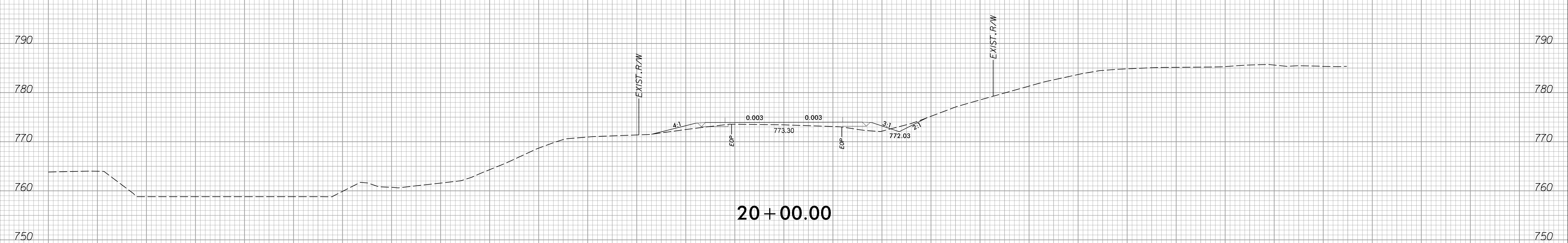
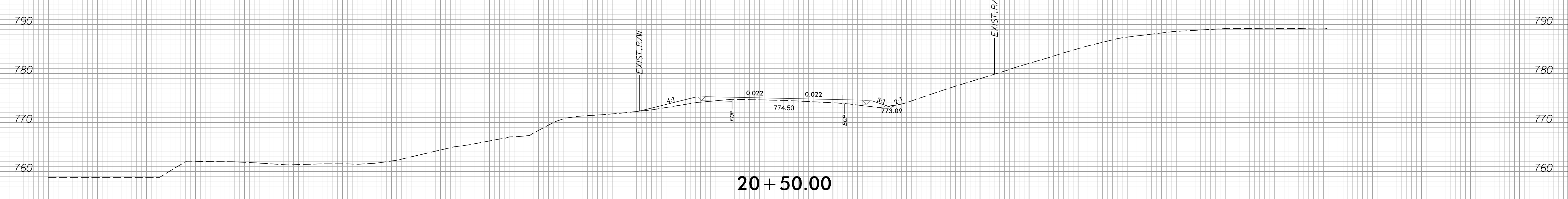
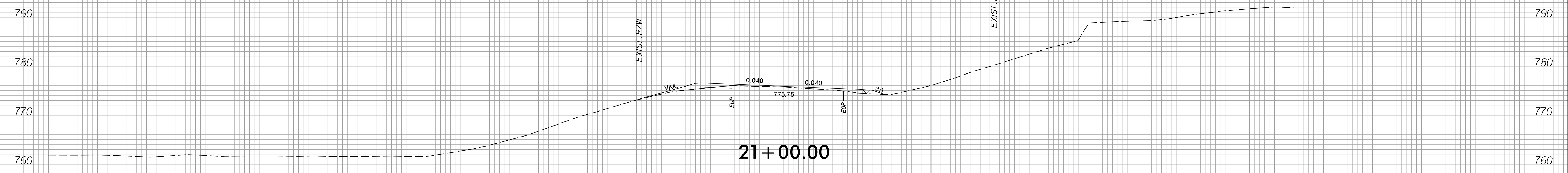

4/26/2021 7:44:04 AM
 R:\caddkey\Xsc\Xp\155714_rdy_xp1.L.dgn
 0086365

150 140 130 120 110 100 90 80 70 60 50 40 30 20 10 0 10 20 30 40 50 60 70 80 90 100 110 120 130 140 150

150 140 130 120 110 100 90 80 70 60 50 40 30 20 10 0 10 20 30 40 50 60 70 80 90 100 110 120 130 140 150

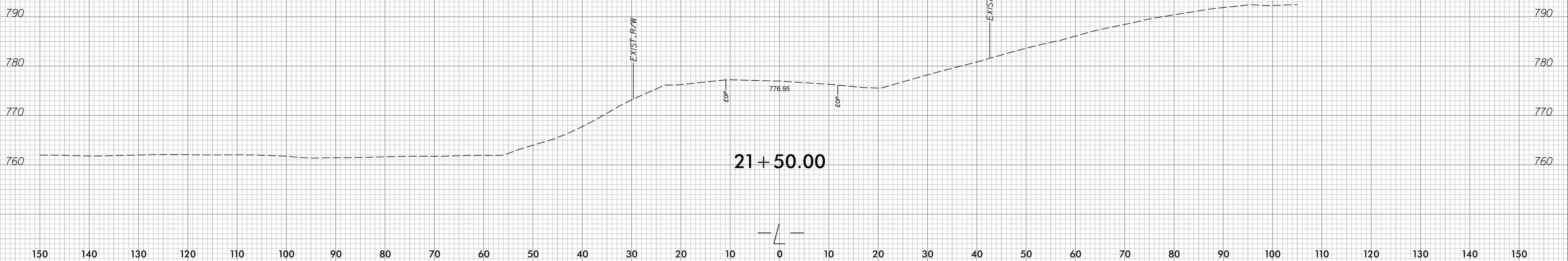

4/26/2021 7:44:06 AM
 R:\cadd\proj\17BP.7.R.127 - GUILFORD 67\17BP.7.R.127 - GUILFORD 67.dgn

150 140 130 120 110 100 90 80 70 60 50 40 30 20 10 0 10 20 30 40 50 60 70 80 90 100 110 120 130 140 150

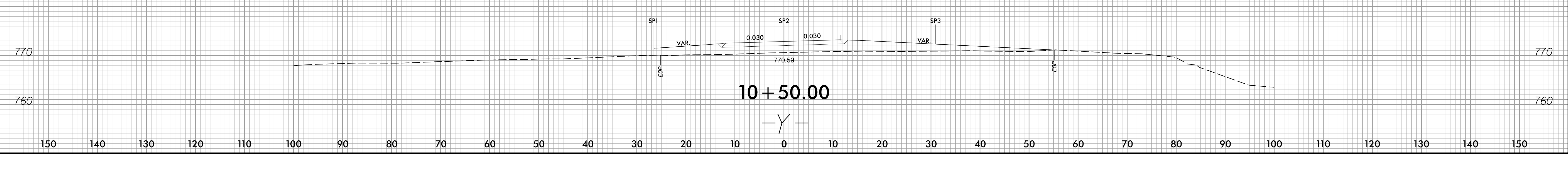
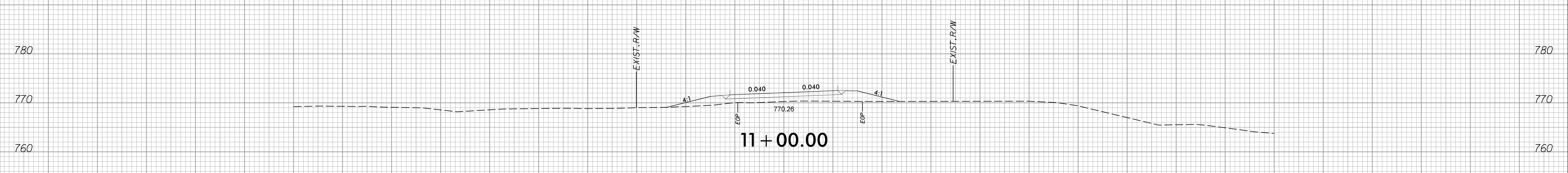
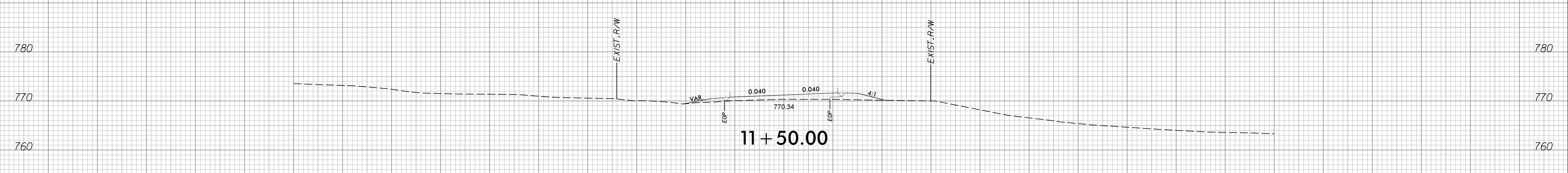
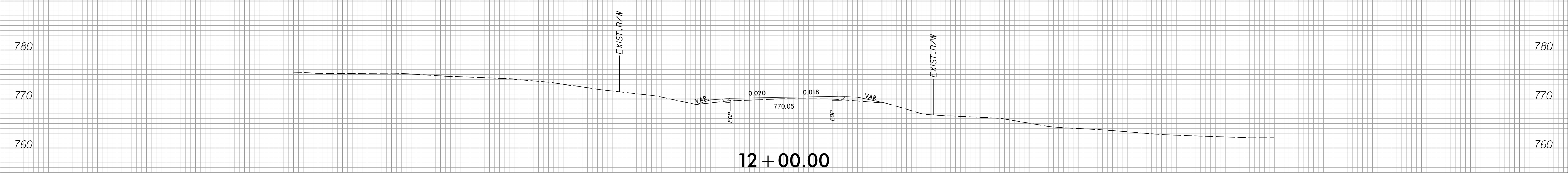
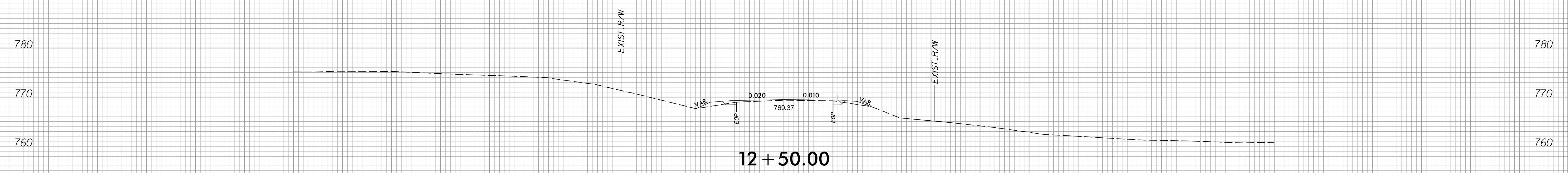

150 140 130 120 110 100 90 80 70 60 50 40 30 20 10 0 10 20 30 40 50 60 70 80 90 100 110 120 130 140 150

4/26/2021 7:44:27 AM
 R:\cadd\proj\17BP.7.R.127\17BP.7.R.127.dwg - xp1.y.dgn
 0086365

150 140 130 120 110 100 90 80 70 60 50 40 30 20 10 0 10 20 30 40 50 60 70 80 90 100 110 120 130 140 150

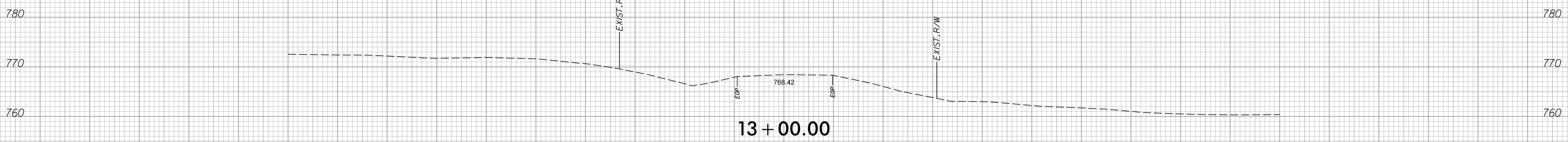

150 140 130 120 110 100 90 80 70 60 50 40 30 20 10 0 10 20 30 40 50 60 70 80 90 100 110 120 130 140 150

4/26/2021 7:44:30 AM
 R:\cadd\proj\155714_rdy_xpl.y.dgn
 0086365