

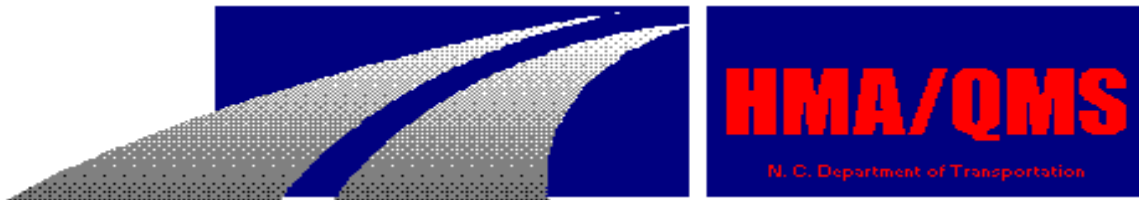

North Carolina Department of Transportation



Density Gauge Operator's Manual

North Carolina Department of Transportation
Division of Highways
Materials and Tests Unit – Field Operations

Table of Contents

HMA/QMS Addendum

Abstract.....	2
Introduction.....	3
Field Operation Procedures for 4640-B	4
Field Operation Procedures for 3450.....	13
Field Operation Procedures for PQI Model 301.....	22
Field Operation Procedures for PQI Model 380.....	27
Field Operation Procedures for Pavetracker 2701B	30
Field Compaction Quality Management System	36
A. Quality Control of Density	
1. Control Strip Procedures.....	38
a. Location	
b. Frequency	
c. Mix Sampling Requirements for Control Strips	
d. Numbering	
e. Establishment of Control Strip	
f. Core Samples	
g. Target Density	
2. Test Section Procedures.....	44
a. Establishment of Test Section	
b. Testing	
c. Numbering	
3. Limited Production Procedures.....	46
B. Quality Assurance of Density.....	47
1. Control Strip Procedures	
2. Test Section Procedures	
3. Limits of Precision	
4. Dispute Resolution Procedures	
C. Acceptance of Density.....	51
D. Field Density Assessment Program.....	53
Appendix I Best Practice Procedures when taking a Standard Count.....	56
Appendix II Record and Report Forms.....	59
Appendix III Random Sampling.....	71
Appendix IV Random Numbers.....	73

Abstract

Nuclear and non-nuclear testing is easy and fast. This enables the Density Technician to take a greater number of tests in a given area. The greater the number of tests, the more reliable the tests' results will be. With nuclear or non-nuclear testing, the tester uses a table of random numbers (which will be explained later) to choose his/her test spots. This way, he not only finds out if the road has the required density, but also if the road has a uniform density. This is essentially a statistical approach to highway quality control, which is assuming a more important role in highway construction.

The use of nuclear techniques for measuring highway compaction dates back to the early fifties. Since that time the equipment has progressed from large homemade laboratory devices to commercially available, self-contained, portable devices designed specifically for compaction control work.

The strength of the radioactive sources used in the newer gauges is much less than that used in the early gauges. In fact, in some cases, the radioactive source strength has been reduced by a factor of 100. This, of course, reduces the health hazard and degree of training necessary. The gauges have become simpler to operate and are constructed to be more rugged and reliable.

Nuclear gauges are used to determine the compaction of ABC and Asphalt pavements; and recent studies have indicated a unique application to concrete consolidation control.

Non-nuclear gauges are a new technology to become available. The techniques for measuring compaction of asphalt with these devices were derived from experience gained with nuclear gauges. Non-nuclear gauges offer numerous advantages in that the devices provide test results within seconds, weigh less than a typical nuclear gauge, do not emit radiation, do not require special licensing, do not require radiation safety training and do not require gauge operators to wear a dosimeter.

It is essential that the operator become familiar with this manual along with the manufacturer's operator manual for the particular device being used. Since the nuclear and non-nuclear testing programs are still evolving, this manual will be changed periodically to reflect new procedures.

Introduction

This manual is to serve as a ready reference to the QMS Density Technician. The HMA/QMS Specification contains several significant changes in the methods and techniques of nuclear or non-nuclear density control. The instructions, information, guidelines, and forms, etc. contained in this manual are based on the HMA/QMS Specification. This text not only presents the concepts associated with nuclear or non-nuclear density testing of asphalt pavements but also some of the general concepts of the HMA/QMS Specifications.

Field Operation Procedures for Troxler 4640B

When a new device is purchased the operator should read and become familiar with the manufacturer's operation manual. Knowledge gained from the operator's manual will help to ensure the gauge is operated safely and efficiently.

Turning the Gauge "ON"

The gauge uses rechargeable Ni-cad batteries (*included*) as a power source. When first turned on, the control panel display screen will fill with test characters before proceeding to the self-test.

To turn the gauge on, press ON.

After the "LCD" test, the display will be:

```
TROXLER 4640B  
V: xxx SN xxxxx  
Customer name  
(TEST: xx sec.)
```

After the 300 second self-test the gauge will enter the "Ready" mode. In this state any of the gauge functions may be accessed. If any error message is displayed on the LCD, contact the gauge manufacturer or technical trainer in your area.

The <READY> display is:

```
<READY>  
mm/dd/yy  
Avg.: xx  
Time: xx mins.  
BATT VOLTS xxx V
```

The first line of the display alternates between the current time and date. The second line of the display indicates any gauge options that are enabled such as "Average Mode". The third line indicates which count time is enabled. The last line indicates the current battery voltage.

Gauge Parameter Set-up - 4640-B

After unpacking your gauge and turning it "ON" there will usually be several parameters that you can initialize. These parameters do not usually require changing and may include the time/date, company name, count time, etc.

Measurement Unit Selection

The 4640-B allows measurement results to be displayed in either metric or English units. Decide which selection you will be using and press SHIFT and SPECIAL.

The display will be:

SPECIAL FUNCTION
YES – next menu
1 – Surface Voids
2 – Recover Erase

Press YES two times and/or press 7 for the display:

Units in US
Select 1 - US
2- METRIC
ENTER - no change

Press either 1 or 2 to select the required units.

Count Time Selection

The gauge provides three different count times for taking density readings. CURRENTLY, THE DEPARTMENT REQUIRES THAT ALL NUCLEAR GAUGE DENSITY MEASUREMENTS BE TAKEN WITH A ONE-MINUTE COUNT TIME.

To set count time press TIME for the display:

Count Time 60 sec
1 – 15 Seconds
2 – 1 Minute
3 – 4 Minutes

Source Rod Positions

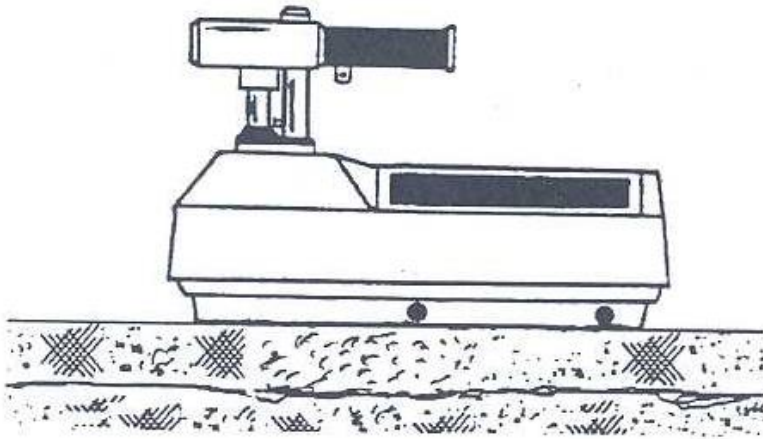

Figure 1

Safe Position

The source rod handle must be in the upper position. The plunger must engage in the notch located on the index rod.

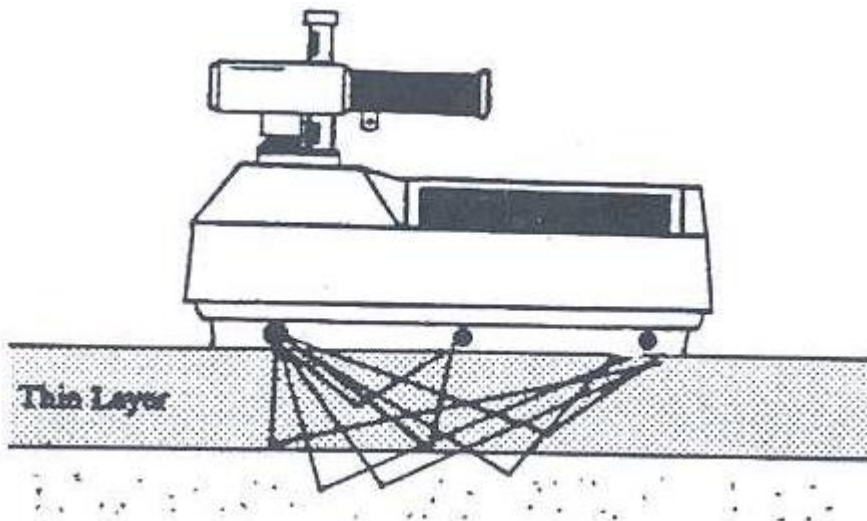

Figure 2

Measure Position

The source rod handle must be all the way down! The handle must be resting on top of the stop pin.

Taking the Standard Count

The 4640-B uses a Cesium-137 gamma source for taking density measurements. This low-level radioactive source undergoes a natural decay process, which results in a gradual loss of strength. The time required for the source strength to diminish by 50% is referred to as the *half-life*. The half-life of Cesium-137 is approximately 30 years.

To compensate for the source decay and to check if a gauge is malfunctioning, a daily reference *Standard Count* is performed. It is very important to take a Standard Count on a daily basis to ensure the highest accuracy/precision possible with the gauge.

On days when a control strip is being placed, the Department's QA technician should witness the QC technician's standard count procedure. Likewise, the Contractor's QC technician should witness the QA gauge operator's standard count procedure. Refer to Appendix I – Best Practice Procedures when taking a Standard Count.

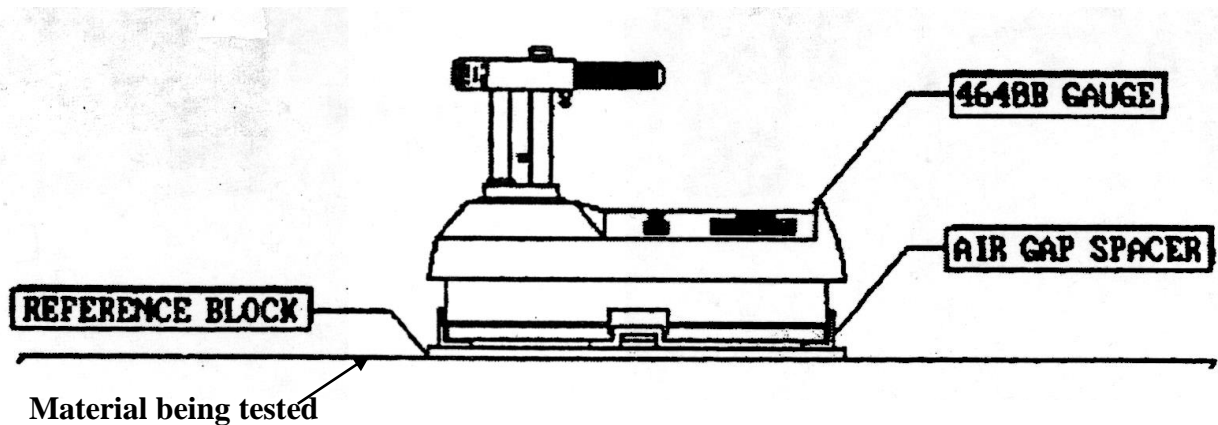

Figure 3

Standard Count

Taking a Density Measurement

Prior to taking any density measurements ensure the gauge Standard Count results meet all tolerances.

Overlay Thickness Selection

Input the overlay thickness prior to taking a measurement with the 4640-B. This will ensure the underlying material does not influence the readings.

Press THICK for the display:

**Layer Thickness:
x.xx
Input and
Press ENTER.**

Input the thickness of the overlay and press ENTER

Marshall/Voidless Density Parameters

Input the target density prior to taking a measurement. Press MA/VOIDLESS for the display:

**MA: xxx.x
VD: xxx.x
Do you want
To change?**

Press YES and input any target Marshall and Voidless Density values.

NOTE: The "Voidless" density is the maximum density obtained in laboratory tests

Site Preparation/Gauge Positioning

The 4640-B Thin Layer Density Gauge is designed for use on asphalt surfaces and consequently will not require a great deal of site preparation. When taking a density measurement the following items are important:

- Remove any loose material (sand, aggregate, etc.) from the test site.
- Keep gauge turned parallel with the direction of the paving operation.
- Ensure the gauge does not "rock." It must remain level and steady. If rocking occurs, find a more suitable test site within a 3 foot radius. If you are taking a measurement at a core site in a Control Strip you may move the gauge up to 12 inches away from the site to level the gauge. Cut the core from within the gauge foot print. Figure 4 shows a typical configuration for obtaining gauge measurements on a core site within a Control Strip.

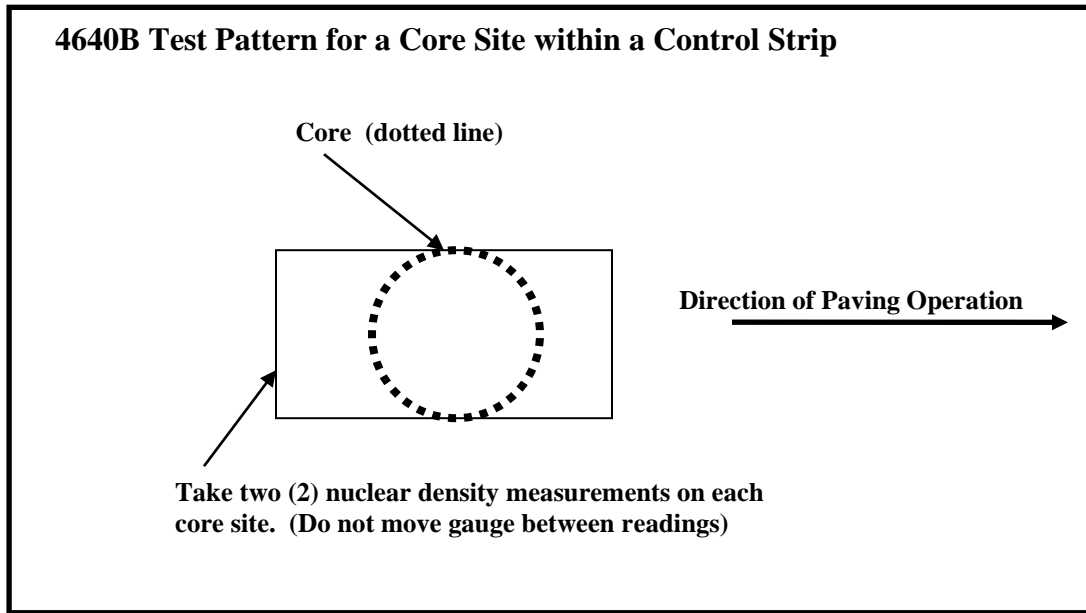

Figure 4

To take a measurement, release the gauge handle and push it down until the handle is resting on top of the stop pin.

Press START: (step back approximately 4 feet from a gauge while taking measurements)

MA: xxx.x
Thick: xxx
Avg.: xx
Time: xx secs.

After the count time has elapsed and the results are displayed, pull the source rod into the safe position. The display will be as follows:

Dens: xxx.x
%MA: xx.xx%
100 - %MA: xx.xx%
%VOIDS: x.xx%

NOTE: If *Surface Voids Mode* has been enabled, the surface voids value will be displayed in place of the density value.

Viewing the Counts

Press SHIFT and RECALL to view the actual counts for detector systems 1 and 2. When troubleshooting issues involving a nuclear gauge, representatives from the gauge manufacturer may need the count information when attempting to diagnose the problem.

Creating a Project File

Data is stored in the 4640-B under a *project number*. When a project is *active*, all readings will be stored in memory under this project number. This function allows data to be retrieved and printed for later use.

The *Project Function* allows projects to be created, retrieved, viewed and/or erased.

Press SHIFT and PROJECT for the display:

Current Project
Xxxxxx
Do you want a
New Project #?

To create a new project, press YES and input the number of the new project. The project will be active until another new project number is entered. All gauge readings that are stored will be stored under the active project.

View/Erase Project

Press NO.

PR# xxxxx
1 – View Proj.
2 – Erase Proj.
3 – Next Proj.

Select the project number required and follow all instructions on the gauge display.

Storing a Measurement

After reviewing the data the reading may be stored under a *Project Number*. This function allows the data to be recalled and printed at a later time.

When the measurement has been completed press STORE. The display will request a station number.

Station Number?

**Input and
Press ENTER**

Input a numeric station or reading number (up to 6 characters) and press ENTER. The display will request the distance from the centerline.

**Distance from
Center line?**
.....
(Press ENTER)

Input the distance (if applicable) and press ENTER. The display will request if the measurement was to the *Left or Right* of the centerline. Press 1 or 2 to select the desired offset reference point.

Additional information may be stored. This information may be random numbers, grid coordinates, mix type, or any other numeric information (up to 12 characters per line). Press YES to continue storing information. Press NO to exit.

Printing Measurement Data

Project data may be printed at any time after the readings have been taken and stored into the project.

Press SHIFT and PRINT. The display will be:

**Connect serial
Device & Select:**
1 – one Project
2 - all Projects

Connect the printer to the serial port located on the front of the gauge (refer to information on setting the serial port parameters).

Press 1 to select (1) project. Press 2 to print all projects.

If 1 is selected, the gauge will display the first project in memory.

PR# xxxxx
1 – Print Proj.
2 – Next Proj.

Press 1 to print the project. Press 2 to scan for another project.

Erasing a Project

The *Erase Function* allows project data to be erased or removed from gauge memory.

Press SHIFT and ERASE. The display will be:

Select to ERASE:
1 – one Project
2 - all Projects

Press 1 to select one (1) project only.

Press 2 to erase all projects stored in the gauge.

Accidental Erasure

If data is accidentally erased press SHIFT and SPECIAL.

Press 2 to select the *Recover Erase* function.

Field Operation Procedures for 3450

When a new device is purchased the operator should read and become familiar with the manufacturer's operation manual. Knowledge gained from the operator's manual will help to ensure the gauge is operated safely and efficiently.

Turning the Gauge "ON"

The gauge primarily uses Ni-cad batteries as a power source; however, the gauge also contains six AA alkaline batteries for a backup power source. When the gauge is first turned on, the software tests the display, performs a short self-test, and displays the battery status. NOTE: The gauge should be turned on at the office prior to leaving for the project to allow the gauge to warm-up.

To turn the gauge on, press ON.

After the self-test the display will be:

```
Charger - OFF  
Ni-Cad - In Use  
Alkaline - Ready  
Press ENTER
```

The first line indicates if the charger is connected and the next two lines display the status of the Ni-cad and alkaline batteries. To view the battery voltage, press the "down" arrow key.

Press, ENTER and the gauge will go into a warm-up mode to allow the electronics to warm-up (approximately 10 minutes).

After the warm-up, the gauge will go into the ready screen.

The display will be:

```
- READY - Thin Mode  
Depth - STD 10:21am  
Tim - 60sec 06/30/2008  
Pr#: Your project
```

From the ready screen any gauge function can be accessed.

To conserve power the gauge will go into a sleep mode after thirty seconds of no use. All data and settings are protected. To exit sleep mode, press any key OTHER THAN ON OR OFF.

Basic Parameter Set-up: 3450 Roadreader Plus

Measurement Unit Selection

Prior to taking measurements, the operator should determine if the project is metric or English and set the gauge accordingly.

To execute the set units function, press *SPECIAL* for the display:

- 1 – Special Operation**
- 2 – Gauge Status/Test**
- 3 – Memory Functions**
- 4 – Gauge Setup**

Press 4 to enter gauge setup menu.

The display will be:

- 1 – Set Time/Date**
- 2 – Print Setup**
- 3 – Depth Indicator**
- 4 – Set Beeper Level**

Use the “down” arrow key to scroll through the menu. Press 8 for set unit function.

- 1 – Special Operation**
- 2 – Gauge Status/Test**
- 3 – Memory Functions**
- 4 – Gauge Setup**

The display will be:

- Unit in pcf**
- 1 - pcf**
- 2 – kg/m³**
- 3 – g/cm³**

Enter the number of the desired unit for testing.

Count Time Selection

The gauge provides three different count times for taking density readings. CURRENTLY, THE NCDOT REQUIRES THAT ALL NUCLEAR GAUGE DENSITY MEASUREMENTS BE TAKEN WITH A ONE-MINUTE COUNT TIME.

To set count time press TIME for the display:

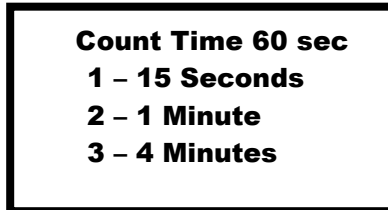

Measurement Mode Selection

The gauge may be utilized on asphalt, base course, or soil, and it provides three different testing modes: Soil mode, asphalt mode, and thin-layer mode. The gauge must be set in soil mode for testing base course or soil. For testing asphalt on QMS projects, the gauge must be set in “**Thin-layer Mode**”.

To select mode press MODE for the display and select 3 for the thin-layer mode:

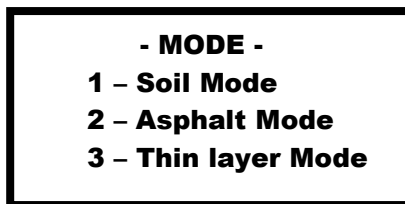

Once the thin-layer mode is selected, the gauge prompts for the overlay thickness. Use the number keys to enter the overlay thickness and press the ENTER key.

Taking the Standard Count

NOTE: The front of the gauge is closest to you when the 3450 is placed with the source rod to the left and the control panel to the right. The handle contains the trigger mechanism, which is used to position the source rod on the notched index rod. The source rod should always be in the SAFE position when the gauge is not in use.

All Troxler nuclear gauges utilize low level radioactive sources for taking measurements. The sources in the 3450 gauge have a half-life of 30 years for Cesium 137 and 433 years for Americium 241: Beryllium. For example, if a nuclear gauge is manufactured with 8 mci of Cesium 137, then in 30 years only 4 mci of Cesium 137 will be present. To ensure accurate testing a STANDARD COUNT must be taken to compensate for the continuous radioactive decay. The radioactive decay is a known occurrence and will not compromise the accuracy of the gauge provided the standard counts are taken. It is important to take the standard count when a gauge is initially received from the factory and prior to taking measurements at the job site.

The gauge should be turned on before leaving for the work site. This allows the gauge to go through the self-test/warm-up routine and the standard count can then be taken upon arrival at the work site without delays.

On days when a control strip is being placed, the Department's QA technician should witness the QC technician's standard count procedure. Likewise, the Contractor's QC technician should witness the QA gauge operator's standard count procedure. Refer to Appendix I – Best Practice Procedures when taking a Standard Count.

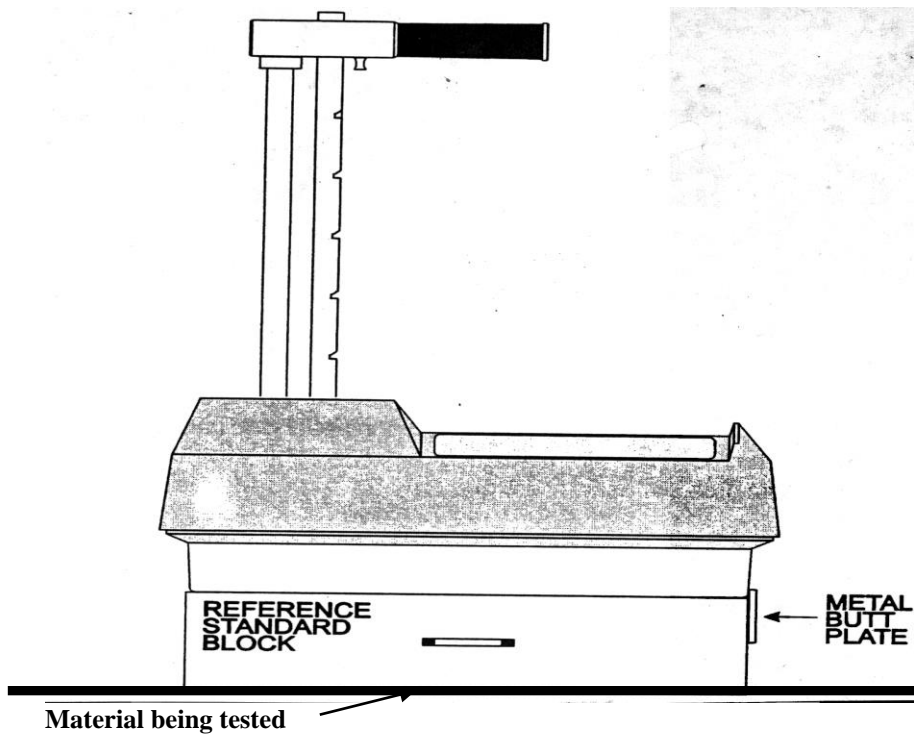

Figure 5

Standard Count

Depth Strip Calibration

Once the Standard Count is complete, the depth strip will require calibrating. The gauge will display:

**Depth Calibration
Set Rod To BS

And Press ENTER**

To calibrate the depth strip, place source rod in the BS (backscatter) position and press ENTER. NOTE: If the source rod is not placed in the BS position during calibration, all density readings will be effected.

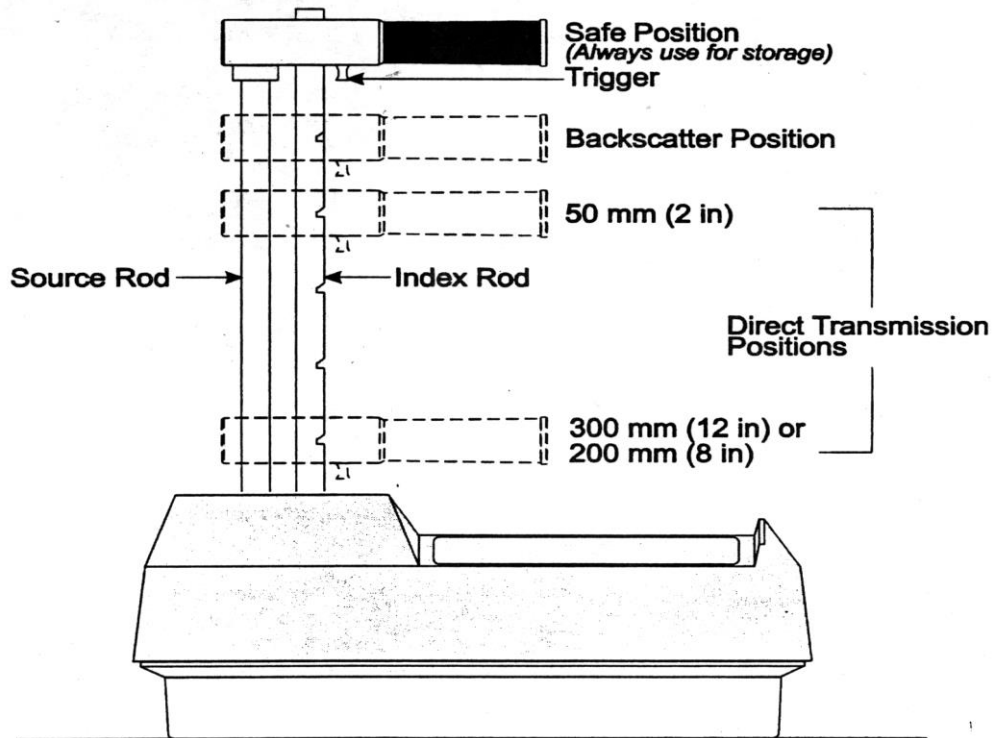

Figure 6

Source Rod Positions

Taking a Density Measurement

Entering a Target Density

Prior to testing asphalt for density acceptance, a target density must be entered into the gauge. Once the target density is determined, press TARGET for the display:

- | |
|------------------------|
| 1 - PR = xxx.x |
| 2 - MA = xxx.x |
| 3 - Voidless = xxx.x |
| 4 - Voidless/MA = pair |

Press 2 to input target density for asphalt. The display will be:

- | | |
|-------------------------|------------|
| Marshall Values: | |
| 1: xxx.x | 2: xxx.x |
| 3: xxx.x | 4: xxx.x |
| 5: New | 6: Disable |

Press 5 and input a new target value. After the value is entered press ENTER. The gauge will then ask if the operator wants to store the value in memory. To store the target value, press YES, and then choose one of the storage cells (1-4). Entering a new target value in a storage cell will erase an existing target value stored in the same cell. The stored target value will be saved and can be

accessed for later testing. When prompted to store a target value, the operator may press NO and the value will not be entered into a memory cell, however; the value will remain the existing target value.

Site Preparation/Gauge Positioning

The 3450 Density Gauge is designed for use on asphalt surfaces and consequently will not require a great deal of site preparation. When taking a density measurement the following items are important:

- Remove any loose material (sand, aggregate, etc.) from the test site.
- Keep gauge turned parallel with the direction of the paving operation.
- Ensure the gauge does not "rock." It must remain level and steady. If rocking occurs, find a more suitable test site within a 3 foot radius. If you are taking a measurement at a core site in a Control Strip you may move the gauge up to 12 inches away from the site to level the gauge. Cut the core from within the gauge foot print. Figure 7 shows a typical configuration for obtaining gauge measurements on a core within a Control Strip.

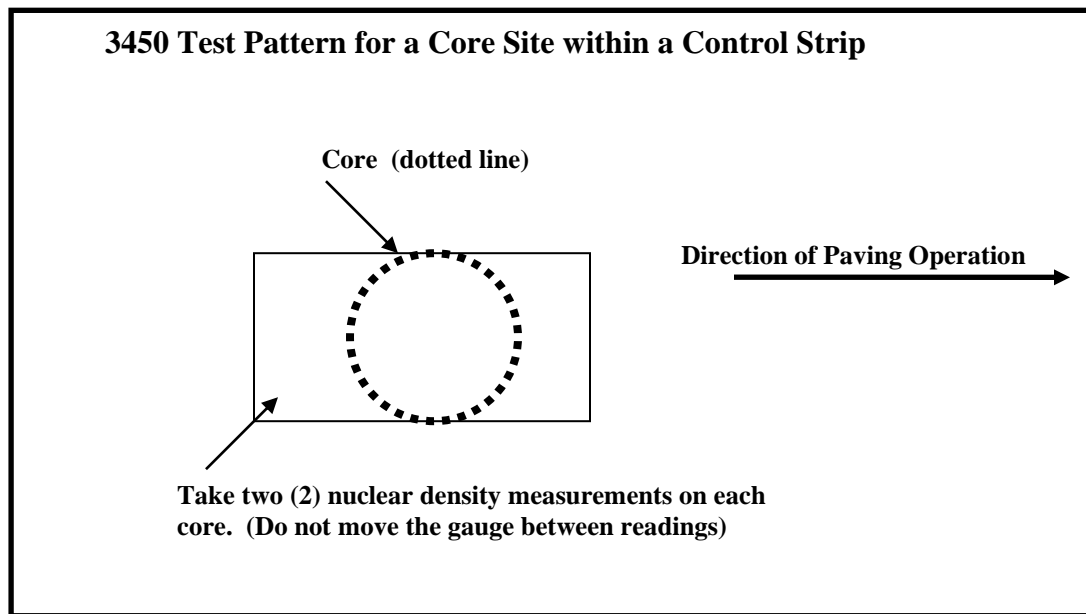

Figure 7

Taking a Density Measurement

Place the gauge on the test site. Release the gauge handle and push it down until the handle is in the first notch below the safe position (BS position).

Press START and the gauge will display:

**Ready for
Count 1 of 1
Place in BS then
Press Start**

Press START again: (step back from gauge approximately 4 feet when taking a measurement)

**Thickness
x.xx in
Count 1 of 1
Time xx sec**

After the count time has elapsed, the display will be:

**%MA = xx.xx% ↕
D = xxx.x pcf**

To view the actual counts for the detector systems 1 and 2 press the either arrow key.

Storing Project Data

The project function allows a unique project number (file) to be created. When the project number is active, density readings can be stored under that number and then either printed or downloaded to a computer.

To access the project function, press the PROJECT key. The display will be:

**PR#: Your Project ↕
1: Select Project
2: New 4: Print
3: View 5: Erase**

The first line displays the current project number. Use the arrow keys to scroll project numbers that are in gauge memory. When the desired project is displayed, press 1 to enable the project. To create a new project, press 2 at the project menu. The display will be:

Project Number

Press ENTER

The gauge then prompts for a project ID number. The project ID number is only an alternate project identification number; therefore, it is not necessary. Press ENTER to get to the display shown below.

**Do You Want To
Select New Project?**

8.123456

Press YES and the gauge will enable the new project. The gauge will then return to the ready screen. Verify that the correct project number is displayed on the last line of the display screen.

- Ready - Thin Mode
Dpth - STD 2:30 pm
Tim-60sec 09/14/2008
PR#: 8.123456

After taking a measurement, the operator can store the data in the selected project by pressing STORE. The display will be:

Next Station Number?

Last Station: 0
ENTER When Done

After entering the station number press ENTER. The gauge will then prompt the operator to enter additional information. The operator can enter the distance from centerline and any additional information.

Printing Data

To print the stored data press PROJECT to enter the project menu. Press 4 to enter the print function. The display will be:



#: Your Project ⇅
1: Print This Project
2: Print All Projects

Use a serial printer cable to connect the nuclear gauge to the printer (or computer). Refer to the Troxler manual for setting the correct baud rate in the gauge. To print a single project, use the arrow keys to scroll through the stored projects. To select a desired project, press 1. To print all projects press 2.

Erase Projects

To erase a project, press PROJECT. The press 5 and the gauge will display.



#: Your Project ⇅
1: Erase This Project
2: Erase All Projects

To erase a single project, use the arrow keys to scroll through stored projects. Once the gauge displays the desired project, press 1. The gauge will then display “Are You Sure”, press YES.

Recover Erase

If project data is erased accidentally, the recover erase function may be able to recover the lost information. For the recover erase function, press SPECIAL. Press 3 to access the memory function menu. To attempt data recovery, press 2.

Field Operation Procedures for PQI 301

When a new device is purchased the operator should read and become familiar with the manufacturer's operation manual. Knowledge gained from the operator's manual will help to ensure the gauge is operated safely and efficiently.

Turning the gauge "ON"

The PQI gauge uses nickel metal hydride batteries as a power source and must be fully charged prior to using the gauge for the first time. These batteries with a full charge will provide approximately 13 hours of normal operation.

To turn the gauge on press ON.

After the self-test the screen will prompt the operator to enter in the "Pavement Type"

Select Pavement Type
1: 25-35 mm (Base)
2: 16-24 mm (Inter.)
3: 9-15 mm (Top)

Enter "3" to select surface mix type. The gauge will prompt the operator to enter a Lift Thickness.

Lift Thickness
Enter Units
1) inches
2) mm

Select "1" for English units or "2" for metric. The gauge display will prompt for a lift thickness value.

Lift Thickness
Enter Thickness (in or mm)

Using the keypad enter the depth of HMA being placed and press "Enter". The gauge will then enter the "Startup Menu" screen as shown below.

Startup Menu
1) Setup Menu
2) Run

Test Block Procedure

To verify the PQI device is operating properly an initial PQI Test Block Procedure must be performed after purchasing a new gauge or following calibration/repair of an existing device. This initial Test Block Procedure will establish a baseline for future Test Block Procedures that are to be conducted on a monthly basis or if the device is operating in an erratic manner. A representative of the Department should verify monthly Test Block results are within tolerance of the initial Test Block Procedure. If the Test Block results do not fall within tolerance the device cannot be used for acceptance testing and the manufacturer should be notified for additional guidance regarding calibration/repair of the device itself. The PQI Test Block can be purchased at TransTech and a step-by-step procedure manual can be found at: <http://www.transtechsys.com> Records of calibration and Test Block results must be maintained for verification by a Department representative.

Basic Parameter Set-up

If gauge testing parameters need to be entered or verified press “1” to enter the Setup Menu. The display will be as follows:

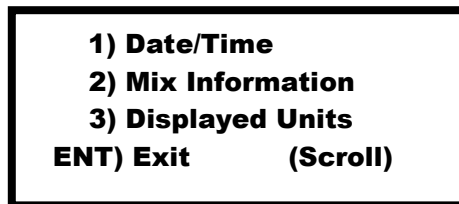

1) Date/Time
2) Mix Information
3) Displayed Units
ENT) Exit (Scroll)

Since density readings will be stored in gauge memory, verify date and time and adjust if needed. Additional menu listings, as shown in the following diagram, can be viewed by pressing the “Down” arrow.

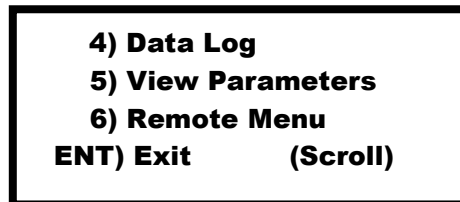

4) Data Log
5) View Parameters
6) Remote Menu
ENT) Exit (Scroll)

From this display the operator can press ENTER to exit, enter a desired menu function by pressing the corresponding number, or press the down arrow to return to the first setup menu display.

Setting Measurement Units

From the Setup Menu select the “Displayed Units” by pressing “3”. The LCD will display the following:

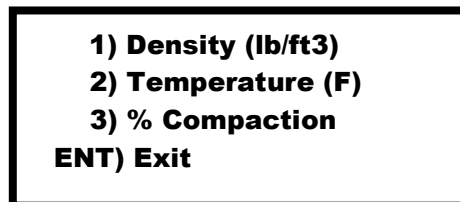

1) Density (lb/ft3)
2) Temperature (F)
3) % Compaction
ENT) Exit

From this display the operator can press the appropriate number to change any of the units. Since the Department’s specifications are based on percent compaction, “% Compaction” should be displayed when testing NCDOT projects. Press ENTER to return to the Setup Menu functions.

Entering a Target Density

Input the Target Density prior to taking a measurement. From the Setup Menu function press “2” for “Mix Information”. The display will be as follows:

1) Set MTD (150.0)
2) Lift (1.5 in)
3) Set Pave Type (T)
ENT) Exit

Select “1” and the display will be:

Set MTD
(150.0 lb/cuft)
1) Keep this value
2) Enter a new value

Press “1” to keep the current value and return to the Setup Menu. Press “2” to enter a new value. Use the keypad to enter a new target density.

Measurement Mode Selection

When testing with a PQI device at an individual test site within a Test Section or individual core site within a Control Strip, a total of five measurements will be required at each site. Taking more density measurements reduces variability providing a better representation of asphalt density. Increasing the number of density readings is possible due to the short count time required to take a density reading. The PQI device displays the results in approximately 3 seconds. The PQI also provides an “Average” mode function which averages 5 consecutive individual readings and displays the final result for recording. The stored density measurements are printed and submitted with the required QMS density forms to the appropriate QA representative.

To select the mode, press “Mode” until the screen displays the following:

Avg Mode (5) [T]
ENT) Take Reading #1

Site Preparation/Gauge Positioning

- Remove any loose material (sand, aggregate, etc.) from the test site.
- If moisture is noticeable on the surface wait for the moisture to evaporate or remove the moisture with an absorbent cloth. Moisture will affect PQI measurement readings, monitor test results carefully. To ensure the highest degree of accuracy, moisture readings should remain relatively constant. Do not accept any density measurements when the “Relative Water Value” (H₂O) is above 5. If the relative water value is above 5 allow the test site to dry and take another measurement. Repeat this procedure until the value drops to 5 or below. Relative Water Values should remain relatively constant between measurements. If the value varies by more than 1 % do not accept the reading. Allow the test site to dry to a constant moisture value and re-test.
- Ensure the bottom of the gauge is clean and the device does not “rock” when placed on the mat. The device must remain level and steady. If rocking occurs, find a more suitable test site within a 3 foot radius. When taking measurements around a core the gauge operator may move the gauge a few inches away from the core location to level the gauge, but the core must be cut from the center of the 5 gauge readings. Refer to the following diagram for a typical PQI test pattern for a core site in a Control Strip and test site within a Test Section.

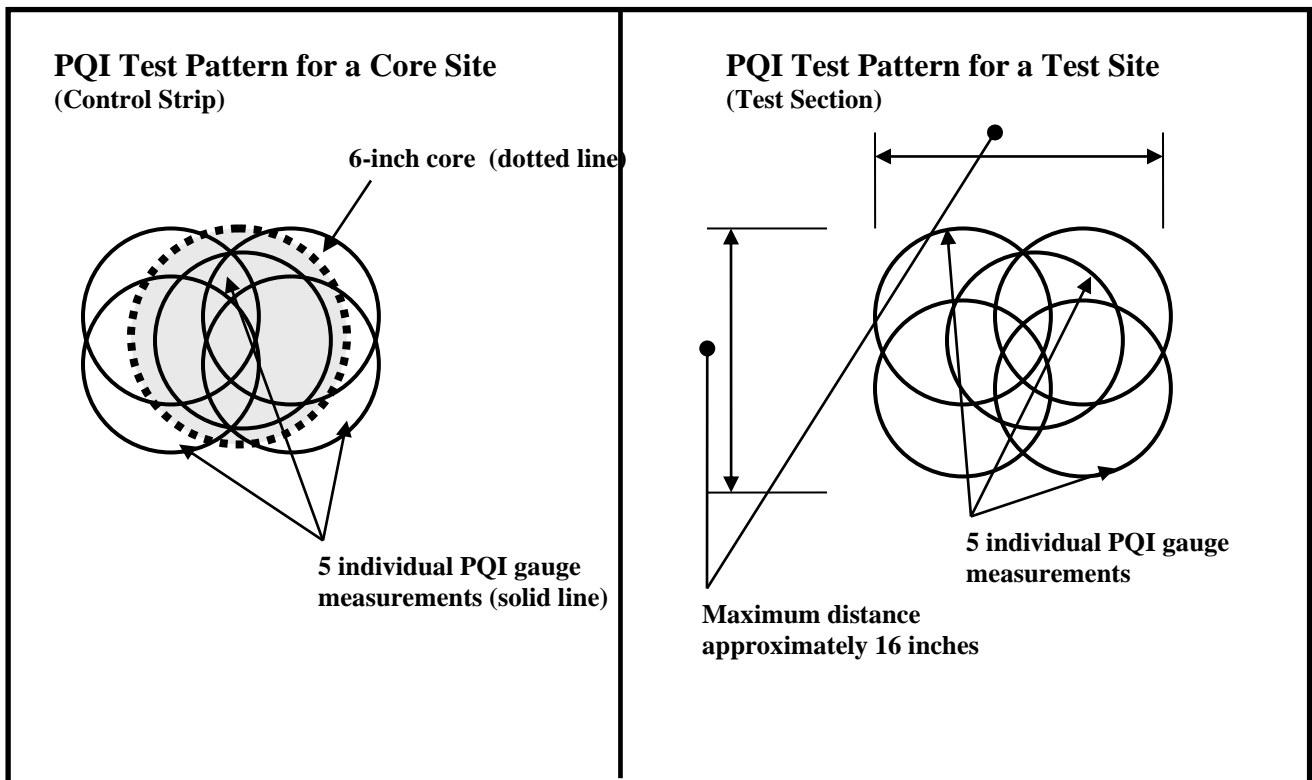

Figure 8

Press “Enter” to take the first reading. DO NOT TOUCH the gauge while it is taking a reading. Once the reading is complete move the gauge over and take another reading. Repeat the same steps until all five readings are obtained. Press “Enter” to display the average of the five measurements (refer to diagram below).

Avg Mode (5) [T]
ENT) Display Average
H2O: 3.0 185.6 F
D: 135.5 lb (92.3 %)

Once the average is recorded on the appropriate QMS density form, press “Enter” to store the data (refer to the following diagram).

Log the last avg?
(0 points in log)
1) Yes
2) No

Press “1” and the LCD will display the following:

Enter Station #
Example: 300 +50
First #:
Second #:

Using the keypad enter the station. For this example enter 300 as the “First #” and press “Enter”. Enter 50 as the “Second #” and press “Enter”.

Printing Data

Once the density readings have been stored in gauge memory the data can be printed. To print data, enter the Setup Menu and select the “Data Log” function by pressing “4”.

4) Data Log
5) View Parameters
6) Remote Menu
ENT) Exit (Scroll)

Select the “Print Data Log” by pressing “3”. Once the data is printed select the “Clear Data Log” to erase the data.

1) Clear Data Log
2) View Data Log
3) Print Data Log
ENT) Exit

Field Operation Procedures for PQI 380

When a new device is purchased the operator should read and become familiar with the manufacturer's operation manual. Knowledge gained from the operator's manual will help to ensure the gauge is operated safely and efficiently.

Turning the gauge "ON"

The PQI 380 gauge uses batteries as a power source and must be fully charged prior to using the gauge for the first time and should be charged after each use. These batteries with a full charge will provide approximately 12 hours of normal operation. The software in the PQI 380 is based on a Windows® format using touchscreen technology.

To turn the gauge on press ON.

Ensure proper date and time are displayed. If not, follow directions in PQI 380 Operator's Handbook issued with the device to correct. Currently, the Department does not require GPS data to be recorded.

Standardization

From the *Main Menu* select *Start PQI 380* to access the *Control Menu*. Select *Standardization* and follow the directions in the Operator's Handbook to complete the standardization process. A standardization must be completed at the beginning of each day's production. Care should be taken to ensure manufacturer's recommendations are followed. A summary of standardization steps are as follows:

- Ensure serial numbers located on the gauge and standardization plate are the same
- Perform standardization test from inside the carry case
- Position gauge on top of plate (inside of case)
- Ensure gauge screen is facing you (if placed backwards, handle will get hung and device will give a false reading)
- Case should not be on top of or within 10 feet of any large metal objects
- Ensure powerlines or other electrical devices are at least 10 feet away

If the gauge readings accuracy are suspect, perform another standardization to verify device.

Unit Selection

The gauge can test in metric or English units. From the *Control Menu*, select *Units* and set the desired unit of measurement.

Test Data Storage

The gauge can store density measurements however, in order to store any data the *Data Logging* feature must be turned on. From the *Control Menu*, select *Data Logging* and ensure the feature is turned on. Data will not save if device is measuring in the Continuous and Segregation Reading Modes.

Enter Mix Details

To ensure accurate test results, mix details must be entered prior to taking density measurements. From the *Control Menu* press *Mix* to access the Mix Details screen. To change mix details press *Edit Mix*. Press the black buttons to access each of the mix features and change to represent the desired mix characteristics. Under the *Mix* button a new name can be entered. The *Offset* feature should be remain at 0.0 pcf. Once completed, the results from the Control Strip M&T Form 514 will be used to calculate the Target Density for the mix. The correlated Target Density will be entered into the gauge (as the *MTD* at the *Mix Details* window). Therefore, the Offset feature should not be used. Once all entries have been completed verify the entries are correct and press *Exit*. To exit the *Mix Details* screen press *Control Menu* to return the Control Menu screen.

Project Details

The PQI 380 can store up to 10 different project files. From the *Control Menu* press *Project* to edit project details. Press the desired black button to select the desired window to enter project specific information. After desired information has been entered verify the information is correct and press *Exit*. Press *Control Menu* to return to the *Control Menu* window.

Reading Modes

The gauge has several reading modes including: *Single Reading*, *Average Reading*, *Continuous*, and *Segregation*. For density acceptance purposes the gauge should be set to *Average Reading Mode*. In this setting the gauge will average 5 readings take at each site. Use test procedures as described in the Site Preparation/Gauge Positioning of this manual.

Site Preparation/Gauge Positioning

- Remove any loose material (sand, aggregate, etc.) from the test site.
- If moisture is noticeable on the surface wait for the moisture to evaporate or remove the moisture with an absorbent cloth. Moisture will affect PQI measurement readings, monitor test results carefully. To ensure the highest degree of accuracy, moisture readings should remain relatively constant. Do not accept any density measurements when the “Relative Water Value” (H₂O) is above 5. If the relative water value is above 5 allow the test site to dry and take another measurement. Repeat this procedure until the value drops to 5 or below. Relative Water Values should remain relatively constant between measurements. If the value varies by more than 1 % do not accept the reading. Allow the test site to dry to a constant moisture value and re-test.
- Ensure the bottom of the gauge is clean and the device does not “rock” when place on the mat. The device must remain level and steady. If rocking occurs, find a more suitable test site within a 3 foot radius. When taking measurements around a core the gauge operator may move the gauge a few inches away from the core location to level the gauge, but the core must be cut from the center of the 5 gauge readings. Refer to the following diagram for a typical PQI test pattern for a core site in a Control Strip and test site within a Test Section.

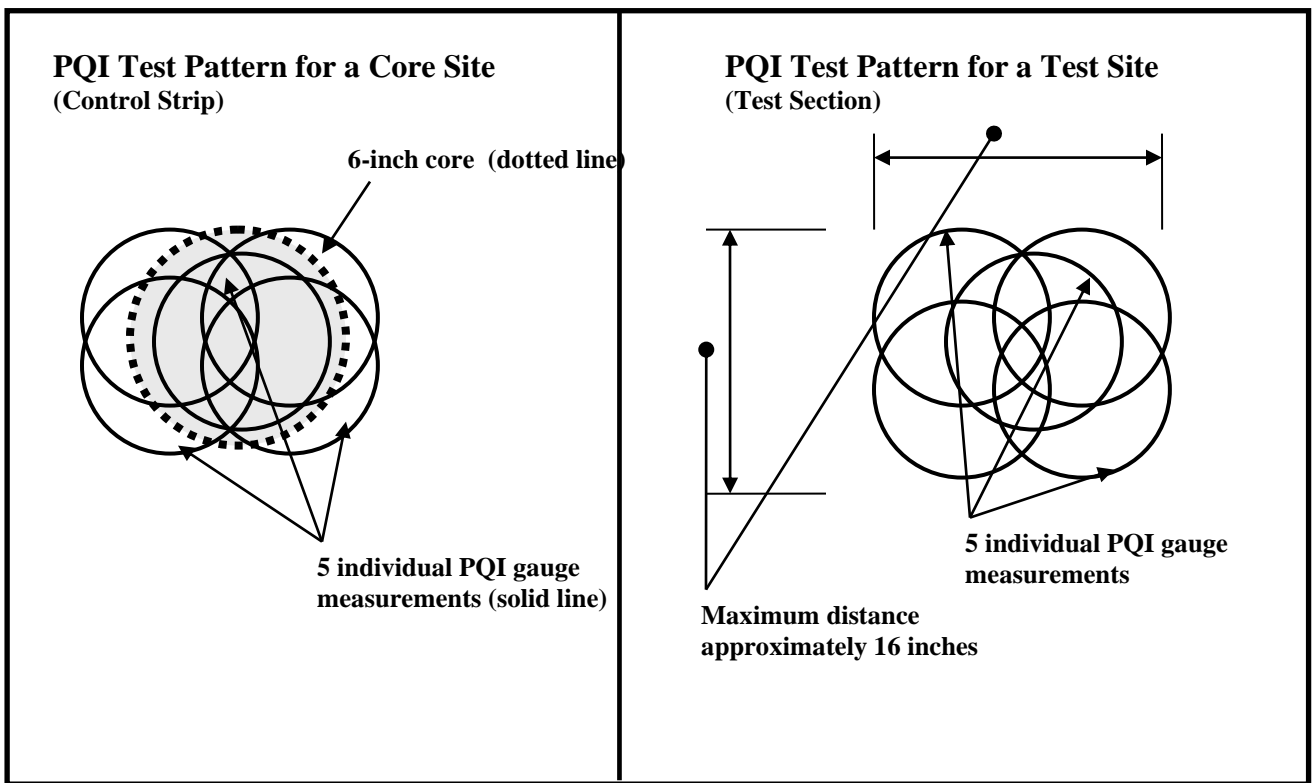

Figure 8

Press “Enter” to take the first reading. DO NOT TOUCH the gauge while it is taking a reading. Once the reading is complete move the gauge over and take another reading. Repeat the same steps until all five readings are obtained. Press “Enter” to display the average of the five measurements (refer to diagram below). Once the average is recorded on the appropriate QMS density form, press “Enter” to store the data (refer to the following diagram).

Data Management

Once the density readings have been stored in gauge memory the data can be printed. To print data, select *Data Management* from the *Control Menu*. Use the arrows to scroll to highlight the desired project to print. Once the desired file is highlighted select *Print*.

Field Operation Procedures for Pavetracker 2701-B

When a new device is purchased the operator should read and become familiar with the manufacturer's operation manual. Knowledge gained from the operator's manual will help to ensure the gauge is operated safely and efficiently.

Turning the Gauge "ON"

The gauge uses rechargeable nickel-metal hydride batteries and should be recharged if the voltage falls to 6.0 V. The gauge will automatically power down if the voltage falls below 5.5 V.

To turn the gauge on press the power switch (next to serial port on front panel). When first turned on, the device will display the following:

```
- Model 2701B -  
Battery Volts: x.x  
V #.##    SN: ###  
Press <Enter>
```

Press "Enter/Start" button on keypad. After press "Enter/Start", the device will perform two self-tests to check for malfunctions. Following the self-test the gauge will displays the Ready screen.

```
-Ready-  
Mm/dd/yyyy hh:mm AM  
Proj: Project Name  
Mode: Averaging
```

Since density readings will be stored verify the date and time are correct. To adjust date and/or time press the "Setup" key to access the Setup menu functions. The display will be:

```
-Setup-  
1. Set Units  
2. Date/Time  
3. Temperature
```

Additional menu functions are listed on the Setup menu as indicated by the double arrow. Use the "arrow" keys to scroll through the functions. Press "2" on the keypad to enter the Date/Time menu and follow the instructions listed on the LCD display.

```
-Date/Time-  
1. Change Date  
2. Change Time  
3. Time Format
```

GAUGE PARAMETER SET-UP

Measurement Unit Selection

The Pavetracker is display density measurements in either metric or English units. To set the units press “Setup” key to access the setup menu. The LCD will display:

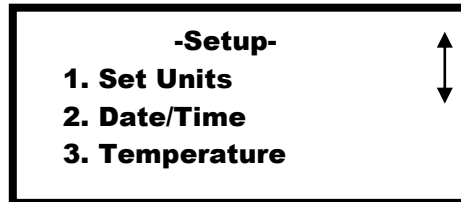

Select “1” for the following display:

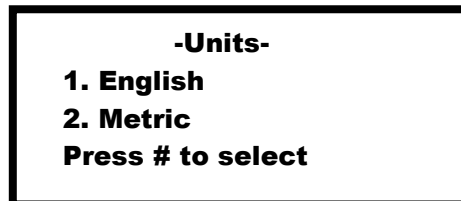

Reference Reading

To ensure accuracy of the gauge, a Reference Reading must be taken each time the gauge is turned on and periodically throughout the day. All Reference Readings must be taken on a flat smooth surface of the material being tested. Density readings can also be taken on the Reference Standard Block to verify the gauge is reading the standard block within +/- 0.5 pcf. As a minimum a density reading must be taken on the Reference Block just prior to obtaining density readings within the Control Strip and at the beginning of each Test Section. If the gauge exceeds the tolerance (+/- 0.5 pcf) another Reference Reading must be taken. Follow the procedures for performing the Reference Reading provided in the manufacturer’s operators manual. If, after two consecutive Reference Standards, the gauge does not measure the standard block with +/- 0.5 pcf, the device cannot be used for density acceptance testing. Contact the manufacturer for additional guidance regarding calibration/repair. Records of calibration must be maintained for verification by Department representatives. Department representatives may request periodic Reference Standard Block density measurements to verify the device is measuring the Reference Standard Block within tolerance.

Measurement Mode Selection

When testing with a Pavetracker Plus device at an individual test site within a Test Section or individual core site within a Control Strip, a total of five measurements will be required at each site. Taking more density measurements reduces variability providing a better representation of HMA density. Increasing the number of density readings is possible due to the short count time required to take a density reading. The Pavetracker displays results in approximately 3 seconds. The Pavetracker also provides an “Average” mode function which averages up to 30 readings. When using the “Average” mode, the average of the five stored density measurements are recorded, printed and submitted with the required QMS density forms to the appropriate QA representative. To select the measurement mode press the “Mode” key.

The display will be:

-Mode-
1. Continous
2. Averaging
3. Segregation

Press “2” to select Averaging mode.

Entering a Target Density

Input the Target Density prior to taking a measurement. Press the “Target” key and the LCD will display:

-Target-
1. Gmb/Marshall ###.#
2. Gmm/voidless ###.#
Press # to select

Press “1”

Gmb (MA) Value:
1. 0.0 3. 0.0
2. 0.0 4. 0.0
5. New 6. Disable

If the desired Target Density has been stored in memory cells 1-4, then select the correct value. If a new Target Density is being entered, press “5”.

Gmb (MA) Value:
0.0 pcf
Press <Enter>

Use the keypad and enter the Target Density and then press “Enter”. The screen will display the following:

Gmb (MA) = ###.#
Do you want to
Save this value
For later use?

If “No” is pressed the Target Density will remain active in the gauge. If “Yes” is selected the Target Density will remain active and the screen will display the following:

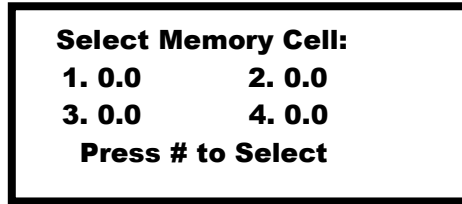

Press the number of the corresponding memory cell to store the Target Density in memory. The Target Density can then be recalled when needed.

Creating a Project

When testing asphalt for acceptance with a gauge, measurements must be recorded on the appropriate QMS form, stored in gauge memory, and printed. All copies of QMS forms along with the gauge printout tapes must be submitted to the QA representative. In order to store any density measurements a Project file must be created. To create a project, press “Proj”. The screen will display:

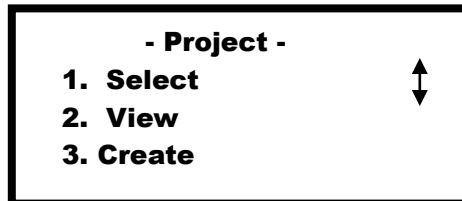

Note that several Project menu functions (i.e. “Select”, “Erase”, “Create”, etc.) are available to manage the project files within the gauge. To create a new project file, press “3”. The screen will display:

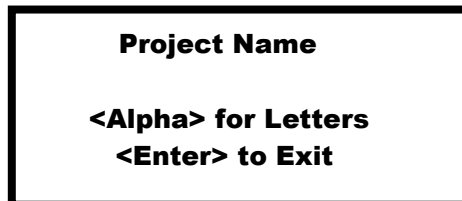

Enter the primary contract number. For example, if a resurfacing project has a primary contract number of C200001, press “Alpha Lock” then “C” followed by “Alpha Lock” then enter the numbers. Once the contract number is entered press “Enter”. The LCD will display:

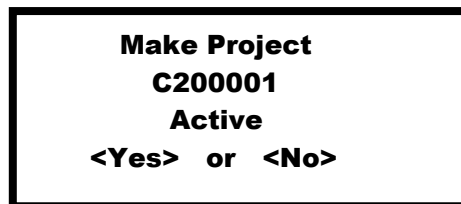

Select “Yes” on keypad. Once the project is active all measurements which are stored will be placed under that particular contract file.

Site Preparation/Gauge Positioning

- Remove any loose material (sand, aggregate, etc.) from the test site.
- If moisture is noticeable on the surface wait for the moisture to evaporate or remove the moisture with an absorbent cloth.
- Ensure the bottom of the gauge is clean and does not “rock” when placed on the mat. The device must remain level and steady. If rocking occurs, find a more suitable test site within a 3 foot radius. When taking measurements around a core the gauge operator may move the gauge 12 inches away from the core location to level the gauge, but the core must be cut from the center of the 5 gauge readings. Refer to the following diagram for a typical Pavetracker test pattern for a core site in a Control Strip and test site within a Test Section.

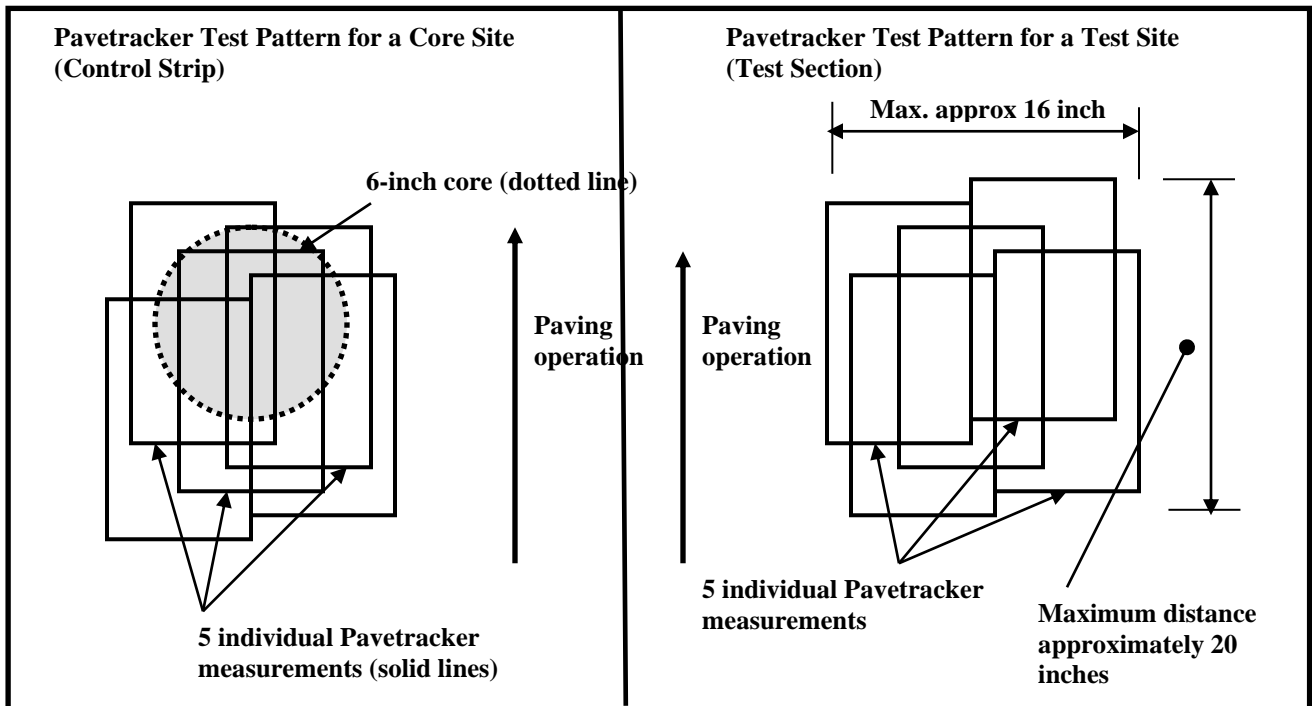

Figure 9

When taking measurements with a Pavetracker, keep the device oriented on the pavement so that it is parallel with the paving operation.

Taking a Density Measurement

Place the gauge on the test site as described in the previous section. Press “Enter/Start” and the screen will display:

Averaging Mode
Reading #: 1
Press <Start>
<Store> / <ESC> to End

Press “Enter/Start” again to begin measurement #1. DO NOT TOUCH the gauge as a measurement is being taken. Once the density results are displayed move the gauge over and repeat the same steps to take the next reading. As the readings are taken the gauge will average the results. Once all five measurements are taken, press “Store”. The screen will display:

**Do You Want To
Add Notes**

<Yes> or <NO>

Press “Yes” and use the keypad to enter the station. Once the station is entered press “Enter” to return to the Ready screen.

Printing Data

To print the stored measurement results press “Proj” for the Project menu functions. Select function “5” for Output. The screen will display:

Output:
1. One Project
2. All Project
Press # to Select

Select desire function. The screen will display:

Output:
1. 32 Column Report
2. Spreadsheet
Press # to Select

Connect the serial cable to the 9-pin serial port on the Pavetracker and connect the serial cable to the printer. Select “1” for 32 Column Report. Select “1” to print the report.

Erase Projects

Project files can be erased by pressing “Proj” to enter the Project menu functions. Select “4” to erase a project. As always remain cautious when erasing projects.

Field Compaction Quality Management System

Quality Control (QC) of Density

The Contractor shall perform quality control of the compaction process in accordance with applicable articles and provisions of Section 609 of the *NCDOT Standard Specifications for Roads and Structures (Standard Specifications)*. The Contractor may elect to use either cored sample density procedures or nuclear gauge density procedures. When placing surface mixes the Contractor may also elect to use non-nuclear density gauge procedures. Non-nuclear gauges cannot be used to test base or intermediate mixes for density acceptance. Non-nuclear gauges currently approved to test surface mixes are Troxler Pavetracker Plus Model 2701-B and TransTech PQI Models 301 and 380. The Contractor shall provide the method and frequency of density quality control to the Engineer at the preconstruction conference.

For individual structure replacements and projects having 1,500 linear feet or less of roadway pavement modified density acceptance process shall be used. Procedures for small quantities density acceptance are provided in Section 10.8.2 of the *Superpave Asphalt Quality Management System* manual.

Nuclear or non-nuclear density control shall be in accordance with the procedures outlined in this manual. Nuclear density shall be determined by the backscatter method of testing using a nuclear gauge with thin-lift and printer capabilities, which has been approved by the Department. The Contractor shall furnish, maintain, and operate the density gauge. The density gauge operator shall have been certified by the Department. The density gauge shall have been calibrated within the previous 12 months by a calibration service approved by the Department. The Contractor shall maintain documentation of such calibration for a 12-month period.

All density gauge readings taken for either density acceptance or establishment of a target density in a control strip must include:

- Recording density results on the appropriate QMS form(s) (record the average of 5 readings if using a non-nuclear gauge)
- “Storing” gauge density measurements in gauge memory
- Printing density measurements stored in gauge memory
- Providing gauge printouts and appropriate QMS form(s) to the QA representative

All density measurements taken with a density gauge must be marked on the pavement by tracing the “foot print” of the device. If an area is re-rolled, the test site must be re-tested and a comment placed on the test report as to the reason. Any repeated moving of any density gauge to “cherry pick” or find a passing density result or core site is a direct violation of testing procedures and could be deemed as falsification. For resurfacing projects where conditions of the existing pavement may influence the density results, it is recommended that the Contractor and Engineer simultaneously evaluate the existing pavement prior to the placement of a new asphalt mix. The information recorded from the evaluation can aid in the final acceptance process.

The minimum frequency of sampling and testing shall be on the basis of test sections consisting of not more than 2,000 linear feet (600 linear meters) or fraction thereof per day, on pavement placed at the paver laydown width. Do not divide full test sections, consisting of 2,000 linear feet (600 linear meters), unless otherwise approved by the Engineer. As an exception, when a day’s production is

less than 6,000 linear feet of laydown width, the total length paved may be divided into 3 equal test sections, provided that nuclear testing has not already occurred or core sample locations established. Nuclear or non-nuclear gauge readings taken for density acceptance or establishment of a control strip must be taken after the finish (or final) roller has completed the compaction operation. If the fraction of a test section remaining at the end of a day is less than 100 linear feet (30 linear meters), it is recommended that the density be represented by the results of the previous section provided the approved compaction equipment and procedures are used. If the fraction remaining is at least 100 linear feet (30 linear meters), it will be considered a separate test section and shall be sampled and tested accordingly. In cases where a paving operation finishes paving one lane of a two lane road and moves to the other lane, "wrap around" test sections will not be permitted unless approved by the Engineer. If approved by the Engineer, a test section consisting of a fraction of the first lane and a fraction of the second lane may be combined and tested as one test section provided the total length of the section does not exceed 2,000 linear feet. If "wrap around" testing is not approved, the test section will end where the paver stopped placing mix in the first lane and a new test section will begin where the paver begins placing mix in the second lane.

When utilizing a nuclear gauge, the testing frequency shall consist of five random gauge readings (one random reading from each of five (5) equally spaced increments) from each test section. In addition, not less than five (5) nuclear gauge readings (one test section) shall be taken from any acceptance lot of a given mix type. When utilizing a non-nuclear gauge, the testing frequency shall consist of five randomly located test sites from each test section. Five individual gauge readings will be taken at each test site and the results will be averaged to determine the percent compaction. Only the average of the five non-nuclear gauge readings will be recorded on the appropriate QMS form and stored in gauge memory for printing. In addition, not less than one test section (25 non-nuclear gauge readings) shall be taken from any acceptance lot of a given mix type. QC nuclear or non-nuclear density tests shall be conducted the same day that the mix being tested was placed and compacted. Should the specified density tests not be completed within the applicable time frame, production will cease at that point until such time the required tests are completed.

Sample and test all pavements that meet the following criteria unless otherwise approved.

1. All full width travel lane pavements, including:
 - a. Normal mainline and -Y- line travel lane pavements
 - b. Turn lanes
 - c. Collector lanes
 - d. Ramps and loops
 - e. Temporary pavements
2. Pavement widening 4.0 feet (1.2 meters) or greater
3. Uniform width paved shoulders paved in the same operation as the travel lane.
Uniform width paved shoulders greater than 4.0 feet paved as a separate operation from the travel lane.

The Contractor shall maintain minimum test frequencies. Should the Contractor's density testing frequency fail to meet the minimum frequency all mix without required density test representation shall be considered unsatisfactory and if allowed to remain in place, will be evaluated for acceptance in accordance with Article 105-3.

Sampling and testing will not be required for the following pavement provided it is compacted using acceptable equipment and procedures. Compaction with equipment other than conventional steel drum rollers may be necessary to achieve adequate compaction for the paving conditions listed below.

1. Pavement widening less than four (4) feet (1.2 meters)
2. Intersections and driveways paved as a separate operation and less than 100 feet.
3. Pavement in irregular areas. Irregular areas are shapes such as tapers or bulb outs that may make them difficult to compact.
4. Paving for patching, wedging, or leveling.

Contractor's Control Strip Procedures (QC)

Location

It is the Contractor's responsibility to determine roller patterns and establish acceptable control strips at locations approved by the Engineer. The Contractor shall notify the Department's Roadway Inspector sufficiently in advance of the placement of control strips to allow establishment of QA target density and to witness the QC technician's Standard Count Procedure. The subgrade, base or existing roadway material on which the control strip is constructed must be representative of the majority of material where the test sections will be constructed.

Frequency (Control Strips)

A control strip shall be placed within the first test section of each job mix formula on a contract provided sufficient mix is produced to construct a 300 foot control strip. After the initial control strip on each job mix formula is placed, a control strip shall be placed at a minimum of every 14 calendar days. A control strip placed for any of the below listed reasons will suffice for this requirement.

1. Control strips shall be placed anytime one or more of the following JMF changes are made:
 - a. Any percentage change in binder content
 - b. An aggregate blend change in excess of +/-10%
 - c. Any change in G_{mb} or G_{mm} on the JMF
2. Control strips shall be placed for each layer of mix.
3. Control strips shall be placed anytime the underlying surface changes significantly.
Note: Pavement transitioning from a milled to a non-milled underlying texture or vice versa, does not require a new control strip.
4. Control strips shall be placed for different layer thickness of the same type mix when the specified thickness varies more than +/- 1/2 of an inch (12.5 millimeters).
5. Control strips shall be placed anytime the Contractor is proceeding on a limited production basis due to failing densities.
6. Control strips shall be placed anytime a new, re-calibrated, or different density gauge is initially used.
7. Control strips shall be placed if a different plant is used.
8. The Engineer may require control strips anytime he/she deems necessary.

Mix Sampling Requirements for Control Strips

Quality control mix sampling and testing shall be performed on the mix in accordance with Sub article 609-6 (B) of the *Standard Specifications*, except when placing mix on a limited production basis due to failing densities. In this case, a full test series shall be performed on the actual mix placed in each control strip. When a mix sample is required to be taken in conjunction with a control

strip, that sample will not substitute for the next randomly scheduled QC mix sample for that tonnage increment. Subsequent QC mix samples will be taken at tonnages in accordance with normal random sampling procedures. When placing mix on a limited production basis, the contractor's QC plant personnel will notify Roadway personnel as to which truck the sample was taken from. The notification method will be at the Contractor's option (Radio, telephone, and note on load ticket, etc.)

Numbering (Control Strips)

1. Control strips for a given contract shall be numbered consecutively by type mix, regardless of plant furnishing the mix. However, if a control strip is made for mix out of a second plant, the number for this control strip will be followed by the suffix A -- a third plant control strip would be followed by a B, etc. For example: 1st plant C.S. would be 1, 2, 3; 2nd plant C.S. would be 4A, 5A, 6A; 3rd plant C.S. would be 7B, 8B, etc.
2. Each type mix will have a separate series of control strip numbers.
3. Both passing and failing control strips will be numbered and reported to the Engineer.
4. If a secondary gauge is used on a control strip for back-up purposes, the secondary gauge control strip will be numbered with the same numbers as used for the primary gauge except that it will be followed by the suffix "S".

Establishment of Control Strip (QC Procedures)

To establish a control strip, asphalt shall be placed on a section of roadway approximately 300 feet (100 meters) in length. The width shall be equal to the lay-down width of the paver. The material should be of a depth equivalent to the layer depth shown in the plans or required by the Specifications. The Engineer may determine that the control strip is representative of the shoulders and that the control strip may be used to determine the required density for the shoulders. If shoulder control strips are constructed, they should be constructed to the full shoulder width and the depth shown on the plans.

The density obtained on the control strip determines the density required for that layer until the next control strip is constructed. Therefore, it is important that the compaction equipment used on the control strip is operating properly and is capable of compacting the material. Reference should be made to the applicable sections of the *Standard Specifications* for minimum equipment requirements.

In order to achieve a complete and uniform coverage, the compactive effort shall consist of roller passes made over the entire control strip surface. Breakdown rolling shall be performed at the maximum temperature at which the mix will support the rollers without moving horizontally. The breakdown roller should normally be operated with the drive wheel nearest the paver. The Contractor will be responsible for carrying out the compaction operation in such a manner as to obtain the required density uniformly over the entire control strip. The compaction rolling shall be completed prior to the mixture cooling below a workable temperature.

In order to ensure complete and uniform coverage, the compactive effort shall consist of individual roller passes made over the entire control strip surface. Each coverage should be completed before beginning the next. The density gauge operator should observe the rolling operation to ensure that the control strip is rolled uniformly. The random locations of core samples from the control strip shall not be marked on the pavement until the compaction operation in the control strip has been satisfactorily completed. Cores within a control strip shall be cut and removed prior to opening that section to traffic.

Control Strip Core Samples

1. Five (5) core samples shall be taken in a control strip. If a core is damaged, follow procedures for check cores.
2. Core samples in the control strip shall be placed a distance of fifty 50 feet (15 meters) apart.
3. Core samples shall be located randomly across the width of the mat.

NOTE: The results of the cored samples and their average will be reported at the top of M&T Form 514QA/QC.

Numbering Core Samples from a Control Strip

Core samples from control strips will be numbered according to guidelines for numbering all core samples. The letters “QC” will follow all sample numbers.

When placing two mix types on the same project, core samples will be numbered as follows:

I 19.0B 1st Control Strip (core samples) 1QC, 2QC, 3QC, 4QC, 5QC; 2nd Control Strip (core samples) 6QC, 7QC, 8QC, 9QC, 10QC, etc.

S 9.5A 1st Control Strip (core samples) 1QC, 2QC, 3QC, 4QC, 5QC; 2nd Control Strip (core samples) 6QC, 7QC, 8QC, 9QC, 10QC, etc.

Procedures for Checking Core Samples from a Control Strip

Check core samples may be taken by the Contractor for either of the following reasons:

1. When a control strip fails and a core sample(s) is more than 2.0 percent below the average of the control strip, that core(s) may be checked.
2. One of the original core(s) is damaged.

For each core sample that is to be checked, take 3 check samples as follows: one adjacent to the initial sample and one ten feet (3 meters) in each direction, longitudinally, of the initial sample. The results of these 3 check samples will be averaged and this average will be used in lieu of the initial core results in question. The initial core samples will not be used if check samples are taken. Check samples must be taken within 2 calendar days of the initial sample. Only one set of check samples per sample location will be allowed. The separation of the layer to be tested will be the responsibility of the Contractor. Take all check samples in the presence of a representative of the Engineer. In addition, a QA comparison core sample(s) may be taken adjacent to one or more of the check samples. To establish the control strip, 2 nuclear gauge readings must also be taken at each of the 3 check sample core sites. The gauge readings taken on the left side of each check core will be averaged and will replace the left gauge reading taken at the original core site. The same procedure will be followed for the gauge readings taken on the right. The results from the 3 check cores and 6 gauge readings will be used to calculate the target density. If using a non-nuclear gauge for density acceptance testing, 5 gauge readings will be taken at each of the 3 check sample core sites. The non-nuclear gauge measurements taken at each check core site will replace the original core site measurements. The results from the 3 check cores and 15 non-nuclear gauge readings will be used to calculate the target density.

Numbering Quality Control Check Core Samples

The *Standard Specifications* allow check samples adjacent to the original core and 10 feet (3 meters) longitudinally each side of the original core.

All check samples will carry the same base number as the original core sample followed by a C₁, C₂, and C₃ series of suffixes.

Example: If core number 8 is in question, the check core sample will be:

8C₁ (10' / 3m down station), 8C₂ (adjacent), and 8C₃ (10' / 3 m up station)

Retention of Control Strip Core Samples

QA personnel will re-test 100% of the control strip cores. All retained samples shall be stored on a smooth, flat surface in a cool, dry protected location.

QC Target Density

Before establishing the QC target density, the QA Roadway Inspector and/or the QA nuclear gauge operator will witness the Standard Count procedure for the QC nuclear gauge(s). Likewise, the QC nuclear gauge technician will witness the Standard Count procedure for QA nuclear gauges. If the standard counts pass, these Standard Counts will be recorded on the M&T 514QA/QC form. It is not necessary to perform another daily standard count specifically for a control strip, so long as the Department witnessed the QC standard count that day and the materials, and underlying base have not changed.

After the Contractor has completed compaction of the control strip, the QC Density Gauge Operator will conduct ten (10) nuclear gauge density tests, two (2) readings at each of the five (5) random core locations in the control strip. The nuclear gauge readings shall be performed directly on the core site (refer to Figures 4 or 7). Do not move the nuclear gauge in between each measurement. When testing with a non-nuclear gauge, the density gauge operator will conduct twenty-five (25) non-nuclear gauge density tests, five (5) readings at each of the five (5) random core locations within the control strip. The surface of the material being tested shall be smooth prior to any tests being performed. The results of the gauge measurements will be averaged and the resulting average density will be used in determining the target density for all test sections being constructed in conjunction with a particular control strip. The target density will be determined by dividing the average density by the average percent compaction of the five (5) core samples from the control strip. Test section densities will be expressed as a percentage of the target density.

The final density of the control strip shall be at least equal to the minimum density specified for the mix based on the maximum specific gravity (G_{mm}). In addition to determining the target density, the following procedures and tests will be performed to assure that the final density of the control strip meets the minimum density requirements:

1. Prior to opening the control strip area to traffic or no later than the beginning of the next day following the completion of the control strip, the Contractor shall core five (5) samples from the control strip. The density of each cored sample will be determined in the QC field laboratory. Artificial cooling of the pavement layers by the Contractor will be permitted in order to obtain cored samples as quickly as possible. No compensation will be made for the cost of artificial

cooling. Cored samples shall be taken in accordance with applicable provisions of Article 609-7 of the *Standard Specifications*.

2. During the time between the completion of the control strip and the determination of the density of the cored samples, the Contractor will be permitted to continue to place pavement which will be evaluated on the basis of a calculated target density determined by multiplying the unit weight of water (62.4 pcf) by the maximum specific gravity of the mix. Evaluation of the test sections during this time period will be based on this calculated target density provided all other specification requirements are met. Once an acceptable correlated target is established, all previous test section densities shall be re-calculated using this correlated target.
3. If the average density of the five (5) cored samples is at least equal to the minimum density specified for the mix, the control strip is considered valid and paving may continue in the normal manner.
4. If the average density of the five (5) cored samples fails to meet the minimum density, specified for the mix, the control strip will be considered unacceptable. The Contractor shall immediately construct a new control strip in accordance with the provisions of Items 1 through 3 above.
5. If the second control strip also fails to meet the minimum density specified for the mix, placing of pavement shall proceed on limited production basis as defined under "Limited Production Procedures" in Section 10-9 of the current *Superpave HMA/QMS* manual.
6. Check samples may be taken on any control strip core samples, but must be in accordance with "Procedures for Checking Core Samples from a Control Strip" as previously described in this manual (Sub article 609-7 (A) of the *Standard Specifications*). A new target density will then be determined using the new core sample average and the new average of the gauge readings. This process should be completed as soon as possible after the initial determination of a target density since it is the controlling factor in checking density thereafter.
7. Once a correlated target density is established, it will be used thereafter to determine density acceptance until a new acceptable target is obtained for that mix. For control strips required every 14 days, all mixed placed the same day as the control strip will be accepted based on the target density established in that control strip. Once the density results of the cored samples from the new control strip are determined and a new acceptable target density established, the new target will be used to determine acceptance for that mix placed during the day's production thereafter until another 14 calendar day control strip is required, at which time this process is repeated. Should the Contractor elect to produce a different mix design of the same mix type, all of the previous mix in question that has not been tested with a correlated target density will be accepted based on the calculated target unless the Contractor elects to cut density acceptance cores.
8. If more than 17 calendar days have lapsed since last using a correlated target density, the procedures for obtaining a new correlated target, as detailed in Items 1-7 above, shall be followed. However, the current maximum specific gravity moving average will be utilized to determine the calculated target instead of the JMF maximum specific gravity.

QC/QA Nuclear Density Control Strip Procedure

10 Nuclear Gauge Readings (2 @ 5 core locations) will be taken within the 300' (100m) control strip.
 5 Core Samples will be taken at 50' (15m) intervals, randomly across the width within the 300' control strip

All gauge operators (QC/QA) shall be approved by the NCDOT.

QC gauge operator shall confirm with the DOT Roadway Inspector on when and where the control strips will be placed.

The DOT Roadway Inspector shall inform the QA Supervisor and/or the QA nuclear gauge operator of the control strip placement.

The QA Roadway Inspector and/or the QA Nuclear gauge operator will witness the Standard Count procedure for the QC nuclear gauge(s). Likewise, the QC Nuclear gauge technician will witness the Standard Count procedure for QA nuclear gauges. These Standard Counts will be recorded on the M&T 514QA/QC form.

Two nuclear gauge readings will be taken at each core sample site. The nuclear gauge readings shall be performed directly on the core site. The nuclear readings shall be compared to the core sample results and a nuclear target density shall be determined using the M&T 514 QA/QC form.

QA Personnel will establish their own target density from control strip results, if possible. If it is possible to take QA readings from the control strip, the QA target density will be determined by multiplying the appropriate Specific Gravity (Gmm) times 62.4 lbs/c.f. (1000 kg/m³)

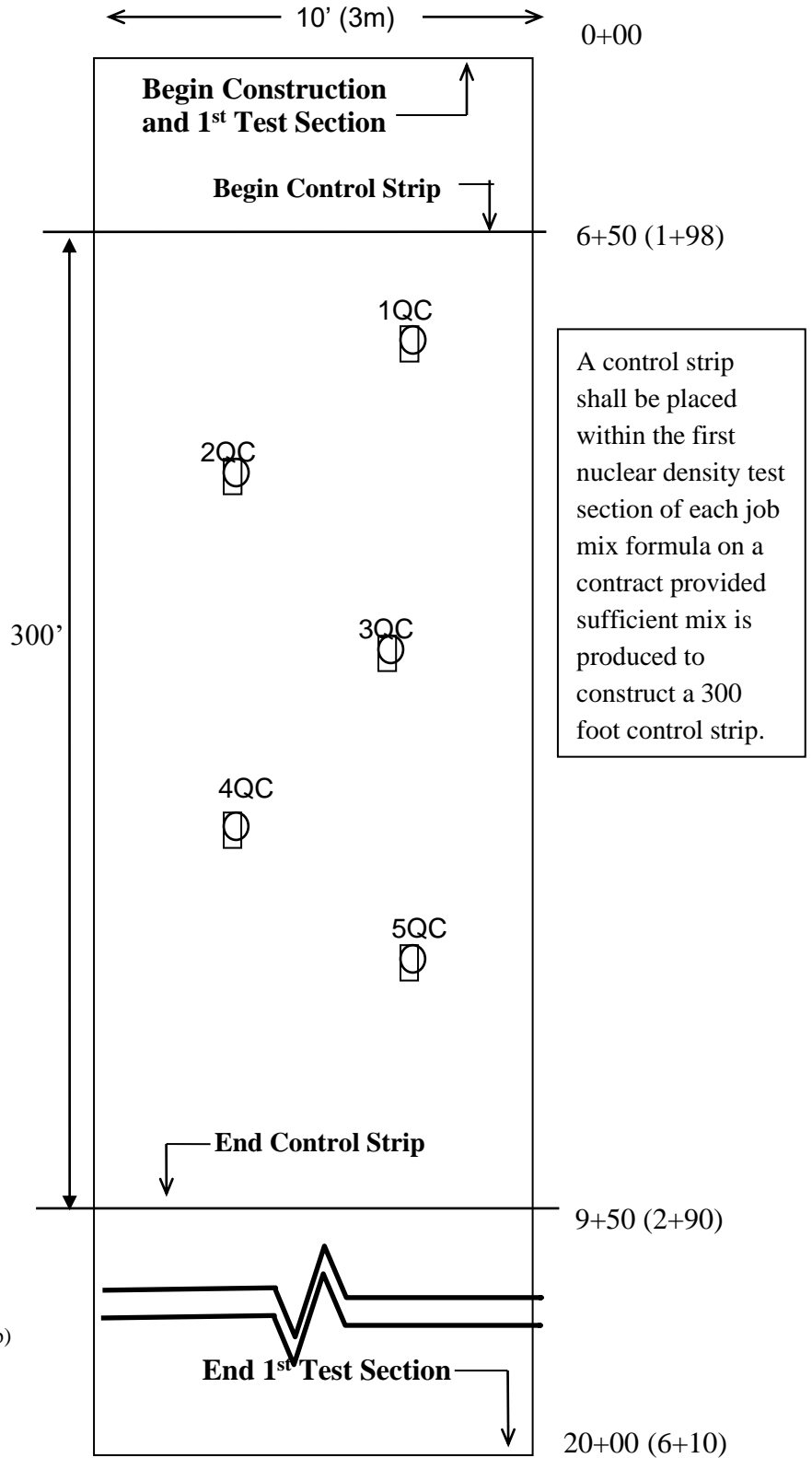

Contractor's Test Section Procedures (QC)

Establishment of Test Sections

A test section is the testing unit for compaction. The lengths of these test sections shall be no more than 2,000 linear feet (600 meters) or fraction thereof per day on pavement placed. If the fraction of a test section remaining at the end of a day is less than 100 linear feet (30 linear meters), it is recommended that the density be represented by the results of the previous section provided the approved compaction equipment and procedures are used. The width of the test sections shall be the same as the paver laydown width. The first test section will begin with the first load of each type mix on each contract.

Test sections will be checked for acceptance as prescribed. The material used in a test section shall be from the same source and shall be of the same type as the material used in the applicable control strip. The depth of a test section shall be within $\pm 1/2$ inch to that of the control strip previously constructed for use with the test section involved except in cases where roadway control strips are used to determine required density for shoulder material.

Testing a Test Section

The test sections shall be divided into five (5) equal segments each from which one test site is to be located. The location of the test site within the segment is to be at random. Do not identify, mark or take acceptance measurements on the test site until the final or finish roller has completed the compaction operation. Refer to the instructions for random sampling in this manual.

Before testing begins with a nuclear gauge, the daily standard count should be compared to the standard count used to construct the active control strip. The daily standard count should be within the allowable Standard Count Range. The upper range limit is calculated by taking the standard count used for the construction of the active control strip and adding 1%. Likewise, the lower range limit is calculated by subtracting 1% from the standard count used to construct the active control strip. This allowable range is computed and recorded on the M&T 514QA/QC form.

As long as the daily standard count passes the system 1 and system 2 requirements of the gauge and is within the allowable Standard Count Range for the active control strip, testing may be performed. However, if either the daily standard count does not pass the system 1 and system 2 requirements, or if the standard count is outside of the allowable Standard Count Range from the active control strip, then another standard count must be taken until it passes all criteria.

Once the daily standard count is accepted and test locations have been determined, a nuclear density test will be taken at each site. If a non-nuclear gauge is being used 5 density measurements will be taken at each test site and the average of the five readings will determine the density for that particular test site and recorded on the appropriate form. Refer to Figure 8 in this manual for the testing pattern of a PQI 301 gauge and Figure 9 for the testing pattern of a Pavetracker Plus 2701B gauge. The results shall be in % compaction, tabulated on Test Section Density Form M&T 516QC and the five test sites averaged.

Numbering Test Sections

Asphalt test sections will have a separate series of numbers for each type mix per paving operation for each contract. Test sections for a given contract shall be numbered consecutively by type mix, regardless of plant furnishing mix. When the Contractor has more than one crew placing the same mix on the same project, the test section numbering will run consecutively. If more than one paving crew is placing the same mix designate a crew number and maintain that designation throughout the entire paving project. The crew designation should be indicated on the QMS Forms: 514 QA/QC, 515 QA, and 516 QC.

Test Section Requirements

Unless otherwise specified in the contract, the required density for all Superpave mixes shall be as follows:

Type Mix	Minimum % G_{mm} Maximum Specific Gravity (AASHTO T-209)
S4.75A	85.0 ^(a)
S9.5B	90.0
B25.0C, I19.0C, S9.5C, and S9.5D	92.0

(a) Compaction to the above specified density will be required when the S 4.75 A mix is applied at a rate of 100 lbs/sy (55 kg/m²)

The actual test section density will be determined by the average of five (5) nuclear density tests made at random locations within five (5) equal segments of the test section. If using a non-nuclear gauge the actual test section density will be determined by the average of twenty-five (25) non-nuclear density tests made at random locations with the five (5) equal segment of the test section. This actual density will be compared to the target density to determine compliance.

If the average fails to meet the above requirements, the test section will initially be considered as failed, but additional rolling may be performed by the Contractor. A note should be made to the effect that this section was re-rolled. In this case, acceptance of the test section will be based on the average after re-rolling.

If the QC test results indicate failing density of the mix based on the calculated target that mix may be subject to pay reduction or removal in accordance with the provisions of Section 610-14 of the *Standard Specifications*. Once the correlated target density is determined and if the recomputed densities still indicate that the mix fails to meet the requirements specified in Section 610-14 of the *Standard Specifications*, it will be subject to pay reduction or removal. If the recomputed densities indicate passing results, the mix will be accepted as passing.

Procedures for Re-testing a Nuclear or Non-nuclear Test Section

When nuclear or non-nuclear control is being utilized and a test section is more than 2.0 percent below the lot average, the Contractor may elect to re-test that test section.

All re-testing shall be performed in the presence of a representative of the Engineer. The re-testing of test sections must be performed within 2 calendar days of the date of the initial sample. A test section

will only be re-tested once. In addition, QA comparison nuclear or non-nuclear density readings may be taken at all locations.

Re-testing of test sections will be performed as follows:

1. 5 new random test sites will be determined jointly with a representative of the Engineer.
2. All re-test readings must be stored and printed
3. The average of these 5 new nuclear readings or 25 new non-nuclear readings will replace the initial test section results.
4. The lot average will be recalculated.

Density Limited Production Procedures

The Contractor shall operate on a limited production basis if, for the same mix type, one of the following items occurs.

1. Two consecutive failing lots, excluding lots representing an individual resurfacing map or portion thereof.
2. Three consecutive failing lots, with each lot representing an individual resurfacing map or portion thereof.
3. Two consecutive failing control strips.

Pavement within each construction category (New and Other), as defined in Article 610-14 of the *Standard Specifications*, and pavement placed simultaneously by multiple paving crews will be evaluated independently for limited production purposes.

Once the Contractor is placed on limited production he shall remain on limited production for that mix type regardless of the plant or JMF. As an exception, the Engineer may grant approval to produce a different mix design of the same mix type if Quality Control and Quality Assurance plant mix test indicate the failing densities are attributed to the mix problem(s) rather than compaction related problems. The determination of whether a mix problem exists at this time made by QA personnel (normally the QA Supervisor).

Limited production is defined as the production, placement and compaction of a sufficient quantity of mix to construct a 300 foot control strip plus 100 feet of pavement adjacent to each end of the control strip.

The Contractor shall remain on limited production until such time as satisfactory density results are attained or two control strips have been attempted without achieving acceptable density test results, whichever occurs first. Should the Contractor fail to achieve satisfactory density at this point, production of that mix type shall cease until such time as the cause of the failing density test results can be determined. As an exception, if there are mix property problem(s) at the same time that limited production occurs due to failing densities, the Contractor may elect to produce a different mix design of the same mix type. The determination of whether a mix problem exists at this time will be made by the QA Supervisor.

When proceeding on limited production due to failing density, the 500 feet of pavement, which includes the control strip, will be considered a lot. The average density of the five control strip cores will be used as the density result for acceptance of that lot in accordance with Article 610-14 of the *Standard Specifications*.

Should the Contractor not operate by the limited production procedures as specified above, the failing lots and all mix produced thereafter will be considered unacceptable. This material shall be removed and replaced with material, which complies with the specifications. The final in-place materials will be accepted in accordance with article 105-3 of the *Standard Specifications*.

Department's Quality Assurance of Density (QA)

Quality Assurance is a process of sampling and/or testing the Contractor's product and monitoring his operations to confirm that the Quality Control results are adequate and accurate. The Department shall provide a certified gauge operator for this purpose.

Quality Assurance testing shall be accomplished in the following ways:

- 1) Re-testing randomly selected quality control (QA test) nuclear or non-nuclear test sections at a frequency equal to or greater than **5%** of the required Quality Control density gauge testing frequency;
- 2) Periodically observing tests performed by the Contractor;
- 3) Conducting verification testing ("V" test) on nuclear or non-nuclear test sections at different random locations within the same QC test sections, at a frequency of at least **10%** of the required QC sampling and testing frequency;
- 4) By periodically directing the recalculation of random numbers for the Quality Control density gauge test locations. The original QC test locations may be tested by QA and evaluated as verification tests;
- 5) Periodically requiring the Contractor to re-test marked test site(s) in the presence of a certified QA gauge operator;
- 6) Witnessing the daily quality control nuclear gauge Standard Count procedure;
- 7) Witnessing the Pavetracker 2701B Reference Count;
- 8) Requesting the QC to take a density reading on the Reference Block to verify Pavetracker is measuring correctly
- 9) Witnessing the PQI Test Block Procedure;
- 10) Verifying PQI Test Block results are within tolerance
- 11) Re-testing 100% of all nuclear or non-nuclear control strip cores; or
- 12) Any combination of the above.

QA Nuclear or Non-nuclear Control Strip Procedures

There will be no separate QA Nuclear or non-nuclear Control Strips constructed unless directed by the Engineer. The Engineer will monitor the construction of all QC nuclear or non-nuclear control strips by having a representative present during construction of all control strips. The Contractor, subject to the Engineer's approval, will determine the location of a control strip and the core samples within it.

When the control strip is used to establish a target density, the Quality Assurance gauge operator will conduct ten (10) nuclear density tests, two (2) each at five (5) core locations in the control strip. The results of the ten (10) tests will be averaged and the resulting average density will be used in determining the target density for all test sections being tested in conjunction with a particular control strip. When testing with a non-nuclear gauge, the QA gauge operator will conduct twenty-five (25) non-nuclear gauge density tests, five (5) readings at each of the five (5) random core locations within

the control strip. The target density will be determined by dividing the average density by the average percent compaction of the five (5) core samples from the control strip.

The Engineer may elect to take QA comparison core samples adjacent to any or all QC core samples within a control strip.

If for whatever reason, the Engineer cannot determine a target by taking the ten (10) nuclear gauge readings from a control strip, he may elect to determine a QA target density by use of the maximum specific gravity. In this case, the target density will be determined by multiplying the maximum specific gravity by the unit weight of water (62.4 lbs/ft³). This method cannot be used when testing with a non-nuclear gauge. Non-nuclear gauges must be calibrated to the mix by establishing a target density from a control strip.

Test section densities will be expressed as a percentage of the target density. The QA control strip shall have the same number as the QC control strip with the addition of the suffix QA.

QA Nuclear or Non-nuclear Test Section Procedures

QA Density Procedures (“QA” Test Sections)

The Department’s Quality Assurance Gauge Operator will randomly select quality control test sections at a frequency of 5% or more of the same sections tested by the contractor. The location of the test within each of the 5 equal segments will be at the same random QC test location. The QA test sections will have the same base number as the QC test sections followed by the suffix QA. The results shall be recorded in percent, tabulated on test section density form M&T 515QA and the five (5) test sites averaged.

QA Density Verification Testing (“V” Test Sections)

Verification testing is an integral part of the Department’s quality assurance process. It is independent testing performed by the QA personnel to help assure the asphalt mat is adequately compacted. Listed next are the Department’s current guidelines on verification testing for density control. It is very important that all personnel involved with the QMS density testing procedures on asphalt pavements are knowledgeable of these requirements and guidelines. Should these test results vary considerably from the Contractor’s QC results or fall below the minimum specification acceptance limit, further testing may be directed by the Department which then could be used as part of the acceptance process. Testing the same test section as both “QA” and “V” test section is not permitted as part of quality assurance procedures.

Roadway Density Nuclear or Non-Nuclear Gauge Procedures

- a) The verification requirement will be satisfied by the Department’s gauge operator assuring that at least 10% of the required number of Quality Control test sections are tested by determining a new set of random sample locations other than those used by the QC gauge operator. All verification same numbers and random locations will be documented in a field book by the QA gauge operator. Refer to Section 10 of the HMA/QMS Manual for an example.
- b) These verification test sections will be in addition to the minimum 5% required QA samples.

- c) Verification test sections will be numbered by the DOT density gauge operator. These verification test sections will be at random locations within the same test section as the QC test section. Verification test sections will be numbered by using the same base as the QC test section followed by the suffix “V”. i.e. 1V, 5V, 10V, etc.
When the Contractor has more than one paving crew on the same project the same day, using nuclear or non-nuclear density control, verification samples will have the same base number as the QC test section followed by the suffix “V”. Designated the crew number of the paving crew and list the information and the appropriate QMS forms. Documentation of these verification test sections will be on the appropriate QMS nuclear or non-nuclear density forms. These forms shall be maintained in the project files by the Resident Engineer.
- d) In addition to the above, random cores will be taken monthly by the IA Section of the Materials and Tests Unit, except on projects “open” to traffic, on which random control strip core samples will be picked up by IA for comparison testing by the Materials and Tests Unit.

Differences between the Contractor’s quality control and the Department’s quality assurance test results will be considered acceptable if within the following limits of precision.

Test	Acceptable Limits of Precision
Gauge Comparison of QC Test Section (average of tests in test section)	+/- 2.0% (percent compaction)
Re-test of QC Control Strip Core Sample	+/- 1.2% (percent compaction)

Dispute Resolution Procedures

In the event test results are outside the above acceptable Limits of Precision, a Dispute Resolution Process must be implemented. The QA technician shall immediately notify the QC technician and both technicians will jointly perform a Field Confirmation of Density Gauges. QC and QA technicians should verify all applicable gauge parameters are correct for each device (i.e. lift thickness, Standard Count results, test mode, target density, etc.) If any discrepancy is discovered, it should be corrected prior to proceeding with the Field Confirmation. The QA technician will randomly select a test site on the mat. QC and QA technicians will take a 1 minute nuclear gauge reading or 5 non-nuclear gauge readings with their respective gauges within the identical “footprint” (ensure nuclear gauges are at least 33 feet apart and 10 feet from large objects including pickup trucks and construction equipment when taking readings). If the QC and QA gauge readings are not within Limits of Precision (+/- 2.0 %), contact the GeoMaterials Laboratory to request a Detailed Investigation (919) 329-4150. When requesting a Detailed Investigation, be prepared to provide a brief summary describing issue(s). If the readings are within Limits of Precision, the test section(s) in question shall be re-tested by both the QA and QC technicians using the appropriate procedures.

Dispute Resolution Procedures - Verification Test Section

While being observed by the QA technician, the QC technician will re-test the original QA verification test sites. The QC technician will record re-test results in the “Comments” space provided on the 516 QC Form. While being observed by the QC technician, the QA technician will re-test the original QC test sites. The QA technician will record re-test results in the “Comments” space provided on the 515 QA Form. If the re-test does not confirm the original density results, (i.e. average of QC re-test exceeds +/- 2.0 % of original QA verification test section average and/or average of QA re-test exceeds +/- 2.0 % of original QC test section average) it indicates a possible

issue with either gauge or a test procedural error. The QA representative should contact the GeoMaterials Laboratory to request a Detailed Investigation. If the average of re-test confirms the original density results (i.e. QC re-test is within 2.0 % of QA original readings and QA re-test is within 2.0 % of original QC readings), it indicates possible density non-uniformity across the mat. The QA technician should notify the Engineer and work with the QC technician to determine cause (i.e. construction issue, joint densities, material issue, condition of underlying layer, etc.). If the investigation determines the issue is due to the condition of the underlying layer, an entry will be made on the M&T 515 QA Form documenting the reason. Where visibly evident take photographs of existing roadway, prior to covering with re-surfacing layer. Paving and testing operations should proceed in normal manner. If the underlying layer is not suspect, the Contractor may take corrective action. If the Contractor elects to re-roll the area in question the QC and QA technician must re-test their original test sites and replace the original readings. If the Contractor does not re-roll the area, acceptance will be based on the QC results. The QA technician will perform a second verification test section (following initial one in question). If the results of the second verification test section exceed the Limits of Precision, contact the GeoMaterials Laboratory to request a Detailed Investigation.

Dispute Resolution Procedures – QA Test Section

While being observed by the QA technician, the QC technician will re-test the original test sites. The QA technician will re-test the original test sites while being observed by the QC technician. If the average of the re-test results is within Limits of Precision (+/- 2.0 %) then the re-test results will replace the original test results. If the re-test indicates the Limits of Precision are not within tolerance, contact the GeoMaterials Laboratory to request a Detailed Investigation.

If a Detailed Investigation is requested, a 3 member committee will review the issue and determine if the Contractor will be required to switch to the core method of density acceptance until the issue is resolved. The Resident Engineer, Pavement Specialist, QA Supervisor, Asphalt Design Engineer, Pavement Construction Engineer, and State Materials Engineer will be notified by the Construction Unit that the Contractor must switch to the core method.

If the potential for a pavement failure is present, the Engineer may suspend production as stated in Article 108-7 of the *Standard Specifications* while the investigation is in progress. If additional tests are necessary to resolve the difference, these tests will be performed jointly by the Contractor's quality control and the Department's quality assurance personnel. If the reason for the difference cannot be determined, payment for the mix in question will be determined in accordance with Article 105-3 of the *Standard Specifications*. If the reason for the difference is determined to be an error or other discrepancy in the quality control test results, the applicable quality assurance test results will be used to determine compliance with the specification density requirements.

Acceptance of Density

The Department will evaluate the asphalt pavement for density compliance after the asphalt mix has been placed and compacted using the Contractor's quality control test results, the Department's quality assurance test results, including verification samples, and by observation of the Contractor's density quality control process conducted in accordance with Section 609. Unless specified otherwise in the contract, the minimum density requirements for all mixes will be as specified in Article 610-10, Table 610-6 of the *Standard Specifications*. Density acceptance will be as provided herein. Core sample densities will be determined by use of the average maximum specific gravity (G_{mm}), until a moving average of the last four maximum specific gravities is attained. Once a moving average of the last four maximum specific gravities is established, the last G_{mm} moving average in effect at the end of the same day's production will then be used to determine density acceptance.

The pavement will be accepted for density on a lot by lot basis. A lot will consist of one day's production of a given job mix formula on a contact. As an exception, separate lots will be established when one of the following occurs:

1. Portions of JMF placed on a given day in both "New" and "Other" construction categories as defined below. A lot will be established for the portion of the pavement in the "New" construction category and a separate lot for the portion of pavement in the "Other" construction category.
2. Pavement is being placed on multiple resurfacing maps, unless otherwise approved prior to paving. A lot will be established for each individual resurfacing map or portion thereof, unless otherwise approved.
3. Pavement is being placed simultaneously by multiple paving crews. A lot will be established for the pavement placed by each crew.
4. Portions of the JMF placed in different layers
5. Control Strip are placed during limited production

The Engineer will determine the final category and quantity of each lot for acceptance purposes.

The "New" construction category will be defined as pavements of uniform thickness, exclusive of irregular areas, meeting all three of the following criteria:

1. Pavement placed on a new aggregate or soil base compacted to the specified density or pavement placed on a new asphalt mix layer (excluding wedging and leveling);
2. Pavement which is within a designated travel lane of the final traffic pattern; and
3. Pavement which is 4.0 feet (1.2 meters) or wider.

As an exception, when the first layer of mix is a surface course and is being placed directly on an unprimed aggregate or soil base, the layer will be included in the "Other" construction category.

The "Other" construction category will include all pavement except as described above.

A failing lot for density acceptance purposes is defined as a lot which the average of all test sections fails to meet the minimum specification requirement. In addition, any lot or portion of a lot that is obviously unacceptable will be rejected for use in the work.

If the Engineer determines that a given lot of mix which falls in the "New" category does not meet the minimum specification requirements, but the work is reasonably acceptable, the lot will be

accepted at a reduced pay factor in accordance with the following formula. The reduced pay factor will apply only to the mix unit price.

$$PF = 100 + \frac{[(Actual\ Density - Specified\ Density) \times 30]}{2}$$

Where:

Actual Density = the lot average, not to exceed 2.0% of the specified density

Specified Density = the density in Table 610-6 or as specified in contract

Acceptance of all failing lots in the “Other” category will be made under the provisions of Article 105-3 of the *Standard Specifications*.

When the deficiency of the lot average density exceeds the minimum requirement, the Engineer will determine whether or not the mix is reasonably acceptable. If determined to be reasonably acceptable, the mix will be paid at an adjusted contract price in accordance with Article 105-3 of the *Standard Specifications*. If it is determined not acceptable, the mix will be removed and replaced with mix meeting the requirements of these specifications. Any reduction in pay due to failing density will be in addition to any reduction in pay due to failing mix property test results on the same mix.

Perform the production and construction of all asphalt mixtures and pavements in accordance with these provisions. There will be no direct payment for work covered by this provision. Payment at the contract unit prices for the various asphalt items will be full compensation for all work covered by this provision.

HMA/QMS Nuclear Density Assessment Program

Mission

To evaluate the competence of the personnel who are performing the Quality Control and Quality Assurance nuclear density testing on asphalt paving projects by observation and comparative sampling.

Scope

Assessment and comparative sampling/testing shall be performed on QC and QA personnel who are actively utilizing the nuclear gauge on asphalt pavements.

Observation

The Materials & Tests Technician is to observe and assess the QC/QA personnel perform the test procedure, evaluate the testing equipment and record their observations on an M&T 901 N form. All equipment utilized in the testing must be in good working order and the calibration should be current. If the Materials & Tests Technician observes the technician perform a testing procedure incorrectly the Materials & Tests Technician will note the incorrect procedure on the M&T 901N form. After the assessment is complete the Materials & Tests Technician shall review the assessment results with the technician. Any dispute will be investigated and resolved by the Field Engineer. Any procedural irregularity shall result in an unsatisfactory rating being assessed against the technician. It is the intent of the Program to assess the technicians who are routinely performing the density testing on any particular project. The Materials & Tests Technician shall review project records to determine which technicians routinely perform the tests, and arrange to perform an assessment.

Assessment

It is the intent of this program to validate the competency of the personnel performing quality control and quality assurance nuclear density testing of asphalt pavements. In order to determine this competency the following rating system will be used to grade QMS/HMA Nuclear Density technicians.

- A) **Satisfactory** – all test procedures performed correctly
- B) **Unsatisfactory** – technician did not perform all test procedures correctly.

All assessments shall be reviewed by the Materials & Tests Technician's immediate supervisor (SMS, AME, and FOE). The Field Services Engineer shall review the results of all unsatisfactory assessments and its re-assessment. If the review indicates that remedial training is required the Field Services Engineer shall contact a Technical Trainer. Any unsatisfactory assessments that requires more than remedial training, or if remedial training has not been effective, shall be brought to the attention of a Review Committee. The Review Committee will be comprised of the Field Operations Manager, Compliance & Assurance Engineer, and the Field Services Engineer. A re-assessment shall be performed on any technician that has an unsatisfactory assessment. It shall be the determination of the Field Services Engineer if the re-assessment process should include a new material correlation. A copy of the "QC/QA Nuclear Gauge Operator Assessment" form for all unsatisfactory assessments is to be sent to the Field Engineer and the Quality Systems Technician.

An unsatisfactory assessment followed by an unsatisfactory re-assessment shall result in temporary suspension of certification.

Equipment

The gauge shall be evaluated following the process stated on the appropriate M&T 901N (nuclear gauge) or M&T 901N-N (non-nuclear gauge) Forms. Failure to utilize a gauge properly during these processes shall result in an unsatisfactory rating.

Assessment Frequency

The Materials & Tests Technician shall assess each QC and QA technician actively performing nuclear density testing at a minimum of once per year. Active is defined as the technician having tested at least one nuclear density test section during the assessment cycle.

Suspension of Certification

If QC/QA personnel have one or more procedural irregularities during a certification period, their certification to perform nuclear density testing may be suspended. Any falsification of testing information shall result in revocation of certification. The QC/QA personnel may regain their certification by demonstrating to the Soils Engineer that they have the ability to perform the tests correctly. This shall be done by successfully completing the certification course offered by the Soils Engineer. However, if the certification was suspended due to falsification, or any other action that is deemed to be contrary to the proper spirit of this program, then the suspension will be permanent.

Refusal, intentional delaying of assessment, and/or re-assessment resulting in an assessment not being able to be performed will lead to suspension of certification.

Correlation

Once the Materials & Tests Technician has observed the testing/sampling procedure, they will take a comparative core sample from the test site. This sample shall be sent to either the Central Asphalt Laboratory or to an appropriate M&T Regional Laboratory. The sample information will be entered into HiCAMS by the Materials & Tests Technician. Upon completion of the test the Materials & Tests Technician will correlate the results using the values listed in Table 1 Confidence Limits Asphalt (Nuclear vs. Core). If the results correlate Excellent or Good, the Materials & Tests Technician will immediately verify the correlation. If the results correlate Fair or Poor, the Materials & Tests Technician will conduct an investigation as to the cause of the disparity. If they cannot determine the cause then the Compliance and Assurance Engineer and the Field Engineer will conduct further investigation as to the cause of the disparity. Other personnel may be asked to participate depending on the scope of the investigation.

A copy of the "QC/QA Nuclear Gauge Operator Assessment" form for all unsatisfactory assessments is to be sent to the Field Engineer and the Quality Systems Technician.

Resolution of testing/sampling disparities

Disparity is the difference between the results of the IA core sample and the project results. If the disparity is outside the correlation limits an investigation is required. If the investigation shows that the disparity was a result of procedural irregularities then the policy governing procedural irregularities shall be followed. However, it is understood that, in some cases, there is no apparent reason why a disparity occurred. Those cases shall not be considered as grounds for possible suspension of certification.

Training

Each Materials & Tests Technician shall be required to complete a HMA Density assessment-training program given by the NCDOT Field Operations Group. The program shall consist of a classroom portion and a field portion. Each portion shall be graded separately. The Materials & Tests Technician must obtain a passing grade in each portion before they can be certified to perform QC/QA HMA Asphalt density assessments.

The Materials & Tests Technician does not train the project personnel, nor do they have any role in the certification process.

Materials & Tests Technicians are to renew their HMA Density assessment certification every year.

Asphalt (Nuclear vs. Core)

Properties	Sign	Excellent	Good	Fair	Poor
		Maximum Limit	Maximum Limit	Maximum Limit	Maximum Limit
% Compaction	+/-	2.0	2.5	3.0	>3.0

Table 1 - Confidence Limits

Appendix I

Best Practice Procedures when taking a Standard Count

When using a nuclear density gauge a 4-minute Standard Count must be taken daily to compensate for source decay and natural background radiation. Source decay is due to the constant decay in radioactive material and is commonly referred as the “half-life”. The half-life is the period of time required for the radioactive material to decay to half the original quantity. For example, most nuclear gauges use Cesium 137 (Cs-137) which has a half-life of approximately 30 years. Therefore, if a nuclear gauge is manufactured with 8 milliCuries of Cs-137 only 4 milliCuries of the material will remain after the first 30 year half-life.

Standard Counts affect accuracy of density gauge measurements therefore, following proper procedures will help to ensure the highest degree of accuracy possible

Standard Count Setup Procedures

1. Prior to taking a Standard Count allow the gauge to “warm-up” for at least 10 minutes
Reason: The electronics within a nuclear gauge need time to stabilize to ensure accurate measurements.
2. When testing with a 4640-B Nuclear Gauge always take a Standard Count using the Reference Standard Count Block and Air Spacer Gap.
3. Take Standard Counts with a 4640-B Nuclear Gauge set in the *Multi-Standard Mode*
Reason: In *Multi-Standard Mode* the gauge will compare the new Standard Count with the average of the last four Standard Counts for System 1 and System 2 (stored in gauge memory). To pass, the new Standard Count must be within 1.0 % of the average for System 1 and within 1.2 % of the average for System 2.
4. When testing with a 3450 Nuclear Gauge always take a Standard Count using the Reference Standard Count Block
5. Choose a proper Standard Count Site using the following criteria
 - a. Located at the project site on the material being tested
 - b. Site should be dry and flat
 - c. Ensure bottom of the gauge is clean
 - d. Ensure the top and bottom of the reference block is clean
 - e. Site must be at least 10 feet from any large vertical surfaces (i.e. barrier walls, vehicles, construction equipment, bridge structures, etc.)
 - f. Site must be at least 33 feet from any other radioactive sources (i.e. other nuclear gauges, high voltage power-lines, etc.).
 - g. Site must be at least 4 inches thick of compacted asphalt, soil and/or concrete
6. Place the Reference Standard Count Block on the site
7. Verify the site is level by tapping the corners of the Block (if it rocks move to another site)
8. If using a 4640-B Nuclear Gauge place the Air Spacer Gap in the middle of the Standard Reference Block and orient the Air Spacer so that when the nuclear gauge is placed on the Air Spacer, the keypad can be read while the gauge operator is facing the handle on the Block (Refer to Figure 1).
9. If using a 3450 Nuclear Gauge place the gauge on the Block and ensure the keypad side of the gauge is against the Metal Butt Plate located on the end of the Block (Refer to Figure 2).
10. Verify source rod is in the safe position. Lightly push down on the source rod handle to ensure it is in the safe position.

Reason: As nuclear gauges are used the rubber O-ring gasket at the top of the guide rod can become worn which will allow for the source rod to be positioned (or pulled) slightly above the Safe Position. This generally occurs as the device is being carried by the handle. Though this change in position is very little, the Standard Count will be affected.

11. If using a 4640-B press “STD” on the keypad and follow directions displayed on the LCD
12. If using a 3450 press “Standard” on the keypad and follow directions displayed on the LCD
13. While performing a 4-minute Standard Count step away from the nuclear gauge about 4 feet.

Reason: To follow ALARA safety procedures and prevent any possible influence to the device while performing a Standard Count

14. If using a 3450 the depth strip must be calibrated immediately following the Standard Count. To properly perform this function follow steps displayed on the LCD.

Reason: If the depth strip is not properly calibrated all measurements will be affected

Analysis of Standard Count Results

1. If the gauge indicates the Standard Count passes record results and, if placing a Control Strip, calculate the “Allowable Standard Count Range”.
2. If a Control Strip is not being placed, verify the Standard Count results do not exceed the “Allowable Standard Count Range”.

Standard Count Fails Gauge Tolerance

1. If the Standard Count fails (gauge tolerance) the following steps should be followed:
 - a. Verify that all proper Standard Count Setup Procedures were followed
 - b. If proper procedures were not followed do not accept new Standard Count
Reason – The accuracy of the new Standard Count is questionable
 - c. Correct issue and repeat Standard Count following proper procedures
2. If proper Standard Count Procedures were followed then:
 - a. If less than a month has passed since the last Standard Count or the failure is greater than 5 % do not accept the new Standard Count
 - b. Take another Standard Count
 - c. If the second Standard Count fails, contact a Technical Trainer or gauge manufacturer
 - d. Erase Standard Counts (in gauge memory) if more than a month has passed since the last Standard Count was performed and the failure is less than 5 %
 - e. Take 4 new Standard Counts (following proper procedures)
 - f. If the fourth Standard Count passes, record results and, if placing a Control Strip, calculate the Allowable Standard Count Range
 - g. If the fourth Standard Count fails contact a Technical Trainer or the gauge manufacturer

Allowable Standard Count Range Exceeded

1. If the Standard Count exceeds the Allowable Standard Count Range
 - a. Do not accept the new Standard Count
Reason: New Standard Count will replace a previous Standard Count which will “push” the average farther from when the Control Strip was placed
 - b. Verify that all proper Standard Count Setup Procedures were followed

- c. If proper procedures were not followed correct issue and repeat Standard Count
2. If the procedures were followed or the second attempt does not fall within the Range
 - a. Do not accept the Standard Count
 - b. Move down the mat 100 to 150 feet
 - c. Take another Standard Count
 - d. If the Standard Count fails any of the tolerances contact a Technical Trainer or the gauge manufacturer

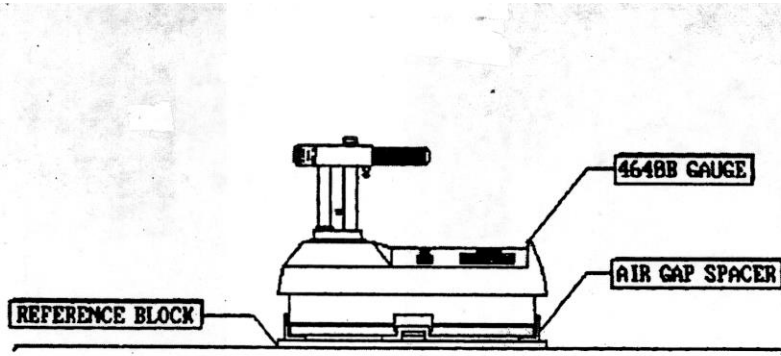

Figure 1 - 4640-B Standard Count

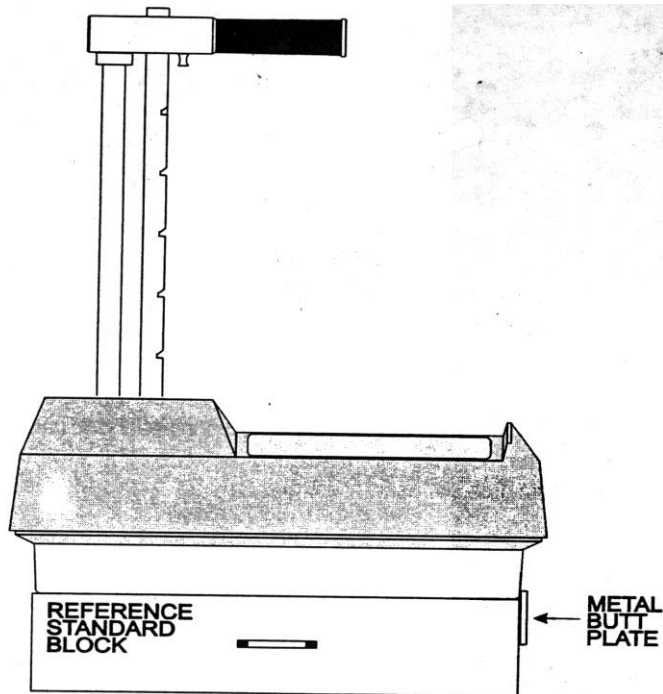

Figure 2 - 3450 Standard Count

Appendix II

Record and Report Forms

A typical set of forms utilized in Nuclear Testing is included in the following pages. The Contractor's QC forms with required supporting documents shall be retained by the Contractor for at least three (3) years after completion of the forms. The Department's QA forms shall be stored indefinitely by the QA Labs unless permission is given otherwise.

**NORTH CAROLINA DEPARTMENT OF TRANSPORTATION
DIVISION OF HIGHWAYS
CONTROL STRIP DENSITY**

M&T – 514QA/QC
Rev. 02/11

Date: [1]

Contract/Project No. [2] County [3] Control Strip No. [4]

From Sta. [5] to Sta. [6] Lane [7]

Layer [8] Depth [9] Width [10] Route [11] Job Mix Formula [12]

Gauge Serial No. [13] Material [14] Crew No. [15]

<u>STANDARD COUNTS</u>				<u>ASPHALT CORE SAMPLES</u>		
Density				<u>Core No.</u>	<u>Sta.</u>	<u>%Compaction</u>
<u> [16] </u> System 1				<u> </u>	<u> </u>	<u> </u> %
<u> </u> System 2				<u> </u>	<u> </u>	<u> </u> %
<u> [17] </u>	Allowable Standard Count Range		<u> [17] </u>	<u> </u>	<u> </u>	<u> </u> %
<u> </u>	+1.0%	System 1	- 1.0%	<u> </u>	<u> </u>	<u> </u> %
<u> </u>	+1.2%	System 2	- 1.2%	<u> </u>	<u> </u>	<u> </u> %
				Avg. % Compaction <u> </u> % (A)		

Test	<u>Station</u>	<u>ASPHALT (Wet Density)</u>
1	<u> [19] </u>	<u> [20] </u>
2	<u> </u>	<u> </u>
3	<u> </u>	<u> </u>
4	<u> </u>	<u> </u>
5	<u> </u>	<u> </u>
6	<u> </u>	<u> </u>
7	<u> </u>	<u> </u>
8	<u> </u>	<u> </u>
9	<u> </u>	<u> </u>
10	<u> </u>	<u> </u>
AVG. (PCF)		<u> [21] </u> (B)

ASPHALT TARGET DENSITY
Average of Control Strip (PCF) + Average of Cores (B+A) 100 = [22] (C) Target Density (PCF)
A = Core Sample Average B = Average PCF of Control Strip C = Correlated Target Density

cc: *Resident Engineer {White} *QA Copy Only
QA/QC Technician {Gold}

Print Name Legibly w/ HiCAMS #: [23]

QA/QC Technician Signature: [24]

NOTE: By providing this data under my signature and/or HiCAMS certification number, I attest to the accuracy and validity of the data contained on this form and certify that no deliberate misrepresentation of test results, in any manner, has occurred.

Instructions for M&T 514 QA/QC

GENERAL NOTE: This form to be completed by both the QA and QC Nuclear Density Technicians when a control strip is tested to determine a correlated target density. (Refer to nuclear gauge operator's manual for control strip frequencies.) The Contractor's gauge operator will always correlate his/her gauge to the control strip core samples. The Department's gauge operator will correlate his/her gauge to the control strip samples at the same time as the Contractor's gauge operator, if possible. The Contractor must notify the Department's Roadway Technician far enough in advance of placing a control strip so the Department can provide a gauge operator at that time. Distribution of this form should be as follows: The QC Density Technician will maintain the gold copy. The QC Technician will provide the other copy to the Department's Roadway Technician at the end of each day's operation when a control strip is placed. These will be attached to the daily roadway report (M&T 605) and forwarded to the Resident Engineer. The white copy will remain on file at the Resident Engineer's office. When this form is completed by the Department's QA gauge operator, he/she will keep the gold copy. The QA Technician will give the other copy to the NCDOT Roadway Technician and distribution will be the same as above for the QC copies.

1. Date mix was placed, compacted and tested
2. Contract number or Project Number that mix is being placed on (Not individual work order numbers)
3. County in which Contract is located
4. Sequential control strip number for each type mix being placed (Refer to Nuclear Gauge Operators Manual for procedures for numbering control strips)
5. Beginning reference station number of the control strip
6. Ending reference station number of the control strip, not to exceed 300 L.F. from beginning of control strip
7. Lane on which control strip is placed (i.e. NBL - Lt. Ln., WBL - Rt. Ln.)
8. Layer of type mix being placed (i.e. B25.0C 1st layer, S9.5B 2nd layer, etc.)
9. Thickness of layer being placed (i.e. 1 ½", 1", 3 ½", etc.)
10. Width of layer being placed (i.e. 10', 12', 24', etc.)
11. Road number or Route number (i.e. US-1 North, SR-1559, I-40, etc.)
12. Job Mix Number of mix type being placed
13. Nuclear Gauge Serial Number (usually etched into handle of Nuclear Gauge)
14. Type Material being tested (See JMF i.e. B25.0C, S9.5B, etc.)
15. Crew number (once established remains the same for entire project)
16. Actual number from gauge when taking standard counts witnessed by the Department
17. Calculated Allowable Standard count range for subsequent days. This range is determined by adding $\pm 1\%$ from the standard count.
18. QC or QA Core sample number, station number, and % compaction of core samples in the control strip. This information is transferred from the QC-5 form
19. Actual station number control strip core samples were placed
20. Nuclear gauge readings in pounds per cubic foot. Two (2) gauge readings must be taken on each core sample location in the control strip. Five (5) non-nuclear gauge readings must be taken on each core sample location in the control strip (only the average of the five readings will be recorded on the form for each core location).
21. Average pounds per cubic foot of the ten (10) nuclear gauge readings or 25 non-nuclear gauge readings at core sample locations
22. Correlated target density to be entered in gauge for determining density of a sections (Avg. PCF divided by core sample average x 100)
23. QA or QC Technician's printed name and HiCAMS nuclear gauge operators certification no., depending on who completes form
24. QA or QC Technician's signature certifying that data entered on this form is true and correct.

**North Carolina Department of Transportation
Division of Highways
Density Gauge Test Section**

M&T - 516 QC
Rev. 11/11

Contract/Project No. [1] Date [2] Division [3] Crew No. [4] Control Strip No. [5]
 Map/Route No. [6] Contractor [7] J.M.F. [8] Type Material [9]
 Layer [10] Gauge Serial No. [11] Standard Counts (nuclear gauge only) Sys1 [12] Sys2 [13]
 Core Sample Avg. [14] % Avg. of gauge readings [15] PCF Correlated Target Density [16] PCF
 Interim Density Calculated Target: 62.4 PCF x [17] = [18] Calculated Target PCF
 Gmm

Test Sect. No. [19]		Begin Sta. [20]		End Sta. [21]		Length: [22] /5 = [23] Increments				
Random No.		Increments		Random (calc.)		Test Site Location			Density Readings	
Length	Width	Length	Width	Length	Width	Station	Offset	Lane	PCF	%
A	B	C	D	A x C =	B x D =	-----	-----	-----	-----	-----
[24]	[25]	[26]	[27]	[28]	[29]	[30]	[31]	[32]	[33]	[34]
↓	↓	↓	↓	↓	↓	↓	↓	↓	↓	↓
↓	↓	↓	↓	↓	↓	↓	↓	↓	↓	↓
Comments: [35]								Test Section Average	[36]	
									Pass	Fail

Test Sect. No.		Begin Sta.		End Sta.		Length: /5 = Increments				
Random No.		Increments		Random (calc.)		Test Site Location			Density Readings	
Length	Width	Length	Width	Length	Width	Station	Offset	Lane	PCF	%
A	B	C	D	A x C =	B x D =	-----	-----	-----	-----	-----
Comments:								Test Section Average		
									Pass	Fail

Test Sect. No.		Begin Sta.		End Sta.		Length: /5 = Increments				
Random No.		Increments		Random (calc.)		Test Site Location			Density Readings	
Length	Width	Length	Width	Length	Width	Station	Offset	Lane	PCF	%
A	B	C	D	A x C =	B x D =	-----	-----	-----	-----	-----
Comments:								Test Section Average		
									Pass	Fail

At end of production for the day, calculate lot average by averaging test section results: Daily Lot Average [37] % Pass / Fail

*Print Name Legibly w/HiCAMs No. [38]

*QC Technician Signature: [39]

Note: (1) All failing lots must be documented by Resident Engineer on the QA-2B form. Contractor must be notified by letter of any pay adjustment or pavement removal.

*By providing this data under my signature and/or HiCAMs certification number, I attest to the accuracy and validity of the data contained on this form and certify that no deliberate misrepresentation of test results, in any manner, has occurred.

cc: Resident Engineer [White]
QC Technician [Gold]

Instructions for M&T 516 QC

GENERAL NOTE: This form is to be completed daily by the Contractor's Density Control Technician when nuclear or non-nuclear density control is being utilized to perform quality control testing of the compaction process. This form is to be distributed as follows: The gold copy is maintained by the QC Density Technician. The white copy is given to the Department's Roadway Technician and attached to his/her daily roadway report (M&T 605) and forwarded to the Resident Engineer. The Resident Engineer will keep the white copy in the project files.

1. NCDOT contract number (list primary number if contract has multiple contract numbers)
2. Date asphalt layer is actually placed, compacted and tested
3. Division in which contact is located
4. Crew Number (once established remains the same for the entire project)
5. Sequential number of control strip per mix type
6. Work order map number within a contract
7. Name of Contractor placing and compacting the mix
8. Job Mix Formula of the material being tested
9. Type of mix being tested (i.e. RS-12.5 C or I-19.0 B, etc.)
10. Layer of mix being placed (i.e. 1st layer S-9.5 B, 2nd layer S-9.5 B, etc.)
11. Gauge serial number
12. Standard Count result of System 1 (must be within Allowable Range)
13. Standard Count result of System 2 (must be within Allowable Range)
14. Average percent compaction of control strip core samples from M&T 514 QA/QC form
15. Average of density readings (in pcf) taken at each core site within the control strip
16. Correlated Target Density determined from the control strip (formula provided on form M&T 514 QA/QC)
17. G_{mm} (rice specific gravity) determined at mix verification or G_{mm} moving average if mix has been previously produced or a 17 day lapse in production of this mix has occurred
18. Calculated target density in pcf.
19. Consecutive number of test sections for each type mix per paving operation
20. Reference station number for beginning of each test section
21. Reference station number for ending of each test section
22. Length of test section
23. Increment length of each test site (i.e. 400' or 300' etc.)
24. Random number from the random number table used to determine station of test site
25. Random number from the random number table used to determine offset width location of test site
26. Increment length of each test site (from #23)
27. Width of pavement layer being placed and compacted
28. Calculate length to test location within incremented section ($A \times C =$)
29. Calculate offset width to test location within incremented section ($B \times D =$)
30. Station of test site (measurement taken with gauge)
31. Offset width pulled from reference line to test site
32. Lane being tested (i.e. NBL Rt, WBL Lt, or SBL Lt, etc.)
33. Density reading in pounds per cubic foot (pcf)
34. Percent compaction of target density for test site
35. Record any pertinent information (i.e. re-rolled section at second reading)
36. Average percent compaction of test section

37. Average percent compaction of each lot tested (only one lot per M&T 516 QC form – see HMA/QMS manual for lot determination)
38. QC Technician printed name and HiCAMs number
39. Signature of QC Technician certifying data listed on the form is true and correct.

**North Carolina Department of Transportation
Division of Highways
Density Gauge Test Section**

M&T - 515 QA
Rev. 11/11

Contract/Project No. [1] Date [2] Division [3] Crew No. [4] Control Strip No. [5]
 Map/Route No. [6] Contractor [7] J.M.F. [8] Type Material [9]
 Layer [10] Gauge Serial No. [11] Standard Counts (nuclear gauge only) Sys1 [12] Sys2 [13]
 Core Sample Avg. [14] % Avg. of gauge readings [15] PCF Correlated Target Density [16] PCF
 Interim Density Calculated Target: 62.4 PCF x [17] = [18] Calculated Target PCF

Test Sect. No. [19]		Begin Sta. [20]		End Sta. [21]		Length: [22] /5 = [23]			Increments		
Random No.		Increments		Random (calc.)		Test Site Location			Density Readings		
Length	Width	Length	Width	Length	Width	Station	Offset	Lane	PCF	%	
A	B	C	D	A x C =	B x D =						
[24]	[25]	[26]	[27]	[28]	[29]	[30]	[31]	[32]	[33]	[34]	
Comments: [35]								Test Section Average (%)	[36]	Pass	Fail
								QC Test Average (%)	[37]	Within Limits of Precision	
										Yes	No

Test Sect. No.		Begin Sta.		End Sta.		Length: /5 =			Increments		
Random No.		Increments		Random (calc.)		Test Site Location			Density Readings		
Length	Width	Length	Width	Length	Width	Station	Offset	Lane	PCF	%	
A	B	C	D	A x C =	B x D =						
Comments:								Test Section Average (%)		Pass	Fail
								QC Test Average (%)		Within Limits of Precision	
										Yes	No

*Print Name Legibly w/HiCAMs No. [38]

*QA Technician Signature: [39]

cc: Resident Engineer [White]
QA Technician [Gold]

*By providing this data under my signature and/or HiCAMs certification number, I attest to the accuracy and validity of the data contained on this form and certify that no deliberate misrepresentation of test results, in any manner, has occurred.

Instructions for M&T 515 QA

GENERAL NOTE: This form is to be completed by the Department's QA Nuclear Gauge Operator when performing re-test and verification tests of a QC technician's test section. Only the density results of one mix type, one project number, and one control strip is to be used on this form. Distribution will be as follows: QA Technician will maintain the gold copy and furnish the white copy to the NCDOT Roadway Technician to be attached to Form M & T 605 and forwarded to the Resident Engineer. The Resident Engineer will keep the white copy in the project file.

1. NCDOT contract number (list primary number if contract has multiple contract numbers)
2. Date asphalt layer is actually placed, compacted and tested
3. Division in which contact is located
4. Crew Number (once established remains the same for the entire project)
5. Sequential number of control strip per mix type
6. Work order map number within a contract
7. Name of Contractor placing and compacting the mix
8. Job Mix Formula of the material being tested
9. Type of mix being tested (i.e. RS-12.5 C or I-19.0 B, etc.)
10. Layer of mix being placed (i.e. 1st layer S-9.5 B, 2nd layer S-9.5 B, etc.)
11. Gauge serial number
12. Standard Count result of System 1 (must be within Allowable Range)
13. Standard Count result of System 2 (must be within Allowable Range)
14. Average percent compaction of control strip core samples from M&T 514 QA/QC form
15. Average of density readings (in pcf) taken at each core site within the control strip
16. Correlated Target Density determined from the control strip (formula provided on form M&T 514 QA/QC)
17. G_{mm} (rice specific gravity) determined at mix verification or G_{mm} moving average if mix has been previously produced or a 17 day lapse in production of this mix has occurred
18. Calculated target density in p.c.f.
19. This number will be the same base number as the QC test section number but will have a suffix of either "QA" for re-test or "V" for verification tests. For example: if the Contractor's test section number is 24QC, a QA re-test would be numbered 24QA and/or a QA verification test would be 24V
20. Reference station number for beginning of each test section
21. Reference station number for ending of each test section
22. Length of test section
23. Increment length of each test site (i.e. 400' or 300' etc)
24. Random number from the random number table used to determine station of test site (if re-testing QC site record station (#30) and offset (#31) from QC Technician)
25. Random number from the random number table used to determine offset width location of test site (if re-testing QC site record station (#30) and offset (#31) from QC Technician)
26. Increment length of each test site (from #23)
27. Width of pavement layer being placed and compacted
28. Calculate length to test location within incremented section ($A \times C =$) (if re-testing QC site record station (#30) and offset (#31) from QC Technician)
29. Calculate offset width to test location within incremented section ($B \times D =$) (if re-testing QC site record station (#30) and offset (#31) from QC Technician)
30. Station of test site (measurement taken with gauge)

31. Offset width pulled from reference line to test site
32. Lane being tested (i.e. NBL Rt, WBL Lt, or SBL Lt, etc)
33. Density reading in pounds per cubic foot (p.c.f.)
34. Percent compaction of target density for test site
35. Record any pertinent information (i.e. re-rolled section at second reading)
36. Average percent compaction of test section
37. Record average percent compaction of QC test section results and determine if result are within Limits of Precision
38. QA Technician printed name and HiCAMs number
39. Signature of QA Technician certifying data listed on the form is true and correct.

**NORTH CAROLINA DEPARTMENT OF TRANSPORTATION
DIVISION OF HIGHWAYS
CONTROL STRIP DENSITY**

M&T – 514QA/QC
Rev. 02/11

Date: _____

Contract/Project No. _____ County _____ Control Strip No. _____

From Sta. _____ to Sta. _____ Lane _____

Layer _____ Depth _____ Width _____ Route _____ Job Mix Formula _____

Gauge Serial No. _____ Material _____ Crew No. _____

<u>STANDARD COUNTS</u>	<u>ASPHALT CORE SAMPLES</u>
Density	<u>Core No.</u> <u>Sta.</u> <u>%Compaction</u>
_____ System 1	_____ _____ _____ %
_____ System 2	_____ _____ _____ %
Allowable Standard Count Range	_____ _____ _____ %
+1.0% System 1 -1.0% _____	_____ _____ _____ %
_____	_____ _____ _____ %
+1.2% System 2 -1.2% _____	_____ _____ _____ %
_____	Avg. % Compaction _____ % (A)

Test	<u>Station</u>	<u>ASPHALT (Wet Density)</u>
1	_____	_____
2	_____	_____
3	_____	_____
4	_____	_____
5	_____	_____
6	_____	_____
7	_____	_____
8	_____	_____
9	_____	_____
10	_____	_____

AVG. (PCF) _____ (B)

ASPHALT TARGET DENSITY

Average of Control Strip (PCF) ÷ Average of Cores (B÷A) 100 = _____ (C) Target Density (PCF)

A = Core Sample Average B = Average PCF of Control Strip C = Correlated Target Density

cc: *Resident Engineer [White] *QA Copy Only
QA/QC Technician [Gold]

Print Name Legibly w/ HiCAMS #: _____

QA/QC Technician Signature: _____

NOTE: By providing this data under my signature and/or HiCAMS certification number, I attest to the accuracy and validity of the data contained on this form and certify that no deliberate misrepresentation of test results, in any manner, has occurred.

**North Carolina Department of Transportation
Division of Highways
Density Gauge Test Section**

M&T - 516 QC
Rev. 11/11

Contract/Project No. _____ Date _____ Division _____ Crew No. _____ Control Strip No. _____

Map/Route No. _____ Contractor _____ J.M.F. _____ - _____ - _____ Type Material _____

Layer _____ Gauge Serial No. _____ Standard Counts (nuclear gauge only) Sys1 _____ Sys2 _____

Core Sample Avg. _____ % Avg. of gauge readings _____ PCF Correlated Target Density _____ PCF

Interim Density Calculated Target: 62.4 PCF x _____ Gmm = _____ Calculated Target PCF

Test Sect. No.		Begin Sta.		End Sta.		Length: _____ /5 = _____			Increments	
Random No.		Increments		Random (calc.)		Test Site Location			Density Readings	
Length	Width	Length	Width	Length	Width	Station	Offset	Lane	PCF	%
A	B	C	D	A x C =	B x D =	-----	-----	-----	-----	-----
Comments:								Test Section Average		
									Pass	Fail

Test Sect. No.		Begin Sta.		End Sta.		Length: _____ /5 = _____			Increments	
Random No.		Increments		Random (calc.)		Test Site Location			Density Readings	
Length	Width	Length	Width	Length	Width	Station	Offset	Lane	PCF	%
A	B	C	D	A x C =	B x D =	-----	-----	-----	-----	-----
Comments:								Test Section Average		
									Pass	Fail

Test Sect. No.		Begin Sta.		End Sta.		Length: _____ /5 = _____			Increments	
Random No.		Increments		Random (calc.)		Test Site Location			Density Readings	
Length	Width	Length	Width	Length	Width	Station	Offset	Lane	PCF	%
A	B	C	D	A x C =	B x D =	-----	-----	-----	-----	-----
Comments:								Test Section Average		
									Pass	Fail

At end of production for the day, calculate lot average by averaging test section results: Daily Lot Average _____ % Pass / Fail

*Print Name Legibly w/HiCAMs No. _____

*QC Technician Signature: _____

Note: (1) All failing lots must be documented by Resident Engineer on the QA-2B form. Contractor must be notified by letter of any pay adjustment or pavement removal.

*By providing this data under my signature and/or HiCAMs certification number, I attest to the accuracy and validity of the data contained on this form and certify that no deliberate misrepresentation of test results, in any manner, has occurred.

cc: Resident Engineer [White]
QC Technician [Gold]

**North Carolina Department of Transportation
Division of Highways
Density Gauge Test Section**

M&T - 515 QA
Rev. 11/11

Contract/Project No. _____ Date _____ Division _____ Crew No. _____ Control Strip No. _____

Map/Route No. _____ Contractor _____ J.M.F. _____ - _____ - _____ Type Material _____

Layer _____ Gauge Serial No. _____ Standard Counts (nuclear gauge only) Sys1 _____ Sys2 _____

Core Sample Avg. _____ % Avg. of gauge readings _____ PCF Correlated Target Density _____ PCF

Interim Density Calculated Target: 62.4 PCF x _____ = _____ Gmm Calculated Target PCF

Test Sect. No.		Begin Sta.		End Sta.		Length: /5 =			Increments	
Random No.		Increments		Random (calc.)		Test Site Location			Density Readings	
Length	Width	Length	Width	Length	Width	Station	Offset	Lane	PCF	%
A	B	C	D	A x C =	B x D =	-----	-----	-----	-----	-----
Comments:								Test Section Average (%)		
									Pass	Fail
								QC Test Average (%)	Within Limits of Precision	
									Yes	No

Test Sect. No.		Begin Sta.		End Sta.		Length: /5 =			Increments	
Random No.		Increments		Random (calc.)		Test Site Location			Density Readings	
Length	Width	Length	Width	Length	Width	Station	Offset	Lane	PCF	%
A	B	C	D	A x C =	B x D =	-----	-----	-----	-----	-----
Comments:								Test Section Average (%)		
									Pass	Fail
								QC Test Average (%)	Within Limits of Precision	
									Yes	No

*Print Name Legibly w/HiCAMs No. _____

*QA Technician Signature: _____

cc: Resident Engineer [White]
QA Technician [Gold]

*By providing this data under my signature and/or HiCAMs certification number, I attest to the accuracy and validity of the data contained on this form and certify that no deliberate misrepresentation of test results, in any manner, has occurred.

Appendix III

Random Sampling

In random sampling, a table of random numbers is used to locate test sites randomly to avoid biased testing. Once a number has been used it is marked through and not used again. For testing asphalt, a calculator that has a random number generator may not be utilized for generating random numbers. Random sampling is done in two dimensions by locating a station (length) and a pull distance from edge of base course (width). Refer to the following example. Use form M&T 517 QC/QA for determining random test sites

1. In the following example, the roadway is 12 feet wide; therefore, the test section is 2,000 feet in length.
2. Divide the test section into five equal sections and record the beginning station of each section on scratch paper. Assume the test section begins at station 0+00 and ends at station 20+00.

The data recorded on form M&T 517QC/QA as follows:

$$2,000 / 5 = 400 \text{ foot sections}$$

Beginning station - 0+00
 4+00
 8+00
 12+00
 16+00
 Ending station - 20+00

NOTE: The greater than symbols will point to the randomly located test sites.

3. Determine the random sample multipliers by referring to the random sample number table. In the example shown below, refer to random sample number table. Looking at the first column of four digits, use the first two digits, which are 81. Place a decimal in front of these two digits (0.81). Go down the column and the next four multipliers are 0.41, 0.74, 0.91, and 0.16.

4. Multiply each random sample multiplier by the length of the five equal sections determined in #2 above. The increment length is 400 feet.

Test section increment:	400	400	400	400	400
Random number:	<u>x 0.81</u>	<u>x 0.41</u>	<u>x 0.74</u>	<u>x 0.91</u>	<u>x 0.16</u>
Distance:	324	164	296	364	64

5. Add the distance determined in #4 to the beginning stations of the sections determined in #2 to locate the stations where the readings will be taken.

Beginning station:	0+00	4+00	8+00	12+00	16+00
Distance:	<u>3+24</u>	<u>1+64</u>	<u>2+96</u>	<u>3+64</u>	<u>0+64</u>
Random test site:	3+24	5+64	10+96	15+64	16+64

Appendix IV

Random Numbers

ASTM D-3665

	0	1	2	3	4	5	6	7	8	9
1	8121	3695	7367	7390	8568	9550	3107	3589	8240	3059
2	4185	5885	0699	3204	5610	3896	1692	2695	3354	9693
3	7423	7796	3747	8271	6052	8188	7913	4975	2525	3610
4	9153	3997	4351	5758	1611	0736	9949	9995	0791	5927
5	1617	6057	8761	8397	9092	0148	6552	7139	1588	0437
6	8760	3170	1224	4708	0815	7609	6584	4617	7047	6426
7	3588	2066	9567	9292	0174	4935	8792	5666	4876	7563
8	8103	5156	3440	4230	5757	5140	6858	5421	1223	8256
9	8871	2553	7202	1987	6385	6288	0497	0593	6161	1683
10	2558	2199	3805	9831	2606	0624	2742	6778	8157	3922
11	1647	1685	0752	8003	8052	2455	7920	1365	4418	6671
12	3135	8556	7712	6194	0847	4364	8858	2267	9994	4963
13	1724	3556	1740	5269	4034	9277	5271	2460	6228	9373
14	2328	3165	8382	7037	2065	4960	8404	6799	5599	9198
15	1350	8343	8993	2840	3880	6539	5501	9722	8424	2622
16	7427	7379	3549	1647	4225	0282	9025	2254	3500	7996
17	7022	0294	6714	9525	0941	3820	4074	8394	2468	9783
18	8582	9671	1036	5445	2233	6034	4240	2131	8345	7991
19	1345	4065	8880	5665	0032	7527	0726	8775	4522	2962
20	3849	0739	2216	6402	3115	4240	6081	2627	2578	9722
21	2250	7900	4486	2135	5081	2413	3685	5667	7988	4918
22	1078	4157	4885	8291	3507	0345	5105	9547	0599	5050
23	6836	1367	4019	5421	6796	1270	9592	0791	5013	5774
24	0978	2451	6865	3278	1912	7451	1343	8765	4038	9477
25	7835	8049	9898	8251	1842	7846	9007	9482	6945	6260
26	4356	9453	8545	5332	0915	6979	2074	2311	9361	8185
27	9158	3851	2403	5209	3580	1300	6650	3150	9335	5735
28	4316	7272	4590	6287	6553	9722	0058	0401	3953	8653
29	5549	7531	1942	3645	5393	0629	6401	3296	0927	2436
30	6446	5760	6850	8674	5189	9503	9662	6626	6170	8798
31	5533	5470	4593	4133	3524	9750	6566	4050	3014	9224
32	7379	0162	5237	1777	9430	2462	3288	5292	3377	8172
33	1664	5435	8368	3431	0291	8455	0159	9895	5849	5898
34	5630	6913	4948	7774	3575	0962	3186	9191	9381	0363
35	6847	7886	3963	8404	0751	0896	2633	9154	3847	5726
36	0950	4958	0297	1385	1083	8430	7831	4219	7010	1479
37	1363	4546	0731	3425	7256	0680	1903	7998	6275	1711
38	1184	2079	7299	9090	3535	3001	2088	1327	7482	8025
39	0736	5980	7034	6469	8688	6732	0461	5775	1210	7049
40	2673	8834	8132	0201	3634	0894	0819	6503	2522	6862
41	9059	7950	3589	1176	0131	8472	6691	6129	3032	5897
42	1605	7970	6152	4179	3269	1914	1468	9593	0850	2435
43	6865	3708	4096	0209	0469	7307	3216	3367	7560	9979
44	2379	2554	9753	2693	4604	8478	7480	7997	0441	8842
45	9821	7026	1331	3689	6738	8468	4876	5971	3939	2112
46	2140	9626	9884	3633	7163	5128	1821	9941	8127	5608
47	5432	6779	6373	6790	0845	7405	1457	6813	2481	6026
48	3460	8006	3670	6930	0523	5017	6487	1702	9237	1591
49	5265	7029	8790	6612	1052	8625	7070	3711	9177	8296
50	4271	3777	0048	6319	8807	0362	4318	9076	3108	2183

ASTM D-3665

	0	1	2	3	4	5	6	7	8	9
51	4724	4526	5407	2546	8332	4853	4422	1499	4129	5573
52	1277	8872	2569	9657	2544	8421	8617	8572	8662	1449
53	7992	6889	3350	1842	3408	8162	9357	5693	8528	4256
54	1908	4882	1892	0335	0131	9624	1024	5572	0089	4228
55	9525	7954	0657	9898	1340	9036	8409	3500	3784	6469
56	6089	6132	9614	6758	0288	0108	8623	8408	3360	3024
57	4909	2362	5297	3386	8329	8149	0845	6834	8831	4806
58	7386	1628	1494	8937	7838	8812	2994	6349	7933	8200
59	7320	7019	8328	7948	3274	5229	5753	0248	2559	0390
60	9763	0440	7154	0970	1852	3077	1522	3851	9877	6720
61	7820	1467	9175	7889	7498	3613	5527	7392	8590	1015
62	3167	2673	5391	5861	0901	4319	8630	9741	5844	7179
63	1701	9045	6529	3580	5265	5790	0414	1969	6780	7105
64	9024	2687	9310	8705	6172	4296	4610	4770	9415	5817
65	6613	4140	2942	2429	9435	8638	8063	1782	6352	7470
66	8449	3176	2217	2969	9996	0447	0516	7859	4525	9581
67	2557	8074	1255	0774	0337	0577	1722	9844	2828	1217
68	9599	1141	1301	9528	2589	1320	7096	1065	3956	6446
69	1992	3807	2096	2780	3358	2803	1457	3717	7601	3117
70	9415	4611	2177	6089	5341	5515	5414	6149	9383	6722
71	6277	6742	2609	2270	6942	1263	8254	1222	7007	7702
72	6330	0455	9317	8445	4361	5738	5322	4667	1433	1937
73	3087	5719	9831	9429	4720	7923	3490	3870	4504	4822
74	1623	3781	9202	2754	1574	3176	3289	3261	9601	8993
75	3456	3994	6498	8484	2594	2955	4836	9337	1417	6546
76	4065	3370	8734	2929	4353	0030	8154	6112	8268	3625
77	3117	5586	3840	7581	0440	7342	1148	2381	9102	6323
78	5770	4381	6456	4863	6505	2027	3656	4672	4027	5691
79	3540	0884	0684	7373	7772	2173	5824	6140	5151	2873
80	1383	6130	0608	0641	1401	3446	0809	6275	4667	6200
81	1694	1598	9773	1641	7271	9571	0956	3317	0638	1462
82	2261	1353	1201	0736	8451	0263	0675	6441	5095	5745
83	0879	8102	3441	9589	6066	6034	2895	0705	8152	1118
84	0267	1101	5030	2776	4676	9728	9698	0278	3653	5743
85	2050	0889	3674	9318	0837	2335	5784	4499	8971	3147
86	6512	9995	8944	5634	7796	4263	9758	6645	1275	1092
87	7778	2306	9643	1905	5315	3015	3158	7265	0190	2208
88	8201	5616	9194	1858	9491	0217	4368	7537	5073	4929
89	2415	0561	8289	2994	7341	4908	1498	8806	9611	5683
90	1938	6471	6108	5497	8081	5295	2897	5618	7229	3668
91	8780	5691	2190	8789	2697	8130	1357	4497	4674	6903
92	8632	5993	7960	0241	5771	9741	9251	3265	6100	6505
93	8636	2303	8091	0273	2265	1886	6465	5330	3707	6802
94	2814	8569	7178	0352	7279	8659	3164	3247	3857	9803
95	7407	7803	7879	1235	4695	8607	5468	3632	5282	4763
96	6352	6868	2150	6844	7191	4442	1561	8629	8724	7650
97	3135	5350	8557	9532	7192	5708	2930	8740	2747	5827
98	6418	0736	8251	5329	6641	8120	8985	3926	6810	0857
99	2070	3609	9184	7250	1270	8171	3581	7679	8326	3488
100	6862	4480	5051	5262	8832	6762	0369	2089	6209	1998

	0	1	2	3	4	5	6	7	8	9
101	2899	1397	0235	0319	5904	0003	8088	1905	7733	8060
102	7825	5409	9375	8387	7821	4044	2004	3784	4062	1510
103	2554	7423	3644	2702	5572	1547	4754	7605	0586	7517
104	9202	0022	0512	9403	4981	0887	8136	3810	2234	0531
105	6587	4132	4073	1627	0845	7391	5286	9327	8620	8679
106	2936	3705	1683	6125	9589	4711	5039	2451	1535	1785
107	0866	5059	3535	4076	3550	7915	3887	4104	9853	0749
108	2291	1818	2466	7884	2218	2089	8594	4615	9316	4174
109	4657	3232	4034	2133	7406	5246	3377	8644	3751	7402
110	4684	1278	1045	7780	1042	3752	8510	4452	6530	4322
111	5150	0521	7345	5987	0250	0216	3283	6590	0612	5895
112	6216	0290	0287	1327	1261	6902	7833	6256	1022	6096
113	0299	4050	7214	6390	7254	0100	1926	6506	1355	0648
114	8268	5594	6620	4371	2606	9710	1366	9945	2715	7083
115	2147	1822	7118	9840	2088	9800	0022	8955	2936	9209
116	1993	1361	4090	4753	7990	2339	6809	2638	2294	4783
117	0888	8380	5567	0165	5333	9343	6287	0128	7050	9734
118	8392	0864	4284	1869	4291	8100	3582	2437	0650	8812
119	3474	8099	3307	8070	2799	5794	5904	4804	5860	4604
120	9301	9691	6256	6788	5190	8793	7480	2763	0468	1625
121	1853	7462	9459	9440	9875	7335	7369	8559	0987	9817
122	8015	2527	0764	8683	6457	3355	0294	1177	7623	3952
123	9671	5790	1460	9181	3987	6303	0321	3132	0770	7984
124	3144	7732	9614	3003	7232	0436	1470	5735	3160	5356
125	8246	3283	0251	6136	8041	3041	4981	2605	7530	0581
126	9410	9785	5355	5616	9907	9222	5300	3212	1632	0273
127	2616	5706	2815	1768	8394	0528	5177	1961	7451	0067
128	8657	8901	0217	5872	8963	8326	0714	8769	9706	0651
129	6101	0251	5333	5253	7051	5492	5837	9508	8029	2154
130	8736	4493	5116	1812	9457	9663	8396	0350	9900	7197
131	2240	8483	1383	3288	5045	6135	3773	0869	3415	8494
132	7945	5971	1429	9426	6198	2241	1371	6798	9069	0059
133	0107	7447	9726	0740	2626	8312	1683	6095	3929	4847
134	2686	3354	9387	1732	9036	2679	4551	0372	5562	1932
135	5762	2898	0169	9265	1804	8196	4461	3044	8148	3440
136	2362	0927	2213	1456	5872	7563	7873	8148	7408	9834
137	0943	2552	3463	5792	1722	5702	0579	2125	3553	7613
138	0968	5505	7917	7812	3297	0996	9626	3931	4954	8197
139	7411	6269	7709	2010	5424	7489	4087	1861	7894	2424
140	1229	9675	5555	1766	3242	2756	8831	1411	6424	6419
141	5477	7684	5707	6457	4473	4401	1814	1203	8406	1503
142	2924	2030	0232	0669	2015	2321	0028	3343	0103	9635
143	6147	3463	9393	6931	7262	0635	0100	2920	6879	9018
144	5397	1006	1167	8094	7679	9271	9529	2107	0380	2781
145	4924	4787	8326	3602	4829	8769	7156	3560	0245	0460
146	8302	2334	7454	2980	6858	8002	9723	6961	4359	2603
147	8116	1613	9955	7589	6207	6364	1470	4641	3399	4119
148	7772	0518	6668	6220	6073	5577	1132	4089	6615	7817
149	3005	6141	3449	7778	9822	2978	6583	6365	4640	9828
150	0515	2611	5698	1784	1272	6277	1186	6157	6562	0114

ASTM D-3665

	0	1	2	3	4	5	6	7	8	9
151	3801	9094	3984	9662	7013	4675	3305	9477	6052	6463
152	5112	8493	3522	9082	1259	9393	1363	8384	9077	7256
153	6661	7321	5734	2238	7349	4913	2483	8800	2084	5533
154	9440	7478	8781	8877	0784	0963	6873	1825	1932	5033
155	5575	9490	3125	9746	8568	4724	1302	3744	5244	2820
156	5284	0256	6717	4189	4073	4327	3656	5039	4245	6650
157	9402	0218	7307	4515	6334	8394	3425	6806	3673	5666
158	3906	6392	1065	1416	8697	0728	7785	5091	3460	7425
159	2766	6735	3663	1802	1945	0226	2890	9448	7061	6863
160	0941	1822	4303	2196	5075	6276	2804	6772	7075	9958
161	9641	5726	2258	5528	1576	9655	1350	9548	4420	1533
162	8979	7285	9994	3207	6047	2331	8674	6722	4125	0510
163	1714	8090	1709	6994	1431	2278	2794	2976	6309	2646
164	4473	4405	2564	4567	3264	2473	8196	0385	5586	9738
165	5375	7532	1932	4760	9993	9806	9774	0254	5170	5947
166	4603	9646	8579	9149	1790	4482	1995	3069	0243	2391
167	8730	2372	0050	5351	0881	0813	7665	3128	1342	1692
168	2327	6572	9247	8958	3354	2747	5210	1817	6554	7970
169	8861	7298	6073	4138	6858	1097	2735	4934	3751	3858
170	6806	8850	7228	1330	8635	5597	1984	6638	0457	6876
171	8652	8362	1567	4844	5784	2737	9932	1684	8423	2794
172	6088	8885	2404	3769	3819	1362	7183	4445	7179	8671
173	1815	6022	9460	7823	8611	4410	7561	2609	0254	4294
174	3473	8945	0964	8240	6844	0396	3358	8447	7657	9587
175	4161	4157	7503	9125	8884	3890	8211	8391	2024	0696
176	3023	6708	3570	8685	3584	8230	4494	8788	1539	1088
177	5655	0644	5188	3485	6691	2698	5291	9690	3617	5423
178	8740	9861	2845	2286	6512	5913	4321	5439	4228	7904
179	1434	3335	3009	1410	9929	3214	2694	0530	6950	8837
180	1737	5691	9354	6787	2523	6040	3340	3542	1793	8388
181	0161	8195	9583	6276	0864	3568	4505	2997	2970	6221
182	9370	2850	5188	0492	0391	3796	2465	6420	2489	6883
183	3775	2928	8101	1313	6547	3748	3816	9558	0907	8016
184	6584	0790	2139	0854	2152	1231	4360	5694	8259	7658
185	4667	7582	2206	8373	2859	7140	3121	9352	6677	2725
186	6455	5130	1084	2872	4378	3176	7364	1393	1209	4810
187	0060	5586	6029	8412	9000	6808	0742	6397	4092	1542
188	6850	8675	7744	0269	2198	8756	1343	6312	8701	6551
189	2517	8132	4397	7633	4431	8702	8616	3250	0689	3254
190	1036	5789	6891	3343	0728	2997	0805	5021	4329	1727
191	9404	1396	6110	1404	4309	0810	5538	8437	6531	6233
192	7108	3253	6374	5536	6072	1705	0244	4504	4154	6666
193	0998	2139	0131	0188	1107	9274	3802	4429	7715	4470
194	1886	4751	0727	3940	8296	4045	8515	5907	8092	4462
195	0410	0317	6966	2726	0128	4489	9773	6389	8605	3374
196	5696	2690	8968	1055	1258	7378	0854	5822	9896	3157
197	4121	7845	1399	1548	5388	9814	5393	2307	2361	0736
198	2653	7554	3951	3033	4620	7119	9086	6337	5045	1744
199	9176	7228	0312	9807	0250	2529	3850	6094	3210	8576
200	7889	9222	3120	4810	8011	6547	0712	4644	2915	1757

ASTM D-3665

	0	1	2	3	4	5	6	7	8	9
201	0160	2080	4447	0987	8028	0893	8971	4711	3498	3214
202	5154	3661	9389	4489	7934	9303	5863	3013	5960	5528
203	5870	7150	9710	7592	9833	8508	3822	2767	7342	6994
204	3100	6300	8049	4190	3168	3921	3590	0225	2444	8492
205	5721	0309	6235	4420	9760	7120	5067	3677	5445	0166
206	3352	3597	3545	8929	7566	0659	8025	7646	9962	3558
207	6012	7380	8185	6058	4767	5729	4316	9275	0165	7284
208	3073	6406	9675	6618	8058	4886	0622	1399	1322	1086
209	8960	3547	7335	4895	8266	8777	8528	6159	6862	4045
210	9122	3189	1137	8510	4541	6840	2240	3387	7152	0303
211	1459	3953	3028	1387	5810	0653	3473	3428	9380	2324
212	1746	0560	8354	7708	2285	0271	3940	5701	3009	2806
213	0002	5212	7917	1803	3365	8926	5320	2260	1558	3065
214	7182	3788	0033	3700	7801	5444	4538	1490	2168	6773
215	4667	3429	8106	3438	0475	2585	2001	5522	0656	3263
216	0497	1847	8938	3034	9088	0171	0268	2200	8611	1604
217	0507	6271	7963	5876	9848	6195	7756	7009	2988	7755
218	7712	8211	3476	8087	9668	8525	1300	4946	7825	5942
219	8367	6320	8873	1714	2606	5061	7947	5577	2369	9865
220	4797	4636	8743	7654	8582	4404	1427	3184	4330	0629
221	2723	7808	4212	2829	5409	5536	4273	8463	3195	4760
222	0735	1290	5356	2656	0184	7098	3047	3119	3717	9146
223	2403	5596	2312	9495	7795	4340	5345	9760	0604	6924
224	3159	9707	2005	5170	5385	2547	2543	6824	1799	8770
225	1520	1715	5788	6617	4883	4298	5045	8441	7470	4036
226	7108	6343	3412	2468	9933	5243	6088	7536	4596	3891
227	0791	8526	5671	7048	9002	0659	0712	4177	1228	1953
228	1780	9336	7203	4396	8396	4545	1135	4896	5366	0708
229	5516	3683	9549	4366	9107	4131	0201	2591	8025	9653
230	4461	4751	8082	6812	2137	6132	3883	6558	4226	8948
231	9626	8918	2457	8185	7717	5394	6638	2502	5582	1122
232	6756	7753	9709	1035	2772	7304	3299	6694	7537	6602
233	5407	0516	5724	7163	4100	5175	9404	1533	5711	8976
234	2672	7284	8051	4037	8002	1559	8356	6394	7363	7046
235	3992	8742	2106	8239	9159	3264	7613	9875	7878	7387
236	0941	1041	5118	2023	0290	2367	8715	9205	1938	5930
237	6365	6705	4441	2372	1088	2556	2213	0804	4489	7373
238	0058	8038	0108	2366	7422	3279	4601	9582	5242	6909
239	3417	7647	7349	7279	6742	3162	5055	0446	7634	3001
240	3909	5035	8407	3799	8675	1271	1819	6555	1005	6819
241	2772	9332	6565	2386	1611	2155	9020	3950	7153	5833
242	1877	7002	4835	9720	4422	1244	7862	4014	9350	1454
243	5350	9156	7710	3431	5303	5049	4557	2826	3733	2119
244	4392	1336	0343	1648	8757	7994	8513	1310	5117	0218
245	0620	6016	8767	1768	3029	5651	1550	9273	5604	0129
246	0385	6746	3438	2298	5509	6194	7003	5151	3174	8353
247	5154	0200	3042	9369	0554	9107	5780	9933	5404	1179
248	0892	7126	7857	8375	0529	3641	3036	2352	0648	6838
249	3004	0224	9766	8811	4449	0446	0423	4018	5293	5149
250	2137	9259	7064	9222	0414	6276	1801	6341	3821	2858

ASTM D-3665

	0	1	2	3	4	5	6	7	8	9
251	8738	0126	5574	8727	9689	5310	8428	8939	3604	5463
252	8286	7025	0656	8101	3620	4040	6008	5988	4441	7366
253	5196	2398	3488	9799	5889	4995	9320	5810	2571	5018
254	8629	9583	2781	3710	3393	8053	2582	9954	7504	3172
255	1491	9040	7888	3142	0234	4314	6470	0272	6718	7455
256	6885	0882	3539	4555	9705	2851	0905	3691	3599	1263
257	2744	1556	6438	8433	1455	0961	2163	3205	6737	2458
258	7151	4750	6095	5337	0351	0195	3534	3551	9057	9258
259	0932	2673	3303	1271	0693	6085	5436	5071	8613	7754
260	3787	3647	2774	1479	0705	5762	9109	7973	0234	1627
261	5432	0890	5955	6306	0808	0595	5370	7828	9060	0900
262	4411	8675	9501	0470	3187	6746	9460	5219	6861	0252
263	2517	0941	1742	0320	1066	1632	3340	1779	1953	0403
264	9893	3022	3122	4194	2431	6441	1150	2419	0993	2814
265	4458	0712	8286	9156	0144	0853	2889	0752	2071	1967
266	2555	7714	6454	8424	2953	4083	5523	2402	5565	4877
267	9216	9051	0503	0948	3618	4645	9480	2773	3263	5260
268	8339	0418	0138	0621	7659	7614	7447	2702	8050	4418
269	0578	4867	2949	3278	9353	0528	6996	4985	7466	0562
270	1549	1857	8046	0828	6272	0429	3418	9482	6414	9865
271	6080	1044	7694	6380	2586	6890	0180	4510	5746	1061
272	5713	8882	2767	5543	4617	2028	7467	4201	4546	1038
273	1852	8853	3535	1588	3713	2645	5695	5920	3976	9559
274	9983	4276	6356	1430	6712	1960	0864	8141	1250	9109
275	2769	3262	9067	0222	5427	2138	0284	1652	8306	2801
276	0402	1540	1261	9724	7973	6497	1002	8296	8932	0561
277	2905	4816	1993	4133	0624	3722	7657	7018	5478	4947
278	8015	1002	2080	6152	6669	8702	9072	5154	5566	1960
279	8121	6009	2869	1354	3365	5494	4981	4995	9980	2596
280	5677	4328	8722	7179	6546	8694	9106	8683	4810	8793
281	5711	1090	2359	4469	9969	4643	0883	2827	0760	9017
282	8322	0249	3762	9962	7734	1456	9845	5780	3579	1940
283	2428	0148	6214	3472	8179	9928	7228	7385	4670	0145
284	4788	3796	8751	5801	7445	6592	6390	6925	3650	6391
285	1433	8831	7715	4040	9742	3589	3711	7050	4629	4769
286	4915	0972	1814	3753	3967	3774	4364	9655	7802	3470
287	5797	4758	0360	5646	8279	0078	9379	2050	5316	3735
288	1165	0540	1930	5730	2238	1212	5065	8288	1810	9952
289	1080	9746	9275	7872	2134	5756	6437	2613	8853	1388
290	9206	4169	5360	5897	8004	1263	1236	5349	0249	9954
291	7819	2316	2825	7552	2271	9595	5164	3306	5171	0588
292	8685	7689	9104	0477	0014	9977	0217	6092	8398	1493
293	5851	0869	0133	3025	9018	1154	4884	4605	8822	1712
294	8435	4257	7097	0086	4301	5930	4664	8767	0234	3160
295	1855	9220	1119	1450	2328	4328	3201	9835	0840	4623
296	4076	7372	7956	0744	0372	0902	4705	4243	3484	4177
297	2822	6671	0417	4235	8325	3187	8026	6820	6841	4386
298	2496	2711	2495	6289	7810	1554	3918	2795	3482	4791
299	5622	8509	4646	7790	3264	8837	7194	4731	6819	2442
300	4008	4838	2492	0135	9561	4802	1081	0023	2238	6158

ASTM D-3665

	0	1	2	3	4	5	6	7	8	9
301	7971	9600	7771	8772	8435	2027	5803	0033	8970	4155
302	8916	5699	0591	8719	4498	2609	0459	7647	0320	1406
303	6942	5255	4686	8671	0435	8762	6161	7763	0228	9421
304	2294	8229	7456	2523	9850	4054	0943	5591	2951	4550
305	1645	0141	6784	7107	7772	4759	0825	7146	0683	6241
306	0949	7024	9174	7412	2993	5904	4995	5453	7312	1372
307	3293	0519	4628	7255	5641	3126	5726	2759	8034	7946
308	6061	4830	5023	1703	9558	2275	9429	2446	3771	1867
309	8269	1953	1720	7596	7750	4879	9931	6103	0351	7966
310	3898	6464	1927	8613	1479	7301	5411	3028	9727	2956
311	1216	5466	2732	1629	7795	3961	0034	0275	8634	7286
312	1932	4667	6220	3122	8644	2691	3519	4722	8363	9069
313	6282	3202	1882	6210	3919	5503	3479	0715	1592	4739
314	9945	4743	0529	0479	5508	4757	2391	6105	7648	8866
315	4640	1838	4422	5173	2505	3431	0148	7781	4495	9296
316	7556	2059	5748	6791	6495	1305	6639	4561	2675	4285
317	9486	8085	6798	4929	7497	8939	1496	1278	4137	3868
318	4833	2442	3674	6391	2363	9950	9302	1287	3896	1341
319	2327	4580	3942	0111	9792	6565	9369	6582	6979	4906
320	8863	7379	8320	4208	2733	7322	6314	4918	2082	6269
321	9973	0331	0667	3872	2031	8732	6123	8979	9625	1717
322	3339	0207	1905	5488	0284	6400	1988	6052	4194	5108
323	8389	2826	7292	3980	3218	4038	8662	3648	2386	9707
324	3180	7799	3047	5571	3707	2169	3793	4893	9386	5076
325	8191	0589	5106	7833	7842	8730	6251	0164	8707	7143
326	5253	0006	4530	8929	7185	0777	5710	9929	4266	3976
327	6528	8627	8978	7845	0664	6075	8496	3007	3578	0054
328	7664	6718	2538	9486	5703	7120	8521	3092	5061	6758
329	2582	6415	0185	1376	1930	0611	5333	0381	0880	5173
330	1136	9939	4940	4262	4442	0616	1642	3711	6661	5900
331	7513	7500	7655	4979	0730	8292	4986	7596	3652	8795
332	3446	3239	5826	8234	9200	1745	5635	7985	9250	5137
333	5455	3963	9270	7772	2076	6947	1196	3554	4870	9012
334	5924	9407	5714	2668	3667	6455	3736	8000	0996	6479
335	2062	0663	9732	7210	7176	0600	2711	8263	8836	0248
336	6634	8562	4390	9896	5874	8468	5407	2706	5132	3233
337	5243	5667	4099	1093	8198	0419	3648	5472	3009	6040
338	9597	7559	7021	5907	2099	4749	8298	9985	4888	0488
339	7760	2517	3740	1071	9069	0307	5007	6464	8696	7642
340	8368	7543	9761	8222	6295	1429	8476	0702	5817	2201
341	2369	6985	1520	0657	5866	0305	8556	2679	4856	4545
342	1448	7833	1185	7564	2764	3037	4394	4471	3569	8648
343	2818	8346	2583	1128	2617	3164	5323	8621	7900	5153
344	9695	5029	4842	1958	0011	1191	8417	3693	0577	8155
345	9332	6231	6059	4504	5868	0919	8981	0255	5019	0132
346	9973	3782	2950	5578	6946	5306	0573	7584	4650	0914
347	1079	9960	5463	8782	3807	5847	1143	4970	9450	6702
348	1996	2975	2548	8115	5636	6783	2446	2212	8888	6953
349	6143	3506	0304	7631	5600	5362	5023	4429	7326	4962
350	1881	1015	7634	1233	0344	7387	0618	5230	6089	1658

ASTM D-3665

	0	1	2	3	4	5	6	7	8	9
351	2474	2846	2138	5148	5456	1827	9249	8511	0456	6711
352	4891	7097	6509	4975	1459	6666	6905	3446	6806	4006
353	0681	8014	6654	3268	2308	4404	8269	3880	1971	2340
354	8057	0244	6347	7837	9492	2710	8695	0157	8189	3298
355	6464	4582	6471	4256	9834	8259	5265	3994	9955	1857
356	8676	0217	6172	6026	2868	1308	4572	1540	8804	3022
357	7846	3762	1800	9549	8226	8940	8827	0862	1348	9595
358	5626	3873	6843	8420	6150	6098	1083	3060	4812	6298
359	9845	0138	1001	8645	0162	5240	6390	2301	7392	6690
360	9353	3771	5724	1013	5155	5456	1138	8420	1786	6626
361	6935	8841	1406	5737	8874	6992	5836	6368	0409	8243
362	0104	7282	8203	1156	6698	0060	2171	2400	7803	3631
363	5035	3811	5070	6267	6210	1465	2385	3399	1286	7238
364	9862	2735	5941	1736	3534	0971	5609	3581	2044	7319
365	0225	7328	1950	1095	8808	4012	6196	9592	7294	9312
366	7538	7869	0825	5632	6534	5707	5876	6540	4431	1354
367	9848	3955	0524	8485	0471	7074	5687	3348	9644	6513
368	8352	2284	5922	1596	4777	0526	4480	5497	5321	6962
369	6165	0280	8626	6560	6573	8171	2403	1660	8348	0153
370	0434	1242	8901	0752	4918	6366	8283	9303	5193	9159
371	4811	9244	4548	0196	2696	3400	2953	4985	3480	8546
372	0577	9457	2264	3497	2752	5823	5782	3961	8965	7713
373	1290	5220	7325	4913	0769	6142	2579	9710	1406	1196
374	8753	2693	7801	8681	2428	9102	6276	7679	1295	5501
375	1837	0731	4801	8869	2053	3620	4074	8615	5519	8346
376	3445	2093	5420	9643	7743	9290	3672	3090	7199	5490
377	6756	9995	9813	8272	4085	7116	6738	5947	1378	0111
378	2686	1974	4635	5511	0123	8896	2424	4066	7619	7305
379	9794	0151	2672	8724	6101	8873	5479	3676	3860	3475
380	4695	4339	2138	8908	7220	5788	1324	9837	8447	2175
381	1747	7440	8716	6254	0012	6060	5348	7185	5750	4662
382	1886	5166	7379	5530	8367	9896	2266	4165	8824	9835
383	1349	0670	0860	9406	8648	5621	8679	2194	3603	5648
384	2797	2535	1992	1905	0009	0033	4927	6876	0742	2964
385	3128	0069	2354	2819	4161	7102	2964	0416	2039	2529
386	1412	8649	0922	3149	3872	7622	9557	8675	0588	0191
387	2729	8481	1359	6697	3619	1353	7129	9649	1809	2201
388	2314	4349	4646	6545	3947	1674	4343	2835	2779	7938
389	4132	8683	4436	5899	0690	6158	6727	6992	4698	2044
390	4446	9426	3046	9184	0839	1683	1638	0381	9034	7293
391	6528	3645	6113	5319	4499	3842	2293	7107	7186	1688
392	3669	1878	2310	3170	1473	5727	8861	7295	1091	9753
393	9248	4854	1800	4241	6937	1053	4814	1170	0575	2612
394	1911	3848	4153	9481	1670	5639	2993	7943	3589	4976
395	6284	3306	7926	7823	0740	0951	6620	7050	8092	8800
396	7668	5957	9100	2999	9574	2412	7182	4656	9566	7086
397	0474	0478	5909	3983	2785	6208	5172	4475	0281	4669
398	8195	1115	3544	1547	4574	2611	7372	6316	9498	2554
399	1147	4374	0906	7740	7090	4901	7056	9893	7207	7998
400	4852	8998	8520	1484	9872	7766	3586	4545	4610	4880

ASTM D-3665

	0	1	2	3	4	5	6	7	8	9
401	5903	2815	5600	3726	1747	2955	1887	2011	7023	2262
402	3919	7784	5844	9245	3032	0608	9045	6136	6952	8731
403	9503	3716	3501	0070	8298	1316	4132	4493	1861	0291
404	1086	1533	8345	5845	8600	4197	5063	1374	4890	9987
405	5996	8476	1614	5369	4138	6956	4761	7831	6253	5064
406	8436	0235	4916	7933	9734	4990	8029	6291	6313	7833
407	9786	0111	7147	9737	5904	9592	1918	3297	6639	8205
408	3818	9483	1180	3180	1560	9700	2598	6046	0978	9764
409	2080	2054	4466	3751	7813	0263	1414	4956	3837	4371
410	4294	3586	6006	3516	8383	9750	7403	8479	6064	6365
411	5412	0398	8619	7465	0449	3417	3759	1558	2947	8310
412	6177	7183	9247	4137	5425	4237	8035	4045	0093	2706
413	3381	3433	5711	5851	2136	0809	9689	4387	7166	6189
414	7027	2221	3889	9224	0597	3938	0041	6989	3954	3096
415	1136	3027	1515	2864	6250	5302	9795	5258	7223	8749
416	6343	3439	1807	0720	2440	2421	1456	2590	4164	9753
417	2124	6593	1687	9250	2937	5882	8580	3502	1821	7647
418	9325	4010	7456	2642	0180	9342	1220	9180	4981	4833
419	2340	2698	8789	1934	9747	7965	4748	4876	7761	3657
420	8104	0685	7177	4315	9974	4043	5756	2395	4274	7237
421	0853	8104	7012	6149	7514	7766	3877	7970	3408	8541
422	4592	1909	8828	0411	1621	2734	3756	0381	0688	7771
423	9309	2879	5269	0957	6308	0144	6880	7062	9329	5785
424	1421	6802	5710	3728	7241	8441	0393	4421	0624	1559
425	7599	8835	2748	5413	1506	5048	6173	0059	5326	4605
426	1801	9449	0797	3895	8311	0289	4797	1398	8431	1286
427	3294	9090	8380	5944	6006	1522	2214	0292	6575	3530
428	3445	2270	3259	7507	4084	7868	5625	1212	8575	3991
429	1022	0982	6854	1429	3931	6639	9170	1290	8998	8304
430	1019	2949	3740	2736	0035	9443	2872	5922	9422	4088
431	3259	0725	4998	6694	2155	6976	0381	6600	2252	2088
432	9556	6103	8231	6413	4297	2694	2367	9508	3610	4606
433	2916	3812	8645	8275	7166	8914	4340	8743	8870	1759
434	1634	3824	5008	4400	7670	7111	0210	6252	6571	4695
435	9727	1073	8076	9090	9802	9161	1969	4320	8970	4953
436	8288	1981	1202	5977	4534	1534	0361	8131	9021	1074
437	1991	0425	1232	0507	9400	3951	1574	6427	4018	0565
438	6855	9445	8507	2710	7031	3891	4395	4966	6465	0254
439	3829	3090	2294	5862	8456	0838	4262	2207	9315	1708
440	0687	0834	7690	5627	8793	9704	8979	3715	7620	1140
441	1192	6075	3222	8556	6901	0933	4516	0926	4335	4495
442	0828	8628	5557	4267	8715	4172	0999	3878	2273	7895
443	8506	4635	9763	3061	1415	1827	2584	3268	0820	6347
444	3664	7739	5915	6699	1254	5051	2199	9780	8256	9094
445	5207	0281	3380	4663	3723	3713	6068	7919	4572	3562
446	4758	3038	9066	6631	2989	0399	5011	3155	4363	5134
447	2948	2150	5274	2619	0872	4823	3397	9551	3514	0578
448	2916	6211	7975	3521	0002	8336	3572	4460	8194	4152
449	4074	8791	1711	9092	1662	1968	5890	8876	7886	8459
450	5522	0630	9099	9412	1987	2213	0365	0857	7059	5607

ASTM D-3665

	0	1	2	3	4	5	6	7	8	9
451	2818	1644	4095	6517	7888	7497	2504	8517	4795	9180
452	4008	2178	9797	2511	0230	3206	4609	9199	9555	4257
453	9270	6757	3094	1902	9576	4245	1907	3537	5024	2212
454	4283	0575	9216	8849	2046	6433	4348	4006	5419	7348
455	1995	9490	1002	4583	1903	0695	9105	6675	9853	8560
456	7486	7617	4960	5009	9875	4046	2463	5190	0337	1009
457	6740	4125	1009	3464	5270	4471	9111	2489	0515	1710
458	2040	3384	2173	7430	7710	9138	9836	4218	4788	6353
459	7800	5776	7489	6166	9933	7387	1823	5741	7063	9422
460	5452	1798	7818	3843	3198	4116	9760	7388	4983	6146
461	2200	9082	1932	0727	4111	2410	7424	8087	4815	1699
462	1380	8104	6786	8552	3552	1648	4648	9452	5785	1241
463	8680	4358	2373	2783	4619	2527	0836	6785	0440	6401
464	1442	8608	9787	4313	9567	5835	5847	9018	8906	3386
465	6968	6542	4931	0323	0554	8831	8249	0884	9401	6952
466	7017	6936	0751	5273	9485	4538	3094	9626	9738	9804
467	7916	6025	2082	4194	9689	4313	8267	3151	2120	9043
468	4313	3979	1380	2564	0454	7942	7243	1338	7826	9340
469	2089	8835	2164	5938	8577	0985	0234	2946	2419	5892
470	0110	8951	0140	6090	1500	7194	0908	5051	5922	7749
471	1634	2255	6261	4023	9225	8815	4309	3774	2946	2517
472	5586	2457	2063	8645	0523	6201	7859	8115	0258	5695
473	0104	3562	6376	0844	7930	8418	9693	5009	9286	4414
474	2735	6851	1541	6615	8432	4800	7595	4895	8951	2809
475	4918	5473	2964	7280	2406	3790	3510	2381	5010	6320
476	4472	6105	3805	3445	8048	1078	8687	7530	4655	9307
477	7816	2237	8693	7775	7897	6151	9126	4346	5236	7570
478	4887	4977	7314	2769	2370	9663	9521	7514	5813	9469
479	1139	7560	1276	5646	3261	8693	3199	6530	2934	0526
480	3444	8169	7650	6183	5108	4653	5072	3348	3792	5971
481	8104	6577	1738	8790	4278	4361	0730	1096	4115	5109
482	2371	2964	2888	3142	9540	2366	0706	1236	0671	1067
483	0999	1401	4609	0833	8450	5466	3812	2756	7902	0033
484	7795	3205	8089	6436	9586	4275	2515	7261	0958	0312
485	4848	3403	1042	3406	0964	5409	5612	8689	6122	7344
486	9440	0676	9834	6449	4216	9188	6150	8022	3893	8890
487	7111	1014	8160	5340	3426	0695	1038	3751	4974	1411
488	8938	4688	2284	0285	4845	8425	4891	2736	7926	3523
489	6950	5210	1565	0431	9641	4016	4505	2629	0111	4095
490	4622	6658	6572	3213	6579	5854	9445	2878	3584	2564
491	6744	0048	1861	2664	0433	4286	8231	6419	5599	9079
492	5695	8530	1924	6177	8870	4822	9070	6201	6412	7507
493	6966	3987	6009	2936	4683	1084	9613	7013	6260	2609
494	7066	8247	9253	8223	0395	5403	2097	7574	5642	0500
495	9895	7280	6024	4505	0338	0706	8514	0659	5178	4059
496	3081	0287	4712	5215	7088	7707	0787	7815	7176	7655
497	2725	3254	8246	4645	9448	7622	0063	9307	9870	2843
498	7315	0408	0976	3714	3932	9194	6425	6438	0639	0028
499	5270	0138	2015	7250	0504	5008	2431	8394	1859	7517
500	6729	4405	0043	5901	9227	5824	5584	1345	9856	2515

References

1. "Manual of Operation and Instruction 4640-B Series Surface Moisture-Density gauge", Troxler Electronic Laboratories, Inc., Third edition, 1991.
2. "Manual of Operation and Instruction 3450 Roadreader Plus", Troxler Electronic Laboratories, Inc., Third edition, 1991.
3. "Pavement Quality Indicator Model 301 Operator's Handbook", TransTech Systems, Inc., 2002.
4. "Pavement Quality Indicator Model 380 Operator's Handbook", TransTech Systems, Inc.
5. "Manual of Operation and Instruction Model 2701-B Pavetracker Plus," Troxler Electronic Laboratories, Inc. 2004-2006.
6. ASTM Manual, D-3665 Standard Practice for Random Sampling of Construction Materials, Volume 04.03.
7. *NCDOT Standard Specifications for Roads and Structures*, (latest edition) January 2012.
8. *Hot Mix Asphalt Quality Management System Superpave* (latest edition).

NOTES