

CHAPTER ONE

GENERAL DESIGN

DESIGN POLICY INTERPRETATION**1**

The adoption of the policy, “A Policy on Geometric Design of Highways and Streets” (2011) by AASHTO and the Federal Highway Administration will supersede all of the previous AASHTO policies and guides dealing with the geometric design of new construction and reconstruction projects. “A Policy on Design Standards - Interstate System AASHTO, 2005” is also approved.

It is the responsibility of the Section Engineers and Project Engineers to be assured that all plans, specifications, and estimates (PS&E’s) for federal-aid projects conform to the design criteria in “A Policy on Geometric Design of Highways and Streets” (2011) (“Green Book”) and the Roadway Design Manual.

Much of the material contained in the 1973 Policy on Design of Urban Highways and Arterial Streets and the 1965 Policy on Geometric Design of Rural Highways and the “1984, 1990, 1994, 2001, and 2004, Greenbook” has been incorporated into, “A Policy on Geometric Design of Highways and Streets” (2011). While material from the superseded guides, as well as much other valuable criteria and information is included in “A Policy on Geometric Design of Highways and Streets” (2011), only certain portions should be viewed as controlling criteria. Therefore, those criteria related to design speed, lane and shoulder widths, bridge width, structural capacity, horizontal and vertical alignment, grades, stopping sight distance, cross slopes, superelevation, and horizontal and vertical clearances contained or referenced in Chapter VI, VII, and VIII are to be controlling criteria and require formal design exceptions when not met. In the absence of material covering controlling criteria in the above chapters, criteria are to be set based on Chapters III and IV. Criteria in Chapter V, Local Roads and Streets, apply only to off-system projects.

Deviations from the above controlling criteria will require the processing of a design exception letter by the Section Engineer or Project Engineer through the Unit Head.

CHAPTER ONE

GENERAL DESIGN

SELECTION OF PROJECT DESIGN CRITERIA**1-1**

Selection of the correct design criteria for a project is one of the most important tasks that confront the highway designer. There are unlimited factors that can affect the design of a particular project making it impossible to provide explanations for them. However, design criteria is more strongly affected by the functional classification, design speed, traffic volumes, character and composition of traffic and type of right of way. Usually when full control of access is purchased, the design standards are much higher than on a project with partial or no control. Other control factors such as unusual land features, safety and economics are always highly reflected in the design criteria.

Since functional classification, design speed, traffic volumes and terrain classifications are the major points of design that must be established, a brief explanation of each is provided in the following section. The Project Development and Environmental Analysis Branch includes information in the planning report necessary for the Design Engineer to establish most design criteria, but the designer may have adequate justification to revise some of this information as in depth design studies are undertaken.

The designer must realize that the design criteria provided outlines minimum and desirable criteria for use in designing most roadway projects. It will be the responsibility of the Project Engineer and/or Section Engineer to determine when deviations from the design criteria are necessary. When deviations are required, it shall be discussed with the State Roadway Design Engineer.

When the functional classification, design speed, traffic volumes and terrain classification are chosen, the design criteria for the particular project can be established.

Critical design elements not meeting AASHTO Standards will require an approved design exception. These critical design elements are design speed, lane width, shoulder width, bridge width, structural capacity, vertical clearance, horizontal alignment, vertical alignment, stopping sight distance, cross slope, superelevation, design life and grades. On projects requiring step by step Federal Highway Administration review, the design exception must be approved by the Federal Highway Administration. On all other projects, the State Highway Design Engineer must approve design exceptions. Any other significant design elements not meeting AASHTO standards should be documented in the project file.

FUNCTIONAL CLASSIFICATION**1-1A**

Functional classification is the process by which streets and highways are grouped into classes, or systems, according to the character of services they are intended to provide. The designer must realize that individual roads and streets do not serve travel independently. Rather, most travel involves movement through a network of roads. Therefore, the functional classification of a road must be determined before design criteria can be established for any proposed improvements being studied by the Design Engineer. On a normal roadway project with an approved planning report, the functional classification is normally given. They will be one of the following: Interstate, Freeway, Arterial (including expressways), Collector, and Local.

DESIGN SPEED**1-1B**

Geometric design features should be consistent with the design speed as shown in the planning report or as determined by the Project Engineer or Section Engineer. Consideration should be given to roadside development, vertical and horizontal alignment, terrain, functional classification, traffic volumes and other contributing factors that are not specifically mentioned but may be a factor on a project by project basis. When design speeds are established, every effort shall be made to use the highest design speed that is practical to attain a desired degree of safety, mobility and efficiency. The design speed of a facility should be a minimum of 5mph above the anticipated posted speed.*

NOTE: The design speed in the Planning Report for bridge replacement projects pertain to the horizontal curvature recommended in the report. Actual design speed attainable for the bridge and approaches will be determined by the Project Design Engineer or Assistant Section Engineer after reviewing grades, possible right of way damages, posted speed, etc.

It is the responsibility of the Project Engineer in Roadway Design to review the design speed selected. The selected design speed shall be shown on the project title sheet with other design data.

The following guidelines provide minimum design speeds for each functional classification. (See the following pages)

* Note: The design speed can be the same as the posted speed on projects with a short project length. It can be considered on bridge replacement projects with length of approximately 2000' or less.

DESIGN SPEEDS (continued)**1-1B**

Design speed is a selected speed used to determine the various design features of the roadway. Geometric design features should be consistent with a specific design speed selected as appropriate for environmental and terrain conditions. Designers are encouraged to select design speeds equal to or greater than the minimum.

Low design speeds are generally applicable to roads with winding alignment in rolling or mountainous terrain or where environmental conditions dictate. High design speeds are generally applicable to roads in level terrain or where other environmental conditions are favorable. Intermediate design speeds would be appropriate where terrain and other environmental conditions are a combination of those described for low and high speed. See Part I, 1-1D for information on terrain classifications.

LOCAL RURAL ROADS**MINIMUM DESIGN SPEEDS**

See “A Policy on Geometric Design of Highways and Streets” (2011), Table 5-1

Table 5-1. Minimum Design Speeds for Local Rural Roads

US Customary						
Design Speed (mph) for Specified Design Volume (veh/day)						
Type of Terrain	Under 50	50 To 250	250 To 400	400 to 1500	1500 to 2000	2000 to over
Level	30	30	40	50	50	50
Rolling	20	30	30	40	40	40
Mountainous	20	20	20	30	30	30

LOCAL URBAN STREETS

Design speed is not a major factor for local streets. For consistency in design elements, design speeds ranging from 20 to 30 mph may be used, depending on available right-of-way, terrain, likely pedestrian presence, adjacent development, and other area controls. In the typical street grid, the closely spaced intersections usually limit vehicular speeds, making the effect of design speed of less importance. Since the function of local streets is to provide access to adjacent property, all design elements should be consistent with the

DESIGN SPEEDS (continued)**1-1B**

character of activity on and adjacent to the street, and should encourage speeds generally not exceeding 30 mph.

RURAL COLLECTORS

MINIMUM DESIGN SPEEDS

See “A Policy on Geometric Design of Highways and Streets” (2011), All 6.2 Rural Collectors, Table 6-1.

Table 6-1. Minimum Design Speeds for Rural Collectors

US Customary			
Type of terrain	Design speed (mph) for specified design volume (veh/day)		
	0 to 400	400 to 2000	over 2000
Level	40	50	60
Rolling	30	40	50
Mountainous	20	30	40

Note: Where practical, design speeds higher than those shown should be considered.

URBAN COLLECTORS

MINIMUM DESIGN SPEEDS

Design speed is a factor in the design of collector streets. For consistency in design, design speed of 30 mph or higher should be used for urban collector streets, depending on available right-of-way, terrain, adjacent development, likely pedestrian presence, and other site controls.

In the typical urban street grid, closely spaced intersections often limit vehicular speeds and thus make the consideration of design speed of lesser significance. Nevertheless, the longer sight distances and curve radii commensurate with higher design speeds result in safer highways and should be used to the extent practical.

RURAL ARTERIALS**MINIMUM DESIGN SPEEDS**

Rural arterials should be designed with design speeds of 40 to 75 mph depending on terrain, driver expectancy and, in the case of reconstruction projects, the alignment of the existing facility. Design speeds in the higher range -60 to 75 mph- are normally used in level terrain, design speeds in the midrange -50 to 60 mph- are normally used in rolling terrain, and design speeds in the lower range -40 to 50 mph- are used in mountainous terrain.

=====

URBAN ARTERIALS**MINIMUM DESIGN SPEEDS**

Design speeds for urban arterials generally range from 30 to 60 mph. Lower speeds apply in more developed areas and in central business districts, while higher design speeds are more applicable in outlying suburban and developing areas.

=====

URBAN AND RURAL FREEWAY**MINIMUM DESIGN SPEEDS**

As a general consideration, the design speed of urban freeways should not be so high as to exceed the limits of prudent construction, right-of-way, and socioeconomic costs. However, this design speed should not be less than 50 mph. Wherever this minimum design speed is used, it is important to have a properly posted speed limit, which is enforced during off-peak hours.

On many urban freeways, particularly in developing areas, a design speed of 60 mph or higher can be provided with little additional cost. In addition, the corridor of the main line may be relatively straight with the character of the roadway and location of interchanges permitting an even higher design speed. Under these conditions, a design speed of 70 mph is desirable because higher design speeds are closely related to the overall quality and safety of a facility. For rural freeways, a design speed of 70 mph should be used. In mountainous terrain, a design speed of 50mph to 60 mph, which is consistent with driver expectancy, may be used.

DESIGN SPEEDS (continued)**1-1B**

INTERSTATES

MINIMUM DESIGN SPEEDS

See A Policy on Design Standards - Interstate System, AASHTO, January 2005.

TRAFFIC VOLUMES**1-1C**

Traffic volumes are a major factor in selecting design criteria. All design criteria is based on a Design Hourly Volume (DHV) or annual Average Daily Traffic (ADT). Sometimes on minor low volume roads, the Average Daily Traffic (ADT) is the only traffic volume listed in the planning report. In this case, the ADT is used as the design basis. However, on most major highways, the design is based on a design hourly volume (DHV). The DHV is based on the 30th highest hourly volume. The design year is listed in the planning report and is usually either ten or twenty years beyond the beginning of construction.

If projects are delayed, the design year traffic should be updated. Design year traffic that is 17 years or less from the beginning of construction should be updated to twenty years. For example, a project has a twenty year design period and is scheduled to be let in 1998. The design year traffic listed in the planning document is 2015. The traffic volumes should be updated to the year 2018. These traffic updates should occur as necessary at the beginning of the preliminary design, right of way plans, and final plans.

TRAFFIC VOLUMES (continued)

1 - 1C

CONVERTING ADT TO DHV

Below is an example of converting ADT to DHV in interchange areas.

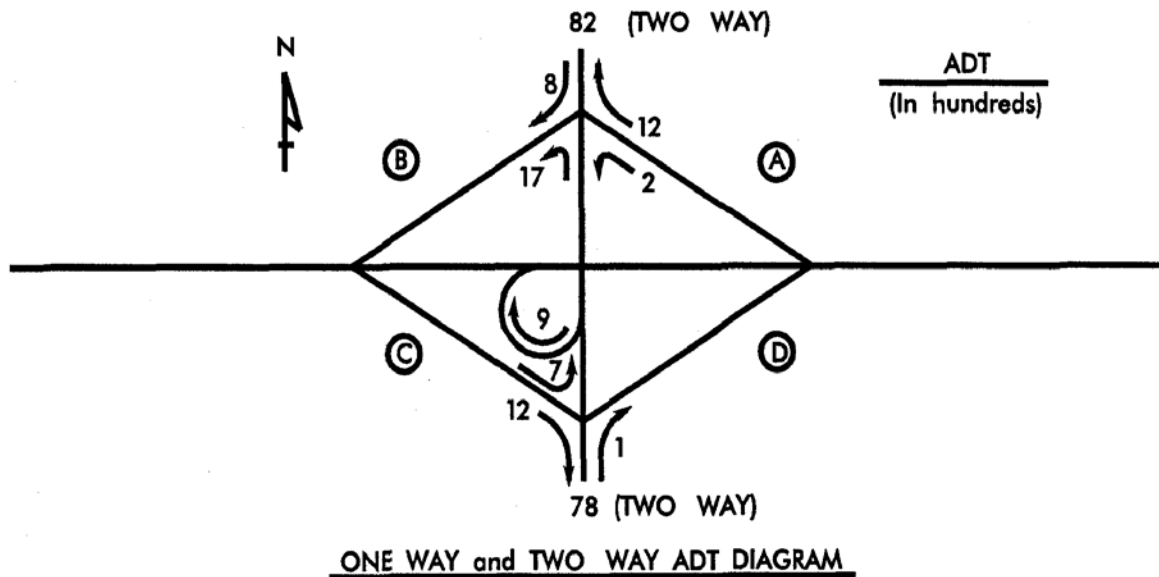

Convert the traffic volume to a stick diagram by combining the moves from one approach to the other. For instance, the movement from westbound to northbound is 1200 ADT and the counter moves from southbound to eastbound is 900 ADT for a total of 2100 ADT. Likewise the movement from southbound to westbound is 800 ADT and from eastbound to northbound is 700 ADT for total of 1500 ADT. This procedure will produce a stick two-way ADT diagram as followed:

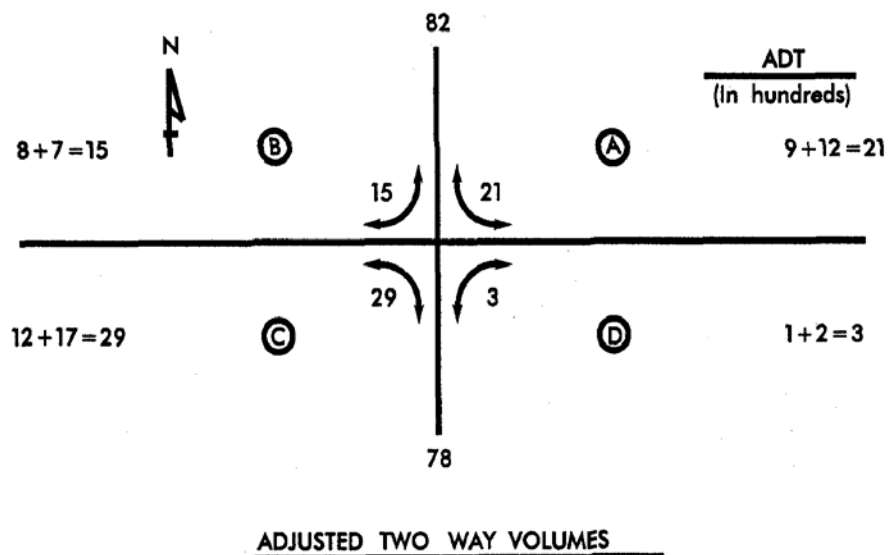

TRAFFIC VOLUMES (continued)**1-1C**

The actual conversion from ADT to DHV is accomplished by the usual method of applying the appropriate DIR and DHV factors. Please note that this method results in directional peaks for all movements simultaneously and may not be appropriate for all cases, such as restricted or urban areas. In restricted or urban areas A.M. and P.M. or a 60% vs. 40% direction may be required.

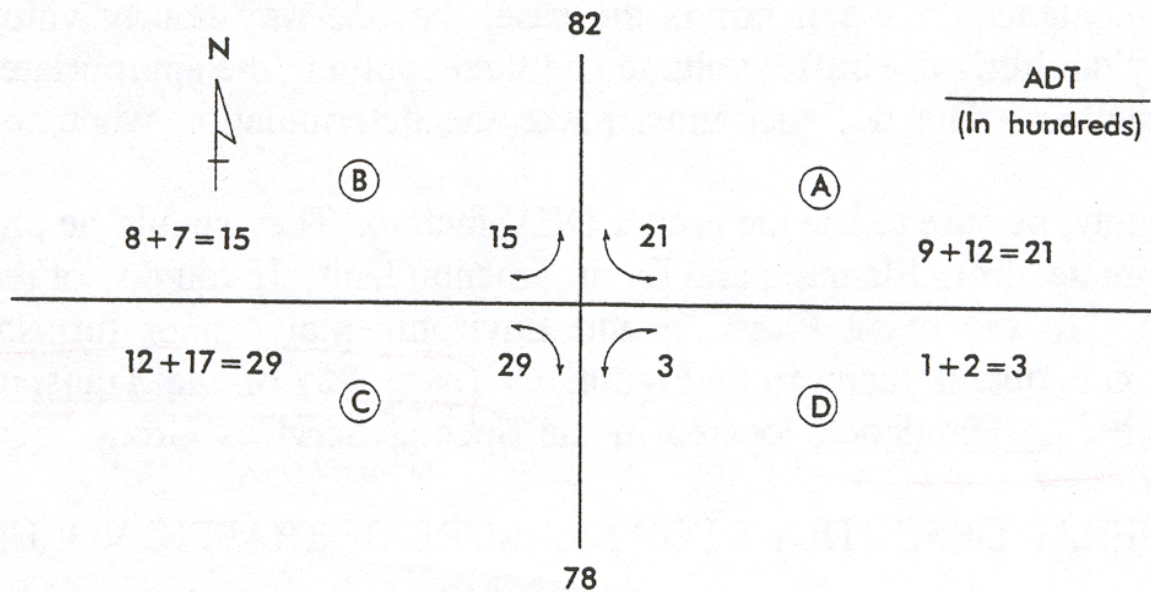

ADJUSTED TWO WAY VOLUMES

COMPLETED DHV CONVERSION

This procedure cannot be used when the given one-way daily volumes are excessively unbalanced. When this is the case, the one-way hourly volume will be determined by doubling the traffic volume and then applying the appropriate directional and hourly factors. The designer must make the determination when to apply this procedure.

TRAFFIC VOLUMES (continued)**1-1C**

NOTE: GENERAL DEFINITIONS FOR MEASURE OF TRAFFIC VOLUME

AVERAGE DAILY TRAFFIC (ADT)

The most basic measure of the traffic demand for a highway is the Average Daily Traffic (ADT) volume. The ADT is defined as the total volume during a given time period (in whole days), greater than 1 day and less than 1 year, divided by the number of days in that time period. The current ADT volume for a highway can be readily determined when continuous traffic counts are available. When only periodic counts are taken, the ADT volume can be estimated by adjusting the periodic counts according to such factors as the season, month, or day of week.

DESIGN YEAR ADT

Design Year ADT is the general unit of measure for projected Average Daily Traffic (ADT) to some future design year. Usually, the Design Year is about 20 years from the date of beginning construction but may range from the current year to 20 years depending on the nature of the improvement.

See “A Policy on Geometric Design of Highways and Streets” (2011), Ch.2. Also see Chapter 4 of this manual.

TERRAIN CLASSIFICATIONS**1-1D**

For design purposes, three terrain classifications are utilized in North Carolina. These classifications have an affect on the design criteria and will be reflected in the design charts. They are as follows:

- Level: In level terrain, highway sight distances, as governed by both horizontal and vertical restrictions, are generally long or can be designed to be so without construction difficulties or major expense. In level terrain, the slope is considered to range from 0% to 8%. Any reference to a slope shall mean the rise and fall on the grade measured both parallel and perpendicular to the centerline.
- Rolling: In rolling terrain, natural slopes consistently rise above and fall below the highway grade line, and occasional steep slopes offer some restriction to normal highway horizontal and vertical roadway alignment. In rolling terrain, the slope is considered to range from 8.1% to 15%.

TERRAIN CLASSIFICATIONS (continued)**1-1D**

Mountainous: In mountainous terrain, longitudinal and transverse changes in the elevation of the ground with respect to a highway are abrupt. Benching and side hill excavation is frequently needed to obtain acceptable horizontal and vertical alignment. In mountainous terrain, the slope is considered to range over 15%.

See “A Policy on Geometric Design of Highways and Streets” (2011), Ch.3.

When a terrain classification is chosen, geographical locations should not be the major factor. For example, a segment of road west of Asheville may have land characteristics of roads in level or rolling terrain.

PROJECT COST REDUCTION GUIDELINES**1-1E**

The primary objective of highway design is to design a safe, functional, aesthetically appearing facility which is adequate for the design traffic volumes, for the minimum life cycle costs. These guidelines suggest possible design changes to help reduce project costs. The suitability of each suggested change should be evaluated within the context of the primary objective of highway design.

(1) Avoid overdesign.

Consider using minimum design criteria where doing so will not significantly compromise safety or function.

(2) Cross Section

- a) Median width - Use the minimum width that is compatible with the type of facility, the needs of projected traffic, positive drainage requirements, and median crossover design.
- b) Lane width - See “A Policy on Geometric Design of Highways and Streets” (2011), Table 5-5, for desirable lane widths. Arterial lane widths may be reduced to 11 ft. when restrictive or special conditions exist. Less than desirable lane widths may remain on reconstructed highways where alignment and safety records are satisfactory.

PROJECT COST REDUCTION GUIDELINES (continued)**1-1E****Table 5.5 Local Roads - Minimum Width of Traveled Way and Shoulders**

US Customary				
Minimum width of traveled way (ft) for specified design volume (veh/day)				
Design speed (mph)	1500			
	under 400	400 to 1500	to 2000	over 2000
15	18	20 ^a	20	22
20	18	20 ^a	22	24 ^b
25	18	20 ^a	22	24 ^b
30	18	20 ^a	22	24 ^b
40	18	20 ^a	22	24 ^b
45	20	22	22	24 ^b
50	20	22	22	24 ^b
55	22	22	24 ^b	24 ^b
60	22	22	24 ^b	24 ^b
65	22	22	24 ^b	24 ^b
Width of graded shoulder on each side of the road (ft)				
All speeds	2	5 ^{a,b}	6	8

^a For roads in mountainous terrain with design volume of 400 to 600 veh/day, use 18-ft traveled way width and 2-ft shoulder width.

^b Where the width of the traveled way is shown as 24 ft, the width may remain at 22 ft on reconstructed highways where there is no crash pattern suggesting the need for widening

^c May be adjusted to achieve a minimum roadway width of 30 ft for design speeds greater than 40 mph.

- c) Shoulder width - See Part I, Chapter 1-4 of this manual, for minimum shoulder widths. Partial width shoulders may be considered where full width shoulders are unduly costly, as in mountainous terrain.

PROJECT COST REDUCTION GUIDELINES (continued)**1-1E**

- d) Roadway ditch - See part I, Chapter 1-2A, Figure 1, of this manual, for standard methods of designing roadway ditches. Flatter or steeper slopes than those shown in Figure 1 may be warranted by project specific soil conditions, accident history, or requirements for balancing earthwork.
- e) Ramp widths - The standard ramp pavement width is 14 ft. 12 ft. ramp pavement width may be used if the full usable width of right shoulder is to be paved. (See Paved Shoulder Policy - Part I, Chapter 1-4O)
- f) Y-lines - Select Y-line pavement width and intersection radii which is appropriate for Y-line traffic volumes and characteristics, and compatible with the existing Y-line cross-section.

(3) Earthwork

Earthwork is one of the highest cost items on projects; therefore, every effort should be made to reduce and balance earthwork.

- a) The steepest slopes practical should be used while considering soil conditions, safety requirements, constructability and maintenance.
- b) Alignment - To help reduce earthwork, give careful attention to the selection of horizontal and vertical alignments. Attempt to balance cut and fill sections, and avoid areas with poor soil conditions. The Project Engineer and Project Design Engineer should both carefully review project alignments.
- c) Use waste to flatten slopes, build false cuts, etc., to improve safety and eliminate guardrail, and eliminate the need for waste pits. (Where possible, use unsuitable material to flatten slopes.)
- d) Utilize cost effective analysis to determine if it is more economical to flatten slopes or use guardrail. (Consider R/W cost, and the cost of providing waste areas.)
- e) Preliminary grades are usually based on contour maps and errors of 5 feet in elevation are possible. When beginning right of way plans, the preliminary grades should be reviewed and refined so they will be accurate and cost effective.

PROJECT COST REDUCTION GUIDELINES (continued)**1-1E****(4) Right of Way**

- a) Where feasible, use temporary easements rather than purchasing property. This reduces right of way costs and the unnecessary taking of property. See Part II, Chapter 9-4 of this Manual.
- b) Consider using an "L" or "Tee" type turn around instead of a circular cul-de-sac to save pavement cost and reduce right of way on roads being dead-ended.
- c) Consider reducing commercial channelization to that required for sight distance and maintenance of roadway.

(5) Drainage

- a) Review drainage and have Hydraulics Unit recheck whenever it appears changes could be made to reduce cost. Use stone lined ditches where possible in lieu of paved ditches.
- b) Reduce length of paved ditch or stone lined ditches where possible.
- c) In interchange areas, look closely at drainage to see if grading adjustments could simplify drainage and reduce drainage items.

(6) Pavement Design

- a) Use pavement components, which give a reduction in number of layers and construction operations.
- b) All pavement designs including mainline, Y-lines, ramps, loops and detours should be obtained from the Pavement Management Unit.

(7) General

- a) Carefully review high cost items (bridges, culverts, barriers, special designs, etc.) to reduce or eliminate where possible.

PROJECT COST REDUCTION GUIDELINES (continued) **1-1E**

- b) Recheck need for detour structure. Is it possible to close road? Can a precast box culvert be used to allow closing of a road in a minimum amount of time? Can a Portable Detour Structure be used?
- c) Consider submitting project for a Value Engineering study if the construction cost exceeds \$2,000,000 and the design has not progressed past the right-of-way stage.

HOW TO SELECT A TYPICAL SECTION **1-2**

For assistance in selecting a typical section, a brief explanation is provided for the major considerations that are directly or indirectly affected by the design criteria. Study each of these carefully before you begin to select a typical section.

The typical section should be based on sound engineering principles with primary emphasis being placed on the type of facility, traffic volumes, terrain, availability of right of way, grading, guardrail construction and economics.

On projects of major importance and where a significant savings can be realized, several design combinations should be considered. After the most feasible of the design combinations are chosen, an analysis should be made to select a typical section that will provide a safe and economical highway. An analysis in the early stages of design may determine that it is necessary to revise the typical section to:

- 1) Reduce right of way takings.
- 2) Improve grading operations.
- 3) Utilize waste material to flatten slopes which will provide greater roadside clearances and may sometimes eliminate the need for guardrail.
- 4) Reduce wetland taking in environmentally sensitive areas.

CRITERIA FOR ROADWAY TYPICAL SECTION AND SLOPES **1-2A****STANDARD METHOD OF CONSTRUCTING CUT AND FILL SLOPES**

(A) Interstates, Freeways, Expressways and other four-lane facilities

See 1-2A, F-1 (A).

(B) Collectors and Locals (4000 ADT or less Design Year Traffic)

See 1-2A, F-1(B).

NOTE: These guidelines (A and B) apply to new construction, not 3-R Projects or subdivision roads.

CRITERIA FOR ROADWAY TYPICAL SECTION AND SLOPES

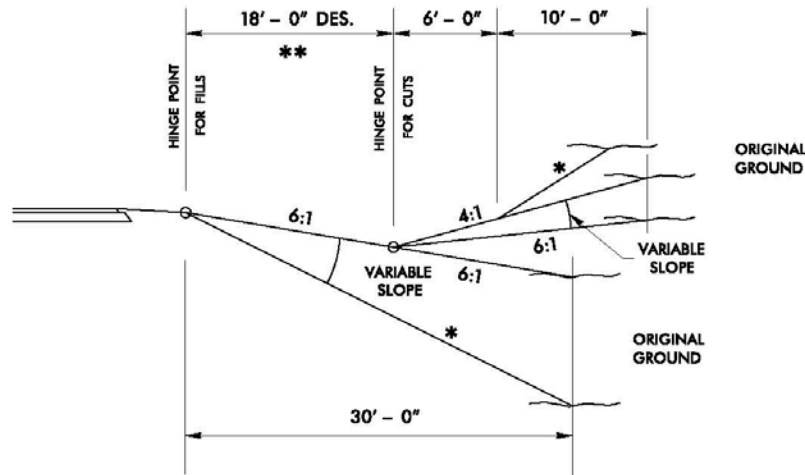
1 - 2A
F - 1(A) INTERSTATES, FREEWAYS, EXPRESSWAYS, OTHER FOUR LANE FACILITIES,
ARTERIALS, COLLECTORS AND LOCALS (OVER 4000 ADT DESIGN YEAR TRAFFIC)

(B) COLLECTORS AND LOCALS (4000 ADT OR LESS DESIGN YEAR TRAFFIC)

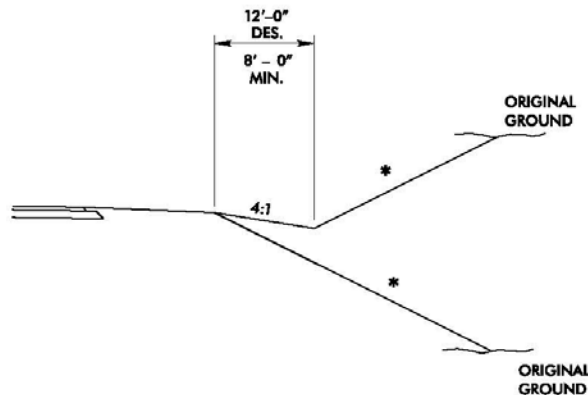

* THE STEEPEST PRACTICAL SLOPES AS DETERMINED BY THE GEOTECHNICAL UNIT SHOULD BE UTILIZED
INTERSTATE SIDE SLOPES SHOULD NOT BE STEEPER THAN 2:1 EXCEPT IN ROCK EXCAVATION
FREEWAYS AND EXPRESSWAYS SHOULD NOT BE STEEPER THAN 1 1/2:1 TO 2:1.

** 12' - 0" MIN. ARTERIALS, COLLECTORS, LOCAL OVER 4000 ADT
15' - 0" MIN. INTERSTATE, FREEWAY, EXPRESSWAY, FOUR LANE

A GUARDRAIL STUDY WILL BE REQUIRED FOR FILL SLOPES STEEPER THAN 3:1
SEE HIGHWAY DESIGN MANUAL, PART I, CHAPTER 3

FOR SHOULDER WIDTHS, SEE HIGHWAY DESIGN MANUAL, PART I, CHAPTER 1-4B, F-1.

TWO FOOT MINIMUM DITCH DEPTH REQUIRED TO COVER DRIVEWAY PIPE

**POSITIVE PAVEMENT DRAINAGE
RECOMMENDED FINAL TYPICAL SECTIONS****1-2B**1) 10' TO 22' MEDIANS

Use of the 10' minimum median width is limited to four-lane freeways that have significant right-of-way, terrain or environmental constraints that prohibit the use of the standard 22' or wider median. Future traffic volumes should indicate that additional travel lanes would not be needed within the foreseeable future. A median of this width will be paved with a concrete median barrier. The Pavement Management Unit will develop positive pavement drainage if necessary.

Use of the 22' width median with concrete barrier on new location or widening projects is limited to those projects that have significant right-of-way, terrain or environmental constraints that prohibit or restrict the use of the 46' or wider median. This width median has a concrete barrier and is paved with positive pavement drainage developed by the Pavement Management Unit if necessary.

2) 30' TO 36' MEDIANS

Use of this median width when widening an existing two-lane, two-way facility to four lanes with restricted right-of-way. Use this width only in cases where a 46' minimum width cannot be provided. The mainline pavement will normally have 6' median shoulders and a 5:1 median ditch slope. **Positive Drainage Treatment**, developed by the Pavement Management Unit and/or the Hydraulics Unit, will be necessary to adequately drain the subgrade since the recommended minimum of 18" below subgrade cannot be achieved with these median widths. The outside shoulder widths will be in accordance with Table 1-4B (Figure 1). The outside shoulder in fills and cuts will be constructed as shown on 1-2B (Figure 1).

3) 46' MEDIAN

This is the minimum median width used for freeways without a concrete median barrier and also the minimum width to be used on new location, non-freeway divided facilities. The 46' minimum width is used when significant right-of-way, terrain or environmental restraints prohibit or restrict the use of the standard 70' freeway median or the standard 60' non-freeway new location.

This median width is also the standard median width to be used when widening existing two-lane roadways to four-lane divided facilities. This median should be used only when significant right-of-way, terrain or environmental restraints prohibit the use of the desirable 60' median width.

POSITIVE PAVEMENT DRAINAGE**RECOMMENDED FINAL TYPICAL SECTIONS (continued)****1-2B**

The median should have 6' shoulders and a 6:1 median ditch slope. The outside widths will be in accordance with Table 1-4B (Figure 1). The outside shoulder in fills and cuts will be constructed as shown on 1-2B (Figure 2A or 2B).

4) 60' MEDIANS

Use this median for new location, non-freeway projects when significant right-of-way, terrain or environmental restraints are not present. This median width should also be used when widening existing two lane roadways to four-lane divided facilities and no design or environmental constraints exist to restrict widening beyond the standard 46' median. Future traffic projections should indicate that additional travel lanes would not be required in the foreseeable future. The median would have 10' shoulders and an 8:1 median ditch slope. The outside shoulder widths will be in accordance with Table 1-4B (Figure 1). The outside shoulder in fills and cuts will be constructed as shown 1-2B (Figure 3).

5) 70' MEDIANS

This is the standard median width for freeways. Use this median for all freeway facilities where traffic projections of future volumes indicate the need for two or more additional lanes within the foreseeable future or for four-lane freeways where significant right-of-way, terrain or environmental restraints are not present. The median should have 12' shoulders and an 8:1 median ditch slope. The outside shoulder width will be in accordance with Table 1-4B (Figure 1). The outside shoulder in fills and cuts will be constructed as shown 1-2B (Figure 4).

6) 23'-30' RAISED MEDIAN

Use this variable raised median width with collector and arterial streets. This typical section should be used in cases where significant right of way, terrain, or environmental restraints prohibit or restrict the use of a 46' median. Ideally, 23' should be the minimum median width allowed for proper intersection treatments including the channelization of left-overs. The outside shoulder widths should be in accordance with 1-4B Figures 1 and 1A. The outside shoulder in fills and cuts will be constructed as shown 1-2B (Figure 5).

PAVEMENT DRAINAGE**RECOMMENDED FINAL TYPICAL SECTIONS (continued)****1-2B**

GENERAL COMMENTS TO BE INCLUDED WITH ATTACHED TYPICAL SECTIONS:

- a) The minimum median width is 46' for all divided facilities without a concrete median barrier and should be the minimum provided when possible. The 10' to 22' freeway median with a concrete barrier is intended for use only where rugged terrain, restricted right-of-way or significant environmental constraints prohibit the use of the 46' or wider median. The 30' – 36' median is intended for use only when widening existing two-lane, two-way facilities to four lanes with very restricted right-of-way. The 60' median should be used on non-freeway facilities when there is no likelihood of needing future median lanes. The 70' median is to be used for freeway facilities that will require additional median lanes in the foreseeable future or where significant environmental, right-of-way, and terrain restraints are not present.
- b) Refer to the paved shoulder policy for paved shoulder widths. For turf shoulders, the maximum cross slope is 0.08 and for paved shoulders, greater than 2', the slope will vary from 0.02 to 0.04.
- c) In Superelevated areas, the median slope may be steepened to a maximum slope of 4:1 to obtain a ditch grade that will drain.
- d) In areas where fill is necessary, the outside shoulders are as shown on Typical Sections. When guardrail is required, the fill shoulder will be widened 3' beyond the face of the guardrail. (See detail Typical Section, 1-2A, Figure 1A).
- e) **Positive Drainage Treatment** is required when the ditch is less than 18" below the subgrade at the edge of the nearest traffic lane. The Positive Drainage Treatment should be obtained from the Pavement Management Unit. This treatment must be a median underdrain or a minimum roadway grade of 1% in satisfactory drainage soils, or 1.5% in soils, which do not have satisfactory drainage properties. If marginal situations occur, appropriate median drainage structures should be placed to provide adequate ditch drainage.
- f) When proposing a 70' median and two additional lanes (lanes five and six) are imminent in the foreseeable future, the grade point should be placed at the "future" median edge of pavement. (See detail on Typical Section, 1-2B, Figure 4). This cross slope should be 0.02 to the outside. If additional lanes (lanes seven and eight) are added, the slope of the lanes should be toward the median. The median shoulder will have a 0.08 slope when a turf shoulder is used.

FIGURE 1

1-2B
F - 1

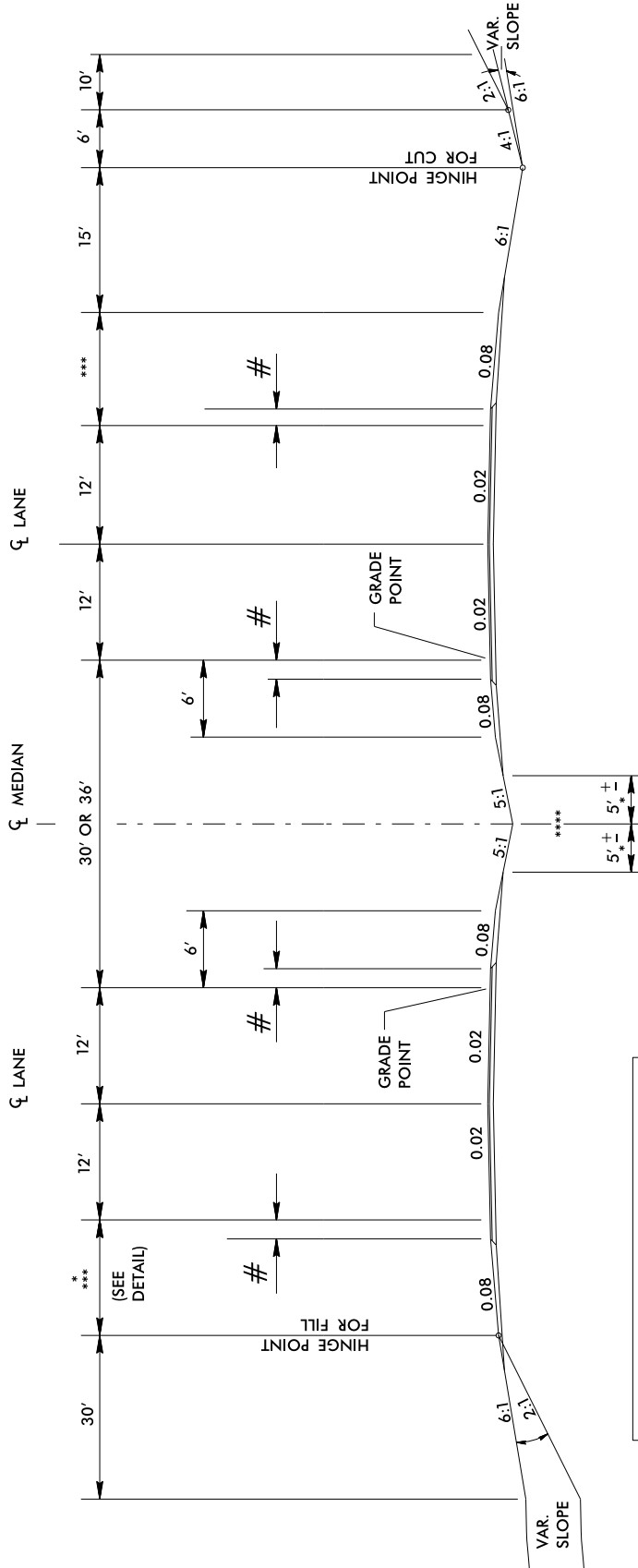

30' - 36' MEDIAN

USE WHEN WIDENING EXISTING TWO LANE - TWO WAY FACILITY TO FOUR LANES WITH VERY RESTRICTED RW AND THE MINIMUM 46' MEDIAN CANNOT BE PROVIDED.

**** REQUIRES POSITIVE DRAINAGE TREATMENT TO ADEQUATELY DRAIN THE SUBGRADE. THE DETAIL SHOULD BE OBTAINED FROM THE PAVEMENT MANAGEMENT UNIT.

* USE FINISHED SLOPE ±5' FROM ζ OF MEDIAN DITCH IN ORDER THAT DRAINAGE STRUCTURES CAN BE CONSTRUCTED AT THE FINAL ELEVATION ON GRADING PROJECTS.

** SLOPES MAY BE VARIED DURING DESIGN TO 6:1 MINIMUM.

*** SEE ROADWAY DESIGN MANUAL PART 1, CHAPTER 1-4B, F-1.

SEE ROADWAY DESIGN MANUAL PART 1, CHAPTER 1-4C.

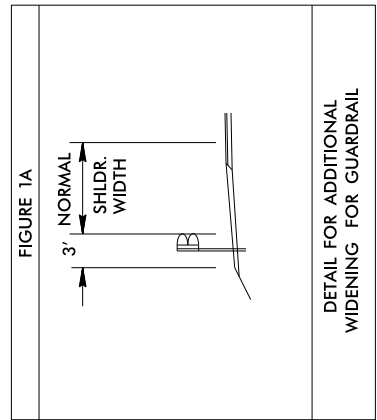

30' - 36' MEDIANS

FIGURE 2A

1-2B
FIG. 2A

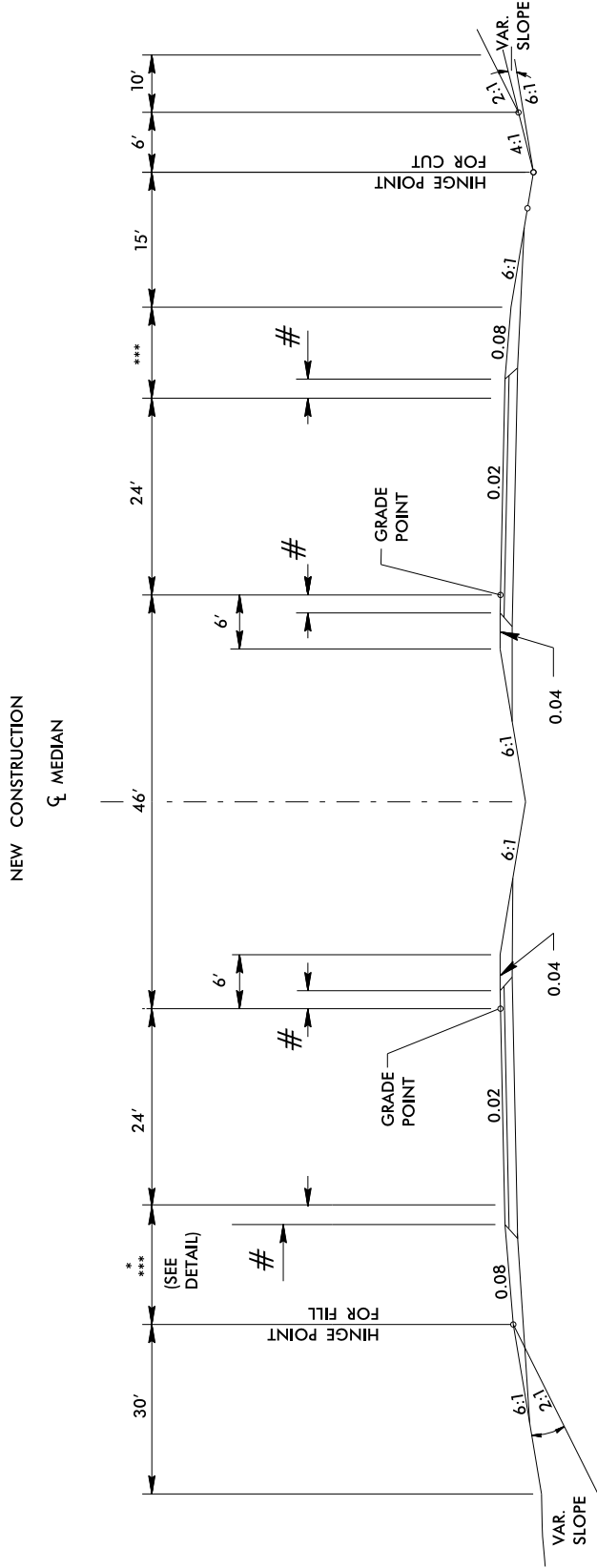

46' MEDIAN (MINIMUM)
USE WHEN THERE ARE EXISTING
RIGHT OF WAY & TERRAIN
CONSTRAINTS

NOTE: FOR GUIDE TO DRAINAGE SUBGRADE AND SHOULDER
SUBGRADE SEE ROADWAY STANDARD DRAWINGS No. 225.01, 225.02.

* FOR GUARDRAIL WIDENING DETAIL,
SEE FIGURE 1A.

*** SEE ROADWAY DESIGN MANUAL PART 1, CHAPTER 1-4B, F-1.

SEE ROADWAY DESIGN MANUAL PART 1, CHAPTER 1-4O.

46' MEDIAN (MINIMUM)

FIGURE 2B

1-2B
FIG. 2B

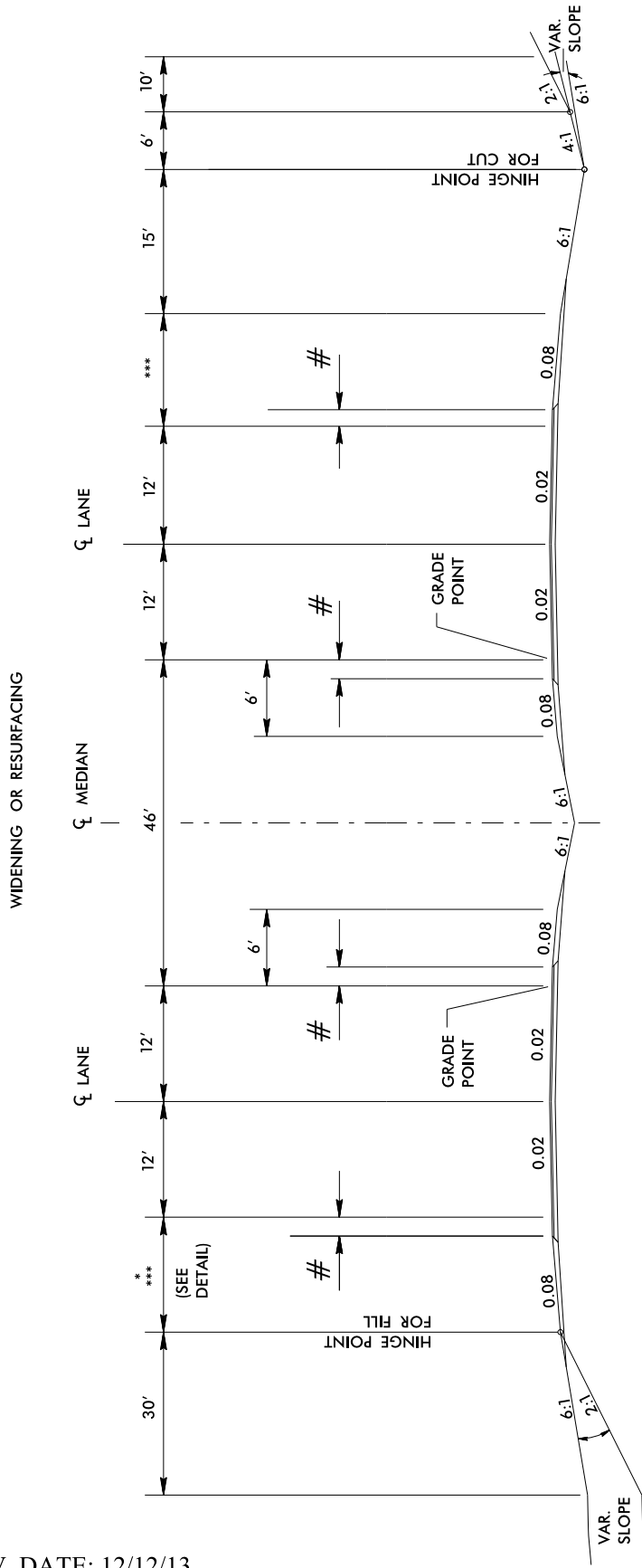

NOTE: FOR GUIDE TO DRAINAGE SUBGRADE AND SHOULDER
SUBGRADE SEE ROADWAY STANDARD DRAWINGS No. 225.01, 225.02.

* FOR GUARDRAIL WIDENING DETAIL,
SEE FIGURE 1A.

*** SEE ROADWAY DESIGN MANUAL PART 1, CHAPTER 1-4B, F-1.

SEE ROADWAY DESIGN MANUAL PART 1, CHAPTER 1-4C.

46' MEDIAN (MINIMUM)

FIGURE 3

1-2B

FIG. 3

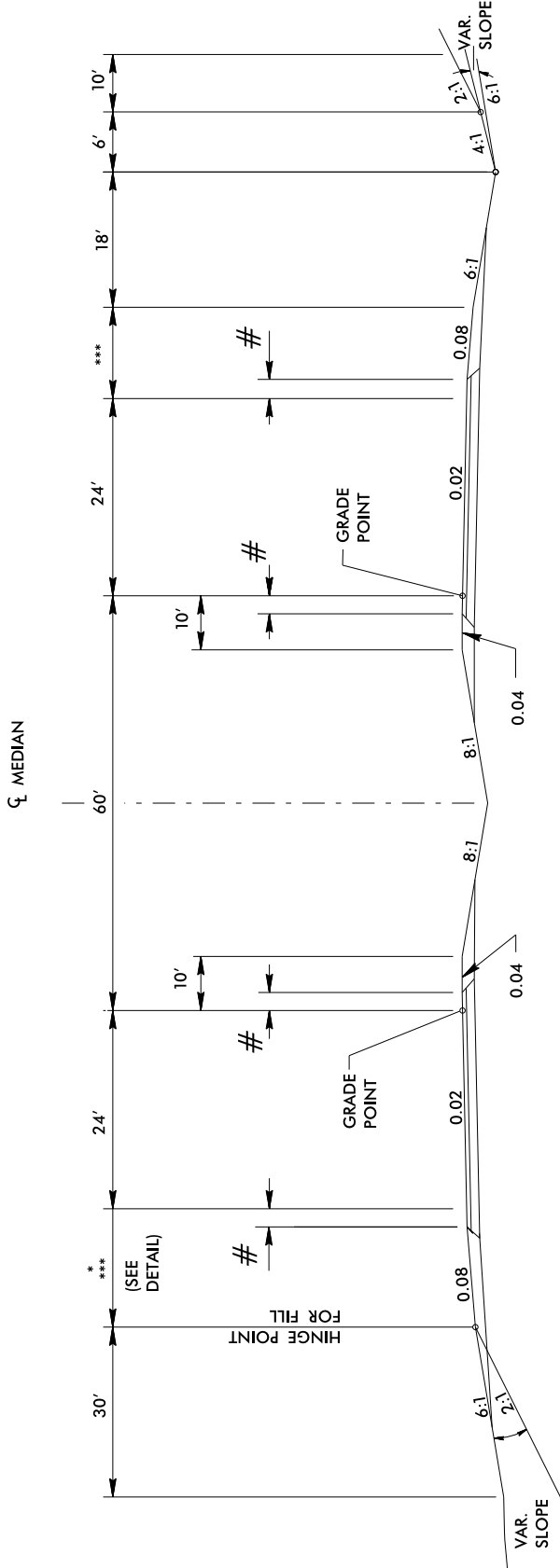

NOTE: FOR GUIDE TO DRAINAGE SUBGRADE AND SHOULDER SUBGRADE SEE ROADWAY STANDARD DRAWINGS No. 225.01, 225.02.

* FOR GUARDRAIL WIDENING DETAIL, SEE FIGURE 1A.

*** SEE ROADWAY DESIGN MANUAL PART 1, CHAPTER 1-4B, F-1.

SEE ROADWAY DESIGN MANUAL PART 1, CHAPTER 1-40.

60' MEDIAN (MINIMUM DESIRABLE)

USE THIS MEDIAN WIDTH WHEN RIGHT OF WAY PERMITS MORE THAN THE MINIMUM MEDIAN WIDTH AND THE PROJECTED TRAFFIC VOLUMES INDICATE THAT NO FUTURE LANES WILL BE REQUIRED.

60' MEDIAN (MINIMUM DESIRABLE)

FIGURE 4

1-2B
FIG. 4

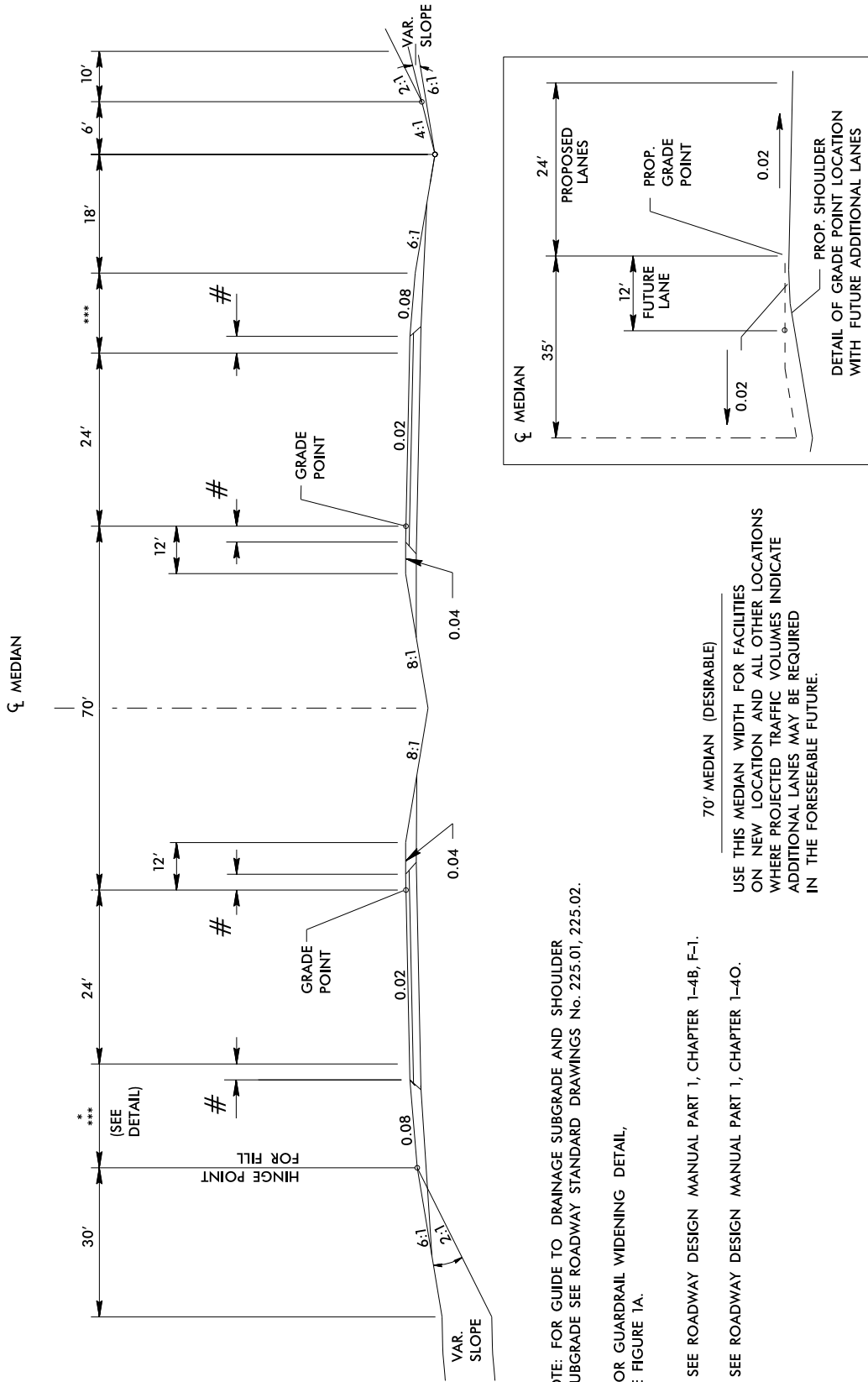

NOTE: FOR GUIDE TO DRAINAGE SUBGRADE AND SHOULDER SUBGRADE SEE ROADWAY STANDARD DRAWINGS No. 225.01, 225.02.

* FOR GUARDRAIL WIDENING DETAIL, SEE FIGURE 1A.

*** SEE ROADWAY DESIGN MANUAL PART 1, CHAPTER 1-4B, F-1.

SEE ROADWAY DESIGN MANUAL PART 1, CHAPTER 1-4O.

70' MEDIAN (DESIRABLE)

USE THIS MEDIAN WIDTH FOR FACILITIES ON NEW LOCATION AND ALL OTHER LOCATIONS WHERE PROJECTED TRAFFIC VOLUMES INDICATE ADDITIONAL LANES MAY BE REQUIRED IN THE FORESEEABLE FUTURE.

70' MEDIAN (DESIRABLE)

FIGURE 5

1-2B

FIG. 5

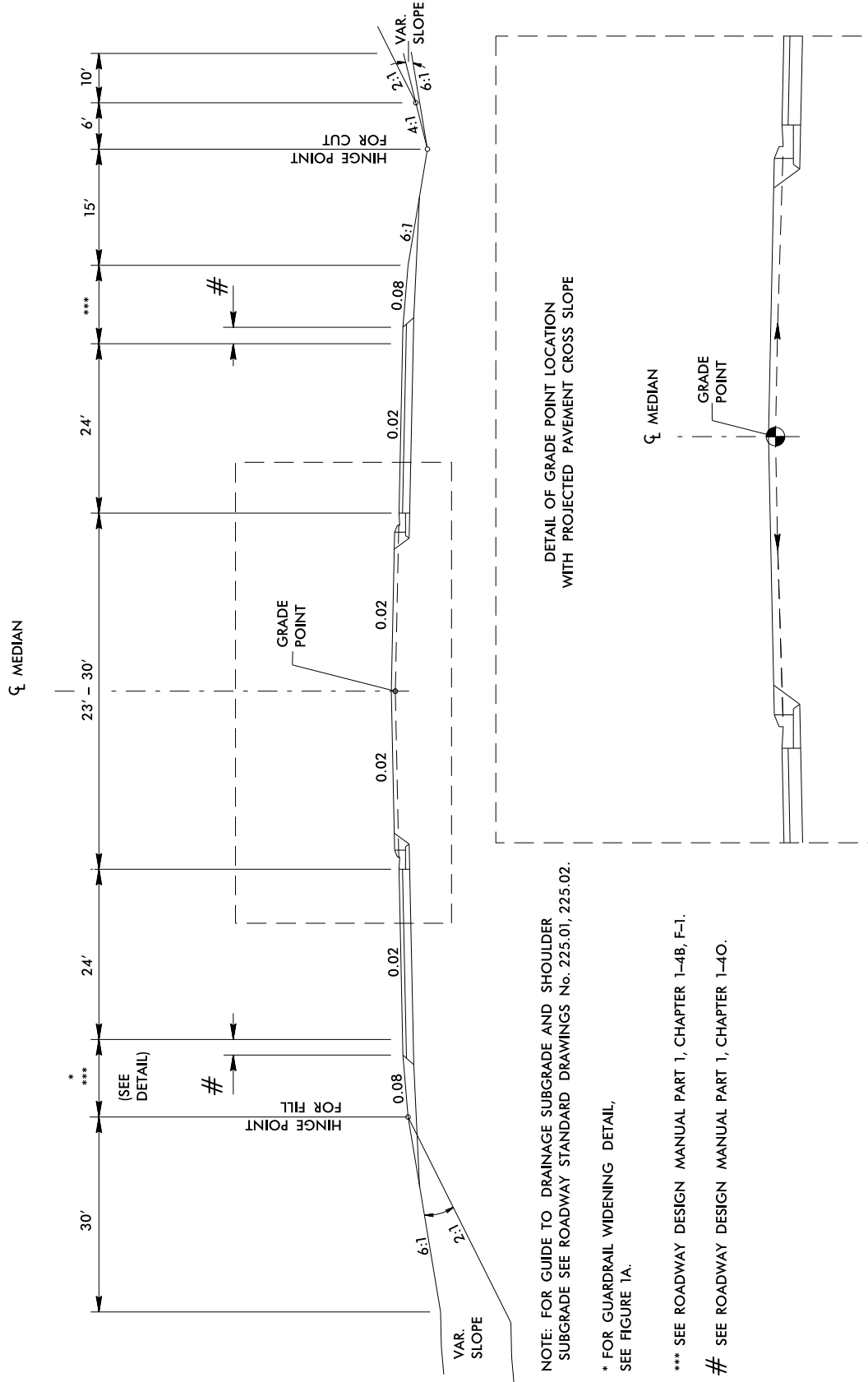

NOTE: FOR GUIDE TO DRAINAGE SUBGRADE AND SHOULDER SUBGRADE SEE ROADWAY STANDARD DRAWINGS No. 225.01, 225.02.

* FOR GUARDRAIL WIDENING DETAIL, SEE FIGURE 1A.

*** SEE ROADWAY DESIGN MANUAL PART 1, CHAPTER 1-4B, F-1.

SEE ROADWAY DESIGN MANUAL PART 1, CHAPTER 1-4O.

23' - 30' RAISED MEDIANS

PAVEMENT**1-3****LANE WIDTHS (SHOULDER SECTION)****1-3A**

For capacity purposes and when feasible, lane widths should be 12' to provide the highest level of service. However, on some urban projects, the lane widths may have to be reduced to 11'. For minimum pavement widths, which are based on design speeds and traffic volumes, see 1-13, Part I of this Manual.

LANE WIDTHS (CURB & GUTTER SECTIONS)**1-3AA**

The maximum curb and gutter section shall be 64' face to face for five lane sections.

The minimum curb and gutter section shall be 59' face to face for five lane sections. This section should be used only where right of way is a major factor and where the truck traffic is less than 5% of the DHV during the design year.

Curb and gutter sections that deviate from those stated above must receive approval from the State Highway Design Engineer.

PAVEMENT SURFACE SLOPE**1-3B**

The normal crown slope is 0.02 for all pavement compositions (*See Below). It is of utmost importance to show a grade point on the typical section so the Engineer will know where this slope is to begin.

For a normal two lane roadway, the grade point is on the centerline with conventional "Roof Top" slopes. In locations where two lanes of a future four lane section are being constructed, a "Roof Top" slope shall also be used.

On a divided section when two or three lanes are being constructed in each direction initially, the grade point is always on the median edge of the lane. In a normal crown section, all lanes will be sloped in the same direction from the pavement edge adjacent to the median to the outside edge of pavement. In the future when lanes are constructed in the median, the additional lane or lanes shall slope to the median.

On a divided section when two lanes are being constructed in each direction initially and provisions are being made to add a maximum of two lanes in each direction in the median, the initial lanes being constructed shall slope away from the edge of median. The future inside lanes shall slope into the median.

*Except for roadways east of I-95 and other roadways with consistently flat grades. Pavement slope should be 0.025 (0.025 is not to be used on two lane roadways or on four lane roadways with each lane crowned at the centerline of pavement).

PAVEMENT SURFACE SLOPE (continued)**1-3B**

When grades are being computed in locations where future lanes will be constructed in the median, extreme care shall be taken in computing the grades to ensure that the future construction can be accommodated. In superelevated sections, and especially where structures are located, it may be necessary to set separate grades. In these locations, it will be necessary to make sure that the relative grades of the inside edges of the future lanes will allow future ditches or median barriers to be constructed.

PAVEMENT COMPOSITION**1-3C**

The proposed pavement design will be in accordance with the pavement design prepared by the State Pavement Management Engineer and approved by the Pavement Design Review Committee. See Policy and Procedure Manual, 13/1. For constructability, consideration should be given to total depth of surface and intermediate courses with curb and gutter to be equal the depth of gutter at the edge of pavement.

EXISTING PAVEMENT**1-3D**

Resurfacing recommendations will be included in the pavement design. On widening projects, it may be necessary to establish a grade line.

PAVEMENT EDGE CONSTRUCTION**1-3E**

Unless otherwise instructed by the State Pavement Management Engineer, pavement edge construction shall be treated as shown in 1-3E, Figure 1 (E-1 thru E-4).

It is not necessary to tie down edge of pavement transitions with computed alignment on most projects. Adequate straight line tapers or degree of curve designations without computed alignment, but with controlling dimensions, will serve adequately.

PAVEMENT EDGE CONSTRUCTION

1-3E
F-1

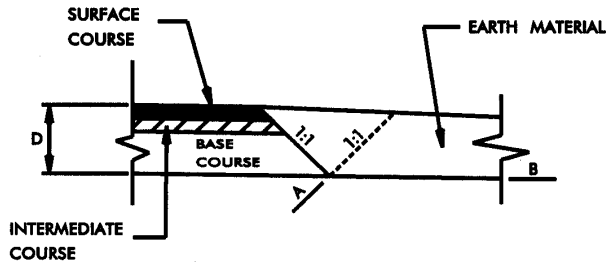

ALL ASPHALT

E-1

- A TRENCH SECTION
WHEN D=10" OR LESS
- B GRADED SECTION
WHEN D=OVER 10"

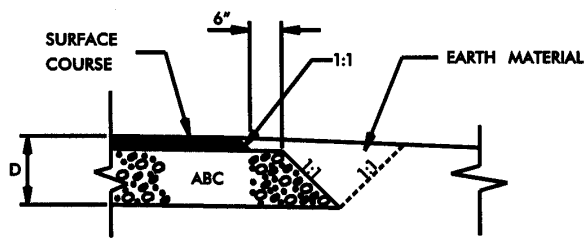

AGGREGATE BASE

E-2

TRENCH SECTION
WHEN D=10" OR LESS

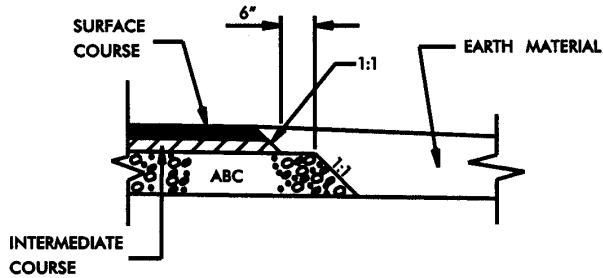

AGGREGATE BASE

E-3

GRADED SECTION

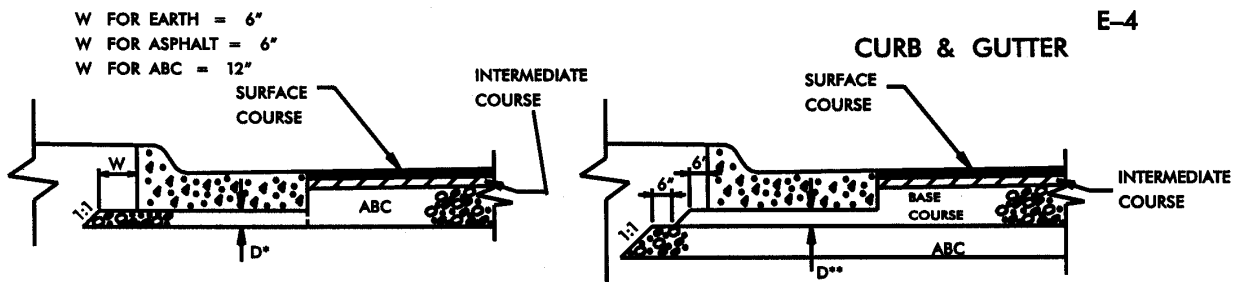

CURB & GUTTER

E-4

- W FOR EARTH = 6"
- W FOR ASPHALT = 6"
- W FOR ABC = 12"

* WHEN D IS LESS THAN 3" THE CURB & GUTTER WILL BE PLACED ON SUBGRADE.
** ASPHALT BASE - HB IS TO BE USED UNDER CURB & GUTTER WHEN D=2 1/2" OR MORE.

PAVEMENT ALTERNATE BASE COURSE MATERIALS**1-3F**

Some major new location and existing two lane facilities widened to four lanes will require alternate base course materials. The alternate base course recommendation will allow the contractor the choice to construct either a pavement with aggregate base course or asphalt concrete base course. The Pavement Management Unit will select which projects require alternate base course materials and specify these bases in the pavement design recommendations sent to the Roadway Design Unit.

The roadway typical sections should show the aggregate base course design. Details or insets should supplement the typical sections showing the asphalt concrete base course alternate. (See 1-3F, Figure 1). The Pavement Management Unit will furnish the applicable shoulder drain designs for each alternate design. When coordinating with other units, specify that all work related to Geotechnical Engineering, Hydraulics and Utilities be performed assuming the aggregate base course alternate will be constructed.

Earthwork quantities are required for both alternates. However, plans will include a single earthwork summary based on the aggregate base course alternate with a line item added to the bottom of the earthwork summary showing the differential volumes of the alternate design. Submit a combined balance summary sheet of both alternates to the Geotechnical Engineering Unit for use in preparing subsurface plans (See 1-3F, Figure 1A).

Use the aggregate base course alternate to prepare cross sections with a note on all the cross section summary sheets and the first cross section sheet (in addition to other standard notes) as follows:

“The cross sections reflect the aggregate base course alternate.”

Any pay item quantities affected by the alternate base course materials should be computed and shown on the estimate within the alternate in which they apply. Some possible pay items required to be shown within each alternate are unclassified excavation, borrow excavation (borrow projects), aggregate base course, asphalt concrete, asphalt binder, prime coat and shoulder borrow (waste projects).

PAVEMENT ALTERNATE BASE COURSE MATERIALS

1-3F

F-1

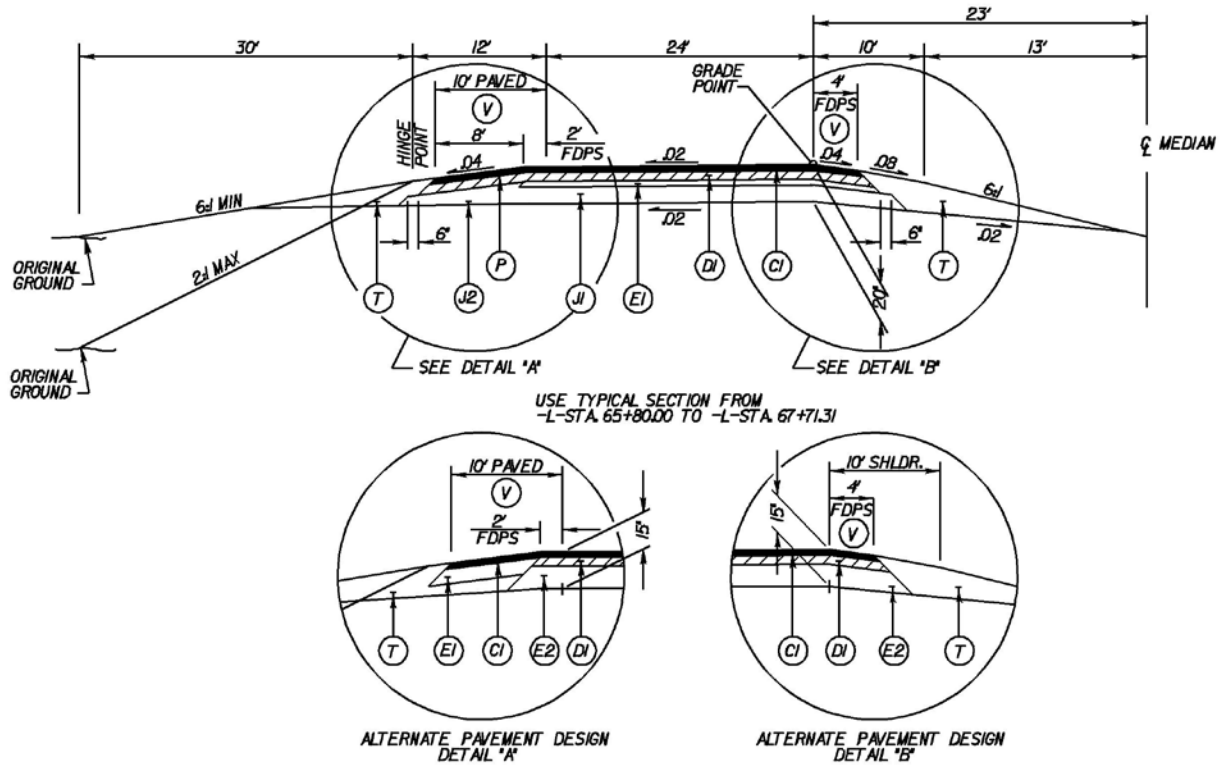

PAVEMENT SCHEDULE	
(C1)	PROP. APPROX 3" ASPHALT CONCRETE SURFACE COURSE, TYPE S9.5B AT AN AVERAGE RATE OF 168 LBS. PER SQ YARD IN EACH OF TWO LAYERS.
(D1)	PROP. APPROX 4" ASPHALT CONCRETE INTERMEDIATE COURSE, TYPE I19.0B AT AN AVERAGE RATE OF 456 LBS. PER SQ YARD.
(E1)	PROP. APPROX 5" ASPHALT CONCRETE BASE COURSE, TYPE B25.0B AT AN AVERAGE RATE OF 570 LBS. PER SQ YARD.
(E2)	PROP. APPROX 8" ASPHALT CONCRETE BASE COURSE, TYPE B25.0B AT AN AVERAGE RATE OF 456 LBS. PER SQ YARD, IN EACH OF TWO LAYERS.
(J1)	PROP. APPROX 8" AGGREGATE BASE COURSE.
(J2)	PROP. VARIABLE DEPTH AGGREGATE BASE COURSE.
(P)	PRIME COAT AT THE RATE OF 0.35 GALLONS PER SQ YARD.
(T)	EARTH MATERIAL
(V)	RUMBLE STRIP

ROADWAY DESIGN MANUAL

PART I

1 - 3F

F - 1A

LOCATION	UNCL. EXCAVATION	UNDERCUT	EMBT+%	BORROW	WASTE
SUMMARY NO. 1					
-L- 11+98.803 TO 19+00.000	163,668		2,638		161,030
-Y- 10+00.000 TO 13+40.000	3,850		554		3,296
-T- 10+00.000 TO 12+26.533	1,395		107		814
-T- 13+03.733 TO 14+20.000	507		107		400
-YI DEF- 10+42.365 TO 14+16.948	2,827		4,504	1,677	
DETOUR REMOVAL			3,062	5,662	
SUMMARY NO. 1 TOTAL	172,247		11,446	4,739	165,540
SUMMARY NO. 2					
-L- 19+00.000 TO 26+17.519 L.B.	24,365		145,723	121,358	
SUMMARY NO. 2 TOTAL	24,365		145,723	121,358	
SUMMARY NO. 3					
-L- 25+77.860 L.A. TO 35+00.000	168,012	1,300	106,846		60,466
-Y2- 10+00.000 TO 13+07.000	5,013		6,870	1,857	
-Y2- 14+20.000 TO 17+39.078	768	600	24,275	23,507	600
SUMMARY NO. 3 TOTAL	173,793	1,900	139,991	25,364	61,066
SUMMARY NO. 4					
-L- 35+00.000 TO 44+00.000	343,420		35,086		308,334
-Y3- 10+00.000 TO 12+26.944	1,633		971		662
-Y3- 13+02.264 TO 14+54.746	1,097		690		407
-Y4- 10+00.000 TO 16+55.785	4,324		26,150	21,826	
-DET2- 12+37.210 TO 15+52.083	5,014		451		4,563
-DET3- 12+51.082 TO 12+95.313	84		0		84
SUMMARY NO. 4 TOTAL	355,572		63,348	21,826	314,050
SUMMARY NO. 5					
-L- 44+00.000 TO 53+00.000	396,205	9,200	54,924		350,476
-Y5- 10+00.000 TO 19+45.115	5,219	800	1,930		4,089
-RPE- 11+53.455 TO 15+26.124	21,810		27,978	6,168	
-RPE- 11+94.366 TO 14+94.366	543		32,014	31,471	
-LPE- 10+167.281 TO 12+51.310	0		62,292	62,292	
-LPC- 10+43.870 TO 12+30.352	5,399		30,923	25,524	
-Y1- 12+76.258 TO 18+50.983	45,289		151,585	106,296	
-Y6- 13+38.426 TO 20+00.000	15,910		17,508	4,598	
-Y6- 21+607.169 TO 28+00.000	25,899		47,316	21,417	
-Y6- 28+00.000 TO 36+00.000	25,504		47,426	21,922	
-Y6- 36+00.000 TO 45+00.000	9,727		106		9,621
-Y6- 45+00.000 TO 49+70.000	1,887	10,000	419	1,468	
SUMMARY NO. 5 TOTAL	550,392	10,000	474,226	279,488	345,654

LOCATION	UNCL. EXCAVATION	UNDERCUT	EMBT+%	BORROW	WASTE
SUMMARY NO. 6					
-L- 53+00.000 TO 61+00.000	25,225		196,495	171,270	
-RPA- 11+14.406 TO 14+23.096	0		96,872	96,872	
-RPA- 11+30.762 TO 14+87.240	35,027		10,250		24,777
-LPA- 10+34.446 TO 12+28.790	0		56,553	56,553	
-FY- 20+12.463 TO 21+45.965	48		57,430	57,382	
-FY- 22+45.366 TO 27+05.979	28,653		124,376	95,723	
-Y6- 21+75.818 TO 28+00.000	30,058		40,392	10,334	
-Y6- 28+00.000 TO 37+00.000	54,683		35,752		18,931
-Y6- 37+00.000 TO 45+80.000	10,026		632		9,394
SUMMARY NO. 6 TOTAL	210,433		639,484	487,664	
SUMMARY TOTALS	1,486,802	11,900	1,444,318	940,439	974,923
ADDITIONAL UNDERCUT		7,000	8,400	8,400	7,000
LOST DUE TO CLEAR. & GRUB.	-15,000			15,000	
ROCK WASTE IN LIEU OF BORROW				-18,524	-18,524
EARTH WASTE IN LIEU OF BORROW				-948,644	-948,644
ADJ. FOR ROCK WASTE			-2,705	-2,705	
SHOULDER MATERIAL			72,600	72,600	
PROJECT TOTALS	1,471,802	18,900	1,542,513	71,566	19,755
EST. TO REPLACE TOP					
SOIL ON BORROW PITS				3,678	
GRAND TOTALS	1,471,802	18,900	1,544,718	75,144	19,755
PAV'T STRUCTURE VOLUME -L- +40.441 CU Yds.				75,200	
EARTHWORK TOTALS FOR ALTERNATE PAV'T DESIGN					
SUMMARY TOTALS	1,466,802	11,900	1,444,718	940,439	974,923
ADJ. FOR ALT. PAV'T DESIGN	-16,000		10,122	10,122	-16,000
ADDITIONAL UNDERCUT		7,000	8,400	8,400	7,000
LOSS DUE TO CLEAR. & GRUB.	-15,000			15,000	
ROCK WASTE IN LIEU OF BORROW				-18,524	-18,524
EARTH WASTE IN LIEU OF BORROW				-932,644	-932,644
ADJUSTMENT FOR ROCK WASTE			-2,705	-2,705	
SHOULDER MATERIAL			72,600	72,600	
PROJECT TOTALS	1,455,802	18,900	1,534,485	79,538	19,755
EST. TO REPLACE TOP				3,977	
SOIL ON BORROW PITS				83,515	
TOTAL	1,455,802	18,900	1,535,977	83,515	19,755
PAV'T STRUCTURE VOLUME -L- +40.441 CU Yds.				83,600	

STATE OF NORTH CAROLINA
DIVISION OF HIGHWAYS
SUMMARY OF EARTHWORK
IN CUBIC YARDS

NOTE: Earthwork quantities are calculated by the Roadway Design Unit. These earthwork quantities are based in part on substructure data provided by the Geotechnical Engineering Unit.

* PAVEMENT STRUCTURE VOLUME 40,441 cu yds.
** FOR ALTERNATE PAVEMENT DESIGN 29,956 cu. yds.

SHOULDERS**1-4**

Paved or unpaved shoulders will be based on traffic volume warrants and the pavement composition of the adjacent pavement utilized for the mainline, ramp and etc. Figure 1-4F outlines typical paved shoulder construction. The pavement design report will specify the type of paved shoulder to construct. All utility poles shall be placed outside the Clear Zone as defined by the 2011 Roadside Design Guide.

SHOULDER WIDTHS ON MAINLINE**1-4A**

See 1-4B (Figure 1) for usable and graded shoulder widths for local, collector, arterial, interstate and freeway roads.

NOTE: Due to frequent on-shoulder parking and other special design features, Subdivision Roads and Streets shall conform to NCDOT Subdivision Roads Minimum Construction Standards and may not conform to the above design guidelines.

USABLE AND GRADED SHOULDERS**1-4B**

See 1-4B (Figure 1) for usable and graded shoulder widths and their relationship to the overall shoulder width. Shoulders shall not exceed these values unless specified otherwise in the Planning Report or unless approved by the Assistant State Roadway Design Engineer.

NOTE: These guidelines apply to new construction, not 3-R projects.

When guardrail is required on a project, additional shoulder width, as noted in Figure 1, is needed for guardrail installation and clearance. At times, this added shoulder width is continued throughout the project for uniformity. As a cost-reduction measure, normal shoulder widths should be specified where guardrail is not required and then transitioned to wider shoulders where guardrail is required. Engineering judgement would be used in considering this method by taking into account the length of the project and the amount of guardrail required.

USABLE AND GRADED SHOULDERS (continued)**1-4B****FIGURE 1****1-4 B****SHOULDER WIDTHS****LOCALS AND COLLECTORS**

IN THE DESIGN OF LOCALS AND COLLECTORS, USE THE FOLLOWING MINIMUM SHOULDER WIDTHS.

ADT	DESIGN YEAR			
	UNDER 400	400 - 1500	1501- 2000	OVER 2000
LOCALS AND COLLECTORS	* 2'	** 5'	6'	8'

* WHEN GUARDRAIL IS WARRANTED, THE MINIMUM OFFSET FROM THE EDGE OF THE TRAVEL LANE TO THE FACE OF THE GUARDRAIL IS 4'-0".

** WHERE ENVIRONMENTAL CONSTRAINTS ALLOW, 6-FOOT SHOULDERS SHOULD BE UTILIZED RATHER THAN THE 5-FOOT SHOULDERS.

See "A POLICY ON GEOMETRIC DESIGN OF HIGHWAYS AND STREETS", (2011) TABLES 5-5 AND 6-5.

USABLE AND GRADED SHOULDERS (continued)**1-4B****Table 5.5 Local Roads - Minimum Width of Traveled Way and Shoulders**

US Customary				
Design speed (mph)	Minimum width of traveled way (ft) for specified design volume (veh/day)			
	under 400	400 to 1500	1500 to 2000	over 2000
15	18	20 ^a	20	22
20	18	20 ^a	22	24 ^b
25	18	20 ^a	22	24 ^b
30	18	20 ^a	22	24 ^b
40	18	20 ^a	22	24 ^b
45	20	22	22	24 ^b
50	20	22	22	24 ^b
55	22	22	24 ^b	24 ^b
60	22	22	24 ^b	24 ^b
65	22	22	24 ^b	24 ^b
All speeds	Width of graded shoulder on each side of the road (ft)			
	2	5 ^{a,b}	6	8

^a For roads in mountainous terrain with design volume of 400 to 600 veh/day, use 18-ft traveled way width and 2-ft shoulder width.

^b Where the width of the traveled way is shown as 24 ft, the width may remain at 22 ft on reconstructed highways where there is no crash pattern suggesting the need for widening

^c May be adjusted to achieve a minimum roadway width of 30 ft for design speeds greater than 40 mph.

USABLE AND GRADED SHOULDERS (continued)**1-4B****Table 6-5. Collector Roads - Minimum Width of Traveled Way and Shoulders**

US Customary				
Design speed (mph)	Minimum width of traveled way (ft) for specified design volume (veh/day) ^a			
	under 400	400 to 1500	1500 to 2000	over 2000
20	20 ^b	20	22	24
25	20 ^b	20	22	24
30	20 ^b	20	22	24
35	20 ^b	22	22	24
40	20 ^b	22	22	24
45	20	22	22	24
50	20	22	22	24
55	22	22	24	24
60	22	22	24	24
65	22	22	24	24
All speeds	Width of shoulder on each side of road (ft)			
	2.0	5.0 ^c	6.0	8.0

^a On roadways to be reconstructed, a 22-ft traveled way may be retained where the alignment is satisfactory and there is no crash pattern suggesting the need for widening

^b A 18 ft minimum width may be used for roadways with design volumes under 250 veh/day.

^c Shoulder width may be reduced for design speeds greater than 30 mph provided that a minimum roadway width of 30 ft is maintained.

Notes: See text for roadside barrier and off-tracking considerations.

USABLE AND GRADED SHOULDERS (continued)

1-4B

MINIMUM SHOULDER

M = MINIMUM SHOULDER
EOT = EDGE OF TRAVEL LANE

WITHOUT GUARDRAIL

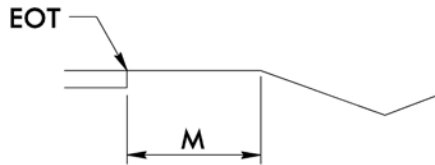

WITH GUARDRAIL

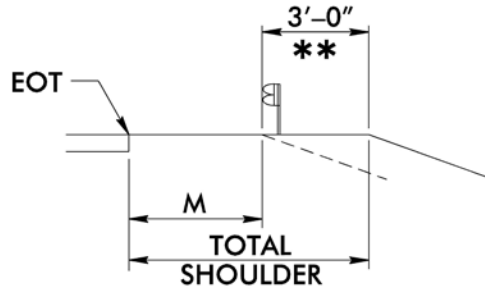

**** WHEN GUARDRAIL IS WARRANTED, THE MINIMUM SHOULDER WIDTH IS INCREASED BY 3'-0" AS SHOWN IN THE ABOVE DIAGRAM.**

FIGURE 1A

1-4B
F-1A

SHOULDER WIDTHS

ARTERIALS, INTERSTATES, AND FREEWAYS

IN THE DESIGN OF ARTERIALS, INTERSTATES AND FREEWAYS,
USE THE FOLLOWING MINIMUM USABLE SHOULDER WIDTHS.

ADT	DESIGN YEAR			
	UNDER 400	400 – 1500	1501 – 2000	OVER 2000
ARTERIALS	4'	6'	6'	8' **

NOTE: SEE " A POLICY ON GEOMETRIC DESIGN OF HIGHWAYS AND STREETS" (2011), Table 7-3

** 10' ON FREEWAYS, EXPRESSWAYS, AND INTERSTATES AND 12' ON FREEWAYS AND INTERSTATES WHEN TRUCK DHV EXCEEDS 500.

USABLE SHOULDER

U = USABLE SHOULDER

EOT = EDGE OF TRAVEL LANE

WITHOUT GUARDRAIL

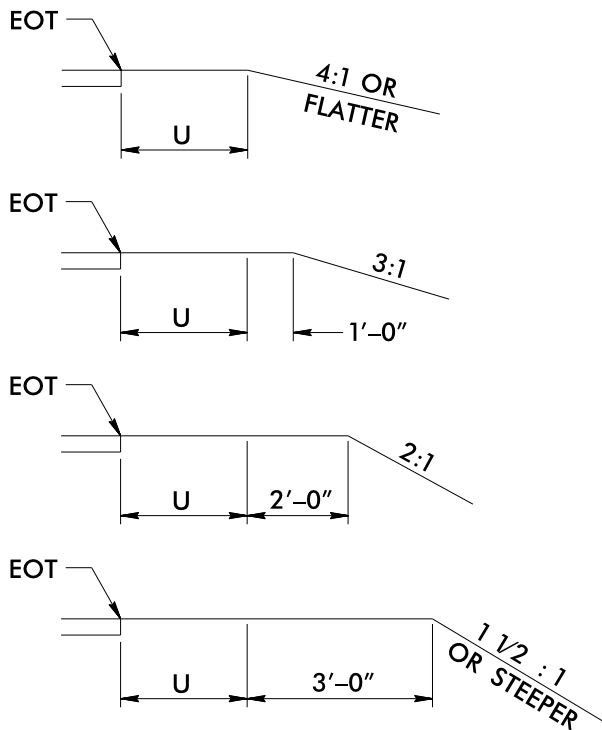

WITH GUARDRAIL

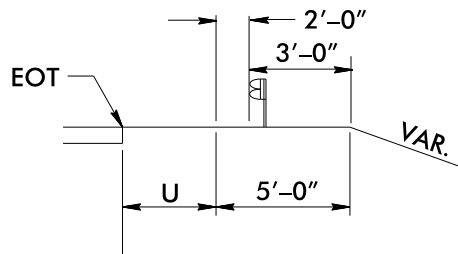

N.C. DOT PAVED SHOULDER POLICY**1-4C**

The NCDOT Paved Shoulder Policy incorporates the findings of an in-depth study of construction, maintenance, safety, operational and economic issues related directly to the usage of paved shoulders. The economics of providing a safe overall highway system were also considered in determining an appropriate level of expenditure for this design feature. The resultant policy is a standardized method developed specifically for the purpose of consistently providing acceptable paved shoulder designs for each roadway classification. Engineering judgement may be used to determine the need for a higher type shoulder design than is required by this policy on a case-by-case basis. Usage of paved shoulder widths in excess of the requirements of this policy must be approved by the State Roadway Design Engineer. See 1-4O, and 1-4O, Figure 1, of this manual for additional information.

SHOULDER WIDTH ON LOOPS**1-4D**

Inside Shoulder – 14' Des. 12' Min. (Right Side of Traffic)
Outside Shoulder – 12' Des. 10' Min. (Left Side of Traffic)

If pavement widening is required, it shall be placed on the inside of the curve. The 2'-6" concrete curb and gutter is placed adjacent to the inside edge of pavement to control drainage and reduce shoulder maintenance. See Chapter 8-1 of this manual for loop pavement widths.

SHOULDER WIDTHS ON RAMPS**1-4E**

Inside Shoulder – 12' Des. 10' Min. (Left Side of Traffic)
Outside Shoulder – 14' Des. 12' Min. (Right Side of Traffic)

See Chapter 8-2 of this manual for ramp pavement widths.

PAVED SHOULDERS WITH FLEXIBLE PAVEMENT

1-4F

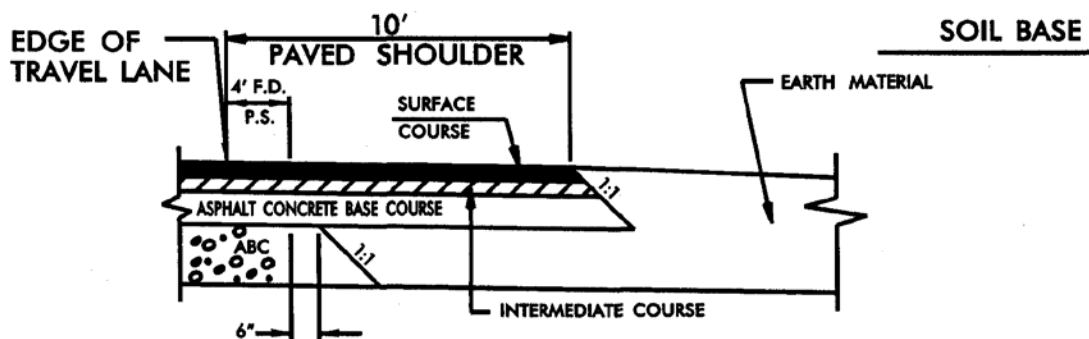
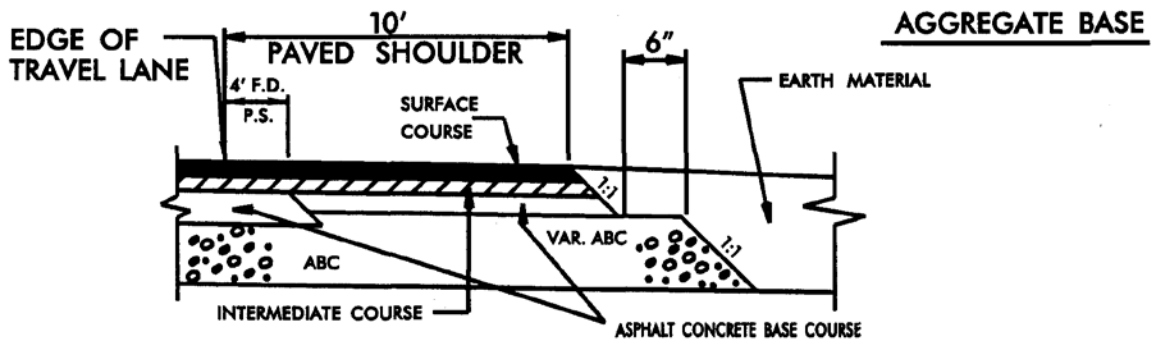
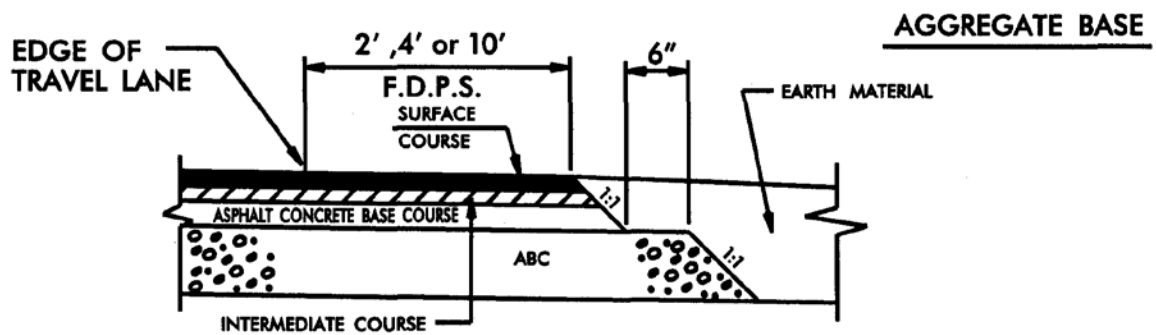
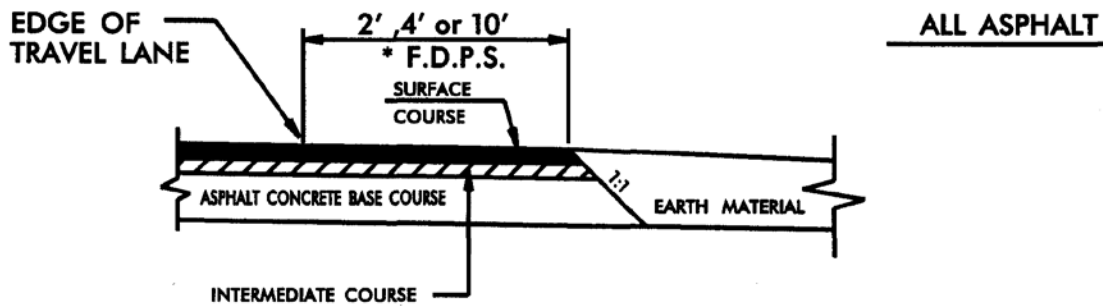

NOTE: FOR PROJECTS WITH A 10' PAVED SHOULDER, THE SHOULDER DESIGN WILL BE RECOMMENDED BY THE PAVEMENT MANAGEMENT UNIT.

* F.D.P.S. - FULL DEPTH PAVED SHOULDER

PAVED SHOULDERS WITH RIGID PAVEMENT

1 - 4G

CONCRETE

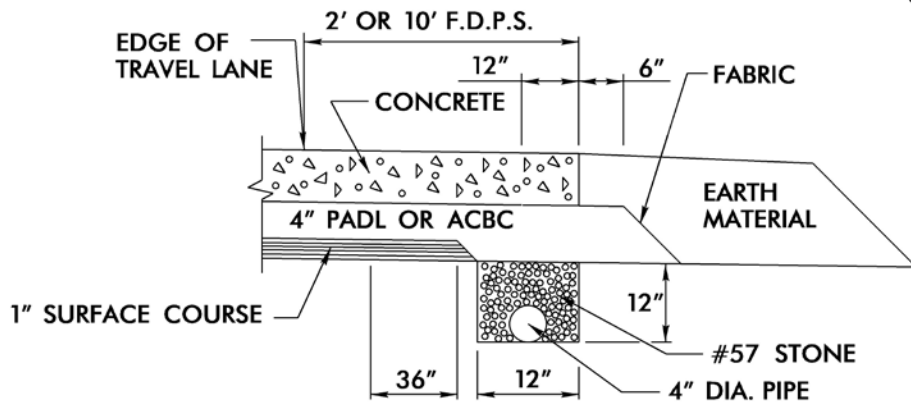

CONCRETE & ASPHALT

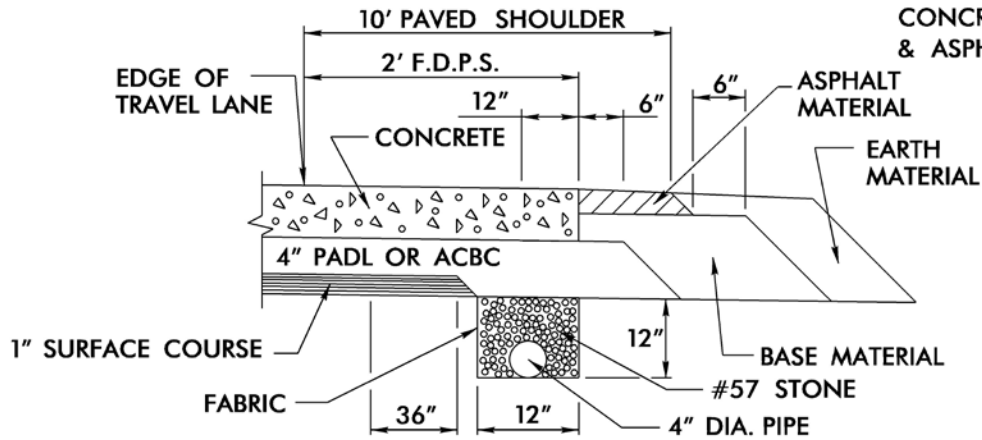

CONCRETE

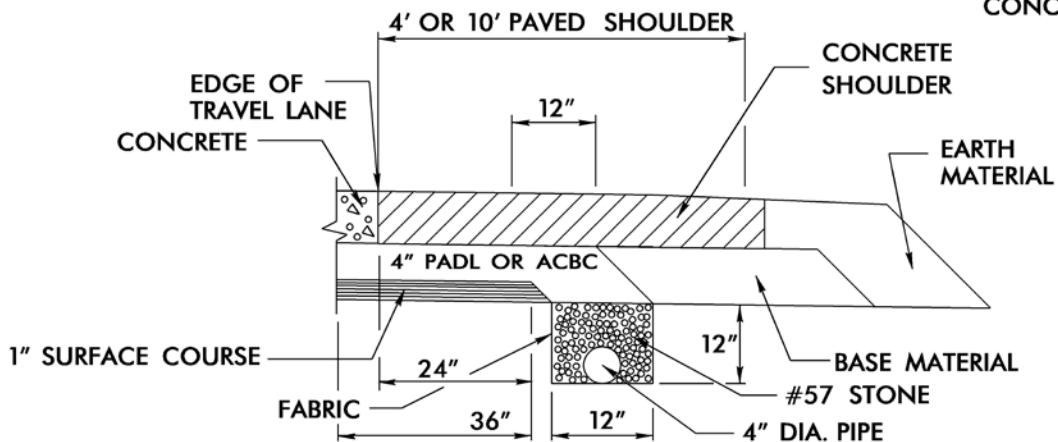

F.D.P.S. - FULL DEPTH PAVED SHOULDER
 PADL - PERMEABLE ASPHALT DRAINAGE LAYER
 ACBC - ASPHALT CONCRETE BASE COURSE

SHOULDER SLOPES**1-4H**

See Roadway Standard Drawings, Std. No's.. 560.01 and 560.02 and 1-4O, Figure 1 in this chapter.

FRONT DITCH SLOPE**1-4I**

The slope from the far edge of shoulder to the ditch point is commonly known as the front slope in a cut section. Front slopes shall be in accordance with Section 1-2A, Figure F-1 in this chapter.

BACK SLOPE**1-4J**

The slope from the ditch bottom to original ground is known as a cut slope or back slope. The back slope may be a fixed slope or a hinge point slope.

When fixed back slopes are used, they shall be in accordance with "Criteria for Roadway Typical Section and Slopes" (see Section 1-2A, Figure F-1 in this chapter). On minor or local roads, one set of fixed slopes in cuts and fills may be used for the length of the project.

HINGE POINT SLOPES**1-4K**

Hinge point slopes shall be used on interstate, freeway, and expressway projects. Also hinge point slopes are used on arterials, collectors, and locals (over 4000 ADT Design Year).

The primary advantage of hinge point slopes is to provide a variable slope that relates to the height of cut or fill. Also, with the utilization of variable slopes, the proposed improvements may be blended into the existing topography and provide a more pleasing appearance.

Hinge point slopes shall be used on all freeways, expressways, and interstates in all terrains except where special ditches are required, soil conditions dictate otherwise, or rock is encountered.

HINGE POINT SLOPES (continued)**1-4K****HINGE POINTS FOR FREEWAYS, EXPRESSWAYS AND INTERSTATES**

See 1-2A, Figure 1(A) in this chapter. These hinges will provide a transition area at the beginning and end of cuts and fills. Steeper fixed slopes, as determined by the Soils and Foundation Section, will be utilized through the remainder of the cut or fill.

Hinge Points for Arterials**(other than Expressways, Collectors, and Locals (Over 4000 ADT Design Year Traffic))**

When utilizing hinge point slopes for arterials (other than freeways, expressways and interstates), collectors, and locals (over 4000 ADT Design Year Traffic), see 1-2A, Figure 1(B) in this chapter.

VEHICLE RECOVERY AREAS**1-4L**

Vehicle recovery area is defined as a traversable clear zone adjacent to the highway travel lanes within which all fixed hazards have either been removed, reconstructed to acceptable safety criteria, or shielded. The width of a recovery area varies with design speed, traffic volumes, and slope configurations.

A traversable and recoverable clear zone indicate there are no slopes encountered within the clear zone which are steeper than 4:1. Slopes between 3:1 and 4:1 are traversable, but not recoverable. Any slopes steeper than 3:1 are classified as critical; an errant motorist will not be able to traverse or recover on these slopes.

For a pictorial view of the Recovery Area, please refer to 1-4M, Figure 1. Clear zone distances are shown on 1-4M, (Figures A, B, C, and D) of this Chapter.

All utility Poles shall be placed outside the Clear Zone as defined by the 2011 Roadside Design Guide. See Detail Figure 1-7D, F-4 for posted 45 PHM or less curb and gutter roadway section.

FIGURE 1

1-4M
F-1

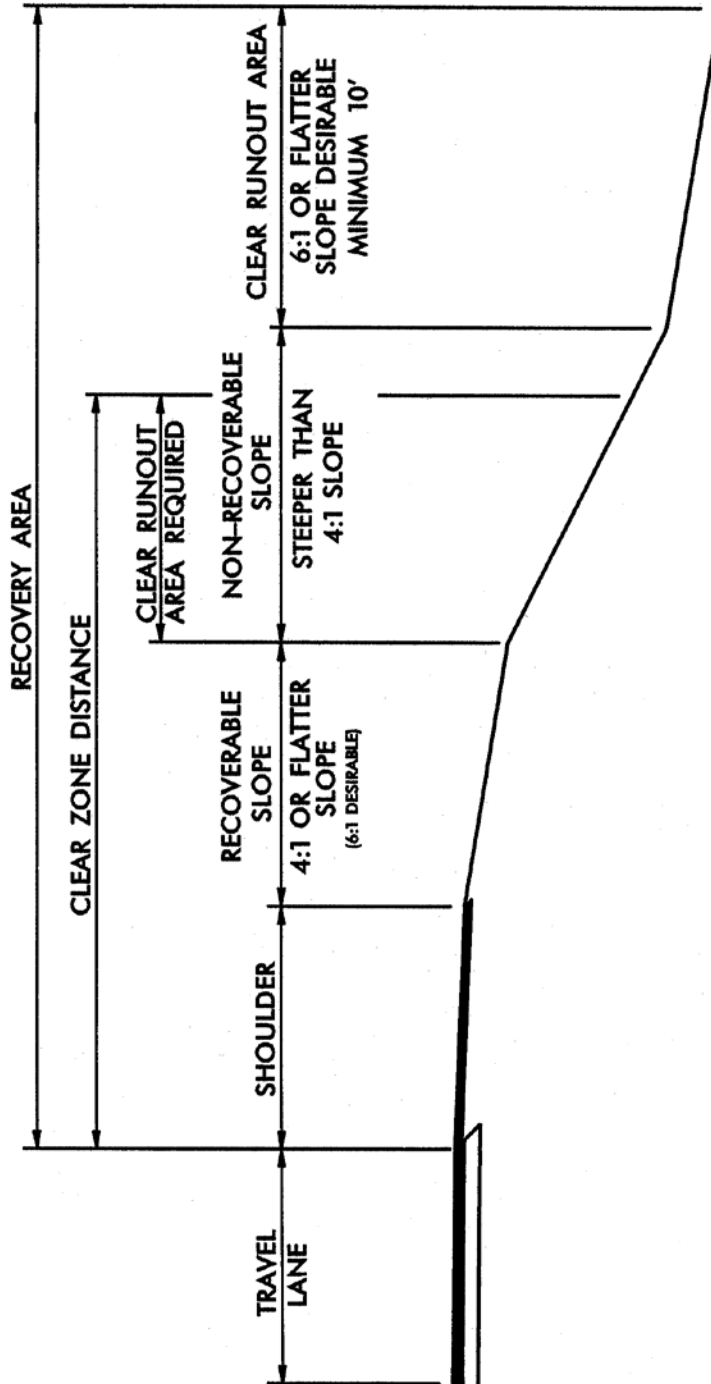

DETAIL GUIDE FOR VEHICLE RECOVERY AREA

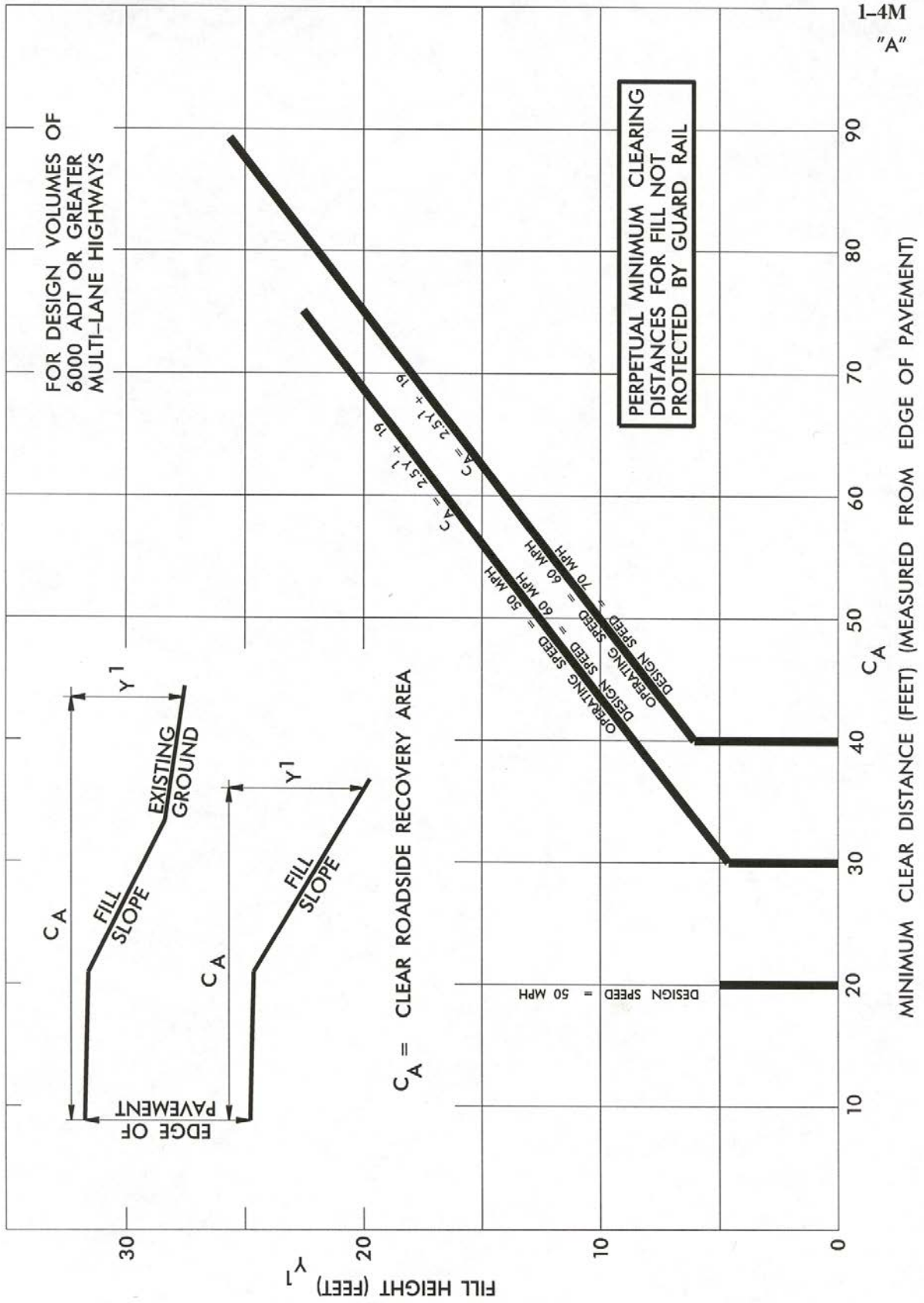

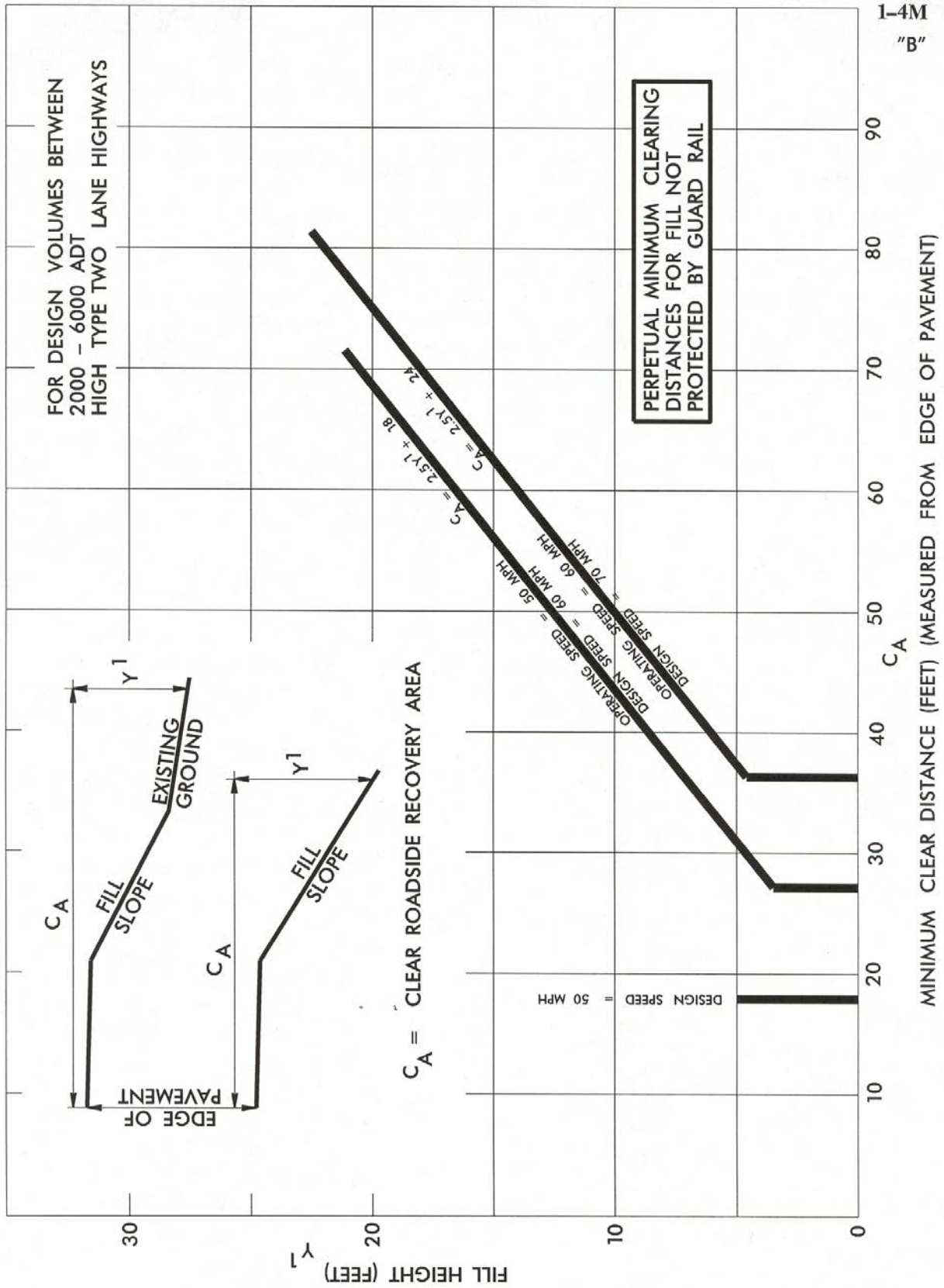

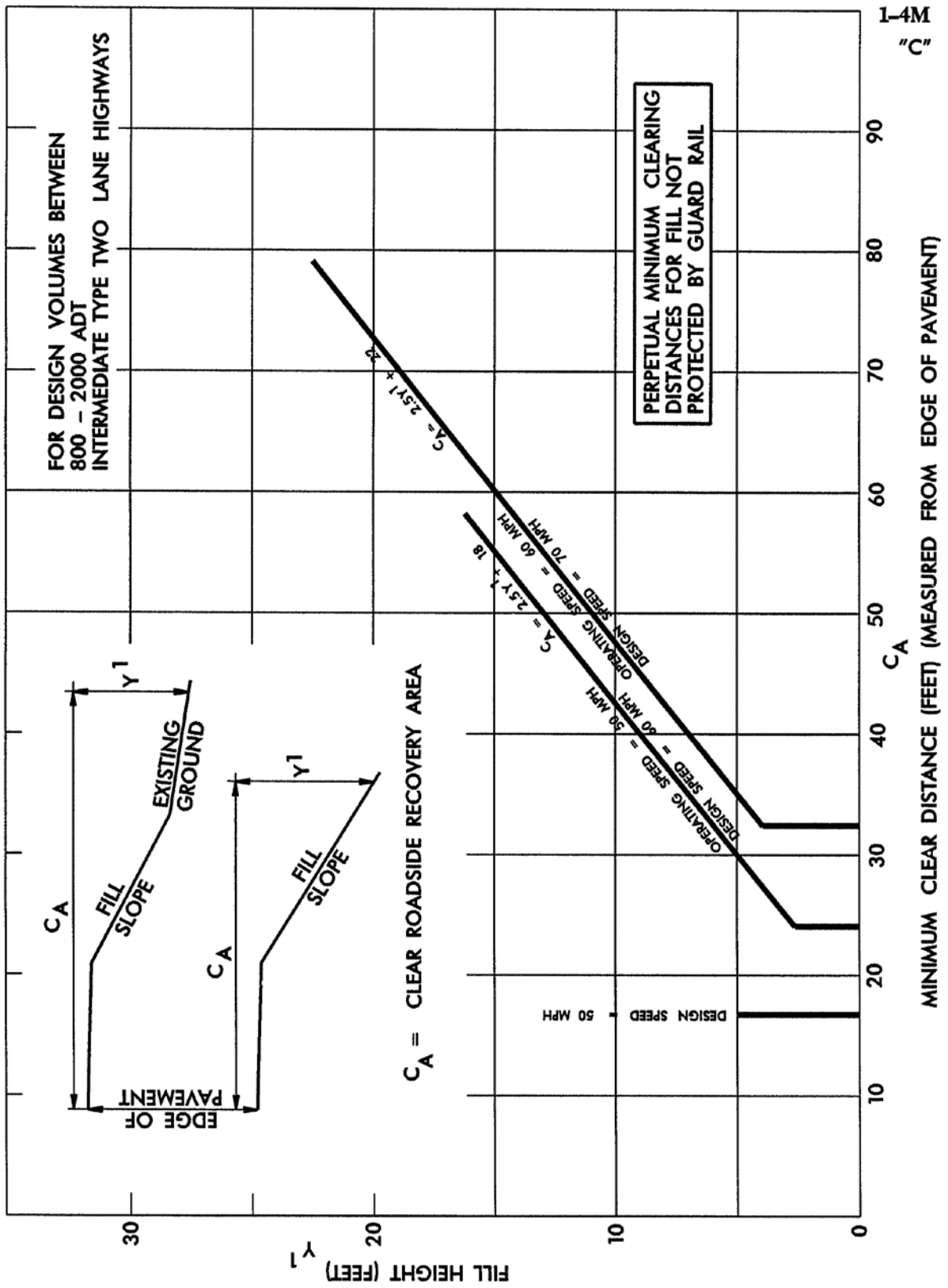

CLEAR ZONE DISTANCES

1 - 4N

**CLEAR ZONE DISTANCES
(IN FEET FROM EDGE OF TRAVEL LANE)**

DESIGN SPEED	DESIGN ADT	FORESLOPES			BACKSLOPES		
		1V:6H or flatter	1V:5H to 1V:4H	1V:3H	1V:3H	1V:5H to 1V:4H	1V:6H or flatter
40 mph or less	UNDER 750	7 - 10	7 - 10	**	7 - 10	7 - 10	7 - 10
	750 - 1500	10 - 12	12 - 14	**	10 - 12	10 - 12	10 - 12
	1500 - 6000	12 - 14	14 - 16	**	12 - 14	12 - 14	12 - 14
	OVER 6000	14 - 16	16 - 18	**	14 - 16	14 - 16	14 - 16
45 - 50 mph	UNDER 750	10 - 12	12 - 14	**	8 - 10	8 - 10	10 - 12
	750 - 1500	14 - 16	16 - 20	**	10 - 12	12 - 14	14 - 16
	1500 - 6000	16 - 18	20 - 26	**	12 - 14	14 - 16	16 - 18
	OVER 6000	20 - 22	24 - 28	**	14 - 16	18 - 20	20 - 22
55 mph	UNDER 750	12 - 14	14 - 18	**	8 - 10	10 - 12	10 - 12
	750 - 1500	16 - 18	20 - 24	**	10 - 12	14 - 16	16 - 18
	1500 - 6000	20 - 22	24 - 30	**	14 - 16	16 - 18	20 - 22
	OVER 6000	22 - 24*	26 - 32*	**	16 - 18	20 - 22	22 - 24
60 mph	UNDER 750	16 - 18	20 - 24	**	10 - 12	12 - 14	14 - 16
	750 - 1500	20 - 24	26 - 32*	**	12 - 14	16 - 18	20 - 22
	1500 - 6000	26 - 30	32 - 40*	**	14 - 18	18 - 22	24 - 26
	OVER 6000	30 - 32*	36 - 44*	**	20 - 22	24 - 26	26 - 28
65 - 70 mph	UNDER 750	18 - 20	20 - 26	**	10 - 12	14 - 16	14 - 16
	750 - 1500	24 - 26	28 - 36*	**	12 - 16	18 - 20	20 - 22
	1500 - 6000	28 - 32*	34 - 42*	**	16 - 20	22 - 24	26 - 28
	OVER 6000	30 - 34*	38 - 46*	**	22 - 24	26 - 30	28 - 30

* Clear zone distances can be limited to 30 feet unless in a high accident rate area.

** Since 3:1 slopes are not recoverable, additional run out area must be provided at the toe of the slope. Please refer to figure 1 on sheet 1-4M.

BACKGROUND INFORMATION

From: <http://www.fhwa.dot.gov/programadmin/clearzone.cfm>

Clear Zone and Horizontal Clearance Frequently Asked Questions

1. **What is the definition of clear zone?**

The Roadside Design Guide defines a **clear zone** as the total roadside border area, starting at the edge of the traveled way, available for safe use by errant vehicles. This area may consist of a shoulder, a recoverable slope, a non-recoverable slope, and/or a clear run-out area. The desired minimum width is dependent upon traffic volumes and speeds and on the roadside geometry. Simply stated, it is an unobstructed, relatively flat area beyond the edge of the traveled way that allows a driver to stop safely or regain control of a vehicle that leaves the traveled way.

A **recoverable slope** is a slope on which a motorist may, to a greater or lesser extent, retain or regain control of a vehicle by slowing or stopping. Slopes flatter than 1V:4H are generally considered recoverable. A **non-recoverable slope** is a slope which is considered traversable but on which an errant vehicle will continue to the bottom. Embankment slopes between 1V:3H and 1V:4H may be considered traversable but non-recoverable if they are smooth and free of fixed objects. A **clear run-out area** is the area at the toe of a non-recoverable slope available for safe use by an errant vehicle. Slopes steeper than 1V:3H are not considered traversable and are not considered part of the clear zone.

2. **Where can I find information on clear zone dimensions?**

The current edition of the AASHTO *Roadside Design Guide* presents information on the latest state-of-the-practice in roadside safety. It presents procedures to determine a recommended minimum clear zone on tangent sections of roadway with variable side slopes and adjustments for horizontal curvature.

The AASHTO *A Policy on Geometric Design of Highways and Streets* (Green Book) enumerates a clear zone value for two functional classes of highway. For local roads and streets, a minimum clear zone of 7 to 10 feet is considered desirable on sections without curb. In the discussion on collectors without curbs, a 10-foot minimum clear zone is recommended. The general discussion on Cross-section Elements also indicates a clear zone of 10 ft. for low-speed rural collectors and rural local roads should be provided.

3. **What is the definition of horizontal clearance?**

Horizontal clearance is the **lateral offset distance** from the edge of the traveled way, shoulder or other designated point to a vertical roadside element. These dimensional values are not calculated, and are not intended to constitute a clear zone. They are intended to provide a roadside environment that is not likely to have an adverse affect on motorists' using the roadway. These lateral offsets provide clearance for mirrors on trucks and buses that are in the extreme right lane of a facility and for opening curbside doors of parked vehicles, as two examples.

4. **What are some examples of roadside elements requiring horizontal clearance?**

Curbs, walls, barriers, piers, sign and signal supports, mature trees, landscaping items, and power poles are primary examples of the type of features that can affect a driver's speed or lane position if located too close to the roadway edge. Other specific examples can be found in the Cross Section Elements, Local Roads and Streets, Collector Roads and Streets, Rural and Urban Arterials, Freeways, and Intersections chapters of the Green Book.

The AASHTO *A Policy on Design Standards - Interstate System* also contains a discussion on horizontal clearance in the section Horizontal Clearance to Obstructions.

5. **Is clear zone a controlling criterion?**

No. Controlling criteria are 13 items or elements in the NHS design standards that require a formal design exception when the adopted minimum value is not met on a project. The list of controlling criteria was developed to insure that deviations below the adopted value for a critical element were adequately considered in design of a project. When the original list was developed in 1985, clear zone was considered to be synonymous with horizontal clearance. Subsequently, in 1990, following adoption of the *Roadside Design Guide*, it was decided that clear zone width would no longer be considered as an element requiring a formal design exception. In the rulemaking to adopt the *Roadside Design Guide*, it was determined that clear zone width should not be defined by a fixed, nationally applicable value. The various numbers in the guide associated with clear zone are not considered as exact but as ranges of values within which judgment should be exercised in making design decisions. Objects or terrain features that fall within the appropriate clear zone are typically shielded so a design exception is not needed. The FHWA believes that a consistent design approach, guided by past crash history and a cost-effectiveness analysis is the most responsible method to determine appropriate clear zone width.

While clear zone is not a controlling criterion for purposes of applying the Green Book to the National Highway System, an exception to a clear zone for a project does need to be noted, approved and documented in the same manner as exceptions to other non-controlling criteria when the established value is not met. The documentation may be included in project notes of meetings or other appropriate means.

6. Where is the appropriate location for above ground utility structures?

FHWA policy is that utility facilities should be located as close to the right-of-way line as feasible. The Green Book, AASHTO *Highway Safety Design and Operations Guide, 1997*, (Yellow Book) and the AASHTO *A Guide for Accommodating Utilities within Highway Right-of-way*, all state that utilities should be located as close to the right-of-way line as feasible. The Yellow Book, recognizing that crashes are overrepresented on urban arterials and collectors, says this means as far as practical behind the face of outer curbs and where feasible, behind the sidewalks.

It is not always feasible to relocate all poles within project limits. Critical locations should be considered for improvement, such as those dictated by crash experience or in potential crash locations, such as within horizontal curves. Where poles cannot be relocated from critical locations, mitigation such as breakaway or shielding should be considered. Poles should not be installed in a location that could act as a funnel directing an errant vehicle into an obstacle (for example a roadside drainage ditch, that would also disrupt the hydraulics). Locating a pole as far as feasible from the traveled way improves sight lines and visibility, providing a safer roadside.

7. What clear zone needs to be maintained behind a curb?

The difference between a "clear zone" and horizontal clearance or "operational offset" has been a topic of much confusion. When the Green Book and the Roadside Design Guide were last updated, the AASHTO committees coordinated to dispel the misunderstanding that 2 feet (actually, 18 inches) behind a curb constituted a clear zone. Since curbs are now generally recognized as having no significant containment or redirection capability, clear zone should be based on traffic volumes and speeds, both without and with a curb. Realizing that there are still contradictory passages in various AASHTO documents, the Technical Committee on Roadside Safety has initiated a short-term project to identify all such inconsistencies and to recommend appropriate language corrections. This effort is underway. The fourth paragraph under Section 3.4.1 Curbs in the 2011 Roadside Design Guide correctly defines AASHTO's "position".

FIGURE 1

NCDOT PAVED SHOULDER POLICY	
INTERSTATE AND FREEWAYS 6 OR MORE LANES	10' WIDE PAVED OUTSIDE SHOULDERS & 10' WIDE PAVED MEDIAN SHOULDERS (FULL DEPTH OR AS DIRECTED THE PAVEMENT MANAGEMENT UNIT.)
INTERSTATE 4 LANES	10' WIDE PAVED OUTSIDE SHOULDERS (FULL DEPTH OR AS DIRECTED BY THE PAVEMENT MANAGEMENT UNIT.) 4' WIDE FULL DEPTH PAVED MEDIAN SHOULDERS (REMAINING WIDTH TO BE TURF.)
FREEWAYS 4 LANES (DES. YR. ADT \geq 40000)	10' WIDE PAVED OUTSIDE SHOULDERS (4' OF WIDTH TO BE FULL DEPTH, REMAINING PAVED WIDTH TO BE SURFACE COURSE ON ABC, OR AS DIRECTED BY THE PAVEMENT MANAGEMENT UNIT.) 4' WIDE FULL DEPTH PAVED MEDIAN SHOULDERS (REMAINING WIDTH TO BE TURF.)
(DES. YR. ADT < 40000) (DES. YR. ADT \geq 15000)	10' WIDE PAVED OUTSIDE SHOULDERS (4' OF WIDTH TO BE FULL DEPTH, REMAINING PAVED WIDTH TO BE SURFACE COURSE ON ABC, OR AS DIRECTED BY THE PAVEMENT MANAGEMENT UNIT.) 4' WIDE FULL DEPTH PAVED MEDIAN SHOULDERS (REMAINING WIDTH TO BE TURF.)
(DES. YR. ADT < 15000)	4' WIDE OUTSIDE AND 4' WIDE MEDIAN FULL DEPTH PAVED SHOULDERS. (REMAINING SHOULDER WIDTH TO BE TURF.)
<u>DIVIDED:</u> ARTERIALS, COLLECTORS 6 OR MORE LANES	10' WIDE PAVED OUTSIDE SHOULDERS (4' OF WIDTH TO BE FULL DEPTH, REMAINING PAVED WIDTH TO BE SURFACE COURSE ON ABC OR AS DIRECTED BY THE PAVEMENT MANAGEMENT UNIT.) 4' WIDE FULL DEPTH PAVED MEDIAN SHOULDER. SEE NOTE 7.
<u>DIVIDED:</u> ARTERIALS, COLLECTORS 4 LANES (DES. YR. ADT \geq 40000)	10' WIDE PAVED OUTSIDE SHOULDERS (4' OF WIDTH TO BE FULL DEPTH, REMAINING PAVED WIDTH TO BE SURFACE COURSE ON ABC OR AS DIRECTED BY PAVEMENT MANAGEMENT), 4' WIDE FULL DEPTH PAVED MEDIAN SHOULDERS (REMAINING MEDIAN SHOULDER WIDTH TO BE TURF.)
(DES. YR. ADT < 40000)	4' WIDE OUTSIDE & 2' WIDE MEDIAN FULL DEPTH PAVED SHOULDERS. (REMAINING SHOULDER WIDTH TO BE TURF.)
<u>MULTILANE UNDIVIDED:</u> 4 OR MORE LANES (DES. YR. ADT \geq 40000)	10' WIDE PAVED SHOULDERS (4' OF WIDTH TO BE FULL DEPTH, REMAINING PAVED WIDTH TO BE SURFACE COURSE ON ABC, OR AS DIRECTED BY THE PAVEMENT MANAGEMENT UNIT.)
(DES. YR. ADT < 40000)	4' WIDE FULL DEPTH PAVED SHOULDERS. (REMAINING SHOULDER WIDTH TO BE TURF.)
<u>TWO LANE - TWO WAY :</u>	
(DES. YR. ADT \geq 8000)	4' WIDE FULL DEPTH PAVED SHOULDERS. (REMAINING SHOULDER WIDTH TO BE TURF.)
(DES. YR. ADT \geq 4000)	2' WIDE FULL DEPTH PAVED SHOULDERS. (REMAINING SHOULDER WIDTH TO BE TURF.)
(DES. YR. ADT < 4000)	FULL SHOULDER TO BE TURF. NOTE: 4' PAVED SHOULDER MAY BE CONSIDERED FOR BIKE ROUTES.
<u>RAMPS</u> LEFT SHOULDERS	4' WIDE FULL DEPTH PAVED SHOULDER (REMAINING SHOULDER WIDTH TO BE TURF.)
RIGHT SHOULDERS	4' WIDE FULL DEPTH PAVED SHOULDER (REMAINING SHOULDER WIDTH TO BE TURF.) SEE NOTE 5.
<p>NOTES:</p> <ol style="list-style-type: none"> PAVED SHOULDER WIDTH SHOULD NOT EXCEED USABLE WIDTHS AS DEFINED IN ROADWAY DESIGN MANUAL EXCEPT AT GUARDRAIL LOCATIONS AS SHOWN IN STD. 862.01. A 12' WIDE PAVED RIGHT SHOULDER SHOULD BE CONSIDERED FOR INTERSTATES AND FREEWAYS HAVING TRUCK TRAFFIC WHICH EXCEEDS 250 DDHV. A 12' WIDE PAVED MEDIAN SHOULDER SHOULD BE CONSIDERED FOR THESE FAC. WHICH HAVE SIX OR MORE LANES AND TRUCK TRAFF. EXCEEDING 250 DDHV. FREEWAYS THAT WARRANT 12' PAVED SHOULDERS DUE TO HEAVY TRUCK TRAFFIC AND THE DESIGN YEAR ADT \geq 40,000 WILL BE DESIGNED WITH 12' FULL DEPTH PAVED SHOULDERS. 12' WIDE PAVED MEDIAN SHOULDERS WILL CONSIST OF 4' WIDTH FULL DEPTH WITH THE REMAINING PAVED WIDTH BEING SURFACE COURSE ON ABC OR AS DIRECTED BY THE PAVEMENT MANAGEMENT UNIT. RUMBLE STRIPS, PAVEMENT TEXTURING OR OTHER APPROVED METHODS FOR DELINEATING MAINLINE PAVEMENT SURFACES FROM SHOULDER PAVEMENT SURFACES SHOULD BE USED ON RURAL INTERSTATE AND FREEWAY SHOULDER SURFACES. THE PAVEMENT MANAGEMENT UNIT SHALL DETERMINE THE PAVED SHOULDER DESIGN ON A PROJECT BY PROJECT BASIS. THE FULL USABLE SHOULDER WIDTH OF INDIVIDUAL RAMPS MAY BE PAVED IF A HISTORY OF EXCESSIVE SHOULDER USAGE IS APPARENT OR EXPECTED, BASED UPON EXPERIENCE AT SIMILAR FACILITIES IN THE REGION. IF THE FULL USABLE WIDTH IS TO BE PAVED THEN 4' OF THE WIDTH SHALL BE FULL DEPTH PAVEMENT AND THE REMAINING PAVED WIDTH SHALL BE SURFACE COURSE ON ABC OR AS DIRECTED BY PAVEMENT MANAGEMENT UNIT. A RECOMMENDATION TO PAVE THE FULL USABLE WIDTH CAN BE MADE AT THE PROJECT FIELD INSPECTION AND IS TO BE APPROVED BY THE STATE ROADWAY DESIGN ENGINEER. THE FULL USABLE WIDTH OF AUXILIARY LANE SHOULDERS SHALL BE PAVED IF THE AUXILIARY LANE CONNECTS INTERCHANGES OR IS LONGER THAN 2500 FEET. 4' OF THE PAVED WIDTH SHALL BE FULL DEPTH PAVEMENT AND THE REMAINING PAVED WIDTH SHALL BE SURFACE COURSE ON ABC, OR AS DIRECTED BY THE PAVEMENT MANAGEMENT UNIT. CONSIDER 10' PAVED INSIDE SHOULDERS FOR SPEEDS \geq 55 MPH. 	

FIGURE 1

1 - 4 0
FIG - 1A

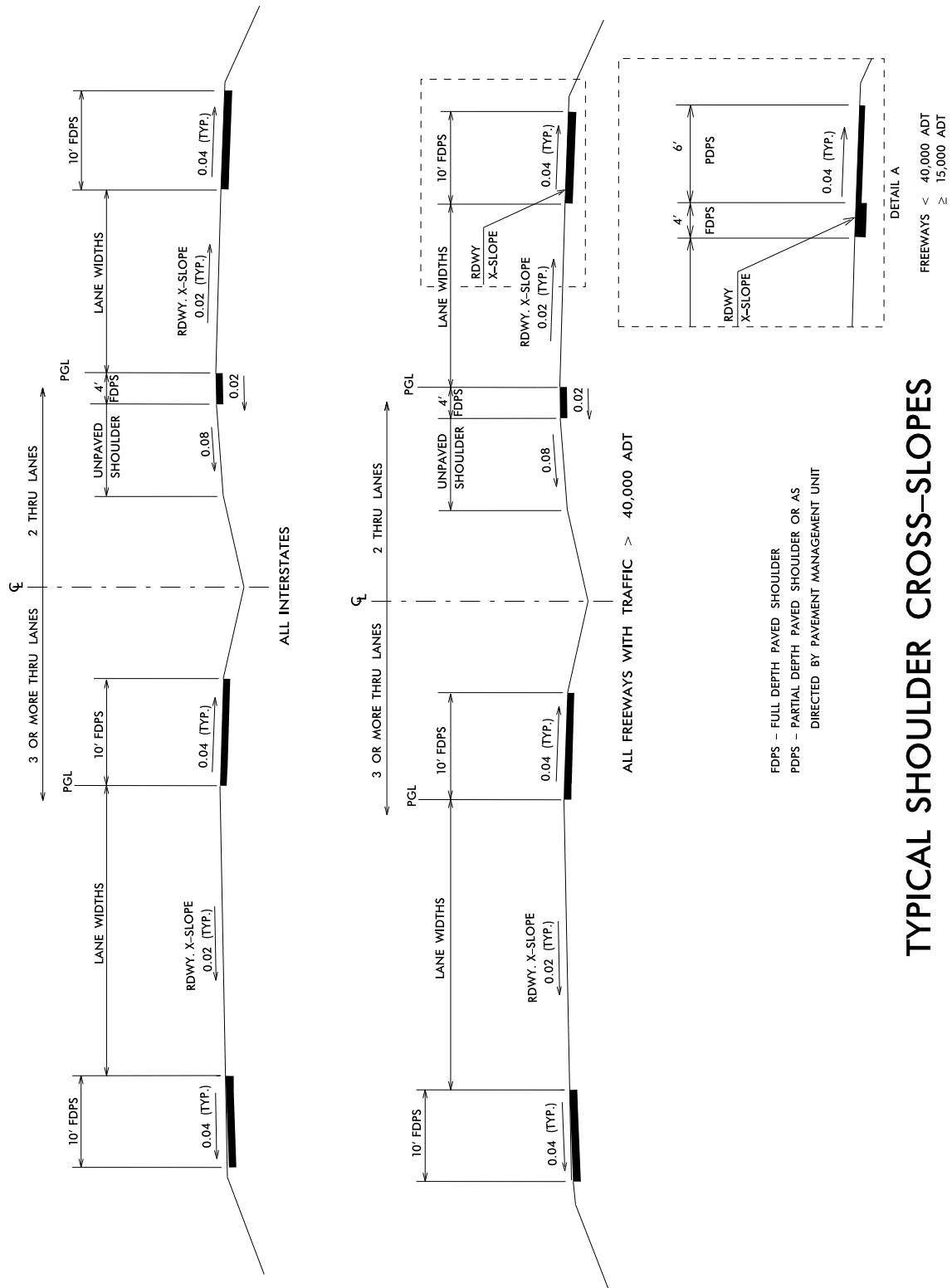

TYPICAL SHOULDER CROSS-SLOPES

FIGURE 1

1 - 4 0
FIG - 1B

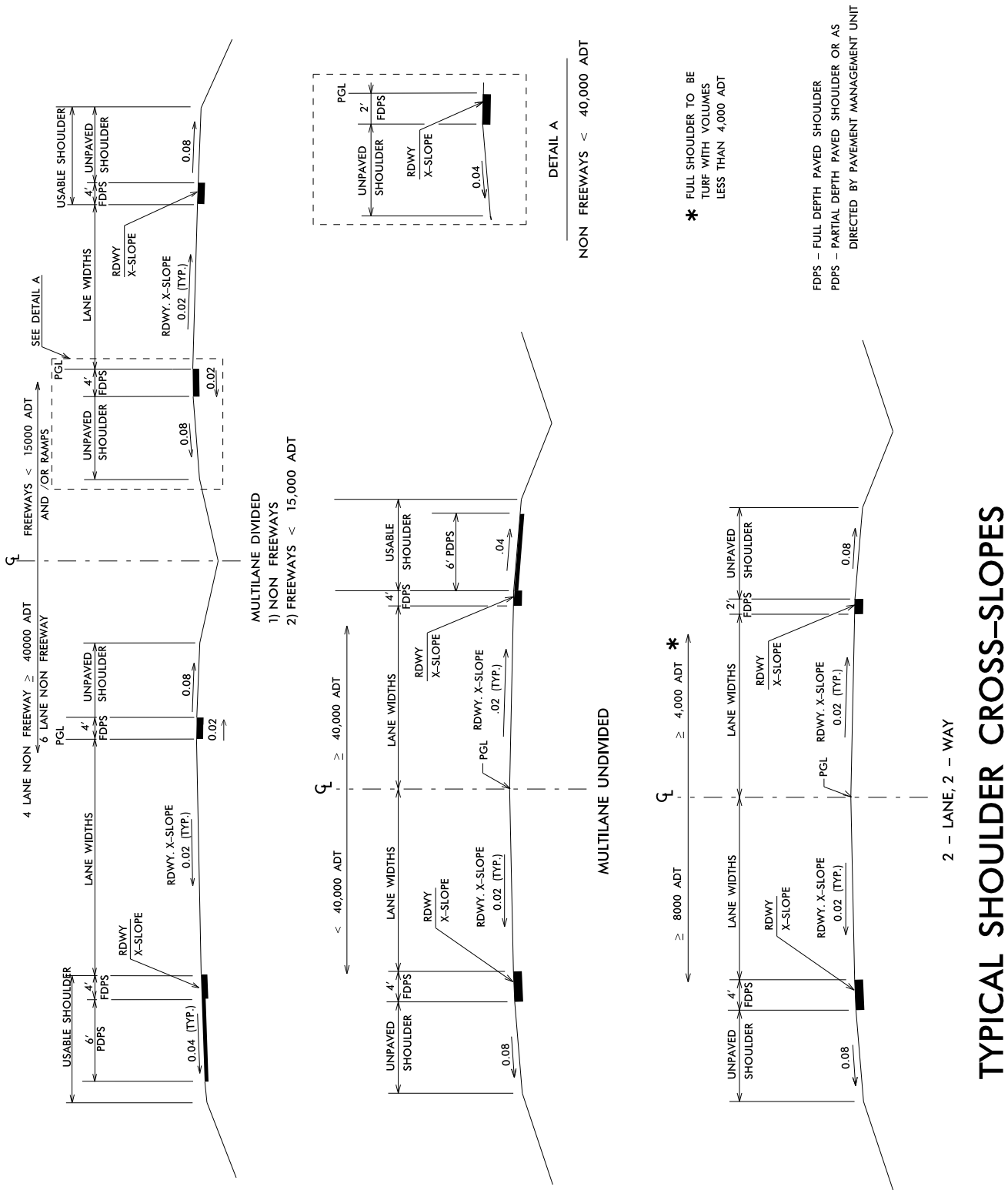

TYPICAL SHOULDER CROSS-SLOPES

2 - LANE, 2 - WAY

**GUIDELINES FOR RUMBLE STRIPS
FOR PAVED SHOULDERS****1-4P**

The purpose of these guidelines is to provide the Preconstruction Branch, Operations Branch, and Transportation Mobility and Safety Branch a procedure when using paved roadway shoulders. These guidelines should be used for identifying sections of shoulders on Interstate, Freeways, Expressways and other roadway facilities where rumble strips are desirable. This policy also discusses different types of rumble strips and selection for various types and widths of paved shoulders.

Rumble strips are sensory warning treatments that are located along the paved shoulders. They alert drivers of “drifting” off the road situations by creating an audible and vibratory warning sensation that their vehicle is leaving the designated travel lane and that a steering correction is required. Rumble strips are intended to alert the motorists before they leave the roadway and strike a roadside barrier or hazard.

It is the responsibility of the State Highway Design Engineer and the State Traffic Engineer, and the Chief Engineer of Operations to ensure that the following guidelines are followed and applied consistently within their respective area of operation.

Generally, rumble strips should be used on both the **median and outside shoulder** at locations where they are required. It is not necessary to use the same type of rumble strips on the median and outside shoulders. The placement of Rumble Strips on existing roadways should be investigated to verify the shoulder width and pavement structure are sufficient. On roadway facilities designated as bike routes, the placement of Rumble Strips should be coordinated with the Bicycle and Pedestrian Division. Milled rumble strips are not recommended on structures.

Rumble strips shall be used on the following types of Median Divided Roadways:

Interstate / Freeway
Expressway (Where access is limited to at-grade intersections)

Placement of Rumble Strips**For Asphalt Paved Shoulders**

Rumble Strips will be located in accordance with the Roadway Standard Drawings, Std. No. 665.01. See details F-1 and F-2.

For Concrete Paved Shoulders

REV. DATE: 09/17/2004

Revision 3

**GUIDELINES FOR RUMBLE STRIPS
FOR PAVED SHOULDERS (continued)****1-4P**

Rumble Strips will be located in accordance with Roadway Standard Drawings, Std. No. 720.01. See details F-3 through F-6.

Rumble Strips should also be considered on other Roadway Facilities

- Where documented histories of lane departure type crashes exists.
- Rural median divided facilities with partial control of access (where designated driveway and street access points are allowed) should be considered on a case by case basis.
-

Placement of Rumble Strips on other Roadway Facilities

- The width of shoulder rumble strips may vary depending on the width of the paved shoulder provided. The Engineer should determine design and placement.
- The width and placement of centerline rumble strips may vary depending on lane width and pavement marking type and use. The Engineer should determine the design and placement.

Other surface treatments may be used with the approval of the State Highway Design Engineer and the State Traffic Engineer. Project Engineers from Roadway Design and Traffic Engineering should agree upon the type and extent of shoulder surface treatments, when applicable, as well as the appropriate Division Office. These guidelines are not intended to restrict or prohibit the use of any alternative surface treatment when special engineering circumstances are required. When selecting the type of treatment, consideration should be given to the potential use of the shoulder by traffic during future construction and maintenance operations.

These guidelines or the rumble strip standard drawings do not account for all possible applications. Therefore, it may be necessary for the designer to develop special application plans or details for the application of milled-in/stamped-in or alternative longitudinal rumble strip treatments. All such plans and details should be submitted and reviewed by the Transportation Mobility and Safety Branch in coordination with the Preconstruction Branch prior to usage on a project.

FIGURE 1

**ASPHALT SHOULDERS
MILLED RUMBLE STRIPS**

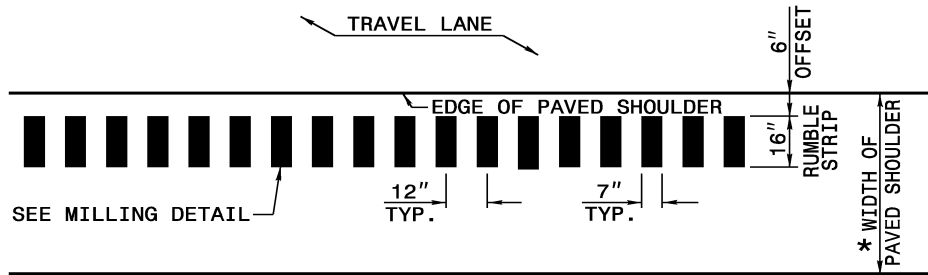

* FOR WIDTHS SEE TYPICAL SECTIONS AND PLAN SHEETS

**PLAN VIEW
PAVED SHOULDER**

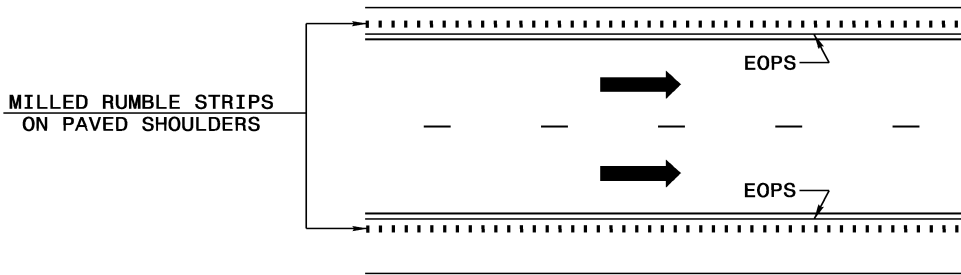

LANE TREATMENT

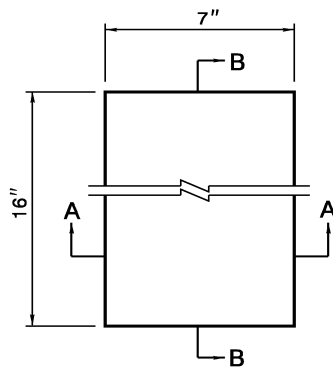

**PLAN VIEW
MILLING DETAIL**

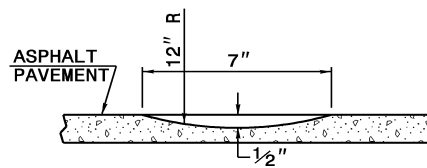

SECTION A-A

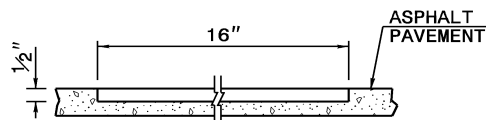

SECTION B-B

FIGURE 2

**ASPHALT SHOULDERS
MILLED RUMBLE STRIPS**

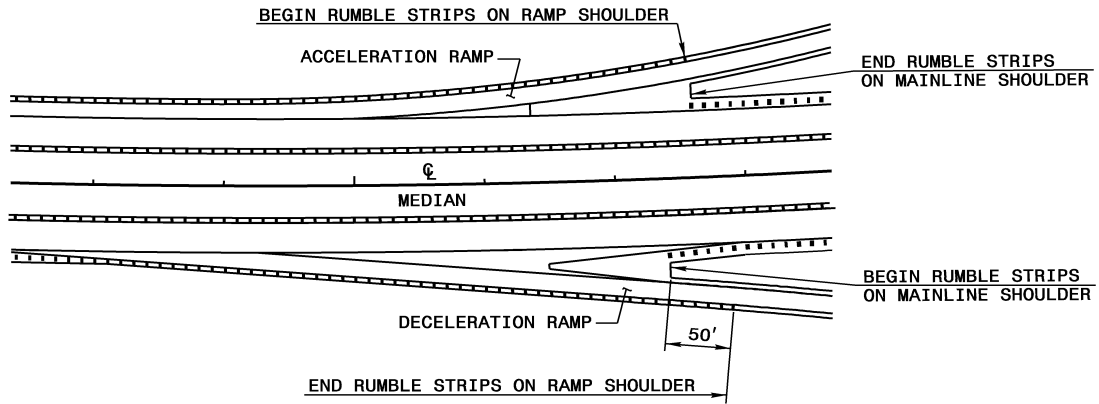

TREATMENT AT RAMP TERMINALS

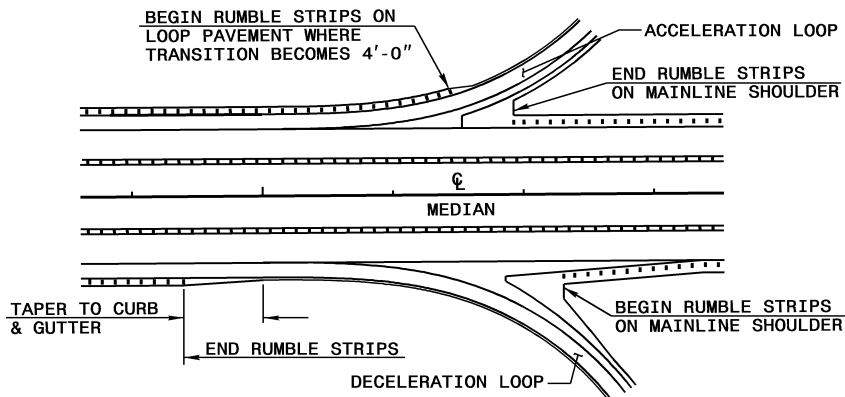

TREATMENT AT LOOP TERMINALS

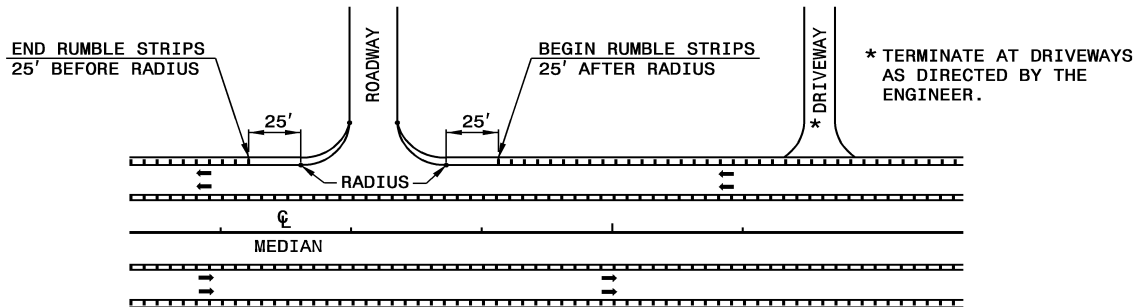

TREATMENT AT INTERSECTIONS

(ROADWAY OR DRIVEWAY)

FIGURE 3

**CONCRETE SHOULDERS
STAMPED OR ROLLED RUMBLE STRIPS**

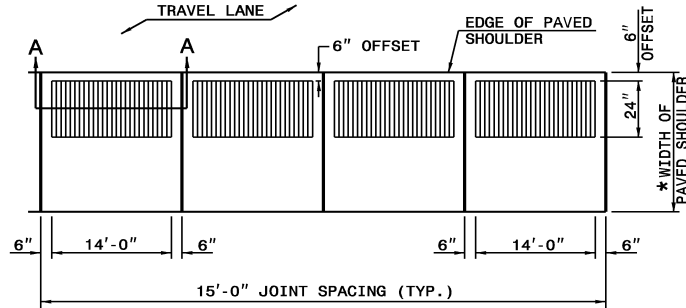

**PLAN VIEW
PAVED SHOULDER**

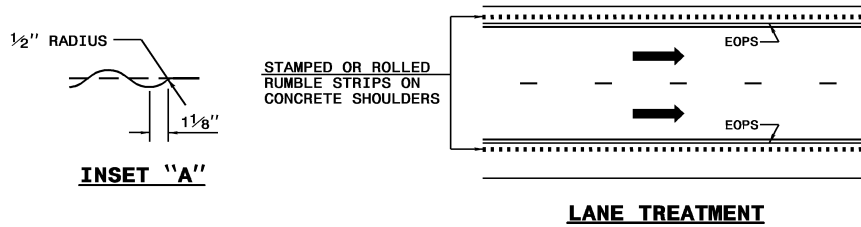

LANE TREATMENT

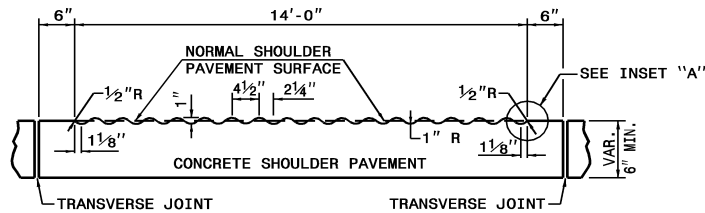

**SECTION A-A
DETAILS FOR RUMBLE STRIP**

* FOR WIDTHS SEE TYPICAL SECTIONS, PLAN SHEETS, AND INTERCHANGE DETAILS.

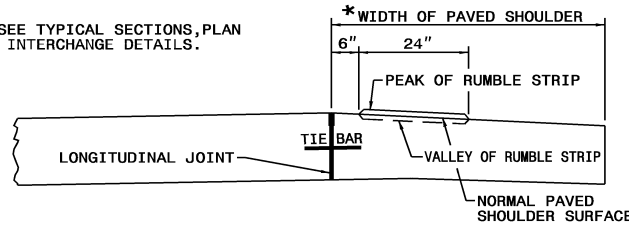

**SECTION DETAILS SHOWING
PEAK AND VALLEY OF RUMBLE STRIP**

NOTES:

1. MATCH CONCRETE SHOULDER TRANSVERSE JOINTS TO THAT OF THE ADJACENT CONCRETE PAVEMENT.
2. SAW AND SEAL THE LONGITUDINAL JOINT AND TRANSVERSE JOINTS. SEE STD. 700.01 FOR DETAILS.
3. SEE DETAIL SHOWING "METHOD OF CONCRETE SHOULDER CONSTRUCTION" FOR PAVEMENT SLOPES.

FIGURE 4

**CONCRETE SHOULDERS
MILLED RUMBLE STRIPS**

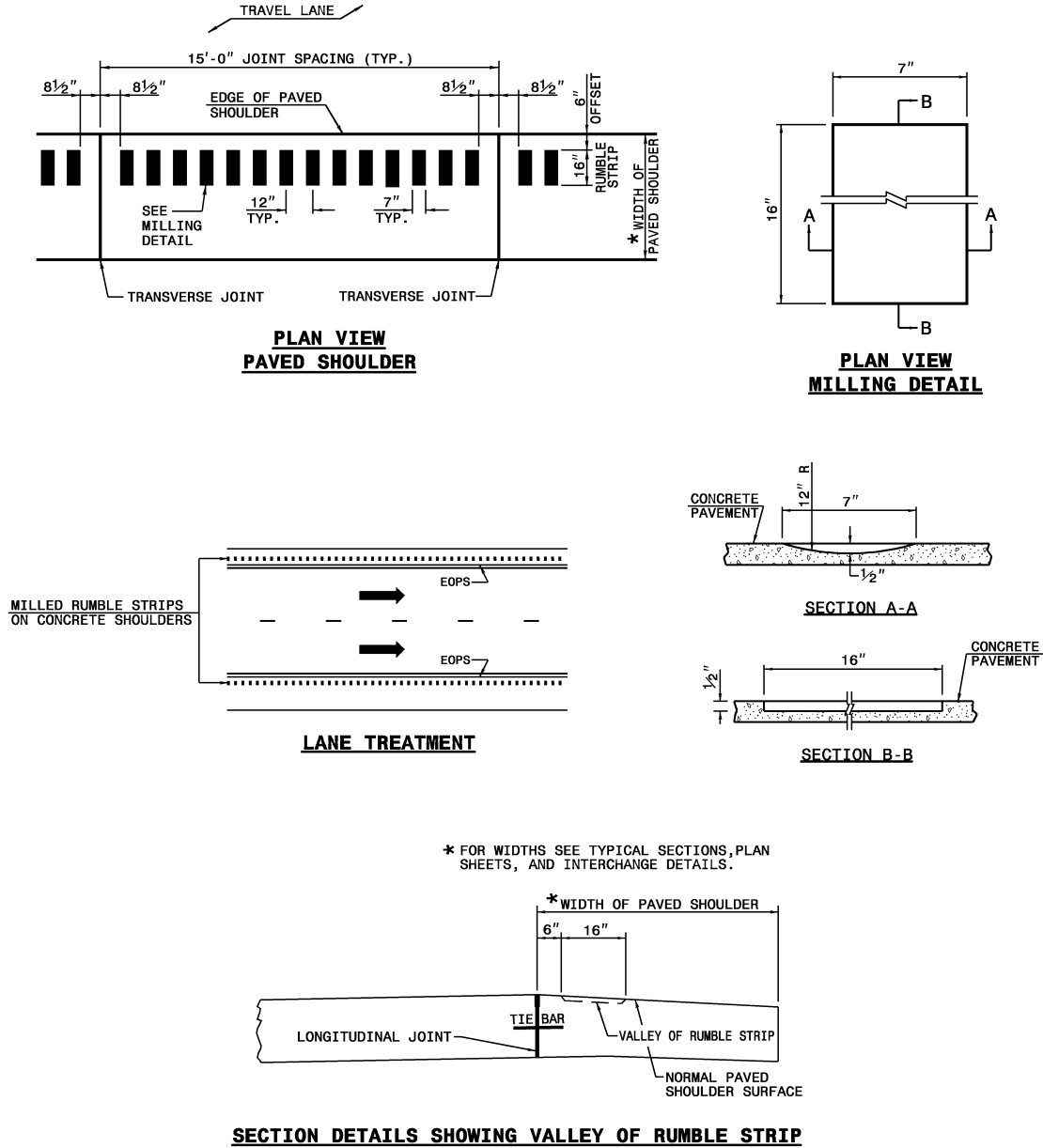

* FOR WIDTHS SEE TYPICAL SECTIONS, PLAN SHEETS, AND INTERCHANGE DETAILS.

NOTES:

1. MATCH CONCRETE SHOULDER TRANSVERSE JOINTS TO THAT OF THE ADJACENT CONCRETE PAVEMENT.
2. SAW AND SEAL THE LONGITUDINAL JOINT AND TRANSVERSE JOINTS. SEE STD. 700.01 FOR DETAILS.
3. SEE DETAIL SHOWING "METHOD OF CONCRETE SHOULDER CONSTRUCTION" FOR PAVEMENT SLOPES.

FIGURE 5

1-4P
F-5

CONCRETE SHOULDERS PLACEMENT OF RUMBLE STRIPS

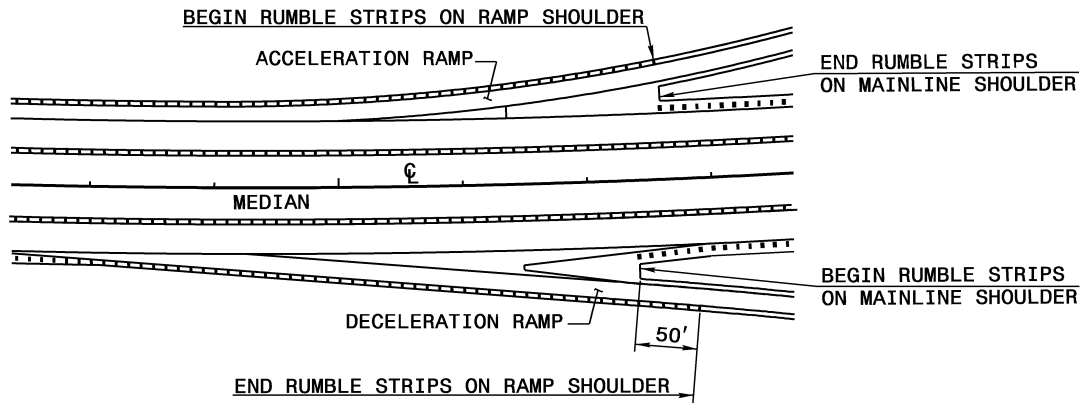

TREATMENT AT RAMP TERMINALS

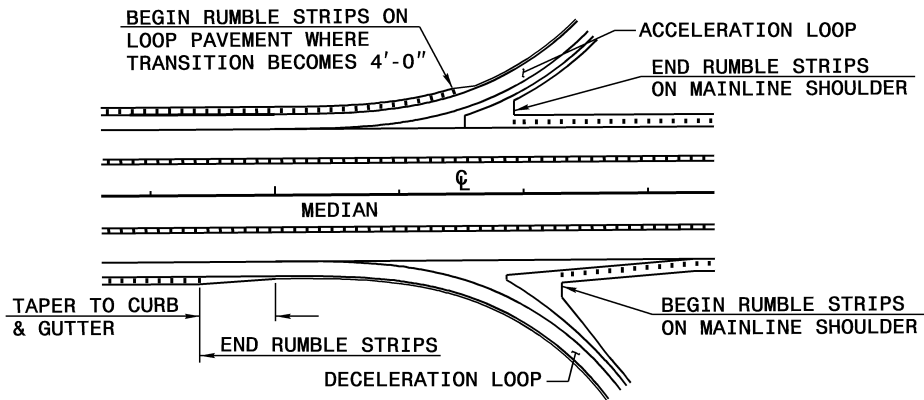

TREATMENT AT LOOP TERMINALS

FIGURE 6

**CONCRETE SHOULDERS - FUTURE LANE
RUMBLE STRIPS**

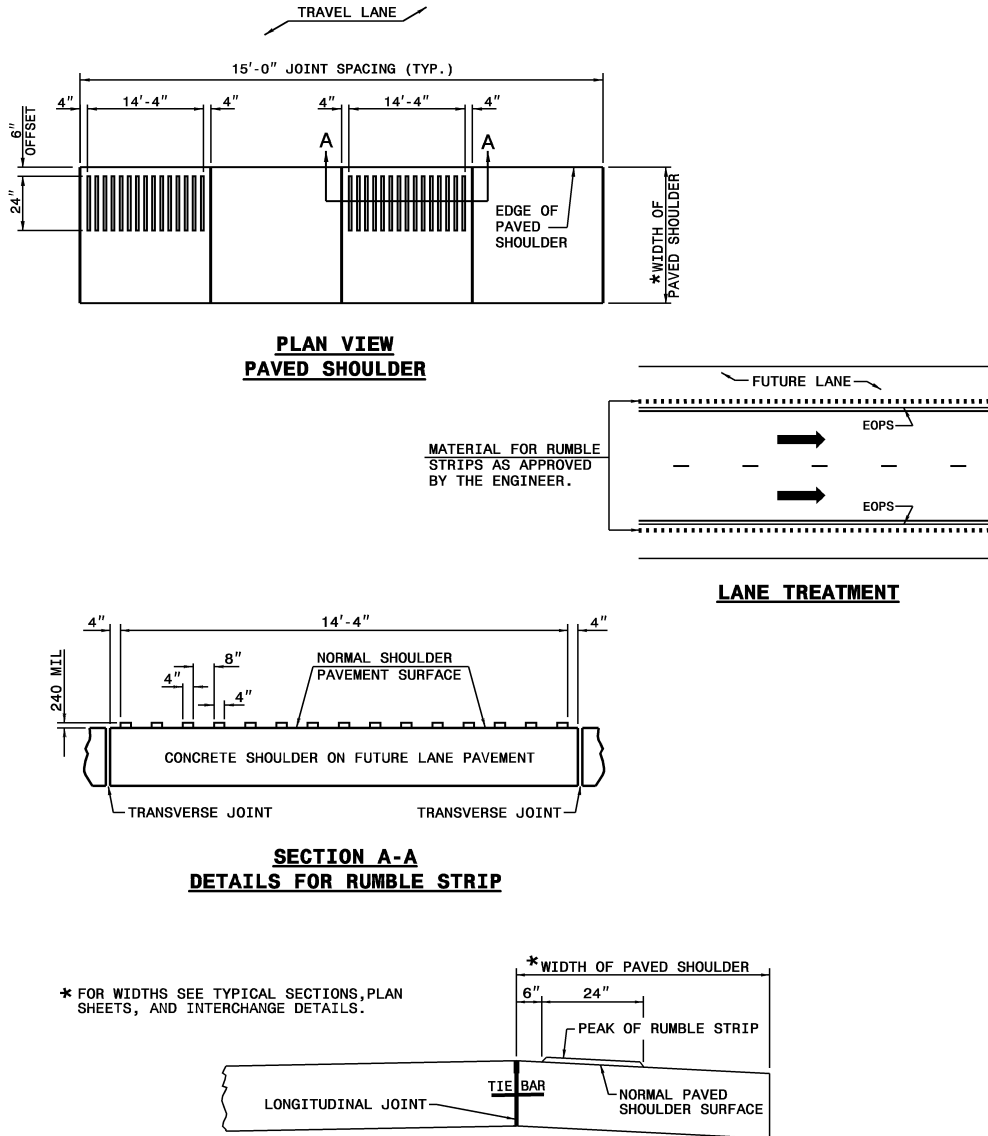

**PLAN VIEW
PAVED SHOULDER**

LANE TREATMENT

**SECTION A-A
DETAILS FOR RUMBLE STRIP**

SECTION DETAILS SHOWING PEAK OF RUMBLE STRIP

- NOTES:
- DO NOT PLACE RUMBLE STRIPS ACROSS TRANSVERSE EXPANSION JOINTS.
 - MATCH CONCRETE SHOULDER TRANSVERSE JOINTS TO THAT OF THE ADJACENT CONCRETE PAVEMENT.
 - SAW AND SEAL THE LONGITUDINAL JOINT AND TRANSVERSE JOINTS. SEE STD. 700.01 FOR DETAILS.
 - SEE DETAIL SHOWING "METHOD OF CONCRETE SHOULDER CONSTRUCTION" FOR PAVEMENT SLOPES.

DITCHES **1-5****DITCH WIDTHS** **1-5A**

See: Typical Sections	1-2A (Figure 1)
Front Slopes	1-2A (Figure 1) and 1-4I
Back Slopes	1-2A (Figure 1) and 1-4J
Hinge Point Slopes	1-2A (Figure 1) and 1-4K

SPECIAL DITCHES **1-5B**

On some projects and especially in flat terrain, it may be necessary to have specially designed ditches to accommodate drainage. When the Hydraulics Unit recommends specially designed ditches, they will be shown on the plans, cross-sections, and special details.

Drainage ditch excavation quantities shall be shown on the plans for all ditches, including location, description and estimated quantity on the plan sheet or summary.

BERM DITCH **1-5C**

Berm ditches are usually recommended by the Hydraulics Unit, however, it is the responsibility of the designer to check each project and determine if the berm ditches should be constructed. They should be recommended in locations where the cut slope is 10' or greater and 100' (perpendicular to the roadway) of natural ground at the top of the cut slopes toward the project. Berm ditch location should be investigated for flow and adequate right of way and/or easements.

Berm ditches are to be shown on the plans with a solid line located 7' beyond the slope stake line. This line is to be labeled "Berm Ditch" with arrows to indicate direction of flow as shown in the plan view of Roadway Standard Drawings, Std. No's. 240.01. If the construction limits of the berm ditch exceeds the dimension shown in the standards, a construction limit should be shown on the plans and the berm ditch shown on the cross sections.

See Roadway Standard Drawings, Std. No. 850.10 and 850.11 for berm drainage outlets.

For additional information on ditch excavation, see Section 240 of the Standard Specifications for Roads and Structures.

PAVED DITCHES**1-5D**

When paved ditches are necessary, they will be included in the drainage recommendations made by the Hydraulics Unit.

The need for paved ditches should also be discussed on the field inspection. See Roadway Standard Drawings, Std. No. 850.01 and 1-5E of this chapter.

RIP RAP FOR DRAINAGE DITCHES**1-5E**

Rip Rap for drainage ditches is normally proposed by the Hydraulics Unit where significant water flows are anticipated. There are four types of Rip Rap used to line ditches; Class "A", Class "B", Class I and Class II.

Class "A" Rip Rap is usually recommended within the clear roadside recovery area and is measured by the ton. See Roadway Standard Drawings, Std. No. 876.03 for typical placement.

Class "B" Rip Rap is usually recommended outside the clear roadside recovery area. Class "B" Rip Rap will be measured by the ton or square yard (units as recommended by the Division Engineer). See Roadway Standard Drawings, Std. No. 876.04 for typical placement.

See Roadway Standard Drawings, Std. No. 876.01 for typical placement of Class I and Class II Rip Rap in ditches.

RIP RAP AT PIPE OUTLETS**1-5F**

Rip Rap should be placed at pipe outlets as recommended by the Hydraulics Unit. The pay item for Rip Rap will be measured by the ton or square yard (units recommended by the Division Engineer). See Roadway Standard Drawings, Std. No. 876.02 for typical placement and quantities.

FILTER FABRIC FOR DRAINAGE DITCHES AND PIPE OUTLETS**1-5G**

Filter Fabric should be used in conjunction with Rip Rap Class "B", Class I, and Class II unless specified otherwise, by the Hydraulics Unit.

For placement of Filter Fabric in drainage ditches, Roadway Standard Drawings, Std.Nos. 876.01 and 876.04.

For placement and quantities of Filter Fabric at outlet pipes, see Roadway Standard Drawings, Std. No. 876.02.

Filter Fabric should not be used with Class "A" Rip Rap unless specifically directed by the Hydraulics Unit.

MEDIANS **1-6****MEDIAN WIDTHS FOR FREEWAYS** **1-6A**

70' Standard
 46' Minimum (without concrete barrier)
 22' Minimum for six or more lanes with concrete barrier
 22' Standard for four-lanes with concrete barrier
 10' Minimum for four-lanes with concrete barrier

MEDIAN WIDTHS FOR HIGHWAYS OTHER THAN FREEWAYS **1-6B**

NEW LOCATION	WIDENING TO 4 LANE DIVIDED
60' Standard	60' Desirable with ditch
46' Minimum	46' Standard with ditch
	*30' Minimum with ditch
	23'-30' with raised median

*NOTE: A 30' median should not be used at intersections subject to heavy school bus crossings. A 46' median is needed at these intersections.

MEDIAN WIDTHS FOR FREEWAYS WITH CONCRETE BARRIER **1-6C**

Six or more lanes – 22' Minimum with Standard Concrete Median Barrier. See Roadway Standard Drawings, Std. No's. 854.01, 854.02, 854.04, and 854.05.

Four lanes – 22' Standard and 10' Minimum with Concrete Median Barrier. See Roadway Standard Drawings, Std. No's. 854.01, 854.02, 854.04, and 854.05.

RAISED MEDIAN WIDTHS FOR ALL HIGHWAYS OTHER THAN FREEWAYS **1-6D**

No provisions for U-turns, 16' minimum. Provisions for U-turns (passenger vehicles only) *30' minimum.

*This width may be reduced if a breakdown lane is provided. If provisions are made for truck U-turns, the median widths will have to be designed to fit the project conditions.

**RAISED MEDIAN WIDTHS FOR ALL
HIGHWAYS OTHER THAN FREEWAYS (continued)****1-6D**

Because of unusual conditions particular to a specific project, the median width may require revisions, but the Unit Head must approve them.

In each of the above median widths, they may have to be adjusted to accommodate median bridge piers.

Divided highways with outside curb and gutter may require outside widening or other special treatment at crossovers to accommodate U-turns.

SPREAD MEDIAN**1-6E**

A spread median may be considered where comparative analysis and cost estimates show a spread median is economically justified. Approval of the State Design Engineer is necessary for use of a spread median.

When a project has a spread median, a typical section shall be shown in the plans. When a spread median is proposed on a project and if adequate distance is available, separate roadway sections shall be provided. A 20-foot vertical curve is suggested for rounding of the intersecting slopes as shown in 1-6E, F-1.

In locations where a spread median is being constructed and it is proposed to leave a portion of the median undisturbed, the areas shall be clearly marked on the plans. If it is proposed to only leave a few selected trees, they should be clearly marked.

FIGURE 1

1-6E
F-1

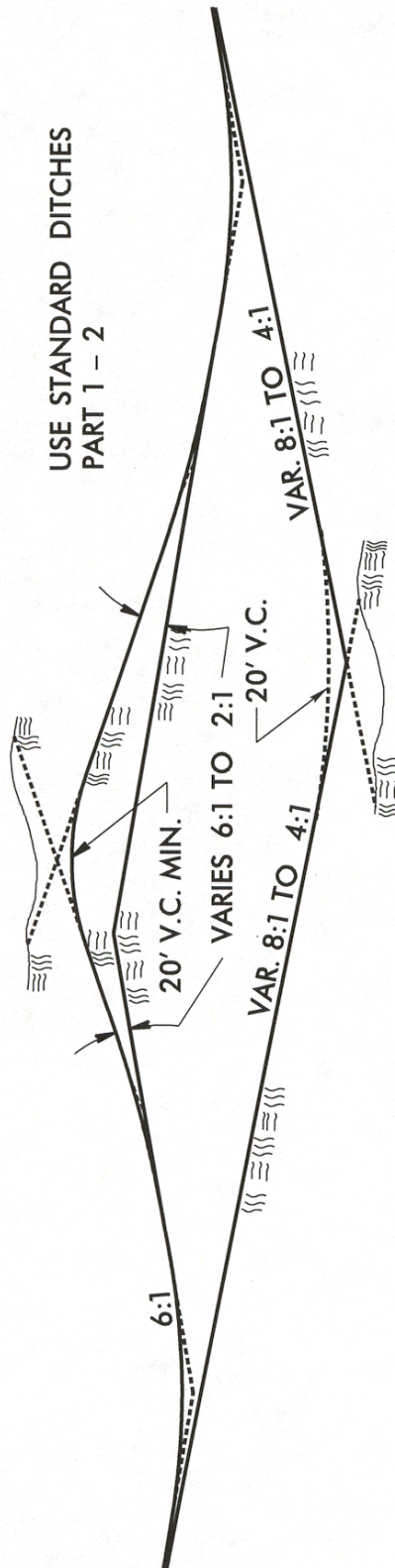

NOTE:

1. CHECK "ROADSIDE DESIGN GUIDE" FOR MEDIAN SLOPE.
2. USE THE SAME HINGE POINT AS FOR THE OUTSIDE IN UNDISTURBED MEDIANS.

GRADING OF SPREAD MEDIAN

MEDIAN SLOPES**1-6F**EXISTING MEDIANS

The median slopes should be as flat as reasonable to provide safe recovery areas for out-of-control vehicles. However, it is also necessary to provide an adequate ditch depth for drainage of the median and pavement structure. The following median slopes are recommended for proposed projects involving existing medians:

**MAXIMUM ALLOWED MEDIAN SLOPE
(Existing Median)**

MEDIAN WIDTH	30'	36'	44'	46'	68'
MAXIMUM SLOPE NORMAL SECTION	5:1	5:1	6:1	6:1	6:1
SUPERELEVATION (LOW SIDE)	5:1	5:1	6:1	6:1	6:1

A 6:1 slope is considered desirable. However, a 4:1 slope is acceptable if the situation warrants. (i.e., a 4:1 slope is necessary for positive drainage and/or drainage of the pavement structure)

MEDIAN SLOPES (continued)**1-6F**

- NOTE:
1. For projects with flat grades, variable median slopes that increase the ditch grade to improve longitudinal drainage capability shall be considered.
 2. Ditch slopes should meet "Roadside Design Guide" criteria for preferred ditch sections.

PROPOSED MEDIANS
(New Roadways)

When determining the width and maximum (steepest) slopes of a proposed median, consideration shall be given to the following design criteria:

A - Design Year Traffic Volume and Level of Service

B - Design Speed

C - Clear Zone Requirements "Roadside Design Guide"

D - Adequate Drainage of the Pavement Structure

When optimum median width has been established, the ditch slopes should be set as shown in Part 1-2B, Figure 1 thru 4. In no case shall the slopes be steeper than those specified for existing medians.

NOTE: The important hydraulic role of the median ditch in removing water from the roadway surface and protecting the integrity of the pavement structure cannot be overly stressed. In order to provide adequate drainage, shoulder drains and underdrains shall be considered along with median slopes, which will adequately drain both the roadway surface and subgrade. The Pavement Management Unit will make recommendations to the Design Engineer on a project by project basis.

EARTH BERM MEDIAN PIER PROTECTION**1-6G**

With median widths 70' and less, Pier Protection shall be provided. An earth berm, guiderail, or guardrail shall be placed as pier protection, when the median width is 70'. When earth berms are placed, pier footings shall be designed accordingly and slope protection placed according to the applicable standards. An earth berm for pier protection is desirable for medians 70' wide (Roadway Standard Drawings, Std. No. 225.08). If the earth berm is not feasible or cost effective, guardrail or guiderail should be utilized.

Median widths over 80' require no impact protection. For additional information, see 17/2 in the Policy and Procedure Manual. See Roadway Standard Drawings, Std. No. 225.08.

MEDIAN DESIGN ON STRUCTURES**1-6H**

See Part I, Chapter 6-4 of this manual.

MEDIANS ON -Y- LINES**1-6I**

The type of median to be constructed in interchange areas shall be determined early in the design stage. If raised islands are proposed across the structure, this shall be shown on the structure recommendations. See Part I, Chapter 6-6 of this Manual.

MEDIAN CROSSOVER GUIDELINES**1-6J****Median Crossover Guideline Statement**

Median divided facilities provide the benefits of separating opposing travel lanes, controlling left turn conflicts, allowing a recovery area for out of control vehicles, and a space for future travel lanes. Research data also concludes that the median divided facilities improve traffic flow (travel speeds), traffic operations (reduces congestion), and traffic safety (lower crash rates), when compared to non-divided facilities. Median crossovers may be necessary on median divided facilities that are not fully access controlled to allow for additional turning and through movements. A median crossover is defined as any connections of the opposing travel lanes that crosses the median of a divided highway. Median crossover includes directional crossovers, U-turns or all-movement crossovers.

Placement of crossovers should be considered carefully since crossovers introduce conflict points along a divided facility and thus may reduce the safety and capacity of the median divided facility. Therefore, it is important to follow these guidelines when considering the addition of median crossovers. The following guidelines have been developed as a guide for design engineers, traffic engineers, and field personnel when considering the placement or addition of median crossovers. The median crossover guidelines shall be used for all new crossovers, even in the cases where adjacent crossovers were approved under previous guidelines.

MEDIAN CROSSOVER GUIDELINES (continued)**1-6J****Types of Crossover Design**

When a crossover is deemed justified by the Department, the only the crossover type that meets the operational and safety needs of the location will be considered. The type of crossover design below is listed from the most desirable to least desirable.

- Use of alternative routes and access: This level uses the existing infrastructure of streets, highways, intersections and existing crossovers to provide the mobility that a proposed crossover would serve.
- Directional Crossovers: A directional crossover provides for left-turns in one direction only. These crossovers are preferred because they provide for the predominant movement and are much safer for the traveling public. This technique provides positive access control on major roadways through the design of median openings to allow only designated movements. Typically, these crossovers only provide for left turns from the major route to the side street. No left turns or straight across movements are allowed from the side street. Where the minimum spacing requirements are not met and there is a defined need for left-turn access, then only a directional crossover will be considered. However, the general guidelines must be met for the directional crossover to be considered.
- Median U-turn Crossovers: Median U-turns allow a vehicle to make a U-turn and do not allow for through movement from a side street or driveway.
- Directional Crossovers with Median U-turns: The combination of these two crossover types may be used on a case to case basis where it is deemed desirable. For more information see Part I – Chapter 9 - 4 – F1 thru F3 for detailed guidelines.
- All-Movement Crossovers: All-movement crossovers provide for all movements at the intersection or driveway. The use of all-movement crossovers is reserved for situations where there is sufficient spacing and other crossover designs cannot adequately meet the operational needs of the location. The use of this crossover design should be limited because it decreases capacity; increases delay and congestion; may increase pollutants from vehicles; and some studies indicate that they have a higher propensity for crashes.

General Guidelines for Median Crossover Installations on New and Existing Facilities:

All proposed median crossovers on existing and new facilities shall be evaluated from an operational and safety perspective. The availability of reasonable alternative routes, access points, existing crossovers, along with the desire to preserve the capacity and safety of the facility shall be considered in all proposed crossovers.

The availability of adequate spacing for a crossover shall be considered when determining if a crossover is justified. However, the availability of adequate spacing alone does not warrant a new crossover.

MEDIAN CROSSOVER GUIDELINES (continued)**1-6J**

A median crossover shall only be considered when the Department deems it necessary to service traffic generated by existing (and proposed) roadways, businesses or other development; and this traffic cannot be adequately serviced with the existing crossovers at intersections, reasonable alternative routes or other access points.

It is the requesting party's responsibility to provide the justification, or means to acquire the information for justification, for new crossovers. If this information is not provided, the crossover will not be reviewed or approved.

When the Department has deemed a median crossover is necessary, the only crossover type considered will be that which meets the operational and safety needs of the facility.

A median crossover shall not be allowed unless an adequate length left turn deceleration lane and taper can be provided and the addition of the crossover will not impede the storage requirements of adjacent intersections. Left turn lanes will be installed to serve all non-emergency crossover movements allowed on the divided facility at the time of installation.

When crossovers are considered, U-turns must be adequately accommodated or restricted. If trucks and large vehicles are expected to use the crossover, then design vehicle shall be selected to accommodate these movements.

Median Crossovers shall not be located where intersection sight distance (both vertical and horizontal) cannot meet current NCDOT design criteria.

Median crossovers shall not be placed in areas where the grade of the crossover will exceed 5 percent. Special consideration should be given to the vertical profile of any median crossover that has the potential for future signalization to ensure a smooth crossing from a present or future side street.

While it is desirable to have median widths 23 feet or greater, a median crossover shall not be provided where the median width is less than 16 feet.

Crossovers that require a signal or where there is expected potential for a future signal in an otherwise unsignalized area should be avoided.

The Department retains the authority to close or modify any crossover that it deems to be operationally unsafe to the traveling public.

MEDIAN CROSSOVER GUIDELINES (continued)**1-6J****Median Crossover Guidelines for North Carolina Streets and Highways****Interstate and Non-Interstate Highways with Full Control of Access:**

No public-use median crossovers will be allowed.

U-turn median openings for use by authorized vehicles for the maintenance and policing of highway or emergency response can be allowed when an engineering study clearly indicates a need. The spacing of the median openings should abide by the following guidelines:

U-turn median openings can be provided if a need has been determined and that they can be added in a safe location where decision sight distance is available. When adding a crossover, it should be located at least one half mile from any overhead structure and at least one mile from the terminus of a ramp acceleration lane or a deceleration lane. The median crossover should be signed appropriately.

The minimum spacing of adjacent U-turn median crossovers between interchanges is three miles. However, spacing alone is not justification for a crossover.

On urban freeways, the interchange spacing is generally close enough that openings are not warranted. Therefore, U-turn openings are not allowed. In addition, on facilities where acceptable gaps are unlikely due to high ADTs, U-turn openings are not allowed.

**Divided Highways without Full Control Access
(Posted speeds of greater than 45 mph)**

On highways with higher traveling speeds, the potential for more severe crashes is greater. Also, on high-speed facilities, development is usually not as concentrated as on lower speed facilities. In order to maximize the safety of these facilities, crossover spacing is critical.

All-movement crossovers shall not be any closer than **2000 feet** apart on divided highways. However, spacing alone is not justification for a crossover. It must be determined that a crossover addition is needed to meet the operational requirements of the facility. Where this spacing requirement is not met and there is a defined need for left-turn access, then a directional crossover will be considered. However, the general guidelines must be met in order for the directional crossover to be added.

MEDIAN CROSSOVER GUIDELINES (continued)**1-6J****Divided Highways without Full Control Access
(Posted speeds of 45 mph and less)**

There is usually more demand for median crossovers and the speed limit is lower. Because of the density of the development and lower traffic speeds, it is acceptable to provide a closer spacing of median crossovers. However, the availability of adequate spacing alone is not justification for a crossover. Crossovers must be justified to meet operational and access needs that the existing facility cannot adequately serve. Only the type of crossover that meets the operational, access and safety needs of the facility shall be added. Directional crossovers are preferred where they meet the operational and access needs of the roadway.

The spacing of crossovers will be largely dependent upon the need for adequate storage for left turning vehicles/U-turn vehicles at intersections. **A crossover shall not be placed where it interferes with the storage requirement for existing intersections.**

All-movement crossovers shall not be spaced any closer than **1200 feet** apart on divided highways with posted speed of 45 mph and less. Where this spacing requirement is not met and there is a defined need for left-turn access, then a directional crossover will be considered. However, the general guidelines must be met in order for the directional crossover to be added.

Responsibility of Locating Crossovers on Active Roadway Design Projects:

While a project is in design and during the life of the construction of the project, the Project Engineer and Project Design Engineer will locate the crossovers for the highway. Only crossovers at arterials, major collectors, and major traffic generators will be shown on the hearing maps. The Division Office shall be consulted regarding the level of access management desired for the project.

The engineer in the Highway Design Branch will determine if the crossover is justified and then determine the appropriate crossover design type. Priority will be given to placing median crossovers at existing intersecting streets. After the crossovers are located for existing streets that justify a crossover, the engineer will examine the remainder of the highway facility, along with reasonable alternative routes and access points, to determine if there are any other major traffic generators that require consideration for a crossover. When considering the intermediate crossover locations, the minimum spacing as outlined previously in these guidelines is to be followed. The crossover design that meets the operational, access, and safety requirements will be shown.

All crossovers are subject to the review of the Transportation Mobility and Safety, the Division Office, and the appropriate local officials if applicable.

MEDIAN CROSSOVER GUIDELINES (continued)**1-6J**

Some special circumstances may justify the need to deviate from these guidelines. If requests are made for crossovers that deviate from these guidelines, the Transportation Mobility and Safety Branch and the Division Office will review the location of the crossover and offer recommendations. The State Design Engineer will be responsible for granting any exceptions to these guidelines on active design and construction projects. Prior to approval of any contractual agreements for crossovers, all negotiated crossovers must be reviewed and approved by the Transportation Mobility and Safety Branch, the Preconstruction Branch, Division Office, and the appropriate local officials if applicable.

Some special circumstances may justify the need to deviate from these guidelines. If requests are made for crossovers that deviate from these guidelines, the Transportation Mobility and Safety Branch and the Division Office will review the location of the crossover and offer recommendations. The State Design Engineer will be responsible for granting any exceptions to these guidelines on active design and construction projects. Prior to approval of any contractual agreements for crossovers, all negotiated crossovers must be reviewed and approved by Transportation Mobility and Safety Branch, the Preconstruction Branch, Division Office, and the appropriate local officials if applicable.

Final approval or denial of the request shall be the responsibility of the State Traffic Engineer. If any aspect of the requested median crossover deviates from the guidelines, the Transportation Mobility and Safety Branch and the Division Office will confer to determine the necessary action to be taken. The State Traffic Engineer will be responsible for granting any exceptions to the guidelines on existing facilities. The State Traffic Engineer will notify the Division Engineer of the decision reached.

Crossovers Considered for Private Developments on Existing facilities:

A private development that justifies direct access and benefits from an added median crossover will be responsible to construct or fund its installation. In addition, it is the responsibility of the requesting party to provide the justification, or means to acquire the information for justification, for new crossovers. If this information is not provided, the crossover will not be reviewed or approved. The developer will be required to submit a complete set of plans and specify the exact location, design, and construction requirements for the proposed median crossover. Only the type crossover that meets the operational and safety needs of the facility shall be added. Directional crossovers are preferred where the design meets the operational and access needs of the roadway. Approval of such a crossover is subject to a traffic engineering investigation and approval procedures as outlined in these guidelines.

MEDIAN CROSSOVER GUIDELINES (continued)**1-6J**

Any drainage facilities required by the construction of the crossover will be installed or funded by the developer or the applicant at their expense. After the construction has been completed in accordance with the Division of Highways requirements and standards, and passes the District Engineer inspection, the Division of Highways will assume ownership and maintenance of the crossover.

Failure to comply with the location, design, or construction requirements will result in the crossover being barricaded or removed until the deficiencies have been corrected at the applicant's expense. Once the Division of Highways assumes the ownership, the median crossover will then be subject to the regulations exercised under the police power of the State.

The Department retains the authority to close or modify any crossover that it deems to be operationally unsafe to the traveling public; or causes undue delay, congestion or adversely impacts traffic operations.

Special Use Crossovers

Median crossovers for special purposes, such as fire protection, ambulance services, etc. shall be considered on an individual basis after a traffic engineering investigation.

Emergency response plans and expected level of need, in addition to the geometric limitations of the facility will be used in consideration for special use crossovers. Approved special use crossovers shall be appropriately designed, delineated, and regulated. However, the availability of adequate spacing alone does not warrant a new crossover.

SIDEWALK **1-7**

Sidewalks are warranted on projects in accordance with Pedestrian Policy Guidelines. If sidewalk construction is proposed, it will usually be included in the project planning report.

SIDEWALK WIDTHS **1-7A**

Desirable – 5' (residential), 10' (commercial and school routes)

Minimum – 4' (residential), 5' (commercial and school routes)

The above widths are adequate for most projects, but heavy pedestrian traffic may warrant wider widths.

SIDEWALK SLOPE **1-7B**

Rises at 0.02 from back edge of curb and gutter.

SIDEWALK THICKNESS **1-7C**

Unless unusual conditions are proposed in the planning report, 4" concrete shall be used. See Roadway Standard Drawings, Std. No. 848.01.

BERM WIDTHS WITH AND WITHOUT SIDEWALK **1-7D**

The following berm widths show desirable and minimum sections. If sidewalk is not constructed initially but is anticipated, one of these sections shall be constructed. See 1-7D, F-1 for Desirable Widths and 1-7D, F-2 for Minimum Widths.

See 1-7D, F-4 for Detail for Placement of Utility Poles in Curb and Gutter sections posted 45 mph or less.

WHEEL CHAIR RAMPS **1-7E**

Curb ramps for the handicapped shall be designed in accordance with a manual entitled "Guidelines Curb Cuts and Ramps for Handicapped Persons". For additional information, see 5/4 in the Policy and Procedure Manual. See Roadway Standard Drawings, Std. No. 848.05 for additional information.

FIGURE 1

DESIRABLE BERM WIDTHS

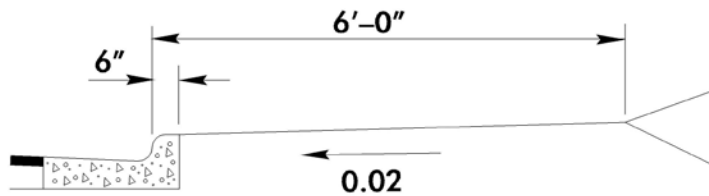
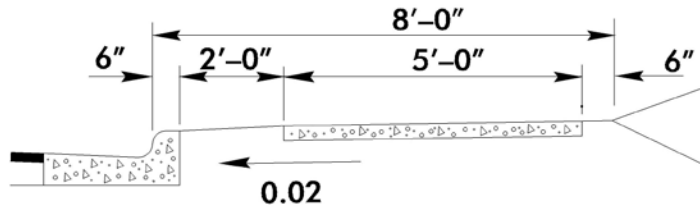
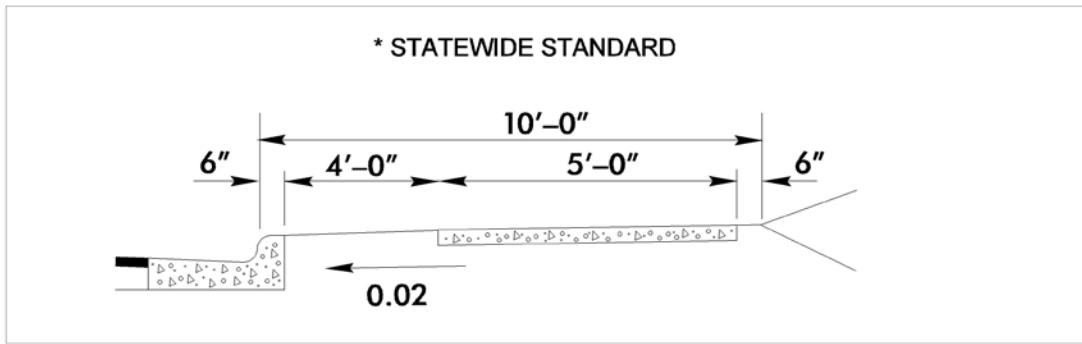
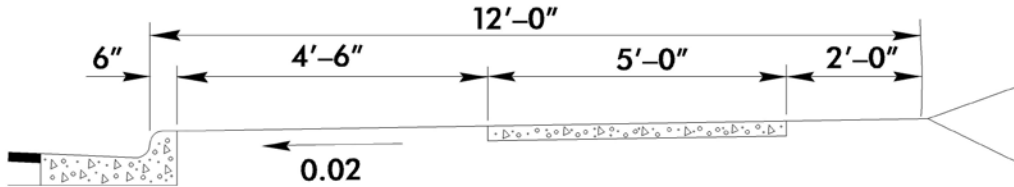

* STATEWIDE STANDARD SHOULD BE USED ON PROJECTS WHERE SIDEWALKS ARE PROPOSED. MORE NARROW BERMS MAY BE USED ON PROJECTS WITH RIGHT-OF-WAY RESTRICTIONS OR TERRAIN CONSTRAINTS. WIDER BERMS MAY BE NEEDED AT GUARDRAIL LOCATIONS (SEE STD. 862.01, SHEET 11 OF 11).

FIGURE 2

1-7D

F-2

MINIMUM BERM WIDTHS

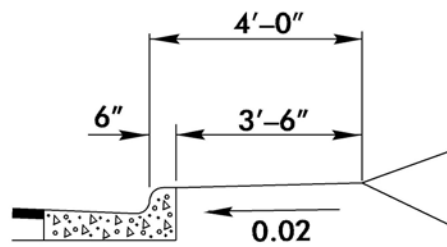
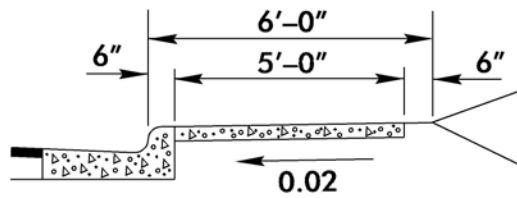
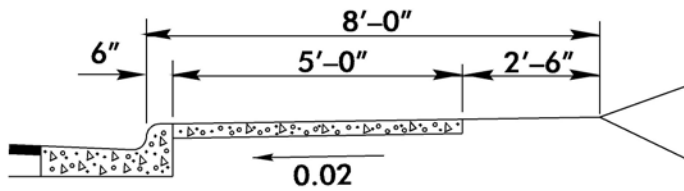
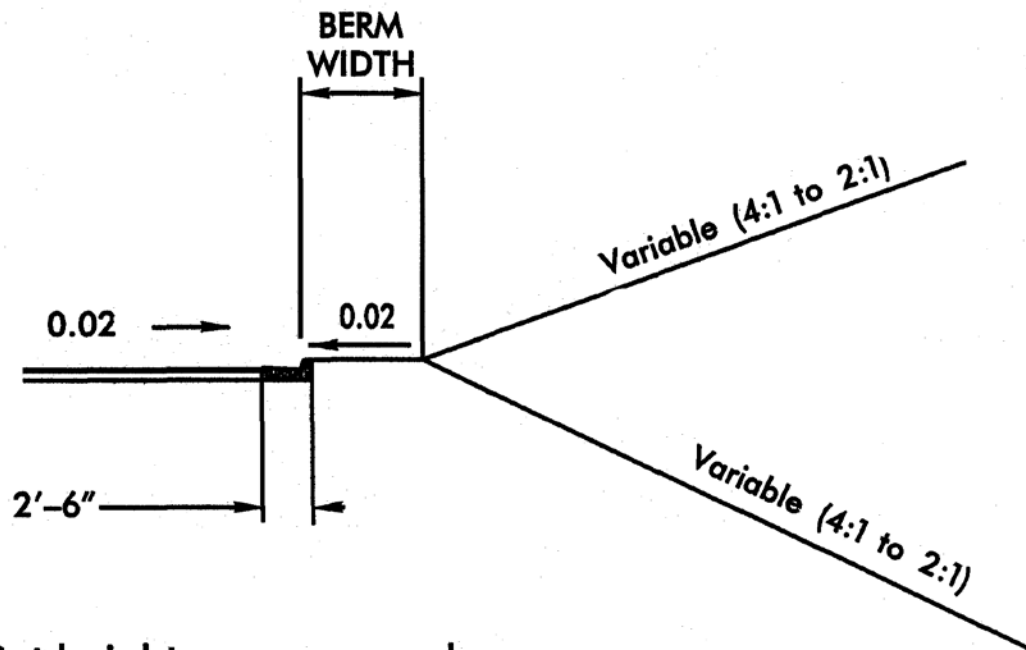

FIGURE 3

1-7D
F-3

Proposed Typical Curb and Gutter Section Statewide



Fill or Cut heights	slope
0-5'	4:1
5'-10'	3:1
> 10'	2:1

FIGURE 4

1-7D
Fig. 4

DETAIL FOR PLACEMENT OF UTILITY POLES IN
CURB AND GUTTER SECTIONS POSTED 45 MPH OR LESS

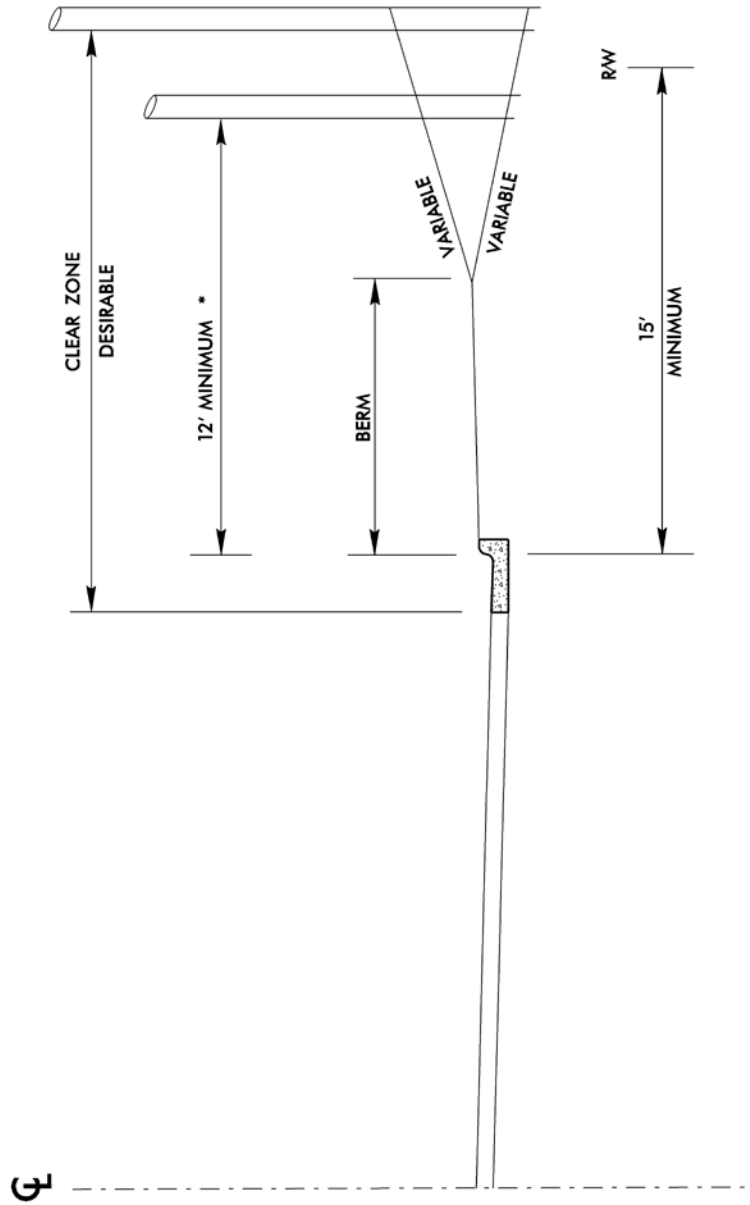

* UTILITY POLES PLACED CLOSER THAN 12 FEET SHALL BE BREAKAWAY POLES

RAISED ISLANDS**1-8**

Flush pavement with markings is often more desirable than raised islands especially where speeds exceed 45 mph. However, when it has been determined that raised islands will be required, both construction and maintenance costs should be considered.

In most instances, monolithic construction should be utilized on islands up to 16' in width due to greater cost-effectiveness, ease and speed of placement, and reduced future maintenance requirements. For widths greater than 16', cost-comparisons should be made between monolithic islands and grass covered islands with curb and gutter to determine the most cost-effective design. In making the determination, consideration should be given to the projected maintenance cost-savings of the monolithic island and the traffic operation requirements for the particular project.

Full depth pavement is normally utilized under the narrower bulb-type islands and under raised median islands when traffic operations during construction will require vehicular traffic in the median area. When traffic operations are not required in the median, it is more economical to place the monolithic island on a compacted aggregate base.

In special cases, grassed, landscaped, or covered islands may be used in urban or residential areas where recommended by the Division Engineer and approved by the Roadside Environmental, Construction, and Maintenance Units. These islands provide an aesthetically pleasing appearance with all surroundings, but only when well maintained. The construction costs of grassed or landscaped islands are considerably lower than those of monolithic islands. However, the greatly increased maintenance costs and the increased danger involved in maintenance operations prevents these islands from normally being justified except under unusual circumstances.

When any type of concrete curb is proposed on a project and it is not in accordance with Roadway Standard Drawings, Std. No's. 846.01, 852.01, and 852.02, a special detail shall be shown in the plans. The Plans and Standards Engineer in Project Services shall be consulted prior to drawing any details. This section has developed several concrete curb configurations that provide satisfactory results. For raised island treatment on structures, see this Manual Part I, Chapter 6-6G.

STANDARD CONCRETE CURB AND GUTTER**1-9**

See Roadway Standard Drawings, Std. No. 846.01.

All utility poles shall be placed outside the Clear Zone as defined by the 2011 Roadside Design Guide.

For Curb and Gutter where posted speed is 45 MPH or less, all utility poles shall be placed outside the Clear Zone where practicable. If this cannot be achieved due to right of way restraints, the utility pole may be placed a minimum of 12 feet from the face of the curb. All utility poles that are placed closer than 12 feet shall be breakaway poles. See Figure 1-7D, F-4 for Detail.

STEPS**1-10**

The type of steps to construct shall be determined by the Division Engineer. When existing steps are being disturbed, it is customary to replace the same type of step. For additional information, see Roadway Standard Drawings, Std. No's. 844.01 and 844.02.

SPIRAL CURVES**1-11**

Spiral curves are required on interstates, freeways, expressways and all major arterials. Where terrain and topography restrict their use, the Project Engineer will have the option to delete spirals on collector roads, local roads and streets, and on minor arterials with a design speed less than 45 mph. Spirals (including tangent runout) should be avoided on bridges and in all cases should not begin or end on the bridge. In cases where spirals are absolutely required on bridges, the increment spacing should be equally spaced across the entire length of the bridge.

There are several methods for computing the length of Spirals. The recommended method for determining spiral lengths is to use A POLICY ON GEOMETRIC DESIGN OF HIGHWAYS AND STREETS (2011), Chapter 3.

COMPOUND SPIRALS**1-11A**

Compound Spirals should be used between two curves if the radius of one curve is twice the radius of the second curve.

Compound Spirals should also be used on all interstates, freeways, expressways, arterials, and on ramps in interchange areas as the preferred method to change superelevation rates.

DESIGN CONTROL FOR VERTICAL CURVES**1-12****Design Controls for Crest Vertical Curves-Open Road Conditions**

See “A POLICY ON GEOMETRIC DESIGN OF HIGHWAYS AND STREETS ” (2011),
TABLE 3-34 and FIGURE 3-43

Design Controls for Sag Vertical Curves-Open Road Conditions

See “A POLICY ON GEOMETRIC DESIGN OF HIGHWAYS AND STREETS ” (2011),
FIGURE 3-44 and TABLE 3-36.

**Table 3-36. Design Controls for Sag
Vertical Curves**

US Customary			
Design speed (mph)	Stopping sight distance (ft)	Rate of vertical curvature, K ^a	
		Calculated	Design
15	80	9.4	10
20	115	16.5	17
25	155	25.5	26
30	200	36.4	37
35	250	49	49
40	305	63.4	64
45	360	78.1	79
50	425	95.7	95
55	495	114.9	115
60	570	135.7	136
65	645	156.5	157
70	730	180.3	181
75	820	205.6	206
80	910	231.0	231

^a Rate of vertical curvature, K is the length of
curve (m) per percent algebraic difference
intersecting grades (A). $K=L/A$

Design Controls for Crest Vertical Curves Based on Passing Sight Distance

See “A POLICY ON GEOMETRIC DESIGN OF HIGHWAYS AND STREETS ” (2011),
TABLE 3-35.

MINIMUM WIDTH OF TRAVELED WAY AND SHOULDERS**1-13****Minimum Width of Traveled Way and Shoulders for Local Roads and Streets**

See “A POLICY ON GEOMETRIC DESIGN OF HIGHWAYS AND STREETS” (2011), TABLE 5-5.

Table 5.5 Local Roads - Minimum Width of Traveled Way and Shoulders

US Customary				
Design speed (mph)	Minimum width of traveled way (ft) for specified design volume (veh/day)			
	under 400	400 to 1500	1500 to 2000	over 2000
15	18	20 ^a	20	22
20	18	20 ^a	22	24 ^b
25	18	20 ^a	22	24 ^b
30	18	20 ^a	22	24 ^b
40	18	20 ^a	22	24 ^b
45	20	22	22	24 ^b
50	20	22	22	24 ^b
55	22	22	24 ^b	24 ^b
60	22	22	24 ^b	24 ^b
65	22	22	24 ^b	24 ^b
All speeds	Width of graded shoulder on each side of the road (ft)			
	2	5 ^{a,b}	6	8

^a For roads in mountainous terrain with design volume of 400 to 600 veh/day, use 18-ft traveled way width and 2-ft shoulder width.

^b Where the width of the traveled way is shown as 24 ft, the width may remain at 22 ft on reconstructed highways where there is no crash pattern suggesting the need for widening

^c May be adjusted to achieve a minimum roadway width of 30 ft for design speeds greater than 40 mph.

MINIMUM WIDTH OF TRAVELED WAY AND SHOULDERS(continued) 1-13**Minimum Width of Traveled Way and Shoulders for Collector Roads and Streets**

See “A POLICY ON GEOMETRIC DESIGN OF HIGHWAYS AND STREETS” (2011), TABLE 6-5.

Table 6-5. Collector Roads - Minimum Width of Traveled Way and Shoulders

US Customary				
Design speed (mph)	Minimum width of traveled way (ft) for specified design volume (veh/day) ^a			
	under 400	400 to 1500	1500 to 2000	over 2000
20	20 ^b	20	22	24
25	20 ^b	20	22	24
30	20 ^b	20	22	24
35	20 ^b	22	22	24
40	20 ^b	22	22	24
45	20	22	22	24
50	20	22	22	24
55	22	22	24	24
60	22	22	24	24
65	22	22	24	24
All speeds	Width of shoulder on each side of road (ft)			
	2.0	5.0 ^c	6.0	8.0

^a On roadways to be reconstructed, a 22-ft traveled way may be retained where the alignment is satisfactory and there is no crash pattern suggesting the need for widening

^b A 18 ft minimum width may be used for roadways with design volumes under 250 veh/day.

^c Shoulder width may be reduced for design speeds greater than 30 mph provided that a minimum roadway width of 30 ft is maintained.

Notes: See text for roadside barrier and off-tracking considerations.

MINIMUM WIDTH OF TRAVELED WAY AND SHOULDERS(continued) 1-13**Minimum Width of Traveled Way and Usable Shoulders for Rural Arterials**

See “A POLICY ON GEOMETRIC DESIGN OF HIGHWAYS AND STREETS” (2011),
TABLE 7-3.

Table 7-3. Minimum width of Traveled Way and Usable Shoulder for Rural Arterials

US Customary				
Design speed (mph)	Minimum width of traveled way (ft) ^a for specified design volume (veh/day)			
	under 400	400 to 1500	1500 to 2000	over 2000
40	22	22	22	24
45	22	22	22	24
50	22	22	24	24
55	22	22	24	24
60	24	24	24	24
65	24	24	24	24
70	24	24	24	24
75	24	24	24	24
All Speeds	Width of usable shoulder (ft) ^b			
	4	6	6	8

^a On roadways to be reconstructed, an 22-ft traveled way may be retained where the alignment is satisfactory and there is no crash pattern suggesting the need for widening.

^b Usable shoulders on arterials should be paved; however, where volumes are low or a narrow section is needed to reduce construction impacts, the paved shoulder may be reduced to 2 ft provided that bicycle use is not intended to be accommodated on the shoulder.

MAXIMUM GRADES**1-14****Maximum Grades for Rural and Urban Freeways.**

See “A POLICY ON GEOMETRIC DESIGN OF HIGHWAYS AND STREETS” (2011), TABLE 8-1.

Table 8-1. Maximum Grades for Rural and Urban Freeways

US Customary							
Type of Terrain	Design Speeds (mph)						
	50	55	60	65	70	75	80
Grades (%) ^a							
Level	4	4	3	3	3	3	3
Rolling	5	5	4	4	4	4	4
Mountainous	6	6	6	5	5	—	—

^a Grades 1% steeper than the value shown may be provided in urban areas with right-of-way constraints where needed in mountainous terrain.

Maximum Grades for Rural Arterials

See “A POLICY ON GEOMETRIC DESIGN OF HIGHWAYS AND STREETS” (2011), TABLE 7-2.

Table 7-2. Maximum Grades for Rural Arterials

US Customary									
Type of terrain	Maximum grade (%) for specified design speed (mph)								
	40	45	50	55	60	65	70	75	80
Level	5	5	4	4	3	3	3	3	3
Rolling	6	6	5	5	4	4	4	4	4
Mountainous	8	7	7	6	6	5	5	5	5

Maximum Grades for Urban Arterials

See “A POLICY ON GEOMETRIC DESIGN OF HIGHWAYS AND STREETS” (2011), TABLE 7-4.

Table 7-4. Maximum Grades for Urban Arterials

US Customary	
Type of terrain	Maximum grade (%) for specified design speed (mph)
	30 35 40 45 50 55 60
Level	8 7 7 6 6 5 5
Rolling	9 8 8 7 7 6 6
Mountainous	11 10 10 9 9 8 8

Maximum Grades for Rural Collectors

See “A POLICY ON GEOMETRIC DESIGN OF HIGHWAYS AND STREETS” (2011), TABLE 6-2.

Table 6-2. Maximum Grades for Rural Collectors

US Customary	
Type of terrain	Maximum grade (%) for specified design speed (mph)
	20 25 30 35 40 45 50 55 60
Level	7 7 7 7 7 7 6 6 5
Rolling	10 10 9 9 8 8 7 7 6
Mountainous	12 11 10 10 10 10 9 9 8

Note: Short lengths of grade in rural areas, such as grades less than 500 ft in length, one-way downgrades, and grades on low-volume rural collectors may be up to 2 percent steeper than the grades shown above.

MAXIMUM GRADES(continued)**1-14****Maximum Grades for Urban Collectors**

See “A POLICY ON GEOMETRIC DESIGN OF HIGHWAYS AND STREETS ” (2011), TABLE 6-8.

Table 6-8. Maximum Grades for Urban Collectors

US Customary									
Type of terrain	Maximum grade (%) for specified design speed (mph)								
	20	25	30	35	40	45	50	55	60
Level	9	9	9	9	9	8	7	7	6
Rolling	12	12	11	10	10	9	8	8	7
Mountainous	14	13	12	12	12	11	10	10	9

Note: Short lengths of grade in urban areas, such as grades less than 500 ft in length, one-way downgrades, and grades on low- volume urban collectors may be up to 2 percent steeper than the grades shown above.

Maximum Grades for Local Rural Roads

See “A POLICY ON GEOMETRIC DESIGN OF HIGHWAYS AND STREETS ” (2011), TABLE 5-2.

Table 5-2. Maximum Grades for Local Rural Roads

US Customary									
Maximum grade (%) for specified design speed (mph)									
15	20	25	30	40	45	50	55	60	
9	8	7	7	7	7	6	6	5	
12	11	11	10	10	9	8	7	6	
17	16	15	14	13	12	10	10	—	

Minimum Superelevation Runoff and Tangent Runout Lengths

See “A POLICY ON GEOMETRIC DESIGN OF HIGHWAYS AND STREETS ” (2011),
TABLE 3-17B.

Minimum Radius Using Limiting Values of (e) and (f).

See “A POLICY ON GEOMETRIC DESIGN OF HIGHWAYS AND STREETS ” (2011),
TABLE 3-7.

Diagrammatic Profiles Showing Methods of Attaining Superelevation for a Curve to the Right

See “A POLICY ON GEOMETRIC DESIGN OF HIGHWAYS AND STREETS ” (2011),
FIGURE 3-16.

SUPERELEVATION RATES (continued)**1-15**

If maximum superelevation rates are used other than those shown the guidelines, it shall be discussed with the appropriate Assistant State Roadway Design Engineer.

SUPERELEVATION GUIDELINES

TYPE OF ROADWAY	LOCATION & CONDITIONS	SUPERELEVATION (1)
Interstates & Freeways	<ul style="list-style-type: none"> Statewide 	.08 or .10 (2)
Ramps & Loops	<ul style="list-style-type: none"> Statewide 	.08
Flyovers (Directional ramps with bridges)	<ul style="list-style-type: none"> Statewide 	.06
Arterials & Rural Collectors	<ul style="list-style-type: none"> Statewide Limited Access 	.08
Arterials & Urban Collectors with 60 mph design speed or greater	<ul style="list-style-type: none"> Statewide Partial or no control of access 	.06
Urban Collectors with 50 mph or less design speed	<ul style="list-style-type: none"> Statewide Curb & Gutter or shoulders with driveways 	.04
Bridge replacement projects, locals, & Secondary Roads	<ul style="list-style-type: none"> Statewide 	.04 or .06 Choose table that fits characteristics of area

- (1) Refers to particular design superelevation table shown in the 2011 AASHTO "Green Book section 3.3.5" that the designer should use.
- (2) Don't use in locations susceptible to icy conditions.

Bridges – it is desirable to use a degree of curve that the superelevation will not exceed .06 on any bridge.

Hydroplaning Awareness Outline

- I. Contributing Factors
 - A. Water film and thickness
 - B. Pavement cross slope and longitudinal slope
 - C. Pavement roughness
 - D. Vehicle speed
 - E. Tire condition and so forth
- II. Identification of Problem Areas
 - A. Existing conditions
 1. Skid testing
 2. Accident Reports
 3. Visual Observation
 4. Reports from Department personnel and citizens
 - B. Proposed/Design Condition
 1. Design Analysis
 2. Accident Reports and so forth upon project completion (see Existing)
- III. Remedial and Countermeasures
 - A. Existing Condition
 1. Improve pavement surface – open graded asphalt friction courses
 2. Improved surface water removal
 - a. Improved drainage systems
 - b. Improved longitudinal and transverse pavement and shoulder slopes
 3. Warning signs
 - B. Proposed/Design Condition – Roadway Design
 5. Typical section
 - a. Pavement Cross Slope
 - b. Shoulder cross slope
 - c. Rooftop section
 6. Grades
 - a. Minimum of 0.3% (tangent and along VC)
 - b. Vertical Curves
 1. Sag (K factors greater than 167 can create drainage problems)
 2. Crest (avoid 0.3% except within 50 ft. of high or low point)
 7. Superelevation
 - a. Resolve SE about centerline instead of median EOP
 - b.
 - c. Avoid long SE transition areas
 8. Combination of the above factors

HYDROPLANNING AWARENESS OUTLINE (continued)**1-16****B. Proposed/Design Condition – Hydraulic Design****1. Hydrology**

- a. Design Storm Frequencies
- b. Drainage Areas (size, shape, cover, slope, future development)
- c. Discharge Rates (Hydrological Method)

2. Highway Geometry

- a. Longitudinal Slopes and Cross Slopes
- b. Grade Elevations
- c. Typical Sections

3. Critical Locations for Collecting Runoff

- a. Cross Drainage
- b. Points for Reducing Spread
- c. Sags
- d. Upgrade of Zero Cross Slopes
- e. Upgrade of Street Entrances
- f. Upgrade of Bridges
- g. Driveway Entrances

4. Highway Drainage Structures

- a. Cross Pipes, Culverts, Bridges
- b. Storm Drainage Systems (Catch Basin, Drop Inlets, Berm Inlets)
- c. Funnel Drains
- d. Bridge Scuppers

DESIGN CONTROLS FOR STOPPING SIGHT DISTANCE ON HORIZONTAL CURVES

1-17

See “A POLICY ON GEOMETRIC DESIGN OF HIGHWAYS AND STREETS ” (2011), FIGURES 3-22 and 3-23.

Passing Sight Distance for Design of Two-Lane Highways

See “A POLICY ON GEOMETRIC DESIGN OF HIGHWAYS AND STREETS ” (2011), TABLE 3-4.

**Table 3-4. Passing Sight Distance for
Design of Two-Lane Highways**

US Customary			
Design speed (mph)	Assumed Speeds (mph)		Passing Sight Distance(ft)
	Passed vehicle	Passing vehicle	
20	8	20	400
25	13	25	450
30	18	30	500
35	23	35	550
40	28	40	600
45	33	45	700
50	38	50	800
55	43	55	900
60	48	60	1000
65	53	65	1100
70	58	70	1200
75	63	75	1300
80	68	80	1400

DESIGN VALUES FOR TRAVELED WAY PAVEMENT WIDENING AND WIDTHS ON OPEN HIGHWAY CURVES AND TURNING ROADS

1-18

See “A POLICY ON GEOMETRIC DESIGN OF HIGHWAYS AND STREETS ” (2011), TABLES 3-29, 3-30 AND FIGURES 3-22, 3-23, 3-24.

DESIGN VALUES FOR TRAVELED WAY PAVEMENT WIDENING AND WIDTHS ON OPEN HIGHWAY CURVES AND TURNING ROADS(continued) 1-18

Table 3-29. Design Widths of Pavements for Turning Roadways

US Customary									
Pavement Width (ft)									
Radius on inner edge of pavement	Case I			Case II			Case III		
	One-lane, one-way operation- -no provision for passing a stalled vehicle			One-lane, one-way operation- -with provision for passing a stalled vehicle			Two-lane operation--either one way or two way		
Design traffic conditions									
R (ft)	A	B	C	A	B	C	A	B	C
50	18	18	23	20	26	30	31	36	45
75	16	17	20	19	23	27	29	33	38
100	15	16	18	18	22	25	28	31	35
150	14	15	17	18	21	23	26	29	32
200	13	15	16	17	20	22	26	28	30
300	13	15	15	17	20	22	25	28	29
400	13	15	15	17	19	21	25	27	28
500	12	15	15	17	19	21	25	27	28
Tangent	12	14	14	17	18	20	24	26	26
Width modification regarding edge treatment									
No stabilized shoulder	None			None			None		
Sloping curb	None			None			None		
Vertical curb:									
one side	Add 1 ft			None			Add 1 ft		
two sides	Add 2 ft			Add 1 ft			Add 2 ft		
Stabilized shoulder, one or both sides	Lane width for conditions B & C on tangent may be reduced to 12 ft where shoulder is 4 ft or wider			Deduct shoulder width; minimum pavement width as under Case I			Deduct 2 ft where shoulder is 4 ft or wider		
Note:	A	=	predominantly P vehicles, but some consideration for SU trucks.						
	B	=	sufficient SU-30 vehicles to govern design, but some consideration for semitrailer combination trucks						
	C	=	sufficient bus and combination-trucks to govern design						

DESIGN VALUES FOR TRAVELED WAY PAVEMENT WIDENING AND WIDTHS ON OPEN HIGHWAY CURVES AND TURNING ROADS(continued) 1-18

Table 3-30. Range of Usable Shoulder Widths or Equivalent Lateral Clearances Outside of Turning Roadways, Not on Structure

US Customary		
Turning roadway condition	Shoulder width or lateral clearance outside of traveled way edge (ft)	
	Left	Right
Short length, usually within channelized intersection	2 to 4	2 to 4
Intermediate to long length or in cut or on fill	4 to 10	6 to 12

Note: All dimensions should be increased, where appropriate, for sight distance.

MINIMUM TURNING PATHS FOR DESIGN VEHICLES

1-19

See "A POLICY ON GEOMETRIC DESIGN OF HIGHWAYS AND STREETS" (2011), FIGURES 2-1 thru 2-23.