



STATE OF NORTH CAROLINA
DEPARTMENT OF TRANSPORTATION

LOGO MANUAL
JANUARY 2024

TRANSPORTATION MOBILITY AND SAFETY DIVISION

BACKGROUND

Specific Service Signs, which are referred to as Logo signs, are signs that identify and provide directions to qualifying gas, food, lodging, camping, and attraction businesses that furnish services to motorists at or near full or partial controlled interchanges or intersections. The North Carolina Department of Transportation provides eligible businesses with the opportunity to be listed on official signs within the right-of-way of fully or partially controlled access highways in accordance with GS # [136-89.56](#) (*Appendix A*) and the North Carolina Administrative Code (19A NCAC [02E.0216](#) and 19A NCAC [02E.0221](#); *Appendix B*).

Although the primary purpose of the Logo Signing Program is to provide valuable services information to the highway user, many participating businesses have documented substantial increases in their sales, which benefits North Carolina's economy. The program is not intended to provide advertisement of information not specifically related to the approved services, which include gas, food, lodging, camping, and attractions.

This manual contains the basic principles that govern the implementation of the Logo Signing Program in NC. It is important that these principles and guidance be given primary consideration in administering and executing logo agreements.

SUMMARY OF CURRENT RULES AND DEPARTMENT REGULATIONS

Businesses participating in the program shall comply with the following:

- The individual business installation whose name, symbol, or trademark appears on a business panel shall give in writing assurance of the business's conformity with all applicable laws concerning the provision of public accommodations without regard to race, religion, color, sex, age, disability, or national origin.
- An individual business under construction, may apply to participate in the program by giving written assurance of the business's conformity with all applicable laws and requirements for that type of service, by a specified date of opening to be within 60 days of the date of application. No business panel shall be displayed for a business that is not open for business and in full compliance with the standards required by the program. A business under construction shall not be allowed to apply for participation in the program if its participation would prevent an existing open business from participating, unless the existing business qualifies for or has a provisional contract.
- Businesses apply for participation in the program on a first-come, first-served basis until the maximum number of panels on the logo sign for that service is reached. Once an interchange or intersection is full and there are no logo spaces available, businesses will be placed on a **wait list**, maintained by the Department. If a

Introduction

business's panel is removed and space is available on the sign, or one or more of the existing businesses have provisional contracts, the next fully qualifying business on the waiting list shall be allowed priority for the vacant space.

- The Logo Program offers participation for five services: GAS, FOOD, LODGING, CAMPING, and ATTRACTIONS, as follows:
 - GAS and associated services. Criteria for erection of a business panel on a sign shall include:
 - 1) licensing as required by law;
 - 2) vehicle services for fuel (gas, diesel, or alternative fuels), motor oil, and water;
 - 3) on-premise public restroom facilities;
 - 4) an on-premise attendant to collect monies, make change, and make or arrange for tire repairs;
 - 5) year-round operation at least 16 continuous hours per day, seven days a week; and
 - 6) on-premise telephone available for emergency use by the public.
 - FOOD service. Criteria for erection of a business panel on a sign shall include:
 - 1) licensing as required by law, and a permit to operate by the health department;
 - 2) businesses shall operate year-round at least eight continuous hours per day six days per week;
 - 3) indoor seating for at least 20 persons;
 - 4) on-premise public restroom facilities; and
 - 5) on-premise telephone available for emergency use by the public.
 - LODGING service. Criteria for erection of a business panel on a sign shall include:
 - 1) licensing as required by law, and a permit to operate by the health department;
 - 2) overnight sleeping accommodations consisting of a minimum of 10 units each, including bathroom and sleeping room, except a Lodging business operating as a "Bed and Breakfast" establishment with fewer than 10 units may participate. "Bed and Breakfast" businesses shall be identified on the Logo signs by the standard message "Bed and Breakfast." "Bed and Breakfast" businesses shall only be allowed to participate in the program if the maximum number of qualified Lodging businesses do not request participation in the program and occupy spaces on the Logo signs. All "Bed and Breakfast" businesses shall have provisional contracts;
 - 3) adequate parking accommodations;
 - 4) year-round operation; and
 - 5) on-premise telephone available for emergency use by the public.

Introduction

- **CAMPING** service. Criteria for erection of a business panel on a sign shall include:
 - 1) licensing as required by law, including meeting all state and county health and sanitation codes and having water and sewer systems that have been duly inspected and approved by the local health authority (the operator shall present evidence of such inspection and approval);
 - 2) at least 10 campsites with accommodations (including on-premise public restroom facilities in a permanent structure) for all types of travel-trailers, tents, and camping vehicles;
 - 3) adequate parking accommodations;
 - 4) continuous operation, seven days a week during the "business season", defined as the times of year the campground is open to the public;
 - 5) removal or masking of said business panel by the Department during "non-business seasons", defined as the times of year the campground is not open to the public, if operated on a seasonal basis; and
 - 6) on-premise telephone available for emergency use by the public.

- **ATTRACTION** service. Criteria for erection of a business panel on a sign for any business or establishment shall include:
 - 1) licensing as required by law;
 - 2) on-premise public restroom facilities in a permanent structure;
 - 3) continuously open to the motoring public without appointment at least eight hours per day, five days per week during its normal operating season or the normal operating season for the type of business; where room is available on the sign and a business exists that does not meet the qualifying hours and days of operations or distance, a provisional contract is permitted. Provisional contracts shall contain a clause that if a fully qualifying business applies and there is not otherwise room on the sign for the new business, then the provisional contract of the business last on the sign shall be cancelled and the business panel shall be removed at the annual contract renewal date. It is the responsibility of the businesses with provisional contracts to update their contracts to non-provisional contracts (if they meet all qualifications) prior to receiving notice of cancellation. The contract in place on the date the Department receives a completed application from a fully qualified business shall be the contract used for the decision making purpose;
 - 4) adequate parking accommodations;
 - 5) on-premise telephone available for emergency use by the public; and
 - 6) only facilities whose primary purpose is providing amusement, historical, cultural, or leisure activities to the public and are categorized as follows shall be allowed signing:
 - a) Amusement Parks: Permanent areas open to the general public including at least three of the following activities: roller coasters, entertainment rides, games, swimming, concerts, and exhibitions;

Introduction

- b) Cultural Centers or Facilities: Locations for cultural events including museums, outdoor theaters, or a facility that exhibits or sells antiques or items painted or crafted by local artists;
 - c) Historic Sites: Buildings, structures, or areas listed on the national or state historic register and recognized by the Department as historic attractions or locations;
 - d) Leisure or Recreation Activity Areas: Attractions that provide tourists with opportunities such as golfing (excluding miniature golf, driving ranges, and chip and putt areas), horseback riding, wind surfing, skiing, bicycling, boating, fishing, picnicking, hiking, and rafting;
 - e) Manufacturing Facilities: Locations that manufacture or produce products of interest to tourists and offer tours at least four times daily on a scheduled year-round basis such as candy, ice cream, cookie, or pickle manufacturing facilities. Facilities shall produce or manufacture, and exhibit or sell their products at the facilities;
 - f) Agricultural Facilities: Locations that provide tours and exhibit or sell their agricultural products or provide on-site samples of their products, such as vineyards and regional farmers markets;
 - g) Zoological or Botanical Parks and Farms: Facilities that keep living animals or plants and exhibit them to the public;
 - h) Natural Phenomena: Naturally occurring areas that are of outstanding interest to the public, such as waterfalls or caverns; and
 - i) Motor Sports Facilities: Locations including museums, race tracks, and race team headquarters that exhibit or sell items related to automobile or truck racing.
- Any other ATTRACTION not listed in Item (6) of this Rule shall be approved by the State Traffic Engineer.
 - Ineligible Attractions include the following: shopping malls, furniture stores, drug stores, movie theaters; community business, historic, antique, or other districts; appliance stores, automobile or truck dealerships or garages, houses of worship, colleges, schools, real estate offices, sand and gravel facilities, produce stands, nurseries, grocery stores, restaurants, bars, lounges, adult establishments, and adult video, book, and novelty stores. An attraction is not eligible for both Specific Services (Logo) Signing and supplemental guide signing, such as Agriculture Tourism signing, at the same interchange.
- Businesses participate by executing an agreement with the Department, which includes signing the agreement and paying annual fees.
 - Businesses pay one annual rental fee of \$300 for each mainline, ramp, and trailblazer panel. The annual fee covers the cost of all Department program expenditures and activities. It does not include the costs related to design and fabrication of the individual business panel. No maintenance fees are required.

Introduction

(Participating businesses are responsible for the design, fabrication, and replacements of their business panels. Businesses provide their business panels to the Department.)

- A business may request logo signing at more than one interchange. All requests are based on first-come, first-served.
- The maximum distance that a GAS, FOOD, or LODGING service may be located from the fully or partially controlled access highway shall not exceed three miles at rural interchange/intersection approaches and one mile at urban interchange/intersection approaches in either direction via an all-weather road. Where no qualifying services exist within three miles (rural) or one mile (urban), provisional contracts are permitted where the maximum distance may be increased to six miles at rural interchange/intersection approaches and three miles at urban interchange/intersection approaches, provided the total travel distance to the business and return to the interchange does not exceed twelve miles. Provisional contracts shall contain a clause that if a closer business applies, qualifies, and is within the three miles (rural) or one mile (urban) distance as applicable, and there is not otherwise room on the sign for the new business, then the provisional contract of the furthest business from the intersection shall be cancelled and the business panels shall be removed at the annual contract renewal date. The maximum distance for a CAMPING or ATTRACTION service shall not exceed 15 miles in either direction via an all-weather road.
- Individual business logo panels shall only contain one service type and shall only be allowed on the corresponding service sign. For example, on the FOOD sign, even if the business provides combination GAS and FOOD services under one roof such as a BP and a McDonald's in one building, the FOOD business panel cannot include information about the GAS service. A separate GAS panel would be required.
- Restaurants must serve qualifying FOOD (meal) item(s) the entire time the business is open. Serving beverages, without qualifying meal items, is not considered qualifying for FOOD Logo sign participation. See detailed FOOD definition on NCDOT Qualification Survey Form.
- If a participating GAS, FOOD, or LODGING business at a rural interchange is further than one mile and has a Standard agreement, and the interchange becomes an urban interchange due to population growth, then the Department will cancel the Standard agreement held by the business and offer a Provisional agreement. *See Chapter Three - Agreements for when standard versus provisional agreements apply.* If at that time, a business located within the one mile distance requests participation, and there is not otherwise room on the sign for the requesting business, then the contract for the furthest business from the

Introduction

interchange (that is further than one mile from the interchange), shall be cancelled and the business panels shall be removed at the annual contract renewal date.

- Logo signs are not allowed at system (freeway to freeway) interchanges. Logo signs may be denied at a freeway to non-freeway interchange when it is determined by the coordinator that the route is difficult to sign or follow, or in cases that unfamiliar motorists may find it difficult to find their way back to the freeway from the business location.
- Logo Signs are to be installed as ground mounted only treatments. Overhead applications of Logo Signs are prohibited. This decision was made in collaboration with Chief Engineers office November 2023. Factors taken into account with this decision included the increased cost of overhead installation, maintenance, inspection and motorist visibility.

DEFINITIONS

The following definitions apply to the Logo Signing Program:

- 1) ***Specific Service Sign or Logo Sign*** is defined as a rectangular, white-on-blue sign bearing the message GAS, FOOD, LODGING, CAMPING, or ATTRACTIONS and appropriate directional information and including space for three or more individual business logo panels.
- 2) ***Combination Specific Service(Logo) Sign*** is defined as a rectangular, white-on-blue sign bearing the message, GAS, FOOD, LODGING, CAMPING, or ATTRACTIONS for two or more service types and appropriate directional information and including space for one or more individual business logo panels (*for example, GAS and FOOD, LODGING and CAMPING, etc*).
- 3) ***Logo Panel, Business Panel, or Panel*** is defined as a separately attached, rectangular sign that is owned and furnished by the participating business that bears the brand, symbol, trademark, or name (*or any combination thereof*) for the available service.
- 4) ***Supplemental Service Sign*** is defined as a rectangular, white-on-blue sign bearing the message GAS, FOOD, LODGING, CAMPING, or ATTRACTIONS (*or any combination thereof up to a maximum of three service types*) that is installed below a mainline logo or guide sign. These are only allowed when there is no space for a separate mainline logo sign for the service specified.
- 5) ***Full Control of Access*** is defined as having connections to a facility provided only via ramps at interchanges. All cross-streets are grade-separated. No private driveway connections are allowed. A control of access fence is placed along the

Introduction

- entire length of the facility and at a minimum of 1000 feet beyond the ramp intersections on the Y lines (minor facility) at interchanges (if possible). See [NCDOT Access Control Map](#).
- 6) **Partial Control of Access** is defined as having connections to a facility provided via ramps at interchanges, at-grade intersections, and private driveways. Private driveway connections are normally defined as a maximum of one connection per parcel. One connection is defined as one ingress and one egress point. The use of shared or consolidated connections is highly encouraged. Connections may be restricted or prohibited if alternate access is available through other adjacent public facilities. A control of access fence is placed along the entire length of the facility, except at intersections and driveways, and at a minimum of 1000 feet beyond the ramp terminals on the minor facility at interchanges (if possible). See [NCDOT Access Control Map](#).
 - 7) **No Control of Access** is defined as having connections to a facility provided via ramps at interchanges, at-grade intersections, and private driveways. No physical restrictions, i.e., a control of access fence, exist. Normally, private driveway connections are defined as one connection per parcel. Additional connections may be considered if they are justified and if such connections do not negatively impact traffic operations and public safety.
 - 8) **Rural Interchange** is defined as an interchange along a freeway (*interstate or other fully-controlled access arterial highway*) that is located either in a rural unincorporated area or within the corporate limits of a city/town with a population of less than 40,000.
 - 9) **Urban Interchange** is defined as an interchange along a freeway (*interstate or other fully-controlled access arterial highway*) that is located either in or within one mile of the corporate limits of a city/town with a population equal to or greater than 40,000.
 - 10) **GAS service** provides gas as primary service. It must comply with all administrative code requirements. Logo must include a recognizable name, symbol, or trademark for the fuel or must be a recognizable gas business name or logo. If the gas business name or logo is not recognizable to the general motorist as a gas service, the word “Gas” or “Fuel” must also be included in the business Logo panel.
 - 11) **FOOD service** provides food and beverage as primary service. It must comply with all administrative code requirements. A food service includes full service and fast service restaurants serving meals prepared on-premises. Sandwiches and salads that are prepared on the premises are considered a meal. Donuts or pastry items made on-premises are considered a meal. Ice cream dishes, or similar frozen food items, combined with a variety of other ingredients such as fruit and nuts are considered a meal. Ice cream products, frozen yogurt, etc., served by

Introduction

themselves, in cones, or pre-packaged are not considered a meal. A facility selling primarily non-alcoholic beverages such as specialty coffee drinks or smoothies that are prepared on-premises with several ingredients such as fruit and cream may be considered qualifying only if a fully qualifying meal (not beverage) item is also provided. A facility selling primarily alcoholic beverages is not considered qualifying. Pre-packaged food items, whether packaged in quantity or individually, are not considered qualifying food for the purpose of the Specific Service Signing (Logo Program). Food items prepared off the premises, and transported to the business for serving, or heating and serving, are not considered qualifying food for the purpose of the Specific Service Signing (Logo Program).

- 12) **Primary service** – To qualify under a particular service (Gas, Food, or Lodging, etc.), over 50% of the sales revenue for the business at that specific business location must come from the type service requested. For food service, beverage may be considered a portion of the food sales revenue only if at least one qualifying food/meal item is also available at the restaurant.
- 13) **First-Come, First-Served** – Where space is available on the sign, consideration is given to the first completed application received, based on date and time of receipt from interested business. The Department will maintain a waiting list of new or interested businesses only when all spaces on the logo sign are taken by fully qualifying operational businesses.

Table of Contents

Introduction	Page
• Background	1
• Summary of Current Rules and Department Regulations	1-6
• Definitions	6-8
Chapter One - Administration	
• General	9
• Role of the Division Logo Coordinator	9
• Process for Reviewing Standard Requests	9-10
• Project Scope	10-11
• Review of Business Panel Design	11-12
• Execution of the Logo Agreement	12
• Payment Process	12-13
• Maintaining Records	13
Chapter Two - Construction	
• New Logo Projects and Project Upgrades	14
• Inspections	14
• Coordination with other Projects	15-16
• Identification System	16
• Division Logo WBS Elements	16
• Sign Requisitions	16
• Vacant Logo Signs	17
• Vegetation Control	17
Chapter Three - Agreements	
• Standard and Provisional Annual Agreements	18
• Requirements for Agreements	19
Chapter Four – Location of Signs and Support Information	
• Criteria and Guidelines for Mainline and Ramp Signing	20-22
• Trailblazers Signing	22
• General Support Information and Guardrail Requirements	23
Chapter Five – Business Logo Panels	
• General Guidelines	24
• Composition of Business Panels and Logo Signs	24-25
• Business Panel Specifications	25-27

Chapter Six - Service Clarifications and Eligibility Requirements	
• Gas Service	28
• Food Service	28
• Lodging Service	28
• Camping Service	29
• Attraction Service	29-30
• Seasonal Camping and Attraction Services	30
Chapter Seven – Appeals Process	
• General	31
• Procedure	31
Chapter Eight - Business Issues	
• Business Failure to Pay Fees	32
• Removal of Business Panels	32-33
• Business in Bankruptcy	33
• Business Franchises	34
• Business in Non-Compliance	34
• Business Failure To Supply Business Panels	34
• Business Under Construction	35
• Business Closed for Renovation	35-36
• Business Closed/Out Of Business	36-37
• Termination of Logo Agreement	37-38
• Transfer of Ownership	38-39
• Refunds to Businesses	39-40
• Advertising Agencies	40

APPENDICES

Appendix A – General Statutes Pertaining to Logo Program

- GS # 136-89.56 (Commercial Enterprises)

Appendix B – North Carolina Administrative Code

- Specific Service Signing (Logo) Program

Appendix C – Listing of Logo Coordinators

Appendix D – Logo Forms

- TEB-221 – Qualification Survey
- TEB-223 – Standard Annual Rental Agreement
- TEB-223P – Provisional Annual Rental Agreement
- TEB-223B – Transfer of Ownership
- TEB-227 – Business Panel Requirements
- TEB-227A – Trailblazer Business Panel Consolidation

Appendix E – Logo Business Panel Face Specifications

Appendix F – Logo WBS Elements

Appendix G – Internal “S” Dimension Worksheets

Appendix H – New Logo Agreement Processing and Logo Contract Maintenance

Appendix I – Typical Interchange Layout for Logo Signing

- Layout for Double Exit Interchange
- Layout for Double Exit Interchange
- Logo Ramp/Loop Option
- Layout for Diamond Interchange

Appendix J – VA41 – Create Contract with Reference to Cancelled Contract

Appendix K – VA42 – Cancel Contract

Appendix L – FBL5N – Customer Line Item Display

Appendix M – Sample Invoice Letters

Appendix N – Logo Sign Design

Administration

GENERAL

The North Carolina Department of Transportation has 14 divisions throughout the state, and each Division has its own [Logo Coordinator](#) (*See Appendix C*). As the local Division's representative, the Logo Coordinator generally has first contact with the public. He/she should have a thorough understanding of the guidelines and policies, governing the Logo Program; appropriate contracts and agreements for participation; specification and installation of individual logo business panels design; construction of logo signing projects; and, submission of customer information electronically via the SAP process.

The Transportation Mobility and Safety Division (Signing and Delineation Unit) administers and oversees the Logo Program.

ROLE OF THE DIVISION LOGO COORDINATOR

The Division Logo Coordinator must respond to logo inquiries, prepare and execute appropriate agreements, review and approve logo business panel designs, let and award logo signing projects, and oversee the construction and maintenance of logo signing projects. The Logo Coordinator should have thorough knowledge of *Part 2J* of the latest Manual on Uniform Traffic Control Devices and SAP training material (*New Logo Agreement Processing and Logo Contract Maintenance*).

The Logo Coordinator constantly communicates with the public, especially with potential business owners and/or managers, and officially represents the NCDOT in all aspects of the Logo Program; therefore, possessing excellent customer service skills and being highly responsive to requests are essential functions of this position.

PROCESS FOR REVIEWING STANDARD REQUESTS

Official requests for participation are on a first-come, first-served basis. Official requests should be written and addressed to the local Division Engineer (where the interchange is located) with attention to the Division Logo Coordinator and must be made from the business owner or official representatives employed or authorized by the business. It should specify the interchange/intersection routes and exit number. Request should be made using the [Logo Application](#) link on the Signing and Delineation Website. As requests arrive at the Division Office, they should be stamped with the appropriate date and time in case there is a question later concerning which business's request arrived first.

After receipt of requests, the Logo Coordinator should complete the following steps:

1. An acknowledgment letter stating the date and time of receipt should be sent to the potential participant. It should also include a timeframe of when a review will be completed, based on current workload.
2. Conduct a field review to determine if there is available space for the specific service, if the business provides the service, and if the business meets eligibility (*a meeting with*

Administration

the business owner is not necessary if a denial is made based on a review of SAP or other office records). As a part of the review process, a Qualification Survey Form (see Form [TEB-221](#) in Appendix D) should be completed to document the appropriate information about the business. When meeting with a business owner or making a site visit, the Logo Coordinator should bring copies of the standard and provisional agreements and brochures. All pertinent material should be reviewed with the business owner or his/her representative. An actual face-to-face interview is recommended; however, the information could be obtained via telephone or written format. The Logo Coordinator should make the business owner aware that the entire process to install a business panel could take at least six to twelve months depending on whether or not the Department has to install a new sign (*this time is used for field verification, plan preparation, support design and fabrication, sign fabrication, and contractor selection and/or coordination*). If the Logo sign is already installed, State Forces may be able to install the business panel in a much shorter time frame, typically within 30 to 60 days.

3. (a) If, after the Logo Coordinator has determined that the business meets the program's eligibility requirements and sign space is available, the Logo Coordinator should proceed with preparing the appropriate contract/agreement (see Forms [TEB-223](#) and [TEB-223P](#) in Appendix D) and sending it to the potential participant for signatures. A Specific Services Signing Business (Logo) Panel Requirements form (see Form [TEB 227A](#) in Appendix D) is completed at this time and provided to the customer which includes the number and size of business panels required, panel delivery information, and total fee for the specific location. Total payment is not necessary until within 30 days prior to business panel and Logo sign installation. Prior to panel installation, a contract/agreement must be signed by the business owner, or designee, and executed by the Department.
- (b) If, the business meets the program's eligibility requirements and sign space is not available, the Logo Coordinator should prepare a response, stating that space is not available and that he or she will be placed on the Department's waiting list for that particular location, copying the State Signing Engineer.
- (c) If the business does not meet the program requirements, etc., the Logo Coordinator should send a letter to the business explaining why the request is being turned down. The letter should also contain appeal rights, as explained in *Chapter Seven*.

PROJECT SCOPE

The Logo Coordinator is responsible for conducting a field investigation as a part of the review process. During the field investigation, the Logo Coordinator will verify the distance from the interchange to the business, verify existing sign spacing along the mainline and ramps, determine if a new sign is necessary, verify that there is adequate sign spacing if a new Logo sign installation is required, determine if trailblazer panels are needed (*a trailblazer panel is required at all turns*), and/or review the existing signs and supports to see if there is a possibility that the existing supports could be reused with upgraded signs (*for example, change out a six panel sign to a combination sign or change*

Administration

an existing four panel sign to a six panel sign, etc.). For further information on sign spacing requirements, see *Chapter Four: Location of Signs and Support Information*.

Once it has been determined that a new Logo sign installation is recommended and or the existing Logo signs need upgrading with new supports, the Logo Coordinator must coordinate with the Signing and Delineation Unit or its designated representative to assist in plan preparation. The Logo Coordinator must provide the field verifications for all support locations unless a private engineering firm (PEF) is responsible for the “S” dimensions (*see Appendix G*). Supports are required to be breakaway unless installed behind guardrail, except for trailblazer panel locations, which may be mounted on u-channel posts. In general, signs with simple supports should have 150’ of leading guardrail and 50’ of trailing guardrail. The Signing and Delineation Unit or its designee will develop and submit a half-size (11” x 17”) Logo plan for each project, including a cost estimate, sign quantities, support requirements, and any project special provisions.

The Logo Coordinator will prepare a purchase order contract for new Logo sign installations unless the division has a designated signing contractor, commonly referred to as “on-call” or “blanket” signing contractor, already under contract. The contractor is responsible for sign installation, including support fabrication and installation.

Once the project has been awarded and the contractor has been notified to start work, the Logo Coordinator will prepare a requisition for the Logo signs from Correction Enterprises, charging the sign fabrication to the Division Logo account number (*See Appendix F for WBS elements*).

REVIEW OF BUSINESS PANEL DESIGN

The potential participant must furnish a proposed panel design (*typically designed by the participant’s selected fabricator*) for review and approval by the Logo Coordinator. See *Chapter Five* for further panel design guidelines and specifications.

Once the Logo Coordinator approves the proposed panel design, the business panel(s) can be fabricated and delivered to the Department. The business panel(s) should be installed as soon as possible after delivery within a 30-day time period and after receipt of all required fees. Any questions concerning the business panel design should be directed to the Signing and Delineation Unit.

Ideally, the Department should coordinate the business panels with the new Logo sign installations so they can be installed at the same time. If the Logo sign is already in-place, the Logo Coordinator should install the business panel within 30 working days after receipt of the business panel. If a business does not provide the business panel in the time period agreed upon, the Logo Coordinator shall send the business a certified letter (*return receipt requested*) and require the business to provide the business panel within 30 days of receipt of the certified letter. If the Logo Coordinator does not get the business panel(s) within the

Administration

specified time period, he or she should terminate the agreement and refund the business its money. If this occurs, the Coordinator may accept a request from another business for the open space.

EXECUTION OF THE LOGO AGREEMENT

Once the Logo agreement has been signed (and sealed if applicable) by the business, the agreement is returned to the Department for final review. *For further information on the Logo agreements, refer to Chapter Three: Agreements.* After the Division Engineer or his designated representative has executed the agreement, the original should be sent to the Logo Accountant, Accounting Operations/Accounts Receivable Unit, 1515 Mail Service Center, Raleigh, North Carolina 27699-1515. A copy of the agreement should be sent to the business owner and the Logo Coordinator should retain a copy. The Accounting Operations/Accounts Receivable Unit (Fiscal) will have the agreements and related documents scanned into the SAP Logo customer record. Once the agreements have been sent to Fiscal, the Logo Coordinator should review the SAP electronic records to verify that the agreements have been scanned within a week or two after transmitting to Fiscal. *(See Appendix H - New Logo Agreement Processing).*

PAYMENT PROCESS

Depending on the anticipated business panel installation date, checks or money orders for all required fees (*initial installation*) should not be accepted by the Department until execution of the agreement and the individual business panels are received and will be installed within 30 calendar days after receipt. In no cases should we accept payment earlier in the process, even if the customer desires to make an earlier payment. Cash should not be accepted for payment of Logo fees. Once a check or money order is received and accepted, it should be forwarded to the Accounting Operations/Accounts Receivable Unit as soon as possible, preferably within five working days.

If the check is returned for insufficient funds and the Logo Coordinator has possession of Logo panels, they should not be installed. No partial payments of Logo fees will be accepted. The Logo Coordinator should send the business a certified letter (*return receipt requested*), notifying them that the check has been returned for insufficient payment and request payment within 30 days. The letter should inform the business that their Logo signs will not be installed until full payment has been received.

At the yearly anniversary date of the panel installation, Fiscal should automatically invoice the customer for its yearly rental fees through its dunning process. This automatic process is generated based on the dates that have been entered into SAP. The contract start date, installation date, contract end date, etc., are all critical fields that must be accurately entered into SAP. Payment is due from the business within 30 days from receipt of the invoice unless otherwise specified in writing by the Department.

MAINTAINING RECORDS

Since the NCDOT enters into an agreement with a private party, it is extremely important for a Logo Coordinator to maintain accurate records of all activities with the private party. Although not mandated for every single activity, written records, including letters, memorandums, e-mail messages, telephone contact summaries, notes to file, etc., are indispensable. A Logo Coordinator should establish a record keeping system that he/she is comfortable with and then he/she should consistently put it to use. A good rule-of-thumb to follow is *records should be kept in such a manner that someone not familiar with the records could locate a needed file and readily retrieve information from it*. Also, the Logo Coordinator should keep a record of any billing problems or any name/ownership changes in the “notes” section of the BSIP (SAP) records. If a business panel is removed due to nonpayment/delinquency, the total amount owed including the time up to removal date shall be documented in the “notes” section.

The Attorney General’s office has advised that all written correspondence requiring some type of action from the business owner by a certain date/deadline must be sent by certified mail, return receipt requested. The phrase **CERTIFIED MAIL** should be typed in bold on the right hand side of the letter below the date. Once the green acknowledgment is returned, it should be stapled to the Department’s copy of the written correspondence. *(This information will prove invaluable in cases of litigation)*. General information provided via written correspondence does not have to be sent by certified mail. General information includes general program information, rules, guidelines, brochures, etc. Fiscal should be copied on any correspondence that requires the business to take action by a certain date, especially correspondence that concerns business panels or Logo sign removals.

NEW LOGO PROJECTS AND PROJECT UPGRADES

The Division Logo Coordinator may determine that a new Logo project is needed based on anticipated need or because he/she has received requests from businesses. For example, an outer loop project in an urban area has been completed and the coordinator noticed that several GAS and FOOD businesses have opened at an interchange. The Logo Coordinator does not have to wait until a business contacts him/her to request a project. He or she can anticipate the request and recommend that the interchange be added to the list of projects needing logo plans. The coordinator can also recommend that future services be shown on plans, even if none of these businesses are currently at the new interchange, based on his/her knowledge of the area and anticipation of future business development.

Sign upgrades are handled in the same manner; however, they do not necessarily require a complete set of plans unless new supports are involved. For instance, in some cases, it is possible to upgrade a 4-panel sign to a 6-panel sign and reuse the same supports. Once the new sign designs have been completed and sent to the coordinator, the Logo Coordinator should proceed with the necessary paperwork for the Logo customer and allow the customer to fabricate the Logo business panels.

Due to equity concerns with customers, extra requirements of Department resources, including sign erectors, equipment, etc. that may not be available, and more transactions with SAP for contract implementation and processing, the Department will not allow logo trailblazer installation before the mainline and ramp signs are installed for any logo project.

INSPECTIONS

All new Logo service sign installations should be inspected according to the Department's current specifications as contained in the *Standard Specifications for Roads and Structures and the Roadway Standard Drawings*. A Logo Coordinator may perform the necessary inspections, if properly trained, or seek assistance from the Resident/District Engineer's Office or the Materials and Test Unit. Training is available for all aspects of inspections and the Division training coordinator should be contacted for additional information.

The Materials and Test Unit will perform inspections on Logo projects; however, the Logo Coordinator must request the inspections preferably in advance of the Logo construction work starting. If assistance is needed with concrete inspection, contact the Resident Engineer's office. All inspection work can be charged to the Division Logo WBS element.

COORDINATION WITH OTHER PROJECTS

The Logo Coordinator should coordinate with the Resident Engineer and the appropriate Division Design staff to minimize any impact to the division's Logo signs during construction. The Logo Coordinator should also be included on the preliminary field inspection meeting contact list. He or she should review construction projects to determine possible impacts on Logo signs. Logo signs should be maintained during construction if at all possible. Logo signs may be placed on temporary wood supports during construction, if necessary, for short periods of time. If the logo signs are being relocated, removed or replaced, the contractor should be reminded that the logo panels belong to the business owner. If panels are damaged, the contractor will be responsible for replacing panels at his expense.

If the construction of an interchange on a State Transportation Improvement Program (STIP) project requires logo signs be relocated, the new support designs, quantities, and costs will be included in the STIP project; however, the STIP project will not cover costs for new logo signs. The Logo Coordinator should recommend to the Signing and Delineation Unit that new Logo sign designs are needed for the project and to ensure that supports are designed and included in the STIP construction plans. The new logo sign designs will be submitted to the Division Logo Coordinator for further handling. The Division Logo Coordinator should have the new signs installed after the STIP construction is complete.

During the construction of major projects involving ramp closures, it may be necessary to temporarily cover or remove existing logo signs. If logo signs are covered or removed, the Logo Coordinator should document construction progress by noting when signs were covered/removed and work closely with the Resident Engineer's Office to determine when signs will be uncovered or re-installed. The NCDOT may consider a refund to businesses if panels were covered or removed beyond a 6-month period, per the contract. Coordination with Fiscal (Accounts Receivable) is necessary when refunds are possible.

Occasionally, some or all of the existing Logo signs at an interchange cannot be relocated or replaced because of sign spacing or other issues. During the preconstruction conference for the project, the Logo Coordinator should remind the contractor that the panels on the Logo sign are the property of the businesses. If possible, the Logo Coordinator should contact the business at least 30 days in advance of the sign removal(s) to let them know the Logo signs must be removed because of the project. Once the business panels are removed, the contractor should turn them over to the Division Logo Coordinator for handling. The Division Logo Coordinator will notify the business that their signs are available for pick-up at a designated location and will be disposed of after 30 days.

Depending on whether or not all or some of the Logo signs at an interchange must be removed, it may be necessary to modify or terminate the Logo contract with the business

Construction

and refund the business for time remaining on their contract. This refund should be prorated based on the number of months times the number of signs that are removed prior to the end of the billing cycle. The Logo Coordinator should coordinate with Fiscal on refunding businesses. Once the business panels are removed from the Logo sign(s), the coordinator should notify the business that they have 30 days to pick up the panels before disposal of them by the Department.

PLAN IDENTIFICATION SYSTEM

Logo projects will have a unique designation. All new Logo projects (*non-STIP*) on fully controlled access highways will begin with “L” (*for Logos*) followed by division number, major route, and exit number. For example, L-04-I40-E319 indicating that the division is four (4), the major route is I-40, and the exit number is 319. It is critical that all information is appropriately entered into SAP. Please inform Fiscal when it is necessary to abbreviate or truncate.

If the Logo project (*non-STIP*) is installed on a fully controlled access highway where no exit numbers are available or on a partially controlled access highway, the exit number is replaced by the secondary route number and road name (*initials*). For example, L-07-SR2085-NGR indicates that the division is seven (7), the secondary route number is 2085, and NGR represents New Garden Road. Again, inform Fiscal when it is necessary to abbreviate or truncate.

The PO number is identified as the route, exit, and specific service type (1-Gas, 2-Food, 3-Lodging, 4-Camping, 5-Attraction). For example, I95-180-204 would be the PO number for a Subway Restaurant (204 indicates 4th Food business) on I-95 at exit 180.

DIVISION LOGO WBS ELEMENTS

The WBS element number for Logo projects is 36111.1.X, where X represents the division number (*see Appendix F*). All Logo project work should be charged to this number. For Logo project work on STIP projects, charge to the construction WBS element.

SIGN REQUISITIONS

When Logo service signs are requisitioned from the Department of Correction’s Sign Plant, a copy of the plan sheets should be sent with the requisition. Also, a separate requisition for each project should be prepared. Do not combine projects on a single requisition. All requisitions should reference the Logo project and WBS element number.

When Logo service signs are damaged by the contractor while working on a STIP project, the Resident Engineer should notify the Signing and Delineation Unit that a requisition for new Logo signs is needed. A message that reads, “Sign(s) to be paid for at

Construction

Contractor's expense" should be included on the bottom of the requisition and the signs should be charged against the wbs number for the construction project. The same procedure should be used when damaged signs are received directly from the sign plant with a message that reads, "Sign(s) to be paid for at Sign Plant's expense". If Logo signs are damaged by a vehicular accident, the driver or his insurance company is responsible for costs of the Logo sign repair if the responsible party can be determined. A damage claim will have to be processed if the Logo sign has been damaged in an accident.

VACANT LOGO SIGNS

Occasionally, a Logo service sign becomes completely vacant because there are no longer qualified businesses in the area. When this situation occurs, a Logo Coordinator should verify that qualified businesses do not exist and/or the potential for development in the very near future (*less than five years*) is not evident. If so, the Logo service sign and supports, including footings, should be removed. (*Ultimately, Logo service signs should not be in place without any business panels*).

VEGETATION CONTROL

During project installation or as needed for Logo signs that are existing, it may be necessary to clear vegetation in front of signs where necessary to provide proper sight distance to the sign. The sight distance area includes the triangular region of land extending from the edge of the travel lane 800 feet in advance of the sign to 4 feet beyond the furthest edge of the sign from the travel lane. The Engineer, or other appropriate DOT agent, will determine where clearing is required and the amount of clearing at the sign locations. Clearing should be in accordance with Section 200 of the Department's Standard Specifications for Roads and Structures. This work may be done by state forces or by Purchase Order Contract. For new installations, a project note can be added to the plan that requires the contractor to do the clearing prior to installation of the proposed Logo signs.

All vegetation clearing for Logo signs should be charged to the Division's Logo WBS element number. If spraying of vegetation is required and state forces are unable to do this work, the Signing and Delineation Unit and the Roadside Environmental Unit can assist the Logo Coordinator with the specifications required for spraying by purchase order contract work.

Contracts

STANDARD AND PROVISIONAL ANNUAL CONTRACTS

There are two types of contracts available for participating in the Logo Program; namely, the Specific Service (Logo) Signing Contract ([TEB-223](#) – see Appendix D) and the Specific Service (Logo) Provisional Signing Contract ([TEB-223P](#) – see Appendix D).

In most cases, form TEB 223 or standard contract will be used. The provisional contract is used when certain provisions or conditions enabling participation are applicable. By signing the provisional contract, the business owner agrees that if these conditions change, the provisional contract may be terminated at the end of the current contract period (billing cycle) to make room for another business or because of termination of the Department’s pilot (test) program. Specifically, the provisional contract is used when:

- a) the maximum distance of three (3) miles at rural interchange approaches and one (1) mile at urban interchange approaches for GAS, FOOD, or LODGING signs is exceeded,
- b) an indirect route for a business such as a business that is on Exit A, but is signed on Exit B for a split exit (as determined on a case by case basis),
- c) when certain combination service signs are used,
- d) for all Bed and Breakfast businesses,
- e) for the Department’s designated pilot (test) signs,
- f) where room is available on the ATTRACTIONS sign and a business exists that does not meet the qualifying hours and days of operations or distance, and
- g) separate panels for two (2) or more services of the same category on same property (see Chapter 4, page. 23).

Note that businesses that have provisional contracts may become standard contract holders in cases b, e, and f, described above. For instance, in case b above, if a vacancy occurs on the direct exit Logo sign(s), the current participant(s) on the non-direct exit, with a provisional contract, will have the first opportunity to take the spot vacated on the direct exit sign and become a standard contract holder. Or, with the pilot program in case e above, if a space becomes available in the first 1 through 6 standard slots on the Logo sign, the current participants in the 7th, 8th and 9th slots are considered “first-come, first-served” for the available space. In either case, the businesses currently participating must have first consideration before a brand new business would be considered. **The Department has an obligation to “first serve” businesses that are already participating in the program since they were “first come” to that location.**

In cases b, e, and f above, where there may be more than one business with a provisional contract vying for the standard 1 through 6 spots, the date of execution by the business owner and the Department is used to determine which of the provisional contract holders will become a standard contract holder. If more than one business signed the contract on the same date, then the priority is based on the date and time of the original written request for participation in the program.

REQUIREMENTS FOR CONTRACTS

The business owner or his/her designated representative must sign all contracts. The business representative is required to print as well as sign his/her name on the contract in such a manner that is legible. As verification for the business representative's signature, a witness must also sign the contract. In general, except for corporations without corporate seals, anyone can witness the business representative's signature: a friend, a family member or the Division Logo Coordinator.

The Department will only coordinate and correspond with the business owner, except as follows: **when requested in writing by the business owner and if approved by the Department's Fiscal Section, invoices and fiscal correspondence related to sign removals may be sent to other parties, such as advertising agents, rather than the business owner.** It is understood that the business owner is responsible for providing the Fiscal Section written notification of any updates to this information.

The Division Engineer or his/her designated representative in the Division has the authority to execute the contract for the Department. **The Logo contract must be executed by the Department within a couple of weeks from the completion of construction of the Logo signs and/or installation of the business panels on the Logo signs.**

A copy of the fully executed contract is returned to the business owner for his or her records, and a copy is kept in the Division Logo Coordinator's file records. The contract is forwarded to the Accounts Receivable Logo Accountant who oversees scanning of the contract into SAP along with depositing of the business' check for all signs. The Logo Coordinator must verify that the contract and check have been scanned into SAP within a couple of weeks of its transmittal to Accounts Receivable.

The Qualification Survey ([TEB-221](#)) must also be sent to Accounts Receivable for scanning since they are part of the contract.

Criteria and Guidelines for Mainline and Ramp Signing

The NCDOT controls the location, installation, and maintenance of Logo signs according to the following criteria:

- As part of the review process, the Logo Coordinator must verify that there is adequate sign spacing available on the mainline and ramps to install Logo signing. As indicated in the latest Manual on Uniform Traffic Control Devices (MUTCD), there should be at least 800' spacing between guide signs, Logo signs, and other supplemental guide signs for full control of access facilities. For partial control of access facilities, there should be at least 200' spacing between logo signs and other signs (guide, regulatory, and warning).
- When measuring distances to a business, the measurement shall be taken from the point on the interchange/intersection crossroad, coincident with the centerline of a fully or partially controlled access highway, along the route to the respective motorist service. The point to be measured for each business is a point on the roadway that is perpendicular to the corner of the nearest wall of the business to the interchange. The wall to be measured to shall be that of the main building or office. Walls of sheds (*concession stands, storage buildings, separate restrooms, etc.*) whether or not attached to the main building shall not be used for the purposes of measuring. If the office (*main building*) of a business is located more than 0.2 mile from a public road on a private road or drive, the distance to the office along the said drive/road is always included in the overall distance measured to determine the closest business. The office shall be presumed to be at the place where the services are provided.
- Mainline Logo signs shall only be installed along fully or partially controlled access highways. If a specific location for a mainline Logo sign falls within the uncontrolled access section adjacent to a full or partially controlled section, it shall not be installed even if the interchange/intersection is full or partial control of access.
- Logo signs shall not be installed along mainline approaches of one fully controlled access facility to another fully controlled access facility (*full control of access facility interchange with other full control of access facility*).
- Logo signs shall not be installed at an interchange where the driver cannot conveniently re-enter the freeway (*determined by the NCDOT*) and continue in the same direction of travel.
- A separate Logo sign shall be provided along the mainline approach for each qualified service, unless a combination Logo sign is required or has been approved by the NCDOT. The number of specific service signs along an approach to an interchange shall be limited to a maximum of four, regardless of the number of service types displayed. (*Combination Logo signs may be used if space is not available for separate sign installations, if the number of businesses desiring to participate exceeds the number of spaces available for*

Location of Signs and Support Information

business panels on a sign, and/or if the number of businesses desiring to participate does not warrant the installation of separate sign installations).

- If multiple mainline and/or ramp Logo signs cannot be installed due to spacing limitations, preference shall be given to GAS, FOOD, LODGING, CAMPING, and ATTRACTIONS services in that order. Additional Logo panels installed above or below a Logo sign are not allowed.
- If a mainline and ramp Logo signs for a particular service cannot be installed due to spacing limitations, a supplemental General Service sign listing the additional services, up to a maximum of three, may be erected below existing mainline and/or ramp LOGO sign(s). **Note: A ramp General Service sign should not be used if the corresponding mainline Logo sign is in place.**
- If there is limited spacing for mainline Logo signs, but there is room for separate ramp Logo signs, a general service sign for the services not installed on the mainline must be installed underneath another mainline Logo sign(s). If there are no other Logo signs at that interchange/intersection, general service signing may be installed underneath other guide sign(s). For instance, GAS, FOOD, LODGING service signs are installed on the ramps, but there is only room for mainline GAS signs. A general service signs stating FOOD - LODGING must be installed under the mainline GAS sign.
- Mainline Logo signs should be erected with the nearest edge of the sign 30 feet from the travel lane for full control access facilities. For partial control access facilities, the nearest edge of the sign is 20 feet from the travel lane or 6 feet from the edge of the shoulder. Along full control access facilities, a closer distance may be used based on engineering judgment and coordination with the Signing and Delineation Unit; however, that distance must not be less than 18 feet or as otherwise specified in the current MUTCD. Along partial control access facilities, a closer distance must not be less than 12 feet.
- Ramp Logo signs should be erected with the near edge of the sign 18 feet from the travel lane. A closer distance may be used based on engineering judgment and coordination with the Signing and Delineation Unit; however, that distance must not be less than 12 feet or as otherwise specified in the current MUTCD.
- Logo signs shall be located in a manner to take advantage of the natural terrain to minimize the impact on the scenic environment.
- A qualifying business is allowed only one business panel on a Logo sign per each approved service (or brand of service) offered at the business location. The service must fall in the category of one of the five approved specific services.
- Separate business panels for each participating business location are required on Logo signs when two or more businesses of the same name or brand of service are located at the

Location of Signs and Support Information

same interchange. The mainline sign and ramp sign must hold each business panel with the direction and mileage to each posted below the ramp panels. Each business location would have a separate contract and clearly have visible on-premise signs.

- Separate panels are permitted on a Logo sign for two or more services (or brands of a service) of the same service category located on the same property with the same owner. In such cases, separate contracts are required, one being Standard and any additional contracts being Provisional, such that the additional space(s) held on the Logo sign may not keep another fully qualifying business location from participating on the Logo sign.
- A business Logo panel is not permitted to include information unrelated to the service. The following information (or wording) is not allowed on any panel: phone numbers, web addresses, prices, credit cards accepted, ATM services offered, lottery ticket sales, Travel Plaza, Truck Stop, Buses Welcome, etc., or any item or service sold or offered that is not related to a separate part of the business not related to the specific service category signed is not allowed on the business Logo panel.
- Along partial control access highways, place logo signs after the JCT assembly, where applicable. Also, along partial control access highways, install logo signs in advance of directional turn assemblies

Trailblazer Signing

- Trailblazer business (Logo) panels shall be required in advance of each turn to the business. Any distance greater than two miles prior to a turn that requires a trailblazer sign shall require a pull-through trailblazer. Additionally, a pull-through trailblazer will be required if the through distance to the business seems excessive such that the driver may be uncertain as to whether or not he/she is traveling in the right direction. The pull-through trailblazer shall be installed at about the halfway point between the ramp terminus and the turn for the business or as determined by the NCDOT. **Note: The Department determines the locations and quantities of all necessary trailblazer business (Logo) panels for a specific business.**
- Due to equity concerns with customers, extra requirements of Departmental resources including sign erectors, equipment, etc. that may not be available and more transactions with SAP for contract implementation and processing, the Department will not allow Logo trailblazer installation before the mainline and ramp signs are installed.
- If a local ordinance prohibits the installation of necessary trailblazers, affected businesses will not be allowed to participate on mainline or ramp Logo signs.

GENERAL SUPPORT AND GUARDRAIL REQUIREMENTS

Signs shall be installed on breakaway supports unless installed behind guardrail, except for trailblazer panel locations, which may be mounted on u-channel posts or perforated square tubing. If the guardrail is deemed in poor condition during the field review, the design engineer may specify breakaway supports at their discretion. Safety of the motoring public is of utmost concern.

If sign upgrades are required for existing signs, supports must also be analyzed for reuse or H-section replacement.

GENERAL GUIDELINES

Prior to panel fabrication, the business panel design (layout) must be submitted to the Department for approval. Logo Coordinators should refer any questions about panel designs to the Signing and Delineation Unit.

Once Division Logo Coordinators have approved panel designs, businesses or their designated sign fabricators are responsible for supplying business panels at no cost to the Department. The Logo Coordinator should install panels within 30 days of receipt, after all fees have been paid and the Division Engineer or designee has executed the Logo Contract.

The NCDOT may cover or remove any or all business panels in the conduct of maintenance or construction operations, or for research studies, or whenever deemed by the NCDOT to be in the best interest of the NCDOT or the traveling public, without advance notice thereof. As a courtesy to the business, the owner must be notified of the business panel removal(s) as soon as possible, preferably 30 days in advance of the removal.

Displayed business panels that are unsightly, badly faded, or in a state of dilapidation, as deemed by the NCDOT, must be replaced immediately. **Note: It is always the responsibility of the business to furnish business (Logo) panels when necessary at no cost to the NCDOT.** The Logo Coordinator must contact the appropriate business owner asking him/her to furnish a replacement business panel within 30 to 60 days. Once it is received, the Logo Coordinator must then schedule the necessary work to be reinstalled within 30 days. No additional service fee is assessed to the business owner, since this work is included in the annual rental fee.

Mainline, ramp and trailblazer panels must have the same message, logo, and layout. Different wording and layout on the panels is not allowed.

COMPOSITION OF BUSINESS PANELS AND LOGO SIGNS

No business panel shall be displayed that would mislead or misinform the traveling public. Any message, trademarks, or brand symbols which interfere with, imitate, or resemble any official warning or regulatory traffic sign, signal, or device or any inappropriate images are prohibited.

Each specific service business panel shall include only information that is related to that specific service. No more than one specific service type such as GAS, FOOD, or LODGING shall be allowed on a business panel.

Combination signs are the large rectangular signs that include space for individual business logo panels with more than one specific service type. Provisional contracts for the businesses on combination signs shall be required for all businesses other than the first three fully qualifying GAS and FOOD panels. Combination signs shall be allowed if one or more of the following conditions are met:

1. If space is not available for separate sign installations;

Business Logo Panels

2. If the number of businesses desiring to participate exceeds the number of spaces available for business panels on sign; or
3. If the number of businesses desiring to participate does not warrant the installation of separate sign installations.

BUSINESS PANEL SPECIFICATIONS

Qualifying businesses have the option of using either their recognized logo or the name of their business on business panels. When a symbol or trademark is used instead of the business name, any legend thereon shall be proportional to the size customarily used on said symbol or trademark. No slogans shall be included on the business panel unless it is part of their copyrighted name. Any message, trademark, or symbol, which interferes with, imitates or resembles any official warning or regulatory traffic sign, signal, or device is prohibited.

Total reflectorization is required for business panels where white and colored sheeting is used. When black sheeting is used it shall be non-reflective. The retroreflective sheeting shall be a minimum of Type III (high intensity) or NC Grade C sheeting and must meet the specifications contained in the latest version of Section 1092 of the North Carolina Department of Transportation Standard Specifications for Roads and Structures.

Mainline business panels shall be 48 inches by 36 inches, along full control access facilities, and shall have a $\frac{3}{4}$ inch white border and 3 inch corner radii. Partial control access facilities shall use the ramp design size, which is 24 inches by 18 inches. On mainline business panels when a symbol or trademark is not used, the legend copy shall consist of at least 8 inch upper case letters and 6 inch lower case, when either one line or two lines of copy are used. When a symbol is used on mainline business panels, any supplemental message, such as “DIESEL” on a Gas business panel shall consist of minimum 5 inch letters with a type D font or broader stroke. Any message and / or wording not directly related to the specific service such as “lottery tickets” is prohibited. See *Appendix E - [Logo Business Panel Details](#)*.

A Gas service that offers alternative fuel may show the information, since it is directly related to the service, within the logo panel as a supplemental message. A Gas service selling branded gas must show the branded gas logo on the logo panel. A Gas service selling unbranded gas must show the name posted on the gas pumps and the word “Gas” or “Fuel.”

Logo panels on the ramp signs and trailblazers shall be duplicates of those displayed on the mainline sign, except that they shall be reduced in size. Ramp and trailblazer business panels shall be 24 inches by 18 inches and shall have a $\frac{3}{4}$ inch white border and 3 inch corner radii. On ramp and trailblazer business panels, when a symbol or trademark is not used the legend copy must consist of at least 4 inch upper case letters and 3 inch lower case, when either one line or two lines of copy are used. When a symbol is used on ramp and trailblazer business panels, any supplemental message such as “DIESEL” on a Gas business panel shall consist of minimum 2.5 inch letters with a type D font or broader stroke. Again, any message and / or wording not directly related to the specific service such as “Tow Service” or “Car Wash” is prohibited.

Business Logo Panels

When the background color of a business panel has a non-contrasting color, such as white, cream, yellow, silver, light blue, etc., a field of contrasting dark color must be placed adjacent to the white border. When used, this field of contrasting dark color shall be at least 1 ½ inches wide on mainline business panels and at least ¾ inches wide on ramp and trailblazer business panels.

Mainline, ramp, and trailblazer business panels shall be made of a flat aluminum sheet having a minimum thickness of 0.063 inch and a maximum thickness of 0.125 inch.

Mainline and ramp business panels shall be made with 5/32 inch holes (spaced as per punching detail) for attaching to the specific service sign. Trailblazer business panels shall be made with two 3/8 inch holes (spaced as per punching detail) for attaching to u-channel posts. See *Appendix E - [Logo Business Panel Details](#)*.

A business logo panel is not permitted to include information unrelated to the service. The following information (or wording) is not allowed on any panel: phone numbers, web addresses, prices, credit cards accepted, ATM services offered, lottery tickets sales, “Travel Plaza,” “Truck Stop,” “Buses Welcome,” “Car Wash,” etc., or any item or service sold or offered that is not related to the specific service.

If the Food business name is not recognizable as a restaurant, the word “Restaurant” must also be included on the business Logo panel. Information that is unrelated to the specific service, such as, play space, playground, playland, etc., on food business panels is prohibited. Buffet prices or other food prices are not acceptable messages to be included as part of the Logo panel design. A business cannot include the types of credit cards that it accepts on the business logo panel. Phone numbers or internet or email addresses are not acceptable on the legend for the business panel.

The logo must include a recognizable name, symbol, or trademark of the gas sold. If the gas business has a recognizable logo, it may display both (business and gas) logos, provided there is only one business. If the gas business name or logo is not recognizable to the general motorist as a gas service, the word “Gas” or “Fuel” must also be included in the business Logo panel.

Diesel or LP Gas is acceptable as additional messages on a GAS Logo business panel since these messages provide the traveling public with additional information about the type of fuel available to assist motorists in making a decision about stopping at the specific location. Alternative fuel word messages such as EV, CNG, or LP are acceptable on gas logo panels as long as the minimum letter size is met.

The logo panel must clearly indicate the attraction offered and be easily recognizable to the public. If, in the opinion of the coordinator, the logo/design is vague or does not clearly depict the attraction, additional wording must be added to the panel design for clarification. Additional wording is considered supplemental message and letter size must meet the standards specified herein.

Only one service type such as GAS, FOOD, or LODGING shall be allowed on a Logo business panel. Only one Logo is allowed per food service, unless it is two different qualifying menus under

Business Logo Panels

one roof. Two businesses of the same service type (*for example, two food businesses*) may be shown on the same Logo business panel provided they are located in the same building and use the same cash register. In addition, the designs must meet the minimum letter sizes.

Hours of operation are acceptable on the Logo business panel. For instance, 24 hours would be allowed on a FOOD Logo business panel as long as the business is fully operational during a 24-hour period. If only the drive thru window is open 24 hours, it is acceptable to add “24 HR Drive Thru” to the panel. Closed Sunday or 8 AM – 8 PM would also be allowed on a business panel since these messages provide the traveling public with additional information to help them make a decision about stopping at the specific location.

Words such as *bar, saloon, lounge, or pub*, etc. will not be allowed on business panels unless this type of wording is part of the official name of the business. (*This type of wording will not be allowed as additional or related text*). It is the participant’s responsibility to furnish adequate proof to the Department that this type of wording is part of the official name of the business. This information may be included on the official business license and it may also be available from the county health departments. A directory of the health departments may be found at the following website: <https://www.ncdhhs.gov/divisions/public-health/county-health-departments>

SERVICE CLARIFICATIONS AND ELIGIBILITY REQUIREMENTS

GAS SERVICE

Additionally, in order to fully qualify as a GAS service, the participant must sell traditional gas. Alternative fuels for motor vehicles may be offered and may be listed on the business panel, such as EV, CNG, or LP GAS, etc. A provisional contract may be used for those businesses that exclusively sell alternative fuels for motor vehicles; however, the business panels must also include a message that reads NO GASOLINE SOLD or other appropriate message. Businesses that sell only LP GAS for non-motor vehicle use are not allowed to participate in the program.

FOOD SERVICE

Additionally, in order to fully qualify for as a FOOD service, adequate parking must be provided. Typically, on-site parking is provided and is acceptable; however, on-street parking (metered and/or not metered) is acceptable if the spaces are located adjacent to the business. A parking deck located several blocks away from the business does not constitute adequate parking if it is the only parking readily available.

Food courts in malls will not in general qualify for Logo signing; however, if an individual business in a food court in a mall had their name clearly posted on the outside of the mall, travel to and from the business was not confusing, and a separate entrance was provided for the FOOD service, the Department would consider allowing the FOOD service to participate in the program.

Coffee shops can only participate in the program if they meet the eligibility requirements for a FOOD service (*see Introduction*) and they can demonstrate that over 50% of the sales revenue for the business at that specific location must come from the type of service requested. For a FOOD service, beverage is not considered a food.

LODGING SERVICE

When Bed and Breakfast businesses participate in the program, they must be identified as such on the Logo service signs. **All Bed and Breakfast businesses shall have provisional agreements.** If a Bed and Breakfast business is the only lodging choice at a specific interchange/intersection, a Bed and Breakfast general service sign may be used. If other lodging choices are available, then the Lodging general service sign should be used. (*General service signs may be used in conjunction with Specific Service signs for eligible types of services that are not represented by a Specific Service sign*).

CAMPING SERVICE

The Department will allow the months of operation to be posted on the sign. See *SEASONAL CAMPING AND ATTRACTIONS SERVICES* below.

ATTRACTION SERVICE

Additionally, attraction businesses should have regional significance to motorists and should be evaluated as an attraction service before installation of supplemental guide signing. See the *standard practice for Supplemental Guide signs for Moderate Traffic Generators* ([T14](#)).

The Attraction facility must be on-site, within the boundary of the property. Providing a shuttle to an off-site attraction will not qualify an Attraction. Attraction signing is not intended for communities with amenities; however, a qualifying attraction may exist within a community.

The attraction facility shall have a permanent sign posted in a prominent and visible location that states the name of the business with the days and hours of operation. If the facility has stated they provide tours as part of their qualifying criteria, the facility shall have a permanent sign posted on the premises stating the times that tours are offered, or stating that tours are available upon request. The sign shall be posted in a conspicuous location that is visible to customers entering the facility.

To qualify as “Leisure or Recreation Activity Areas”, all equipment, etc., necessary for the activity must be available on site (for rent or at no cost to the customer). For hiking and biking, trails must be signed and properly marked. To qualify as an attraction, a golf course must be open to the public and must offer tee times to the public within thirty minutes of arrival without requiring prior appointment. On-premise signs(s) at the entrance (from the public road and from any subsequent drive) to any recreational facility, including a golf course, specifying “open to the public” or “public welcome” must be in place unless it is obvious to the coordinator that it is a public attraction. A leisure or recreation activity area may be indoors (in a facility); however, the primary purpose of the facility must be to provide the leisure or recreation activity to the public. Sports Entertainment complex may be considered for attractions logo if open at least 8 hours a day 5 days a week, open to the general public, all equipment necessary for the activity must be available on site (for rent or at no cost to the customer) include at least 50 entertainment bays for leisure or recreation activity. Can also include food (restaurants/bars/lounges), and/or meeting/event spaces.

Tour time for “Manufacturing Facilities” must be posted on a permanent on-premise sign located conspicuously at or near the entrance to the facility. Tours must be: 1) directed by knowledgeable employee (tour guide) of the business; 2) educational, informative, and entertaining in nature; and 3) of sufficient length to clearly describe materials, equipment, and processes used in the manufacturing facility (min 15 minutes)

To qualify as “Agricultural Facilities” (other than regional farmer’s markets), requesters must have an actual working farm (or vineyard) on the same site as the facility to which motorists are directed. A guided tour must be provided of the farm or vineyard, as well as of any production processes

Service Clarifications and Eligibility Requirements

used by the facility. Tour times (or “Tours Available Upon Request” message) must be posted on a permanent on-premises sign located conspicuously at or near the entrance to the facility. Tours must be: 1) directed by knowledgeable employee (tour guide) of the business; 2) educational, informative, and entertaining in nature; 3) of sufficient length to clearly describe materials, equipment, and processes used in the production of agricultural products by the facility (min 15 minutes); and 4) conducted regularly (min of two scheduled tours during each day the facility is open to the public) during open business hours; or in the absence of regular tour times, upon customer demand (within thirty minutes of request).

SEASONAL CAMPING AND ATTRACTIONS SERVICES

Any qualifying camping or attraction service that is only open seasonally is still required to pay the standard annual rental fees. No proration of fees will apply. Seasonal attractions should have their business panels removed or masked during their “off” season. There is **no** charge to the business for this service. During its normal operating season, the business must meet all the eligibility criteria described within (*see Introduction*).

As an alternate to masking or removing a business panel for a seasonal attraction during their “off” season, a business Logo panel may include the months of open operation. The letter size must meet the minimum criteria specified for mainline and ramp business panels (*see Appendix E – Logo Business Panel Face Specifications*). **Note: If the business is open from June 15th through September 8th, the business panel cannot show June-Sept. The business must be open for the entire month period, not a portion of a month, before it would be acceptable to show the month on the business panel.**

Appeals Process

GENERAL

Written documentation should follow each decision to deny requesting participation or terminate existing contracts. The documentation should be sent via **certified** letter, return receipt requested, clearly stating reasons why participation was refused or the contract terminated and panels removed.

The correspondence must also give businesses their appeal rights, which basically allow businesses to challenge the decision, if they feel the program is not being administered in accordance with Departmental procedures, and directions on whom to submit an appeal notice. Appeal rights will give business owners 20 calendar days, starting from the receipt date of the letter, to appeal the decision. Appeal rights also require the Department to respond within 30 calendar days of appeal notifications.

PROCEDURE

1. The business owner is notified of denied participation in the program or contract termination with clear reasoning. Within the notice, the business owner is informed that he or she has 10 calendar days within the receipt of notice of the decision, to submit a notice of appeal to the Division Engineer.
2. Upon receipt of an appeal from the business owner, the Division Engineer will acknowledge the notice of appeal and forward the notice of appeal to the Secretary. Within the acknowledgement statement from the Division Engineer, the appealing business owner is informed that he or she has 20 calendar days to submit a written appeal, including all pertinent facts, directly to the Secretary of Transportation, North Carolina Department of Transportation, 1501 Mail Service Center, Raleigh, North Carolina 27699-1501.
3. Within 30 calendar days from the receipt of the said written appeal or within such additional time as may be agreed to between the Secretary and the business, the Secretary shall complete an investigation of the said appeal. The Secretary shall then make appropriate findings of fact and conclusions pertaining to the appeal. The findings and conclusions shall then be served upon the business seeking the review, by certified mail, return receipt requested.
4. **The Secretary of Transportation's decision is not subject to appeal.**

BUSINESS FAILURE TO PAY FEES

Per the terms of the Logo agreement, the participant agrees to pay its invoice to the NCDOT within 30 days of receipt. If payment is not made within this specified time period, Accounts Receivable will notify the participant in writing by **certified** mail, *return receipt requested*, reminding the participant that payment is due. The letter states that if payment is not received within 30 days, the business (Logo) panels shall be removed and the agreement will be terminated. In addition, the letter states that after 30 days, the business panel(s) shall become the property of the NCDOT and disposed of as the NCDOT determines.

After the 30 day time period for payment, Fiscal will notify the Logo Coordinator via email that payment has not been received and the Logo Coordinator must have the Logo panels removed from the Logo sign. Panels must be removed as soon as possible, preferably within two weeks after the notification. If at this time the Department receives a check that is returned or marked insufficient funds, Fiscal will notify the Logo Coordinator that payment has not been received and the business (Logo) panels must be removed as stated above. **No partial payment of fees will be accepted by the Department.** Any partial payment sent to Fiscal or the Division office must be returned immediately via certified mail to the business with copy of their agreement highlighting this language or a letter stating this.

REMOVAL OF BUSINESS PANELS

The NCDOT is required to remove business (Logo) panel(s) and terminate the Logo agreement when the business owner fails to pay appropriate fees and/or the business violates any provision of the current rules, their agreement, or any of the guidelines for the Specific Service (Logo) Signing Program. It is essential for Logo Coordinators to take immediate action when invoices are not paid or businesses refuse to be in compliance with the rules of the program in order to maintain the integrity of the program and to make sure that all participants are treated fairly.

When business panels are removed, they shall be taken to the Logo Coordinator's office of the Division in which the business is located. If the business owner does not pick up their panels within the previously specified 30-day time frame, the business panel(s) shall become the property of the NCDOT and disposed of as the NCDOT determines.

If the business panels are removed and the business owner requests that signs be reinstalled, if space is available, this request shall be handled in the same manner as a request from a new applicant. In addition, the business is required to pay back fees owed up to their anniversary date. No proration of fees is allowed for the time period that business panels are removed from signs.

Business Issues

The contract end and dismantle dates must be entered into VA42 in SAP to complete the cancellation of the contract. Otherwise, the contract will still show as active and the customer will be billed on its next anniversary billing. The contract end and dismantle dates must be the date the business panels are removed from the Logo sign. Notes must be made in SAP if the business has been removed for nonpayment. The text notes should include pertinent information such as how much money was past due.

If the Logo Coordinator is notified that a new owner/operator has taken over the business, then the Logo Coordinator will need to ask the new owner to complete a transfer of ownership form. *See Appendix D – Transfer of Ownership (TEB-223B)*. The new owner is still responsible for payment of past due fees. If a transfer of ownership form is not completed within 30 days of the change of ownership, the Department should send the new owner a new agreement for execution.

The business is responsible for notifying the Department in writing if they no longer wish to participate in the program. Failure to notify the Department in writing does not release the business from paying fees for the time period the business panels have been installed on the Logo signs.

BUSINESS IN BANKRUPTCY

According to the Attorney General's office, the Department cannot expect back payment of fees for a business that is in bankruptcy. The Logo Coordinator should request written documentation that the business is in bankruptcy and the type of bankruptcy that has been filed. Depending upon the type of bankruptcy filed, in some cases the businesses will not be responsible for making payment to the Department for the rental of their space on the Logo sign(s).

With Chapter 11 bankruptcy, a court allows the business to reorganize and may also grant complete or partial relief from debts and contract commitments. With Chapter 7 bankruptcy, the business is liquidated to pay off debts, but instead of making full payment on a debt or obligation, only a portion of the payment may be received. Therefore, bankruptcy issues will be reviewed on a case by case basis with the State Signing Engineer with input from the Attorney General's office, if necessary. Any bankruptcy documentation should be forwarded to Accounts Receivable for scanning into the Logo electronic records for the business.

If the business fails to provide this documentation, then the business must be notified by **certified** mail, *return receipt requested*, that their signs will be removed. The process for Removal of Business Panels as described above applies.

BUSINESS FRANCHISES

If a business franchise is removed from the program for non-payment and later requests participation in the program, as standard operating procedure the Logo Coordinator will request payment of past due fees. If the business informs them that they have no affiliation with the previous franchise/owner and are not responsible for the past due fees, the Logo Coordinator must request this statement in writing and then proceed with initiating a new agreement with the requesting business, if space is available.

BUSINESS IN NON-COMPLIANCE

When it comes to the attention of the NCDOT that a participating business is not in compliance with the minimum state criteria by visual observation or if reported by another business, the Logo Coordinator shall promptly verify the information. If the business fails to meet any of the Logo program requirements, the Logo Coordinator shall inform the business in writing by **certified** mail (*return receipt requested*) that it has 30 days to correct any deficiencies or its business panel(s) shall be removed as described in the process for the *Removal of Business Panels*. The correspondence should clearly state the deficiency the business must correct to remain in the program.

If the business panels are removed and the business owner applies for reinstatement at a later date, this request shall be handled in the same manner as a request from a new applicant, if space is available.

BUSINESS FAILURE TO SUPPLY BUSINESS PANELS

The business is responsible for supplying the business panels to the Department as requested for new installation or because the panels are, in the opinion of the Department, in need of replacement to meet new specifications or dilapidated. Displayed business panels that, in the opinion of the NCDOT, are unsightly, badly faded, or in a state of dilapidation should be replaced immediately.

The Logo Coordinator should notify the business in writing by **certified** mail, *return receipt requested*, that their panels have not been received as required or that their panels need replacement because of new specifications, or their panels are in poor condition. The Coordinator must request that the business owner furnish a replacement business panel at no cost to the NCDOT within 30 to 60 days or their contract will be terminated and panels removed.

If the business panels are not received in the time frame requested, the Logo Coordinator shall terminate the Logo agreement with the business owner. No refunds will be made. The process for Removal of Business Panels must be followed.

BUSINESS UNDER CONSTRUCTION

An individual business under construction may apply to participate in the program by giving written assurance of the business's conformity with all applicable laws and requirements for that type of service, by a specified date of opening to be **within 60 days** of the date of application. No business panel shall be displayed for a business that is not open for business and in full compliance with the standards required by the program.

A business under construction shall not be allowed to apply for participation in the program if its participation would prevent an existing open business from participating, unless the existing same service business qualifies for or has a provisional agreement. *For example, assume that the Logo sign is full for a particular service at an urban or rural interchange where there are no qualifying food services within one mile (urban) or three miles (rural) of the interchange, but there are existing food services located two miles (urban) or four miles (rural) from the interchange. A standard agreement could be prepared for a food service under construction that is located within the one-mile (urban) or three-mile (rural) limit since the existing food service either has or qualifies for a provisional agreement. **Since the program is first come, first-served, or next business on the waiting list, regardless of distance, the last business to sign a provisional agreement would be the first business removed from the Logo sign.*** Thirty days prior to the end of the billing cycle, the Department should notify the business with a provisional agreement in writing by **certified** mail, *return receipt requested*, that their agreement will not be renewed and that their business panel will be removed at the end of their contract period, normally the anniversary date of their sign installations.

BUSINESS CLOSED FOR RENOVATION

A business closed for reconstruction or renovation, or for restoration of damages caused by fire or storm shall notify the Logo Coordinator immediately upon its temporary closing. The business shall be granted one year to complete the construction, renovation, or restoration, provided all Logo fees are maintained and the same type of qualifying service is provided after reopening, even if under a different business name. The business panels shall be removed or covered from the service signs and stored by the NCDOT until notice of reopening is received. The business panels should be re-installed or uncovered as soon as possible after notification within a 30 day time period. No reimbursement of fees will be made to the business during the closed time period.

Ideally, the business's panels should be re-erected within two weeks of the business opening. However, at the time specified for opening or reopening, if a business under construction or reconstruction, renovation, or restoration is found to not be in compliance, or not open for business, the Division Logo Coordinator shall promptly verify the information. If a breach of agreement is ascertained, the Division Logo Coordinator shall inform the business in writing by **certified** mail *return receipt*

Business Issues

requested, that it has 30 days to correct any deficiencies or its business panel(s) shall not be erected and are available for pick up at the Division Logo Coordinator's office. If the business owner applies for reinstatement at a later date, this request shall be handled in the same manner as a request from a new applicant.

BUSINESS CLOSED/OUT OF BUSINESS

Occasionally a business that is not participating in the Logo Program will contact the Logo Coordinator and inform them that a business that is on the Logo sign is no longer in business and request the spot on the sign. Before a new business can be accepted into the program, the Logo Coordinator must investigate and determine whether or not a business is actually out of business or just closed for renovation. The coordinator should inform the potential applicant of the investigation that must take place to make this determination and that they will contact them back with the result. In general, the site visit must be conducted within 5-7 workdays. Obviously, the quicker, the better for this process to be resolved since other businesses may begin requesting the position.

As part of the business-closure formal investigation, the Logo Coordinator must attempt to contact the business and request notification in writing from the business owner that they are closed. If the coordinator is unable to contact the owner over the phone, he/she should next attempt to contact the owner in writing via **certified mail, return receipt requested**, requiring that the business owner contact the coordinator within seven working days or their agreement with the Department will be terminated if a site visit determines that the business is no longer open for business. The site visit should be made while waiting on response from the owner. A site visit may determine that the business is just closed for renovation. As stated in the section above, the Department does allow a business that is under renovation to keep their spot on the sign as long as they pay their fees and continue to meet the program's requirements.

Depending upon the situation, following are the steps that must be taken:

- a) If the coordinator does determine that the business is undergoing renovation, he should contact the business that notified him of the business closure and explain that the business has not closed, but is undergoing renovation and has a year to complete their renovation while keeping their spot on the program;
- b) If the coordinator does determine that the business is closed by visual observation (notice on the building is posted of the business closure) or by confirmation in writing from the business owner or by failure of by the business to respond to the certified letter, a new business may be accepted on the program. Immediately after this notification, the business that notified the Department of the closure must be informed that the next business on the waiting list will be offered a new agreement; or
- c) If the Logo Coordinator determines that the business owner has sold his business to another owner, the Logo Coordinator should notify the owner in writing by **certified mail, return receipt requested**, that a Transfer of Ownership form ([TEB-223B](#)) must

Business Issues

be completed within 30 days of the business transfer (see below). (The coordinator may inform the business over the phone also, but it must be followed up in writing). Immediately after this notification, the business that notified the Department of the closure must be informed that a transfer of business ownership has taken place and there is not currently a vacancy on the Logo board.

Occasionally, Fiscal is notified that the business is closed when requesting payment from the business owner. The Logo Accountant should request written notice via fax, email, or letter from the business of the closing. Fiscal will notify the coordinator via email that the business is closed. Immediately after receiving this notification, the Logo Coordinator must accept a request from a new business (based on first-come, first-served or next business on the waiting list on the date and time of the written request) for the program while initiating removal of the old business's panels from the program.

TERMINATION OF LOGO AGREEMENT

In addition to the cases mentioned above, the Department reserves the right to terminate the agreement at any time with a 30-day notice to the business owner. The Department rarely exercises this right, but occasionally must do so. For instance, under a construction project, a new interchange is built close to an existing interchange such that there is very limited spacing for signs. Since Logo signs are considered *supplemental* guide signs, directional guide signs and/or safety-related signs would take precedent over Logo signs. Per the terms of the Logo agreement, “it is further understood that the DEPARTMENT reserves the right to terminate this program or agreement or any portion thereof by furnishing the BUSINESS written notice of such intent not less than 30 calendar days prior thereto”.

Occasionally, a business that was entitled to participate in the program with a provisional agreement will no longer qualify for the program. If a GAS, FOOD or LODGING business that is located in an area that was classified as a rural interchange (rural incorporated area or within the corporate city limits of a city or town with a population of less than 40,000) becomes reclassified as urban interchange, then the Department may terminate the agreement if certain conditions prevail.

For example, an unincorporated interchange is annexed into the corporate city limits of a city with a population of greater than 40,000. If there are other fully qualifying GAS, FOOD, or LODGING businesses within the one mile radius from the interchange, the business may no longer qualify for the program if it is located 2.8 miles from the interchange because of the mileage requirement for an urban interchange. In this instance, the Logo agreement with the business may be terminated. The business could remain in the program, if there were no other fully qualifying businesses within a one-mile radius of the interchange.

TRANSFER OF OWNERSHIP (FORM [TEB-223B](#))

Per the terms of the Logo agreement, the transfer of ownership of a business for which an agreement has been lawfully executed with the original owner shall not in any way affect the validity of the agreement for the business panel(s) of the business, provided that the appropriate Logo Coordinator is given notice in writing of the transfer of ownership within 30 days of the actual transfer. A transfer of ownership form (*see Appendix D*) must be completed by both parties and submitted to the appropriate Logo Coordinator. A new agreement is then required from the new owner, unless the Logo Coordinator determines that the wording in the original agreement is exactly the same as the current Logo agreement.

One of the requirements included in the transfer of ownership form states that the Buyer shall pay any monies past due under the terms of the Seller's existing agreement with the Department. Prior to the execution of the new agreement by the Department or acceptance of the change of ownership form, all past due monies shall be collected by the Logo Coordinator (or verified that they have been collected by Fiscal).

A new contract is always required in SAP with the new business owner. It is created with reference to the previous agreement/owner. Also, all billing records should be immediately updated with the new owner's name and address.

If, at the annual contract renewal date, a business provides the Accounts Receivable with a check with a name and address indicating that a change of ownership for the business may have taken place and it does not appear to be an advertising agency making payment for the business, then the owner of the business (as indicated on the agreement) must be contacted by the Logo Coordinator or Accounts Receivable to confirm he/she is still the current owner prior to acceptance of the check by the Department. If Fiscal receives the check, they must contact the Logo Coordinator via email that an investigation of ownership is necessary and that a Transfer of Ownership form should be completed.

If the Logo Coordinator or Fiscal Logo Accountant discovers that the business has been sold, then prior to processing the check, the Logo Accountant must notify the Logo Coordinator via email about the change of ownership and request that the necessary paperwork be completed. The Logo Coordinator must attempt to contact the new owner and provide him with information about the transfer of ownership process if the Logo Accountant provided him with this information. The new owner (Buyer) should be sent a certified letter that includes the transfer of ownership form and new agreement (if necessary). The letter shall state that the seller/buyer has 30 days to execute the transfer of ownership form or the panels will be removed.

After the 30 day time period, if the Transfer of Ownership form and signed agreement (if necessary) have not been received, the Logo Coordinator must remove the panels from the Logo signs and the position may be offered to the next qualifying business that

Business Issues

contacts the Department in writing. The Department is under no obligation to hold the spot on the Logo sign for the new owner since we do not have a valid agreement with the owner and were not notified in writing of the change in ownership as is required by the Logo agreement.

If the invoice sent from Fiscal was returned as undeliverable, the Logo Coordinator should be emailed and requested to determine the status of the business. The Logo Coordinator may contact the old owner to determine whom the business was sold to and attempt to get the new owner's name and address; however, this is not required. If attempts to contact the new/old business owners via certified mail from the Department are returned as undeliverable, and the address is verified as correct by our records or physical location of the business, then the Department must proceed with panel removals once the 30 days has expired (as required by the agreement).

REFUNDS TO BUSINESSES

Occasionally, the Department may owe a refund to a business. Refunds are possibly due to the business when:

- the Department inadvertently bills the business incorrectly such as invoicing a business twice for the same location (duplication of a billing for a Logo customer) and the business pays NCDOT for both invoices (customer doubles his payment);
- overpayment is received from a business;
- the business pays for signs that are not installed;
- the Department has a construction project or other need for the designated Logo sign space such as for the installation of a required directional, guide or safety sign(s) that requires the **permanent removal of the Logo sign** and subsequently a business's Logo panel or panels;
- the Logo signs/panels are removed six months or more before the end of the billing cycle for the business;
- a construction project is unable to maintain the business's Logo panels during construction for a period of six month or more. The Department will not refund the business unless the signs have been removed for more than six months. The Contractor on a construction project is required to maintain Logo signing if at all possible, even if it requires the Logo signs to be placed on temporary supports; or,
- a Logo sign/panel(s) is damaged by vehicular accident and the sign/panels are down for **more than** six months.

Refunds will not be made when:

- the business decides to drop its participation in the program because of closing or bankruptcy during the middle of a billing cycle, the Department is not required to refund the business;
- a business does not provide written notification of termination of their contract with the Department at the end of the billing cycle. The business should send written notification to the Logo Coordinator and Fiscal if they do not wish to renew their

Business Issues

contract when they are invoiced prior to their anniversary date. The business should verify that the Department has received notice of termination the Logo contract;

- the business fails to maintain the eligibility requirements of the program;
- the business decides it is no longer interested in participating in the program for any reason; or,
- a Logo sign/panel(s) is damaged by vehicular accident and the signs are down for less than six months.

No refunds shall be made to advertising agencies. Refund checks shall only be issued to the business owner as listed on the Agreement and/or latest Transfer of Ownership form.

ADVERTISING AGENCIES

Although we do not allow an advertising agency to sign for the owner of a business, checks received from ad agencies are acceptable. In this case, Accounts Receivable (AR) shall require that the ad agency provide them with a delegation of authority letter from the business owner with the ad agency that allows the ad agency to make payments for the business. The delegation of authority letter shall be available for viewing on SAP and handled by AR.

The current standard and provisional Logo agreements state that “It is understood that the Department will only correspond with and invoice the business owner. Coordination of payments to be made by other parties, such as advertising agents, is the sole responsibility of the business owner.” In cases where delegation of authority has been transmitted, it is acceptable to respond to questions from advertising agencies though regarding billing issues.

Appendix A

Appendix A

§ 136-89.56. Commercial enterprises.

No commercial enterprises or activities shall be authorized or conducted by the Department of Transportation, or the governing body of any city or town, within or on the property acquired for or designated as a controlled-access facility, as defined in this Article, except for:

- (1) Materials displayed at welcome centers which shall be directly related to travel, accommodations, tourist-related activities, tourist-related services, and attractions. The Department of Transportation shall issue rules regulating the display of these materials. These materials may contain advertisements for real estate; and
- (2) Vending machines permitted by the Department of Transportation and placed by the Division of Services for the Blind, Department of Health and Human Services, as the State licensing agency designated pursuant to Section 2(a)(5) of the Randolph-Sheppard Act (20 USC 107a(a)(5)). The Department of Transportation shall regulate the placing of the vending machines in highway rest areas and shall regulate the articles to be dispensed. In order to permit the establishment of adequate fuel and other service facilities by private owners or their lessees for the users of a controlled-access facility, the Department of Transportation shall permit access to service or frontage roads within the publicly owned right-of-way of any controlled-access facility established or designated as provided in this Article, at points which, in the opinion of the Department of Transportation, will best serve the public interest. The location of such fuel and other service facilities may be indicated to the users of the controlled-access facilities by appropriate signs, the size, style, and specifications of which shall be determined by the Department of Transportation.

The location of fuel, gas, food, lodging, camping, and attraction facilities may be indicated to the users of the controlled-access facilities by appropriate logos placed on signs owned, controlled, and erected within the right-of-way of fully and partially controlled-access highways by the Department of Transportation. The owners, operators or lessees of fuel, gas, food, lodging, camping, and attraction facilities who wish to place a logo identifying their business or service on a sign shall furnish a logo meeting the size, style and specifications determined by the Department of Transportation and shall pay the Department of Transportation a fee set by the Board of Transportation. The Board shall set the fee to cover the initial costs of signs, sign installation, and maintenance, and the costs of administering the logo sign program. The Transportation Mobility and Safety Division of the Department of Transportation shall administer the logo sign program, including receiving requests for information concerning the logo sign program. (1957, c. 993, s. 9; 1973, c. 507, s. 5; 1977, c.

464, s. 7.1; 1981, c. 481, s. 1; 1983, c. 604, s. 1; 1985, c. 456; c. 718, ss. 2, 3, 6; 1987, c. 417, s. 2; 1996, 2nd Ex. Sess., c. 18, s. 19.10(b); 1997-443, s. 11A.118(a); 2003-184, s. 2; 2014-100, s. 34.14(a); 2015-239, s. 1.)

Appendix B

Appendix B

Appendix B

19A NCAC 02E .0216 SPECIFIC SERVICE SIGNING (LOGO) PROGRAM

The Specific Service Signing Program, hereinafter "Program", provides eligible businesses with the opportunity to be listed on official signs within the right-of-way of fully controlled access highways. The Traffic Engineering and Safety Systems Branch is responsible for administering the program and receiving requests for information concerning the Program. Requests for information may be directed to the State Traffic Engineer, Division of Highways, Department of Transportation, 1561 Mail Service Center, Raleigh, NC 27699-1561. Division Engineers, for the division in which the interchange is located, are responsible for receiving and distributing applications and copies of policies and procedures, executing agreements and administering the agreements.

History Note: Authority G.S. 136-89.56; 136-137; 136-139; 143B-346; 143B-348; 143B-350(f); 23 C.F.R. 750, Subpart A; 23 U.S.C. 131(f); Eff. April 1, 1982; Amended Eff. April 1, 1994; October 1, 1993; October 1, 1991; Temporary Amendment Eff. October 13, 2003; Amended Eff. January 1, 2004; Pursuant to G.S. 150B-21.3A, rule is necessary without substantive public interest Eff. September 6, 2016.

Appendix B

19A NCAC 02E .0221 FEES

(a) All logo signs shall be constructed and maintained by the Department. These logo signs shall be owned by the Department. The participating logo business shall pay an annual fee established by the Board of Transportation. All logo contracts existing under prior administrative code provisions are terminated in accordance with the terms of those contracts. However, existing participants shall not be required to reapply, but shall be required to sign an appropriate contract in accordance with the new regulations in order to continue their participation.

(b) The fee for participation in the Logo program is as follows: Mainline, ramp, and trailblazer panels are billed an annual fee of three hundred dollars (\$300.00) per each mainline, ramp and trailblazer panel. The initial payment of the fee shall be paid prior to installation. The contract runs for one year from the date of installation. Contracts shall be renewed annually and the fee is due at the contract renewal date. Every participating business that meets program requirements has a valid contract and pays all required fees shall be automatically renewed except for provisional contracts which shall be reviewed by the Department annually prior to renewal.

(c) The business shall provide a new or renovated business panel when necessary due to damages caused by acts of vandalism, accidents, or natural causes including natural deterioration. If the Department replaces a business panel on a logo sign or removes or masks a business panel because of seasonal operation, there shall be no additional charge to the business.

(d) The fee shall be paid by check or money order and is due in advance of the period of service covered by the fee. Failure to pay a fee when due is grounds for removal of the business panels and termination of the contract.

History Note: Authority G.S. 136-89.56; 136-137; 136-139; 143B-346; 143B-348; 143B-350(f); 23 C.F.R. 750, Subpart A; 23 U.S.C. 131(f); Eff. April 1, 1982; Amended Eff. July 1, 2000; August 1, 1998; April 1, 1994; October 1, 1993; December 1, 1992; September 1, 1990; Temporary Amendment Eff. October 13, 2003; Amended Eff. February 1, 2004.

Appendix C

Appendix C
Division Logo and TODS Program Contact Information

Division Number	Division Address	Counties	Programs Coordinator	Phone Number
Division 1	113 Airport Dr, Suite 100 Edenton, NC 27932	Bertie, Camden, Chowan, Currituck, Dare, Gates, Hertford, Hyde, Martin, Northampton, Pasquotank, Perquimans, Tyrrell, Washington	Jason Davidson jdavidson@ncdot.gov	(252) 482-1857
Division 2	1037 W.H. Smith Blvd. Greenville, NC 27835	Beaufort, Carteret, Craven, Greene, Jones, Lenoir, Pamlico, Pitt	Jim Evans jfevans@ncdot.gov	(252) 439-2829
Division 3	5504 Barbados Blvd Castle Hayne, NC 28429	Brunswick, Duplin, New Hanover, Onslow, Pender, Sampson	Bob Hammond bobhammond@ncdot.gov	(910) 341-2200
Division 4	P.O. Box 3165 Wilson, NC 27895	Edgecombe, Halifax, Johnston, Nash, Wayne, Wilson	Jan W. Lee jwlee3@ncdot.gov	(252) 640-6534
Division 5	5674 Cornwall Road Oxford, NC 27565	Durham, Franklin, Granville, Person, Vance, Wake, Warren	Donny Smith ext-desmith@ncdot.gov	(919) 536-4000
Division 6	P.O. Box 1150 Fayetteville, NC 28302	Bladen, Columbus, Cumberland, Harnett, Robeson	Sean Simmons Lmsimmons1@ncdot.gov	(910) 364-0606
Division 7	P.O. Box 14996 Greensboro, NC 27415-4996	Alamance, Caswell, Guilford, Orange, Rockingham	Justin Martin jgmartin@ncdot.gov	(336) 487-0175
Division 8	150 DOT Drive Carthage, NC 28327	Chatham, Hoke, Lee, Montgomery, Moore, Randolph, Richmond, Scotland	William Purvis wlpurvis@ncdot.gov	(910) 947-3930
Division 9	350 Craft Drive Winston-Salem, NC 27127	Davidson, Davie, Forsyth, Rowan, Stokes	Mike Westmoreland smwestmoreland@ncdot.gov	(336) 896-2400
Division 10	903 Coble Avenue Albemarle, NC 28001	Anson, Cabarrus, Mecklenburg, Stanly, Union	Lori Efird lmefird@ncdot.gov	(704) 244-8270
Division 11	P.O. Box 250 N. Wilkesboro, NC 28659	Alleghany, Ashe, Avery, Caldwell, Surry, Watauga, Wilkes, Yadkin	Joseph Woodie jnwoodie@ncdot.gov	(336) 903-9133
Division 12	P.O. Box 47 Shelby, NC 28151-0047	Alexander, Catawba, Cleveland, Gaston, Iredell, Lincoln	Jamie Jamison jjamison@ncdot.gov	(980) 552-4235
Division 13	55 Orange Street Asheville, NC 28801	Buncombe, Burke, Madison, McDowell, Mitchell, Rutherford, Yancey	Chris Blanton ckblanton@ncdot.gov	(828) 250-3000
Division 14	79 Division Highways Dr Sylva, NC 28779	Cherokee, Clay, Graham, Haywood, Henderson, Jackson, Macon, Polk, Swain, Transylvania	Darryn Knight dbknight@ncdot.gov	(828) 631-1154

Appendix D

NORTH CAROLINA DEPARTMENT OF TRANSPORTATION
SPECIFIC SERVICE (LOGO) SIGNS QUALIFICATION SURVEY

Purchase Order #

[]
Completed by Logo Coordinator

[Form must be completed by NCDOT Logo Coordinator during on-site review of facility.]

Distance from the interchange: [] mile(s)

Invoice/Billing Document #

[]
Completed by Fiscal

Type of service: Gas Food Lodging Camping Attraction

Freeway Route: _____ Interchange Exit No.: _____ Crossroad Route: _____

Name of Business and Trade Name (dba): _____

Business Address (Physical Location): _____

Invoice/Correspondence Mailing Address: _____
(Fill in only if different than above address.)

Name of Business Owner: _____ Phone No.: _____

Name of Business Representative: _____ Phone No.: _____
(Fill in only if not the owner and representative has authority to make decisions and sign contract for owner - May not be advertising agent.)

Appropriate city and/or county business license(s): Yes No Health Sanitation Grade: _____

On-premise landline telephone for emergency use: Yes No On-premise public restroom: Yes No

Permanent on-premise sign specifying business name. Hours of operation posted visibly at the main entrance: Yes No
(See page 2 of 2 for details on signing requirements)

GAS, FOOD, OR ATTRACTION BUSINESSES: HOURS OF OPERATION

Hours of operation are posted on entrance door or in other conspicuous location visible from outside building: Yes No

SUN: _____ MON: _____ TUE: _____ WED: _____

THR: _____ FRI: _____ SAT: _____

This block must be filled in and hours must be posted for any Gas, Food, or Attraction business

GAS: Year- round operation min. 16 continuous hrs/day, 7 days/week: Yes No

- Gas Diesel Alternate Fuels Motor Oil
- Water for batteries and radiators Drinking water suitable for public use
- On premise attendant to collect monies, make change, make or arrange for tire repairs

FOOD: Year- round operation min. 8 continuous hrs/day, 6 days/week: Yes No

Meets Food definition specified on page 2 of 2: Yes No

Indoor seating capacity (min 20): _____

LODGING: Year- round continuous operation: Yes No

No. of lodging rooms for rent: _____ No. of off-street parking spaces: _____

Bathroom with each room: Yes No Bed & Breakfast: Yes No

CAMPING OR ATTRACTION: Months of Operation:

- J F M A M J J A S O N D

CAMPING: Continuous operation 7d days/ week during operating season: Yes No

Total no. of campsites: _____ No. of parking spaces: _____

Has approved water and sewer systems: Yes No

ATTRACTION: Continuously open without appointment at least 8hrs/day, 5 days/week during operating season: Yes No

- Amusement Activity Historic Activity Cultural Activity Leisure Activity Other (specify) _____

No. of parking spaces: _____ (Requires approval of State Traffic Engr.)

Gated facility (See page 2 of 2 for on-premise signing requirements, etc.) : Yes No

Signature of Division Logo Coordinator

Date

Name of Business Owner (or official representative) *Type or Print*

Signature of Business Owner (or official representative)
(Indicates agreement with information included on this document.)

Date

MINIMUM STATE REQUIREMENTS:

All businesses participating in the Logo program must be open to the public of all ages, except if as specified under **ATTRACTION Service Requirement** below*. All Logo businesses must meet the requirements specified herein and in the Logo Rules. See 19A NCAC 02E.0219 for eligibility requirements.

On-Premise Signing:

If a qualifying business wishes to participate in the program and is part of, or contained within, what would otherwise be a non-qualifying business, the qualifying business' name must be prominently displayed on the building or on-premise sign. The posted business name may not be the name of the non-qualifying business that houses the qualifying business.

For GAS and associated services, the following definition applies:

Complies with all administrative code requirements. Provides fuel as primary service. Logo must include a recognizable name, symbol, or trademark for the fuel or must be a recognizable gas business name or logo. If the gas business name or logo is not recognizable to the general motorist as a gas service, the word "Gas" or "Fuel" must also be included in the business Logo panel. Determination of "recognizable" is made by the State Signing and Delineation Engineer.

Words/phrases such as pantry, mini mart, and/or a convenience store name are not considered a recognizable gas business name and may only be used within the Logo panel if they are in the official name of the business. In this case, the word "Gas" or "Fuel" must also be included in the business Logo panel. Any message and/or wording not directly related to the specific service, such as wording related to the sale of merchandise or lottery tickets, is prohibited. Business panels must match on premise business signage.

For FOOD services, the following definition applies:

Complies with all administrative code requirements. Restaurant must provide food and beverage as primary service. A food service includes full service and fast service restaurants serving meals prepared on-premises. Sandwiches and salads that are prepared on the premises are considered a meal. Donuts or pastry items made on-premises are considered a meal. Ice cream dishes, or similar frozen food items, combined with a variety of other ingredients such as fruit and nuts are considered a meal. Ice cream products, frozen yogurt, etc., served by themselves, in cones, or pre-packaged are not considered a meal. A facility selling primarily non-alcoholic beverages such as specialty coffee drinks or smoothies that are prepared on-premises with several ingredients such as fruit and cream may be considered qualifying only if a fully qualifying meal (not beverage) item is also provided. A facility selling primarily alcoholic beverages is not considered qualifying. Pre -packaged food items, whether packaged in quantity or individually, are not considered qualifying food for the purpose of the Specific Service Signing (Logo) Program. Food items prepared off the premises, and transported to the business for serving, or heating and serving, are not considered qualifying food for the purpose of the Specific Service Signing (Logo) Program.

For SERVICE qualification, the following definition applies:

PRIMARY SERVICE – To qualify under a particular service (Gas, Food, or Lodging, etc.), over 50% of the sales revenue for the business at that specific business location must come from the type service requested. For food service, beverage may be considered a portion of the food sales revenue only if at least one qualifying food/meal item is also available at the restaurant.

***ATTRACTION Service Requirement:**

An attraction business will be permitted Logo program participation if age/weight/height/restrictions are posted due to the nature of the attraction. These restrictions must be posted on the attraction business website. An attraction business with a gate at or near the entrance will only qualify for the Logo program if the gate remains open a minimum of 8 consecutive hours per day, 5 days per week. In addition, an attraction business facility with a gate or a guardhouse shall have an on -premise sign at or near the entrance reading "Open to the Public" or "Public Welcome" in minimum 4" letters. The panel design for an attraction service shall clearly specify the service offered. Permanent on-premise signing by business owner at turns and as needed for guidance must be in place directing motorist to the specific attraction(s). Attraction must be on site.

Provisional Contracts:

PROVISIONAL CONTRACTS are used when certain conditions, listed as follows, enabling participation are applicable. Check block as indicated below:

- Maximum distance of three miles (rural) / one mile (urban) from interchange is exceeded for GAS, FOOD, or LODGING services [When evaluating a new request for a provisional contract for this condition, the provisional contract is only allowed if no other existing qualifying business of that service category is located within 3 miles (rural) / 1 mile (urban), regardless of whether business within this limit is participating or not]
- Business logo panels installed on combination service signs for all services other than the first three fully qualified GAS and first three fully qualifying FOOD business panels
- Bed and Breakfast business
- Other _____

(Such as business logo panels that are installed on the Department's pilot signs, less direct exit of an interchange, etc.)

Appendix D
SPECIFIC SERVICE (LOGO) SIGNING CONTRACT

<i>For Department Use Only</i>		
Purchase Order #	Contract #	Customer #

Whereas, it is the desire of _____
(Name of Owner of the Business and Trade Name)

(Mailing Address of Business)

hereinafter referred to as BUSINESS, to participate in the Specific Service (Logo) Signing Program of the North Carolina Department of Transportation, hereinafter referred to as DEPARTMENT, to provide logo signing within the right-of-way of fully-controlled access highways and trailblazer signs on intersecting routes.

The BUSINESS desires signing for _____ Service along
(Gas, Food, Lodging, Camping, or Attraction)
_____ at Exit _____ in _____ County.
(Interstate/Freeway Number) *(Exit Number)*

The BUSINESS agrees to abide by the rules as found in the North Carolina Administrative Code for this Program, the terms of this Contract, and the Department's policies for this Program, as the same are currently in force or as may be amended in the future. The BUSINESS acknowledges receipt of the rules currently in force for this Program.

In consideration of participating in the Specific Service (Logo) Signing Program, the BUSINESS agrees to pay an annual fee per each mainline, ramp, and trailblazer logo panel as established by the DEPARTMENT. This fee shall be paid within 30 days after this contract is approved by the DEPARTMENT, unless otherwise specified by the DEPARTMENT in writing. No logo panels shall be installed by the DEPARTMENT until full payment is received. No partial payments will be accepted for annual fees. No reimbursements will be provided should the BUSINESS decide to discontinue participation or go out of business at any time during the cycle since the fee is all-inclusive, including panel removals and administration.

THEREFORE, in consideration thereof, the BUSINESS offers this written assurance that it conforms with all applicable laws concerning the provision of public accommodations without regard to race, religion, color, sex, age, disability, or national origin and shall not be in breach of this assurance; and

It is understood that should the BUSINESS at any time be in breach of this assurance or at any time fail to be in full compliance with all requirements and criteria specified in the rules, the Qualification Survey Form (TEB 221), this Contract, and Logo policies; the BUSINESS's Logo panels are subject to immediate removal for a minimum of six months and until the BUSINESS fully meets the requirements. At that time, the BUSINESS would need to reapply for participation. No refunds or reimbursements will be provided to the BUSINESS, and there shall be no further obligation on the part of the DEPARTMENT; and

It is understood that the DEPARTMENT will only coordinate and correspond with the BUSINESS owner. The Fiscal Section of the DEPARTMENT will invoice the BUSINESS owner and send fiscal correspondence related to sign removals to the BUSINESS owner. The DEPARTMENT will not send invoices or correspondence to other parties, such as advertising agents.

It is understood that the BUSINESS shall install and maintain a permanent on-premise sign at the main business entrance from the roadway specifying the business name. The sign may be attached or close to the building if it is legible from the roadway. It is also understood that the BUSINESS shall have and maintain a permanent on-premise sign with the days and hours of operation posted conspicuously at the entrance to the building. In addition, an Attraction BUSINESS shall have a permanent on-premise sign with the days and hours of operation posted legibly as you enter the drive to the facility from the roadway; and

It is understood that an Attraction BUSINESS with a gate at or near the entrance will only qualify for the Logo program if the gate remains open a minimum of 8 consecutive hours per day, 5 days per week. It is further understood that a BUSINESS facility with a gate or a guardhouse shall have an on-premise sign at or near the entrance reading "Open to the Public" or "Public Welcome" in minimum 4" letters; and

It is understood that any seasonal Attraction or Camping BUSINESS shall specify the months of closure or months in operation, or otherwise clearly specify the operational season, on all business logo panels; and

Appendix D

It is understood that the BUSINESS shall assure that the DEPARTMENT has the name of its current contact person and mailing address on file and that it will notify the appropriate Division Engineer in writing within 30 days after the contact person and/or mailing address changes; and

It is understood that the transfer of ownership of the BUSINESS shall not in any way affect the validity of this contract provided the appropriate Division Engineer is notified in writing regarding the transfer of ownership within 30 days of the actual transfer, the new owner completes and returns to the Division Engineer an official Transfer of Ownership Form (TEB 223B), and the new owner confirms his/her desire to participate in the Program. If notification does not occur within 30 days of a transfer of ownership, the new owner will be reviewed as a new applicant for Program participation and if approved, a new contract will be required; and

It is understood that the BUSINESS is responsible for paying its invoice within 30 days of receipt unless otherwise specified by the DEPARTMENT in writing. Should the BUSINESS fail to pay this invoice within 30 days of notification, unless otherwise specified by the DEPARTMENT in writing, the DEPARTMENT shall remove the business logo panels and terminate this contract; and

It is understood that the contract period shall begin on the first day of the month closest to the actual day the business logo panel(s) are installed and it will be for a period of 12 months. It is further understood that this contract will automatically be renewed unless one of the following conditions occurs: 1)the BUSINESS fails to meet the terms of this contract; 2)the BUSINESS fails to meet the requirements in the rules for this Program as found in the North Carolina Administrative Code; 3)the BUSINESS fails to be in compliance with Logo policies and information provided on the Qualifications Survey Form (TEB 221); or 4) the signed interchange is *rural* at the time the contract is executed and due to growth and development changes to *urban* (as defined in the rules) and the Gas, Food, or Lodging service is located further than one mile from the interchange, whereby necessitating a change to a provisional contract.

It is understood that before sign panel fabrication, the BUSINESS shall furnish a design (layout) of the specific business logo panel to the DEPARTMENT for review and approval. It is further understood that the BUSINESS shall furnish to the DEPARTMENT at the designated place the necessary business logo panels displaying the name, symbol, or trademark of the BUSINESS fabricated according to DEPARTMENT specifications, at no cost to the DEPARTMENT; and

It is understood that the BUSINESS is responsible for notifying the DEPARTMENT of any missing or damaged business logo panels or trailblazer panels, including at the completion of initial installation. It is further understood that the BUSINESS assumes full responsibility for any damage, deterioration, or loss of any of its panels and agrees to furnish any business panels in need of replacement as requested by the DEPARTMENT; and

It is understood that the DEPARTMENT reserves the right to cover or remove any or all business logo panels in the conduct of maintenance or construction operations, or for research studies, or whenever deemed by the DEPARTMENT to be in the best interest of the DEPARTMENT or the traveling public, without advance notice thereof. The DEPARTMENT may consider a refund to the BUSINESS in this instance only if the business panels were removed for a minimum of six months of the billing cycle. A reimbursement for removed signs in this instance will only be considered at the end of the cycle. Full payment is required at the billing date, including locations that are temporarily removed; and

It is further understood that the DEPARTMENT reserves the right to terminate this program or contract or any portion thereof by furnishing the BUSINESS written notice of such intent not less than 30 calendar days prior thereto.

<hr/>		<hr/>	
Name of Official for BUSINESS (Print or Type)		Name of DEPARTMENT Representative (Print or Type)	
<hr/>	<hr/>	<hr/>	<hr/>
Signature of Official for BUSINESS	Date	Signature of DEPARTMENT Representative	Date
<hr/>		<hr/>	
Title of Official for BUSINESS		Division Engineer	
<hr/>		<hr/>	
Email address of Official for BUSINESS		Title of DEPARTMENT Representative	
<hr/>		<hr/>	
Witness Signature			
<hr/>			

Appendix D

**IF BUSINESS IS INCORPORATED AND POSSESSES
AN OFFICIAL SEAL, AFFIX CORPORATE SEAL:**

Note: The State of North Carolina does not require an incorporated business to purchase or possess an official corporate seal.

NOTIFICATION OF CHANGE IN BUSINESS OWNERSHIP/
ASSIGNMENTS OF RIGHTS AND OBLIGATIONS UNDER THE
DEPARTMENT OF TRANSPORTATION'S
SPECIFIC SERVICE SIGNING (LOGO) PROGRAM

Purchase Order No. _____

WHEREAS, _____, hereinafter referred to as Seller, owns and operates a business which qualifies and is currently participating in the North Carolina Department of Transportation's Specific Service Signing (Logo) Program; and

WHEREAS, _____, hereinafter referred to as Buyer, has purchased or leased the said business owned and operated by the Seller; and

WHEREAS, the Buyer is in possession of and meets all current program rules and qualification criteria, and wishes to continue to participate in the Department's Logo Program;

NOW, THEREFORE, the parties hereto agree as follows:

That in consideration of this assignment of the Seller's participation in the Department's Logo Program, the Buyer hereby agrees to conform to all of the Department of Transportation's rules and regulations established for the Logo Program. Specifically, the Buyer agrees: (1) that the Buyer shall pay the established fee(s) for participation in the Logo Program; (2) that the Buyer shall pay any monies past due under the terms of the Seller's existing Logo Program agreement with the Department; (3) that the current Logo signing is only for the existing business location and is not transferable to another location; (4) that if the business is temporarily closed for renovation or remodeling as a result of the sale of lease of the business, the Buyer shall notify the Department and request the temporary removal or masking of the Logo panel(s) and; (5) if it is necessary to replace the existing Logo panels because of a name change, the Buyer shall pay the cost of the new Logo panels. The Buyer agrees that panel design must be approved by the Department of Transportation and must be manufactured to the Department of Transportation's standards. Further, the Buyer agrees that they shall continue in the same business and meet the same eligibility requirements as engaged in by the Seller and as established by the Department of Transportation.

SEAL

SELLER

DATE

DATE: _____

SEAL

BUYER

DATE

DATE: _____

BUYER'S FEDERAL IDENTIFICATION NO. _____

APPROVED BY THE NORTH CAROLINA DEPARTMENT OF TRANSPORTATION

Division Engineer

Date

Appendix D
SPECIFIC SERVICE (LOGO) PROVISIONAL SIGNING CONTRACT

<i>For Department Use Only</i>		
Purchase Order #	Contract #	Customer #

Whereas, it is the desire of _____
(Name of Owner of the Business and Trade Name)

(Mailing Address of Business)

hereinafter referred to as BUSINESS, to participate in the Specific Service (Logo) Signing Program of the North Carolina Department of Transportation, hereinafter referred to as DEPARTMENT, to provide logo signing within the right-of-way of fully-controlled access highways and trailblazer signs on intersecting routes.

The BUSINESS desires signing for _____ Service along
(Gas, Food, Lodging, Camping, or Attraction)
 _____ at Exit _____ in _____ County.
(Interstate/Freeway Number) (Exit Number)

The BUSINESS agrees to abide by the rules as found in the North Carolina Administrative Code for this Program, the terms of this Contract, and the Department's policies for this Program, as the same are currently in force or as may be amended in the future. The BUSINESS acknowledges receipt of the rules currently in force for this Program.

PROVISIONAL CONTRACTS are used when certain conditions, listed as follows, enabling participation are applicable. A PROVISIONAL CONTRACT is not automatically renewed each billing cycle and is subject to cancellation. The conditions applicable to this PROVISIONAL CONTRACT are indicated below:

- Maximum distance of three miles (rural)/one mile (urban) from interchange is exceeded for GAS, FOOD, or LODGING services. A Provisional Contract is allowed only in two cases: 1) when no qualifying business for the requested specific service category exists within the maximum distance of three miles (rural)/one mile (urban); or 2) when gas, food, or lodging business is located further than one mile from the interchange and due growth and development, the interchanges where signs are located changes from rural to urban, as defined in the rules, requiring customer's standard contract to be canceled and a provisional contract offered. Should a new fully qualifying business of the requested service category locate within the three mile (rural)/one mile (urban) and request participation, and there is not otherwise room on the sign, then this Contract is subject to cancellation.
- Business logo panels installed on combination service signs for all services other than the first three fully qualified GAS and first three fully qualifying FOOD business panels
- Bed and Breakfast business
- Other _____ *(Such as business logo panels that are installed on the Department's pilot signs)*

In consideration of participating in the Specific Service (Logo) Signing Program, the BUSINESS agrees to pay an annual fee per each mainline, ramp, and trailblazer logo panel as established by the DEPARTMENT. This fee shall be paid within 30 days after this contract is approved by the DEPARTMENT, unless otherwise specified by the DEPARTMENT in writing. No logo panels shall be installed by the DEPARTMENT until full payment is received. No partial payments will be accepted for annual fees. No reimbursements will be provided should the BUSINESS decide to discontinue participation or go out of business at any time during the cycle since the fee is all-inclusive, including panel removals and administration.

THEREFORE, in consideration thereof, the BUSINESS offers this written assurance that it conforms with all applicable laws concerning the provision of public accommodations without regard to race, religion, color, sex, age, disability, or national origin and shall not be in breach of this assurance; and

Appendix D

It is understood that should the BUSINESS at any time be in breach of this assurance or at any time fail to be in full compliance with all requirements and criteria specified in the rules, the Qualification Survey Form (TEB 221), this Contract, and Logo policies; the BUSINESS's Logo panels are subject to immediate removal for a minimum of six months and until the BUSINESS fully meets the requirements. At that time, the BUSINESS would need to reapply for participation. No refunds or reimbursements will be provided to the BUSINESS, and there shall be no further obligation on the part of the DEPARTMENT; and

It is understood that the DEPARTMENT will only coordinate and correspond with the BUSINESS owner. The Fiscal Section of the DEPARTMENT will invoice the BUSINESS owner and send correspondence related to sign removals to the BUSINESS owner. The DEPARTMENT will not send invoices or correspondence to other parties, such as advertising agents.

It is understood that the BUSINESS shall install and maintain a permanent on-premise sign at the main business entrance from the roadway specifying the business name. The sign may be attached or close to the building if it is legible from the roadway. It is also understood that the BUSINESS shall have and maintain a permanent on-premise sign with the days and hours of operation posted conspicuously at the entrance to the building. In addition, an Attraction BUSINESS shall have a permanent on-premise sign with the days and hours of operation posted legibly as you enter the drive to the facility from the roadway; and

It is understood that an Attraction BUSINESS with a gate at or near the entrance will only qualify for the Logo program if the gate remains open a minimum of 8 consecutive hours per day, 5 days per week. It is further understood that a BUSINESS facility with a gate or a guardhouse shall have an on-premise sign at or near the entrance reading "Open to the Public" or "Public Welcome" in minimum 4" letters; and

It is understood that any seasonal Attraction or Camping BUSINESS shall specify the months of closure or months in operation, or otherwise clearly specify the operational season, on all business logo panels; and

It is understood that the BUSINESS shall assure that the DEPARTMENT has the name of its current contact person and mailing address on file and that it will notify the appropriate Division Engineer in writing within 30 days after the contact person and/or mailing address changes; and

It is understood that the transfer of ownership of the BUSINESS shall not in any way affect the validity of this contract provided the appropriate Division Engineer is notified in writing regarding the transfer of ownership within 30 days of the actual transfer, the new owner completes and returns to the Division Engineer an official Transfer of Ownership Form (TEB 223B), and the new owner confirms his/her desire to participate in the Program. If notification does not occur within 30 days of a transfer of ownership, the new owner will be reviewed as a new applicant for Program participation and if approved, a new contract will be required; and

It is understood that the BUSINESS is responsible for paying its invoice within 30 days of receipt unless otherwise specified by the DEPARTMENT in writing. Should the BUSINESS fail to pay this invoice within 30 days of notification, unless otherwise specified by the DEPARTMENT in writing, the DEPARTMENT shall remove the business logo panels and terminate this contract; and

It is understood that the contract period shall begin on the first day of the month closest to the actual day the business logo panel(s) are installed and it will be for a period of 12 months. It is further understood that this contract will automatically be renewed unless the BUSINESS fails to meet the terms of this contract or the requirements of the North Carolina Administrative Code; and

It is understood that before sign panel fabrication, the BUSINESS shall furnish a design (layout) of the specific business logo panel to the DEPARTMENT for review and approval. It is further understood that the BUSINESS shall furnish to the DEPARTMENT at the designated place the necessary business logo panels displaying the name, symbol, or trademark of the BUSINESS fabricated according to DEPARTMENT specifications, at no cost to the DEPARTMENT; and

Appendix D

It is understood that the BUSINESS is responsible for notifying the DEPARTMENT of any missing or damaged business logo panels or trailblazer panels, including at the completion of initial installation. It is further understood that the BUSINESS assumes full responsibility for any damage, deterioration, or loss of any of its panels and agrees to furnish any business panels in need of replacement as requested by the DEPARTMENT; and

It is understood that the DEPARTMENT reserves the right to cover or remove any or all business logo panels in the conduct of maintenance or construction operations, or for research studies, or whenever deemed by the DEPARTMENT to be in the best interest of the DEPARTMENT or the traveling public, without advance notice thereof. The DEPARTMENT may consider a refund to the BUSINESS in this instance only if the business panels were removed for a minimum of six months of the billing cycle. A reimbursement for removed signs in this instance will only be considered at the end of the cycle. Full payment is required at the billing date, including locations that are temporarily removed; and

It is further understood that the DEPARTMENT reserves the right to terminate this program or contract or any portion thereof by furnishing the BUSINESS written notice of such intent not less than 30 calendar days prior thereto.

Name of Official for BUSINESS (Print or Type)		Name of DEPARTMENT Representative (Print or Type)	
Signature of Official for BUSINESS	Date	Signature of DEPARTMENT Representative	Date
Title of Official for BUSINESS		Division Engineer	
Email address of Official for BUSINESS		Title of DEPARTMENT Representative	
Witness Signature			

IF BUSINESS IS INCORPORATED AND POSSESSES AN OFFICIAL SEAL, AFFIX CORPORATE SEAL:

Note: The State of North Carolina does not require an incorporated business to purchase or possess an official corporate seal.

Appendix D

**SPECIFIC SERVICES SIGNING
BUSINESS (LOGO) PANEL REQUIREMENTS**

This form to be completed by Division Logo Coordinator:

Purchase Order # _____ Contract # _____ Customer # _____

Freeway
Route _____ Interchange Exit No. _____ Crossroad No. _____

(Business Name) (Trade Name)

(Business Address)

The type, size, and quantity of business (LOGO) panels required for participation in the program of the North Carolina Department of Transportation to provide specific service signing along the freeway route are as follows:

GAS	<input type="checkbox"/>	48" x 36" Mainline	_____
FOOD	<input type="checkbox"/>	24" x 18" Ramp	_____
LODGING	<input type="checkbox"/>	24" x 18" Trailblazer	_____
CAMPING	<input type="checkbox"/>		
ATTRACTION	<input type="checkbox"/>		
Total Number of Panels Required			_____
Fee Per Panel			_____
Total Fee			_____

The total annual fee, payable to the North Carolina Department of Transportation, shall be remitted within 30 days after the contract is approved by the Department, unless otherwise specified by the Department in writing. Remittance shall be delivered to the address for correspondence shown below.

Businesses must submit a layout of their proposed business (LOGO) panel for review and approval by the Department of Transportation before the business (LOGO) panel is fabricated.

All required business (LOGO) panels shall be fabricated according to appropriate specifications and shall be delivered (*properly insured*) to the location designated below by _____

Correspondence and Remittance Address:

Shipping Address:

Comments: _____

If additional information is needed concerning this program, please contact the Division Engineer or:

State Signing and Delineation Engineer
North Carolina Department of Transportation
1561 Mail Service Center
Raleigh, North Carolina 27699-1561

Appendix D
SPECIFIC SERVICES SIGNING
TRAILBLAZER BUSINESS PANEL CONSOLIDATION

Use this form for documentation when combing mainline/ramp with trailblazer contracts.

This form to be completed by Division Logo Coordinator:

Purchase Order # _____ Old Contract # _____ Customer # _____

New Contract # _____

Freeway/Expressway

Route _____ Interchange Exit No. _____ Crossroad No. _____

(Business Name)

(Trade Name)

(Business Address)

The type, size, and quantity of business (LOGO) panels required for participation in the program of the North Carolina Department of Transportation to provide specific service signing along the freeway route are as follows:

GAS	<input type="checkbox"/>	48" x 36" Mainline	_____
FOOD	<input type="checkbox"/>	24" x 18" Ramp	_____
LODGING	<input type="checkbox"/>	24" x 18" Trailblazer	_____
CAMPING	<input type="checkbox"/>		
ATTRACTION	<input type="checkbox"/>		
Total Number of Panels Required			_____
Fee Per Panel			_____
Total Fee			_____

Trailblazer Contract #: _____

Voided Date: _____

Division Logo Coordinator Signature: _____

Date Signed: _____

Potential Logo Business Survey (Page 1 of 2)

Date: _____

Form to be completed by the Logo Coordinator and verified by the Project Engineer

Division: _____ Main Route: _____ Crossing Route: _____
 Rural/Urban: _____ Exit #: _____ Div Coordinator: _____

GAS

BUSINESS (Name)	Existing Sign? (Y/N)	Open ? (Y/future)	Qual? (Y/N)	Written Request? (Y/N)	Distance ? (miles)	A/B Exit? (No, A, B)	Prj. Eng. Verified (Initials/Date)
1							
2							
3							
4							
5							
6							

Specify Size of GAS Panel Required (see page 2): _____

FOOD

BUSINESS (Name)	Existing Sign? (Y/N)	Open ? (Y/future)	Qual? (Y/N)	Written Request? (Y/N)	Distance ? (miles)	A/B Exit? (No, A, B)	Prj. Eng. Verified (Initials/Date)
1							
2							
3							
4							
5							
6							

Specify Size of FOOD Panel Required (see page 2): _____

LODGING

BUSINESS (Name)	Existing Sign? (Y/N)	Open ? (Y/future)	Qual? (Y/N)	Written Request? (Y/N)	Distance ? (miles)	A/B Exit? (No, A, B)	Prj. Eng. Verified (Initials/Date)
1							
2							
3							
4							
5							
6							

Specify Size of LODGING Panel Required (see page 2): _____

CAMPING/ATTRACTIONS

BUSINESS (Name)	Existing Sign? (Y/N)	Open ? (Y/future)	Qual? (Y/N)	Written Request? (Y/N)	Distance ? (miles)	A/B Exit? (No, A, B)	Prj. Eng. Verified (Initials/Date)
1							
2							
3							
4							
5							
6							

Specify Size of CAMPING/ATT Panel Required (see page 2): _____

Appendix D

Potential Logo Business Survey (Page 2 of 2)				Date: _____
Form to be completed by the Logo Coordinator and verified by the Project Engineer				
Division: _____	Main Route: _____	Crossing Route: _____		
Rural/Urban: _____	Exit #: _____	Div Coordinator: _____		

OVERFLOW: Specify design _____ (such as GAS/FOOD or FOOD/LODGING)

	BUSINESS (Name)	Service (Gas, Food...)	Existing Sign? (Y/N)	Open ? (Y/future)	Qual? (Y/N)	Written Request? (Y/N)	Distance ? (miles)	A/B Exit? (No, A, B)	Prj. Eng. Verified (Initials/Date)
1									
2									
3									
4									
5									
6									

Specify Size of Panel Required (see note below): _____

Note: When determining size for the Logo sign, use the following guideline:

For new projects where no existing businesses are currently participating at the interchange for that service type, use the 3 panel design when 3 or less businesses will potentially participate at the completion of the Logo project. If it is known that additional businesses for a service type will exist within a year, the Logo Coordinator or Project Engineer may request the 6 panel sign with a brief explanation below the list of businesses. Use 6 panel design when more than 3 businesses will potentially participate at the completion of the Logo project. For upgrade projects, we should only upgrade to the 6 panel design when necessary to accommodate a qualified requesting business, i.e., when a 4th qualified business has requested participation for that service.

Sketch the interchange below if desired:

Appendix E

LOGO BUSINESS PANEL DETAILS

MAINLINE

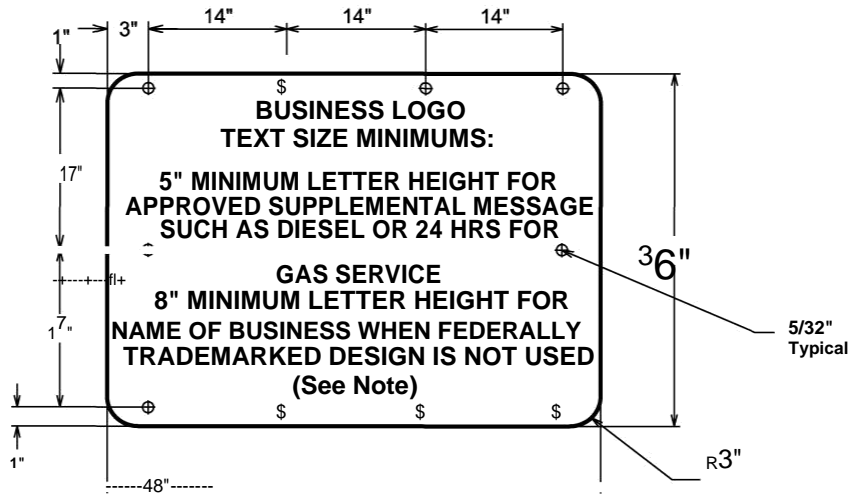

RAMP



TRAILBLAZING SIGNS

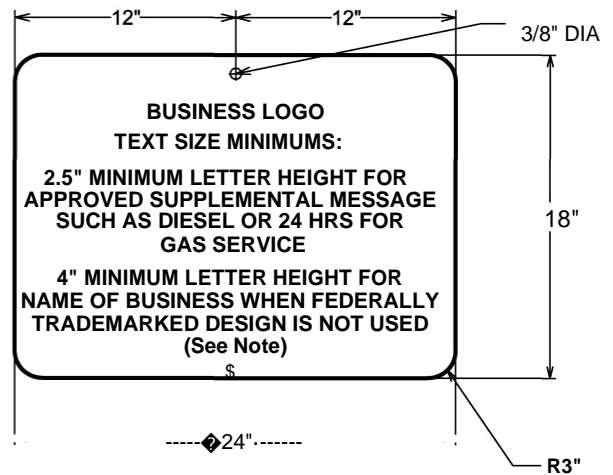

*** WHEN A BUSINESS DOES NOT HAVE A FEDERALLY REGISTERED (TRADEMARKED) DESIGN, BUT USES A PICTORAL DESIGN OR SYMBOL WITHIN THE PANEL DESIGN, THE MINIMUM LETTER SIZE FOR THE NAME OF BUSINESS MUST BE MET. THE LOGO DESIGN MUST NOT BE SIMILAR IN PART OR OVERALL TO ANY TRADEMARKED DESIGN. WORDS WITHIN FEDERALLY TRADEMARKED DESIGNS DO NOT HAVE A MINIMUM LETTER SIZE REQUIREMENT.**

NOTE: WHEN A FEDERALLY REGISTERED (TRADEMARKED) DESIGN IS USED, THE DESIGN SHALL INCLUDE THE TRADEMARK REGISTRATION SYMBOL. WHEN REGISTRATION PERTAINS TO SERVICE MARK OR WORDS ONLY (NOT DESIGN), REGISTRATION SYMBOLS ARE NOT REQUIRED AND MINIMUM LETTER SIZES ARE REQUIRED.

MATERIALS: 6061-T6OR 5052 H 38 AND NCDOT GRADE C OR GREATER REFLECTIVE SHEETING
 THE SIGN SHALL BE FABRICATED FROM FLAT SHEET ALUMINUM OF 0.063 INCH MINIMUM
 AND 0.125 MAXIMUM THICKNESS. SEE STANDARD SPECIFICATION SECTION 1092.

BUSINESS: _____
 AGREEMENT NO: _____

COUNTY: _____ NO. ML: _____
 ROUTE: _____ NO. RP: _____
 EXIT: _____ NO. TB: _____

Appendix F

Appendix F

Appendix F

Division 1 36111.1.1

Division 2 36111.1.2

Division 3 36111.1.3

Division 4 36111.1.4

Division 5 36111.1.5

Division 6 36111.1.6

Division 7 36111.1.7

Division 8 36111.1.8

Division 9 36111.1.9

Division 10 36111.1.10

Division 11 36111.1.11

Division 12 36111.1.12

Division 13 36111.1.13

Division 14 36111.1.14

Appendix G

STATE OF NORTH CAROLINA DEPARTMENT OF TRANSPORTATION

SIGNING AND DELINEATION UNIT

1561 MAIL SERVICE CENTER

GARNER, NC 27529

PROJECT _____
COUNTY _____
SIGN No. _____
STA.No. _____

BREAKAWAY/SIMPLE _____
RIGHT/LEFT _____
FIGURED BY _____
CHECKED BY _____

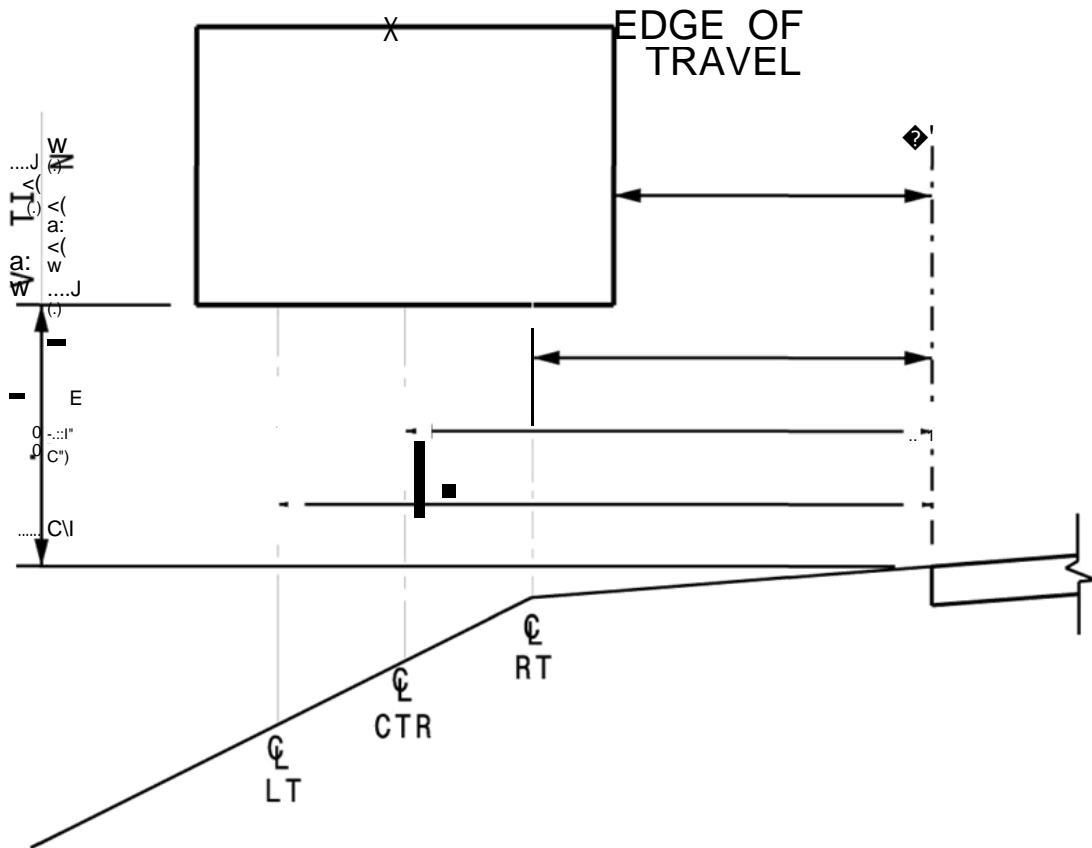

STATE OF NORTH CAROLINA
DEPARTMENT OF TRANSPORTATION

SIGNING AND DELINEATION UNIT

1561 MAIL SERVICE CENTER
GARNER, NC 27529

PROJECT _____
COUNTY _____
SIGN No. _____
STA.No. _____

BREAKAWAY/SIMPLE _____
RIGHT/LEFT _____
FIGURED BY _____
CHECKED BY _____

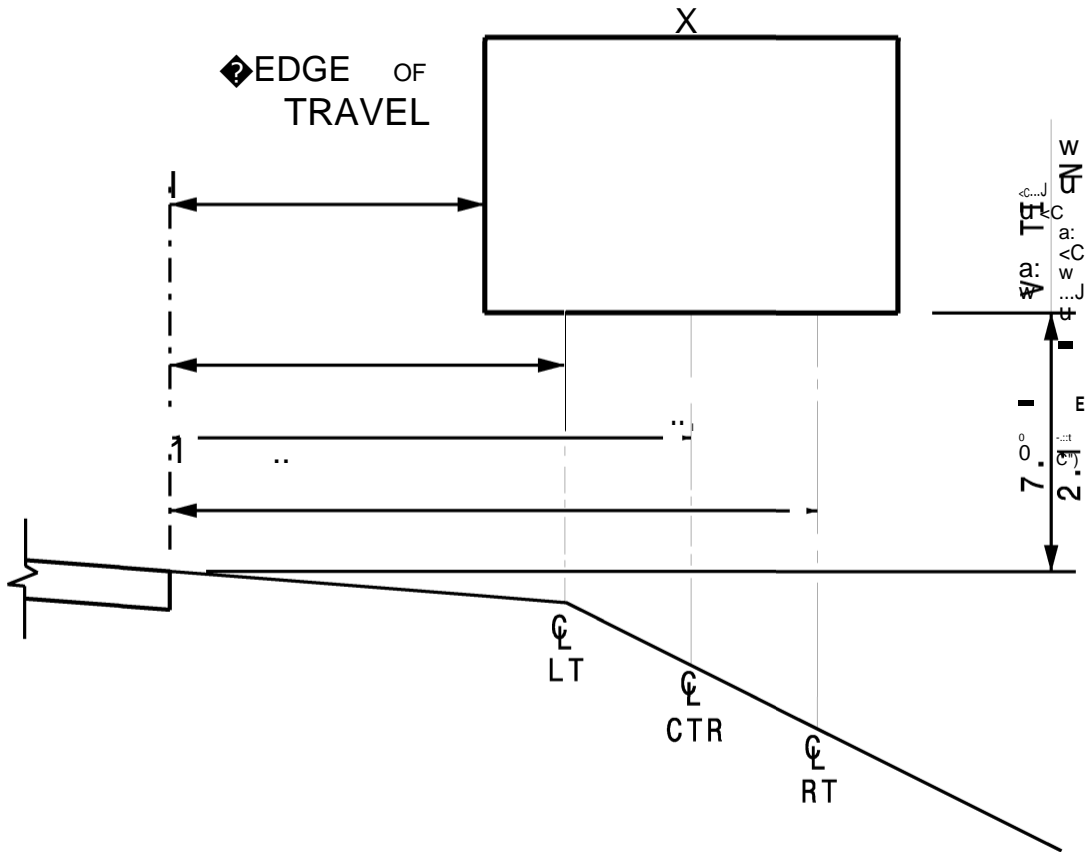

Appendix H



Logo Contract Maintenance Step-by-Step

Table of Contents

Introduction	4
Conventions	4
SAP Resources	4
Overview	5
Key Terms	5
Annual Contract Renewal Process	7
Review Financial History of Contract and Customer	9
Contract Document Flow	9
VA43 – Display Contract Document Flow	10
Contract	10
VA43 – Display Contract	10
Customer Line Items Report	12
FBL5N – Display Customer Line Items	13
Cancel Contract	16
Cancel Contract Process	16
Issue Work Order to Dismantle Panels	16
Display Contract Document Flow & Contract	16
Display Customer Line Items	16
Calculate New Contract End Date	16
Notify Accounts Receivable, if Necessary	17
Confirm Panels Were Dismantled	17
Cancel Contract	18



Steps to Cancel an Unbilled Contract	18
VA42 – Cancel Unbilled Contract	19
Steps to Cancel a Billed Contract	22
VA42 – Cancel Billed Contract	23
Reinstating Cancelled Contracts	26
Add Panel to Contract	27
Display Contract	27
Calculate Prorated Order Quantity	27
VA01 – Create Prorated Sales Order	28
VF01 – Create Billing Document	29
Mail Invoice / Receive Payment	30
Issue Work Order to Install Panel	30
Confirm Panel Was Installed	30
VA42 – Add Panel to Contract	30
Send Documents & Payment to Accounts Receivable	33
Cancel Panel on Contract.....	34
Issue Work Order to Dismantle Panel	34
Display Customer Line Items	34
Notify Accounts Receivable	35
Confirm Panel was Dismantled	35
VA42 – Cancel Panel on Contract	35
Notify Accounts Receivable	37
Change Ownership of Contract	38
Verify Change of Ownership	39
Display Contract Document Flow	39
Display Customer Line Items	39
Notify Accounts Receivable, if Necessary	39
VA42 – Cancel Contract for Previous Owner	39
Search for/Create Customer Master Record	42
VA41 – Create Contract with Reference to Cancelled Contract	43
Display New Contract Document Flow	46
Send Documents to Accounts Receivable	46



Merge Contracts47

- Display Customer Line Items47
- VA42 – Cancel Secondary Contract47
- VA42 – Add Panels to Primary Contract50
- Notify Accounts Receivable53

Tips & Tricks54

- Set Parameters.....54
- FBL5N – Display Invoices Created During Billing Process.....55
- XD03 – Display Dunning Letters55
- ZCON – Display SD Contract Report with Customer Name56
- Y_DEV_60000077 – SD Open Items Report58
- Y_DEV_60000070 – Customer Sales Area Query59

Appendix60

- Logo Materials & Fees60
- Logo WBS Elements.....60



Introduction

The Logo Contract Maintenance guide provides step-by-step instructions for maintaining contracts for the Logo Signing Program.

Conventions

Italicized text indicates text that must be entered in a field.

Bold text in a procedure step indicates application elements that you select, choose, press or enter text.

Italicized and bolded text in a procedure indicates the name of a screen or dialog box that displays.

The following text boxes in a procedure indicate important information:



Note – a guideline or practice



Helpful Hint – a tip or hint that helps improve your efficiency



Warning – a notification of important information



Example – an example relevant to the task at hand



Decision – a choice to make that will determine your next step

SAP Resources

Course materials, course catalog and training calendar are published on the BSIP (SAP) Training page of Inside NCDOT.



Overview

Key Terms

The following is a list of key terms and acronyms used throughout this guide. Refer to this section if you encounter an unfamiliar term.

Term	Acronym	Description
Accounting Document	--	SAP document used by Accounts Receivable to post customer payment; automatically created when billing document is saved
Billed Contract	--	contract that has had a payment posted against it
Billing Document	--	SAP document used to create an invoice
Business	--	actual business (gas station, restaurant, etc.) included in the Logo Signing Program; may also be called physical location or trade name
Business Owner	--	company or individual who owns the business (same as customer unless Logo fees are paid by corporate office)
Contract	--	SAP sales document that contains control data for the billing of annual renewal fees associated with the Logo Signing Program; includes details about the business
Customer	--	company or individual who pays the Logo fees (same as business owner until Logo fees are paid by corporate office)
Customer Master Record	--	data record in SAP that contains all information necessary to conduct business transactions with a specific customer
Invoice	--	printed document used to notify customer of payment due; automatically prints when billing document is saved



Term	Acronym	Description
Logo Panel	--	sign depicting the name, symbol and/or trademark of a business included in the Logo Signing Program; may be used to refer to mainline panel, ramp panel or trailblazer panel
Mainline Panel	--	Logo panel attached to service sign prior to exit on route
Physical Location	--	physical location of the actual business represented on the Logo panel; may also be called trade name or business
Ramp Panel	--	Logo panel attached to service sign on exit ramp
Sales Order	SO	SAP sales document that contains control data for the one-time billing of fees associated with the Logo Signing Program
Service Sign	--	sign to which Logo panels are attached
Trade Name	--	SAP term for the actual business (gas station, restaurant, etc.) included in the Logo Signing Program; may also be called physical location or business
Trailblazer Panel	--	Logo panel attached to service sign on secondary road when more than one turn is necessary to find the business
Unbilled Contract	--	contract that has not had a payment posted against it, even if it has been invoiced
WBS Element	WBS	cost collector for revenues related to the Logo Signing Program



Annual Contract Renewal Process

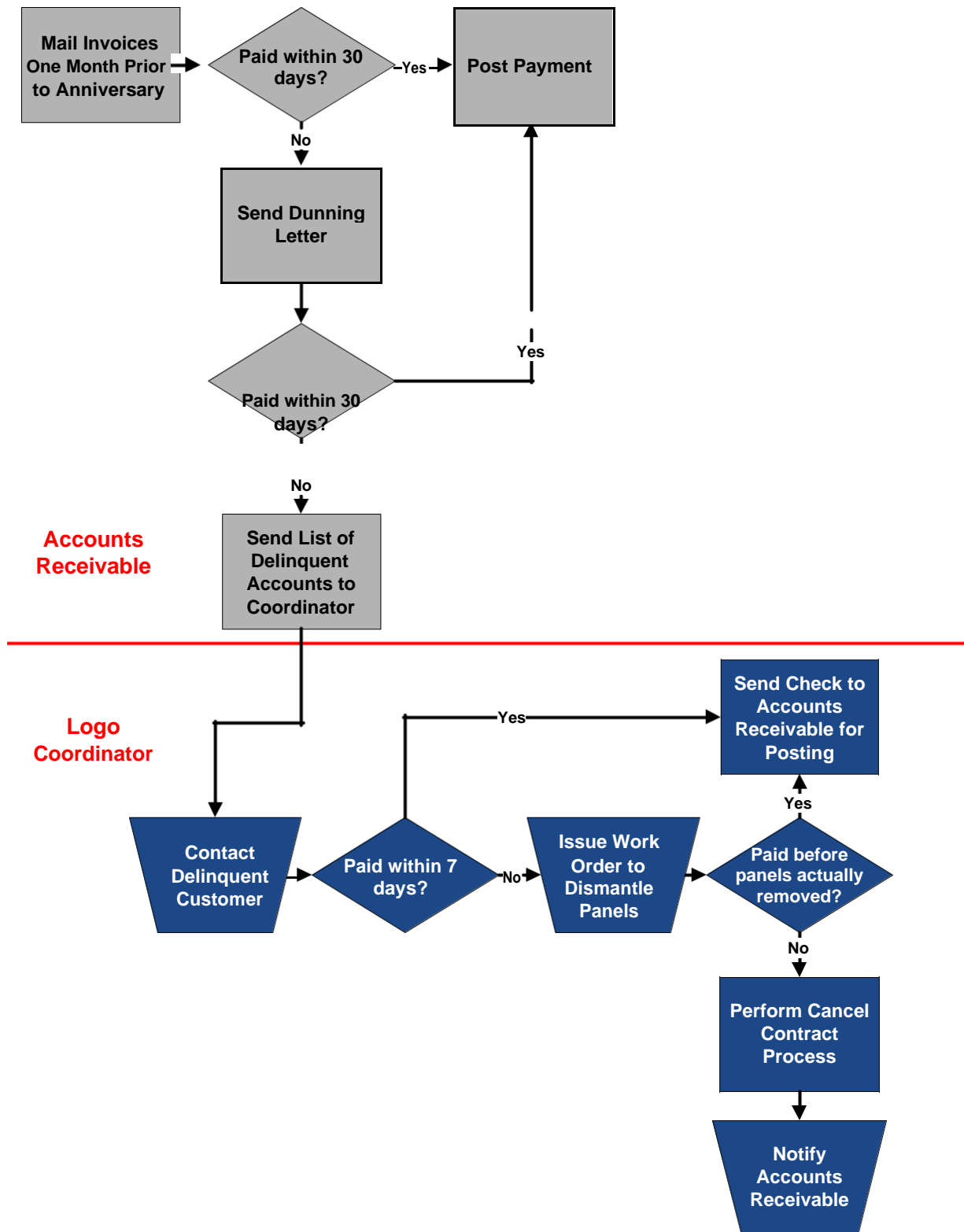



Logo contracts are renewed according to the *Annual Contract Renewal* process. Accounts Receivable mails invoices for annual renewal fees one month prior to the contract's anniversary. If the customer pays the invoice within 30 days, Accounts Receivable posts the customer payment against the contract. The contract is renewed and requires no additional maintenance.

If the customer does not pay the invoice within 30 days, Accounts Receivable sends a reminder (dunning letter) to the customer. If the customer pays the invoice, Accounts Receivable posts the customer payment and the contract is renewed. If the customer still does not remit payment within the time limit set in the dunning letter, Accounts Receivable forwards the customer information to the Logo Coordinator.

The Logo Coordinator contacts the customer, informing them that payment must be received by the Coordinator within 7 days or the logo panels will be removed. If the Coordinator receives payment, they forward the check to Accounts Receivable, where it is posted and the contract is renewed. If the Coordinator does not receive payment within the time limit, they issue a work order to dismantle the panels.

If the customer remits payment before the panels are actually removed, the payment is posted and the contract remains in force. If the panels are removed, the Logo Coordinator performs the *Cancel Billed Contract* process and notifies Accounts Receivable that the contract has been cancelled. Accounts Receivable cancels the outstanding invoice.



Review Financial History of Contract and Customer

Before maintaining a contract, review the financial history of the contract and the customer using the contract document flow, the contract, and the Customer Line Items report.

Contract Document Flow

The contract document flow displays a list of all financial documents for the contract. Review the contract document flow to determine if the contract has been invoiced, and if so, if the invoice has been cleared. If the document flow does not include an invoice, it is an unbilled contract. If the document flow includes at least one invoice, and the invoice has been cleared, it is a billed contract. If the document flow includes only one invoice, and that invoice has not been cleared, the contract is treated as an unbilled contract.

Document Flow Screen

Business partner 0000001331 BURGER KING CORPORATION		
Referenced contracts		
	On	Status
Logo Contract 0040011961	06/05/2003	Completed
Logo Contract 0040023671	09/16/2005	Completed
Logo Contract 0040028945	05/04/2010	Being processed
Logo Invoice 0090324260	09/30/2010	Completed
Accounting document 0090324260	10/01/2010	Cleared
Logo Invoice 0090371801	09/29/2011	FI doc. generated
Accounting document 0090371801	10/03/2011	Cleared
Logo Invoice 0090419429	09/26/2012	FI doc. generated
Accounting document 0090419429	10/01/2012	Not cleared

The Document Flow screen displays the name and customer master record number of the owner of the contract in the header. When a Logo contract is created in reference to another Logo contract, the active contract is highlighted, is indented and displays → to the left.

The term invoice refers to the document that prints when an SAP billing document is saved. In the contract document flow, billing documents are called Logo invoices. Each Logo invoice has an associated accounting document that is automatically created to record the customer payment.

When an invoice is paid by the customer or otherwise cleared by Accounts Receivable, the accounting document displays a status of *Cleared*. Accounting documents for invoices that have been cancelled by Accounts Receivable also display a status of



Cleared. (Use transaction FBL5N to determine how the invoice was cleared. Refer to the *FBL5N – Display Customer Line Items* procedure for instructions.)

If payment for an invoice has not been posted against the contract, the status of *Not cleared* displays for the accounting document. When the contract document flow includes at least one Logo invoice and accounting document, the contract has been invoiced (but the invoice may or may not have been paid by the customer).

VA43 – Display Contract Document Flow

Use this procedure to determine if a contract has been invoiced, and if an invoice has been cleared.

1. Enter **VA43** in the **Command** field on the **SAP Easy Access** screen.
2. Click  or press **Enter**. The **Display Contract: Initial Screen** displays.
3. Enter a *contract number* in the **Contract** field.



Do not click  or press **Enter**.

4. Click . The **Document Flow** screen displays.



The customer master record number and name displays to the right of **Business partner** in the header.

5. Review the list of financial documents for the contract.



The **On** column displays the date the document was created. The **Status** column displays the status of the document.

Contract numbers begin with 004. Invoice numbers begin with 009.

6. Select a contract number, then click  to display the contract, if desired.
7. Click  to exit this transaction.



Contract

Contracts include details about the business and the Logo agreement. Review a contract to identify contract start and end dates, materials, quantities, etc. Contracts can be displayed from the VA43 initial screen or from within the contract document flow.

VA43 – Display Contract

Use this procedure to identify additional information about a contract and Logo panels.







1. Enter **VA43** in the **Command** field on the **SAP Easy Access** screen.
2. Click  or press **Enter**. The **Display Contract: Initial Screen** displays.
3. Enter a *contract number* in the **Contract** field.
4. Click  or press **Enter**. The **Display Logo Contract [number]: Overview** screen displays.
5. Review values in the following fields of the header:
 - **Logo Contract** – contract number
 - **Sold-To Party** – customer master record number and customer name/address
 - **Ship-To Party** – customer master record number and business name/address
 - **PO Number** – agreement number
 - **PO date** – date contract was created
6. Review values in the following fields on the **Sales** tab:
 - **Contract start** – beginning date of contract
 - **Contract end** – ending date of contract
 - **Sales area** – sales organization, distribution channel, and division
7. Review data in the following columns:

 If the contract contains four or more line items, only the first three are included on the annual billing document, and the printed invoice does not reflect the total amount due.

 - **Material** – Logo material number
 - **Target quantity** – amount of material
 - **Description** – description of Logo material
 - **Net value** – value of Logo material on line item
 - **WBS Element** – object to which Logo payments are posted
8. Click  in the header. The **Display Logo Contract [number]: Header Data** screen displays.
9. Review values in the following fields on the **Sales** tab:
 - **Created by** – ID of user who created contract
 - **Created on** – date contract was created
10. Select the **Contract data** tab.
11. Review values in the following fields:



- **Installation date** – date panels were installed
 - **Acceptance date** – date customer check was received
 - **Contract signed** – date agreement was signed by Division Engineer or designee
 - **Dismantling date** – date panels were dismantled
 - **Reason for cancel.** – reason contract was cancelled
 - **Receipt of canc.** – date NCDOT received notice of cancellation from the customer or date panels were removed (if contract cancelled due to lack of payment)
12. Select the **Partners** tab.
 13. Click  to the left of **Ship-to party**.
 14. Click  near the bottom of the screen. The **Address From Master Data for Ship-to party** dialog box displays.

 Data on this dialog box should reflect details about the business (rather than the customer).
 15. Review the data.
 16. Click  to close the dialog box.
 17. Click  to exit this transaction.

Customer Line Items Report

The Customer Line Items report displays a list of all financial documents for a customer. Review the report to determine if a contract is billed or unbilled, how an invoice was cleared, if a contract has unpaid invoices, and the date of the last customer payment. A customer can have more than one Logo contract, so it is important to refer to the values in the Reference and Assignment columns to correctly identify each line item.

Every invoice that has been cleared has two line items: one for the invoice and another for the document that cleared it. Both line items have the same clearing document number.

Logo invoices (RV document type) that were paid by the customer are cleared by an incoming payment (DZ document type) for the offsetting amount. Invoices (RV) with customer payments (DZ) indicate the contract is a billed contract. See the chart below:

	Doc No	Doc Type	Amount	Clearing Doc
invoice line item	90362997	RV	1200.00	1400025405



clearing line item	1400025405	DZ	-1200.00	1400025405
--------------------	------------	----	----------	------------

Logo invoices that were cleared by some means other than an incoming payment display a different document type for the clearing document, but both line items still have the same clearing document number. Invoices (RV) cleared by other means (AC) may indicate the contract is an unbilled contract. See the chart below:

	Doc No	Doc Type	Amount	Clearing Doc
invoice line item	90246147	RV	300.00	101377755
clearing line item	101377755	AC	-300.00	101377755

If the clearing line item has a document type of AC, contact Accounts Receivable for more information about the invoice and how it was cleared. If the clearing line item has a document type of AB, the invoice was reversed. Contact Accounts Receivable for more information.



FBL5N – Display Customer Line Items

Use this procedure to determine how an invoice was cleared, if a contract has any unpaid invoices, and/or the date of the most recent customer payment.

1. Enter *FBL5N* in the **Command** field on the **SAP Easy Access** screen.
2. Click  or press **Enter**. The **Customer Line Item Display** screen displays.
3. Enter the *customer master record* in the **Customer account** field.
4. Select the **All items** radio button.



Select the **Open items** radio button to display line items with open balances only.





5. Ensure */DUNNING* displays in the **Layout** field.
6. Click . A list of line items for the customer displays.
7. Click the **Doc. Date** column heading, then click  to sort the line items in chronological order.



Customers may have multiple Logo contracts. When reviewing report data, ensure the values referenced are for the correct contract.

8. Review data in the following columns:
 - **Cleared/open items symbol indicating status (St)**
 -  indicates open



-  indicates cleared
-  indicates parked
- **Document Number** – document number
- **Document Type (Typ)**
 - AB – accounting document
 - AC – clearing posting
 - DP – dunning penalty
 - DR – customer invoice
 - DZ – incoming payment
 - RV – invoice
- **Document Date** – date document was created
- **Reference**
 - contract number (when value begins with 004)
 - invoice number against sales order (when value begins with 009)
- **Assignment** – agreement number or document number followed by fiscal year
- **Due date (DD)**
 -  indicates past due
 -  indicates not due
- **Amount in local currency** – amount for line item

 Invoice line items on this report display the total amount due for the contract. If the contract contains more than three line items, only the first three are included on the annual billing document, and the printed invoice does not reflect the total amount due. When the customer pays the incorrect invoice, the amount paid does not match the amount owed.
- **Text** – explanatory text for line item
- **Clearing date** – date clearing document cleared
- **Clearing Document** – clearing document number
- **Last dunned** – date accounting document was last dunned
- **Dunning level**
 - 1 – customer has been notified of past due balance



- 2 – expect communication from Accounts Receivable regarding possible cancellation of contract
 - **Dunning block** – indicates customer will not continue to be dunned until a payment conflict has been resolved
 - H – indicates account is on hold for management review
 - L – indicates contract has been sent to Logo Coordinator for sign removal
9. Click  to exit this transaction.



Cancel Contract

Cancel Contract Process

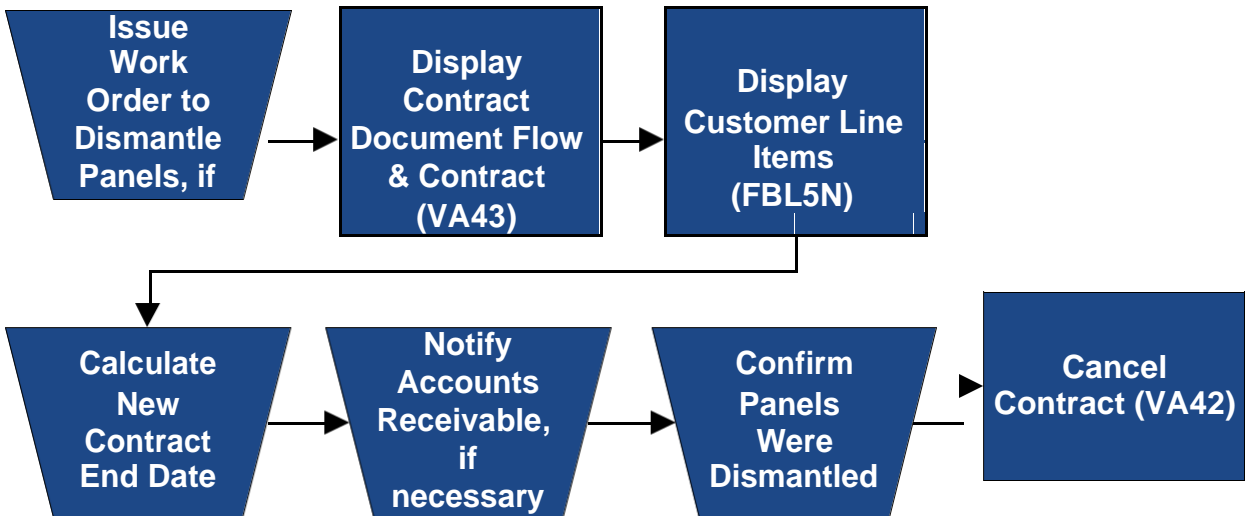

Issue Work Order to Dismantle Panels

The Logo Coordinator issues a work order for NCDOT personnel or a contractor to remove Logo panels, if panels were installed.

Display Contract Document Flow & Contract

Display the document flow from the contract to review the customer name and master record number in the header to ensure the change of ownership has not already been performed. Refer to the *VA43 – Display Contract Document Flow* procedure for instructions.

Display the contract to identify and record the contract start and end dates.

Display Customer Line Items

Execute this report to ensure all invoices have cleared properly and to determine the date of the last customer payment. Refer to the *FBL5N – Display Customer Line Items* procedure for instructions.

Calculate New Contract End Date

When cancelling a contract for any reason, the contract end date that was entered when the contract was created must be changed to the last day of the most recent period for



which payment has been received. If not changed, the system will continue to generate annual invoices for the contract.

When cancelling a contract, SAP automatically proposes a cancellation date as part of the procedure. Always manually calculate the new contract end date for comparison to the proposed date to ensure it is correct before accepting it. Typically, the new contract end date should be the last day of the most recent period for which payment was received.

For example, a Logo customer pays their first-year fees on 12/1/2014, which covers 12/1/2014 through 11/30/2015. The contract is created with a start date of 12/01/2015, the day after the first-year fees coverage ends. The first contract renewal period is 12/01/2015 to 11/30/2016. If the customer requests that the contract be cancelled on 9/30/2015, they are within the first-year coverage and haven't received their first bill for annual renewal fees. The contract is cancelled following the *Cancel Unbilled Contract* process. SAP proposes a contract end date of 11/30/2015, which is correct.

Let's say the same contract isn't cancelled during the first year, but instead goes on for a few years. The customer requests on 05/15/2021 that the contract be cancelled. The *Customer Line Item Display* report indicates the last payment from the customer was received on 11/15/2020 (which pays for the renewal period 12/01/2020 to 11/30/2021). The contract is cancelled following the *Cancel Billed Contract* process. SAP proposes a contract end date of 11/30/2021, which is correct, because it is the last day of the most recent contract renewal period for which payment has been received).

Now let's say the customer wasn't sure if they wanted to renew or cancel, and doesn't notify NCDOT that they want to cancel until 01/15/2022 (six weeks past due, and into the next renewal period). The contract is cancelled following the *Cancel Billed Contract* process. The end date should be 11/30/2021 (the last day of the most recent contract renewal period for which payment has been received), but because the contract cancellation went into the next renewal period, SAP proposes an end date of 11/30/2022, which should not be accepted. If this end date is accepted, the customer will appear as having failed to pay the next billing period. To avoid this problem, the contract end date on the Sales tab is changed to 11/30/2021 (the last day of the most recent contract renewal period for which payment has been received).

Notify Accounts Receivable, if Necessary

If the contract has an unpaid invoice, notify Accounts Receivable so the invoice can be cancelled. Do not cancel the contract before confirming the invoice has been cancelled.

Confirm Panels Were Dismantled

Do not cancel a contract until the panels have been dismantled. Occasionally a customer will pay a delinquent invoice just prior to the date for the panels to be removed. If they do, the contract should not be cancelled.



Cancel Contract

Canceling Unbilled vs Billed Contracts

An unbilled contract is one that has not had a payment for annual renewal fees posted against it, even if has been invoiced. For example, a contract created for a new Logo agreement is an unbilled contract until a customer payment for the first invoice is posted against it. Unbilled contracts are cancelled when:

- the customer wants to discontinue participation in the Logo Signing Program before they have paid the first invoice for annual renewal fees
- a customer is delinquent in paying their first invoice for annual renewal fees
- the contract is a duplicate and no payments were posted to it
- the Logo panels specified in the contract were never installed

A billed contract is one that has had a payment for annual renewal fees posted against it. Billed contracts are cancelled when:

- the customer wants to discontinue participation in the Logo Signing Program after having paid at least one invoice for annual renewal fees
- a customer who has paid at least one invoice for annual renewal fees does not pay their current invoice for annual renewal fees
- the contract is a duplicate and payments have been posted to it

Steps to Cancel an Unbilled Contract

1 Issue Work Order to Dismantle Panels, if necessary

If the Logo panels have never been installed, this step is not required.

2 Display Contract Document

Flow Use transaction VA43 to

- display the contract document flow to ensure the contract has not had any payments posted against it
- display the contract to identify and record the contract start and end dates

3 Display Customer Line Items

Use transaction FBL5N to identify the date of the first-year fee payment.

4 Calculate New Contract End Date

Using the contract start and end dates and the date the invoice for the first-year fees was paid, calculate the new contract end date. The date should equal the last day of the period covered by the first-year fees.



5 Notify Accounts Receivable, if necessary

If the contract was invoiced for the first annual renewal fees, but the invoice was not paid, notify Accounts Receivable so the invoice can be cancelled.

- include customer number, contract number, date of contract cancellation and invoice number in email to Accounts Receivable

Do not cancel the contract before confirming the invoice has been cancelled.

6 Confirm Panels Were Dismantled



Do not cancel the contract until the Logo panels are dismantled.

7 Cancel Contract

Use the *VA42 – Cancel Unbilled Contract* procedure to cancel the contract.

VA42 – Cancel Unbilled Contract

Use this procedure to cancel all panels on an unbilled Logo contract.

1. Enter **VA42** in the **Command** field on the **SAP Easy Access** screen.
2. Click  or press Enter. The *Change Contract: Initial Screen* displays.
3. Enter the *contract* in the **Contract** field.
4. Click  or press **Enter**.



If the **Information** dialog box displays the following message:
Consider the subsequent documents, documents related to the contract (invoices, credit memos, accounting document, etc.) exist. Typically, if the message does not display, the contract has not been billed.

5. Click  or press **Enter**. The **Change Logo Contract [number]: Overview** screen displays.
6. Review data in the header to ensure the correct contract displays.
7. Follow the menu path **Goto** → **Head.** → **Contract Data**. The **Create Logo Contract: Header Data** screen displays with the **Contract data** tab selected.



Never change the **Contract start date** or **Contract end date** on the **Contract data** tab.

8. Enter the *date the panels were removed* in the **Dismantling date** field.



If the panels were installed, this is the date on the dismantling work order. If the panels were never installed, or if the contract is a duplicate, enter the date the customer notified NCDOT or the current date.

9. Click  in the **Reason for cancel.** field, then select the reason for cancelling the contract.



Contract not renewed – contract cancelled by customer request

Delinquent payment – contract cancelled due to lack of payment



Other – select when panels were never installed or when contract is a duplicate

10. Enter one of the following dates in the **Receipt of canc.** field:
- date NCDOT received notice of cancellation from the customer (when contract is cancelled by customer request)
 - date panels were removed (when contract is cancelled due to lack of payment)
 - date the customer notified NCDOT or the current date (when panels were never installed or when contract is a duplicate)
11. Click  or press **Enter**. The **Propose cancellation date** dialog box displays.
12. Review the proposed cancellation date to determine if it is correct.







The proposed cancellation date should equal the last day of the period covered by the first-year fees.

If the proposed date is correct, perform the following:

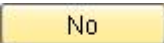
1. Click .
2. Click  to clear the *Alter the action if necessary* message.
3. Click  to return to the **Change Logo Contract [number]: Overview** screen. The proposed cancellation date displays in the **Contract end** field on the **Sales** tab.

If the proposed date is not correct, perform the following:

1. Click .
2. Click  to return to the **Change Logo Contract [number]: Overview** screen.
3. Enter the last day of the last contract period for which payment was received in the **Contract end** field on the **Sales** tab.
4. Click  or press **Enter**.

13. Click  to the left of the first line item.
14. Follow the menu path **Goto** → **Item** → **Sales A**.
15. Click  in the **Reason for rejection** field, then select **DOT – Sales Contract Rejection**.
16. Select the **Billing plan** tab.



Click  or press **Enter** to clear any dialog boxes that display.



Do not change information on the **Billing plan** tab.

17. Review the billing plan data for the selected line item.



The **End date** should be the same as the new date in the **Contract end** field on the **Sales** tab.



All billing line items should be grayed out.



18. Click  as necessary to review billing plan data for the next line item.



Review the values in the **Sales Document Item** and **Material** fields in the header to identify the line item.

19. Repeat steps 17 – 18 as necessary until the following message displays: *There are no more items to be displayed*
20. Click . The **Change Logo Contract [number]: Overview** screen displays.
21. Click . The following message displays:
Logo Contract [number] has been saved
22. Click  to exit this transaction.

Steps to Cancel a Billed Contract

1 Issue Work Order to Dismantle Panels

This step is not required when cancelling a duplicate contract.

2 Display Contract Document

Flow Use transaction VA43 to

- display the contract document flow to ensure the contract has had payments posted against it
- display the contract to identify and record the contract start and end dates

3 Display Customer Line Items

Use transaction FBL5N to identify the date of the most recent annual renewal fee payment. If the contract has invoices that were cleared by any means other than customer payment, contact Accounts Receivable.

4 Calculate New Contract End Date

Using the contract start and end dates and the date of the most recent annual renewal fee payment, calculate the new contract end date. The date should equal the last day of the most recent contract renewal period for which payment has been received.



5 Notify Accounts Receivable, if necessary

If the contract had an unpaid invoice, notify Accounts Receivable so the invoice can be cancelled.

- include customer number, contract number, date of contract cancellation and invoice number in email to Accounts Receivable

Do not cancel the contract before confirming the invoice has been cancelled.

6 Confirm Panels Were Dismantled



Do not cancel the contract until the Logo panels are dismantled. This step is not required when cancelling a duplicate contract.

7 Cancel Contract

Use the *VA42 – Cancel Billed Contract* procedure to cancel the contract.

VA42 – Cancel Billed Contract

Use this procedure to cancel all panels on a billed Logo contract.

1. Enter **VA42** in the **Command** field on the **SAP Easy Access** screen.
2. Click  or press **Enter**. The **Change Contract: Initial Screen** displays.
3. Enter the *contract* in the **Contract** field.
4. Click  or press **Enter**.



If the **Information** dialog box displays the following message:
Consider the subsequent documents, documents related to the contract (invoices, credit memos, accounting document, etc.) exist. Typically, if the message does not display, the contract has not been billed.

5. Click  or press **Enter**. The **Change Logo Contract [number]: Overview** screen displays.
6. Review data in the header to ensure the correct contract displays.
7. Follow the menu path **Goto** → **Head.** → **Contract Data**. The **Create Logo Contract: Header Data** screen displays with the **Contract data** tab selected.



Never change the **Contract start date** or **Contract end date** on the **Contract data** tab.

8. Enter the *date the panels were removed* in the **Dismantling date** field.



Typically, this is the date on the dismantling work order. If the contract is a duplicate, enter the date the customer notified NCDOT or the current date.

9. Click  in the **Reason for cancel.** field, then select the reason for cancelling the contract.





Contract not renewed – contract cancelled by customer request
Delinquent payment – contract cancelled due to lack of payment
Other – select when contract is a duplicate

10. Enter one of the following dates in the **Receipt of canc.** field:
- date NCDOT received notice of cancellation from the customer (if contract cancelled by customer request)
 - date panels were removed (if contract cancelled due to lack of payment)
 - date the customer notified NCDOT or the current date (when contract is a duplicate)
11. Click  or press **Enter**. The **Propose cancellation date** dialog box displays.
12. Review the proposed cancellation date to determine if it is correct.



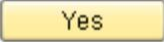

The proposed cancellation date should equal the last day of the most recent contract renewal period for which payment has been received.

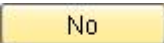

If the proposed date is correct, perform the following:

1. Click .
2. Click  to clear the *Alter the action if necessary* message.
3. Click  to return to the **Change Logo Contract [number]: Overview** screen. The proposed cancellation date displays in the **Contract end** field on the **Sales** tab.

If the proposed date is not correct, perform the following:

1. Click .
2. Click  to return to the **Change Logo Contract [number]: Overview** screen.
3. Enter the last day of the last contract period for which payment was received in the **Contract end** field on the **Sales** tab.
4. Click  or press **Enter**.

Review Billing Plan Data

13. Click  to the left of the first line item.
14. Click . The **Change Logo Contract [number]: Item Data** screen displays.



Do not change information on the **Billing plan** tab.

15. Review the billing plan data for the selected line item.



The **End date** should be the same as the new date in the **Contract end** field on the **Sales** tab.



No future dates should display in the **Billing date** column and all previous billing dates should have a **BillSt** of C.

16. Click  as necessary to review billing plan data for the next line item.



Review the values in the **Sales Document Item** and **Material** fields in the header to identify the line item.



17. Repeat steps 16 – 17 as necessary until the following message displays: *There are no more items to be displayed*
18. Click . The **Change Logo Contract [number]: Overview** screen displays.
19. Click . The following message displays:
Logo Contract [number] has been saved
20. Click  to exit this transaction.

Reinstating Cancelled Contracts

If a contract has been cancelled due to unpaid invoices and the customer wants to participate in the Logo program again, the Coordinator contacts Accounts Receivable to determine the amount owed on the cancelled contract. The customer must pay all fees owed and wait at least six months from the dismantle date on the cancelled contract before a new agreement can be created. If the contract is cancelled due to lack of payment again, the customer will be required to pay all fees owed and wait two years before a new agreement can be created.



Add Panel to Contract

Customers may request that one or more panels be added to a Logo contract. A prorated sales order must be created for the months between the panel installation and the contract renewal month. After the customer pays the invoice and the additional panels are installed, the Logo Coordinator adds the new panels to the contract.

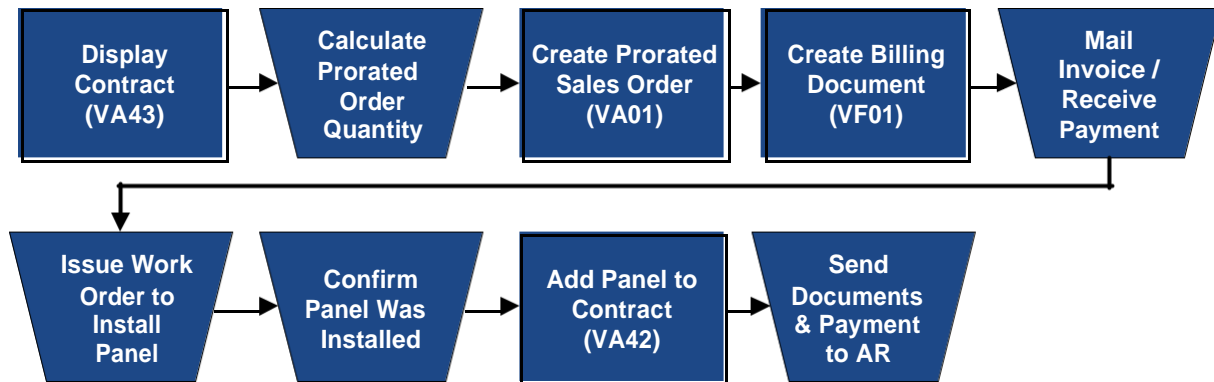

Display Contract

Display the contract to identify and record data that will be required when creating the prorated sales order, including customer master record number, agreement number, contract start month (contract renewal month), and division. Refer to the *VA43 – Display Contract Document Flow & Contract* procedure for instructions.

Calculate Prorated Order Quantity

When panels are added to an existing contract, the order quantity for the additional panels on the sales order is prorated, or adjusted to the number of months between the calculated current month and the contract renewal month.

The calculated current month is determined by the current date. If the current date is on or before the 15th of the month, use the current month. If the current date is after the 15th of the month, use the next month as the calculated current month.

Count the number of months between the calculated current month and the contract start month (contract renewal month). Multiple the number of months by the number of additional panels to determine the order quantity for the prorated sales order. Repeat the calculation as necessary for additional Logo materials.

For example, two ramp panels and two trailblazer panels are to be added to a contract with a renewal month of November. The current date is March 20, which means the calculated current month will be April. The number of months between April and November is 7. Multiplying the number of months (7) by the number of panels to be added (4) gives a prorated order quantity of 28.



VA01 – Create Prorated Sales Order

When adding a Logo panel to an existing contract, a prorated sales order is created to provide a way to bill the customer for the months between the installation of the additional panel and the contract's next annual billing. When the new panels are added to the contract later in the process, they will be included in the annual renewal fees.



It is recommended that users reconfigure the columns of the line item table, making it easier to enter required data. (Refer to the *Reconfigure Table Columns/Configuration Button XPress Card* for instructions.)

1. Enter **VA01** in the **Command** field on the **SAP Easy Access** screen.
2. Click  or press **Enter**. The **Create Sales Order: Initial Screen** displays.



If your parameters have been set to default for Logo (refer to the *Set Parameters* procedure in the **Tips & Tricks**), perform the following:

1. Review the defaulted values to ensure they are correct.
2. Enter **ZOR** in the **Order Type** field.
3. Proceed to step 7.

3. Enter **ZOR** in the **Order Type** field.
4. Enter **1500** in the **Sales Organization** field.
5. Enter **75** in the **Distribution Channel** field.
6. Enter the *division number* in the **Division** field.
7. Click  or press **Enter**. The **Create DOT Standard Order: Overview** screen displays.
8. Enter the *customer master record number* in the **Sold-To Party** field.
9. Enter the *agreement number* in the **PO Number** field.
10. Enter the *current date* in the **PO date** field.
11. Click  or press **Enter** to validate your entries.
12. Enter a *Logo monthly material number* in the **Material** column.



Use ARM910, ARM911 or ARM912 for when adding panels to existing agreements.



Do not enter or overwrite text in the **Description** column.

13. Enter the *prorated order quantity* in the **Order Quantity** column.
14. Enter the *Logo WBS element to receive payment* in the **WBS Element** column.



If the line item table has not been reconfigured, you must scroll to the right to find the **WBS element** column.

If you do not know the WBS element, click in the **WBS Element** field to search for it.

15. Click or press **Enter** to validate your entries. The **Description** and **Amount** columns are populated with the relevant data.
16. Repeat steps 12 – 15 as necessary for additional line items.
17. Click .
18. Follow the menu path **Goto** → **Item** → **Texts**. The **Create DOT Standard Order: Item Data** screen displays.
19. Review the data in the header to determine the material type.
20. Enter *[number of additional panels] [PANEL TYPE] PANEL @ [number of months] MONTHS = QUANTITY OF [order quantity]* in the **Material sales text** box.



2 MAINLINE PANELS @ 7 MONTHS = QUANTITY OF 14

Information entered prints below the line item on the invoice.

21. Click . Values for the next line item display in the header.
22. Repeat steps 19 – 21 as necessary until the following message displays: *There are no more items to be displayed*
23. Click . The following message displays: *DOT Standard Order [number] has been saved*
24. Record the sales order number for future reference.
25. Click to exit this transaction.

VF01 – Create Billing Document

Use this procedure to create a billing document referencing the prorated Logo sales order. Be sure you have set up your default printer before creating the billing document.

1. Enter *VF01* in the **Command** field on the **SAP Easy Access** screen.
2. Click or press **Enter**. The **Create Billing Document** screen displays.
3. Enter the *sales order* in the **Document** column.
4. Click or press **Enter**. The **DOT Standard Invoice (ZFS) Create: Overview of Billing Items** screen displays.



5. Review the line items.



If a line item requires changes, exit this transaction. Use transaction VA02 to correct the line item in the sales order, then begin this procedure again.

6. Click . The **Create Billing Document** screen displays the following message: *Document [number] has been saved.*



Two copies of the invoice automatically print to your default SAP printer. The invoice is attached to the billing document in the system.

7. Record the billing document number for future reference.
8. Click to exit this transaction.

Mail Invoice / Receive Payment

When a billing document is saved, two copies of the invoice print. If payment for the additional panel has already been received, the Coordinator stamps RECEIVED on both of the invoices, and records the date payment was received on each copy. One copy of the invoice is sent to the customer as a receipt and the remaining copy is placed with the customer payment.

If the customer has not already submitted payment, the Coordinator places a label indicating the Division office as the remit to address on one invoice, and forwards it to the customer to request payment. When payment is received, the Coordinator stamps RECEIVED on the remaining invoice, records the date payment was received, and places the invoice with the customer payment.

Issue Work Order to Install Panel

Do not issue a work order to install Logo panels until customer payment has been received.

Confirm Panel Was Installed



Do not change the contract until the additional panel has been installed.

VA42 – Add Panel to Contract

It is recommended that users reconfigure the columns of the line item table, making it easier to enter required data. (Refer to the *Reconfigure Table Columns/Configuration Button XPress Card* for instructions.)

Use CAPITAL LETTERS when entering text.



1. Enter **VA42** in the **Command** field on the **SAP Easy Access** screen.
2. Click  or press **Enter**. The **Change Contract: Initial Screen** displays.
3. Enter the *contract* in the **Contract** field.
4. Click  or press **Enter**. The **Information** dialog box displays the following message:

Consider the subsequent documents



The message indicates that documents related to the contract (invoices, credit memos, accounting document, etc.) exist.

5. Click  or press **Enter**. The **Change Logo Contract [number]: Overview** screen displays.
6. Review data in the header to ensure the correct contract displays.
7. Review the line items to determine if the Logo material exists on the contract or must be added.



If the material exists on the contract, increase the value in the **Target quantity** column to represent the additional panels. Do not create a new line item for an existing Logo material.

If the material does not exist on the contract, perform the following:

1. Enter or select the *Logo material number* in the **Material** column.
2. Enter the *total number of panels (existing plus additional)* in the **Target Quantity** column.
3. Enter the *Logo WBS element to receive payment* in the **WBS Element** column.

Note: If the line item table has not been reconfigured, you must scroll to the right to find the **WBS element** column.



Do not allow the contract to contain more than three line items. If four or more line items are created on a Logo contract, only the first three are included on the annual billing document, and the printed invoice does not reflect the total amount due. When the customer pays the incorrect invoice, the amount paid does not match the amount owed.

8. Click  or press **Enter**.

Review Billing Plan Data

9. Click  to the left of the first line item changed or added.



10. Click . The **Change Logo Contract [number]: Item Data** screen displays.



If the following message displays: *There are unbilled dates in the past*, click  to clear the dialog box.

11. Review the billing plan data for the selected line item.



If the target quantity for an existing material was increased, perform the following:

1. Identify the line item that represents the next billing cycle.
2. Ensure the value in the **Bill.value** column reflects the increase in target quantity.

If the material was added to the contract, perform the following:

1. Identify the line item that represents the next billing cycle.
2. Copy the value in the **Start date** field, then paste it into the **Dates from** field.
3. Change the year pasted into the **Dates from** field so that it matches the year of the next billing cycle.
For example: If the contract **Start date** is 11/1/2012, and the next billing cycle is 10/1/2013, enter 11/1/2013 in the **Dates from** field.
4. Click  or press **Enter**. Billing dates for the past are deleted.



Do not change any data that displays in the **Dates** section.

12. Click  as necessary to display billing plan data for the next line item that was changed or added to the contract.



Review the values in the **Sales Document Item** and **Material** fields in the header to identify the line item.

If the following message displays: *There are unbilled dates in the past*, click  to clear the dialog box.

13. Repeat steps 11 – 12 as necessary until the following message displays: *There are no more items to be displayed*

14. Click . The **Change Logo Contract [number]: Overview** screen displays.

Enter Line Item Text



15. Click  to the left of the first Logo material line item changed or added.
16. Follow the menu path **Goto** → **Item** → **Texts**.
17. Enter explanatory text in the **Material sales text** field.



If the target quantity for an existing material was increased, enter the following text:

ON [current date], [additional quantity] ADDITIONAL PANEL(S) WAS(WERE) ADDED TO MATERIAL [Logo material]. PANELS WERE ADDED IN ACCORDANCE WITH THE LOGO ADDITIONAL PANEL PROCESS. DOCUMENTATION REGARDING THIS ADDITION MAY BE FOUND ON FILE WITH THE DIVISION LOGO COORDINATOR. [SAP USER ID]



If the material was added to the contract, enter the following text:

ON [current date], MATERIAL [Logo material] WAS ADDED TO THIS CONTRACT IN ACCORDANCE WITH THE LOGO ADDITIONAL PANEL PROCESS. DOCUMENTATION REGARDING THIS ADDITION MAY BE FOUND ON FILE WITH THE DIVISION LOGO COORDINATOR. [SAP USER ID]

18. Click  as necessary to enter explanatory text for the next line item that was changed or added to the contract.



Review the values in the **Sales Document Item** and **Material** fields in the header to identify the line item.

19. Repeat steps 17 – 18 as necessary until the following message displays: *There are no more items to be displayed*
20. Click . The **Change Logo Contract [number]: Overview** screen displays.
21. Click . The **Change Contract: Initial Screen** displays the following message: *Logo Contract [number] has been saved*
22. Click  to exit this transaction.

Send Documents & Payment to Accounts Receivable

After the contract has been updated, the Coordinator records the contract number on the invoice, and sends the invoice with the customer payment to Accounts Receivable.



Cancel Panel on Contract

Individual Logo panels may be removed from a service sign, leaving one or more panels for the same business on other service signs. The dismantled panels must be cancelled on the contract. Do not cancel the panel on the contract until it has been dismantled.

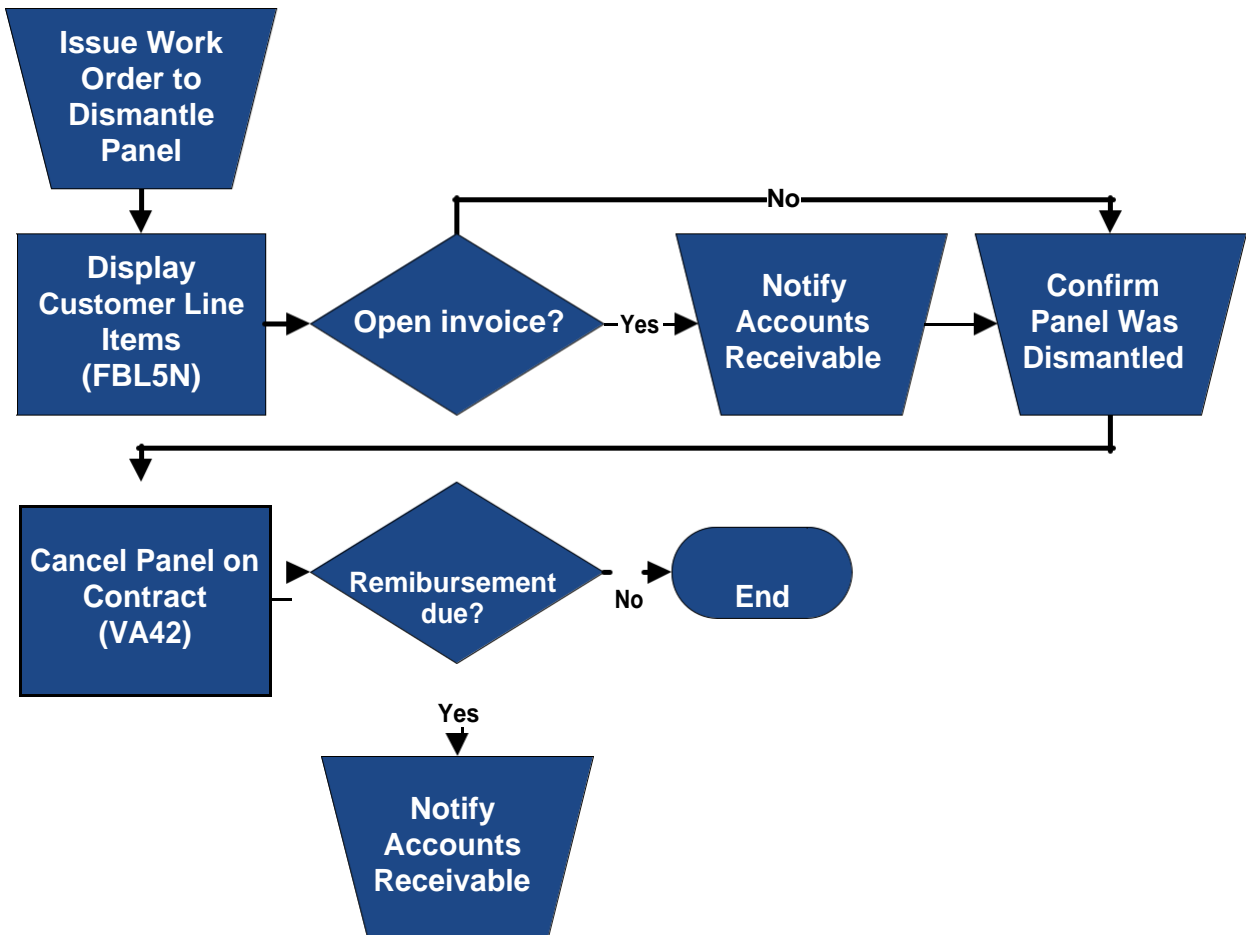

Issue Work Order to Dismantle Panel

When a Logo customer notifies NCDOT that they do want to remove some, but not all, of the Logo panels from a contract, issue a work order to dismantle the Logo panels.

Display Customer Line Items

Execute this report to ensure all invoices have cleared properly and to determine the date of the last customer payment. Refer to the *FBL5N – Display Customer Line Items* procedure for instructions. (If the contract has unpaid invoices, contact Accounts Receivable.)



Notify Accounts Receivable

If the contract has an unpaid invoice, notify Accounts Receivable so the invoice can be cancelled. Do not cancel the contract before confirming the invoice has been cancelled.



Confirm Panel was Dismantled

Do not change the contract until the additional panel has been removed.

VA42 – Cancel Panel on Contract

This procedure should not be used to cancel an entire Logo contract. Refer to the *Cancel Logo Contract* procedure for instruction, if necessary.

Use CAPITAL LETTERS when entering text.

1. Enter **VA42** in the **Command** field on the **SAP Easy Access** screen.
2. Click  or press **Enter**. The **Change Contract: Initial Screen** displays.
3. Enter the *contract number* in the **Contract** field.
4. Click  or press **Enter**. The **Information** dialog box displays the following message:
Consider the subsequent documents



The message indicates that documents related to the contract (invoices, credit memos, accounting document, etc.) exist.

5. Click  or press **Enter**. The **Change Logo Contract [number]: Overview** screen displays.
6. Review data in the header to ensure the correct contract displays.
7. Review the line item for the appropriate Logo material to determine if a quantity will remain on the contract.





If a quantity will remain on the contract, perform the following:

1. Change the value in the **Target quantity** column to represent the reduced number of panels.
2. Click to the left of the line item.
3. Click  **Bill. plan**.
4. Identify the line item that represents the next billing cycle.
5. Ensure the value in the **Bill.value** column reflects the decrease in target quantity.

Note: if the target quantity does not decrease, do not make any changes on the **Billing plan** tab; contact Accounts Receivable.

If the total quantity will be deleted from the contract, perform the following:

1. Click to the left of the line item.
2. Click  **Bill. plan**.
3. Change the value in the **Dates until** field to the last day of the current billing period.
4. Click  or press **Enter**. Billing dates for the future are deleted.

8. Click . The **Change Logo Contract [number]: Overview** screen displays.
9. Repeat steps 7 – 8 as necessary to delete additional panels.



Do not use this procedure to cancel an all materials on a Logo contract. Use the *Cancel Logo Contract* procedure.

Enter Line Item Text

10. Click to the left of the first changed line item.
11. Follow the menu path **Goto** → **Item** → **Texts**.
12. Enter explanatory text in the **Material sales text** field.



If a quantity remains on the contract, enter the following text:
 ON [current date], A QUANTITY OF [quantity] PANEL(S) WAS(WERE)
 CANCELLED FROM MATERIAL [Logo material]. PANELS WERE
 CANCELLED IN ACCORDANCE WITH THE LOGO PANEL
 CANCELLATION PROCESS. DOCUMENTATION REGARDING THIS
 CANCELLATION MAY BE FOUND ON FILE WITH THE DIVISION
 LOGO COORDINATOR. [YOUR SAP USER ID]



If the total quantity was deleted from the contract, enter the following
 text:

ON [current date], MATERIAL [Logo material] WAS CANCELLED
 FROM THIS CONTRACT IN ACCORDANCE WITH THE LOGO PANEL
 CANCELLATION PROCESS. DOCUMENTATION REGARDING THIS
 CANCELLATION MAY BE FOUND ON FILE WITH THE DIVISION
 LOGO COORDINATOR. [YOUR SAP USER ID]

13. Click  as necessary to enter explanatory text for the next line item that was changed.



Review the values in the **Sales Document Item** and **Material** fields in the header to identify the line item.

14. Repeat steps 12 – 13 as necessary until the following message displays: *There are no more items to be displayed*
15. Click . The **Change Logo Contract [number]: Overview** screen displays.
16. Click . The **Change Contract: Initial Screen** displays the following message: *Logo Contract [number] has been saved*
17. Click  to exit this transaction.

Notify Accounts Receivable

Logo customers are not provided monetary reimbursement for panels cancelled at their request. However, if NCDOT required that panels be removed due to interchange reconfiguration, construction, etc., the customer may receive monetary compensation. In this instance, contact Accounts Receivable to request that a credit memo be issued to the Logo customer once the contract has been changed.



Change Ownership of Contract

When a participating business is sold and the new owner wants to continue participation in the Logo Signing Program, written notification of the change of ownership is required. The original contract is cancelled and a new contract is created in reference to the cancelled contract. Do not simply change the customer master record referenced on the contract. If the new owner does not want to continue participation, use the *Cancel Billed Contract* process to cancel the contract.

The Logo Coordinator performs an on-site review of the business and performs another qualification survey to ensure the business still qualifies for the Logo program. The Coordinator meets with the new owner to discuss the program, answer any questions and have the owner sign a new Logo agreement.

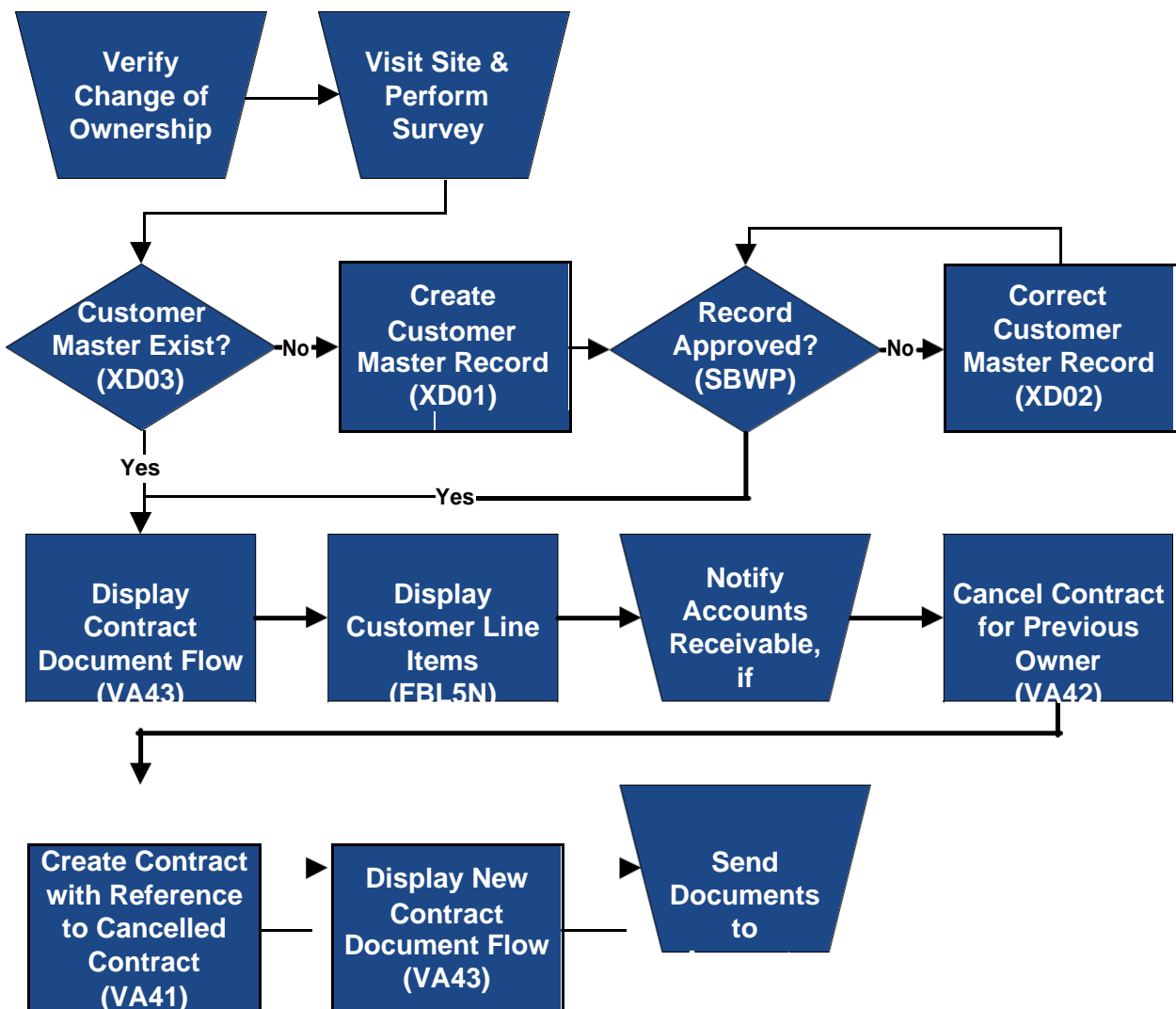



Verify Change of Ownership

When a Logo customer notifies NCDOT that they no longer own the business, the change must be verified. Written notification (email, fax, or letter) from the previous owner is required, specifying that the business has been sold and the name and address of the new owner. The new owner must confirm that they now own the business, the date of purchase, and the route and exit numbers.

Display Contract Document Flow

Display the document flow from the contract to review the customer name and master record number in the header to ensure the change of ownership has not already been performed. Refer to the *VA43 – Display Contract Document Flow* procedure for instructions.

Display Customer Line Items



Execute this report for the current owner to ensure all invoices have cleared properly and to determine the date of the last customer payment. Refer to the *FBL5N – Display Customer Line Items* procedure for instructions. (If the customer has outstanding invoices, notify Accounts Receivable to request they be cancelled.)

Notify Accounts Receivable, if Necessary

If the contract has an unpaid invoice, notify Accounts Receivable so the invoice can be cancelled. Do not cancel the contract before confirming the invoice has been cancelled.

VA42 – Cancel Contract for Previous Owner



Use this procedure to cancel an existing contract as part of the change of ownership process. You must know the contract number and date of most recent invoice paid by the customer before cancelling the contract.

1. Enter **VA42** in the **Command** field on the **SAP Easy Access** screen.
2. Click  or press **Enter**. The **Change Contract: Initial Screen** displays.
3. Enter the *contract number* in the **Contract** field.
4. Click  or press **Enter**. The **Information** dialog box displays the following message:
Consider the subsequent documents



The message indicates that documents related to the contract (invoices, credit memos, accounting document, etc.) exist.



5. Click  or press **Enter**. The **Change Logo Contract [number]: Overview** screen displays.
6. Review data in the header to ensure the correct contract displays.
7. Click  in the header. The **Create Logo Contract: Header Data** screen displays.
8. Select the **Contract data** tab.





Never change the **Contract start date** or **Contract end date** on the **Contract data** tab.

9. Enter the *current date* in the **Dismantling date** field.





This field must be populated in order for SAP to change the contract status from active to inactive.

10. Click  in the **Reason for cancel.** field, then select **Change of Ownership**
11. Enter the *date NCDOT received notice of change of ownership from the customer* in the **Receipt of canc.** field.
12. Click  or press **Enter**. The **Propose cancellation date** dialog box displays.
13. Review the proposed cancellation date to determine if it is correct.





The proposed cancellation date should equal the last day of the most recent contract renewal period for which payment has been received.

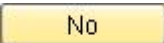

If the proposed date is correct, perform the following:

1. Click .
2. Click  to clear the *Alter the action if necessary* message.
3. Click  to return to the **Change Logo Contract [number]: Overview** screen. The proposed cancellation date displays in the **Contract end** field on the **Sales** tab.

If the proposed date is not correct, perform the following:

1. Click .
2. Click  to return to the **Change Logo Contract [number]: Overview** screen.
3. Enter the last day of the last contract period for which payment was received in the **Contract end** field on the **Sales** tab.
4. Click  or press **Enter**.

Review Billing Plan Data

14. Click  to the left of the first line item.
15. Click . The **Change Logo Contract [number]: Item Data** screen displays.



Do not change information on the **Billing plan** tab.



If the following message displays, *There are unbilled dates in the past*, click , then contact Accounts Receivable and request they review the contract.

16. Review the billing plan data for the selected line item.



The **End date** should be the same as the new date in the **Contract end** field on the **Sales** tab.





No future dates should display in the **Billing date** column.

All previous billing dates should have a **BillSt** of C. (If any line items display something other than C, contact Accounts Receivable and request they review the contract.)

17. Click  as necessary to review billing plan data for the next line item.





Review the values in the **Sales Document Item** and **Material** fields in the header to identify the line item.

18. Repeat steps 16 – 17 as necessary until the following message displays: *There are no more items to be displayed.*
19. Click . The **Change Logo Contract [number]: Overview** screen displays.
20. Click  in the header. The **Create Logo Contract: Header Data** screen displays.
21. Select the **Partners** tab.
22. Click  to the left of the **Ship-to party** line item.
23. Click . The **Address From Master Data for Ship-to party** dialog box displays.
24. Record the details for use when creating the new contract.



The dialog box should contain the name and physical location of the business. Instead of manually recording the information, you can press **PrtScn**, open a new MS Word document, and paste the screen capture into the Word document to save time.

25. Click  or press **Enter** to close the dialog box.
26. Click . The following message displays:
Logo Contract [number] has been saved
27. Click  to exit this transaction.

Search for/Create Customer Master Record

Search SAP to determine if the new business owner has a Logo customer master record. Refer to the *XD03 – Display Customer Master Record* procedure in the *New Logo Agreement Processing* course materials for instructions, if necessary.



If the business owner has a Logo customer master record, but the address does not match the information on the signed agreement, contact the business owner to verify their correct address. Create a new customer master record for Accounts Receivable to approve if necessary (refer to the *XD01 – Create Customer Master Record* and *SBWP – Process Workflow Messages & Work Items* procedures in the *New Logo Agreement Processing* course materials for instructions).

VA41 – Create Contract with Reference to Cancelled Contract



Use this procedure to create a new contract with reference to the cancelled contract.

1. Enter **VA41** in the **Command** field on the **SAP Easy Access** screen.
2. Click  or press **Enter**. The **Create Contract: Initial Screen** displays.



If your parameters have been set to default for Logo (refer to the *Set Parameters* procedure in the **Tips & Tricks**), perform the following:

1. Review the defaulted values to ensure they are correct.
2. Enter **ZLG** in the **Contract Type** field.
3. Proceed to step 7.

3. Enter **ZLG** in the **Contract Type** field.
4. Enter **1500** in the **Sales Organization** field.
5. Enter **75** in the **Distribution Channel** field.
6. Enter the *division in which the panel was installed* in the **Division** field.
7. Click . The **Create with Reference/Release from Contract** dialog box displays.
8. Enter the *cancelled contract number* in the **Contract** field.
9. Click . The **Logo Contract [number]: Selection List for Reference Document** screen displays a list of materials and quantities from the cancelled contract.
10. Clear the checkbox to the left of any cancelled line items recorded when cancelling the contract.



Any cancelled line items not deselected will be copied into the new contract and thus be eligible for billing during the next billing cycle.





11. Click . The following message displays:
End date billing plan: Base line date for rule 09 not set



12. Click  or press **Enter** until the **Create Logo Contract: Overview** screen displays populated with information from the cancelled contract.



The message will display once for each contract line item.

13. Enter the *customer master record for the new owner* in the **Sold-To Party** field.
14. Click  or press **Enter** to validate your entries.
15. Click  or press **Enter** until the **Adjust terms** dialog box displays the following message:
Shipping conditions were changed. Redetermine routes and shipping for all items?
16. Click . The **Adjust items** dialog box displays the following message:
The sold-to party has been changed. Redetermine plant/shipping point?
17. Click . The following message displays: *New pricing carried out*
18. Click  or press **Enter**. The descriptions for the **Sold-To Party** and **Ship-To Party** update to reflect the new owner.
19. Ensure the date in the **Contract start** field is correct.



The date should be the day after the contract end date of the cancelled contract. If the date is incorrect, exit this transaction and review the cancelled contract to ensure it was cancelled with the correct date.

20. Enter the last day of the month prior to the contract start date for year 2030 in the **Contract end** field.



If the contract start date is 6/01/2013, enter 5/31/2030.



21. Click  or press **Enter** to validate your entries and update the **Net value** field.
22. Ensure the **Net value** in the header is correct.



The **Net value** in the header is the sum of the net values for the line items. The **Net value** of a line item is the price of the material (\$300) multiplied by the number of panels multiplied by the number of years on the contract..

23. Click . The **Create Logo Contract: Header Data** screen displays.



24. Select the **Contract data** tab.
25. Ensure the *date the panel was installed* displays in the **Installation date** field.
26. Enter the *date the change of ownership document was signed by the Division Engineer or designee* in the **Contract signed** field.
27. Select the **Partners** tab.
28. Click  to the left of the **Ship-to party** line item.
29. Click . The **Address From Master Data for Ship-to party** dialog box displays.
30. Enter or change values in the following fields as necessary to reflect the physical location and other details of the business.



Refer to the screen print of information from when the previous contract was cancelled, if available.

- **Name** – BUSINESS NAME
- **Street/House number** (first field) – BUSINESS PHYSICAL ADDRESS



NCDOT does not use the second field.

- **Postal Code/City** – enter the business zip code in the first field, and the CITY in the second field
- **Region** – NC
- **Jurisdct.code** – TAX JURISDICTION CODE FOR THE BUSINESS PHYSICAL ADDRESS



If the **Jurisdct.code** field does not display, click  in the **Street address** section.

- **Telephone** – telephone number for the business



Use dashes when entering telephone numbers. For example, 919-555-1212.

- **E-Mail** – email address for the business



Do not use the **E-Mail** field to enter additional text.



The @ symbol is required.



- **Comments** – any additional contact information for the business

31. Click  or press **Enter** to close the dialog box.



If the following message displays: *Taxes have been re-determined.*

Click  or press **Enter**.

If the following message displays: *Ship-to party has been changed.*

Redetermine plant/shipping point? Click .

32. Click . The **Create Logo Contract: Overview** screen displays.

33. Click . The following message displays:
Logo Contract [number] has been saved

34. Record the contract number for future reference.

35. Click  to exit this transaction.

Display New Contract Document Flow

Display the document flow from the new contract to ensure the new contract references the cancelled contract. Refer to the *VA43 – Display Contract Document Flow* procedure for instructions.

Send Documents to Accounts Receivable

After the new contract has been created, the Coordinator sends all documentation pertaining to the change of ownership along with the old and new contract numbers and old and new customer master record numbers to Accounts Receivable. AR may need to bill the new customer for back fees.



Merge Contracts

When a Logo customer has two active contracts with valid panels for the same route, exit, and business, merging the contracts prevents the customer from receiving multiple bills. The first contract created is the primary contract; the last contract created is the secondary contract. Panels from the secondary contract are added to the primary contract, and the secondary contract is cancelled.

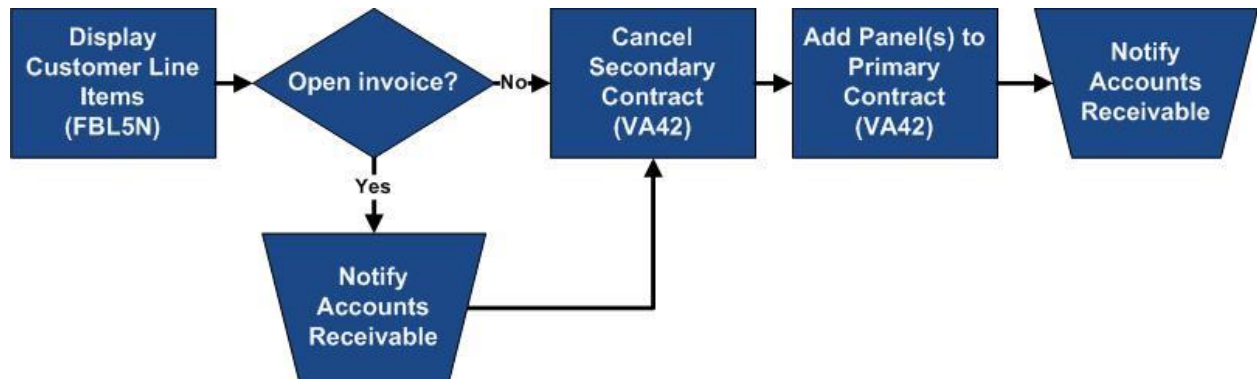



Display Customer Line Items

Execute this report to ensure all invoices for the secondary contract have cleared properly and to determine the date of the last customer payment. Refer to the *FBL5N – Display Customer Line Items* procedure for instructions. (If the customer has unpaid invoices, notify Accounts Receivable to request they be cancelled.)

VA42 – Cancel Secondary Contract

Use this procedure to cancel the secondary contract.

1. Enter **VA42** in the **Command** field on the **SAP Easy Access** screen.
2. Click  or press **Enter**. The **Change Contract: Initial Screen** displays.
3. Enter the *contract* in the **Contract** field.
4. Click  or press **Enter**. The **Information** dialog box displays the following message:
Consider the subsequent documents



The message indicates that documents related to the contract (invoices, credit memos, accounting document, etc.) exist.

5. Click  or press **Enter**. The **Change Logo Contract [number]: Overview** screen displays.



6. Review data in the header to ensure the correct contract displays.
7. Record the values in the **Material** and **Target quantity** columns for future reference.
8. Click  in the header. The **Create Logo Contract: Header Data** screen displays.
9. Select the **Contract data** tab.





Never change the **Contract start date** or **Contract end date** on the **Contract data tab**.

10. Enter the *current date* in the **Dismantling date** field.





This field must be populated in order for SAP to change the contract status from active to inactive.

11. Click  in the **Reason for cancel.** field, then select **Consolidated Contract**.
12. Enter the *current date* in the **Receipt of canc.** field.
13. Click  or press **Enter**. The **Propose cancellation date** dialog box displays.
14. Review the proposed cancellation date to determine if it is correct.





 The proposed cancellation date should equal the last day of the most recent contract renewal period for which payment has been received.

If the proposed date is correct, perform the following:

1. Click .
2. Click  to clear the *Alter the action if necessary* message.
3. Click  to return to the **Change Logo Contract [number]: Overview** screen. The proposed cancellation date displays in the **Contract end** field on the **Sales** tab.

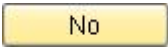

If the proposed date is not correct, perform the following:

1. Click .
2. Click  to return to the **Change Logo Contract [number]: Overview** screen.
3. Enter the last day of the last contract period for which payment was received in the **Contract end** field on the **Sales** tab.
4. Click  or press **Enter**.

Review Billing Plan Data

15. Click .
16. Click . The **Change Logo Contract [number]: Item Data** screen displays.

 Do not change information on the **Billing plan** tab.

 If the following message displays, *There are unbilled dates in the past*, click , then contact Accounts Receivable and request they review the contract.

17. Review the billing plan data for the first line item.



 The **End date** should be the same as the new date in the **Contract end** field on the **Sales** tab.

No future dates should display in the **Billing date** column.

18. Click  as necessary to review billing plan data for the next line item.





Review the values in the **Sales Document Item** and **Material** fields in the header to identify the line item.

19. Repeat steps 17 – 18 as necessary until the following message displays: *There are no more items to be displayed*
20. Click . The **Change Logo Contract [number]: Overview** screen displays.
21. Click . The following message displays:
Logo Contract [number] has been saved
22. Click  to exit this transaction.

VA42 – Add Panels to Primary Contract

Use this procedure to add the panels from the cancelled secondary contract to the primary contract.

Use CAPITAL LETTERS when entering text.

1. Enter VA42 in the **Command** field on the **SAP Easy Access** screen.
2. Click  or press **Enter**. The **Change Contract: Initial Screen** displays.
3. Enter the *contract* in the **Contract** field.
4. Click  or press **Enter**. The **Information** dialog box displays the following message:
Consider the subsequent documents



The message indicates that documents related to the contract (invoices, credit memos, accounting document, etc.) exist.

5. Click  or press **Enter**. The **Change Logo Contract [number]: Overview** screen displays.
6. Review data in the header to ensure the correct contract displays.
7. Review the line items to determine if the Logo material from the cancelled secondary contract exists on the primary contract or must be added.



If the material exists on the contract, increase the value in the **Target quantity** column to represent the additional panels. Do not create a new line item for an existing Logo material.



If the material does not exist on the contract, perform the following:

1. Enter or select the *Logo material number* in the **Material** column.
2. Enter the *number of panels* in the **Target Quantity** column.
3. Enter the *Logo WBS element to receive payment* in the **WBS Element** column.



Note: If the line item table has not been reconfigured, you must scroll to the right to find the **WBS element** column.



Do not allow the contract to contain more than three line items. If four or more line items are created on a Logo contract, only the first three are included on the annual billing document, and the printed invoice does not reflect the total amount due. When the customer pays the incorrect invoice, the amount paid does not match the amount owed.

8. Enter the *Logo WBS element to receive payment* in the **WBS Element** column, if necessary.
9. Click  or press **Enter**.

Review Billing Plan Data

10. Click  to the left of the first Logo material line item added.
11. Click . The **Change Logo Contract [number]: Item Data** screen displays.



If the following message displays: *There are unbilled dates in the past*, click  to clear the dialog box.

12. Review the billing plan data for the selected line item.



If the target quantity for an existing material was increased, perform the following:

4. Identify the line item that represents the next billing cycle.
5. Ensure the value in the **Bill.value** column reflects the increase in target quantity.



If the material was added to the contract, perform the following:

6. Identify the line item that represents the next billing cycle.
7. Copy the value in the **Start date** field, then paste it into the **Dates from** field.
8. Change the year pasted into the **Dates from** field so that it matches the year of the next billing cycle.
For example: If the contract **Start date** is 11/1/2012, and the next billing cycle is 10/1/2013, enter 11/1/2013 in the **Dates from** field.
9. Click  or press **Enter**. Billing dates for the past are deleted.





Do not change any data that displays in the **Dates** section.

13. Click  as necessary to display billing plan data for the next line item that was changed or added to the contract.



Review the values in the **Sales Document Item** and **Material** fields in the header to identify the line item.

If the following message displays: *There are unbilled dates in the past*, click  to clear the dialog box.

14. Repeat steps 12 – 13 as necessary until the following message displays: *There are no more items to be displayed*
15. Click . The **Change Logo Contract [number]: Overview** screen displays.

Enter Line Item Text

16. Click  to the left of the first Logo material line item added or changed.
17. Follow the menu path **Goto** → **Item** → **Texts**.
18. Enter explanatory text in the **Material sales text** field.



If the target quantity for an existing material was increased, enter the following text:

ON [current date], [additional quantity] ADDITIONAL PANEL(S) WAS(WERE) ADDED TO MATERIAL [Logo material]. PANELS WERE ADDED IN ACCORDANCE WITH THE LOGO ADDITIONAL PANEL PROCESS. DOCUMENTATION REGARDING THIS ADDITION MAY BE FOUND ON FILE WITH THE DIVISION LOGO COORDINATOR. [SAP USER ID]





If the material was added to the contract, enter the following text:
ON [current date], MATERIAL [Logo material] WAS ADDED TO THIS CONTRACT IN ACCORDANCE WITH THE LOGO ADDITIONAL PANEL PROCESS. DOCUMENTATION REGARDING THIS ADDITION MAY BE FOUND ON FILE WITH THE DIVISION LOGO COORDINATOR. [SAP USER ID]

19. Click  as necessary to enter explanatory text for the next line item that was changed or added to the contract.



Review the values in the **Sales Document Item** and **Material** fields in the header to identify the line item.

20. Repeat steps 18 – 19 as necessary until the following message displays: *There are no more items to be displayed*
21. Click . The **Change Logo Contract [number]: Overview** screen displays.
22. Click . The **Change Contract: Initial Screen** displays the following message: *Logo Contract [number] has been saved*
23. Click  to exit this transaction.

Notify Accounts Receivable

After the panels from the secondary contract have been added to the primary contract, notify Accounts Receivable that the secondary contract has been cancelled and the materials added to the primary contract. The customer may need to be billed for any unpaid months. Provide Accounts Receivable with contract numbers and dates.



Tips & Tricks

Set Parameters



Use this procedure to configure parameter settings to default the sales organization, Logo distribution channel and division into the selection criteria when creating customer master records, sales orders and contracts for the Logo Program.

1. Follow the menu path **System** → **User Profile** → **Own Data**. The **Maintain User Profile** screen displays.
2. Select the **Parameters** tab.
3. Scroll to the bottom of the **Parameter** section.
4. Enter the following data in the **Parameter ID** and **Parameter value** columns:

Parameter ID	Parameter value
KGD	Z006
VKO	1500
VTW	75
SPA	<i>two-digit division number</i>
RBU	1500
RVK	1500
RVT	75
RSP	<i>two-digit division number</i>
RKN	29313



Do not change any existing information on the screen.

5. Click . The new parameters are sorted in alphabetical order with the existing parameters and text for the new parameters defaults into the **Short Description** column.
6. Click . The **SAP Easy Access** screen displays the following message:
User [user ID] was saved.









FBL5N – Display Invoices Created During Billing Process

Use this procedure to display images of invoices that are automatically attached to SAP billing documents.

1. Enter *FBL5N* in the **Command** field on the **SAP Easy Access** screen.
2. Click  or press **Enter**. The **Customer Line Item Display** screen displays.
3. Enter the *customer master record* in the **Customer account** field.
4. Select the **All items** radio button.



Select the **Open items** radio button to display line items with open balances only.

5. Ensure */DUNNING* displays in the **Layout** field.
6. Click . A list of line items for the customer displays.
7. Double click an invoice number in the **Document Number** column. The **Display Document: Line Item [number]** screen displays.
8. Click the right side of , then select **Attachment list**. The **Service: Attachment list** dialog box displays.
9. Double click the appropriate line item.
10. Review the invoice.
11. Click  to close the attachment screen.
12. Click  to close the **Service: Attachment list** dialog box.
13. Click  to return to the report.
14. Click  to exit this transaction.







XD03 – Display Dunning Letters

Use this procedure to display images of dunning letters that are automatically attached to SAP customer master records.

1. Enter *XD03* in the **Command** field on the **SAP Easy Access** screen.
2. Click  or press **Enter**. The **Customer Display: Initial Screen** dialog box displays.
3. Enter the *customer master record number* in the **Customer** field.



If you do not know the master record number,  to search for it.

4. Click  or press **Enter**. The **Display Customer: General Data** screen displays.
5. Click .
6. Click the right side of , then select **Attachment list**.
7. Double click the appropriate line item.
8. Review the dunning letter.
9. Click  to close the attachment screen.
10. Click  to close the **Service: Attachment list** dialog box.
11. Click  to exit this transaction.

ZCON – Display SD Contract Report with Customer Name

Use this procedure to display a list of all Logo contracts by division, by customer, by business name keyword, or by contract start date.

1. Enter **ZCON** in the **Command** field on the **SAP Easy Access** screen.
2. Click  or press **Enter**. The **SD Contract Report with Customer Name (ZCON)** screen displays.
3. Select the **Logo** tab, if necessary.
4. Enter a *two-digit code for the division* in the **Division** field.
5. Enter or select values for the following fields, if desired:
 - **Sold To** – customer master record number
 - **Route** – route type and number
 - **Exit Number** – exit number
 - **Type** – 1 (Gas), 2 (Food), 3 (Lodging), 4 (Camping) or 5 (Attractions)
 - **County** – three-digit county code
 - **Trade** – enter keyword from name of business surrounded by asterisks
 - **Sign Status** – A (Active) or I (Inactive)
 - **Material** – Logo material number
 - **Cntr Start Date** – date contract begins
 - **Cntr End Date** – date contract ends



6. Click . The **Logo Report Prepared by [userID] On [current date]** screen displays.
7. Review data in the following columns:
 - **Div** – division
 - **Route** – route type and number
 - **Exit** – route exit number
 - **Logo type** – 1 (Gas), 2 (Food), 3 (Lodging), 4 (Camping) or 5 (Attractions)
 - **Sold To** – customer master record number
 - **Sold To Name** – customer name
 - **Sales Document** – contract number
 - **Item** – line item number
 - **Purchase Doc** – signed agreement number
 - **WBS Number** – Logo WBS element for the division
 - **County** – three-digit county code
 - **Trade** – Logo trade name (name of business)
 - **Material** – Logo material number
 - **Order Description** – Logo material description
 - **Qty** – target quantity
 - **Net Price** – material price
 - **Cntr Str Dt** – contract start date
 - **Cntr End Dt** – contract end date
 - **Dismntl Date** – dismantling date
 - **Cancl Reason** – cancellation reason
 - **Bill Pln Str Dt** – billing plan start date
 - **Bill Pln End Dt** – billing plan end date
 - **Sign** – sign status
8. Click a **Sales Doc** to display the contract, if desired.





Click  to return to the report.

9. Click  to exit this transaction.



Y_DEV_6000077 – SD Open Items Report



Use this procedure to display a list of Logo customers with outstanding balances. This report does not show all activity on the customer account.

1. Enter *Y_DEV_6000077* in the **Command** field on the **SAP Easy Access** screen.
2. Click  or press **Enter**. The **SD Open Items Report** screen displays.
3. Enter *75* in the **Distribution channel** field to restrict the search to Logo customers only.
4. Enter the *division* in the **Division** field.
5. Click . A list of Logo customers with outstanding balances displays.
6. Review data in the following columns:
 - **Customer** – customer master record number
 - **Customer name** – name of customer
 - **Assignment** – signed agreement number
 - **Reference** – contract number (if outstanding invoice references a contract) or invoice number (if outstanding invoice references a sales order)
 - **Amount** – amount on invoice
 - **Baseline date** – baseline date for calculating due date
 - **Due date** – payment due date
 - **Dunning level** – 1 (customer has been notified of past due balance); 2 (expect communication from Accounts Receivable Clerk regarding possible cancellation of contract)
 - **Dunn Date** – date accounting document was last dunned
 - **Dunning block** – indicates customer will not continue to be dunned until a payment conflict has been resolved (typically H – hold for management review or L – forward to Logo coordinator)
 - **Billing Type** – ZFS (first year fees invoice); ZFL (annual renewal fees invoice)
 - **Document type** – DZ (customer payment); RV (invoice)
 - **Created by** – ID of user who created invoice
 - **Created on** – date invoice was created
 - **Doc date** – document date on document
 - **Pstg date** – posting date on document
7. Click  to exit this transaction



Y_DEV_6000070 – Customer Sales Area Query

Use this procedure to display a list of Logo customers by division.

1. Enter `Y_DEV_6000070` in the **Command** field on the **SAP Easy Access** screen.
2. Click  or press **Enter**. The **Customer Sales Area Query** screen displays.
3. Enter `75` in the **Distribution channel** field.
4. Enter a *division* in the **Division** field.
5. Click . A list of Logo customers for the division displays.
6. Review data in the following columns:
 - **AcctGrp** – customer account group (Z006 = Logo customers)
 - **Prev Acct** – previous customer master record number
 - **Customer** – customer master record number
 - **DF** – deletion flag
 - **SB** – central order block
 - **Customer Name 1** – customer name
 - **Street** – customer street address
 - **City** – customer city
 - **St** – customer state
 - **Post Code** – customer zip code for street address
 - **P.O. Box** – customer post office box
 - **PO Post Cd** – customer zip code for post office box
 - **Telephone** – customer telephone number
7. Click  to exit this transaction.



Appendix

Logo Materials & Fees

Material	Description	Fee
ARM900	LOGO ANNUAL MAINLINE FEE	\$300/year per panel
ARM901	LOGO ANNUAL RAMP FEE	\$300/year per panel
ARM902	LOGO ANNUAL TRAILBLAZER FEE	\$300/year per panel
ARM910	LOGO MONTHLY MAINLINE FEE	\$25/month per panel
ARM911	LOGO MONTHLY RAMP FEE	\$25/month per panel
ARM912	LOGO MONTHLY TRAILBLAZER FEE	\$25/month per panel

Logo WBS Elements

Division 1 – 36111.1.1
 Division 2 – 36111.1.2
 Division 3 – 36111.1.3
 Division 4 – 36111.1.4
 Division 5 – 36111.1.5
 Division 6 – 36111.1.6
 Division 7 – 36111.1.7

Division 8 – 36111.1.8
 Division 9 – 36111.1.9
 Division 10 – 36111.1.10
 Division 11 – 36111.1.11
 Division 12 – 36111.1.12
 Division 13 – 36111.1.13
 Division 14 – 36111.1.14

New Logo Agreement Processing Step-by-Step

Table of Contents

Introduction	3
Conventions	3
SAP Resources	3
Overview	4
Key Terms	4
What is the Logo Signing Program?	5
How Does it Work?	5
New Logo Agreement SAP Process	6
Customer Master Records	7
XD03 – Display Customer Master Record	7
Customer Master Template	9
XD01 – Extend Customer Master Record	9
XD01 – Create Customer Master Record	10
Workflow	13
SBWP – Process Workflow Work Items	14
XD02 – Change Customer Master Record	14
Sales Orders.....	17
VA01 – Create Sales Order	17
VA02 – Change Sales Order	19
Billing Documents	21
VF01 – Create Billing Document	21

Mail Invoice / Receive Payment21

Installation.....23

Contracts.....24

 Calculate Contract Dates24

 VA41 – Create Contract.....24

 VA42 – Change Contract30

 Send Documents & Payment to Accounts Receivable30

Tips & Tricks31

 Set Parameters.....31

 Set Default Printer32

 VA02 – Cancel Sales Order32

 VA03 – Display Sales Order33

 VF03 – Display Billing Document.....34

 VF03 – Reprint Billing Documents35

Appendix36

 Logo Materials & Fees36

 Logo WBS Elements.....36

Introduction

The New Logo Agreement Processing guide provides step-by-step instructions for creating customer master records, sales orders, billing documents and contracts for new Logo agreements.





Conventions

Italicized text indicates text that must be entered in a field.

Bold text in a procedure step indicates application elements that you select, choose, press or enter text.

Italicized and bolded text in a procedure indicates the name of a screen or dialog box that displays.

The following text boxes in a procedure indicate important information:

	Note – a guideline or practice
	Helpful Hint – a tip or hint that helps improve your efficiency
	Warning – a notification of important information
	Example – an example relevant to the task at hand
	Decision – a choice to make that will determine your next step

SAP Resources

Course materials, course catalog and training calendar are published on the Enterprise Business Services - Education (SAP) Training page of Inside NCDOT.

Overview

Key Terms

The following is a list of key terms and acronyms used throughout this guide. Refer to this section if you encounter an unfamiliar term.

Term	Acronym	Description
Billing Document	--	SAP document used to create an invoice
Business	--	actual business (gas station, restaurant, etc.) included in the Logo Signing Program; may also be called physical location or trade name
Business Owner	--	company or individual who owns the business (same as customer unless Logo fees are paid by corporate office)
Contract	--	SAP sales document that contains control data for the billing of annual renewal fees associated with the Logo Signing Program; includes details about the business
Customer	--	company or individual who pays the Logo fees (same as business owner until Logo fees are paid by corporate office)
Customer Master Record	--	data record in SAP that contains all information necessary to conduct business transactions with a specific customer
Logo Panel	--	sign depicting the name, symbol and/or trademark of a business included in the Logo Signing Program; may be used to refer to mainline panel, ramp panel or trailblazer panel
Mainline Panel	--	Logo panel attached to service sign prior to exit on route
Physical Location	--	physical location of the actual business represented on the Logo panel; may also be called trade name or business

Term	Acronym	Description
Ramp Panel	--	Logo panel attached to service sign on exit ramp
Sales Order	SO	SAP sales document that contains control data for the one-time billing of fees associated with the Logo Signing Program
Service Sign	--	sign to which Logo panels are attached
Trade Name	--	SAP term for the actual business (gas station, restaurant, etc.) included in the Logo Signing Program; may also be called physical location or business
Trailblazer Panel	--	Logo panel attached to service sign on secondary road when more than one turn is necessary to find the business
WBS Element	WBS	cost collector for revenues related to the Logo Signing Program

What is the Logo Signing Program?

The North Carolina Department of Transportation (NCDOT), as a service to the motoring public, provides Logo signing for highways with fully controlled access interchanges (fully controlled interchanges are grade separated and do not have intersections or driveways within the limits of the interchange). The Logo Signing Program allows NCDOT to install service signs to which individual business Logo panels are attached. Currently, signs are installed for gas, food, lodging, camping, and attraction services.

Mainline Logo panels are attached to service signs prior to the exit on the route. Ramp Logo panels are attached to service signs on the exit ramp. Trailblazer Logo panels are required on secondary roads when more than one turn is necessary to find the business. Businesses pay \$300 per year for each panel.

How Does it Work?

Businesses apply for the Logo program via a written request to the appropriate Division Engineer (or their designee, the Division Logo Coordinator). The Coordinator performs a field investigation to verify the distance of the business from the interchange. They also determine if there is space on existing mainline and ramp service signs to accommodate the necessary panels or if additional service signs would need to be installed.

If the business meets the distance requirements and there is adequate space for the panels, the Coordinator performs an on-site review of the business and completes a qualification survey form. The Coordinator meets with the business owner or their representative and discusses the quantity and type of panels required, provides copies of the program rules, a list of sign fabricators and other information as necessary. Once the field and on-site investigation is completed, the Coordinator sends a written response to the customer's request.

The sign fabricator for the owner is required to submit panel artwork to the Coordinator for review before the panels are fabricated. When the artwork is approved, the Coordinator notifies the sign fabricator to make the signs and provide them to the Coordinator for installation.

The Coordinator assigns an agreement number to the agreement following standard naming conventions and forwards the agreement to the business owner for signature. When the Coordinator receives the signed agreement, fabricated panels, and payment for first-year fees, they issue a work order to install the panels. After the panels are installed, the Coordinator creates a contract to represent the agreement in SAP. The Coordinator then sends the original signed agreement, invoice, and customer payment to Accounts Receivable.

New Logo Agreement SAP Process

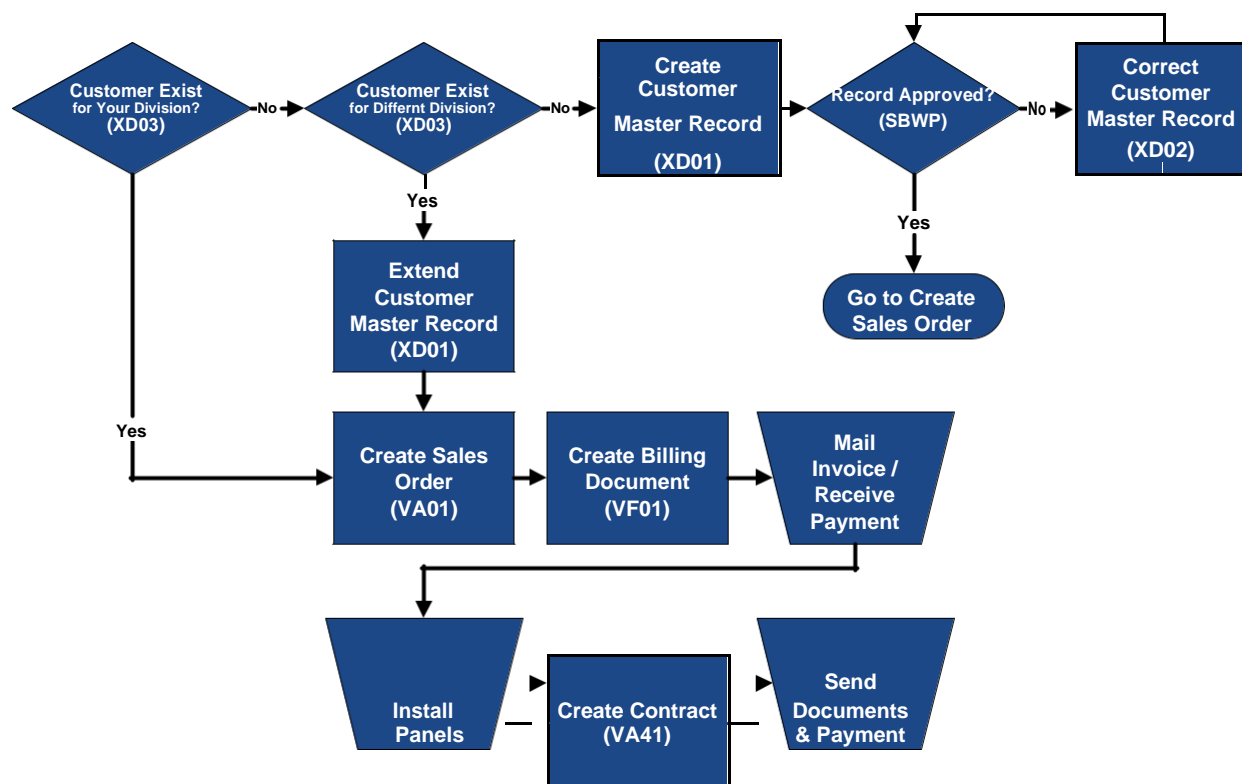



Customer Master Records

A customer master record is a data record in SAP that contains all information necessary to conduct business transactions with a specific customer. The customer is the legal entity responsible for paying the fees associated with the Logo Signing Program, and is often the same as the business owner. If the business is a franchise, and the corporate office pays the Logo fees, the corporate office is the customer and the franchise owner is the business owner.

For example, Joseph Strickland owns and operates Karolina Kampground, but the Logo Signing Program fees are paid by KOA of America Corporation. The customer master record captures details about KOA of America, the customer. Details about the business, Karolina Kampground, are captured on the contract.

XD03 – Display Customer Master Record

Before creating a new customer master record, always check to see if a Logo customer master record already exists for the client. If you think you have already created a Logo customer master record and cannot find it using this procedure, contact SAP Support Services for assistance. Do not create a duplicate customer master record.

1. Enter **XD03** in the **Command** field on the **SAP Easy Access** screen.
2. Click  or press **Enter**. The **Customer Display: Initial Screen** dialog box displays.
3. Click  to the right of the **Customer** field. The **Customer Account Number** dialog box displays.
4. Select the **Customers per sales group** tab, if necessary.
5. Enter a *keyword of the customer name surrounded by asterisks* in the **Name** field.



Entering a portion of the name surrounded by asterisks generates a larger number of results, but reduces the risk of not finding a customer due to data entry errors.

6. Enter **75** in the **Distribution Channel** field.
7. Clear the **Division** field, if necessary.



A value defaults in the **Division** field if you have set your parameters (refer to *Set Parameters* in the **Tips & Tricks** for details).

8. Clear the **Maximum No. of Hits** field, if desired.
9. Click  or press **Enter**. A list of customers matching the selection criteria entered displays.



If the following message displays, *No values for this selection*, the client does not have a Logo customer master record in SAP. Click to close the dialog box, then click to exit this transaction.

10. Review the values in the **Name 1**, **City**, **Postal Code** and **Dv** columns.



If ZZ precedes a customer name, the master record is not valid and should not be used.



If the name, city and postal code match the information provided by the business owner, take note of the division number in the **Dv** column, then continue with step 11 to review the customer master record.

If the name, city and postal code do not match the information provided, the client does not have a Logo customer master record in SAP. Click to close the dialog box, then click to exit this transaction.

11. Double click the appropriate customer. The customer master record number populates the **Customer** field.
12. Clear the **Sales Organization**, **Distribution Channel**, and **Division** fields, if necessary.
13. Click or press **Enter**. The **Display Customer: General Data** screen displays.
14. Review data in the following fields on the **Address** tab:
- **Name** – full name of customer
 - **Search term 1/2** – name of business
 - **Street/House number** – street address of customer
 - **Postal Code/City** – zip code and city



If the address in the **Street/House number** field does not match the address provided by the business owner, a new customer master record must be created.

If the address in the **Street/House number** field matches the address provided, record the customer master record number.

- If the division from step 10 matches your division, the master record can be used to create the sales order.
- If the division does not match, the master record can be extended to your division.

15. Click to exit this transaction.

Customer Master Template

A customer master template has been created for use when extending or creating customer master records for Logo. The customer name is *Logo Template Customer* and the record number is 29313. By referencing the template customer, many fields automatically default into the new customer master record, reducing the amount of data entry.

XD01 – Extend Customer Master Record

When the name and street address on an existing Logo customer master record matches the information on the new signed agreement, but the master record is not for your division, it can be extended (copied) to your division. Extending master records ensures each Logo customer has only one master record, regardless of the number or location of participating businesses they may own.



Use the following procedure to extend a Logo customer master record from one division to another, referencing the DOT Logo Template Customer.

1. Enter **XD01** in the **Command** field on the **SAP Easy Access** screen.
2. Click  or press **Enter**. The **Customer Create: Initial Screen** dialog box displays.



If your parameters have been set to default for Logo (refer to the *Set Parameters* procedure in the **Tips & Tricks**), proceed to step 7 to change the value in the **Reference division** field.

3. Click  in the **Account group** field, then select **LOGO Customers**.
4. Enter the *customer master record number to be extended* in the **Customer** field.
5. Ensure 1500 displays in the **Company code** field.
6. Enter values in the following fields in the **Sales area** section:
 - **Sales Organization** – 1500
 - **Distribution Channel** – 75
 - **Division** – division to receive the customer master record
7. Enter values in the following fields in the **Reference** section:
 - **Customer** – 29313
 - **Company code** – 1500
 - **Sales Organization** – 1500
 - **Distribution Channel** – 75
 - **Reference division** – division in which panel is to be installed

8. Click  or press **Enter**. The **Create Customer: Sales Area Data** screen displays.
9. Click . The **Customer Create: Initial Screen** displays the following message:
Customer [number] was created for sales area 1500 75 [new division]
10. Click  to exit this transaction.

XD01 – Create Customer Master Record

When the name and address provided by the business owner does not match an existing Logo customer master record, a new one must be created. New customer master records are automatically blocked until reviewed and approved by Accounts Receivable. A sales order cannot be created until the customer master record has been approved. The record creator receives notification of approval or rejection.

Logo customer master records are never created for marketing companies.

Also, it is recommended that users configure their parameter settings to default the sales organization, Logo distribution channel, Logo template customer, and their division into the selection criteria for customer master records, sales orders and contracts. (Refer to the *Set Parameters* procedure in the **Tips & Tricks** for instructions.)

1. Enter **XD01** in the **Command** field on the **SAP Easy Access** screen.
2. Click  or press **Enter**. The **Customer Create: Initial Screen** dialog box displays.



If your parameters have been set to default for Logo (refer to the *Set Parameters* procedure in the **Tips & Tricks**), perform the following:

1. Review the defaulted values to ensure they are correct.
2. Click , then proceed to *Customer Details*.

3. Click  in the **Account group** field, then select **LOGO Customers**.
4. Ensure 1500 displays in the **Company code** field.
5. Enter values in the following fields in the **Sales area** section:
 - **Sales Organization** – 1500
 - **Distribution Channel** – 75
 - **Division** – division in which panel is to be installed
6. Enter values in the following fields in the **Reference** section:
 - **Customer** – 29313
 - **Company code** – 1500

- **Sales Organization** – 1500
- **Distribution Channel** – 75
- **Reference division** – division in which panel is to be installed

7. Click  or press **Enter**. The **Create Customer: General Data** screen displays.

Customer Details

The customer is the company or individual paying for the Logo panels. The customer may or may not be the same as the business. If the customer and business are different, details about the business will be entered on the Logo contract.

Enter details about the customer (company or individual paying for the panels). Use CAPITAL LETTERS when entering text.

8. Enter the *FULL CUSTOMER NAME* in the first **Name** field.



If the customer is an individual, enter their full name. If the customer is a company, enter the full company name.



JOHN QUINCY ADAMS
BAKERSFIELD INVESTMENTS, INC
POPEYE'S CHICKEN & BISCUITS

9. Enter *ATTN: ACCOUNTS PAYABLE* in the second **Name** field.

10. Enter *SEARCH TERMS* in the **Search term 1/2** fields.



If the customer is an individual, enter the *LAST NAME* in the first **Search term 1/2** field, and the *FIRST NAME* in the second **Search term 1/2** field.

If the customer is a company, enter the prominent keyword(s) in the first **Search term 1/2** field (leave the second field blank).

Do not enter a keyword from the business name in the **Search term 1/2** fields unless the business is also the customer.



ADAMS JOHN QUINCY
BAKERSFIELD
POPEYE'S

11. Enter the *BILLING STREET ADDRESS* in the first **Street/House number** field.



Do not enter the physical location of the business represented on the Logo panel unless it is also the customer billing address.
If the customer address is a post office box, leave this field blank.
The second **Street/House number** field is not used by NCDOT.

12. Enter the *zip code* in the first **Postal Code/City** field.





If the customer address is a post office box, leave this field blank.

13. Enter the *CITY* in the second **Postal Code/City** field.
14. Enter the *TWO-LETTER STATE ABBREVIATION* in the **Region** field.
15. Enter the *TAX JURISDICTION CODE for the billing address* in the **Tax Jurisdictn** field.



If the customer address is out of state, enter *ZZ0000000* in the **Tax Jurisdictn** field.

If the customer address is in NC, perform the following:

1. Click  to the right of the field.
2. Enter *NC* in the **State** field.
3. Click  or press **Enter**.
4. Double click the county that corresponds to the customer address.

16. Enter the *POST OFFICE BOX NUMBER* in the **PO Box** field.



If the customer address is a street address, leave this field blank.

17. Enter the *zip code* in the **Postal code** field.



If the customer address is a street address, leave this field blank.

18. Enter a *telephone number and extension for the customer* in the **Telephone** and **Extension** fields, respectively.



Use dashes when entering telephone numbers. For example, 919-555-1212.

19. Enter a *mobile telephone number for the customer* in the **Mobile Phone** field, if available.
20. Enter a *fax number for the customer* in the **Fax** field, if available.
21. Enter an *E-MAIL ADDRESS for the customer* in the **E-Mail** field, if available.





Do not use the **E-Mail** field to enter additional text. The email address may be used to send official notifications and correspondence to the customer.



The @ symbol is required.

Billing Document Details

Enter details required for the billing document.

22. Click . The **Create Customer: Sales Area Data** screen displays.
23. Ensure *75* and the *correct division* displays in the **Distr. Channel** and **Division** fields in the header.
24. Ensure *1* defaults into the **Cust.pric.proc.** field on the **Sales** tab.
25. Select the **Billing Documents** tab.
26. Ensure *FOB* and *FREE ON BOARD* defaults into the **Incoterms** fields.
27. Ensure *NT30* defaults into the **Terms of payment** field.
28. Enter *1* in the **Tax classification** column for the **County Sales Tax** line item.
29. Enter *1* in the **Tax classification** column for the **City Sales Tax** line item.
30. Enter *1* in the **Tax classification** column for the **Tax Jurisdict. Code** line item.
31. Click . The **Customer Create: Initial Screen** displays the following message:
Customer [number] has been created for company code 1500 sales area 1500 75 [division]
32. Click  in the **Customer Create: Initial Screen** dialog box to exit this transaction.

Workflow

SAP Workflow is used to route documents and work items to customer master record creators when customer master records have been approved or rejected by Accounts Receivable. When you create a new customer master record, check your inbox regularly for notification of approval or rejection.

Workflow is initiated when a new customer master record is saved or when changes to a customer master record that has never been approved are saved. Extended customer

master records do not require approval from Accounts Receivable. When a customer master record is extended to another division, there is no resulting Workflow.

Documents  are generated by the system to notify customer master record creators that a master record has been approved.





Work items  are generated by the system to notify customer master record creators that a master record has been rejected.

If the customer master record is not correct, the Accounts Receivable clerk rejects the customer master record and provides an explanation. SAP sends the explanation to the record creator via a Workflow work item. The record creator must change the customer master record using transaction XD02. When changes are saved, the system generates a Workflow work item to Accounts Receivable requesting review of the corrected master record.

If the customer master record is a duplicate, the Accounts Receivable clerk rejects the customer master record and provides the record creator with the existing customer number via a Workflow work item. Duplicate master records are flagged for deletion by the Accounts Receivable clerk, and ZZ is added to the beginning of the customer name to indicate the master record should not be used.

Work items should be processed as soon as they are received.

SBWP – Process Workflow Work Items

1. Enter *SBWP* in the **Command** field on the **SAP Easy Access** screen, then click  or click  on the **SAP Easy Access** toolbar. The **Business Workplace of [user name]** screen displays.
2. Click  **Inbox**. All **Inbox** documents and work items display in the **Worklist**.
3. Double click the appropriate work item. The **Display document: Customer Master Record Rejection Notification** screen displays.
4. Review the **Reason for Rejection** text.
5. Click  to return to the inbox.



The work item is removed from the inbox.

6. Click  to exit this transaction.

XD02 – Change Customer Master Record

When a Logo customer master record was not set up correctly or needs updating, it should be changed.

- If making changes to a customer master record that has been rejected by Accounts Receivable, the Workflow process is the same as when a new master record is created (refer to the **Workflow** section)
- If making changes to a previously approved customer master record, such as updating the customer's address, telephone number or email address, there is no resulting Workflow

When a business is sold (and thus, the person or company paying for the Logo contract changes), do not simply change the customer master record to reflect the new owner. Instead, follow the *Change Ownership of Contract* process in the *Logo Contract Maintenance* course materials. However, if a business legally changes its name and the ownership remains the same, the name of the business can be changed on the customer master record.

For example, Bill Fox owns Bill's Barbecue. The customer master record lists Bill as the customer. Bill sells the business to his friend Jimmy Carroll. The responsibility of paying the Logo Signing Program fees moves from one entity to another. It is against Accounts Receivable policy to simply change the customer on the customer master record from Bill Fox to Jimmy Carroll. You must follow the *Change Ownership of Contract* process (refer to the *Logo Contract Maintenance* course materials for instructions).

However, if the customer master record lists Bill's Barbecue as the customer, and Bill doesn't sell the business, but instead legally changes the name to Foxy Barbecue, the entity responsible for paying the fees stays the same. The customer master record can and should be changed to reflect the new name.

1. Enter **XD02** in the **Command** field on the **SAP Easy Access** screen.
2. Click  or press **Enter**. The **Customer Change: Initial Screen** dialog box displays.
3. Enter the *customer number* in the **Customer** field.



If you do not know the customer number, click  to search for it.

4. Click  or press **Enter**. The **Change Customer: General Data** screen displays.





If the **Change Customer: Sales Area Data** screen displays instead, click .

5. Make the necessary changes.



If changing the billing address, be sure to review and update the **Jurisdic.code** as necessary.

6. Click . The **Customer Change: Initial Screen** displays the following message: *Changes have been made*
7. Click  in the **Customer Create: Initial Screen** dialog box to exit this transaction.

Sales Orders

A sales order is an SAP sales document that contains control data for the one-time billing of fees associated with the Logo Signing Program. The sales order captures details about the Logo panels, links the cost of the first-year fees to the Logo customer master record, and enters the WBS element to record revenue. Only the first -year fees are billed against the sales order. Annual renewal fees are billed against the contract by Accounts Receivable.

VA01 – Create Sales Order

Logo sales orders should be created no earlier than 30 days prior to the expected installation date of the panels. Do not change data that defaults into the sales order.

It is very important to avoid creating duplicate sales orders, because they appear to auditors as unbilled, open orders. If you think you have already created a Logo sales order and cannot find it using the *VA03 – Display Sales Order* procedure in the **Tips & Tricks**, contact SAP Support Services for assistance. Do not create another sales order.

Also, it is recommended that users reconfigure the columns of the line item table, making it easier to enter required data. (Refer to the *Reconfigure Table Columns/Configuration Button XPress Card* for instructions.)

1. Enter **VA01** in the **Command** field on the **SAP Easy Access** screen.
2. Click  or press **Enter**. The **Create Sales Order: Initial Screen** displays.



If your parameters have been set to default for Logo (refer to the *Set Parameters* procedure in the **Tips & Tricks**), perform the following:

1. Review the defaulted values to ensure they are correct.
2. Enter **ZOR** in the **Order Type** field.
3. Proceed to step 7.

3. Enter **ZOR** in the **Order Type** field.
4. Enter **1500** in the **Sales Organization** field.
5. Enter **75** in the **Distribution Channel** field.
6. Enter the *division in which the panel will be installed* in the **Division** field.
7. Click  or press **Enter**. The **Create DOT Standard Order: Overview** screen displays.
8. Enter the *customer master record number* in the **Sold-To Party** field.
9. Enter the *agreement number* in the **PO Number** field.



Uses dashes only if required for highway numbers.

For example, *US 064 383 204* or *I-077 154 201*.

The agreement number entered in the **PO Number** field is used to search for contracts, and must be entered accurately and consistently.

10. Enter the *current date* in the **PO date** field.
11. Click  or press **Enter** to validate your entries.
12. Enter a *Logo material number* in the **Material** column.



Use the following Logo materials for new Logo agreements:



- ARM900 – LOGO ANNUAL MAINLINE FEE
- ARM901 – LOGO ANNUAL RAMP FEE
- ARM902 – LOGO ANNUAL TRAILBLAZER FEE

13. Enter the *number of panels* in the **Order Quantity** column.
14. Enter the *Logo WBS element to receive payment* in the **WBS Element** column.



If the line item table has not been reconfigured, you must scroll to the right to find the **WBS element** column.

If you do not know the Logo WBS element for your division, refer to the table in the Appendix.

15. Click  or press **Enter** to validate your entries. The **Description** and **Amount** columns are populated with the relevant data.
16. Repeat steps 12-15 as necessary for additional line items.
17. Click . The following message displays: *DOT Standard Order [number] has been saved*







If the **Save Incomplete Document** dialog box displays, required data is missing from the sales order.

Click  to save the incomplete sales order. SAP assigns the order a document number, but still considers the order incomplete. Do not create a billing document for the sales order until all incomplete items have been corrected using transaction code VA02.

Click  to exit the sales order without saving your data.

Click  and perform the following to correct the incomplete data before saving the contract.

1. Click  to select all line items.
2. Click .
3. Refer to the message in the status bar, and enter or correct the data.
4. Click .
5. Repeat steps 3 – 4 until the following message displays in the status bar, *Document is complete*.
6. Click .

If problems saving the sales order persist, contact SAP Support Services.

18. Record the sales order number for future reference.

19. Click  to exit this transaction.

VA02 – Change Sales Order

Use this procedure to access an existing sales order that requires changes. If the billing document has already been created, Accounts Receivable must be contacted so they can cancel the billing document before you make changes to the sales order.

1. Enter VA02 in the **Command** field on the **SAP Easy Access** screen.
2. Click  or press **Enter**. The **Change Sales Order: Initial Screen** displays.
3. Enter the *sales order* in the **Order** field.





If you do not know the sales order number, click  to search for it.

- Click  or press **Enter**. The ***Change DOT Standard Order [number]: Overview*** screen displays.



If the following message displays, *Consider the subsequent documents*, and Accounts Receivable has already canceled the billing document, click  to continue. (If you have not contacted Accounts Receivable and requested cancellation of the billing document, exit this transaction and do so.)

- Make the necessary changes.
- Click  to validate your changes.
- Click . The ***Change Sales Order: Initial Screen*** displays the following message:
DOT Standard Order [number] has been saved
- Click  to exit this transaction.



Billing Documents

A billing document is an SAP document used to create an invoice. Logo Coordinators create a billing document for the first-year fees captured on a Logo sales order. Billing documents reference the customer master record and sales order. When a billing document is saved, SAP automatically prints two copies of the invoice and attaches an image of the invoice to the billing document in the system.

VF01 – Create Billing Document

Use this procedure to create a billing document referencing a Logo sales order. Never create a billing document that references a Logo contract.

Be sure you have set up your default printer before creating the billing document. Refer to the *Set Default Printer* procedure in the **Tips & Tricks** for instructions, if necessary.

1. Enter **VF01** in the **Command** field on the **SAP Easy Access** screen.
2. Click  or press **Enter**. The **Create Billing Document** screen displays.
3. Enter the *sales order* in the **Document** column.
4. Click  or press **Enter**. The **DOT Standard Invoice (ZFS) Create: Overview of Billing Items** screen displays.
5. Review the line items.



If a line item requires changes, exit this transaction. Use transaction VA02 to correct the line item in the sales order, then begin this procedure again.

6. Click . The **Create Billing Document** screen displays the following message: *Document [number] has been saved.*



Two copies of the invoice automatically print to your default SAP printer.

7. Click  to exit this transaction.

Mail Invoice / Receive Payment

If the customer submits payment when they return the signed agreement, the Coordinator stamps RECEIVED on both of the invoices, and records the date payment was received on each copy. One copy of the invoice is sent to the customer as a receipt and the remaining copy is placed with the customer payment.

If the customer has not already submitted payment, the Coordinator places a label indicating the Division office as the remit to address on one invoice, and forwards it to the customer to request payment. When payment is received, the Coordinator stamps RECEIVED on the remaining invoice, records the date payment was received, and places the invoice with the customer payment.

Installation

The Coordinator issues a work order for NCDOT personnel or a contractor to install Logo panels only after customer payment has been received. If the Coordinator is not on site when the panels are installed, they must confirm that the panels were installed correctly.

The date of installation is required when creating the contract.

Contracts

For the NCDOT Logo Signing Program, a contract is an SAP sales document that contains data used for the annual billing of Logo renewal fees. The contract captures details about the business and the Logo panels, links the cost of renewal fees to the Logo customer master record, and enters the WBS element to record revenue.

Only annual renewal fees are billed against the contract. The first-year fees are billed against the sales order. Accounts Receivable is responsible for invoicing Logo customers for annual renewal fees one month before they are due. The contract start date determines the bill date for the automated billing cycle. The contract end date is required in order to generate a bill plan.

Calculate Contract Dates

Before creating a contract, the start and end dates for the contract must be calculated. When a panel is installed on the 1st through 14th day of the month, the contract start date is one year from the first day of the same month. When a panel is installed on the 15th through the 31st day of the month, the contract start date is one year from the first day of the following month. For example, if the panel was installed on February 6, 2012, the contract start date is February 1, 2013. If the panel was installed on May 16, 2012, the contract start date is June 1, 2013.

The contract end date is the last day of the month prior to the contract start month for the year 2030. For example, if the contract start date is February 1, 2015, the contract end date is January 31, 2030.

VA41 – Create Contract

Use this procedure to create a Logo contract using information from the signed agreement. Do not create a contract until the Logo panels have been installed.

Also, it is recommended that users reconfigure the columns of the line item table, making it easier to enter required data. (Refer to the *Reconfigure Table Columns/Configuration Button XPress Card* for instructions.)

Use CAPITAL LETTERS when entering text.

1. Enter **VA41** in the **Command** field on the **SAP Easy Access** screen.
2. Click  or press **Enter**. The **Create Contract: Initial Screen** displays.



If your parameters have been set to default for Logo (refer to the *Set Parameters* procedure in the **Tips & Tricks**), perform the following:

1. Review the defaulted values to ensure they are correct.
2. Enter *ZLG* in the **Contract Type** field.
3. Proceed to step 4.

3. Enter or select a value for the following fields:
 - **Contract Type** – ZLG
 - **Sales Organization** – 1500
 - **Distribution Channel** – 75
 - **Division** – division in which panel was installed
4. Click  or press **Enter**. The **Create Logo Contract: Overview** screen displays.
5. Enter the *customer master record number* in the **Sold-To Party** field.
6. Enter the *agreement number* in the **PO Number** field.



Uses dashes only if required for highway numbers.
For example, *US 064 383 204* or *I-077 154 201*.

The agreement number entered in the **PO Number** field is used to search for contracts, and must be entered accurately and consistently.

7. Enter the *current date* in the **PO date** field.
8. Click  or press **Enter** to validate your entries.
9. Enter the *date for the start of the contract* in the **Contract start** field.



Do not use the same year the panel installed as the contract start year.

10. Enter the *date for the end of the contract* in the **Contract end** field.
11. Click  or press **Enter** to validate your entries.
12. Enter a *Logo material number* in the first blank row in the **Material** column.

 Use the following Logo materials for new Logo agreements:

- ARM900 – LOGO ANNUAL MAINLINE FEE
- ARM901 – LOGO ANNUAL RAMP FEE
- ARM902 – LOGO ANNUAL TRAILBLAZER FEE

 Do not enter or overwrite text in the **Description** column.

13. Enter the *number of panels* in the **Target Quantity** column.

 Enter the number of panels requested on the signed agreement and on the sales order.

14. Enter the *Logo WBS element to receive payment* in the **WBS Element** column.

 Enter the WBS element that is listed on the signed agreement and on the sales order.

If the line item table has not been reconfigured, you must scroll to the right to find the **WBS element** column.

15. Click  or press **Enter** to validate your entries. The **Description** column is populated with the relevant data and the net value is calculated.

 The **Net value** of each line item is a calculation of the price of the material, number of years on the contract, and number of panels. The **Net value** in the header is the sum of the net values for the line items.



Line 10	price of material	\$300
	years on contract	11
	number of panels	2
	net value of line item	\$6,600
Line 20	price of material	\$300
	years on contract	11
	number of panels	2
	net value of line item	\$6,600
Header	net value of contract	\$13,200

16. Repeat steps 15 – 18 as necessary for additional panels.





Do not create more than three line items. If four or more line items are created on a Logo contract, only the first three are included on the annual billing document, and the printed invoice does not reflect the total amount due. When the customer pays the incorrect invoice, the amount paid does not match the amount owed.

17. Click  to the right of the **PO date** field. The **Create Logo Contract: Header Data** screen displays.
18. Select the **Contract data** tab.
19. Enter the *date the panel was installed* in the **Installation date** field.
20. Enter the *date the customer check was received by the Logo Coordinator* in the **Acceptance date** field.
21. Enter the *date the agreement was signed by the Division Engineer or designee* in the **Contract signed** field.



If the physical location of the business is the same as the customer address, proceed to step 30.

If the physical location of the business is different from the customer address, continue with step 25.

22. Select the **Partners** tab.
23. Click  to the left of the **Ship-to party** line item.
24. Click  at the bottom of the screen. The **Address from Master Data for Ship-to party (Document header)** dialog box displays.



Data in the **Address from Master Data for Ship-to party (Document header)** dialog box defaults from the customer master record, and must be changed as necessary to reference the physical location of the business.

25. Review values in the following fields, and make changes as necessary:
- **Name** – BUSINESS NAME
 - **Street/House number** (first field) – BUSINESS PHYSICAL ADDRESS



NCDOT does not use the second field.

- **Postal Code/City** – enter the business zip code in the first field, and the CITY in the second field
- **Region** – NC
- **Jurisdct.code** – do not change the jurisdiction code that defaults



If the field is blank, it will cause the contract to error out during annual invoicing.

If the **Jurisdct.code** field does not display, click  in the **Street address** section.

- **Telephone** – telephone number for the business



Use dashes when entering telephone numbers. For example, 919-555-1212.

- **E-Mail** – email address for the business



Do not use the **E-Mail** field to enter additional text.



The @ symbol is required.





- **Comments** – any additional contact information for the business

26. Click  or press **Enter** to validate your changes.



If the **Information** dialog box displays, click .

If the **Adjust items** dialog box displays, click .

27. Click , then select **Additional data B**.
28. Click  in the **Route no.** field.
29. Double click the *route where the panel is located*.
30. Click  in the **Exit no.** field.
31. Click  or press **Enter**.
32. Double click the *exit where the panel is located*.
33. Click  in the **County code** field.
34. Double click the *county where the panel is located*.

35. Enter the *number of miles between the exit and the business location* in the **Mileage** field.
36. Click  in the **Logo type** field.
37. Double click the type of Logo sign for the panel.
38. Enter *A* in the **Sign status** field to indicate the sign is active.
39. Enter the *BUSINESS NAME* and *STORE NUMBER* (if available) in the **Trade name** field.





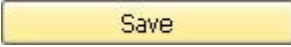

40. Click . The following message displays:
Logo Contract [number] has been saved

 If the **Save Incomplete Document** dialog box displays, required data is missing from the contract.

Click  to save the incomplete contract. SAP assigns the contract a document number, but prevents the contract from invoicing until all incomplete items have been corrected using transaction code VA42.

Click  to exit the contract without saving your data.



Click  and perform the following to correct the incomplete data before saving the contract.

1. Click  to select all line items.
2. Click .
3. Refer to the message in the status bar, and enter or correct the data.
4. Click .
5. Repeat steps 3 – 4 until the following message displays in the status bar, *Document is complete*.
6. Click .

41. Record the contract number for future reference.
42. Click  to exit this transaction.



VA42 – Change Contract

Use this procedure access a contract that requires changes to agreement numbers, dates, material numbers, demographic data, etc.

1. Enter **VA42** in the **Command** field on the **SAP Easy Access** screen.
2. Click  or press **Enter**. The **Change Contract: Initial Screen** displays.
3. Enter the *contract number* in the **Contract** field.
4. Click  or press **Enter**. The **Change Logo Contract [number]: Overview** screen displays.



If the **Information** dialog box displays the following message, *Consider the subsequent documents*, documents related to the contract (invoices, credit memos, accounting document, etc.) exist. Click  to continue.

5. Make necessary changes.
6. Click . The **Change Contract: Initial Screen** displays the following message:
Logo Contract [number] has been saved
7. Click  to exit this transaction.

Send Documents & Payment to Accounts Receivable

After the contract has been created, the Coordinator records the agreement number, contract number, and customer master record number on the signed agreement. The Coordinator then sends the original signed agreement, customer payment, and invoice to Accounts Receivable.

.

Tips & Tricks

Set Parameters



Use this procedure to configure parameter settings to default the sales organization, Logo distribution channel, division and DOT Logo Template Customer into the selection criteria when creating customer master records, sales orders and contracts for the Logo Signing Program.

1. Follow the menu path **System** → **User Profile** → **Own Data**. The **Maintain User Profile** screen displays.
2. Select the **Parameters** tab.
3. Scroll to the bottom of the **Parameter** section.
4. Enter the following data in the **Parameter ID** and **Parameter value** columns:



Parameter ID	Parameter value
KGD	Z006
VKO	1500
VTW	75
SPA	<i>two-digit division number</i>
RBU	1500
RVK	1500
RVT	75
RSP	<i>two-digit division number</i>
RKN	29313



Do not change any existing information on the screen.



5. Click . The new parameters are sorted in alphabetical order with the existing parameters and text for the new parameters defaults into the **Short Description** column.
6. Click . The **SAP Easy Access** screen displays the following message:
User [user ID] was saved.

Set Default Printer

1. Follow the menu path **System** → **User Profile** → **Own Data**. The **Maintain User Profile** screen displays.
2. Select the **Defaults** tab.
3. Click in the **OutputDevice** field. The matchcode button displays to the right of the field.
4. Click . The **Spool: Output device** dialog box displays.
5. Clear the **Output Device** field.
6. Click . A list of printers displays.
7. Double click the printer name in the **OutputDevice** column. The printer name displays in the **OutputDevice** field on the **Maintain User Profile** screen.



The printer name is typically located on a label attached to the printer. Printer names are case sensitive, and must be entered exactly as they appear on the printer.

8. Ensure the **Output Immediately** and **Delete After Output** checkboxes are selected.
9. Click  or press **Enter**.
10. Click  to save your printer changes and return to the **SAP Easy Access** screen.

VA02 – Cancel Sales Order

Use this procedure to cancel a duplicate sales order created by mistake. Do not cancel a sales order for which the billing document has been created and mailed. If the billing document has been created but not yet mailed, contact Accounts Receivable to request the billing document be canceled before canceling the sales order.

1. Enter **VA02** in the **Command** field on the **SAP Easy Access** screen.
2. Click  or press **Enter**. The **Change Sales Order: Initial Screen** displays.
3. Enter the *sales order* in the **Order** field.







If you do not know the sales order number, click  to search for it.

4. Click  or press **Enter**. The **Change DOT Standard Order [number]: Overview** screen displays.



If the following message displays, *Consider the subsequent documents*, a billing document has already been created for the sales order. Exit this transaction, then contact Accounts Receivable for assistance.

5. Click  in the **Order reason** field, then select **Cancelled – Other**.
6. Click  in the **Reason for rejection** column for the first line item, then select **DOT – Sales Order Rejection**.
7. Repeat step 6 for any remaining line items.
8. Click . The **Change Sales Order: Initial Screen** displays the following message:
DOT Standard Order [number] has been saved
9. Click  to exit this transaction.

VA03 – Display Sales Order



Use this procedure to display and review a sales order.

1. Enter **VA03** in the **Command** field on the **SAP Easy Access** screen.
2. Click  or press **Enter**. The **Display Sales Order: Initial Screen** displays.
3. Enter a *sales order* in the **Order** field.



If you do not know the order number, click  in the **Order** field to search for it.

4. Click  or press **Enter**. The **Display DOT Standard Order [number]: Overview** screen displays with the **Sales** tab selected.
5. Review the data in the following fields in the header:
 - **DOT Standard Ord** – order number
 - **Net value** – total dollar amount of order
 - **Sold-To Party** – customer master record number and details
 - **PO Number** – signed agreement number
 - **PO date** – date sales order was created
6. Review the data in the following columns in the **All items** section:
 - **Material** – Logo material number
 - **Description** – description of Logo material
 - **Amount** – actual cost for line item

- **WBS Element** – WBS element to receive payment
7. Click  to return to the initial screen.
 8. Click  to display the document flow, if desired.







Click a document number, then click  to display the document, if desired. Click  to return to the document flow.

9. Click  to exit this transaction.



VF03 – Display Billing Document

Use this procedure to display and review a billing document.

1. Enter *VF03* in the **Command** field on the **SAP Easy Access** screen.
2. Click  or press **Enter**. The **Display Billing Document** screen displays.
3. Enter the *billing document* in the **Billing document** field.
4. Click  or press **Enter**. The **DOT Standard Invoice (ZFS) Display: Overview of Billing Items** screen displays.
5. Review values in the following fields in the header:
 - **DOT Standard Invoice** – billing document number
 - **Net Value** – total dollar amount invoiced
 - **Payer** – customer number, name and address
 - **Billing Date** – date billing document was created
6. Review values in the following columns:
 - **Description** – description of Logo material
 - **Billed Quantity** – number of panels
 - **Net value** – dollar amount for line item
 - **Material** – Logo material number
 - **DistChanOrder** – (distribution channel) should always be 75
 - **Division** – division in which panel will be installed
 - **WBS Element** – WBS element to receive payment
 - **Sales Document** – sales order number
7. Click  to return to the **Display Billing Document** screen.

8. Click  to display the document flow, if desired.





Click a document number, then click  to display the document, if desired. Click  to return to the document flow.

9. Click  to exit this transaction.





VF03 – Reprint Billing Documents

Use this procedure to reprint invoices that have already been printed.

1. Enter *VF03* in the **Command** field on the **SAP Easy Access** screen.
2. Click  or press **Enter**. The **Display Billing Document** screen displays.
3. Enter the *billing document* in the **Billing document** field.
4. Click  or press **Enter**. The **Logo Invoice [number] (ZFL) Display: Overview of Billing Items** screen displays.
5. Click the right side of , then select **Attachment list**. The **Service: Attachment list** dialog box displays a list of attachments.
6. Double click a **Billing document**. A PDF image of the attachment displays.



If this is not the attachment you wish to print, click  to close the window, then double click another **Billing document** until the desired PDF image displays.

7. Follow the menu path **Document** → **Print**. The **Print** dialog box displays.
8. Ensure the desired printer and settings are selected.
9. Click .
10. Click  to close the window.
11. Repeat steps 6 – 10 as necessary to reprint additional invoices and letters.
12. Click  to close the **Service: Attachment list** dialog box.
13. Click  to exit this transaction.

Appendix

Logo Materials & Fees

Material	Description	Fee
ARM900	LOGO ANNUAL MAINLINE FEE	\$300/year per panel
ARM901	LOGO ANNUAL RAMP FEE	\$300/year per panel
ARM902	LOGO ANNUAL TRAILBLAZER FEE	\$300/year per panel

Logo WBS Elements

Division 1 – 36111.1.1

Division 2 – 36111.1.2

Division 3 – 36111.1.3

Division 4 – 36111.1.4

Division 5 – 36111.1.5

Division 6 – 36111.1.6

Division 7 – 36111.1.7

Division 8 – 36111.1.8

Division 9 – 36111.1.9

Division 10 – 36111.1.10

Division 11 – 36111.1.11

Division 12 – 36111.1.12

Division 13 – 36111.1.13

Division 14 – 36111.1.14

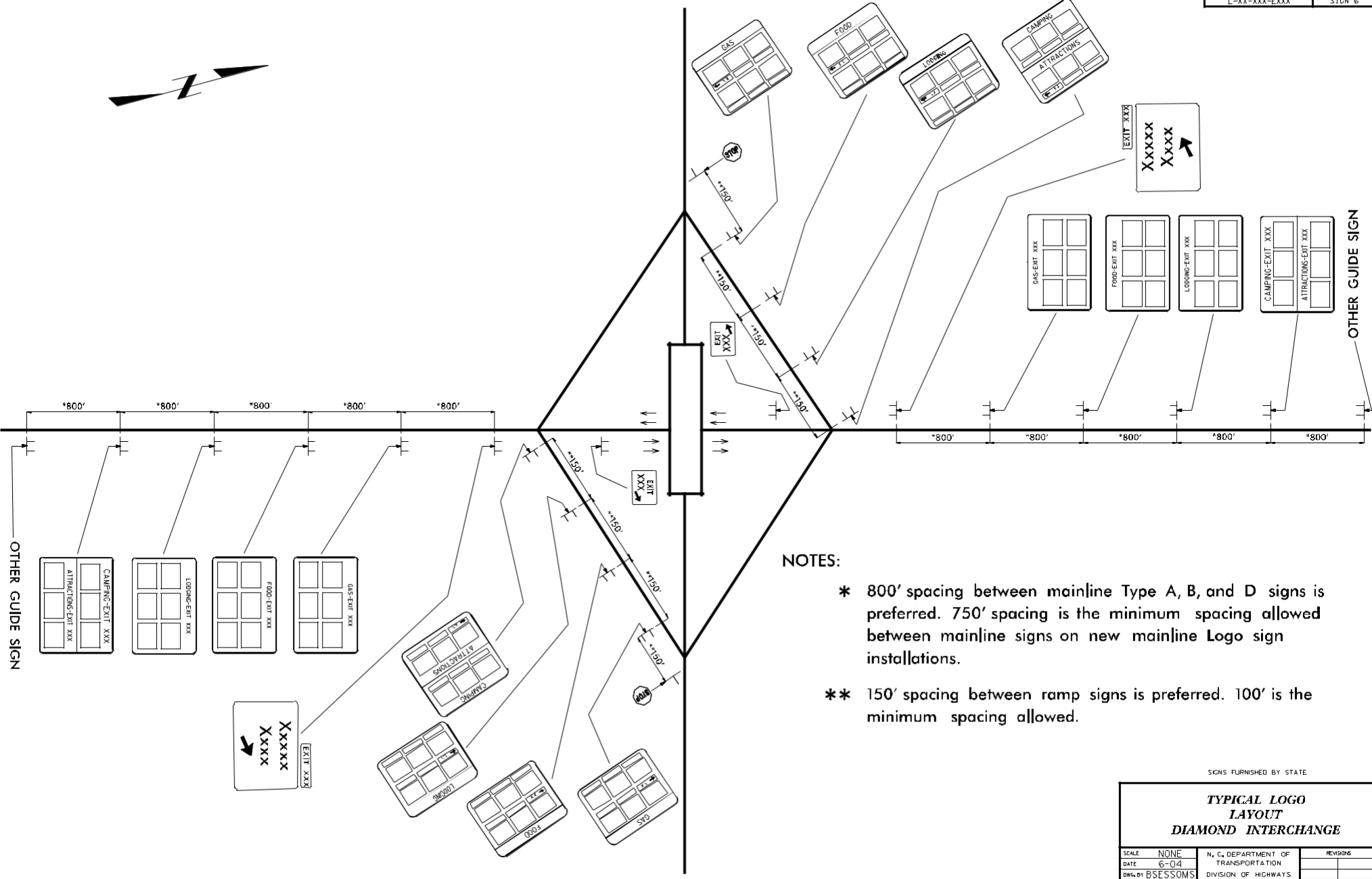

NOTES:

- * 800' spacing between mainline Type A, B, and D signs is preferred. 750' spacing is the minimum spacing allowed between mainline signs on new mainline Logo sign installations.
- ** 150' spacing between ramp signs is preferred. 100' is the minimum spacing allowed.

SIGNS FURNISHED BY STATE

TYPICAL LOGO LAYOUT DIAMOND INTERCHANGE		
SCALE NONE	N. C. DEPARTMENT OF TRANSPORTATION DIVISION OF HIGHWAYS TRAFFIC ENGINEERING BRANCH	#Revised
DATE 6-04		
DESIGNED BY BSESSOMS		
APPROVED TLC		

Appendix I

NOTES:

1. On split A-B exits, the mainline holds a maximum of 3 businesses per exit per service, however, 6 businesses are allowed per service on the ramp sign. A business that can be clearly seen when approaching the end of the ramp or from the location the sign is installed, is not required to have a panel included on the ramp sign.
2. If a business on the mainline service sign drops out of the program, one of the three businesses on the ramp, not shown on the mainline sign, is given first opportunity to acquire the open mainline slot. The first of the three businesses to originally sign a contract with the department should be contacted to see if they want the open slot. A new business is not allowed on the mainline sign until all three businesses not shown on the mainline have been offered the mainline slot.

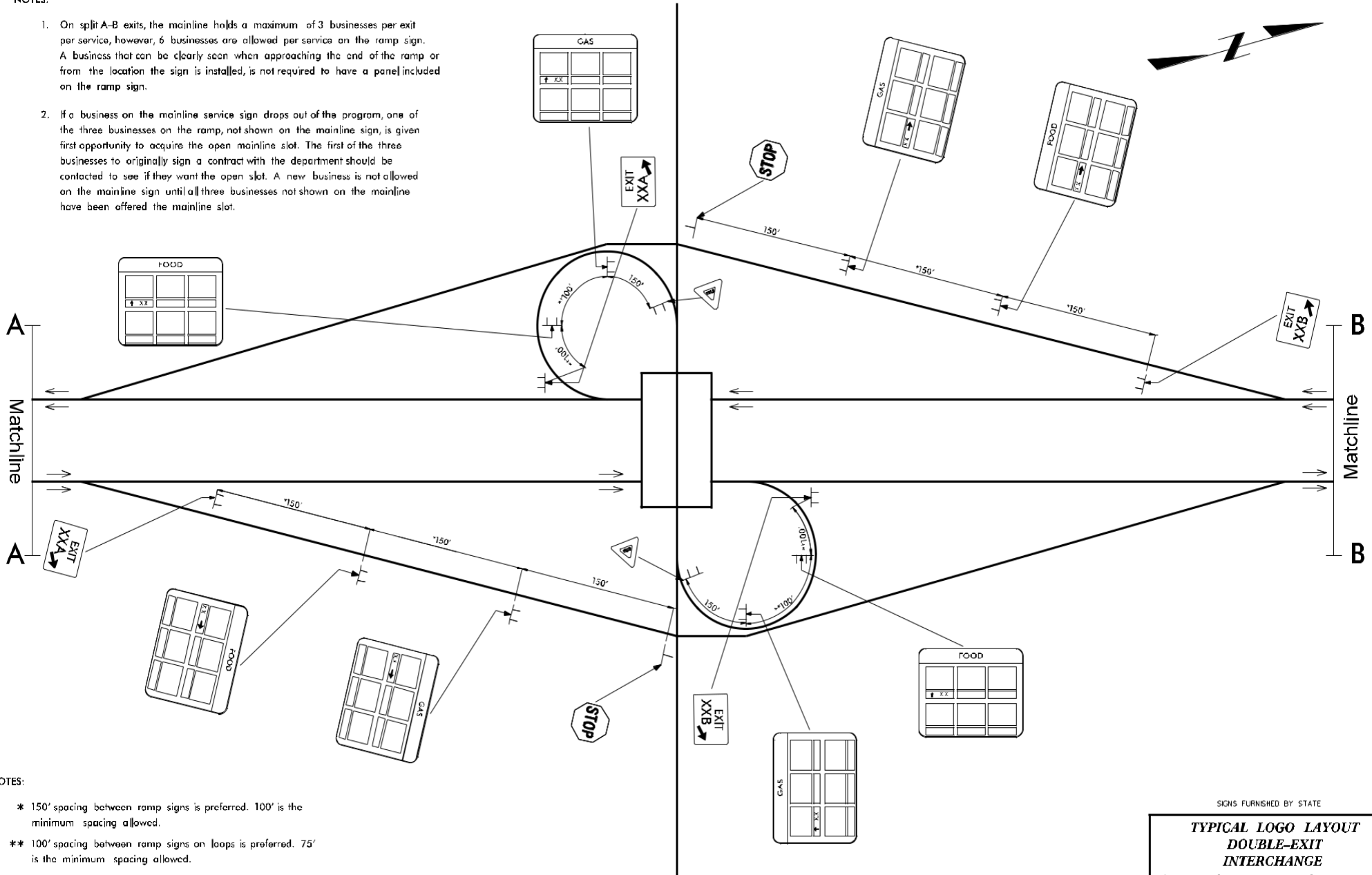

NOTES:

- * 150' spacing between ramp signs is preferred. 100' is the minimum spacing allowed.
- ** 100' spacing between ramp signs on loops is preferred. 75' is the minimum spacing allowed.

SIGNS FURNISHED BY STATE

TYPICAL LOGO LAYOUT DOUBLE-EXIT INTERCHANGE		
SCALE	N. C. DEPARTMENT OF TRANSPORTATION	REVISIONS
NONE	6-04	
DATE	DIVISION OF HIGHWAYS	
DESIGN BY	TRAFFIC ENGINEERING	
DESIGN BY	BRANCH	
APPROVED	T. C.	

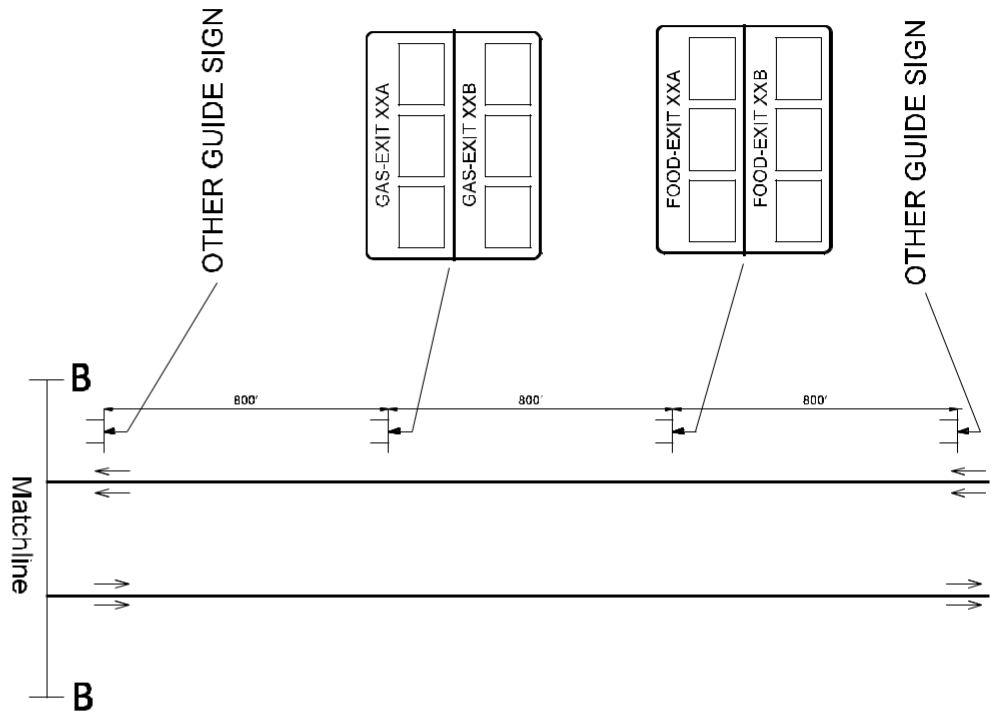
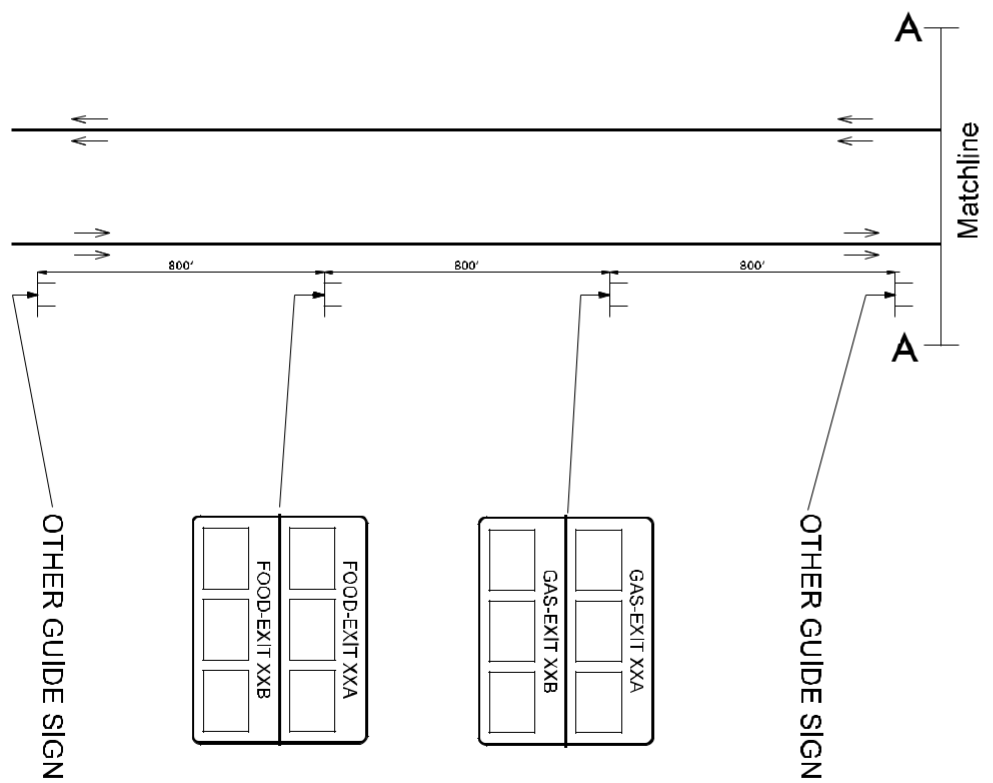

Note: 800' spacing between mainline Type A, B, and D signs is preferred. 750' spacing is the minimum spacing allowed between mainline signs on new mainline Logo sign installations.

SIGNS FURNISHED BY STATE

TYPICAL LOGO LAYOUT DOUBLE-EXIT INTERCHANGE			
SCALE	NONE	N. C. DEPARTMENT OF TRANSPORTATION DIVISION OF HIGHWAYS TRAFFIC ENGINEERING BRANCH	REVISIONS
DATE	6-04		
DRG. BY	BSESSOMS		
DESIGN BY			
APPROVER	TLC		

Loop Option

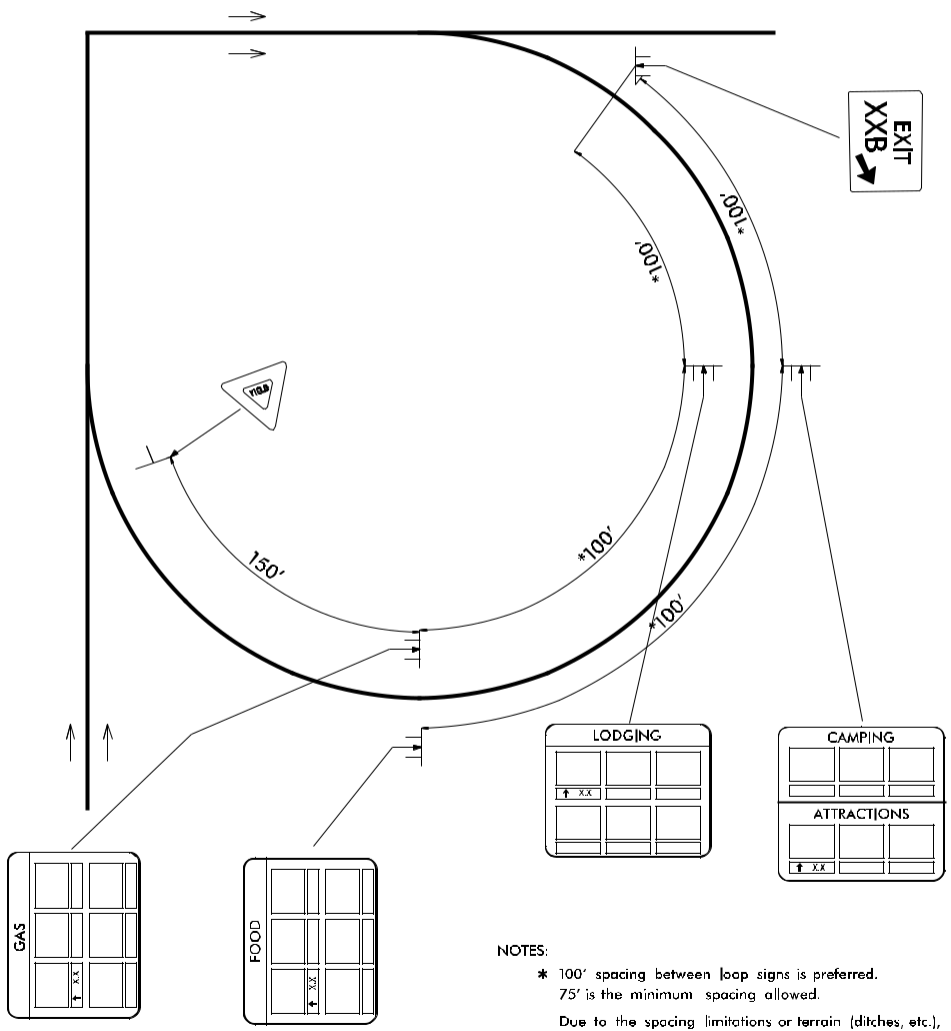

NOTES:

- * 100' spacing between loop signs is preferred. 75' is the minimum spacing allowed.
- Due to the spacing limitations or terrain (ditches, etc.), ramp/loop Logo signs may be installed on both sides or either side of the ramp.

Ramp Option

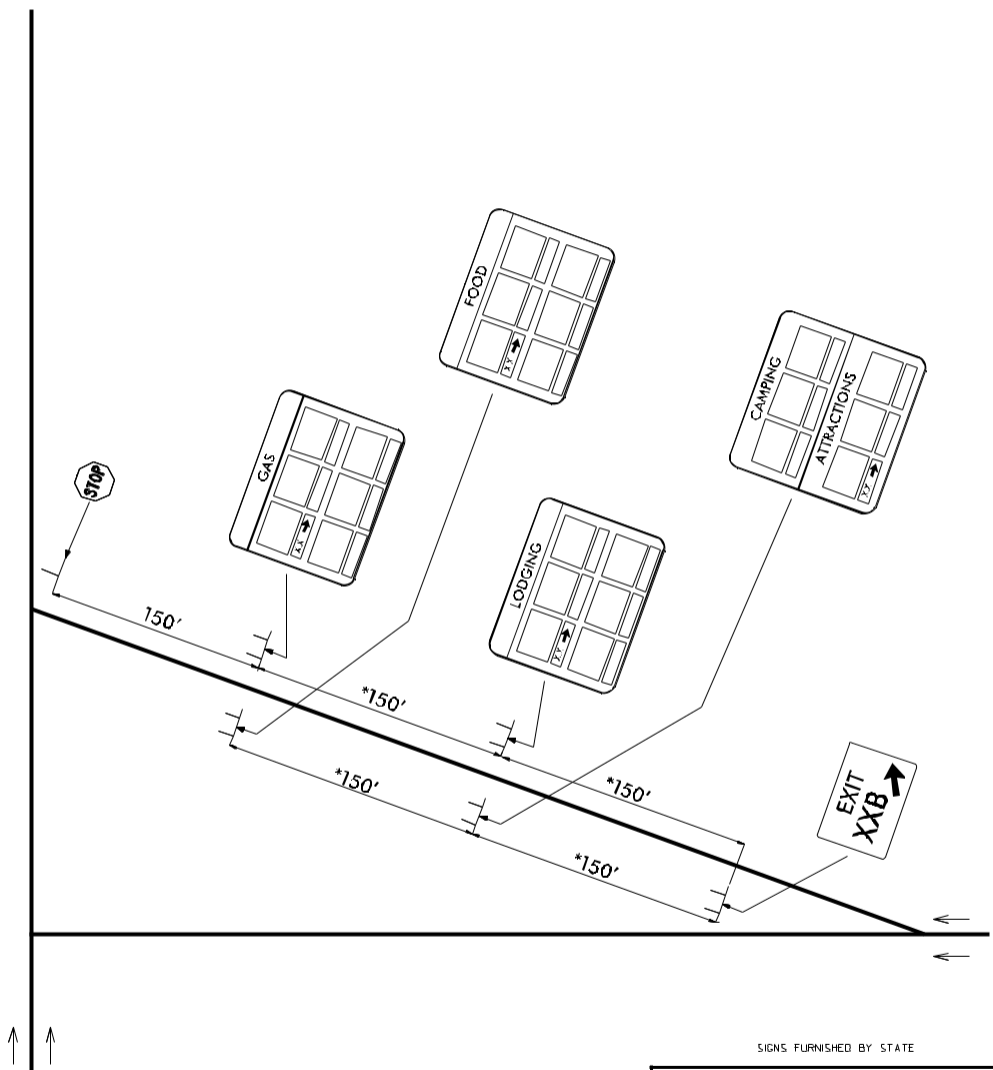

NOTES:

- * 150' spacing between ramp signs is preferred. 100' is the minimum spacing allowed.
- Due to the spacing limitations or terrain (ditches, etc.), ramp/loop Logo signs may be installed on both sides or either side of the ramp.

SIGNS FURNISHED BY STATE

LOGO RAMP/LOOP OPTION			REVISIONS
SCALE	NONE	N. C. DEPARTMENT OF TRANSPORTATION DIVISION OF HIGHWAYS TRAFFIC ENGINEERING BRANCH	
DATE	7-04		
DRG. BY	BESSOMS		
DESIGN BY			
APPROVED	TLC		

NCDOT LOGO PROGRAM TYPICAL DRAWING

TYPICAL LOGO SIGNING AT END OF FREEWAY

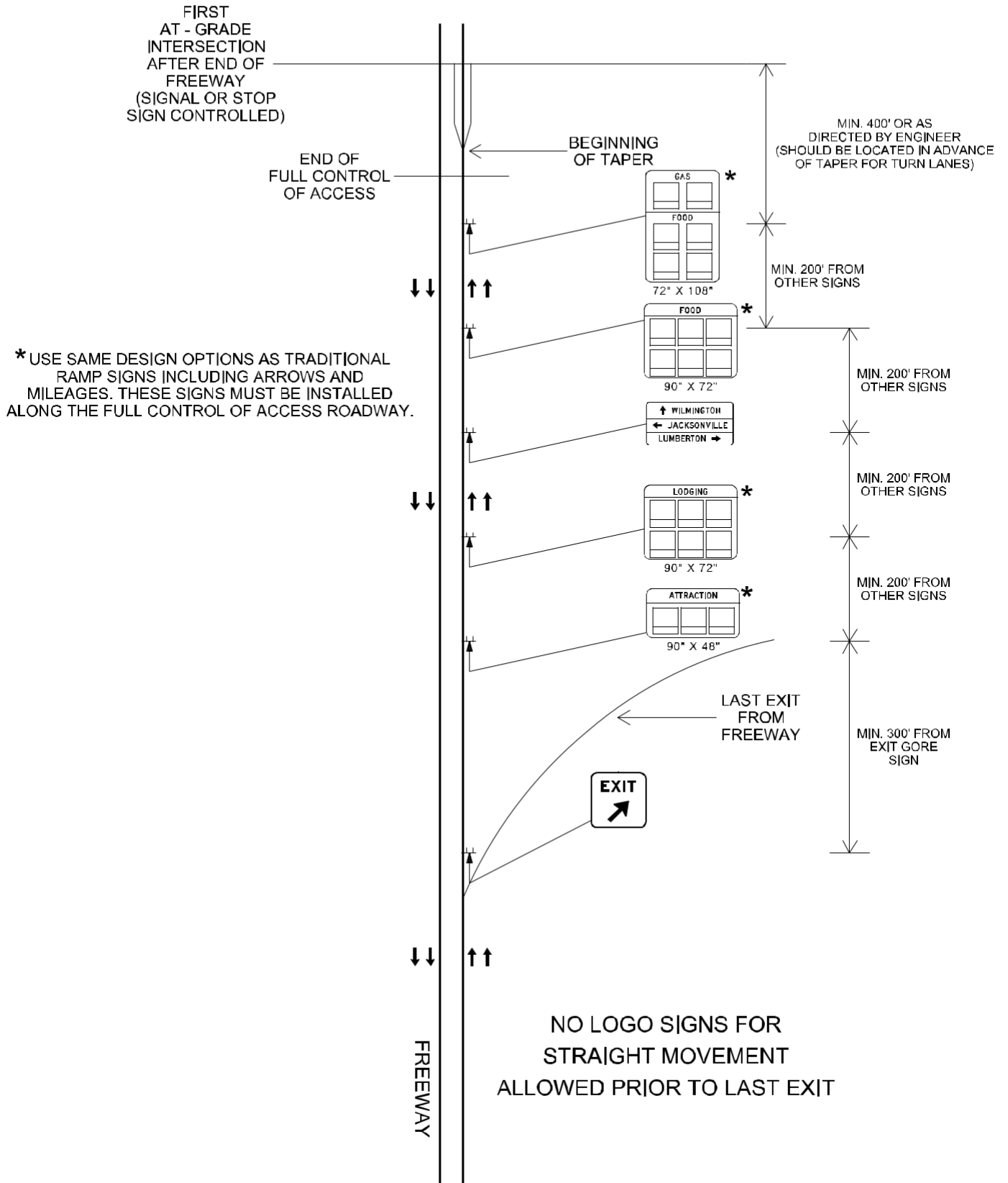

Appendix J

Appendix J

VA41 – Create Contract with Reference to Cancelled Contract

Use this procedure to create a new contract with reference to the cancelled contract.

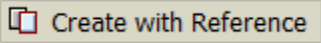
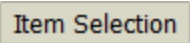
1. Enter VA41 in the **Command** field on the **SAP Easy Access** screen.
2. Click  or press **Enter**. The **Change Contract: Initial Screen** displays.
3. Enter ZLG in the **Contract Type** field.
4. Enter 1500 in the **Sales Organization** field.
5. Enter 75 in the **Distribution Channel** field.
6. Enter the division in which the panel was installed in the **Division** field.
7. Click . The Create with Reference/Release from Contract dialog box displays.
8. Enter the cancelled contract number in the **Contract** field.
9. Click . The **Logo Contract [number]: Selection List for Reference Document** screen displays a list of materials and quantities from the cancelled contract.
10. Clear the checkbox to the left of any cancelled line items that will not be included in the contract.



Any cancelled line items not deselected will be copied into the new contract and thus be eligible for billing during the next billing cycle.

11. Click  **Copy**. The following message displays:

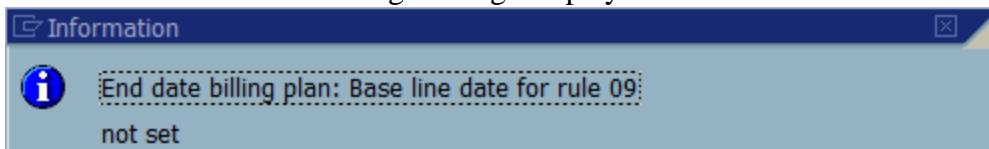

12. Click  or press **Enter** until the **Create Logo Contract: Overview** screen displays; populated with information from the cancelled contract.



The message will display once for each contract line item.

13. Enter the customer number for the new owner in the **Sold-To Party** field.

Appendix J

14. Click **Enter** to validate your entries.

15. The following message displays:

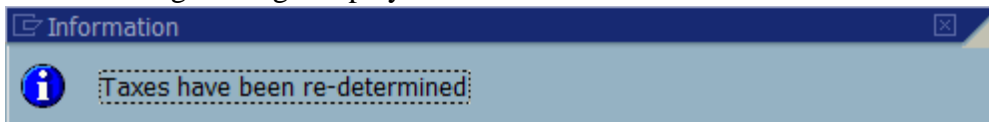

16. Click  or press Enter until the Adjust items dialog box displays the following message:

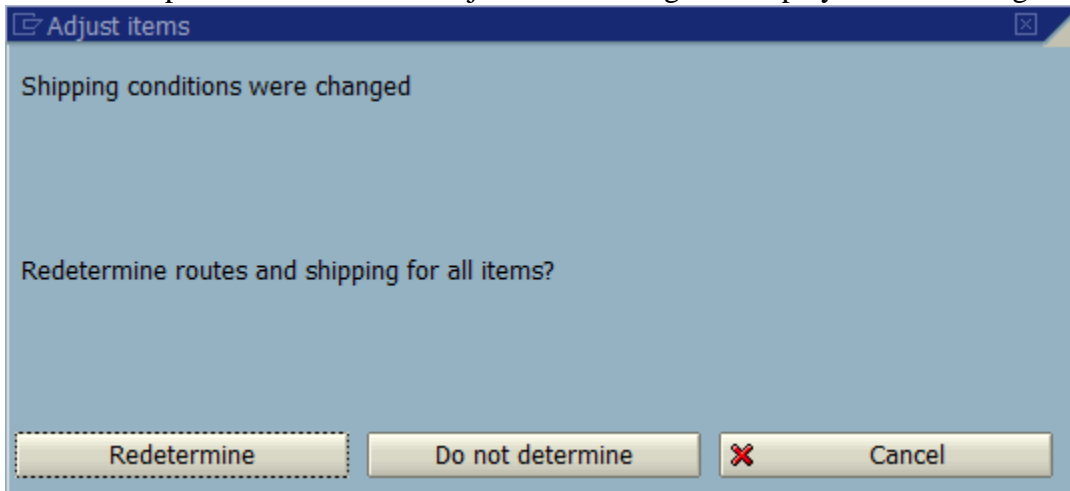

17. Click . The following message displays.

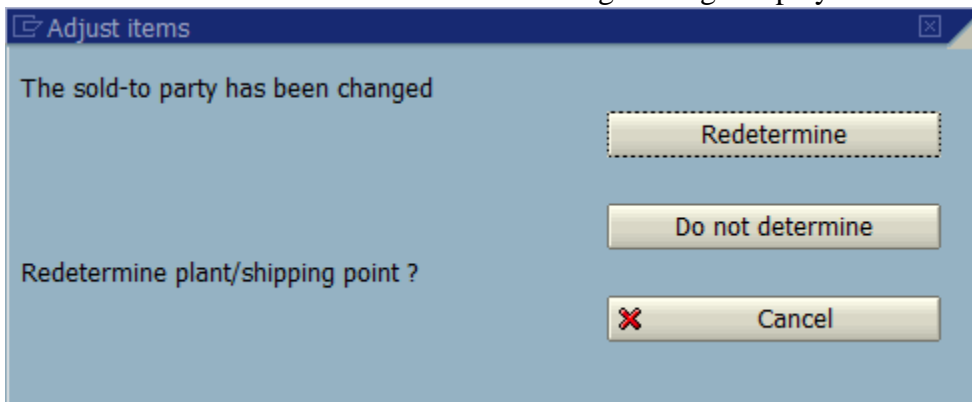

18. Click . The Following message displays:



19. Click  or press **Enter**. The descriptions for the **Sold-To Party** and **Ship-To Party** update to reflect the new owner.

Appendix J

20. Ensure the date in the **Contract start** field is correct.



The date should be the day after the contract end date of the cancelled contract. If the date is incorrect, exit this transaction and review the cancelled contract to ensure it was cancelled with the correct date.

21. Enter the last day of the month prior to the contract start date for year 2030 in the **Contract end** field.



If the contract start date is 6/01/2018, enter 5/31/2030.

22. Click **Enter** to validate your entries and update the **Net value** field.

23. Ensure the Net value in the header is correct.



The **Net value** in the header is the sum of the net values for the line items. The **Net value** of a line item is the price of the material (\$300) multiplied by the number of panels multiplied by the number of years on the contract..

24. Click . The **Create Logo Contract: Header Data** screen displays.

25. Select the **Contract data** tab.

26. Ensure the date the panel was installed displays in the **Installation date** field.

27. Ensure the date the change of ownership document was signed by the Division Engineer or designee in the **Contract signed** field.

28. Select the Partners tab.

29. Double click in the street field for Ship-to party.

30. Enter or change values in the following fields as necessary to reflect the physical location and other details of the business.



Refer to the screen print of information from when the previous contract was cancelled, if available.

- **Name** – BUSINESS NAME

Appendix J

- **Street/House number** – (first field) BUSINESS PHYSICAL ADDRESS



NCDOT does not use the second field.

- **Postal Code/City** – enter the business zip code in the first field, and the CITY in the second field
- **Region** – NC
- **Tax Juris. Code** – TAX JURISDICTION CODE FOR THE BUSINESS PHYSICAL ADDRESS
- **Telephone** – telephone number for the business
- **E-mail** – email address for the business
- **Comments** – any additional contact information for the business

31. Click  or press Enter to close the dialog box.

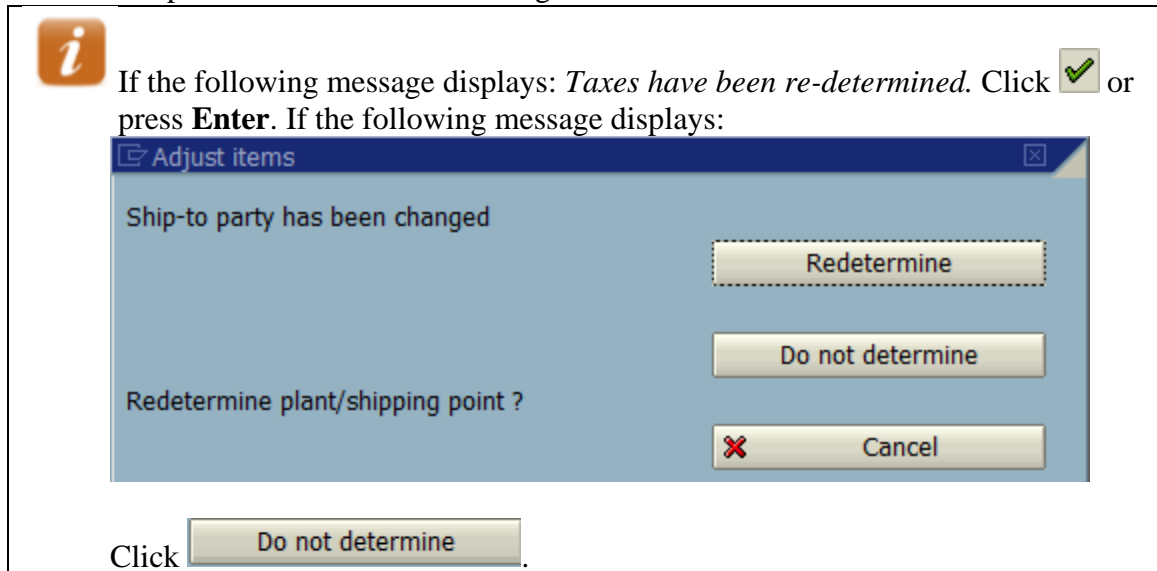

The screenshot shows a dialog box titled "Adjust items" with a blue header and a light blue background. The main text reads: "If the following message displays: *Taxes have been re-determined*. Click  or press **Enter**. If the following message displays:". Below this text is a smaller dialog box titled "Adjust items" with a blue header and a light blue background. The text inside this smaller dialog box reads: "Ship-to party has been changed" followed by a "Redetermine" button, a "Do not determine" button, and a "Cancel" button. Below the "Cancel" button is a question: "Redetermine plant/shipping point ?". At the bottom of the main dialog box, there is a "Do not determine" button with the text "Click" to its left.

32. Click . The **Create Logo Contract: Overview** screen displays.

33. Click . The following message displays:
Logo Contract [number] has been saved

34. Record the contract number on the agreement.

35. Click  to exit this transaction



36. Send Fiscal a copy of the agreement to have scan in SAP

Appendix K

Appendix K

VA42 – Cancel Contract

Use this procedure to cancel all panels on a Logo contract.

1. Enter VA42 in the **Command** field on the **SAP Easy Access** screen.
2. Click  or press **Enter**. The **Change Contract: Initial Screen** displays.
3. Enter the contract number in the **Contract** field.
4. Click  or press **Enter**.



If the Information dialog box displays the following message:
Consider the subsequent documents, documents related to the contract (invoices, credit memos, accounting document, etc.) exist. Typically, if the message does not display; the contract has not been billed.

5. Click  or press **Enter**. The **Change Logo Contract [number]: Overview** screen displays.
6. Review data in the header to ensure the correct contract displays.
7. Follow the menu path Goto → Header → Contract data. The **Change Logo Contract: Header Data** screen displays with the Contract data tab selected.
8. Enter the date the panels were removed in the **Dismantling date** field.



Typically, this is the date on the dismantling work order. If the contract is a duplicate, enter the date the customer notified NCDOT or the current date.

9. Click  in the **Reason for cancel**. Field, then select the reason for cancelling the contract.



Contract not renewed – contract cancelled by customer request
Delinquent payment – contract cancelled due to lack of payment
Other – select when contract is a duplicate



10. Enter one of the following dates in the **Receipt of canc.** field:
 - Date NCDOT received notice of cancellation from the customer (if contract cancelled by the customer request)
 - Date panels were removed (if contract cancelled due to lack of payment)
 - Date the customer notified NCDOT or the current date (when contract is a duplicate or change of ownership)

Appendix K

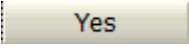

11. Click  or press Enter. The Propose cancellation date dialog box displays.
12. Review the proposed cancellation date to determine if it is correct.

 The proposed cancellation date should be the last day of the most recent contract renewal period for which payment has been received.

If the proposed date is correct, perform the following:

1. Click .
2. Click **Enter** to clear the  **Alter the action if necessary** message.
3. Click  to return to the **Change Logo Contract [number]: Overview** screen.
The proposed cancellation date displays in the **Contract end** field on the **Sales** tab.

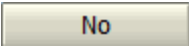
If the proposed date is not correct, perform the following:

1. Click .
2. Click  to return to the **Change Logo Contract [number]: Overview** screen.
3. Enter the last day of the last contract period for which payment was received in the **Contract end** field on the **Sales** tab.
4. Click **Enter**.
5. Click **Enter** to clear the  *Date is in the past* message.

Review Billing Plan Data

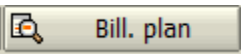
13. Click  to the left of the first line item.
14. Click . The **Change Logo Contract [number]: Item Data** screen displays.

 Do not change information on the **Billing plan** tab.

15. Review the billing plan data for the selected line item.

 The **End date** should be the same as the new date in the **Contract end** field on the **Sales** tab.
No future dates should display in the **Billing date** column and all previous billing dates should have a **BillSt** of C.

Appendix K

16. Click  as necessary to review billing plan data for the next line item.



Review the values in the **Sales Document Item** and **Material** fields in the header to identify the line item.

17. Repeat steps 16 -17 as necessary until the following message displays:

 There are no more items to be displayed

18. Click . The **Change Logo Contract [number]: Overview** screen displays.

Review Sign status

19. Follow the menu path Goto → Header → Additional Data B. The **Change Logo Contract: Header Data** screen displays with the Additional data B tab selected.

20. Review that the **Sign status** field display an **I** (sign is inactive)

21. Click . The **Change Logo Contract [number]: Overview** screen displays.

22. Click . The following message displays:

 *Logo Contract [number] has been saved.*

23. Click  to exit this transaction.

Appendix L

Appendix L

FBL5N – Customer Line Item Display









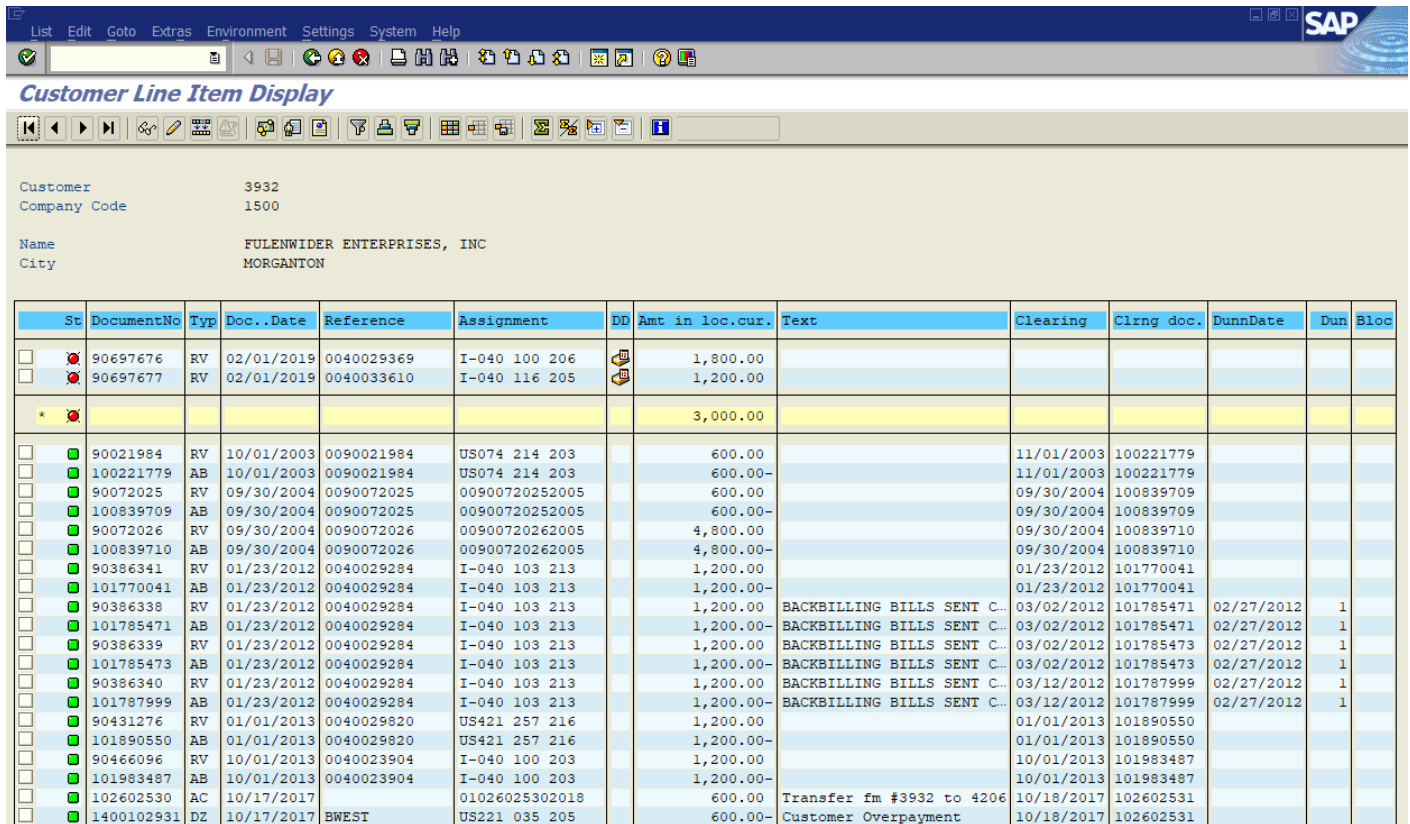















Use this procedure to display images of invoices that are automatically attached to SAP billing documents or to view customer account history.



1. Enter *FBL5N* in the **Command** field on the **SAP Easy Access** screen.
2. Click  or press **Enter**. The **Customer Line Item Display** screen displays.
3. Enter the *customer number* in the **Customer account** field.
4. Select the **All items** button.

 Select the **Open items** radio button to display line items with open balances only.





5. Enter */DUNNING* in the **Layout** field.
6. Click . A list of line items for the customer displays.



St	DocumentNo	Typ	Doc..Date	Reference	Assignment	DD	Amt in loc.cur.	Text	Clearing	Clrng doc.	DunnDate	Dun	Bloc
<input type="checkbox"/>	 90697676	RV	02/01/2019	0040029369	I-040 100 206		1,800.00						
<input type="checkbox"/>	 90697677	RV	02/01/2019	0040033610	I-040 116 205		1,200.00						
	* 						3,000.00						
<input type="checkbox"/>	 90021984	RV	10/01/2003	0090021984	US074 214 203		600.00		11/01/2003	100221779			
<input type="checkbox"/>	 100221779	AB	10/01/2003	0090021984	US074 214 203		600.00-		11/01/2003	100221779			
<input type="checkbox"/>	 90072025	RV	09/30/2004	0090072025	00900720252005		600.00		09/30/2004	100839709			
<input type="checkbox"/>	 100839709	AB	09/30/2004	0090072025	00900720252005		600.00-		09/30/2004	100839709			
<input type="checkbox"/>	 90072026	RV	09/30/2004	0090072026	00900720262005		4,800.00		09/30/2004	100839710			
<input type="checkbox"/>	 100839710	AB	09/30/2004	0090072026	00900720262005		4,800.00-		09/30/2004	100839710			
<input type="checkbox"/>	 90386341	RV	01/23/2012	0040029284	I-040 103 213		1,200.00		01/23/2012	101770041			
<input type="checkbox"/>	 101770041	AB	01/23/2012	0040029284	I-040 103 213		1,200.00-		01/23/2012	101770041			
<input type="checkbox"/>	 90386338	RV	01/23/2012	0040029284	I-040 103 213		1,200.00	BACKBILLING BILLS SENT C...	03/02/2012	101785471	02/27/2012	1	
<input type="checkbox"/>	 101785471	AB	01/23/2012	0040029284	I-040 103 213		1,200.00-	BACKBILLING BILLS SENT C...	03/02/2012	101785471	02/27/2012	1	
<input type="checkbox"/>	 90386339	RV	01/23/2012	0040029284	I-040 103 213		1,200.00	BACKBILLING BILLS SENT C...	03/02/2012	101785473	02/27/2012	1	
<input type="checkbox"/>	 101785473	AB	01/23/2012	0040029284	I-040 103 213		1,200.00-	BACKBILLING BILLS SENT C...	03/02/2012	101785473	02/27/2012	1	
<input type="checkbox"/>	 90386340	RV	01/23/2012	0040029284	I-040 103 213		1,200.00	BACKBILLING BILLS SENT C...	03/12/2012	101787999	02/27/2012	1	
<input type="checkbox"/>	 101787999	AB	01/23/2012	0040029284	I-040 103 213		1,200.00-	BACKBILLING BILLS SENT C...	03/12/2012	101787999	02/27/2012	1	
<input type="checkbox"/>	 90431276	RV	01/01/2013	0040029820	US421 257 216		1,200.00		01/01/2013	101890550			
<input type="checkbox"/>	 101890550	AB	01/01/2013	0040029820	US421 257 216		1,200.00-		01/01/2013	101890550			
<input type="checkbox"/>	 90466096	RV	10/01/2013	0040023904	I-040 100 203		1,200.00		10/01/2013	101983487			
<input type="checkbox"/>	 101983487	AB	10/01/2013	0040023904	I-040 100 203		1,200.00-		10/01/2013	101983487			
<input type="checkbox"/>	 102602530	AC	10/17/2017		01026025302018		600.00	Transfer fm #3932 to 4206	10/18/2017	102602531			
<input type="checkbox"/>	 1400102931	DZ	10/17/2017	BWEST	US221 035 205		600.00-	Customer Overpayment	10/18/2017	102602531			

- In the Status column  means that the invoice has not been paid
- In the Status column  means that the invoice has been cleared either by payment or cancellation.

Appendix L

7. Double click an invoice number in the **Document Number** column. The **Display Document: Line Item [number]** screen displays.
8. Click the right side of  , then select **Attachment list**. The **Service: Attachment list** dialog box displays.
9. Double click the appropriate line item. Example: (Billing document is the invoice, Non-PO Invoice – Scanned Doc., could be a check copy, or Past due letter)
10. Review the document.
11. Click  in the upper right-hand corner to close the attachment screen.
12. Click  to close the Service: Attachment list dialog box.
13. Click  to return to the report.
14. Click  to exit this transaction.



STATE OF NORTH CAROLINA
DEPARTMENT OF TRANSPORTATION

ROY COOPER
GOVERNOR

J.R. "JOEY" HOPKINS
SECRETARY

<<Date>>

Subject: LOGO Signing for service at

Dear M:

Thank you for participating in the LOGO Signing program. Please find enclosed copies of the LOGO agreement, the paid invoice, and check for your records.

If I can provide you with any additional information, please do not hesitate to contact me.

Sincerely,

James A. Jamison
LOGO/TODS Coordinator
Engineering Tech, IV
Enclosures ()

cc: File

Appendix M



STATE OF NORTH CAROLINA
DEPARTMENT OF TRANSPORTATION

ROY COOPER
GOVERNOR

J.R. "JOEY" HOPKINS
SECRETARY

July 6, 2018

Jack in the Box
Attn: Kathy Lama
9357 Spectrum Center Blvd.
San Diego, CA 92123

Subject: LOGO Signing for FOOD service at US 321 Exit 12B

Dear Ms. Lama

Thank you for participating in the LOGO Signing program. Please find enclosed the invoice for the first year LOGO program fees. Future billing will occur each year thirty (30) days prior to the month your LOGO agreement began. Please send payment for the program fees to my office for processing in the form of a check made payable to the Department of Transportation. Once the Department receives the check, we will schedule the LOGO panel installation, and I will make copies and send to you for your records.

Thanks again for participating in the LOGO program. If I can provide you with any additional information, please do not hesitate to contact me.

Sincerely,

James A. Jamison
LOGO/TODS Coordinator
Engineering Tech, IV

Enclosures ()

cc: File

Mailing Address:
NC DEPARTMENT OF TRANSPORTATION
DIVISION 12
PO BOX 47
SHELBY, NC 28151-0047

Telephone: (980) 552-4200
Fax: (704) 480-5401
Courier: 06-53-03
Website: www.ncdot.gov

Location:
1710 E. MARION STREET
SHELBY, NC 28152



STATE OF NORTH CAROLINA
DEPARTMENT OF TRANSPORTATION

ROY COOPER
GOVERNOR

J. R. "JOEY" HOPKINS
SECRETARY

February 28, 2019

Table 31
Attn: Kathy J. Updike
19918 North Cove Rd
Cornelius, NC 28031

Subject: LOGO Signing for FOOD service at I-77 Exit 31

Dear Ms. Updike

Thank you for contacting us about the LOGO Signing program. Please find enclosed copies of the LOGO Rules, LOGO Agreement, Qualification Survey, Sign Requirements, and a list of sign suppliers. Please fill out the forms and return to my office for processing. Once I receive the forms, I will review for approval. After approval, I will contact you about ordering your signs.

If I can provide you with any additional information, please do not hesitate to contact me.

Sincerely,

James A. Jamison
LOGO/TODS Coordinator
Engineering Tech, IV

Enclosures (7)

cc: File

Appendix N

STANDARD SIX PANEL RAMP LOGO SIGN

