

NORTH CAROLINA DEPARTMENT OF
TRANSPORTATION

MANUAL FOR CONSTRUCTION LAYOUT



Acknowledgements

Revised 9/01/2018

In order to establish minimum standards for construction layout and uniformity in staking procedures, the North Carolina Department of Transportation developed this Construction Layout Manual.

The Department would like to thank the many people who participated in the development of this document. A special thank you is extended to all Division Construction offices that assisted with the reviewing and editing process, to the Location and Surveys Unit, and to Summit Design and Engineering for their efforts in updating the Manual.

The Manual for Construction Layout was edited and published by the North Carolina Department of Transportation, Construction Unit. If you have any comments or questions regarding this Manual, contact the Construction Unit.

Corrections Sheet

By using the corrections sheet you will help NCDOT improve future instructional material. Please read the following instructions before going any further.

INSTRUCTIONS:

1. As you use these guidelines, record mistakes and/or printing errors when you encounter them.
2. Once you have recorded any mistakes and/or printing errors, return this sheet to the address at the bottom of the page.
3. Do not use this sheet for asking questions or making comments that require a reply; please write a separate letter for such questions or comments.

I have noted the following mistakes and/or printing errors:

Page	Paragraph	Remarks
------	-----------	---------

Use the opposite side of this page if necessary.

Please mail this sheet to:

**North Carolina Department of Transportation Construction Unit
Assistant State Construction Engineer
1543 Mail Service Center Raleigh, NC 27699-1543
CCU@ncdot.gov**

Preface

Contract Surveyors play an important role in constructing safe, efficient, economical and durable transportation facilities. The North Carolina Department of Transportation (NCDOT) believes the current trend of providing Prime Contractors the responsibility of surveying their own projects, will continue well into the future. By developing a standard Manual for Construction Layout, NCDOT establishes consistency in construction layout and staking procedures to be used by all department contractors. The use of these uniform procedures will result in fewer construction stakeout errors and problems resulting from such errors.

These standards and procedures were established by a technical advisory committee consisting of NCDOT and contractor personnel.

You, the Contract Surveyor, are expected to review these guidelines, consider them in the compilation of your bid and apply them to your daily surveying operations.

Introduction

The purpose of the Manual for Construction Layout is to familiarize Contract Surveyors with the standards and procedures required to survey and stake a NCDOT project. The majority of construction layout procedures encountered during a typical project are detailed within this manual. If an item is not included, contact the Resident Engineer administering the project for the appropriate procedure.

Construction Surveying is essential to completing a high quality and economical project. The Contract Surveyor is involved in construction layout at all stages of the project, from verifying initial control points through project completion. By knowing and understanding the standards and procedures for construction layout, the Contract Surveyor helps to improve the overall quality, productivity and profitability of the project.

In any successful partnership, effective communication is vital. The partnership between the Contract Surveyor and the Resident Engineer's surveying staff is no different. Everyone involved with the project must communicate effectively to increase overall understanding of both the information being established in the field and submitted for review.

NCDOT realizes that the effectiveness of this manual is an important element in the construction layout of a project. If, while surveying a department project, you develop a more efficient procedure, please submit it to the Construction Unit. The Construction Unit will evaluate its viability for inclusion in the next revision of this manual. Please note that written approval should be provided by the Resident Engineer if a deviation from this manual is proposed.

Reference Materials

In addition to the Manual for Construction Layout, you should have access to the following:

- Standard Specifications for Roads and Structures
- Roadway Standard Drawings
- Project contract and plans
- Any and all revisions for the project

Table of Contents

Acknowledgements	ii
Corrections Sheet	iii
Preface.....	iv
Introduction.....	v
Chapter 1	1
General Information.....	1
1.1 General Information	1
1.2 Safety.....	1
1.3 Required Submittals.....	2
1.4 Preconstruction Survey Meeting.....	3
Chapter 2	4
Staking Control Points	4
2.1 General Information	4
2.2 Verifying Control Points.....	4
2.3 Referencing Control Points.....	4
2.4 Submittal Requirements	4
2.5 Type of Stakes	5
2.6 Staking Accuracy	5
Chapter 3	8
Centerline Stakes	8
3.2 Guideline Information.....	8
3.3 Type of Stake	8
3.4 Stake Information.....	8
Chapter 4	9
Orange Safety Fence.....	9
4.1 General Information	9
4.2 Guideline Information.....	9
4.3 Type of Stake	9
Chapter 5	10
Clearing Limits.....	10
5.1 General Information	10
5.2 Guideline Information.....	10
5.3 Submittal Requirements	10
5.4 Type of Stake	10
5.5 Stake Information.....	10
Chapter 6	15
Slope Stakes	15
6.1 General Information	15
6.2 Guideline Information.....	15
6.3 Submittal Requirements	15
6.4 Type of Stake	15
6.5 Stake Information.....	15
Chapter 7	17
Ditch Stakes	17
7.1 General Information	17
7.2 Guideline Information.....	17

7.3 Type of Stake	17
7.4 Stake Information.....	17
Chapter 8	19
Pipe Stakes	19
8.1 General Information	19
8.2 Guideline Information.....	19
8.3 Submittal Requirements	19
8.4 Type of Stake	20
8.5 Stake Information.....	20
Chapter 9	22
Minor Structure Stakes	22
9.1 General Information	22
9.2 Guideline Information.....	22
9.3 Type of Stake	22
9.4 Stake Information.....	22
Chapter 10	26
Endwall Stakes	26
10.1 General Information	26
10.2 Guideline Information.....	26
10.3 Type of Stake	26
10.4 Stake Information.....	26
Chapter 11	29
Intermediate Grade Stakes	29
11.1 General Information	29
11.2 Guideline Information.....	29
11.3 Type of Stake	29
11.4 Stake Information.....	29
Chapter 12	30
Curb Stakes	30
12.1 General Information	30
12.2 Guideline Information.....	30
12.3 Submittal Requirements	30
12.4 Type of Stake	30
12.5 Stake Information.....	30
Chapter 13	32
Fence Line Stakes.....	32
13.2 Guideline Information.....	32
13.3 Type of Stake	32
13.4 Stake Information.....	32
Chapter 14	34
Fine Grade Hubs	34
14.1 General Information	34
14.2 Guideline Information.....	34
14.3 Submittal Requirements	34
14.4 Type of Stake	34

14.5 Stake Information.....	34
Chapter 15	38
Right-of-Way Markers	38
15.1 Guideline Information.....	38
15.2 Submittal Requirements	38
15.3 Type of Stake	39
15.4 Stake Information.....	39
Chapter 16	41
Signs	41
16.1 General Information	41
16.2 Guideline Information.....	41
16.3 Submittal Requirements - Overhead Signs (Structures)	41
16.4 Submittal Requirements - Ground Mounted Signs (Type A and B)	42
16.5 Submittal Requirements - Ground Mounted Signs (Type D, E and F)	42
16.6 Type of Stake	43
16.7 Stake Information.....	43
Chapter 17	49
Major Structure Stakes	49
17.1 Guideline Information.....	49
Bridge Stake Out.....	49
Cored Slab and Box Beam Overlays.....	50
Culvert Stake Out.....	50
Wall Stake Out	51
17.2 Submittal Requirements	51
17.3 Type of Stake	51
Chapter 18	57
Cross-sections for Earthwork Quantities	57
18.1 General Information	57
18.2 Guideline Information.....	57
18.3 Type of Stake	57
Chapter 19	59
Automated Machine Guidance	59
19.1 General Information	59
19.2 Subgrade and Base Controls	59
19.3 Submittal Requirements	60
Chapter 20	61
GPS.....	61
20.1 General Information	61
Appendix.....	62
Report of Final R/W and Permanent Easement Survey.....	63



Chapter 1

General Information

1.1 General Information

Perform all construction layouts in accordance with this manual, the current edition of the Standard Specifications for Roads and Structures (Section 801), and the project Contract (unless otherwise approved or directed).

Set all types of stakes at intervals of 50 feet (20 meters) unless otherwise detailed or directed. Intervals may be adjusted by the Engineer to properly construct the project.

Reference all elevations to the finished grade.

Accuracy is a degree of conformity with a standard or accepted value. According to *Definitions of Surveying and Associated Terms*, accuracy relates to the quality of a result, and is distinguished from precision which relates to the quality of the operation by which the result is obtained. The accuracy ratio shall not exceed an error of closure of 1 foot per 20,000 feet (1 meter per 20,000 meters) of perimeter for all control and structure surveys and 1 foot per 10,000 feet (1 meter per 10,000 meters) of perimeter for all other horizontal surveys. The accuracy for vertical surveys shall not exceed

$$0.05ft. \sqrt{(x)miles} \quad (15.24mm \sqrt{0.62137(x)km})$$

for control and structure surveys, and

$$0.10ft. \sqrt{(x)miles} \quad (30.48mm \sqrt{0.62137(x)km})$$

for all other vertical surveys.

The Contractor shall provide the Department with the type of equipment and manufacturer's information for the equipment being used for construction surveying. The standard GPS equipment only has an accuracy GPS of 0.1 feet. GPS equipment, therefore, is currently limited in its use for layout in regard to accuracy. Robotic equipment should be utilized for most stakeouts to ensure that the required precision is met when electronic equipment is used for layout. The precision for surveying each operation is detailed within this manual.

1.2 Safety

The number one concern in construction stakeout is ensuring that all work is conducted in a safe manner. Proficiency, accuracy and timeliness should never take precedence over safety of the crew and/or public. The consequences of any accident, no matter how minor, cannot be justified by the desire to complete work within a given schedule. Remember, when operating in a hazardous area, the top priority is the safety of

each individual, equipment is secondary.

The stakeout crew is exposed constantly to moving vehicles and equipment on the construction site. Earthmoving equipment can dwarf a survey crew member, making it difficult for the equipment operator to see the individual standing on the ground. Therefore, one should always notify the Contractor of his/her intended area of operation and the expected time period of occupancy. Crew members should be alert for backing equipment. When one is setting stakes, it is recommended to have a standing person close by to make the operation more visible and act as the eyes of the stake driver. If working beneath a construction operation, each crew member should wear an approved safety helmet. In some cases, the Prime Contractor may require the use of safety helmets while performing work within the project limits.

When stakeout is required adjacent to active travel lanes, extreme caution should be taken to protect the crew from oncoming traffic. Each member of the crew should stay alert and watch for potential hazardous situations. In addition, the appropriate traffic control measures should be installed. The Contractor shall assist Department personnel with traffic control when survey layouts are being verified.

Work vehicles must always use warning lights with at least 50% being amber in color attached to the vehicle as high as possible and in a manner such that they are not obscured by equipment or supplies. Vehicle hazard signals or lights may be used to supplement this requirement. This requirement applies to all work vehicles and equipment not inside lane closures or behind barriers. (1101-5). Vehicle should be parked in the safest location possible.

1.3 Required Submittals

Submit the following information to the Engineer for review and approval. Submittals should be sent as a pdf unless otherwise noted. Detailed information for submittals is provided in related sections in this manual.

- 1) A printout of horizontal verification, as well as coordinates, differences and error of closure.
- 2) A printout of vertical control verification, with benchmark location elevations, and differences from plan elevations.
- 3) Sketch of location of newly referenced horizontal control, with text printout of coordinates, method of reference and field notes associated with referencing control.
- 4) Description of newly established benchmarks with location, elevation and closed loop survey field notes.
- 5) The proposed method for recording information in field books to ensure clarity and adequacy.
- 6) All updated electronic and manuscript survey records on a monthly basis.
- 7) Clearing Points in Environmentally Sensitive Areas (Permitted Sites) prior to clearing
- 8) Layout drawings for all utility construction systems.
- 9) Layout drawings for all drainage systems.
- 10) Layout drawing for each structure and culvert.
- 11) Bridge layout drawing with coordinates and control points prior to field layout
- 12) Computations for buildups over beams, screed grades and overhang form elevations.
- 13) Sign S-Dimension information on an 11 ½ inch x 17 inch drawing depicting the theoretical finished section at each proposed overhead sign assembly location.
- 14) Coordinate data showing differences between supplied baseline coordinates and field obtained GPS coordinates, including report detailing preliminary input data.
- 15) Any proposed plan alteration to rectify a construction stakeout error, including design calculations, narrative and sealed drawings.
- 16) Validation of right-of-way marker locations.

- 17) Alignment of baseline for each borrow pit location.
- 18) Detailed sketch of proposed overhead and Type A and B ground mounted sign locations along with any obstructions that may interfere with installation.
- 19) Site Calibration Report
- 20) Digital Terrain Model
- 21) AMG Work Plan

As noted in items 5 and 6 above, submit proposed method for setting up survey books or electronic data files to the Engineer before beginning work to assure clarity and adequacy. Promptly make available to the Engineer all requested survey records. Provide updates to the Engineer monthly of the electronic and/or manuscript survey records. Submit remaining records upon completion of the work. Attest the work was performed in accordance with the contract by providing all receivable information signed by an engineer or land surveyor licensed by the State of North Carolina and in responsible charge.

Furnish personnel who are experienced in highway construction surveying and are capable of accurately establishing all line and grade points necessary to complete the work in accordance with the plan dimensions within the precision established in this *Manual for Construction Layout*. Consult the Engineer for clarifications of the plans. Submit list of qualified personnel to the Engineer.

When the Contractor proposes an alteration to the plans to rectify a construction stakeout error, submit alterations to the Engineer for review and approval. Include design calculations and drawings sealed by an engineer licensed by the State of North Carolina along with a narrative describing justification for the alteration.

1.4 Preconstruction Survey Meeting

Prior to commencing surveying operations on the project and separate to the project preconstruction meeting, a preconstruction survey meeting shall be held.

The meeting should include topics regarding expectations and requirements for submittals, where submittals should be sent for review and who will be reviewing the submittals, review of this manual, anticipated methods for rough and fine grading, the type of equipment and manufacturer's information for the equipment being used for construction surveying, list of qualified personnel performing survey work and the Responsible in Charge for survey layout, and conformity to this manual of labeling stakes.

The Contractor should bring the following to the Preconstruction Survey Meeting:

- a) Any required rover or equipment to be supplied to the Department
- b) List of qualified personnel performing survey work and Responsible in Charge
- c) Any requested survey methods deviating from the manual for the Department's review
- d) Method of staking control points



Chapter 2

Staking Control Points

2.1 General Information

The initial control is the foundation from which the entire project will be surveyed. Therefore, it is critical to establish accurate control. The Department strives to provide accurate baseline control. The expectation is that the Contract Surveyor will easily be able to verify the Department's control within the specified accuracy, and will preserve such accuracy in referencing the control outside the project limits.

2.2 Verifying Control Points

Horizontal Control

Verify the Department's horizontal control by performing a closed traverse of the baseline control points. All baseline control points should be occupied. Notify the Engineer in writing of any discrepancies in the horizontal control. The Engineer should provide written direction before control points, which do not validate within the specified accuracy, are utilized.

Vertical Control

Verify the Department's vertical control by performing a closed loop survey utilizing differential leveling. Notify the Engineer, in writing, of any discrepancies in the vertical control.

2.3 Referencing Control Points

Horizontal Control

Approved methods for referencing horizontal control points shall include a minimum of three (3) points and one (1) angle. An offset baseline traverse is an approved method for referencing horizontal control. (See *Figure 2.1.*)

Vertical Control

An approved method for referencing vertical control is to establish a new benchmark by performing a closed loop survey utilizing differential leveling.

2.4 Submittal Requirements

Submit to the Engineer a printout of the control verification, as well as coordinates, differences and error of closure.

Submit to the Engineer a sketch showing location of new control, a text printout of coordinates, the method of reference and the field notes associated with referencing control.

Submit to the Engineer a printout of all benchmarks with locations, elevations and differences from plan elevations.

Submit to the Engineer a description of the new benchmark, location, elevation and closed loop survey field notes. (See *Figure 2.2.*)

As new control points are established, a list of all control points shall be submitted on a weekly basis to the Engineer.

2.5 Type of Stakes

Recommended Stake Size: 60D nail or 18" #5 rebar for horizontal control point ¾" x 1 ¾" x 36" for guard stake. Railroad spikes may be used for vertical control or other approved points. A paint mark will not be acceptable. A ¾" x 1 ¾" x 18" stake should accompany the benchmark with the elevation information legibly written upon it.

Coordinates and elevation shall be written on the side of guard stakes.

Required equipment to be used: Robot (total station).

2.6 Staking Accuracy

Horizontal Control

The accuracy ratio shall not exceed an error of closure of 1 foot per 20,000 feet (1 meter per 20,000 meters) of perimeter (1:20,000).

Vertical Control

The error of closure shall not exceed $0.05\text{ft}\cdot\sqrt{(x)\text{miles}}$ ($15.24\text{mm}\cdot\sqrt{0.62137(x)\text{km}}$)

METHODS OF REFERENCING HORIZONTAL CONTROL

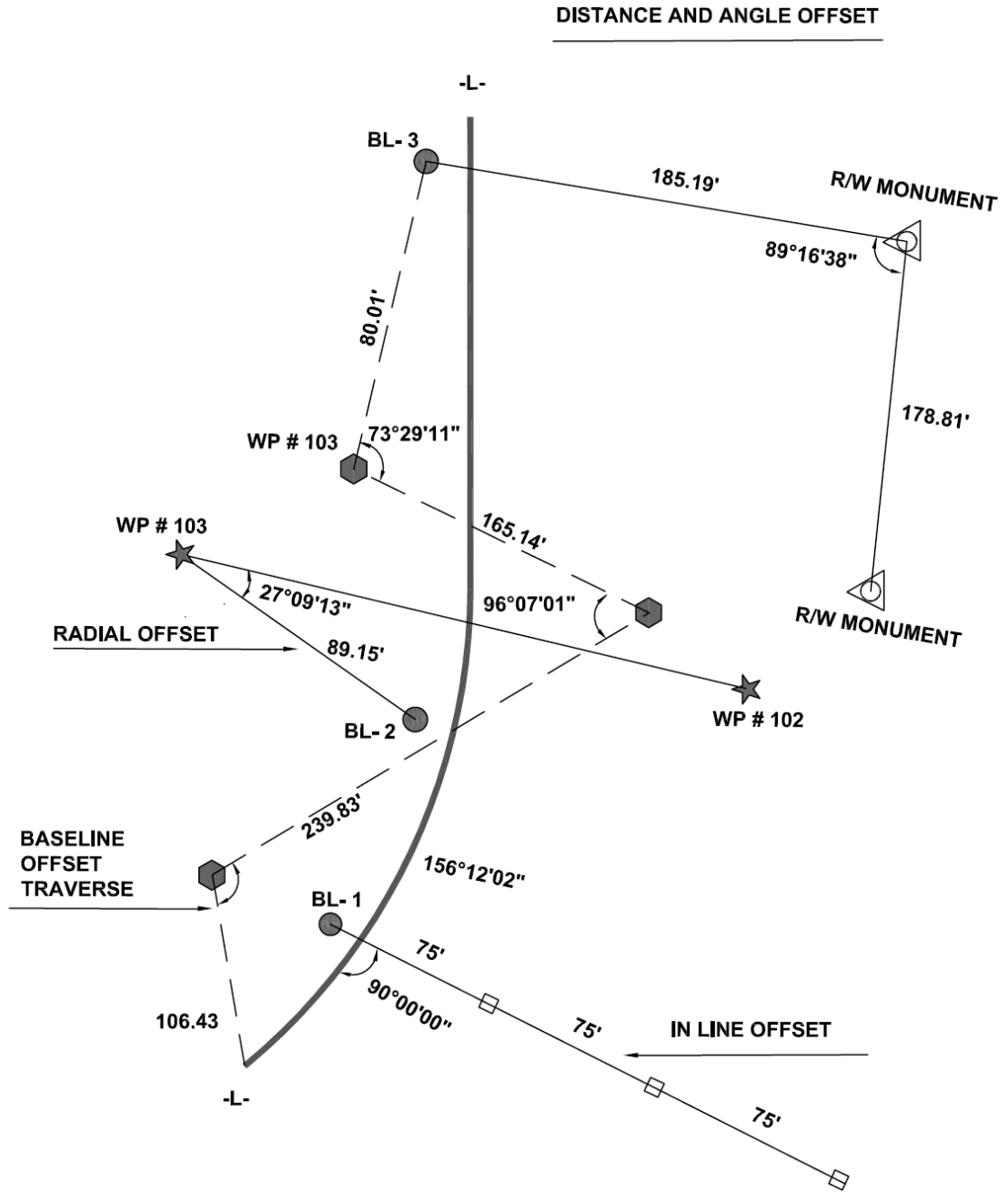
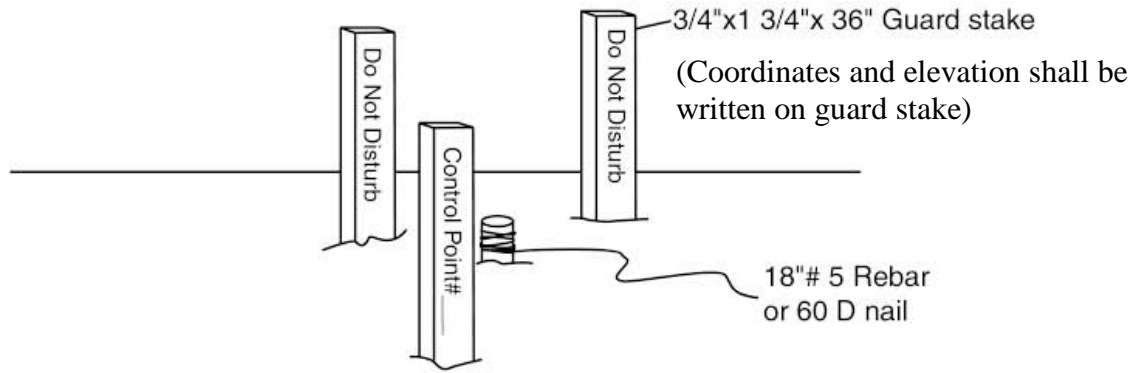

Figure 2.1

Referencing Horizontal Control



Referencing Vertical Control

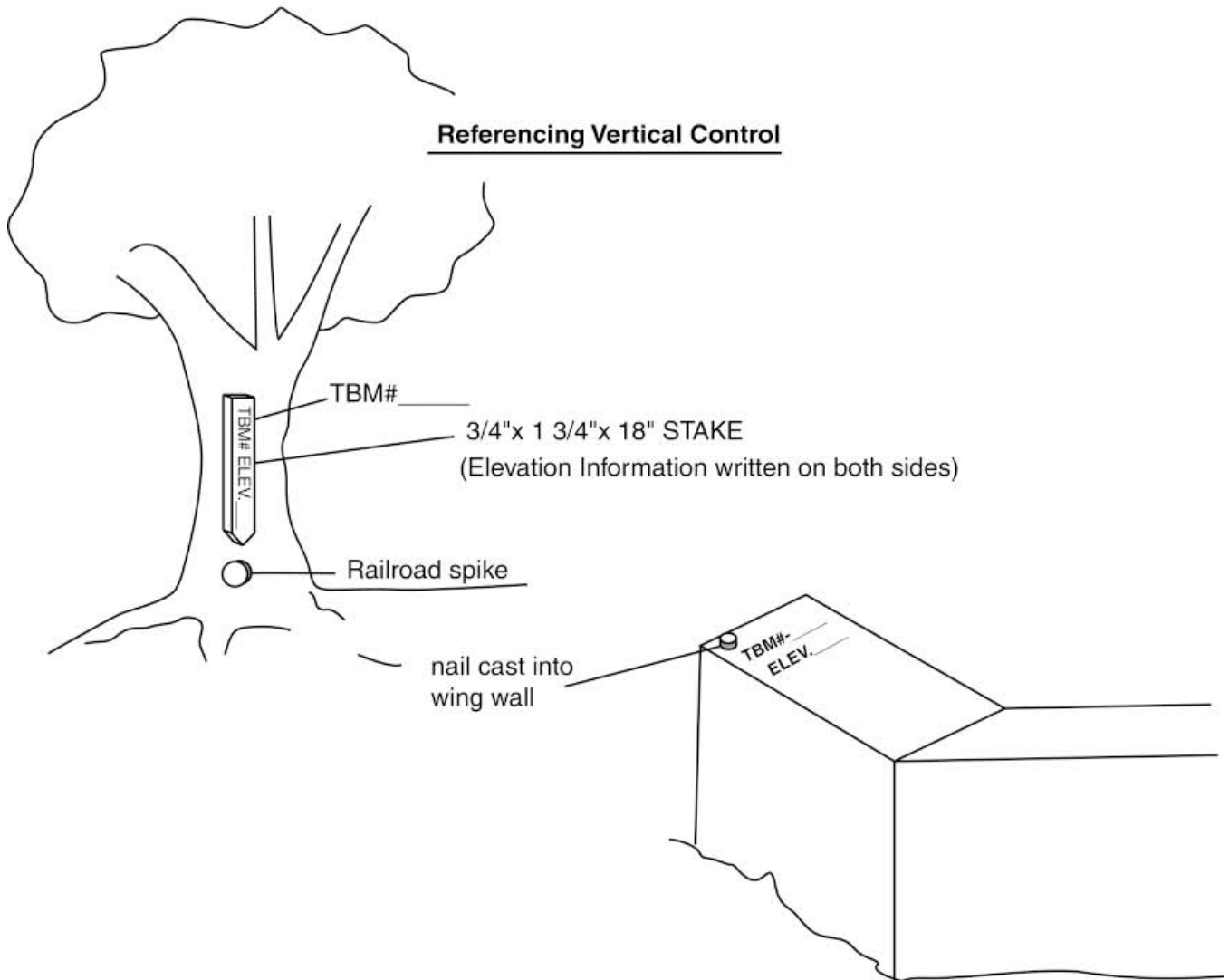

Figure 2.2



Chapter 3

Centerline Stakes

3.1 General Information

With today's technology and the use of baseline surveys, the need to install centerline stakes has diminished. However, there are different types of projects across North Carolina which, for various reasons, may require the installation of centerline stakes. If the centerline is inaccessible, an offset line may be required.

3.2 Guideline Information

Set centerline stakes at 50 foot (20 meter) intervals, including all cardinal points (TS, SC, CS, SC, equalities, etc.)

3.3 Type of Stake

Recommended Stake Size: 3/4" x 1 3/4" x 18"

Recommended Flagging: Orange

Precision: Horz. 0.1'

Stake Use: Location and Information

3.4 Stake Information

The information described below is detailed in *Figure 3.1*.

1. Station number
2. Offset (if necessary)
3. Designation of alignment

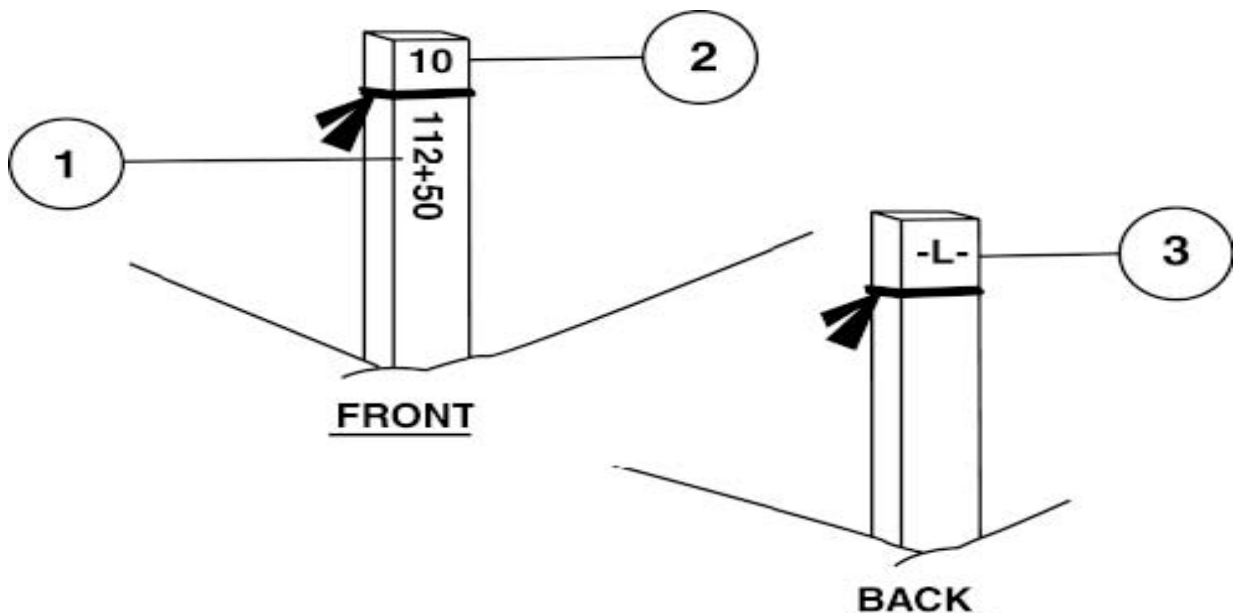

Figure 3.1



Chapter 4

Orange Safety Fence

4.1 General Information

Provide construction stakes to establish the locations of the safety fence along the outside riparian buffer, wetland, water boundary or other boundaries located within the construction corridor as shown on the permit drawings. Coordinates for the limits of the permitted area can be obtained from the Engineer.

Provide wooden stakes on 25-foot maximum intervals with flagging attached to delineate the interior boundaries of all jurisdictional areas. Interior boundaries may be staked on a tangent that runs parallel to the buffer but must not encroach on the buffer at any location. Interior boundaries of hand clearing areas shall be identified with a different colored flagging to distinguish it from mechanized clearing.

Requirements for flagging and layout are shown in the Clearing Limits section, Chapter 5.

4.2 Guideline Information

Utilize Contract Permit Drawings, Permit Stakeout Drawings (see Appendix), Erosion Control Plans, Standard Drawings, Roadway Plans, Erosion Control Design and Sediment Control Manual, Utility Construction Plans and Project Cross-Sections in establishing the location of the Orange Safety Fence.

4.3 Type of Stake

Recommended Stake Size: $\frac{3}{4}$ " x 1 $\frac{3}{4}$ " x 48"

Recommended Flagging: Orange

Precision: Horz. 0.1ft.

Stake Use: Location



Chapter 5

Clearing Limits

5.1 General Information

One of the initial operations on a new project is to establish the limits for clearing and grubbing, which prepares the project for grading within the construction limits.

Safety fence, wetland flagging, permit flagging and stakes, slope stakes, and all necessary boundary staking shall be installed for all permitted areas prior to clearing and in accordance with Table 5.1 and the Figures 5.2 through 5.4.

5.2 Guideline Information

Utilize Erosion Control Plans, Utility Construction Plans, Contract Permit Drawings, Roadway Plans, Standard Drawings, Erosion Control Design and Sediment Control Manual, and Project Cross-Sections in establishing clearing limits. In critical areas such as wetlands, condemned parcels and any other areas deemed necessary by the Engineer, install slope stakes prior to establishing clearing limits. Flagging tape may be tied on stable trees to supplement the clearing stakes. Retain the clearing stakes throughout the clearing and grubbing operation.

5.3 Submittal Requirements

1. Clearing Points in Environmentally Sensitive Areas (Permitted Sites) prior to any clearing on project.
2. Clearing points for areas prior to clearing.
3. Submit electronic clearing points as text file (.txt) or comma-separated values (.csv) file

5.4 Type of Stake

Recommended Stake Size: $\frac{3}{4}$ " x 1 $\frac{3}{4}$ " x 36"

Recommended Flagging: Blue and White Striped

Precision: Horz. 1.0 unless slope staking is required, then Horz. 0.1'

Stake Use: Location

5.5 Stake Information

The information described below is detailed in *Figure 5.1*.

1. Denotes type of stake (clearing limits)
2. Station

CLEARING LIMITS

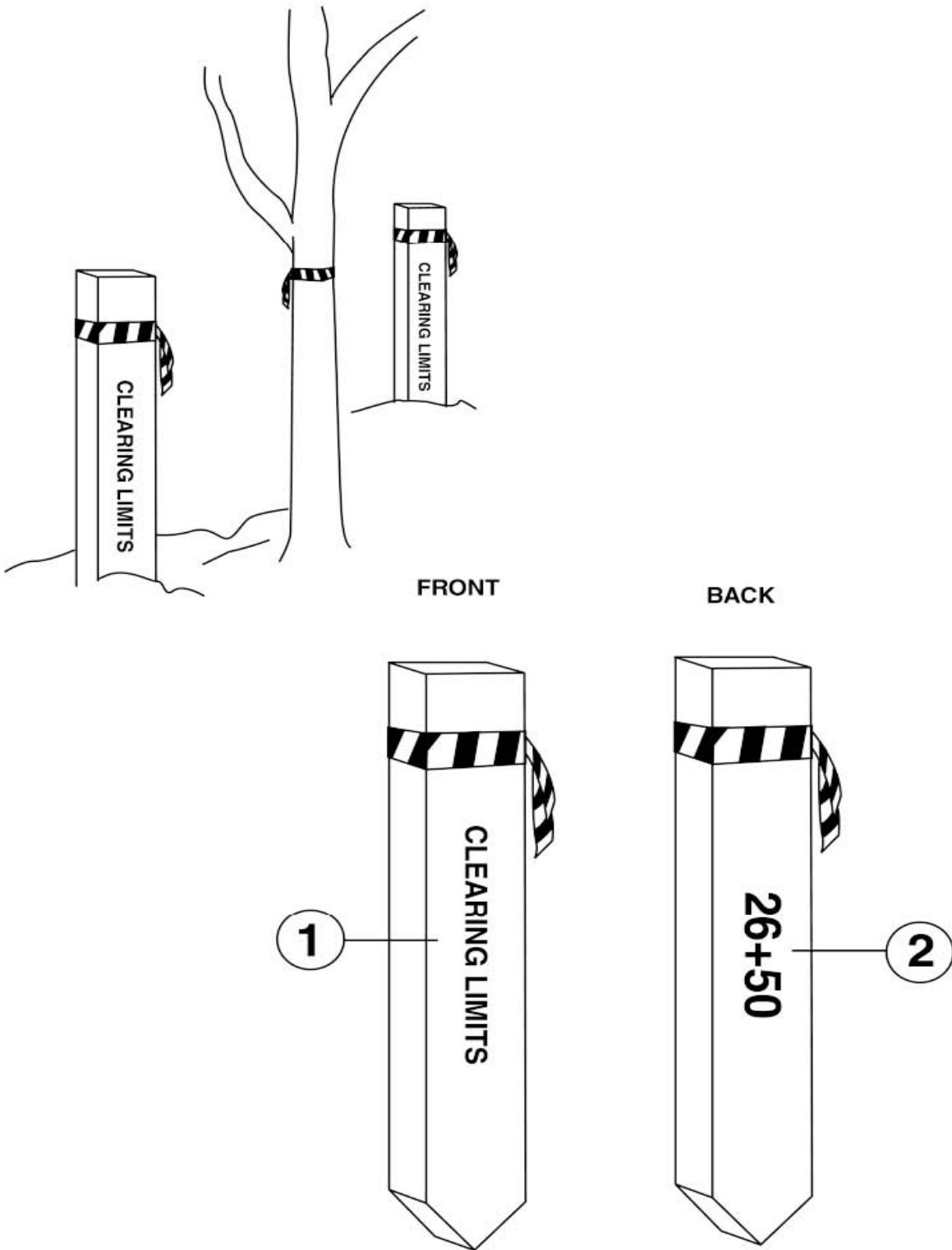





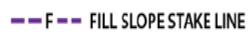

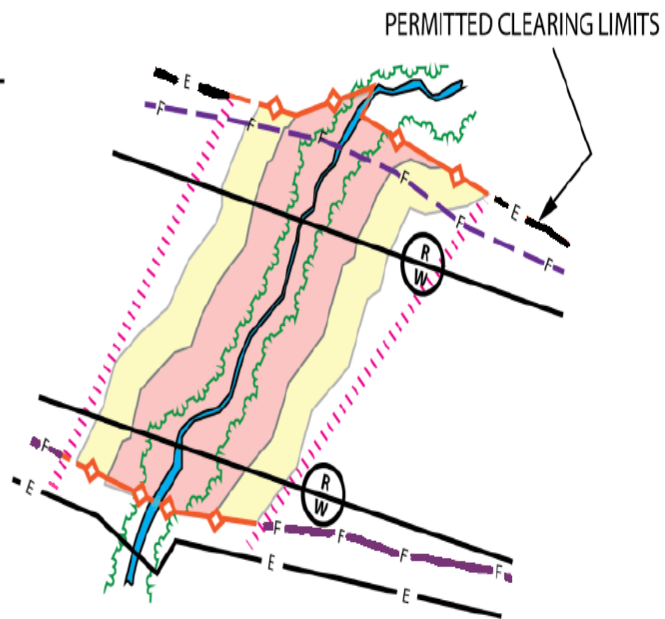

Figure 5.1







JURISDICTIONAL FLAGGING PLAN VIEW (NOT TO SCALE)

JURISDICTIONAL AREA -
RIPARIAN BUFFER ZONE LAYOUT

-  SAFETY FENCE (SF)
-  JURISDICTIONAL FLAGGING (JF)
-  ALLOWABLE IMPACTS ZONE 1
-  ALLOWABLE IMPACTS ZONE 2
-  EASEMENT
-  FILL SLOPE STAKE LINE
-  RIGHT-OF-WAY BOUNDARY



LAYOUT FOR JURISDICTIONAL AREA - RIPARIAN BUFFER ZONE

-  SAFETY FENCE (SF)
-  JURISDICTIONAL FLAGGING (JF)
-  EASEMENT
-  FILL SLOPE STAKE LINE
-  RIGHT-OF-WAY BOUNDARY
-  ENVIRONMENTALLY SENSITIVE AREAS (ESA)

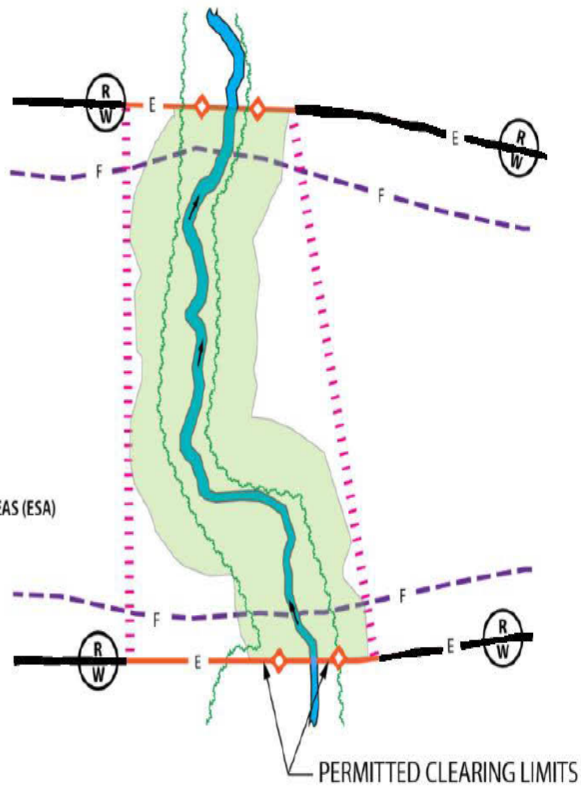

LAYOUT FOR JURISDICTIONAL STREAM - ESA WITHOUT RIPARIAN BUFFERS

Figure 5.2

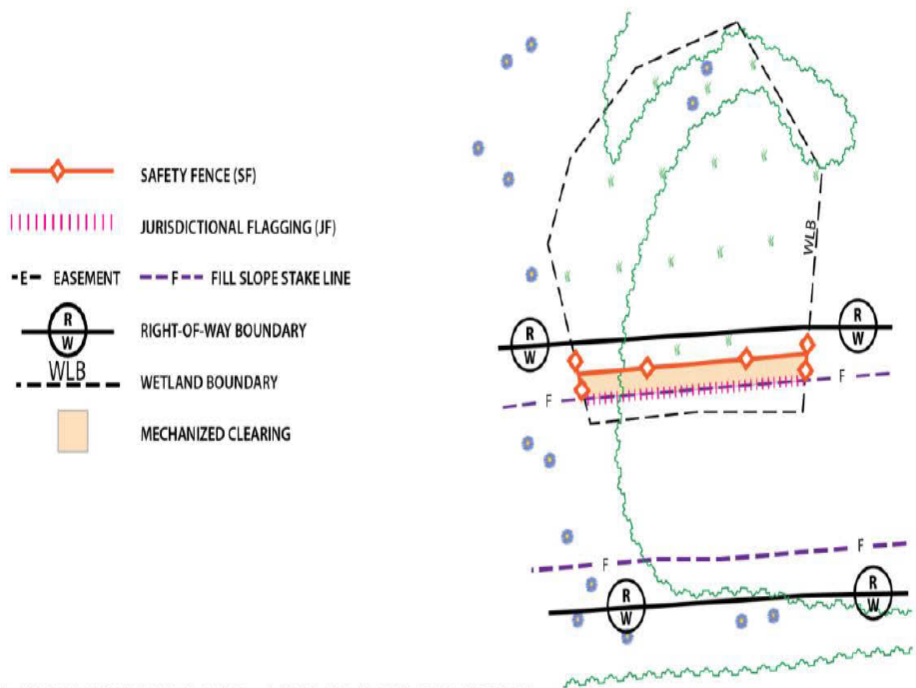

LAYOUT FOR WETLAND - MECHANIZED CLEARING*

* - REFER TO PERMIT DRAWINGS FOR JURISDICTIONAL BOUNDARIES

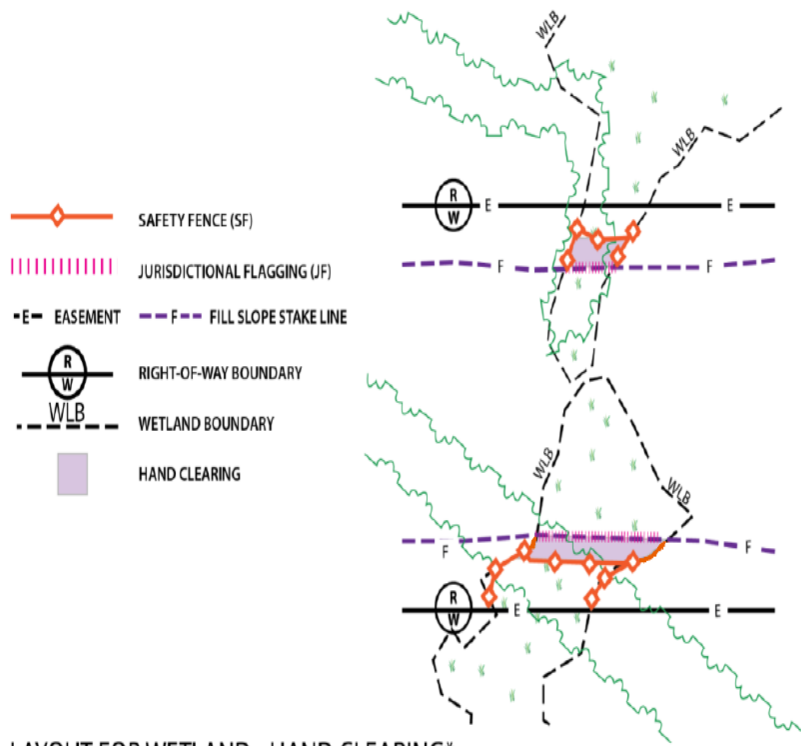

LAYOUT FOR WETLAND - HAND CLEARING*

* - REFER TO PERMIT DRAWINGS FOR JURISDICTIONAL BOUNDARIES

Figure 5.3

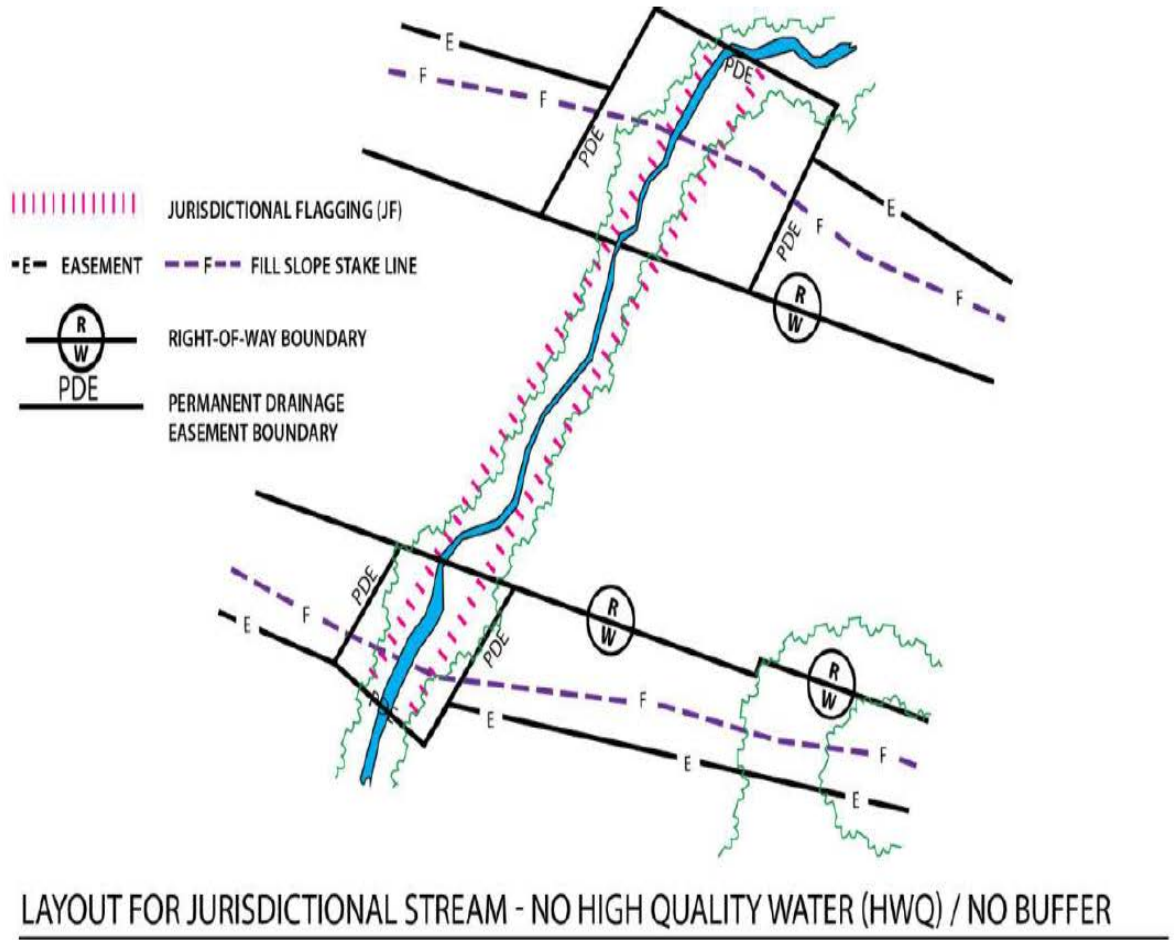

Figure 5.4

Table 5.1

Jurisdictional Flagging

Stakes	<ul style="list-style-type: none"> Place the stakes on a maximum of 25-foot intervals. Attach highly visible orange flagging. Install the posts a minimum of 2 feet into the ground. Stake interior boundaries on a tangent running parallel to the buffer, but do not encroach on the buffer at any location.
Flagging	<ul style="list-style-type: none"> Interior boundaries of hand clearing should be identified with a different colored flagging to distinguish them from mechanized clearing. Flagging should be installed in accordance with Sections 105-9 or 801-1 of the Standard Specifications. Delineation of jurisdictional boundaries at staging areas, waste sites or borrow pits should be performed in accordance with subsections 230-4(B)(5) or 802-2(F) of the Standard Specifications.



Chapter 6

Slope Stakes

6.1 General Information

Before beginning earthwork construction, the limits of the cuts and fills must be identified for equipment operators. Slope stakes establish the intersection of either the top of cut or the toe of fill with the natural ground. They also reference the centerline location and quantify the depth of material to be excavated or placed. Slope stakes should remain in place until the slopes are completed, inspected and permanently seeded.

6.2 Guideline Information

Install slope stakes with a minimum offset distance of 10 feet (3 meters). Slope stakes shall not be scaled from the plans or determined from plan cross sections. Instead, they should be determined mathematically in the field prior to grading operations.

If a hinge point is detailed, set the slope stake to the hinge point. Otherwise, set the slope stake to the shoulder point or ditchline.

6.3 Submittal Requirements

1. Copy of slope stake field book

6.4 Type of Stake

Recommended Stake Size: $\frac{3}{4}$ " x 1 $\frac{3}{4}$ " x 18"

Recommended Flagging: Orange

Precision: Horz. 0.1', Vert. 0.1'

Stake Use: Information and Location

6.5 Stake Information

The information described below is detailed in *Figure 6.1*.

1. Offset distance (horizontal distance between catch point and slope stake)
2. Total fill or cut from the base point to intercept point with natural ground
3. Total horizontal distance of slope
4. Rate of slope
5. Total distance from centerline to intercept point
6. Offset difference (\pm)
(vertical difference between intercept point and offset stake point) + offset stake point higher than intercept point
-offset stake point lower than intercept point
7. Station number
8. Superelevation

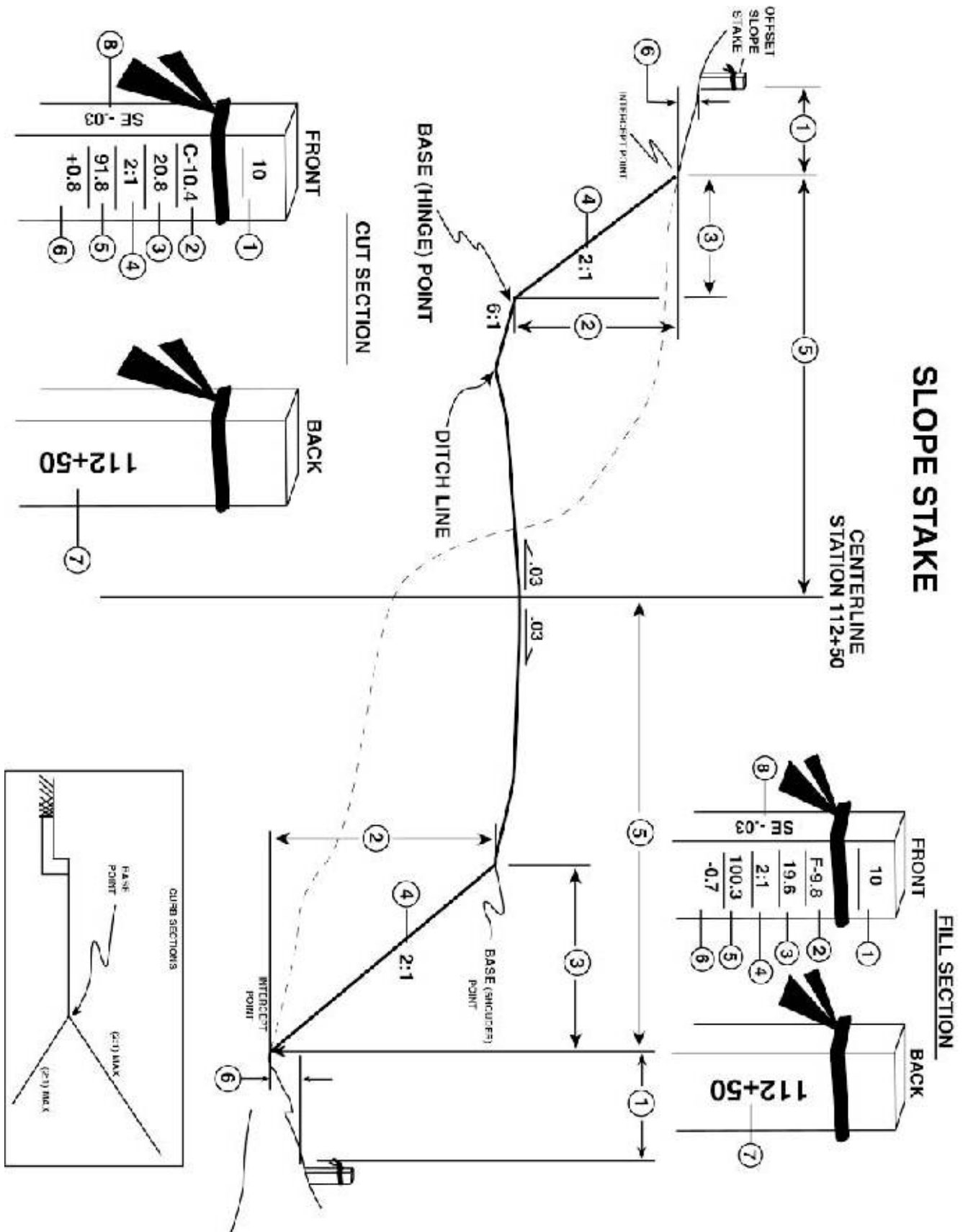

Figure 6.1



Chapter 7

Ditch Stakes

7.1 General Information

Drainage ditches typically are located at the toe of fill sections to provide a controlled channel to carry storm water. Ditch stakes provide the location, depth and width of such channels.

7.2 Guideline Information

Utilize Roadway Plans, Project Cross-Sections, slope stake information and drainage ditch details when establishing the location and depth of a drainage ditch. Ditch stake elevations should be established from the profile plan sheets. The ditch typical section will override profile grades in order to achieve minimum depths. The ditch depth should be measured either to the top of the ditch lining or to the flow line of the ditch (if no lining is specified).

7.3 Type of Stake

Recommended Stake Size: $\frac{3}{4}$ " x 1 $\frac{3}{4}$ " x 18"

Recommended Flagging: Blue

Precision: Horz. 0.1', Vert. 0.1'

Stake Use: Information and Location

7.4 Stake Information

The information described below is detailed in *Figure 7.1*.

1. Offset distance to intercept point of back slope with natural ground
2. Cut to bottom of ditch from stake
3. Back slope of ditch
4. Base width
5. Ditch typical from plans
6. Offset difference (\pm)
(vertical difference between intercept point and offset ditch stake point)
 - + offset ditch stake point higher than intercept point
 - offset ditch stake point lower than intercept point
7. Station

DITCH STAKES

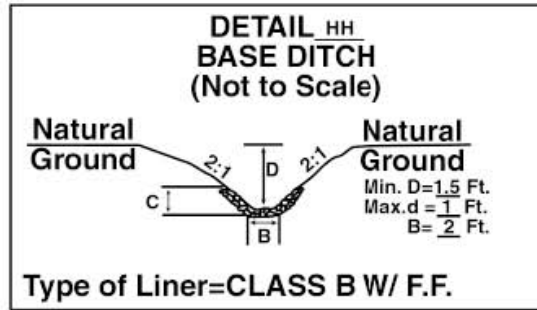

STA 756+50 LT -L-
STA 794+00 RT -L-
STA 19+20 RT-SR A-

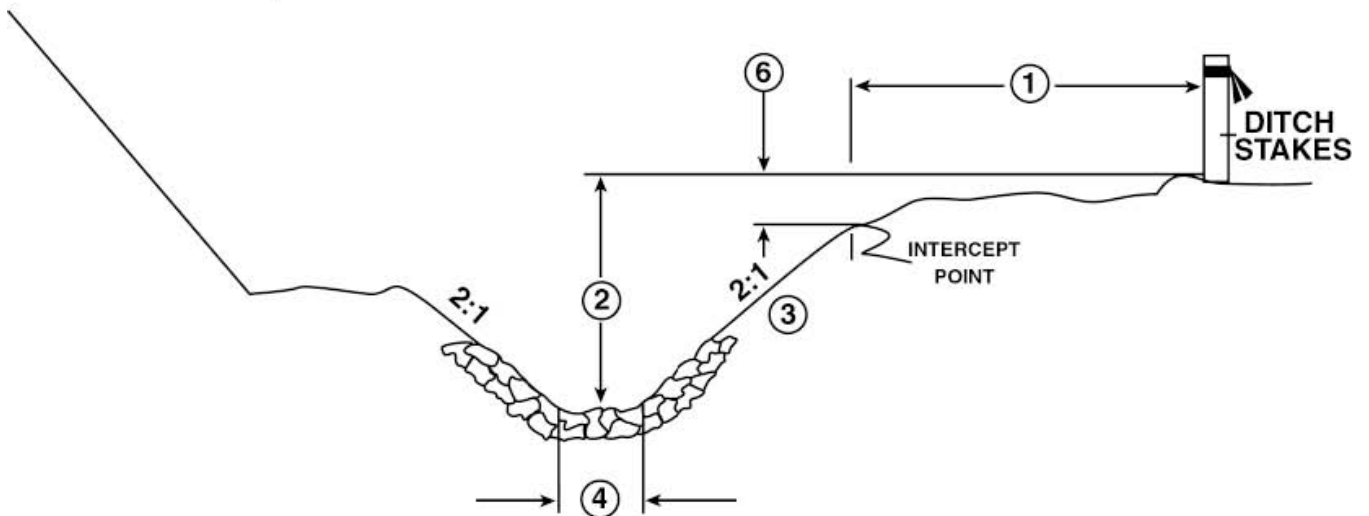
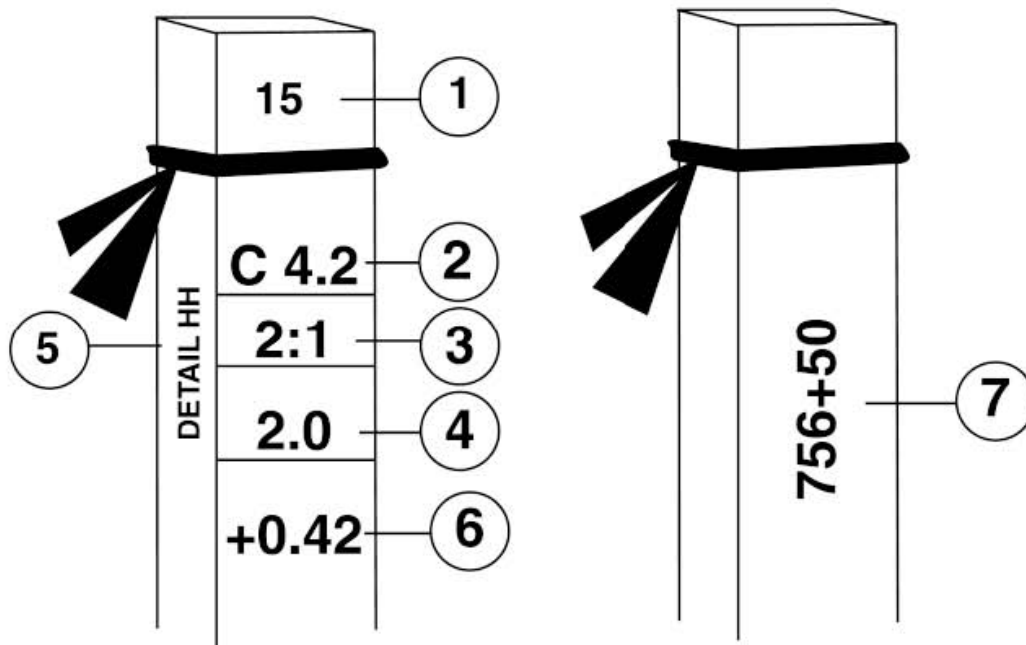

Figure 7.1



Chapter 8

Pipe Stakes

8.1 General Information

A critical task, on any project, is to construct the drainage so that it effectively collects and distributes storm water. During construction stakeout, the survey crew should identify potential drainage problems and make recommendations for correction to the Engineer. It is the responsibility of the construction stakeout crew to ensure that the drainage systems detailed in the plans will function properly as staked. If a concern exists that the drainage system may be inadequate, based upon field observations, it also should be addressed with the Engineer. In accordance with Section 801-2(F)(2), provide construction layout of drainage systems, as depicted in the plans in accordance with the *Guidelines for Drainage Studies and Hydraulic Design*.

8.2 Guideline Information

Prior to calculating and staking the drainage system detailed in the plans, perform a field investigation of the proposed area. Consider the locations and elevations of all existing and proposed utilities, proposed utility construction, and existing and proposed drainage systems in the layout of the drainage system. A layout drawing of the drainage system shall be submitted to the Engineer for review and approval prior to the contractor beginning installation of that system. In addition, unless otherwise instructed, calculate the entire network before submitting any portion of the network for approval. The Drainage Summary provided in the plans is for bidding purposes only and shall not be used for stakeout.

Establish pipe lengths from the drainage structure locations and/or actual location of the slope intercept with existing streams, natural ground or proposed drainage ditches as measured during the field investigation and/or layout. To ensure the clear zone recovery requirements are met, when staking crossline pipes notify the Engineer if the pipe length is less than the plan length. Use 12" hubs for referencing the pipe's line and flowline elevation. Pipelines greater than 200 feet will require intermediate hubs set on 100-foot intervals or on smaller intervals as deemed necessary by the Engineer. The intermediate hubs shall contain cuts or fills relative to the pipes invert elevations directly adjacent to the intermediate hubs' location. Stationing of the pipe shall begin with 0+00 at the outlet end of the pipe and advance to the inlet end. Provide one reference line, consisting of two hubs with corresponding reference stakes, for the inlet and outlet of the pipeline. The first reference hub shall be a minimum of 10 feet (3 meters) from the reference point with the second hub installed at an equal distance from the first hub.

8.3 Submittal Requirements

- 1) Drainage layout shall contain the following at a minimum:
 - a. Station and offset from centerline
 - b. Flow line elevations
 - c. Invert elevations
 - d. Percent grade of drainage networks
 - e. Standard drawing number for drainage structures
 - f. Standard drawing number for frames and grates
 - g. Type and size of drainage pipe
 - h. Length of drainage pipe

- 2) Field layout notes shall be submitted once the pipe layout is completed

8.4 Type of Stake

Recommended Stake Size: ¾" x 1 ¾" x 36"

Recommended Flagging: Blue

Stake Use: Information and Guard

Recommended Stake Size: 1 ¾" x 1 ¾" x 12" hub total

Precision: Horz. 0.01', Vert. 0.01'

Stake Use: Grade and/or Alignment

Required equipment to be used: Robot (total station)

8.5 Stake Information

Reference stakes will be used in conjunction with hubs to provide the required information as detailed below and depicted in *Figure 8.1*.

At First Reference Hub

1. Offset to the reference point of pipe
2. Station of the point referenced with respect to the pipe line
3. Cut or fill from hub to invert
4. Length size and type of pipe
5. Grade of pipe in percent with either inlet or outlet defined
6. Structure number
7. Hub elevation on side of stake

At Second Reference Hub (Reference location of pipe by alignment with first hub)

1. Offset to the reference point of pipe
2. Station of the point referenced with respect to the pipe line
4. Length size and type of pipe
6. Structure number

At Intermediate Hubs

1. Offset to the pipe
2. Station with respect to the pipe line
3. Cut or fill from hub to invert
7. Hub elevation on side of stake

PIPE STAKES

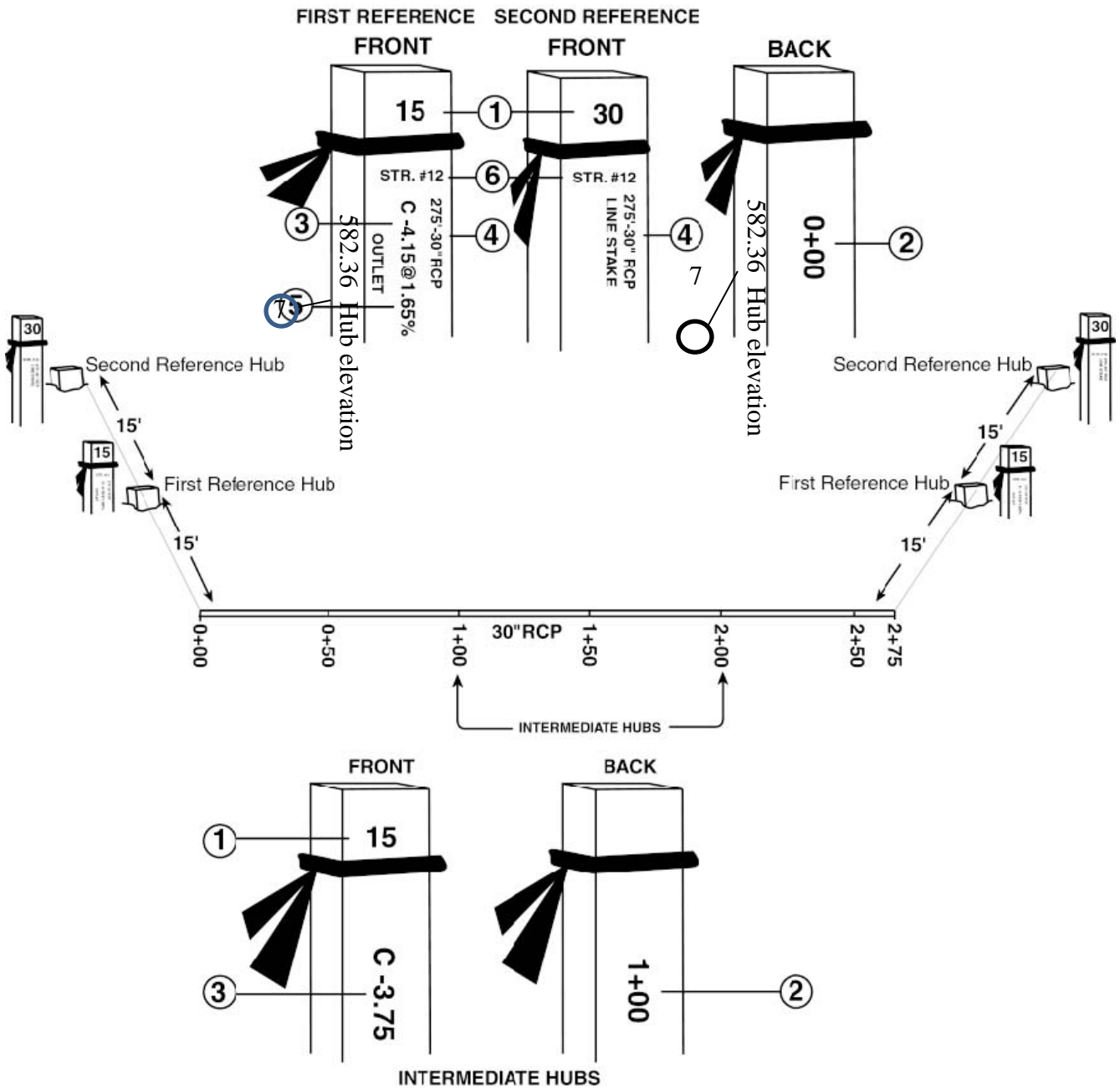

Figure 8.1



Chapter 9

Minor Structure Stakes

9.1 General Information

During construction stakeout, the survey crew should identify potential drainage problems in the field and make recommendations for correction to the Engineer. It is the responsibility of the construction stakeout crew to ensure that the drainage systems detailed in the plans will function properly as staked. Verify the location of all drainage structures within sag vertical curves and reposition as necessary to assure the structure is located at the lowest point. Superelevations at both the roadway and shoulder should be considered in establishing the lowest point. If a concern exists that the drainage system may be inadequate based upon field observations, it should be addressed with the Engineer.

9.2 Guideline Information

Stake each drainage structure independently of each pipeline. Each structure will require a reference line for alignment and grade, consisting of at least one hub on opposite sides of the drainage structure. The hubs should have equal offsets and be a minimum of 10 feet (3 meters) from the reference point. The reference line should mark the centerline of junction boxes and drop inlets, and the inside back wall of catch basins. Grades should be set and referenced from the hubs to top of structure for junction boxes and catch basins, and flow line of grate for drop inlets. Refer to the Standard Drawings for the grate and frame dimensions.

Unless otherwise approved, calculate the entire network before submitting any portion of the network. Careful consideration should be given for all work that is to follow the installation of the minor stakes that could result in future conflict (ie. guardrail flare rates, shoulder berm gutter, etc). The frame and grates on minor drainage structures shall have bearing on all four sides; therefore, accurate stakeout and construction is critical.

9.3 Type of Stake

Recommended Stake Size: $\frac{3}{4}$ " x $1\frac{3}{4}$ " x 36"

Recommended Flagging: Blue

Precision: Horz. 0.01', Vert. 0.01'

Stake Use: Information

Recommended Stake Size: $1\frac{3}{4}$ " x $1\frac{3}{4}$ " x 12" hub with tack

Recommended Flagging: Blue

Precision: Horz. 0.01', Vert. 0.01'

Stake Use: Grade and/or Alignment

Recommended equipment to be used: Robot (total station)

9.4 Stake Information

The information described below is detailed in *Figure 9.1*.

1. Offset to the center of the structure

2. Reference line of hubs with respect to drainage structure
3. Cut/fill from hub to invert; top of structure for drop inlets and junction boxes, top of grate for catch basins.
4. Structure number
5. Hub elevation on side of stake

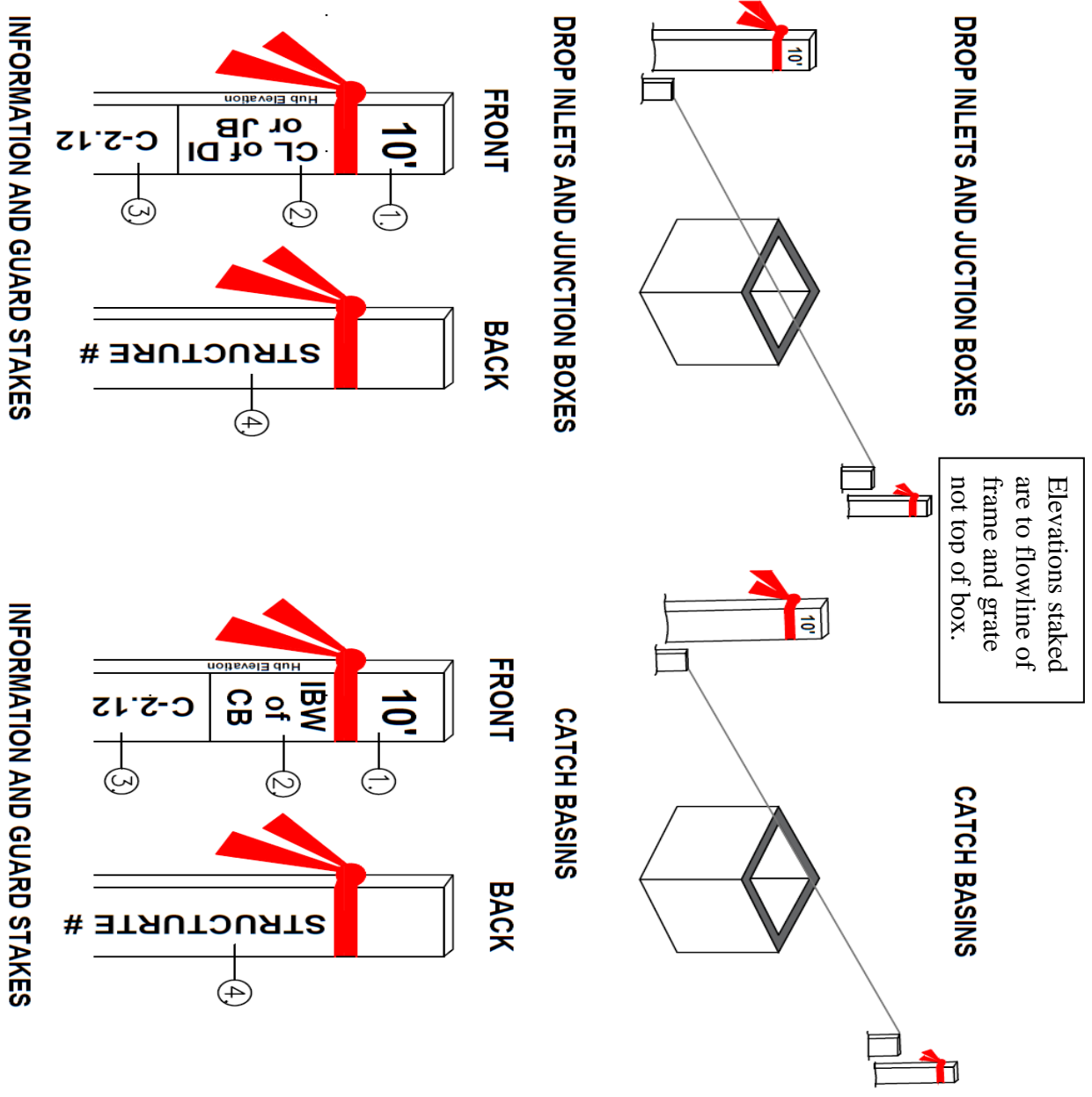

Figure 9.1
23

Figure 9.1

MINOR DRAINAGE STRUCTURE LAYOUT

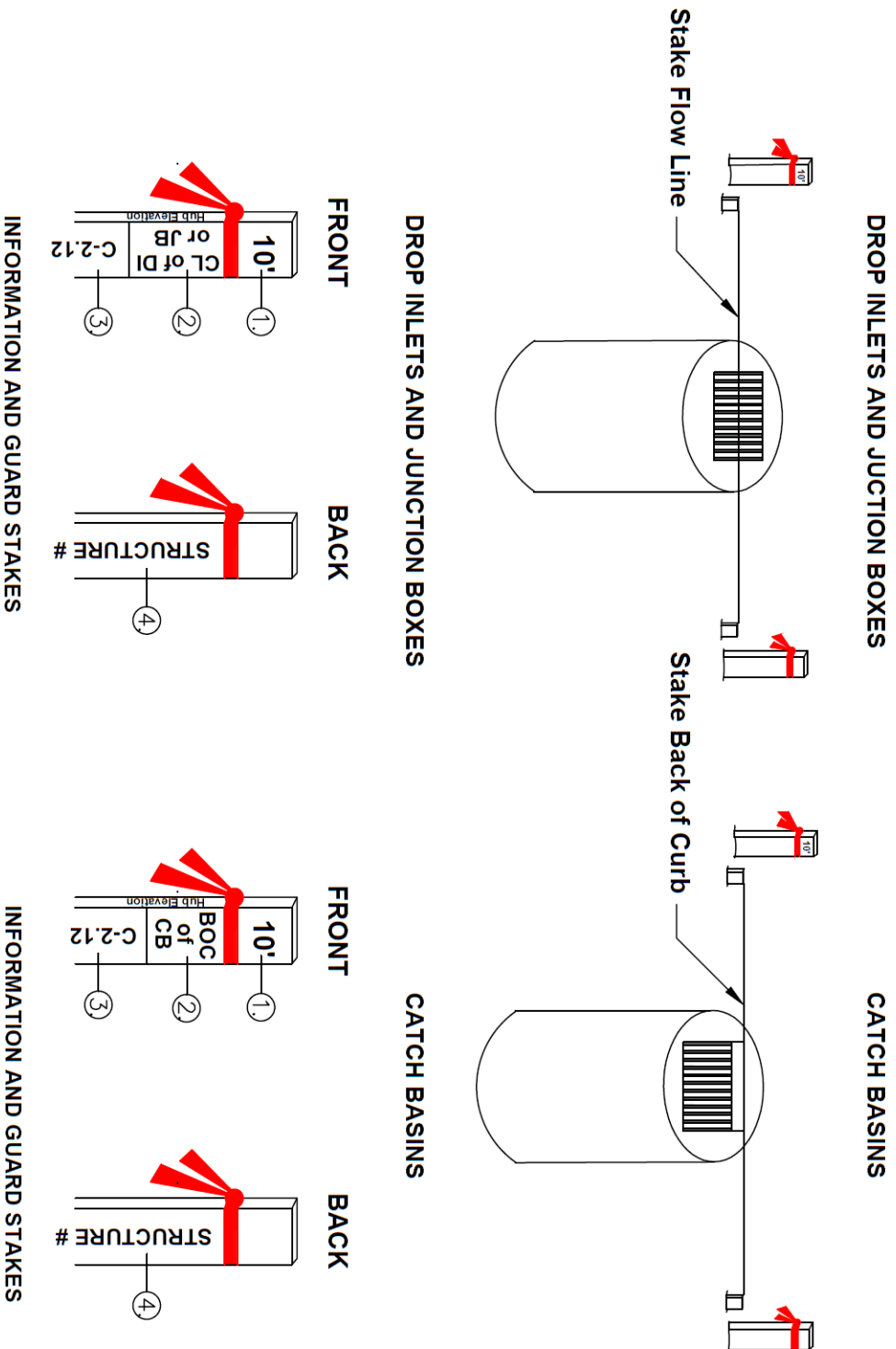

Figure 9.2



Chapter 10

Endwall Stakes

10.1 General Information

Endwalls assist in channeling water into the pipe network, minimizing erosion of the stream channel and retaining the embankment above the pipe. Prior to staking the endwall, you must know the limits of your embankment and pipe.

10.2 Guideline Information

Prior to staking the endwall, set slope stakes to establish the limits of the embankment. Stake endwalls perpendicular to the pipe. Adjust the slope and pipe length to accommodate the endwall. Endwalls require one reference line with a hub on each side of the proposed structure. The line should be referenced to the outside face of the endwall. Grades should be set and referenced from the hubs to a known or calculated elevation on the proposed structure. (See *Figure 10.1*.) When locating the endwall, the fill slope should be projected to intersect with the inside wall of the endwall.

10.3 Type of Stake

Recommended Stake Size: $\frac{3}{4}$ " x $1\frac{3}{4}$ " x 36"

Recommended Flagging: Blue

Precision: Horz. 0.01', Vert. 0.01'

Stake Use: Information

Recommended Stake Size: $1\frac{3}{4}$ " x $1\frac{3}{4}$ " x 12" hub with tack

Recommended Flagging: Blue

Precision: Horz. 0.01', Vert. 0.01'

Stake Use: Grade and/or Alignment

Required equipment to be used: Robot (total station)

10.4 Stake Information

The information described below is detailed in *Figure 10.2*.

1. Offset to the center, outside face of endwall
2. Cut or fill from hub to reference point on endwall (typically top of wall)
3. Hub elevation

ENDWALL REFERENCING

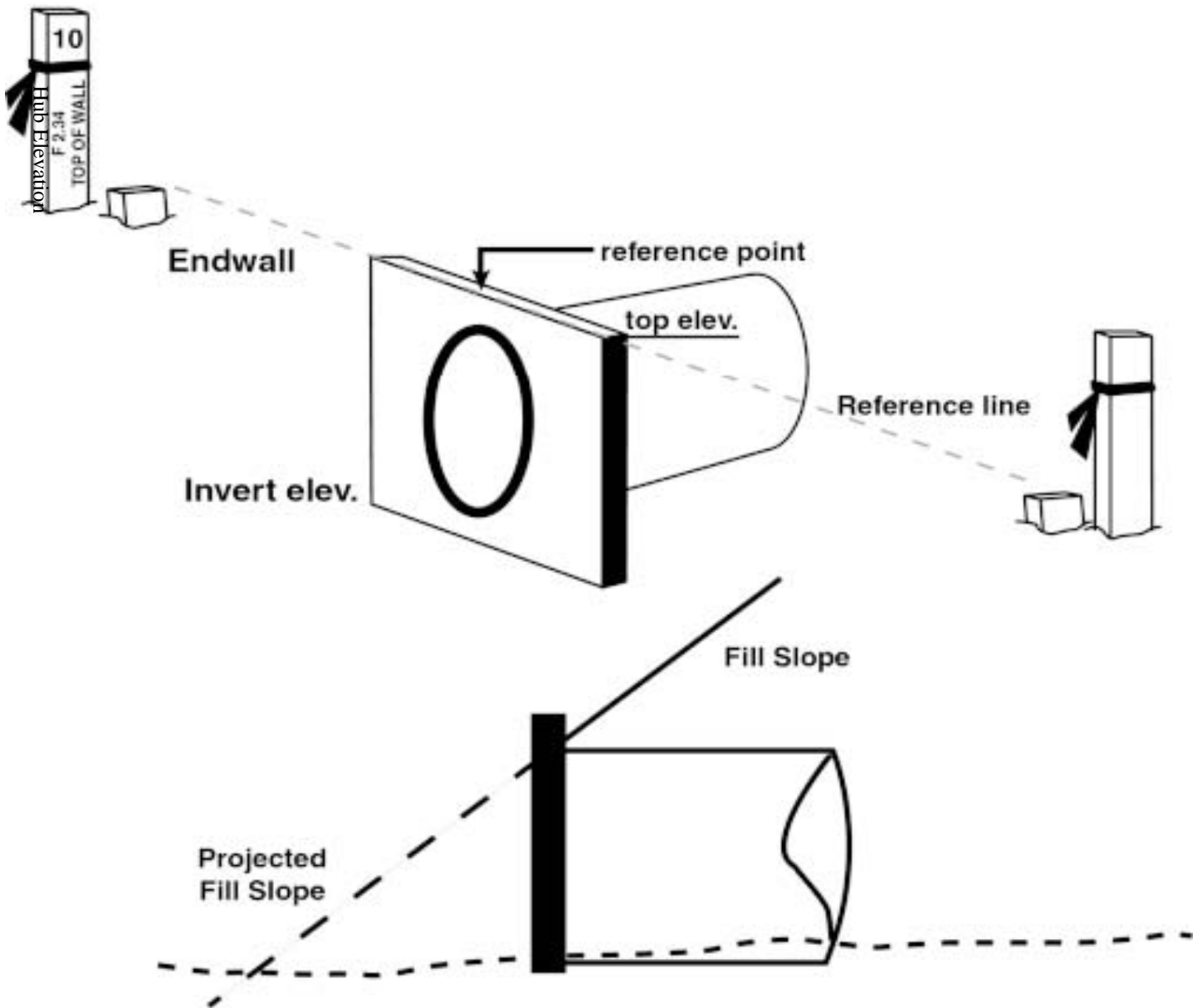

Figure 10.1

ENDWALLS

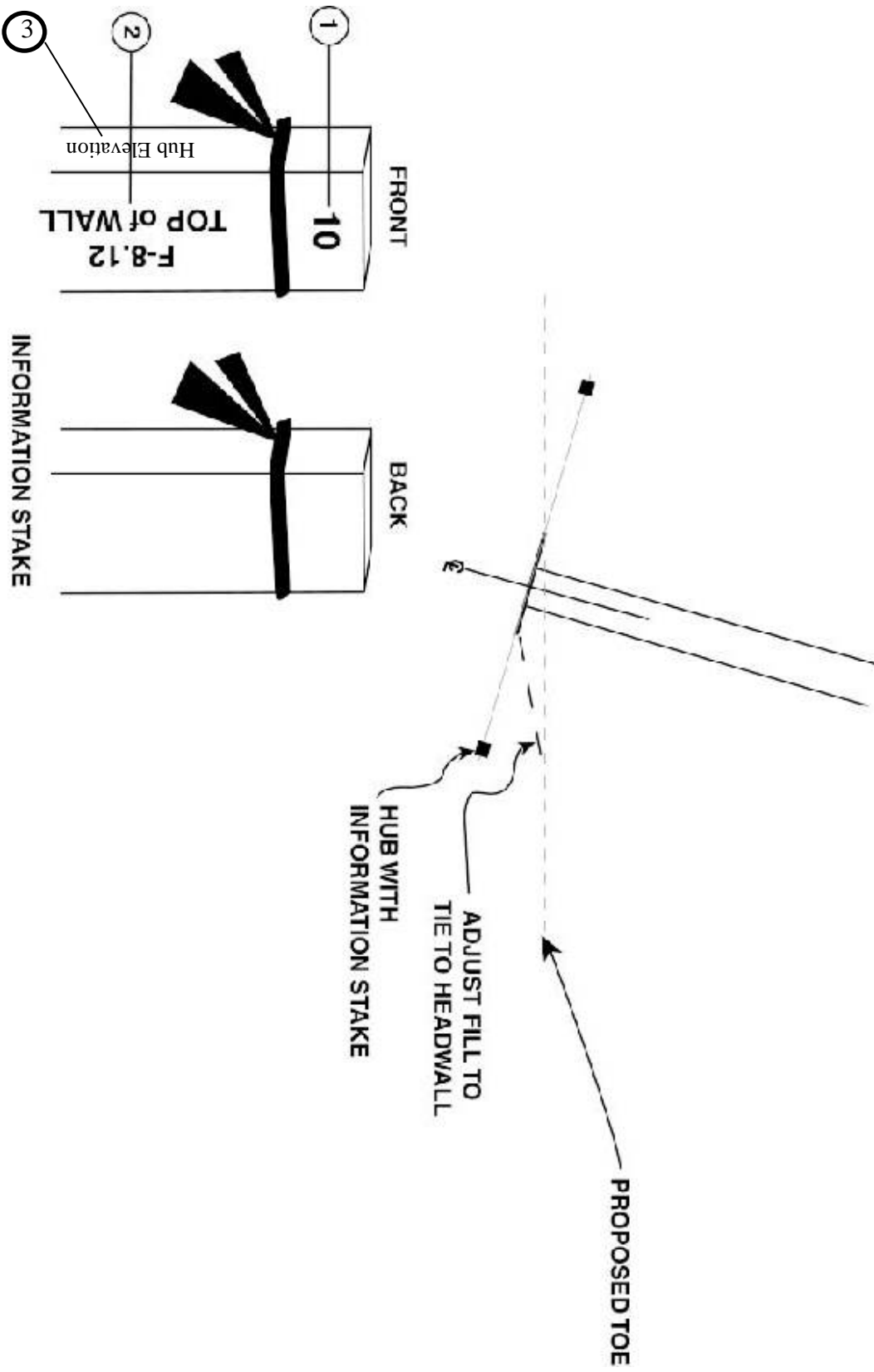

Figure 10.2



Chapter 11

Intermediate Grade Stakes

11.1 General Information

Intermediate grade stakes typically are set after slope stakes and before fine grade stakes. Although the information contained on intermediate grade stakes may be obtained from the slope stakes, intermediate grade stake installation often expedites grading operations by providing the equipment operators a reference to the finished grade location.

11.2 Guideline Information

Set intermediate grade stakes on the centerline or a designated offset line (grade or crown point). On each stake, provide the difference in elevation from finished grade to the top of the stake. Mark the top of the stake with an X to designate the elevation reference.

11.3 Type of Stake

Recommended Stake Size: $\frac{3}{4}$ " x 1 $\frac{3}{4}$ " x 18"

Recommended Flagging: Orange

Precision: Horz. 0.1', Vert. 0.01'

Stake Use: Grade and Alignment

11.4 Stake Information

The information described below is detailed in *Figure 11.1*.

1. Station Number
2. Superelevation
3. Alignment designation
4. Cut or Fill to proposed finish grade

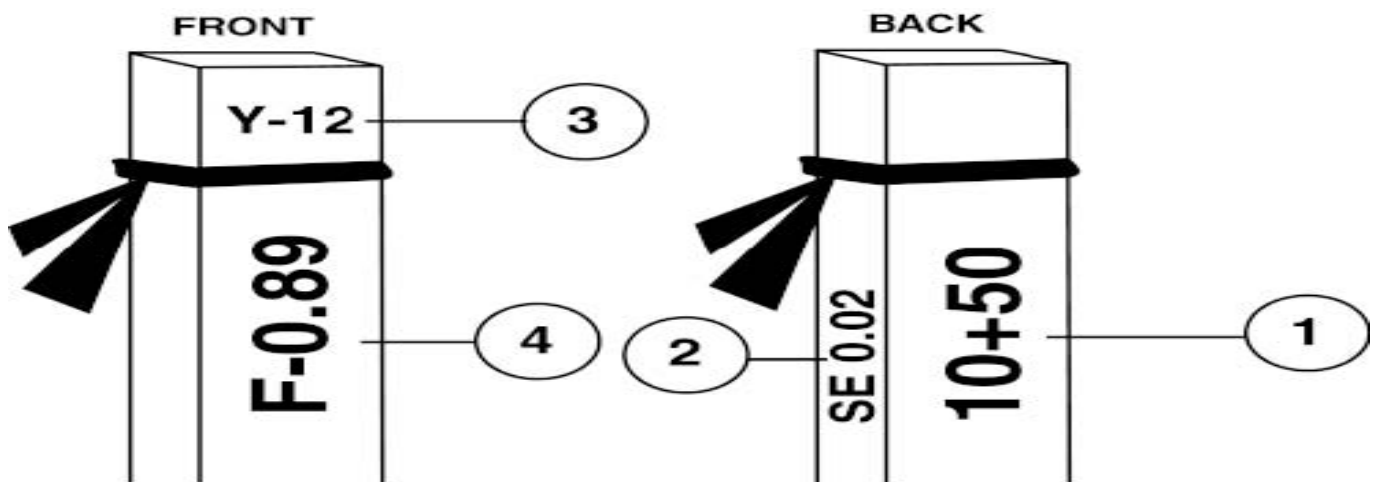

Figure 11.1



Chapter 12

Curb Stakes

12.1 General Information

Various types of curb are specified within NCDOT projects to assist in collecting and distributing storm water to a controlled outlet. Although several types of curbs or curb and gutters may be specified, they should be staked uniformly as detailed below.

12.2 Guideline Information

Stake curb and gutter on 50 foot (20 meter) or smaller intervals in sharp radii, tapers and along flat grades as deemed necessary. Intervals may be adjusted by the Engineer to properly construct the project. Stake curb and gutter with a minimum 3 foot (0.9 meters) and maximum 6 foot (1.8 meter) offset. Set hubs with tacks on the offset line used for horizontal and vertical control. Reference grades to the top of the curb and the offset to the back of the curb. Reference will be taken from the tack in the hub.

When staking radii, stake and mark the curve radius point along with the PC point, the PT point and one or more points equally distributed throughout the curve. When staking radii for -Y- lines, the grades along -L- should override those of the -Y- line to facilitate rideability of the -L- line. Adjust the -Y- lines accordingly.

Consult the Standard Drawings for *Curb Slopes for Variable Superelevations*.

12.3 Submittal Requirements

1. Copy of field book (layout notes)

12.4 Type of Stake

Recommended Stake Size: $\frac{3}{4}$ " x $1\frac{3}{4}$ " x 18"

Recommended Flagging: Orange

Stake Use: Information and Guard

Recommended Stake Size: $1\frac{3}{4}$ " x $1\frac{3}{4}$ " x 12" with tack

Precision: Horz. 0.01', Vert. 0.01'

Stake Use: Grade and Alignment

Required equipment to be used: Robot (total station)

12.5 Stake Information

The information described below is detailed in *Figure 12.1*

1. Offset to back of curb
2. Cut or fill to top of curb
3. Gutter slope
4. Super elevation of pavement
5. Station number
6. Hub elevation

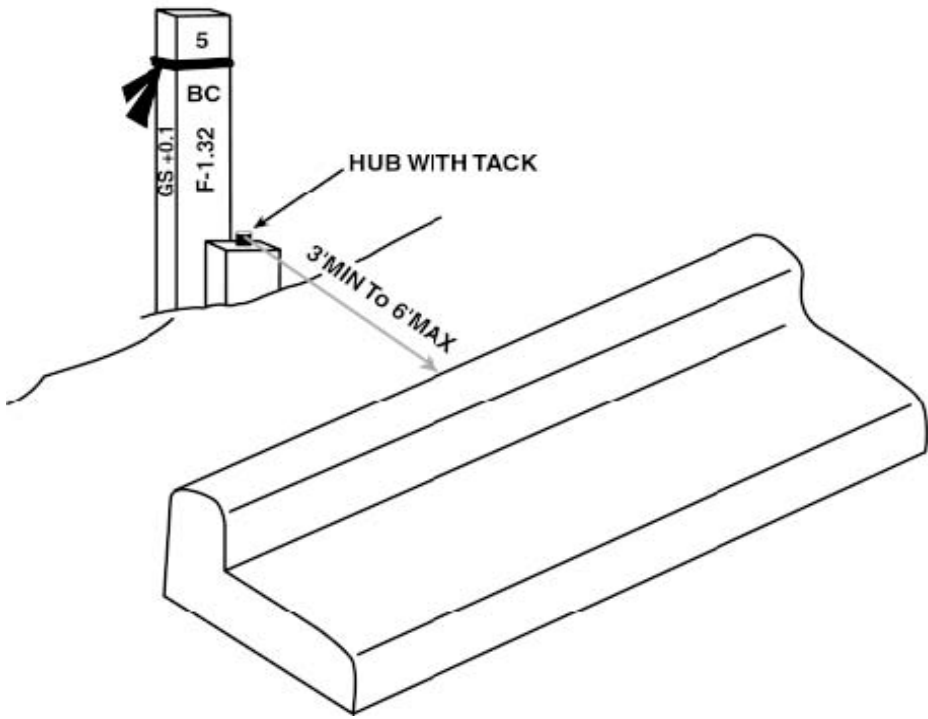
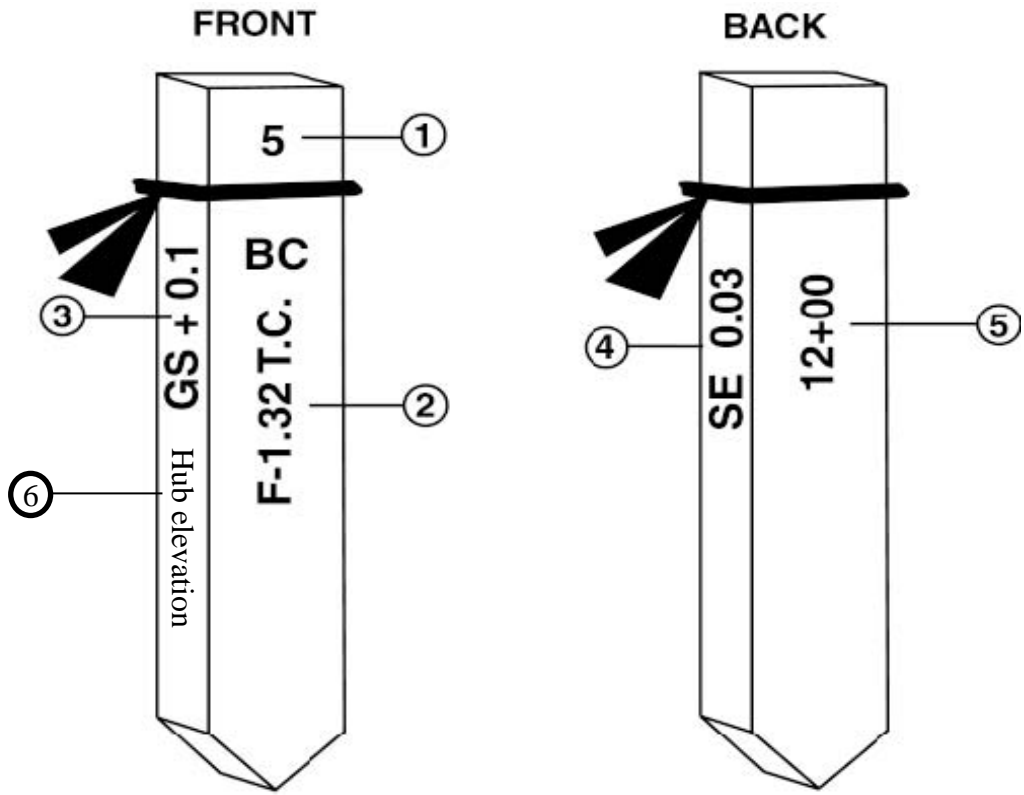

Figure 12.1



Chapter 13

Fence Line Stakes

13.1 General Information

The majority of fence on projects will be control of access fence. However, different fences may be specified for Right-of-Way or safety considerations.

13.2 Guideline Information

Set fence stakes at the intervals required by field conditions, not to exceed 100 feet (30 meters). If the control of access and Right of Way lines differ, set stakes on the control of access line. Otherwise set stakes on the right of way line. Establish the Department's Right-of-Way or controlled access line by using the plans and/or any applicable revisions.

Stake other fences along the alignment detailed in the Plans.

13.3 Type of Stake

Recommended Stake Size: $\frac{3}{4}$ " x $1\frac{3}{4}$ " x 18"

Recommended Flagging: White

Precision: Horz. 0.1'

Stake Use: Alignment

13.4 Stake Information

The information described below is detailed in *Figure 13.1*.

1. Denotes type of fence
2. Offset
3. Station and distance from centerline

FENCE STAKES

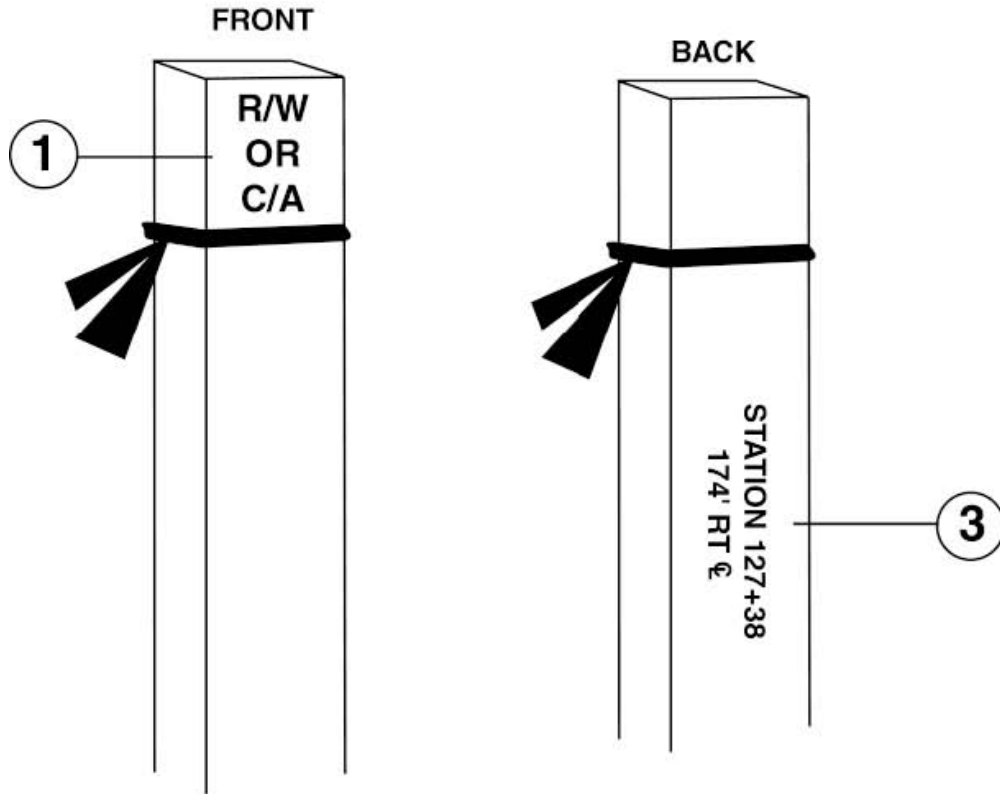

Control of Access Fence

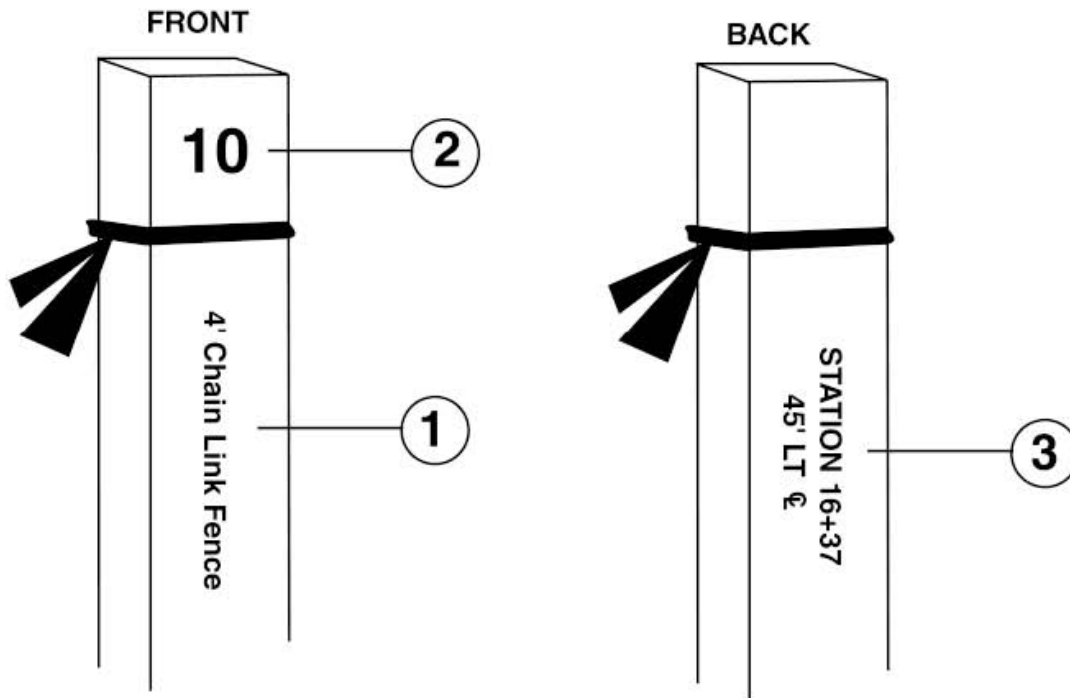

Other Fences

Figure 13.1



Chapter 14

Fine Grade Hubs

14.1 General Information

Fine grade hubs reference the proposed finish elevation. They are used to establish and check the elevation of all layers of the pavement schedule up to the final layer of surface. Typically set upon completion of rough grading, fine grade hubs provide reference for the elevation of all layers of the pavement, including subgrade, base and pavement.

14.2 Guideline Information

Install and reference all fine grade hubs to finish grade. Set fine grade hubs at a maximum 50 foot (20 meter) interval. A smaller interval may be necessary for gores, tapers, and sharp horizontal and vertical curves or superelevation transitions. Set fine grade hubs on a suitable offset from the edge of paved shoulder, but no less than 5 feet (1.5 meters). (See *Figure 14.1* and *14.2*.) Set an intermediate stake at the centerline if the fine grade hubs span more than 60 feet (20 meters) of proposed pavement. Reestablish this intermediate stake after each layer of pavement structure, excluding the final layer of surface course.

Retain and, if necessary, reinstall all fine grade hubs until the completion of the first layer of surface course.

14.3 Submittal Requirements

1. Copy of field or layout book

14.4 Type of Stake

Recommended Stake Size: 1 ¾" x 1 ¾" x 12"-24" hub

¾" x 1 ¾" x 18" reference stake

Recommended Flagging: Orange

Precision: Horz. 0.1', Vert. 0.01'

Stake Use: Alignment, Finished Grade and Pavement Slope

Required equipment to be used: Robot (total station)

14.5 Stake Information

The information described below is detailed in *Figure 14.3*.

1. Offset
2. Cut or fill from reference hub to the proposed projected finished grade, excluding Case III B (cut or fill to proposed grade or crown point elevation)
3. Superelevation
4. Station number
5. Distance to Grade Point or Crown Point
6. Build up (Optional - Case III A)

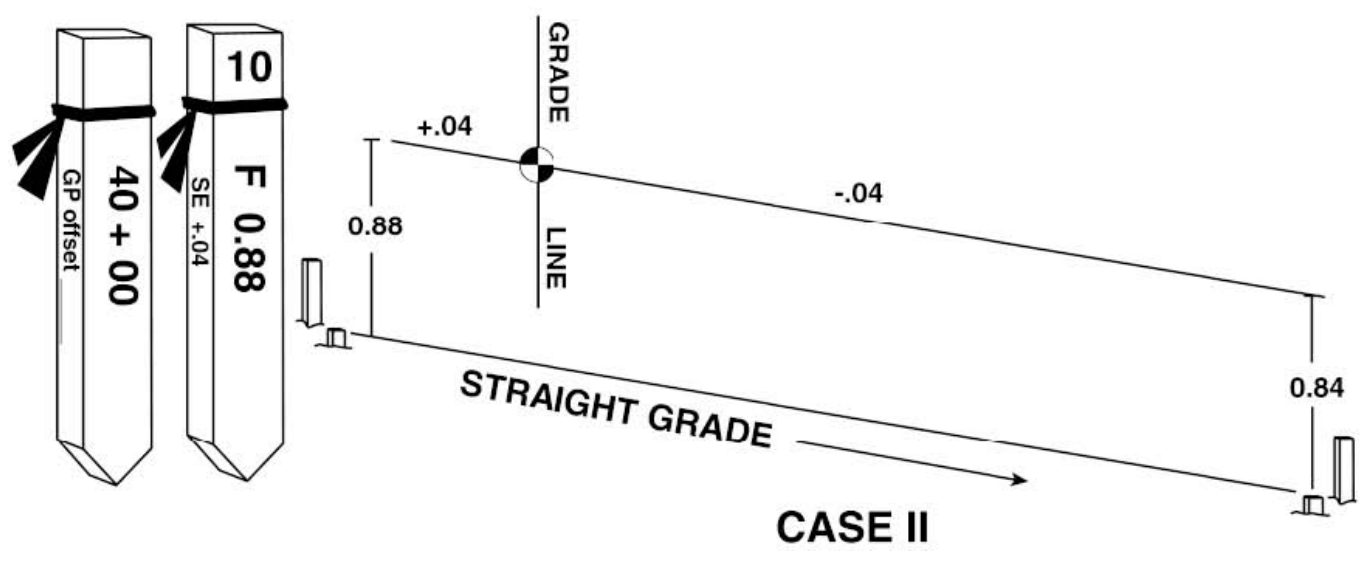
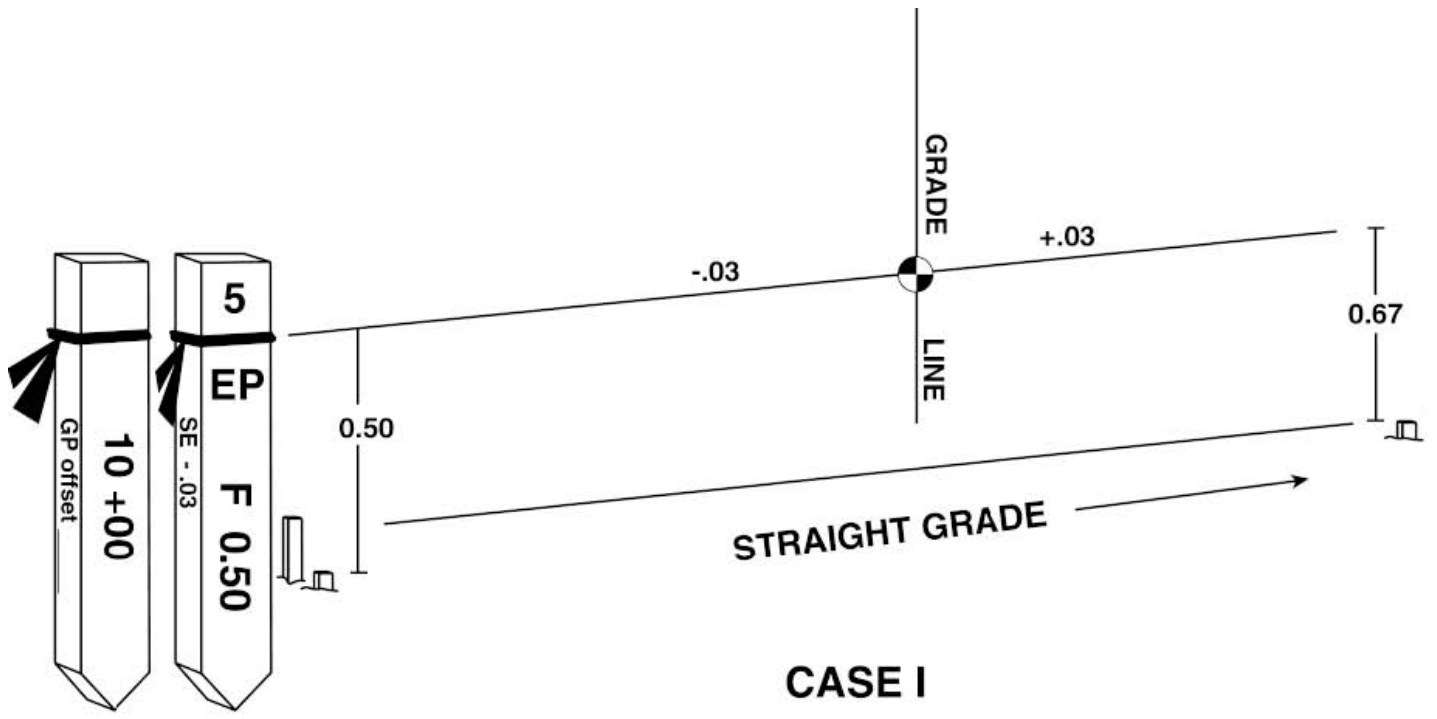
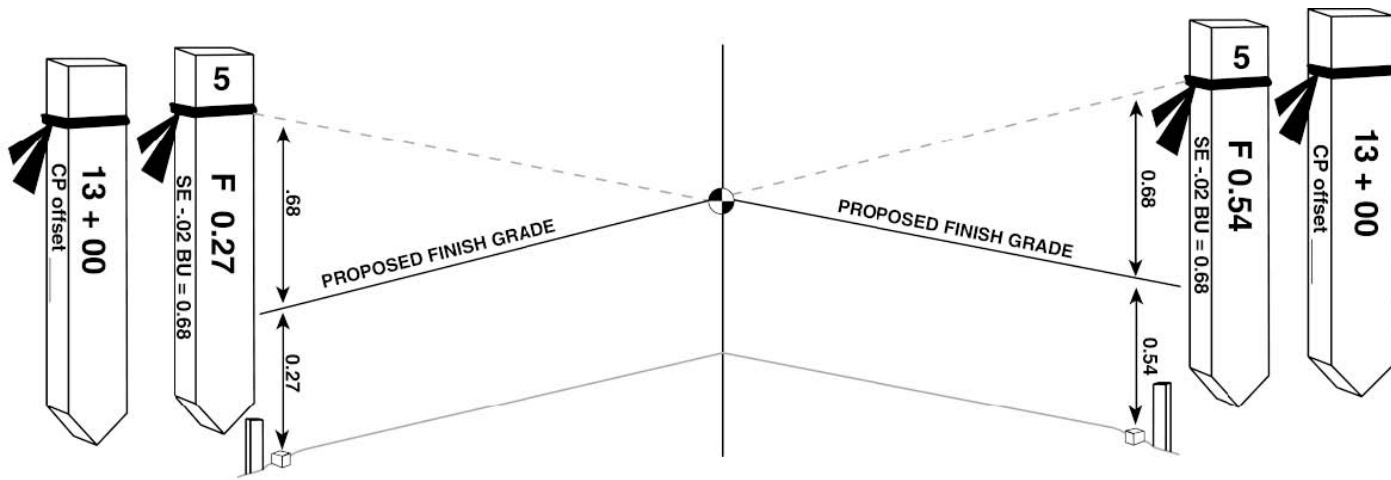
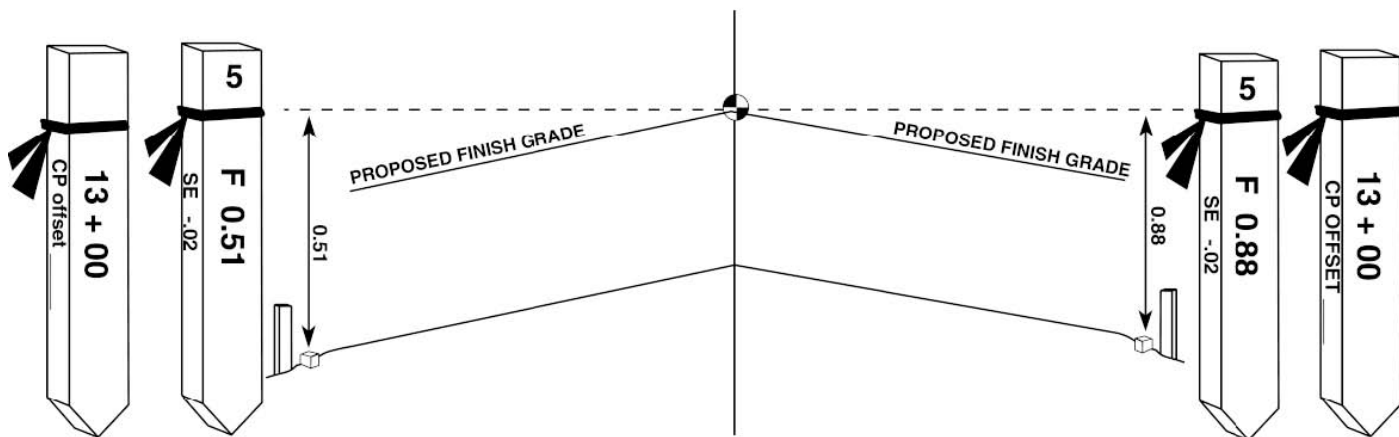

Figure 14.1



CASE III A



CASE III B

Figure 14.2

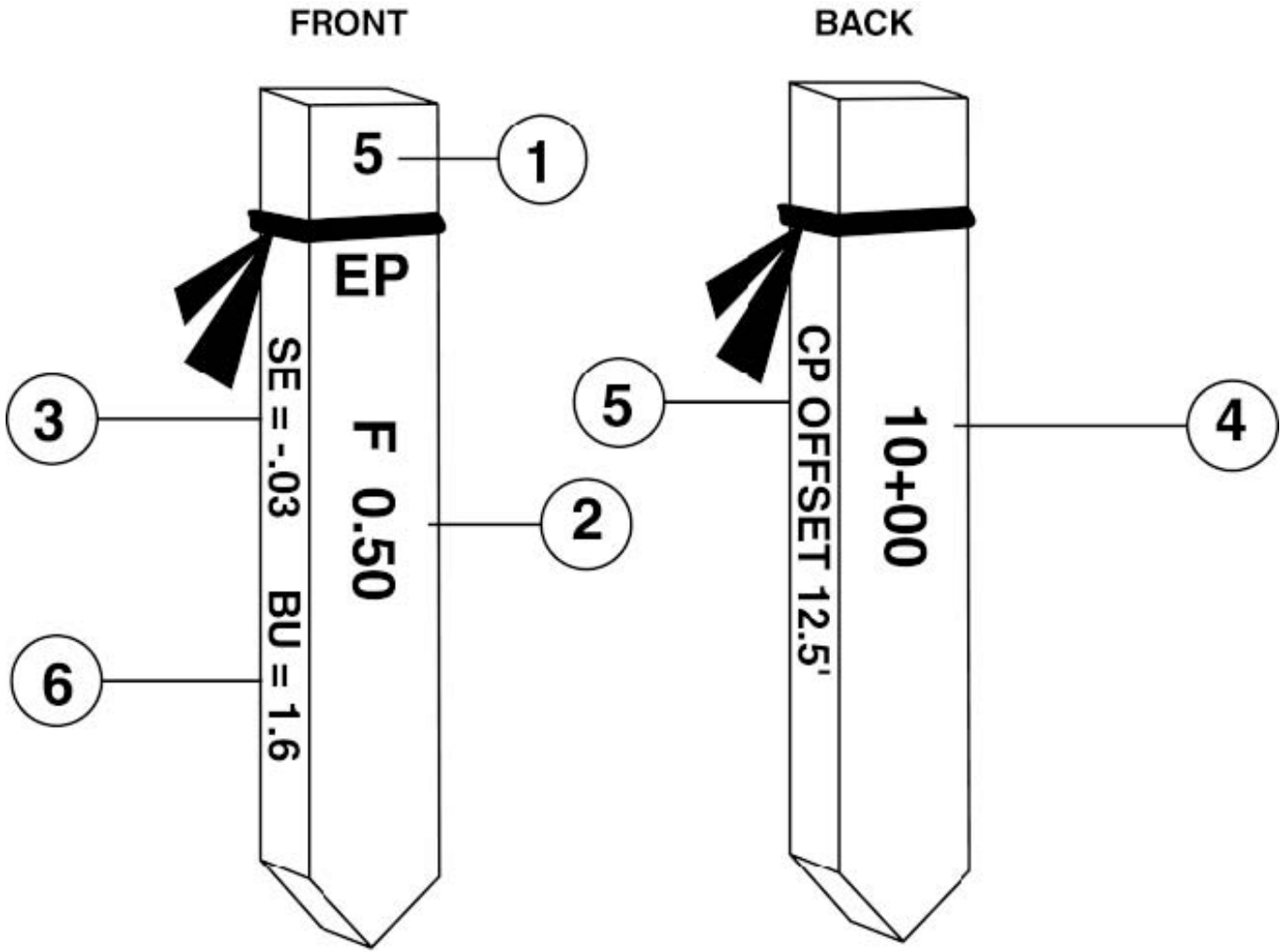

Figure 14.3



Chapter 15

Right-of-Way Markers

15.1 Guideline Information

A rebar and cap will be set at all proposed Right-of-Way monument locations, Control of Access monument locations and Permanent Easement monument locations by a North Carolina Professional Land Surveyor at the time of Right-of-Way approval by the Board of Transportation and prior to recordation of Right-of-Way Plans at the appropriate County Register of Deeds Office. Upon given notice to proceed, the Contractor shall validate the positions of all existing Right-of-Way monuments, Control of Access monuments, and Permanent Easement monuments within the construction limits. The Contractor shall submit to the Resident Engineer for review any monumentation discrepancies between the roadway plans, including any applicable revisions, and the previously established monumentation location established by the Department.

Unless concrete Right-of-Way markers are specified in the Contract, the Contractor shall install a Right-of-Way monument cap, Control of Access monument cap or Permanent Easement monument cap and appropriate carsonite witness stake at each monumentation shown on the plans that needs to be re-established. Mount the monument cap on a minimum 18" long #5 reinforcing bar, which has been driven flush with the top of the ground. Using a hammer, snugly secure the monument cap to the top of the bar. Install an appropriate carsonite witness stake adjacent to the monument and drive it approximately 12 inches (30 centimeters) into the ground. Avoid damaging the top of the monument cap or witness stake. The Department will provide all Right-of-Way, Control of Access, and Permanent Easement monument caps and witness stakes.

If concrete monuments are specified on the design plans, the Contractor under the responsible charge of a North Carolina Professional Land Surveyor shall install concrete monuments by installing appropriate and accurate additional reference line stakes to properly reference the location of the existing cap and rebar monument location during concrete monument installation or replacement. Concrete monument replacement shall be duly noted for each location on the "Report of Final R/W and Permanent Easement Survey" and attested by the responsible North Carolina Professional Land Surveyor in responsible charge.

Right-of-way, Control of Access, and Permanent Easement markers are considered part of boundary lines and property lines. Re-establishment and verification of existing monuments or the replacement of existing monuments shall be performed under the responsible charge of a North Carolina Professional Land Surveyor.

15.2 Submittal Requirements

1. A signed and sealed attestation by a North Carolina Professional Land Surveyor. The attestation shall be verification of all re-established and/or re-placed Right of Way, Permanent Easement, and Control-of-Access monument positions. Verification includes new and existing monuments (including concrete R/W markers, iron pins, caps, etc). The "Report of Final R/W and Permanent Easement Survey" form shall be completed and submitted to the Resident Engineer upon completion of the installation of all Right-of-Way Markers. Any operations that pose a risk of damage to the location of the markers shall

also be reported to the Resident Engineer. A copy of the report shall be forwarded by the Resident Engineer to the appropriate Location & Surveys Unit Regional Project Development Engineer for review and approval. An example of this form can be found in the Appendix of this Manual as well as the procedures to be followed. An electronic, fillable form is located on the NCDOT website at:

<https://connect.ncdot.gov/resources/Location/Pages/default.aspx>

15.3 Type of Stake

Recommended Stake Size: ¾" x 1 ¾" x 18"

Recommended Flagging: White

Stake Use: Information and Guard

Recommended Stake Size: 1 ¾" x 1 ¾" x 12" with tack or 60D Nail

Recommended Flagging: White

Precision: Horz. 0.01'

Stake Use: Location

Required equipment to be used: Robot (total station)

15.4 Stake Information

The information described below is detailed in *Figure 15.1*.

1. Denotes type of stake (Right-of-Way)
2. Alignment
3. Offset from survey line
4. Station
5. Monument cap
6. 18" long #5 reinforcing bar
7. Carsonite witness stake

RIGHT OF WAY STAKING INFORMATION

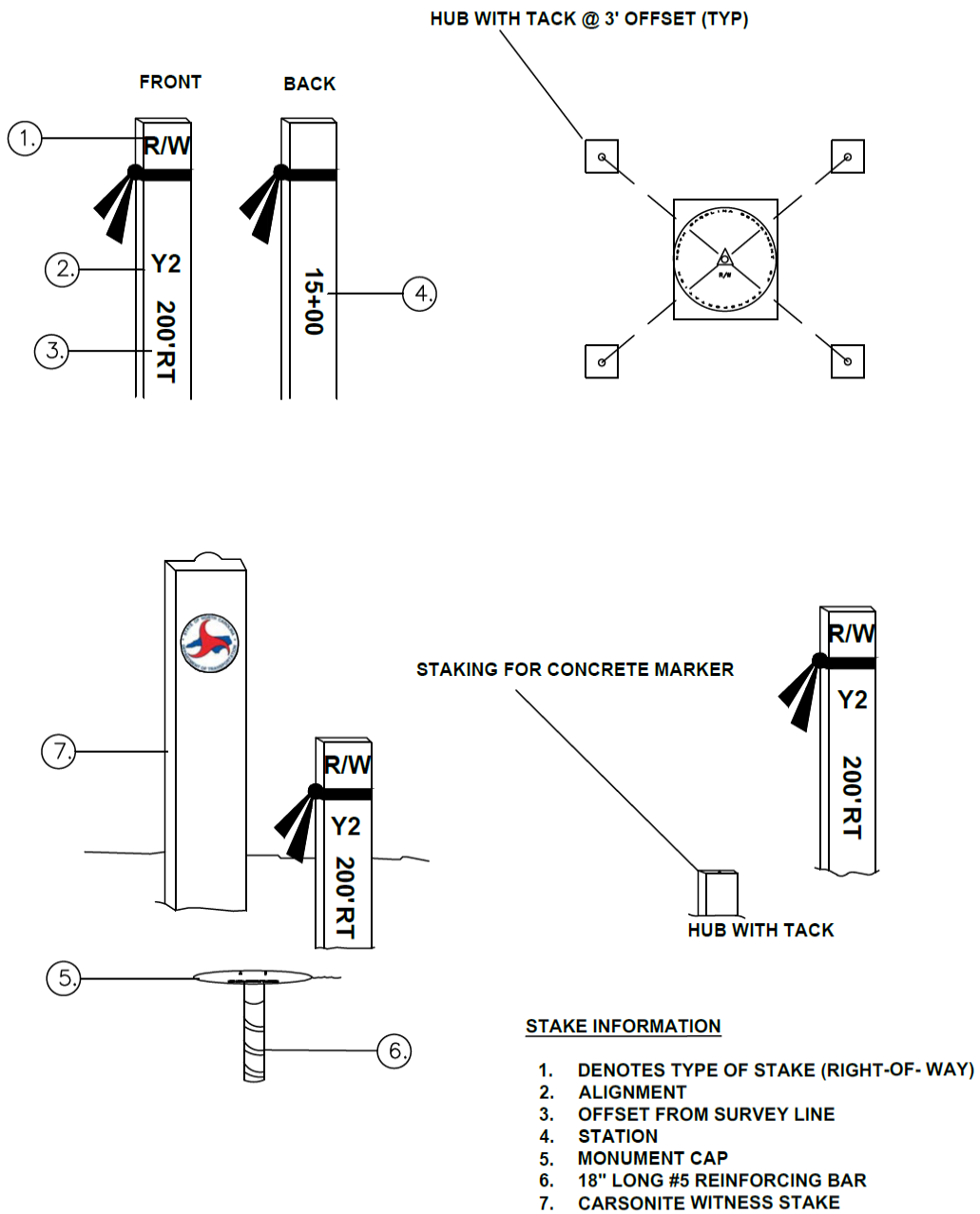

Figure 15.1



Chapter 16

Signs

16.1 General Information

The s-dimensions and support lengths detailed in the plans are used for estimating purposes only and are not intended for fabricating supports. Prior to sign support fabrication, the s-dimensions should be verified by either theoretical calculation or field measurement and should be submitted to the Engineer for review. Once verified by the Contractor and reviewed by the Department, sign plan revisions will be provided to the Contractor for the fabrication of ground mounted supports and design of overhead sign structures.

16.2 Guideline Information

Prior to establishing the s-dimensions, stake the horizontal location of the proposed signs for the Engineer's review. Perform a thorough investigation of the proposed sign locations, or revised locations established during the Engineer's review. Identify any obstruction, either existing or proposed, which may interfere with the proposed sign installation. Such items may include, but are not limited to, existing or proposed drainage systems, underground and/or aboveground utilities, and drainage ditches. If adjustments in the sign locations are warranted to avoid obstacles, advise the Engineer in writing. Include a detailed sketch of the proposed sign location, the obstruction and the new location recommended to avoid the obstruction. Do not revise any sign locations without the written direction of the Engineer.

Once proposed overhead sign locations are confirmed, use the roadway plans to calculate the theoretical finished elevations at that station. Consider the following in calculating the theoretical finished section:

- Proposed lane and shoulder widths, including any tapers or widening for guardrail roadway
- Superelevations
- Shoulder rollovers
- Side ditches
- Barrier rail sections
- Slope gradients
- Any other items which may affect the span length or elevation of the proposed sign

16.3 Submittal Requirements - Overhead Signs (Structures)

The s-dimension for overhead sign assemblies is the difference in elevation between the highest point of the roadway section, including the paved shoulder, and the ground at the proposed center of the overhead sign footing location. (See *Figure 16.1.*)

Submit an 11 1/2" x 17" cross-section drawing of the proposed overhead sign locations detailing the following:

- Roadway, shoulder and slope gradients
- Edge of pavement elevations
- Elevation of each lane line
- Elevation of the ground at each sign footing location
- Location of any monolithic islands
- Calculated s-dimension

Unless grading work is not anticipated at the proposed sign location, calculate and install a slope stake at each proposed sign location to ensure the Contractor constructs the slopes to the gradient utilized in calculating the theoretical finished section.

Layout the overhead sign assemblies as detailed in the Contractor's approved shop drawings. Provide reference line for the footings, which consists of a minimum of two hubs with corresponding reference stakes. Reference the center of the sign footing. The first reference hub shall be a minimum of 10 feet (3 meters) from the reference point with the second hub installed at an equal distance from the first hub. Grades should be set and referenced from the hubs to a known or calculated elevation of the proposed footing. (See *Figure 16.3*)

This section shall apply to all overhead structures (excluding bridges), not solely signs including toll gantries, dynamic message signs, etc.

16.4 Submittal Requirements - Ground Mounted Signs (Type A and B)

The s-dimension for ground mounted signs represents an increase (+) or decrease (-) in support length relative to the elevation of the edge of the outside travel lane, not the outside edge of the paved shoulder. (See *Figure 16.2*) Reference the *Typical Elevation Ground Mounted Sign* detail located within the project Signing Plans.

Submit to the Engineer, in tabular format, the s-dimensions for each support within the proposed Type A and B ground mounted signs.

Provide reference line for the footings, which consists of a minimum of two hubs with corresponding reference stakes. Reference the center of the sign footing. The first reference hub shall be a minimum of 10 feet (3 meters) from the reference point with the second hub installed at an equal distance from the first hub. Grade information is typically not required. (See *Figure 16.4.*)

16.5 Submittal Requirements - Ground Mounted Signs (Type D, E and F)

S-dimensions are not required for Type D, E and F Ground Mounted Signs.

Provide location of ground mounted signs. Install an information stake at the proposed sign location. (See *Figure 16.5.*)

16.6 Type of Stake

Recommended Stake Size: 1 3/4" x 1 3/4" x 12" hub

Precision: Horz. 0.01', Vert. 0.01'

Stake Use: Grade and/or Alignment

Recommended Stake Size: 3/4" x 1 3/4" x 18"

Recommended Flagging: Pink

Stake Use: Information and Location

Required equipment to be used: Robot (total station)

16.7 Stake Information

The information described below is detailed in *Figure 16.6*.

1. Offset to center of footing
2. Grade to known or calculated elevation of footing (typically not required for ground mounted signs)
3. Distance to centerline
4. Station
5. Alignment
6. Hub elevation

VERIFICATION OF OVERHEAD MOUNTED SIGNS

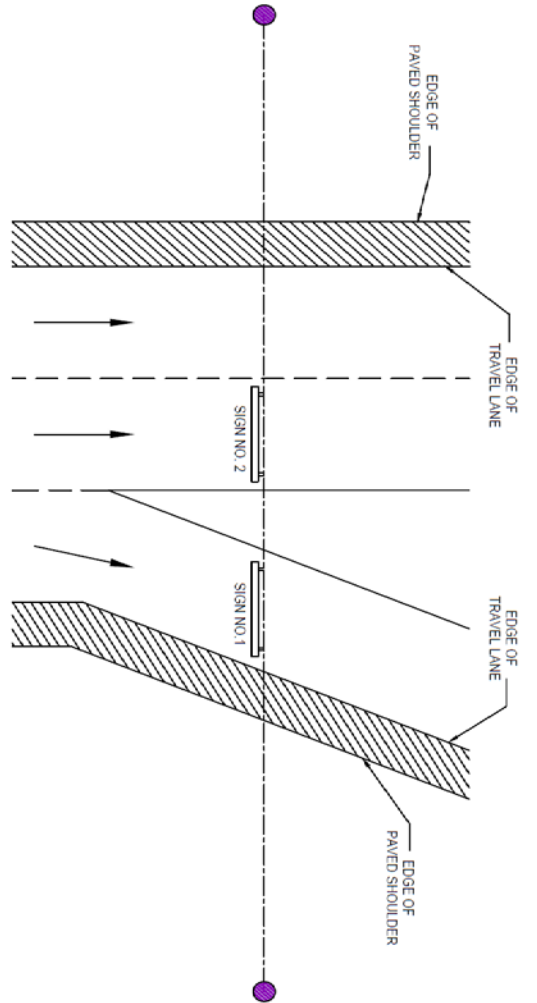

**ROAD WAY
TOP VIEW**

NOTES:
 * ALL OF THESE DIMENSIONS AND SLOPES NEED TO BE VERIFIED AND SUBMITTED TO THE ENGINEER FOR REVIEW.

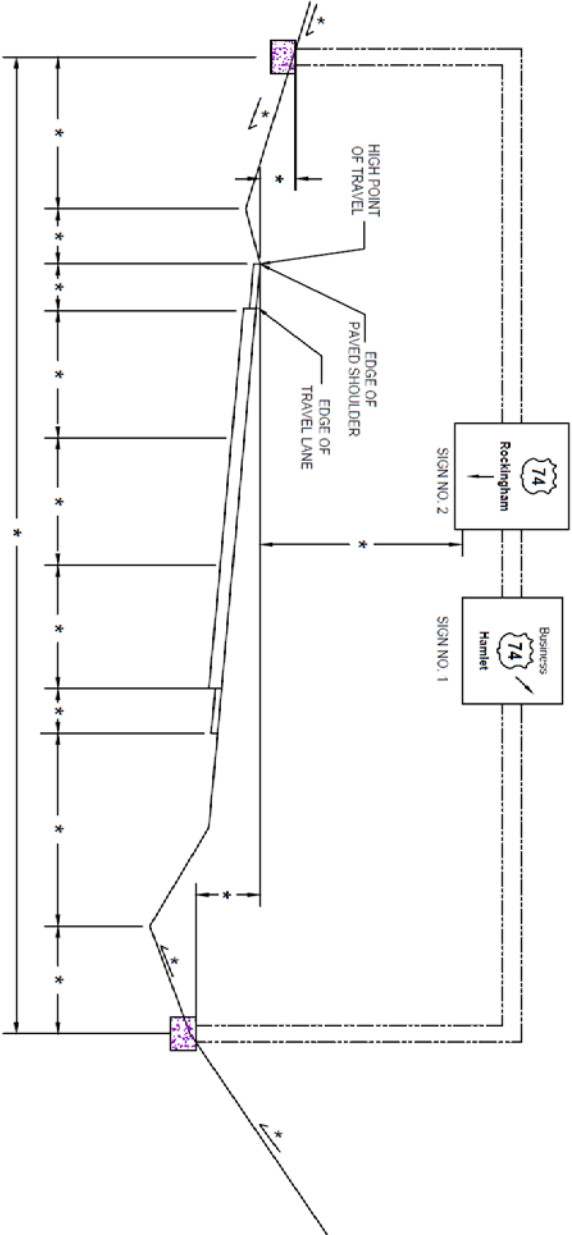

**TRAVEL LANE ELEVATION
FRONT VIEW**

Figure 16.1

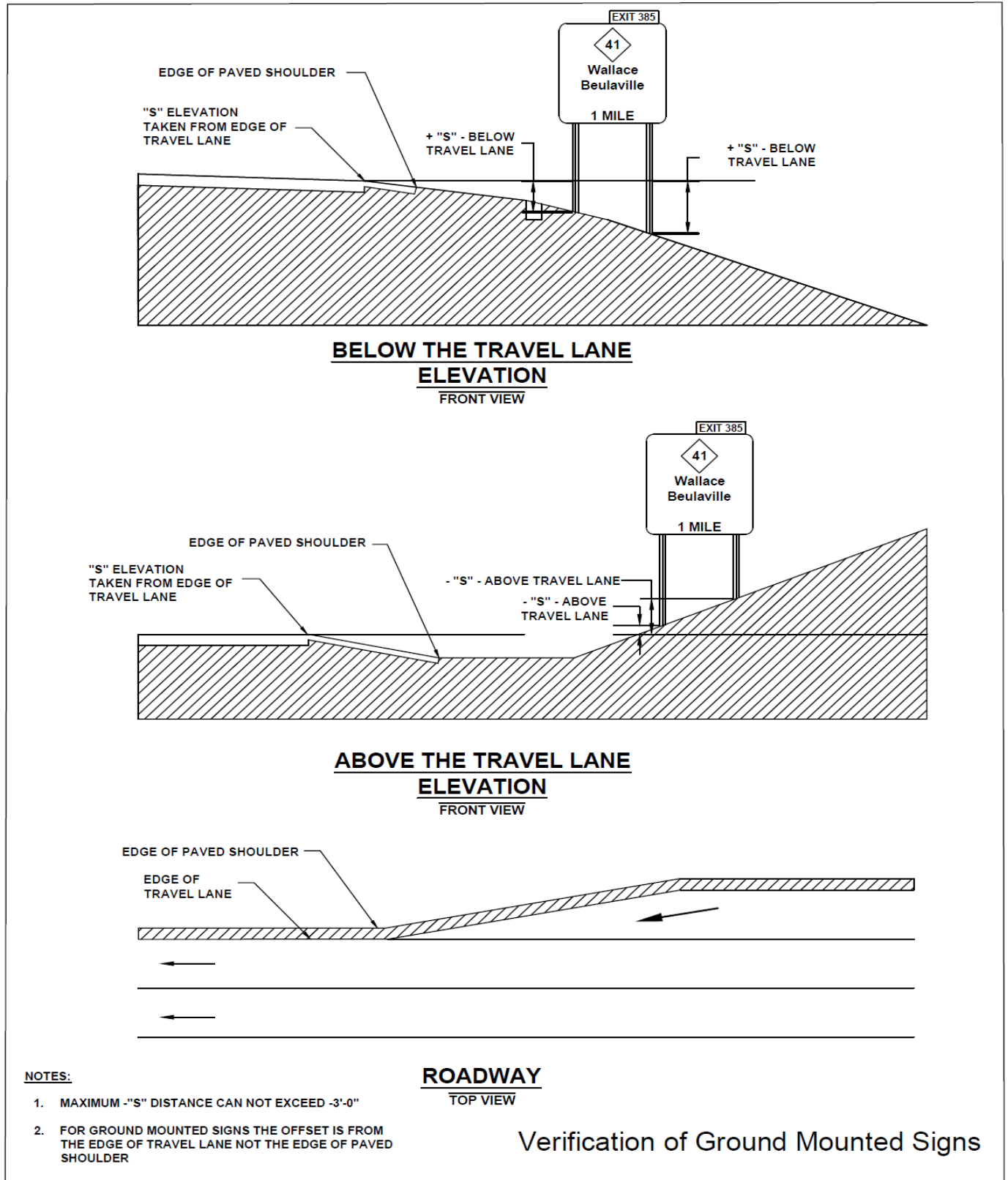
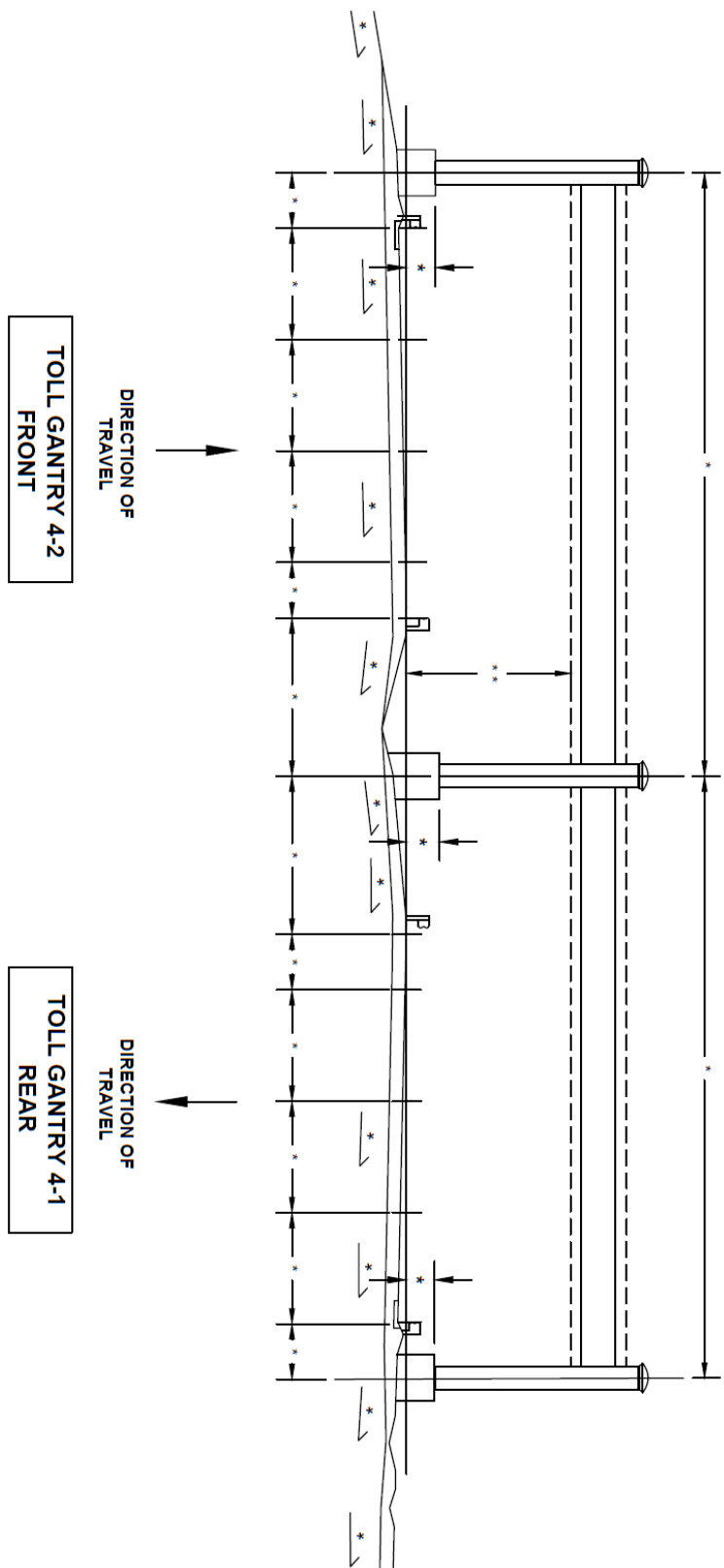

Figure 16.2



* NOTES:
 ALL OF THESE DIMENSIONS AND SLOPES NEED TO
 BE VERIFIED AND SUBMITTED TO THE ENGINEER
 FOR REVIEW.

* * BOTTOM OF STRUCTURE AND BOTTOM OF TOLL EQUIPMENT.

Overhead Signs

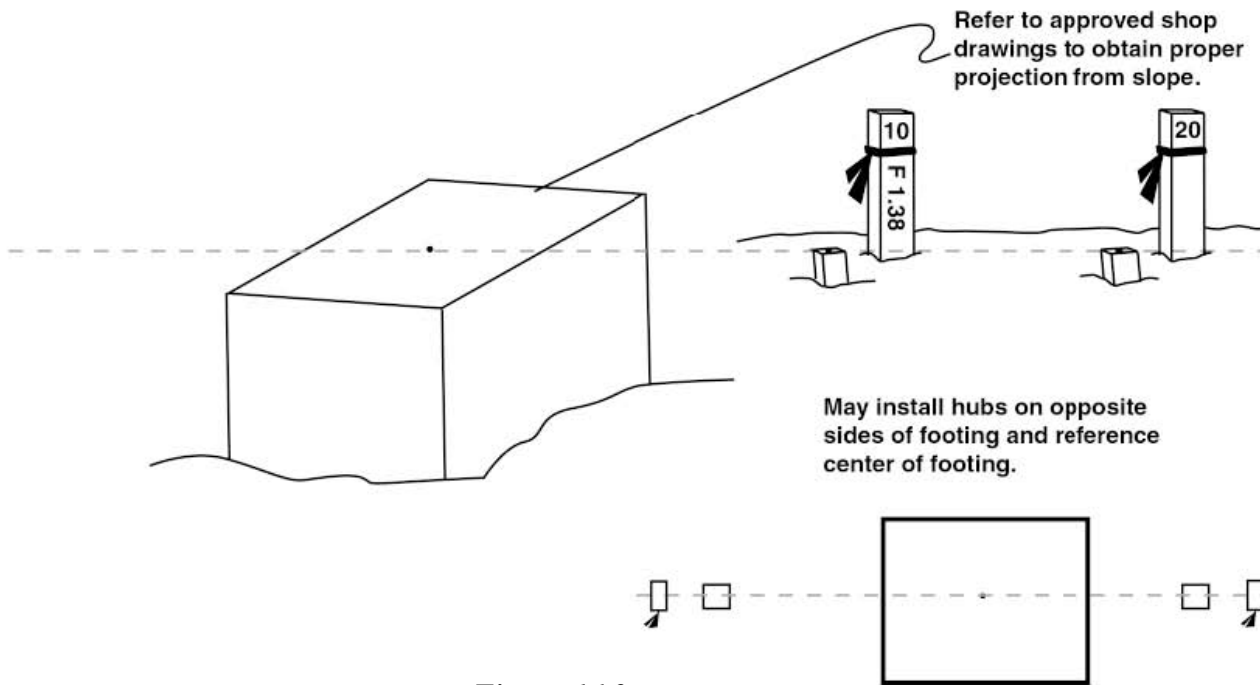

Figure 16.3

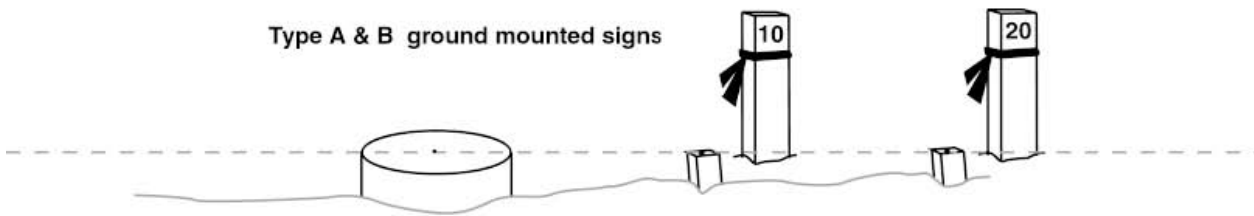

Figure 16.4

Typically grade information is not required for ground mounted signs.

Type D, E and F Ground mounted signs

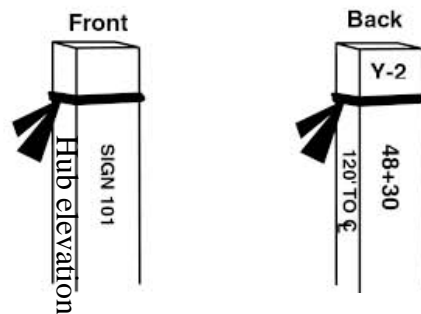

Figure 16.5

Sign Stakes

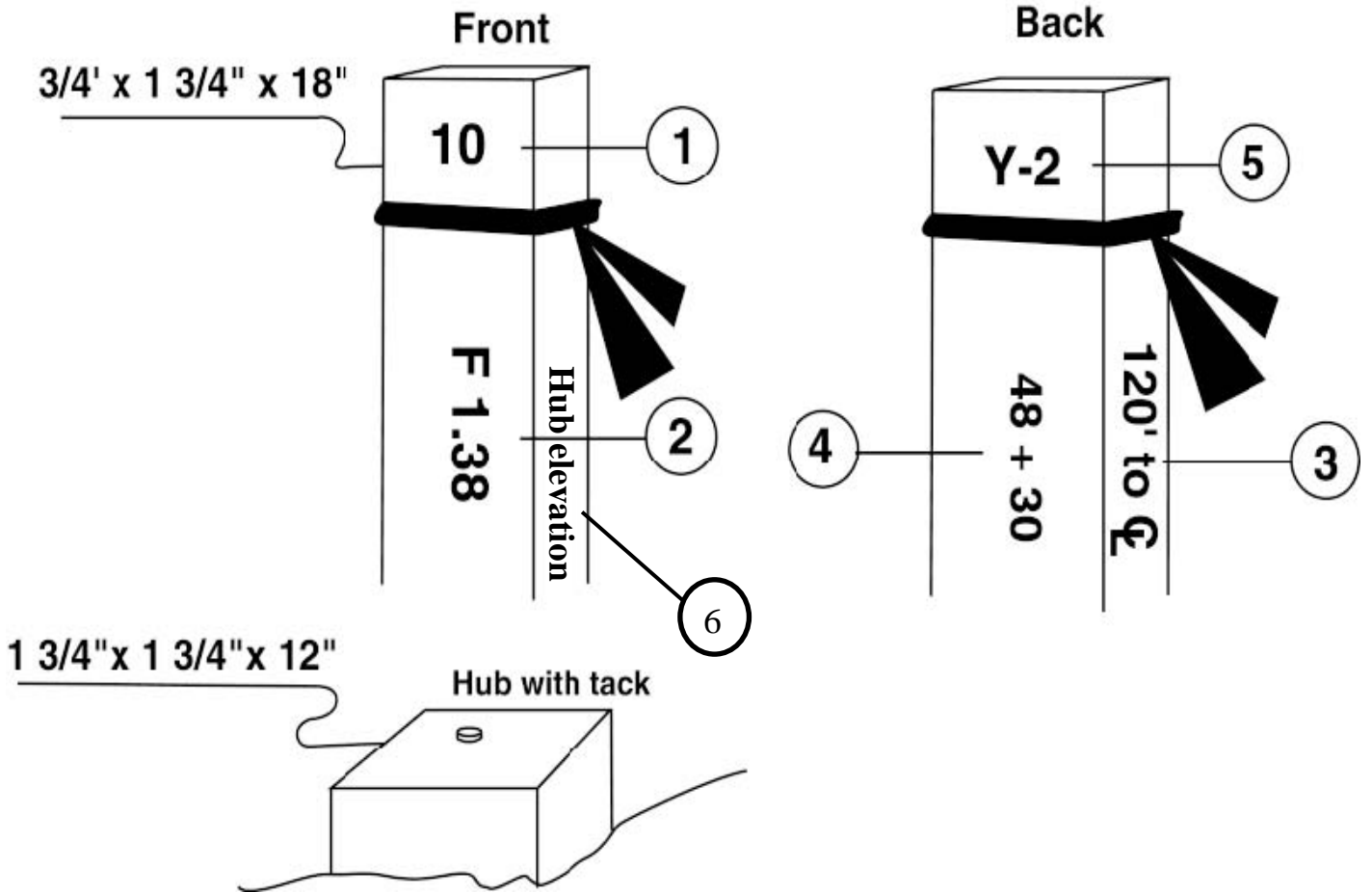

Figure 16.6



Chapter 17

Major Structure Stakes

17.1 Guideline Information

All major structures shall be staked with reference lines which contain at least three (3) reference hubs on each side with tacks. These hubs should be spaced equally apart at adequate intervals. Reference hubs shall be checked for accuracy after sitting all winter or as required by the Engineer. If two structures are side by side, then the reference hubs for each bridge should be color coordinated to eliminate confusion.

Bridge Stake Out

Bridge stake out will contain two reference lines for each end bent, interior bent, and the long chord line. (See *Figures 17.1a* and *17.1b*.) Set a minimum of two (2) temporary benchmarks to remain in place throughout the entire bridge construction. One benchmark is to be used for substructure and one for superstructure. On grade separation structures, a point of minimum vertical clearance may be shown on the general drawing. If shown on the plans, the elevation of this point shall be verified at the time of bridge layout.

Construction elevations are furnished from Structure Design for all bridges except cored slabs and box beams and should be used as follows:

Bottom of slab grades will be used to determine build ups at twentieth points along each girder of each span. (For longer spans 40th or 60th points may be required; this will be given in the construction elevation printouts.) After camber has been checked, necessary corrections made and diaphragm connection bolts tightened, elevations should be determined on top of girders at each twentieth point and are used in computing build-up heights. The effect of the sun can significantly change girder camber. Levels should be run either early in the morning or on a completely overcast morning. Deflections shown in the deflections tables are used in the required computations. Build-up height at a twentieth point is computed as follows:

- + final bottom of slab elevation (*provided by Structure Design or EOR*)
- + deflection due to weight of slab
- + deflections due to weight of parapet, rail, and F.W.S.
- top of girder elevation (determined in field)

The algebraic sum of these values equals the height of build-up above the top of girder. In some cases, this value will be minus indicating the girder flange projects into the slab.

The build-up heights for the entire bridge shall be computed and listed in a field book well in advance of any forming operation. These heights can be marked on the top of girder at the proper twentieth point.

The Contractor should be made aware that the computed height is at the centerline of girder and will vary at each side of the build-up depending on the crown slope and flange width.

Build-up shots shall be taken at the center of the girder correlating to the construction elevations submittal.

Overhang grades are no longer given as direct elevations. The revised construction elevations printout gives the elevation difference between the bottom of slab at the exterior girder and the bottom of slab at the outside edge of superstructure (i.e. bottom of overhang), shown as positive for an increase in elevation from bottom of slab to bottom of overhang, and negative for a decrease in elevation from bottom of slab to bottom of overhang. (See *Figure 17.2*.) Offset distances between the centerline of exterior girder and the outside edge of superstructure are also given for each of these elevation differences. These offset distances are measured normal to the centerline of girder at each 20th, 40th, or 60th point. These revisions eliminate the need for arc offsets in the plans (for curved deck bridges with straight girders) to establish the edge of slab. It also eliminates the need to calculate the elevation differences for each twentieth point.

Header grades are no longer given in the construction elevations printout. Headers should be left low and the screed allowed to finish over them to the proper elevation. See the “Suggested Procedure For Grading Screeds” section of Engineering Control in the Construction Manual.

Drilled shafts should be staked only after bridge stake out is complete. Each drilled shaft should be referenced individually so that casing and reinforcing steel alignment can be checked during drilling and casting operations. Each drilled shaft stakeout will contain two reference lines with two reference points on either side. If field conditions do not permit this type of referencing, then the Contractor should consult the Resident Engineer with a proposed method of referencing and receive approval. It is recommended that shafts should be staked at least thirty days prior to the pre-drill meeting and reviewed by the Area Construction Engineer to determine if permanent casing is necessary. This will allow for lead times necessary for ordering casing.

Approach slab grades are given to the finished slab grade. (See *Figure 17.3*.) It is important to check a point on the actual deck, at either end of the structure, which is relative to a given approach slab elevation to determine any necessary minor adjustment to the approach slab. Grades should be checked utilizing a stringline off the deck.

Cored Slab and Box Beam Overlays

No grades are provided for overlays on cored slab and box beam bridges. Instead, finished grade must be staked at centerline and the gutterlines. Fills should be marked on top of the slabs at tenth points along these lines to finished grade. These fills should be used for setting the barrier or parapet height and grading the screed for overlay thickness.

Culvert Stake Out

The grade that is provided on the structural plans is referenced to the centerline invert of the culvert. The length of the culvert should be checked to ensure that it intercepts the roadway slope properly. Culvert stake

out will contain a reference line for the centerline of barrel and for each culvert headwall face. Each reference point should refer to the intersection point of the centerline of the barrel reference line and the face of the culvert headwall reference line. Grades set on the hubs referencing the face of the culvert headwall will be set in reference to the top of the headwall or curtain wall. Intermediate hubs for culverts over 100' in length will be set at even intervals no greater than 50'+/- apart or at the construction joints. (See *Figure 17.4.*) Grades set on the centerline offset hubs shall reference the proposed elevation of the culvert invert. If plan inverts do not match field conditions consult the Engineer prior to making adjustments, due to environmental permit requirements.

Wall Stake Out

Noise walls, reinforced earth walls and retaining walls will be staked with a reference line to the face of the wall or as noted in the structure plans or as otherwise needed for construction. Existing ground elevations shown in the plans shall be verified for accuracy. For pile/panel type walls three (3) offsets shall be provided for each pile. All critical elevations shall be referenced, including, but not limited to, top of wall/ coping, bottom of shaft/pile, etc.

17.2 Submittal Requirements

1. Station and offset from centerline
2. Control points used
3. Coordinates
4. Utility locations for possible conflicts with walls, culverts and bridge substructure
4. Field layout notes

17.3 Type of Stake

Recommended Stake Size: ¾" x 1 ¾" x 18"

Recommended Flagging: Color Coordinated

Stake Use: Information

Recommended Stake Size: 1 ¾" x 1 ¾" x 12"

Recommended Flagging: Color Coordinated

Precision: Horz. 0.01', Vert. 0.01'

Stake Use: Alignment and Grade

Recommended Stake Size: ¾" x 1 ¾" x 48"

Recommended Flagging: Color Coordinated

Stake Use: Guard

Required equipment to be used: Robot (total station)

TYPICAL BRIDGE-TANGENT SURVEY LAYOUT

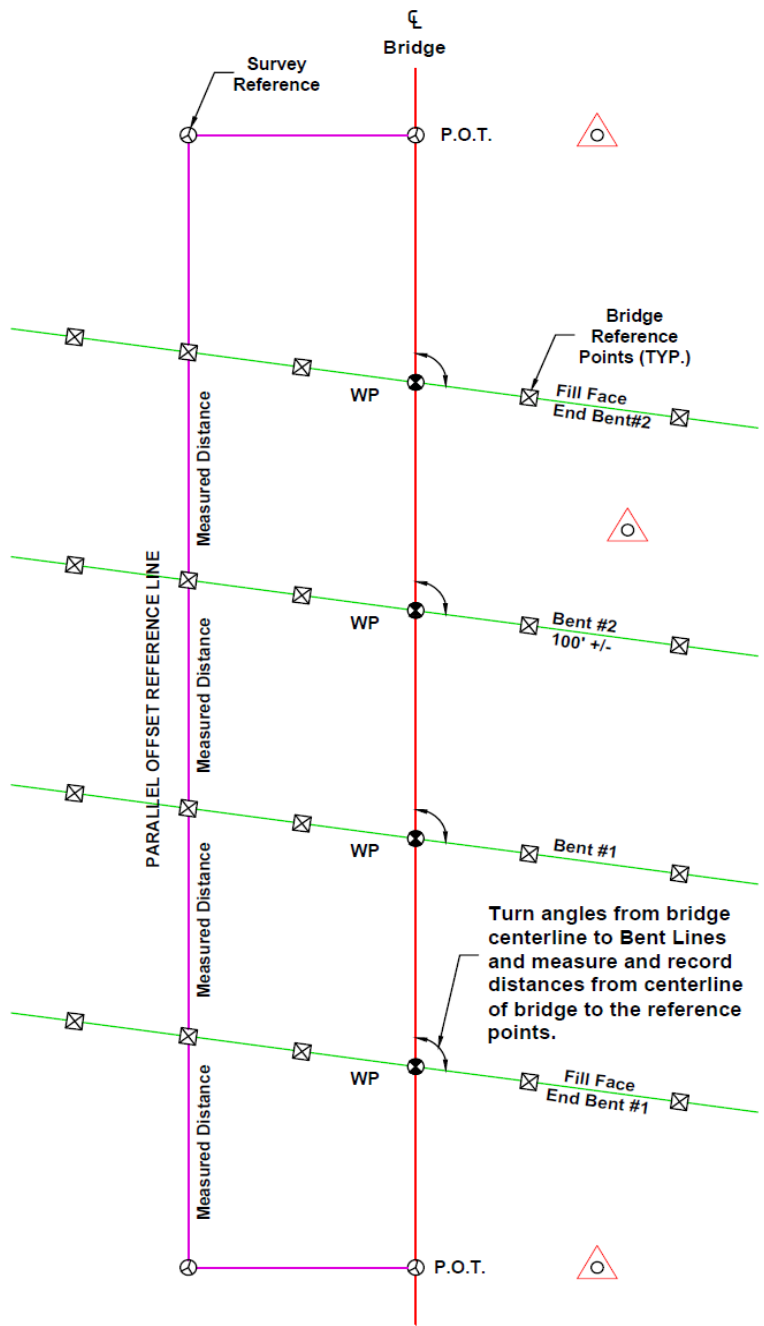

△BL Survey Control Points
Cap and Rebar Set by NCDOT.

⊗ Bridge Reference Points-
Tacked hubs with guard stakes and offsets along reference lines for each work point.

⊙ Survey Reference Points-
Tacked hubs with guard stakes and offsets along reference lines for each work point. Acceptable to use Mag Nails when work points or survey reference is on paved surfaces.

Bridges should not be layed out using radial stakeout unless prior approval has been obtained.

Figure 17.1a

TYPICAL BRIDGE-CURVE SURVEY LAYOUT

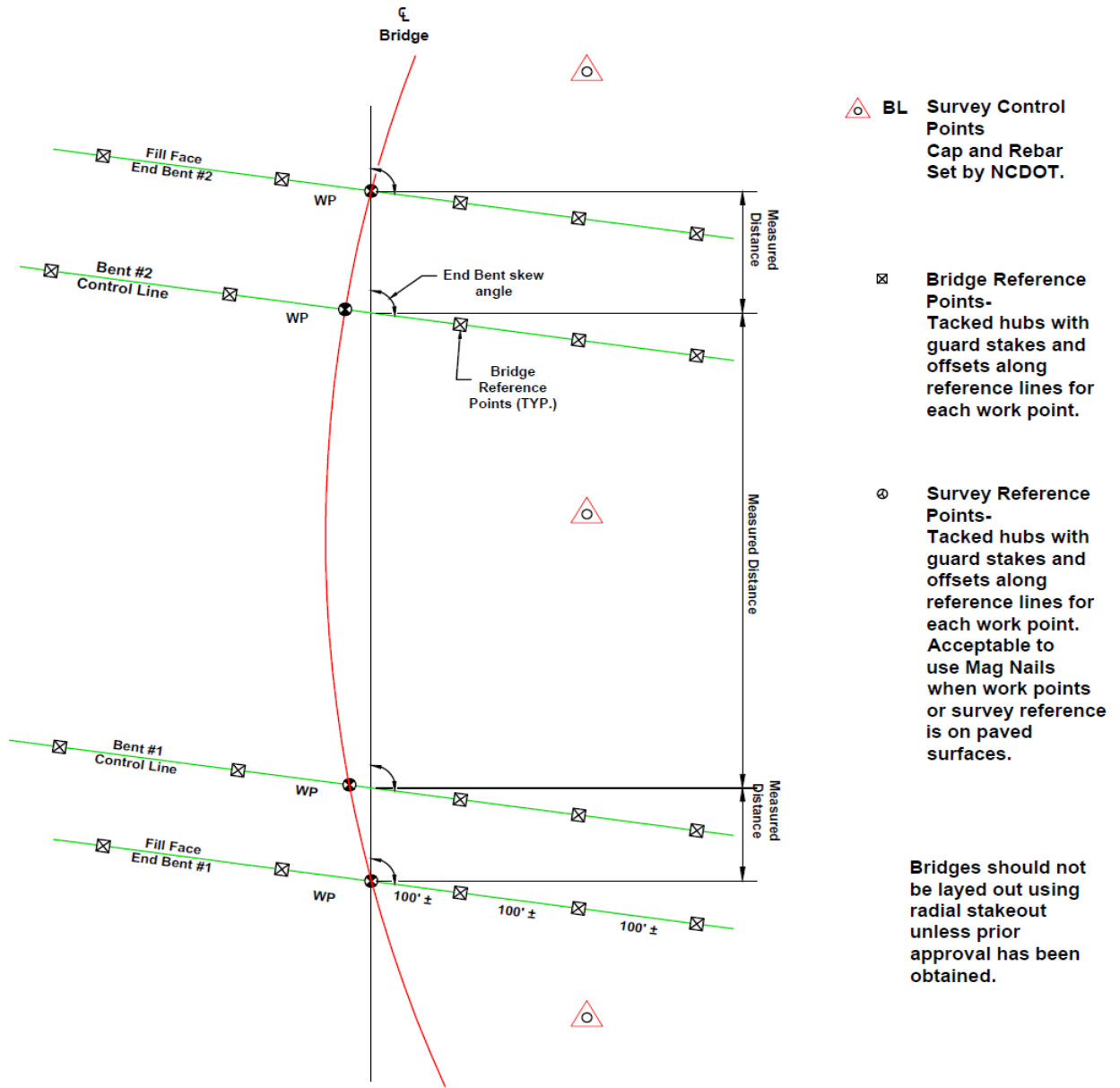
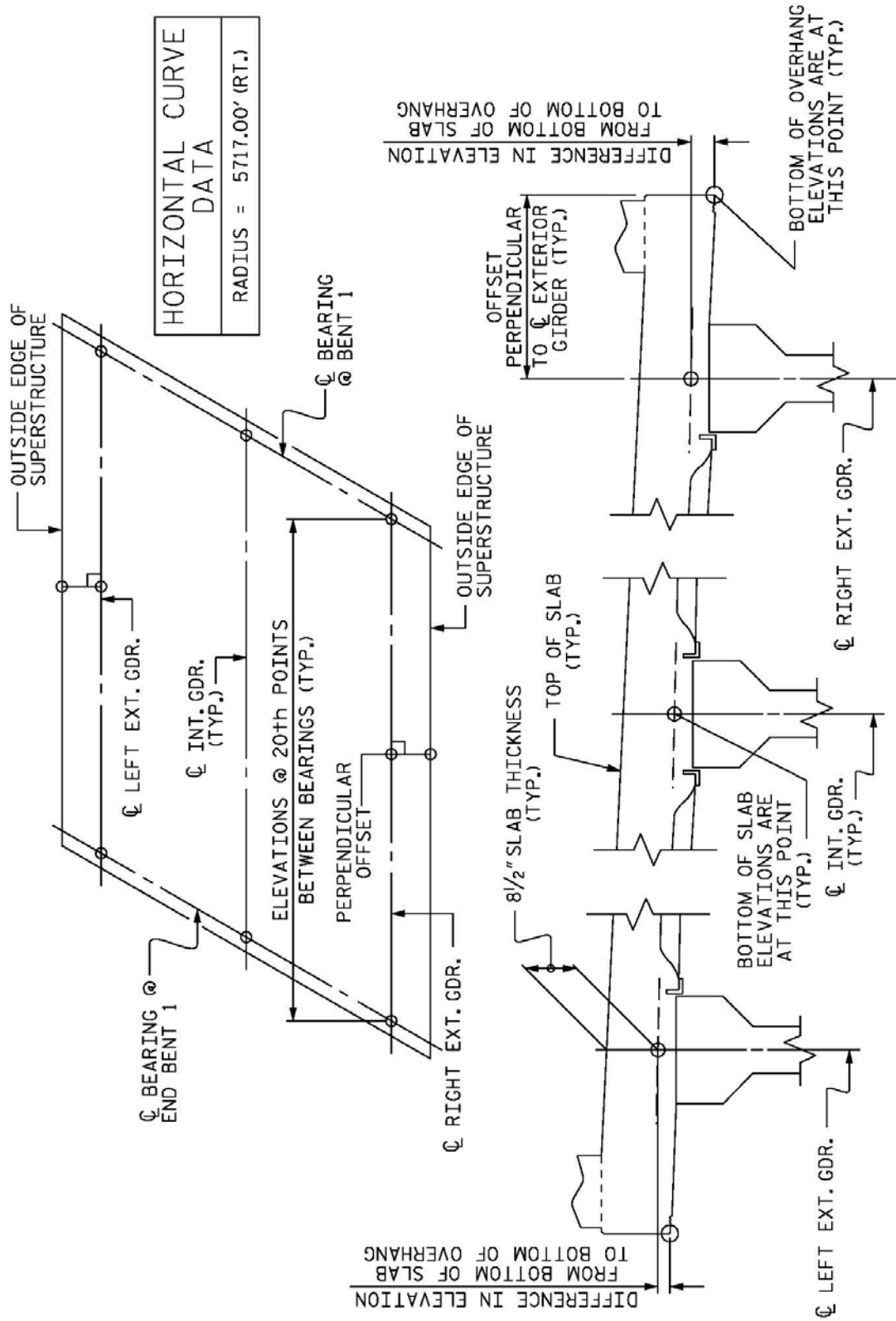

Figure 17.1b



BOTTOM OF SLAB ELEVATIONS
(SPAN AS SHOWN, OTHER SPANS SIMILAR)

CONSTRUCTION ELEVATIONS SKETCH
EXAMPLE SKETCH FOR CONCRETE GIRDER BRIDGE ON A CURVE

Figure 17.2

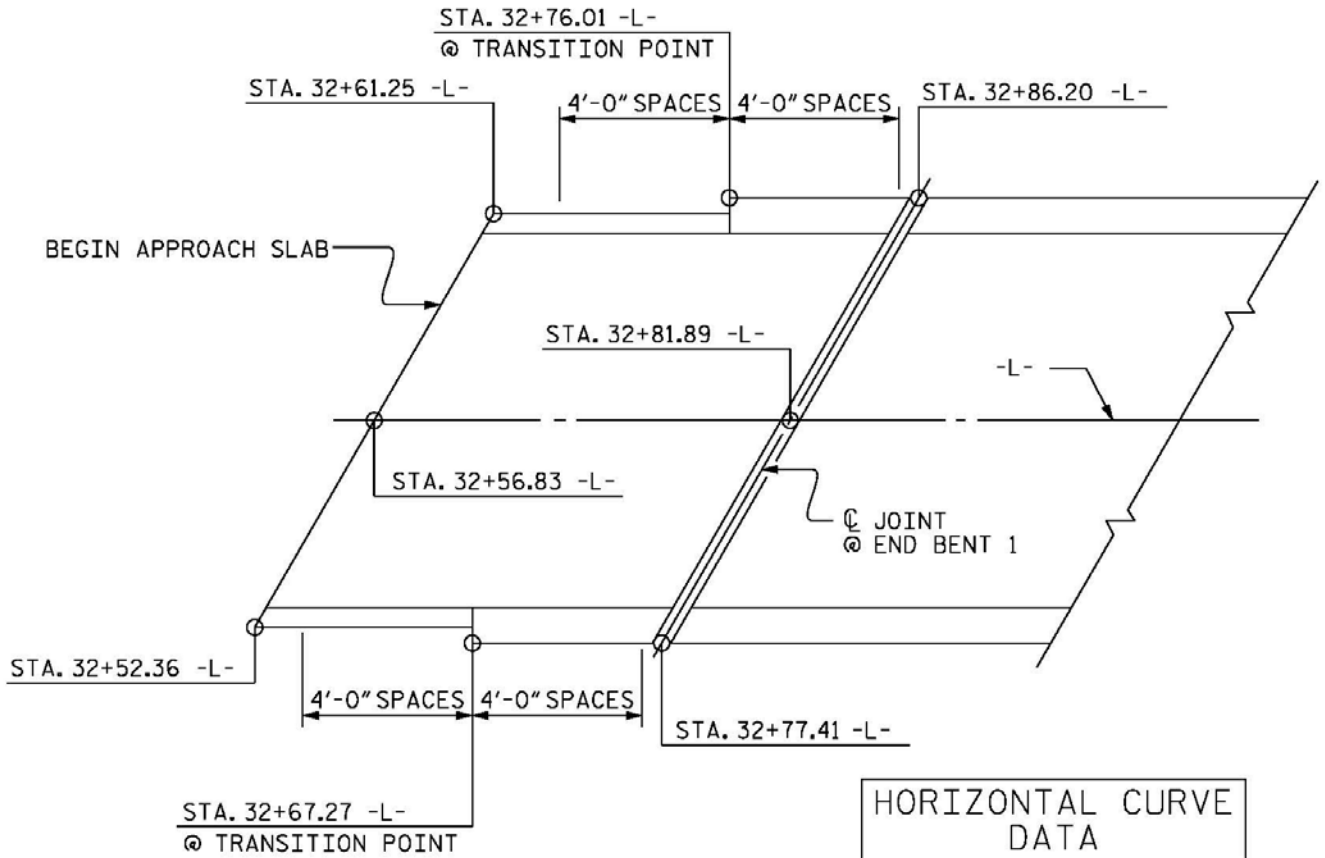

HORIZONTAL CURVE DATA	
RADIUS = 5717.00' (RT.)	

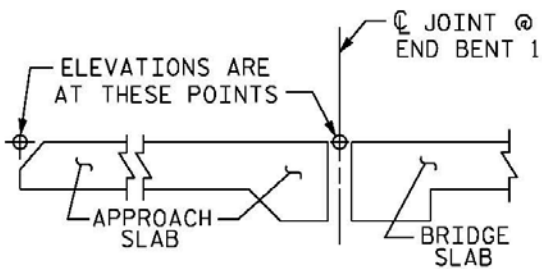

SECTION THRU SLABS

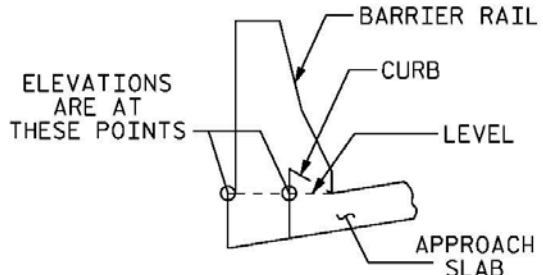

SECTION THRU CURB & BARRIER RAIL

APPROACH SLAB ELEVATIONS

(APPROACH SLAB @ BEGINNING OF BRIDGE SHOWN)

CONSTRUCTION ELEVATIONS SKETCH

EXAMPLE SKETCH FOR APPROACH SLAB ON CURVE
WITH EXPANSION JOINT SEAL AT END BENT

Figure 17.3

TYPICAL REINFORCED CONCRETE BOX CULVERT SURVEY LAYOUT

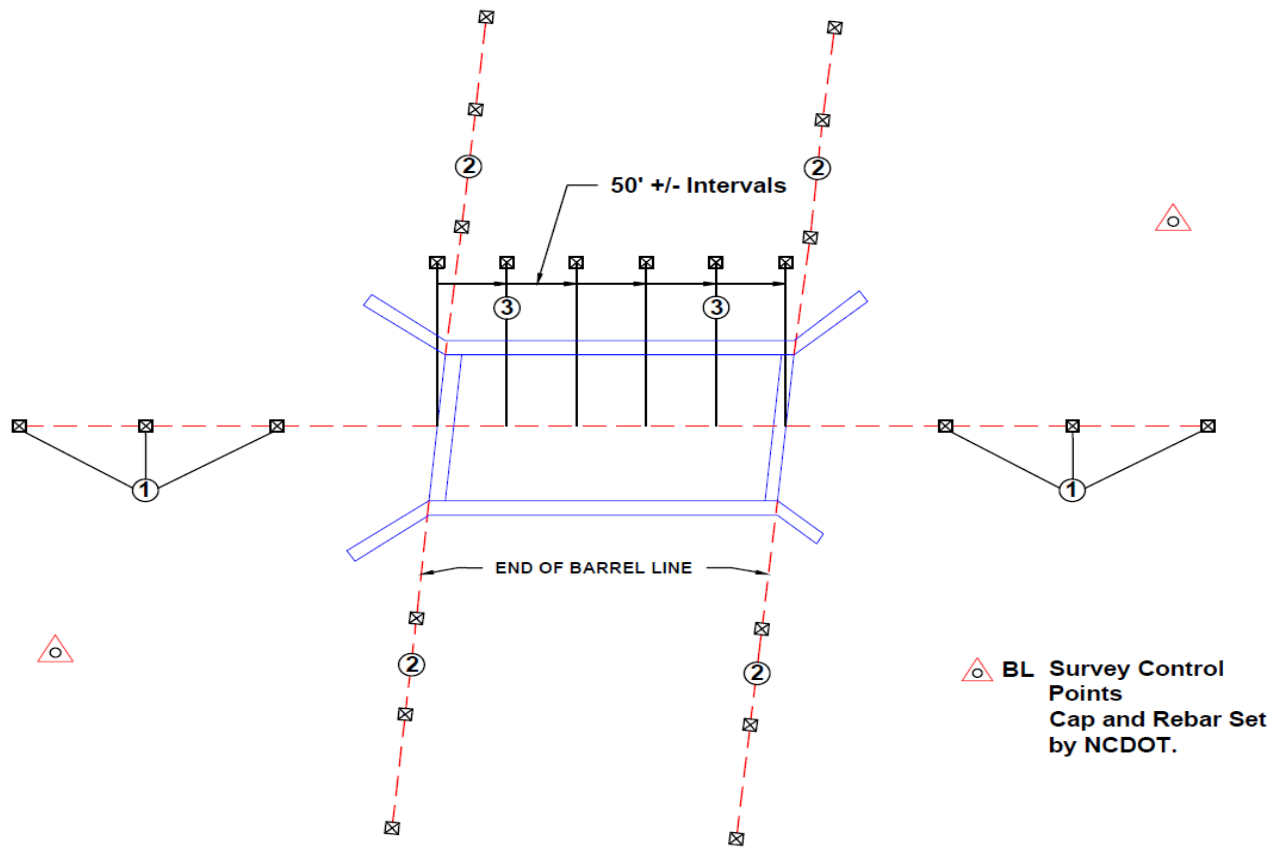

① ☒ Culvert Reference Points- Tacked hubs along centerline of culvert.

② ☒ Culvert Reference Points- Tacked hubs along end of barrel with distance marked to centerline of culvert and cut/fill to top of bottom slab on guard stake.

③ ☒ Culvert Reference Points- Hubs with marked guard stakes giving offset and cut/fill to top of bottom of slab - including camber.

△ Survey Control Points
Cap and Rebar Set by NCDOT.

Figure 17.4



Chapter 18

Cross-sections for Earthwork Quantities

18.1 General Information

The Engineer may elect to obtain cross-sections or Digital Terrain Models (DTM) by using either hand or aerial methods depending on the topography, vegetative cover, and size of the project or borrow sites. The Department often utilizes aerial photography to obtain cross-sections for calculation of earthwork quantities. Aerial photography requires the installation of photogrammetric control panels. Once panels are installed, the Photogrammetry Unit can orient the film both horizontally and vertically and obtain a correct scale.

18.2 Guideline Information

If the Engineer elects to hand section the project, set centerline stakes for all alignments on 50 foot (20 meter) intervals as detailed in Chapter 3. Offset alignments also may be required.

If the Engineer elects to obtain cross-sections by aerial methods, the Engineer will provide the photogrammetric panel locations. The staking of the survey line is typically not required when setting photogrammetric panels at the predetermined locations. Set panels at the locations shown in the panel plan, and provide a panel book detailing the panel coordinates. Install photogrammetric panels as detailed below:

Photogrammetric Control Panels

Install photogrammetric panels on 5-foot x 5-foot sheets of black plastic or paint them on the roadway surface. An oil based exterior paint is recommended to mark the panel arrows. Panel arrows should have legs approximately 5 feet in length and six inches in width. (See *Figure 18.1.*) The point of the arrow represents the photogrammetric control point.

The Engineer will obtain the vertical elevations for each panel.

Maintain the photogrammetric panels until a successful aerial photograph has been obtained. Photogrammetric panels must be clearly visible on the scheduled flight day.

Other methods of cross-sections for earthwork may be submitted to the Engineer for review. Methods should be submitted for all waste and borrow sites prior to using the sites.

18.3 Type of Stake

Panel Size: 60" x 60" sheet of black plastic with arrow
Precision: Horz. 0.01'
Stake Use: Location

AERIAL FLIGHT PANEL CONFIGURATION

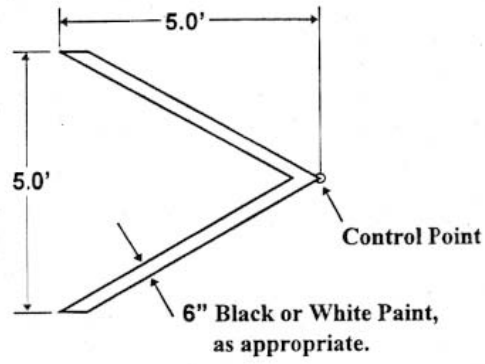

Typical configuration for asphalt or concrete surfaces.

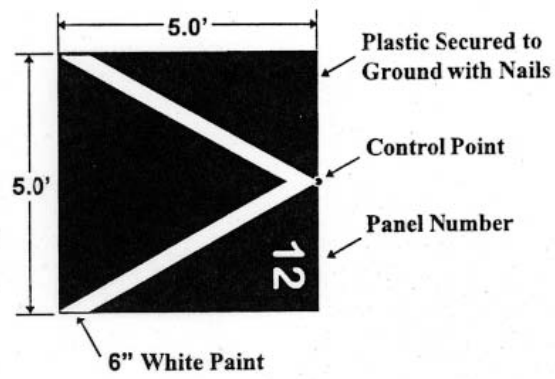

Typical configuration for earth or other surfaces.

Figure 18.1



Chapter 19

Automated Machine Guidance

19.1 General Information

If the Contractor elects to use Global Positioning System (GPS) machine control grading it shall be used in conjunction with Section 801 of the Standard Specifications for Roads and Structures. The use of this technology (or similar technology) is referenced as Automated Machine Guidance (AMG). All equipment using AMG shall be able to generate end results that meet the Standard Specifications. Perform test sections for each type of work to be completed with AMG to demonstrate that the system has the capability to achieve acceptable results. If acceptable results cannot be achieved, conform to the requirements for conventional stakeout.

The Contractor shall be responsible for all errors resulting from the use of AMG and shall correct deficiencies to the satisfaction of the Engineer at no cost to the Department.

19.2 Subgrade and Base Controls

If the Contractor elects to use AMG for fine grading and placement of base or other roadway materials, the GPS shall be supplemented with a laser or robotic total station. Include details of the proposed system in the AMG work plan. In addition, the following requirements apply for the use of AMG for subgrade and base construction.

1. Provide control points at intervals along the project not to exceed 800 feet or as recommended by the manufacturer for the equipment in use. The horizontal position of these points shall be determined by traverse connection from the original base line control points. The elevation of these control points shall be established using differential leveling from project benchmarks, forming closed loops where practical. A copy of all new control point information shall be provided to the Engineer prior to construction activities.
2. Provide conventional survey grade stakes at 500' intervals and at critical points such as, but not limited to, PCs, PTs, tapers, changes in roadway width, and other critical points as requested by the Engineer.
3. Provide hubs at the top of the finished subgrade at all hinge points on the cross section at 500-foot intervals. These hubs shall be established using conventional survey methods for use by the Engineer to check the accuracy of construction.
4. Stakes shall be provided prior to the start of fine grading at 100' intervals and at offsets between 3' and 10' from the edge of pavement (edge of asphalt) on the outside shoulder. These stakes shall remain in place until the final lift of pavement is completed. All stakes shall have offset distance and station number provided on the stake. The stakes will provide reference for proof rolling operations, fine grading operations, and paving operations.
5. Slope stakes shall be set regardless of grading methods for slope protection under bridges, cross line pipe, culverts, wetlands, and other jurisdictional boundaries.

19.3 Submittal Requirements

If the Contractor elects to use AMG, a Digital Terrain Model (DTM) of the design surface and all intermediate surfaces shall be developed and submitted to the Engineer for review. At least 90 days prior to beginning grading operations, the Contractor shall submit to the Engineer an AMG work plan to include, but not limited to, proposed equipment, control software manufacturer and version, types of work to be completed using AMG, project site calibration report, repetitive calibration methods for construction equipment and rover units to be used for the duration of the project, how the Contractor will check into bench marks and the frequency of check-ins, and local GPS base station to be used for broadcasting differential correction data to rover units (this may include the NC Network RTK). All surveys must be tied to existing project control as established by NCDOT.

The AMG plan may be submitted as one submittal in its entirety or multiple AMG plans may be submitted for separate operations using machine control. Plans must be submitted for all operations using machine guidance including but not limited to rough grading, fine grading, chemical stabilization, concrete paving, and asphalt paving operations.

Until the DTM and AMG plan are received and approved by the Engineer, the Contractor shall provide conventional stakes and use conventional staking methods for all operations including but not limited to slope stakes, intermediate grade stakes, ditch stakes, and fine grade stakes.

19.4 Inspection

If the surveying /construction layout/oversight plan or machine accuracy control is deemed unacceptable by the Department, during any part of planning, design, or construction, the Contractor may be required to revert to requirements of Section 801 of the Standard Specifications and conventional staking.

The Contractor shall provide the Engineer with one GPS rover unit for use during the duration of the contract. The rover will be loaded with the same model that is used with the AMG and have the same capability as rover units used by the Contractor. The rover will be kept in the possession of the Engineer and will be returned to the Contractor upon completion of the contract. Any maintenance or repairs required for the rover will be the responsibility of the Contractor. Formal training of at least 8 hours shall be provided to the Engineer by the Contractor on the use of the proposed AMG system.



Chapter 20

GPS

20.1 General Information

The Contractor may elect to utilize Global Positioning System (GPS) surveying, either static or kinematic. Perform GPS surveys with same or higher order of accuracy as conventional surveys. NCDOT projects utilize a localized coordinate system developed by the Location and Surveys Unit specifically for each individual project. Using the Survey Control Sheet located in the plans, obtain the control information that the Location and Surveys Unit utilized in establishing the localized coordinate system, specifically the Rotation, Scaling, Translation and coordinates for the azimuth pairs. This will aid in the comparison of actual results.

If no site calibration is provided in the plans, perform a site calibration and include the results in the required horizontal and vertical control verification submittal for approval.

Newly developed GPS procedures and techniques that do not conform to the Specifications in this section may be used if approved by the Engineer.

For additional guidance in performing GPS, see the GPS Survey Guidelines in the NCDOT Location and Surveys Manual. The link to the manual is below.

http://www.ncdot.org/doh/preconstruct/highway/location/support/Support_Files/Documents/Manuals/LocationGPS0210.pdf

Appendix

Example

Report of Final R/W and Permanent Easement Survey

(Replacement and /or Re-establishing Verification of Right of Way and Permanent Easement Markers
for the North Carolina Department of Transportation)

TIP No.:

Project No.:

County:

Project Description:

Plans Recorded in: <County Highway Plan Book designation, i.e. Map Book, Page>

I certify that this survey was done under my responsible charge in accordance with the **NCDOT Survey Standards** as directed in the **NCDOT Location & Surveys Guidelines and Procedures** and the **Manual for Construction Layout** for the purpose of (re-establishing/replacement) of R/W and/or permanent easement markers. That per the Project Plans of Record the following list of markers were either re-established or replaced at the following station/offset locations:

Line Descriptor (-L,-Y-, etc.)	Station	Offset	Northing	Easting	Re-placed or Re-established	Type and Material of Original Marker	Type and Material of New Marker
Examples L	28+56.23	148.66, Rt.	878,948.23	2,456,128.92	Re-placed	R/W, Iron Pin & Cap	R/W, Concrete
Y	58+72.66	167.89, Lt.	868,785.45	2,456,849.88	Re-established	Easement, Iron Pin & Cap	Easement, Iron Pin & Cap

All bearings and coordinates are referenced to the North Carolina State Plane Coordinate System per Plans of Record.

Witness my signature, registration number and seal this ____ day of _____, 20XX

Professional Land Surveyor (Print Name)

PLS#



Surveyor's Seal

Signature