

# Placement of Detection Loops on High Speed Approaches to Traffic Signals

NCDOT Project HWY 2007-13

by

**George F. List, Ph.D., P.E.**

Professor

T: (919) 515-7212 E: [gflist@ncsu.edu](mailto:gflist@ncsu.edu)

**Alixandra Demers, Ph.D.**

Research Assistant Professor

T: (919) 515-7212 E: [ademers@ncsu.edu](mailto:ademers@ncsu.edu)

**Isaac Kumar Isukapati**

Graduate Research Assistant

T: (919) 515-7212 E: [isaac\\_assiduous028@yahoo.com](mailto:isaac_assiduous028@yahoo.com)

Department of Civil, Construction, and Environmental Engineering  
North Carolina State University  
Raleigh, North Carolina 27695-7908

and

**Edd Hauser, Ph.D., P.E.**

Professor and Director

T: (704) 687-3997 E: [ehauser@uncc.edu](mailto:ehauser@uncc.edu)

**Srinivas S. Pulugurtha, Ph.D., P.E.**

Associate Professor and Assistant Director

T: (704) 687-6660 E: [sspulugurtha@uncc.edu](mailto:sspulugurtha@uncc.edu)

Center for Transportation Policy Studies  
University of Carolina at Charlotte  
Charlotte, North Carolina 28223

for the

ITS and Signals Unit / Traffic Signals Branch  
North Carolina Department of Transportation

March 5, 2010

Report No. FHWA/ NC/ 2007-13	Government Accession No.	Recipient's Catalog No.	
Title and Subtitle: Placement of Detection Loops on High Speed Approaches to Traffic Signals		Report Date March 5, 2010	
		Performing Organization Code	
Author(s) G.F. List, A. Demers, I.K. Isukapati, E. Hauser, S.S. Pulugurtha		Performing Organization Report No.	
Performing Organization Name and Address Department of Civil, Construction & Environmental Engineering, NC State University, Raleigh NC 27695-7908		Work Unit No. (TRAIS)	
		Contract or Grant No.	
Sponsoring Agency Name and Address North Carolina Department of Transportation  ITS and Signals Unit / Traffic Signals Branch North Carolina Department of Transportation		Type of Report and Period Covered Final Report July 1, 2006 – August 15, 2009	
		Sponsoring Agency Code NCDOT Project HWY 2007-13	
Supplementary Notes:			
<p>Abstract: High-speed, signalized intersections require special attention to ensure safe operation. The dilemma zones of approaching vehicles need to be protected. One crucial element is the placement of detectors, especially those that sense approaching vehicles on the mainline when a change interval is about to commence. This research found that well-placed detectors and a carefully chosen signal timing strategy reduced the likelihood that vehicles would be caught in dilemma zones at the onset of yellow. Field studies were conducted at three sites in North Carolina, preceded by simulation studies at those three locations and two others. Innovations in wireless detector installation played a role in the field studies. The safety and efficiency benefits from pursuing this new configuration appear to significantly outweigh the costs, so the authors believe the idea should be considered strongly for widespread use.</p>			
Key Words Detector placement, signal timing, control, hardware-in-the-loop simulation, truck safety		Distribution Statement	
Security Classif. (of this report) Unclassified	Security Classif. (of this page) Unclassified	No. of Pages 100	Price

Form DOT F 1700.7 (8-72)

Reproduction of completed page authorized

## **Disclaimer**

The contents of this report reflect the views of the authors and not necessarily the views of the University. The author(s) are responsible for the facts and the accuracy of the data presented herein. The contents do not necessarily reflect the official views or policies of the North Carolina Department of Transportation at the time of publication. This report does not constitute a standard, specification, or regulation.

## Preface

This report contains the results of the NC Department of Transportation research project *Placement of Detection Loops on High Speed Approaches to Traffic Signals* (HWY 2007-13). The goal of this project was to determine the best places to locate detectors on the approaches to high-speed signalized intersections and the best signal control strategy to employ in conjunction with those sensor placement ideas to minimize dilemma zone occurrences.

The Executive Summary provides a very high-level, one-page overview of the project and its findings.

The Executive Report provides a 14-page summary of the project and provides enough detail that someone can gain a sense of what was done and what findings were obtained.

Chapter 1 defines the NCDOT needs and issues related to the research problem. It also presents the research objectives and challenges. Similar research conducted elsewhere is reviewed briefly to put the project into context vis-à-vis other, previous studies.

Chapter 2 provides a literature review covering state-of-the-art dilemma zone research. A short discussion on the shift from defining dilemma zones as distance-based to time-based is introduced. The key methods of handling dilemma zones are mentioned. Various sensor configurations were tested by researchers. Based on the literature review, recommendations for an NC solution are offered with the rationale for why the Detector-Control System (D-CS) was selected for testing in the project.

Chapter 3 covers the current design practices by North Carolina and other states. The finding is the NCDOT is a best-practice state and has to push the frontier of practice through innovation as this project is doing.

Chapter 4 presents the evaluations that were conducted as part of the project, both via simulation and field testing. The methodology employed is described as well as the results obtained.

Chapter 5 presents the results of a cost-benefit analysis. It compares existing, standard practice with the NQ4 high-speed, special treatment that NCDOT normally follows as well as the D-CS based treatment that was also included in the evaluations. The conclusion is that while both NQ4 and D-CS are good treatments, D-CS is slightly better, and provides a higher benefit-to-cost ratio.

Finally, Chapter 6 summarizes the research and Chapter 7 offers concrete recommendations for the NCDOT to consider implementing to minimize dilemma zone occurrences at rural, high-speed, signalized intersections.

## **Acknowledgements**

The research team would like to extend extreme thanks to the many people from NCDOT who helped make this project a success. One particular individual is Mark Harrison, whose guidance, counsel and support was critical to success. He worked with us to understand the workings of NCDOT intersections, detectors, and controllers; helped with troubleshooting in the field, often by cell phone; and assisted in arranging the logistics to move the signal controller, cabinet, and wireless detectors to and from the field sites. We are also indebted to about 30 people among the field crews in Divisions 3, 4, and 14 who labored willingly and tirelessly to help us change the controller and the detector configurations at the three field sites. Research teams always dream that such field experiments will be feasible, but rarely do they happen with such ease, excitement, and enthusiastic support. It is hoped that their efforts will lead to improved safety and efficiency as the results of our efforts are integrated into the operation of NCDOT. We are also very thankful for the guidance and counsel of the Steering and Implementation Committee, especially Pamela Alexander, who tirelessly and enthusiastically championed our cause and worked within NCDOT to ensure that our needs would be met and the project would progress to a successful closure.

## Executive Summary

This study focused on improving the way NCDOT provides for safe and efficient operation of signalized intersections in rural areas. The safety concern relates to high-speed right-angle, rear-end, and other collisions that occur because motorists are not expecting to see a signal, let alone one that is displaying yellow or red. The challenge is for the signal control strategy to prevent vehicles from being in dilemma zones, where the motorist is not sure whether to continue or stop, when the transition to yellow occurs, while not compromising efficient operation.

Currently, NCDOT treats such situations by adding advance vehicle detection using the NQ4 system, flashers and warning signals, and other site-specific improvements as a supplement to volume-density control. Thus, the question was this: is there a better way to provide protection that is less costly, more effective, and simpler?

A survey of best practice suggested that the Detector-Control System (D-CS) developed by Bonneson *et al.* (2002) would be worth testing.<sup>1</sup> It seemed to produce good results, be robust in its impacts, and be simple to implement. It also seemed likely to be cost effective since it did not involve more sensors than NCDOT presently uses for the NQ4 installations.

Both the hardware-in-the-loop simulation tests and the field studies showed that the D-CS system did work well. It reduced the likelihood that vehicles are caught in dilemma zones at the onset of yellow, and it did so without compromising efficiency. Moreover, cycle lengths did not increase after D-CS was introduced. In contrast to the NQ4 system, which was also tested, and did quite well, both in simulation and in the field, D-CS tended to produce shorter cycle lengths (more efficient and responsive operation) and it did a slightly better job of ensuring that no vehicles were in dilemma zones at the onset of yellow.

The benefit-cost (BC) assessment, which was predicated on the hardware-in-the-loop simulation results, found that the D-CS system had a high payoff. It produced BC ratios significantly greater than 1.0 and the ratios were higher for the D-CS system than for the NQ4 system.

The main recommendation is that NCDOT proceed ahead with plans to add the D-CS capability to the existing OASIS software and that, in the short run, it allow divisions to order Naztec controllers that include D-CS as an optional feature for special cases where short-term treatment is needed.

Recognizing that NCDOT is currently evaluating wireless detector technology in select locations throughout the state, the team offers the following insights. In the space of 2-4 hours, at two locations, the research team and NCDOT field crews were able to install wireless sensors in the pavement, mount the repeaters and the access point, connect the detectors to the controller, and start using them to control traffic. The field crews were impressed by the ease with which the sensors were installed, and their effectiveness, and they expressed hopefulness that NCDOT would, at some time in the near future, allow the use of such detectors when deemed prudent.

---

<sup>1</sup> An easy-to-find reference is Zimmerman, K., and J.A. Bonneson. "Improving Intersection Safety with an Innovative Collision Avoidance System," *ITE Journal*, February 2007, pp. 24-29.

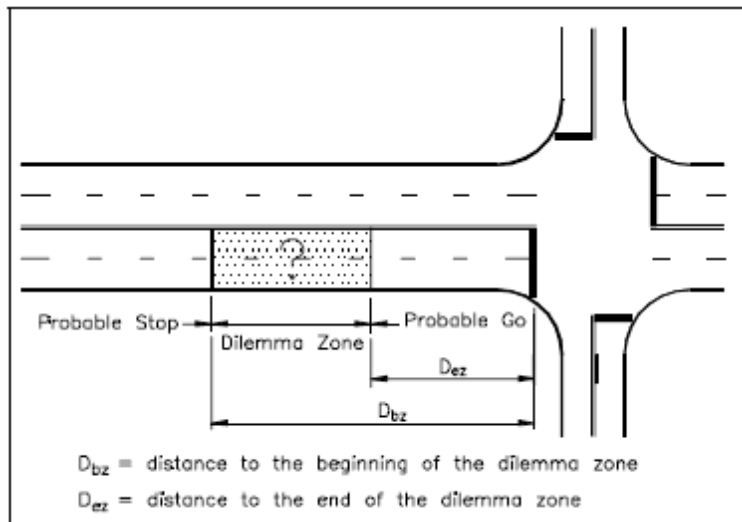
# Executive Report

## Introduction

It is clearly in the interest of public safety to have high-speed, rural, signalized intersections operate as safely as possible. These facilities, that tend to be unexpected by motorists, can have higher likelihoods of accidents because the motorists are not expecting to see a signal let alone an yellow or red indication. The challenge is to minimize the likelihood that motorists will face a dilemma about whether they should stop or pass through when an yellow occurs. The crucial elements are 1) detector placement, especially those that sense the approach of mainline vehicles when a change interval is about to commence and 2) the signal control logic. This research finds that well-placed detectors and a carefully chosen signal timing control strategy can improve the safety of these intersections without jeopardizing their efficiency.

In this regard, NCDOT enjoined the research team to 1) investigate current best practices, theories, and trends; 2) model the impact of various vehicle detection loop distance placements using simulation; 3) field evaluate alternate vehicle detection loop placements; 4) determine the costs and benefits of recommended practices generated from research including the impact on vehicle delay; and 5) develop new recommended practices.

The main idea is dilemma zone protection. A “dilemma zone” is the region where, as shown in Figure E.1 drivers are unsure whether they should continue through the intersection or stop. Some researchers define it based on distance; others use time.



**Figure E.1 Typical Dilemma Zone Definitions**

(Source, Bonneson *et al.*, 2002)

Bonneson *et al.* (2002) conclude that the dilemma zone boundaries are most precisely defined if travel time from the stop line (as opposed to distance) is used. Further, they conclude that it is practical to use the 90<sup>th</sup> and 10<sup>th</sup> percentile drivers, respectively. This means the boundaries for

the dilemma zone should extend from about 5.5 seconds away from the stop bar to about 2.5 seconds away, a result that is followed in this research.

## **Review of Theory and Practice**

Bonneson *et al.*, (2002) provide a succinct description of the prevalent control strategies in common use. Table E.1 indicates there are four: 1) Multiple Advance Detector system, of which variants are in fairly widespread use nationwide, 2) the TTI Truck Priority system, 3) the LHOVRA system developed by the Swedish National Road Administration, and 4) the SOS system developed for the Swedish National Road Administration by the Transport Research Institute.

**Table E.1 High Speed Detection Systems Currently in Use as of 2002**

Operating Characteristic		Detection System			
		Multiple Advance Detector	Truck Priority	LHOVRA	SOS
FUNCTION					
Dilemma (or clearance) zone protection.	For passenger cars.	✓	✓	✓	✓
	For trucks.	--	✓	--	--
Delay reduction capability.	For major movements.	✓	✓	✓	✓
	For minor movements. <sup>1</sup>	--	--	--	✓
CONTROL LOGIC					
Goal: End green when...	...clearance zone empty.	✓	✓	✓	--
	...least delay+crash cost.	--	--	--	✓
Meaning of maximum green.	Absolute end of green.	✓	--	--	--
	Can be exceeded.	--	✓	✓	✓
Ability to end green on opposing approaches at separate times.		--	--	✓	✓
External computer.		--	✓	--	✓
DETECTOR LOGIC					
Typical number of detectors (for 55-mph design).	One-lane approach.	4	6	3	4
	Two-lane approach.	4	8	3	8
Separate detectors for each lane.		--	✓ <sup>2</sup>	--	✓

Notes:

✓ = yes, "--" = no.

1 - Assumes that only the major-road through movements are provided advance detection.

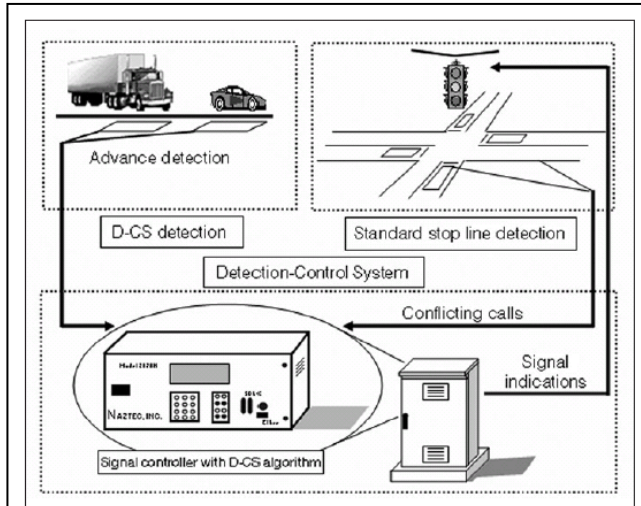
2 - Only for the first upstream detection zone.

(Source, Bonneson *et al.*, 2002)

## **D-CS Signal Control**

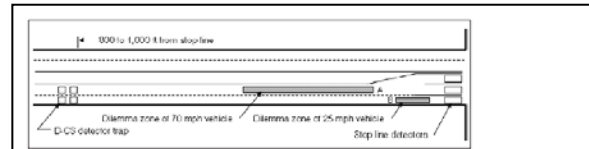
The conclusion of the Bonneson *et al.* study was that none of the existing detection strategies provide a good, robust solution. Instead, they tested a new idea, called the "detection-control system" (D-CS) that out-performed the common strategies. Their D-CS system consists of a set





**Figure E.2 The Detection-Control System**  
Source: Zimmerman and Bonneson (2007)

of advance detectors well upstream of the intersection (say, 1,000'), detectors at or near the stop line, and a signal controller with the D-CS algorithm installed, as shown in Figure E.2. It is this system that was both studied through simulation and tested in the field at three intersections across the state.



**Figure E.3 Detector Placement for D-CS**  
Source: Zimmerman and Bonneson (2007)

Placement of the detectors is shown in Figure E.3. To quote Bonneson *et al.*:

a pair of inductive loop detectors ... placed in each major road traffic lane at least 700 ft upstream of the intersection in a speed-trap. As a vehicle passes over these loops, the detection information is fed into a classifier that determines the vehicle's speed and length. Using this information, the detection-control algorithm, operating within a computer at the intersection, calculates when that vehicle will be in its 'dilemma zone' on the intersection approach. It then prevents the phase from ending when one or more vehicles are in the dilemma zone.... The location of this detection is based on a desire to have the system 'look' into the future of vehicle arrivals to the dilemma zone. The detection-control system searches for a time when each vehicle served by the subject phase is outside of its respective dilemma zone. It uses a dynamic dilemma-zone monitoring process that enables it to safely end the phase and to do so with a relatively short maximum allowable headway. The implications of this operation are that the system will operate with less delay (through shorter phase durations) and with fewer vehicles caught in the dilemma zone than the multiple advance detector system.

### **Existing NCDOT Practice**

Existing NCDOT practice is best illustrated through an example. The intersection of US 70 and Swift Creek Road (NC Signal #04-1217) is one of the test locations used in the project. It shows how NCDOT presently provides added protection at rural high-speed intersections. As portrayed in Figure E.4, it starts with volume-density control.

Call-and-extension detectors are about 420' from the stop line in all mainline lanes. Those detectors place calls for phases 2 and 6 ( $\Phi 2$  and  $\Phi 6$ ), add 1.5 seconds per actuation during red to the minimum green, and extend the green during green, first by 6 seconds and eventually only by 3.4 seconds once the "time before reduction" and "time to reduce" have elapsed.

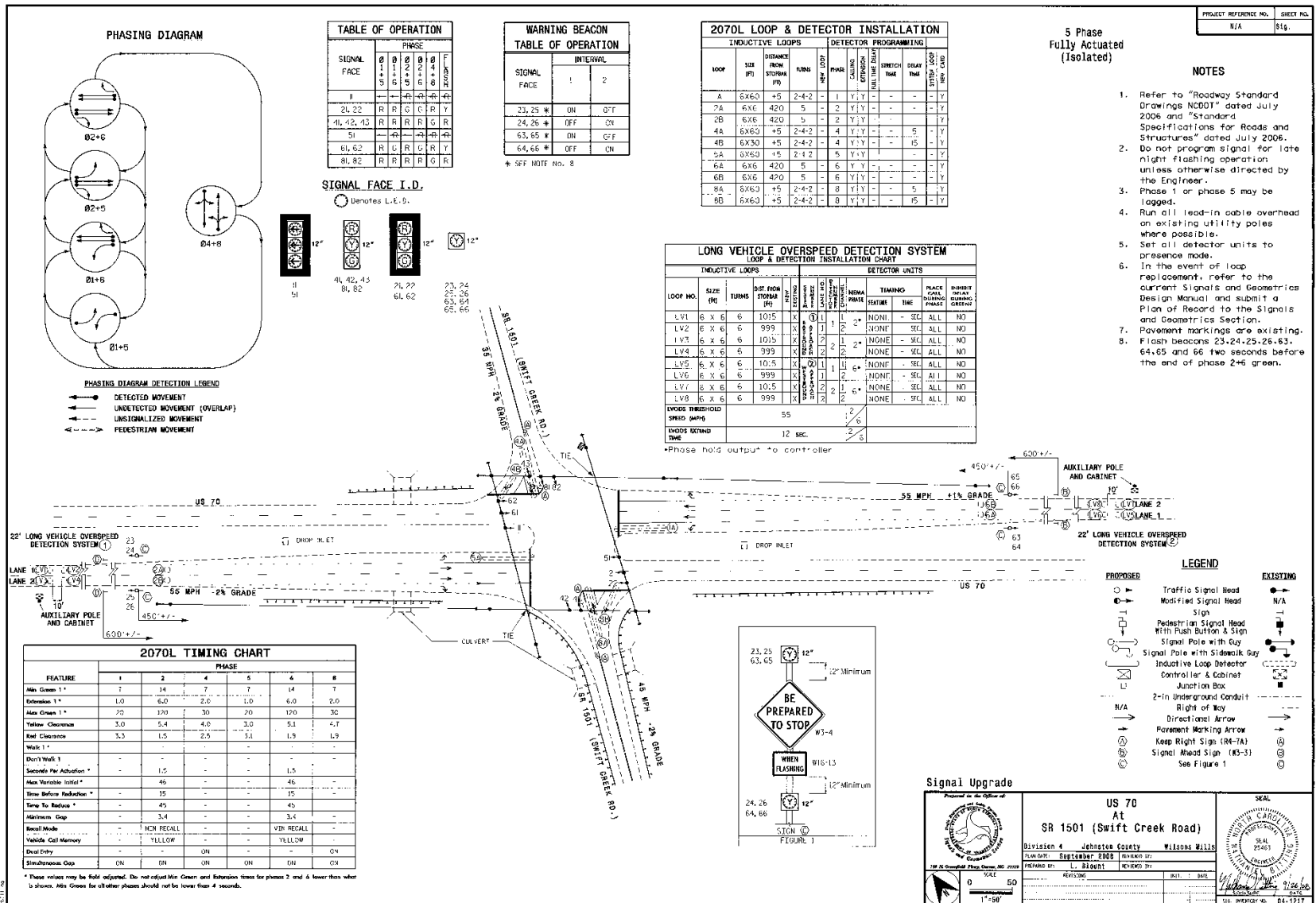


Figure E.4 Sheet for US 70 and Swift Creek Road, Wilson's Mills, NC (NC Signal #04-1217)

Additional high-speed/long vehicle protection is provided by pairs of detectors placed about 1,000' upstream of the stop bar (999' and 1,015') plus an NQ4 long vehicle system detection device. The NQ4 monitors the speeds and lengths of the oncoming vehicles and, if it senses a long vehicle traveling faster than 55 mph it sends to the controller a 12-second hold on main street green. This hold is long enough for the triggering vehicle to pass through the intersection before the onset of yellow. Overlapping holds occur if sequential triggering vehicles are sensed quickly one after another.

This configuration is common at many locations across the state. The placement of the advance detectors varies a little as do the settings for the NQ4 device, but the general arrangement and signal timing scheme are the same. For the D-CS control strategy to be of significant value to NCDOT, it needed to perform as well as or better than this NQ4-based strategy.

### **Simulation Tests and Field Tests**

To compare and contrast the various control strategies, five sites were selected. These were:

- *Swift Creek*: This is an intersection on US 70 about 10 miles east of Raleigh, NC. It was used to test the D-CS control system and to prepare for the field studies at the other two locations. It also served as a “piedmont” or mid-state test location. The intersection lies at the bottom of a fairly significant vertical curve. The mainline has two through lanes in both directions, divided by a median, plus left-turn bays, and flaring for the right turns. The side street has flared approaches but no left-turn bays. The signal control is volume density supplemented by an NQ4 device (explained below). There are left-turn arrows (protected/ permissive) on the mainline.
- *NC 280*: This intersection is about 10 miles south of Asheville, NC. It is in the “mountainous” or western part of the state. It lies along a section of highway that is gradually ascending/ descending, but the intersection itself is at the crest of a vertical curve and in the midst of a horizontal curve. The mainline has two through lanes in each direction and a two-way, left-turn median that becomes left-turn bays at the intersection. The side street has flared approaches but no left-turn bays. The volume-density control is two phase.
- *US 17*: This intersection is about 10 miles north of Wilmington, NC. It is in the “coastal” or eastern part of the state. It is on the level and lies at the beginning of a gradual horizontal curve. A T-intersection, the side street approach is on the eastern side. The mainline has two lanes in each direction, divided by a wide median, plus left-turn bays at the stopbar and a right-turn bay northbound. The volume-density signal control includes a lagging southbound left.
- *US 19-74-129 at NC 141*: This site is located in Marble, NC, just south of the Andrews Murphy Airport. The mainline has two through lanes in each direction, divided by a median, plus left-turn bays, and auxiliary lanes for the right turns. The side street has flared approaches but no left-turn bays. The signal control is volume density. There are left turn arrows (protected/permissive) on the mainline.
- *NC 24 (Kenansville Bypass) and NC 11-903*: This intersection is just southwest of Kenansville, NC. The mainline has two through lanes in each direction, divided by a

median, plus left-turn bays, and auxiliary lanes for the right turns. The side street has flared approaches but no left-turn bays. The signal control is volume density. There are left turn arrows (protected/ permissive) on the mainline.

The detector placement/ signal control configurations explored were:

- *Base Case*: This is used to designate the existing/initial configuration extant in the field. Except for Swift Creek, it involves standard NCDOT detector placements (e.g., detectors in each mainline lane, 420' upstream of the stopbar) and volume-density control using a 2070 controller and standard NCDOT OASIS software. (At Swift Creek the base case was the NQ4 configuration, described below.)
- *NQ4*: This is the configuration in which the NQ4 Long Vehicle System (LVS) devices are being used to give added protection on the mainline approaches. It is the configuration that NCDOT typically selects to provide protection above and beyond volume-density control. It was the base case condition at Swift Creek. Except at Swift Creek, the advance detectors were created by installing Sensys detectors at 1,000', working in conjunction with Sensys "repeater units", an "access point", and two Sensys detector cards.
- *D-CS*: This configuration involves using a Naztec 2070 controller and TS-2 cabinet to implement D-CS-based control. It requires speed traps in each mainline lane about 1,000' upstream of the stopbar. To create this configuration, the existing 2070 cabinets were swapped out so a Naztec TS-2 cabinet and Naztec controller could be put in place. Wireless Sensys detectors were used to create the speed traps at 1,000', working in conjunction with Sensys "repeater units", an "access point", and two Sensys detector cards.

The evaluation metrics that were most intensely employed were:

- Probability of  $n$  vehicles being in a dilemma zone at the onset of yellow,  $n = 0, 1, 2, \dots$ ;
- Probability of  $n$  trucks being in a dilemma zone at the onset of yellow,  $n = 0, 1, 2, \dots$ ;
- Probability that  $n$  vehicles violated the red light;
- Average delay per vehicle, overall and by approach; and
- Average cycle length.

The simulation results show that both the D-CS and NQ4 configurations significantly reduce the likelihood that vehicles will be trapped in dilemma zones at the onset of yellow. Moreover, the D-CS strategy provides the added benefit of reducing delays and reducing the cycle length.

Table E.2 summarizes the findings among the five sites based on the simulation studies. The table makes it clear that:

- The cumulative probability of none (0) or at most one (1) vehicle being in a dilemma zone at the onset of yellow is much higher for either the NQ4 or the D-CS strategy compared to the base case condition. For example, for the NC 280 site, the base case has a CP(0) of 69.6% for all vehicles while for the NQ4 configuration it is 77.9% and for D-CS it is 80.0%.

- In both the NQ4 and D-CS configurations, the yellow times selected provide much higher cumulative probabilities for CP(0) and CP(1) than do the other times that could have been selected. Again for NC 280, the base case involves almost no change, a value of 67.6% for any possible time versus 69.6% for the yellows that were actually invoked; while for NQ4 the change is from 63.3% to 77.9% and for D-CS it is from 63.2% to 80.0%.

**Table E.2 Simulation Results Summary**

	All Vehicles - Cum Prob of being in DZ				Trucks - Cum Prob of being in DZ				AvgD	AvgCyc (sec)	TotAmb
	CumProb(0)		CumProb(1)		CumProb(0)		CumProb(1)				
	Amber	Other	Amber	Other	Amber	Other	Amber	Other			
Swift Creek											
Base											
NQ4	65.1	43.5	89.1	75.3	96.8	91.1	99.9	99.7	13.7	78.4	459
D-CS	66.2	45.7	91.6	77.6	95.9	91.3	99.9	99.5	11.4	74.1	486
NC-280											
Base	69.6	67.6	94.7	93.2	99.2	98.8	100.0	100.0	11.2	97.6	369
NQ4	77.9	63.3	95.1	91.0	98.6	97.8	100.0	100.0	13.5	68.6	525
D-CS	80.0	63.2	98.0	91.0	98.7	98.0	100.0	100.0	3.9	68.1	529
US-17											
Base	77.2	77.1	95.5	95.6	88.4	88.4	98.3	98.4	8.6	75.0	480
NQ4	69.8	57.0	91.3	87.1	86.6	75.5	97.4	95.7	11.1	90.7	397
D-CS	82.2	61.8	97.8	88.6	99.5	97.5	100.0	100.0	5.9	56.3	640
US-19											
Base	82.6	81.5	99.3	98.9	99.0	99.0	100.0	100.0	38.9	88.2	408
NQ4	91.1	78.3	99.5	97.0	99.9	98.9	100.0	100.0	14.4	77.1	467
D-CS	91.1	79.4	99.5	96.5	99.8	99.0	100.0	100.0	12.3	58.3	617
NC-24											
Base	82.4	80.4	97.6	96.8	98.1	98.0	99.9	99.9	13.2	67.7	532
NQ4	81.2	70.0	97.1	93.4	98.8	96.0	100.0	100.0	13.6	64.3	560
D-CS	81.5	70.8	97.9	93.6	98.2	96.5	99.9	100.0	12.6	61.9	582

- In all cases, the CP(0) is higher for the D-CS configuration than it is for NQ4.
- The average delays for the D-CS configuration are always the smallest and in some cases, like NC 280 and US 17, they are dramatically so.
- The average cycle lengths for D-CS are always the smallest while the NQ4 configuration produces mixed results, while most of the time the average cycle length is shorter, sometimes it is longer.

The conclusion from these analyses is that both the NQ4 and D-CS control strategies are good, but the D-CS strategy has a slight edge because it yields smaller delays and shorter average cycle lengths.

Table E.3 summarizes the results for all three intersections where field tests were performed. (Field tests were performed at three of the five intersections studied in the simulation analyses.) The first column shows the percentage of yellows for which no vehicles were 2-6 seconds from the stopbar based on the observations at 180'. For example, in the case of the base case (existing

conditions) at US 17 southbound, 64.3% of the time no vehicles were 2-6 seconds from the stopbar. The actual times when yellows were invoked have the same characteristics: 62.7% of the time, no vehicles were present. In contrast, the NQ4 control configuration selected times when no vehicles were 2-6 seconds upstream of the yellow 77.1% of the time and the D-CS strategy increased that percentage to 91.8%. Moreover, while the base case average cycle length was 62.7 seconds, the NQ4 control strategy increased the cycle length to 147.9 seconds while the D-CS control strategy kept it constant at 66.6 seconds. Hence, the NQ4 and D-CS

	All Vehicles - Cum Prob of being in DZ						AvgCyc (sec)
	CumProb(0)		CumProb(1)		CumProb(2)		
	Amber	Other	Amber	Other	Amber	Other	
<b>Swift Creek - EB</b>							
Base							
NQ4	69.3	42.5	22.0	30.7	7.1	17.2	78.7
D-CS	84.4	36.4	13.3	33.9	2.2	19.8	62.8
<b>Swift Creek - WB</b>							
Base							
NQ4	83.3	68.3	13.0	17.0	3.7	9.2	95.4
D-CS	87.0	58.8	9.8	21.8	3.3	11.9	77.3
<b>NC-280 - EB</b>							
Base	72.6	63.4	24.2	27.2	3.2	7.5	150.7
NQ4	72.1	59.7	14.4	23.3	10.8	10.3	125.8
D-CS	79.3	66.6	19.5	25.1	1.2	6.6	166.1
<b>NC-280 - WB</b>							
Base	49.4	56.3	41.4	25.7	8.0	11.3	182.8
NQ4	77.8	64.3	20.4	26.4	1.9	7.5	163.4
D-CS	84.5	60.8	12.6	23.2	1.9	10.2	154.2
<b>US-17 - NB</b>							
Base	87.2	53.9	10.6	27.2	2.1	12.9	68.0
NQ4	85.3	80.5	12.1	12.6	2.6	5.0	59.7
D-CS	83.8	47.4	15.1	33.1	1.1	14.2	56.9
<b>US-17 - SB</b>							
Base	62.7	64.3	31.3	27.2	6.0	7.0	62.7
NQ4	77.1	56.5	20.0	28.7	1.9	10.7	147.9
D-CS	91.8	55.7	7.7	28.8	0.4	10.9	66.6

control strategies both improved safety, but the D-CS control strategy did it without sacrificing efficiency.

Another interesting observation is that the number of vehicles counted as being in dilemma zones decreased when comparing the data for 450' or 180' with that for 1000'. Notice in Table E.4 that in the case of the D-CS control strategy, this is almost always the case. For example, at Swift Creek, westbound, P(0), the probability of no vehicles being in a dilemma zone at the onset of yellow rises in the D-CS case from 81.5% at 1000' to 84.2% at 450' and then 87.0% at 180'. This increase always occurs for the D-CS cases if the P(0) estimate at 1000' is compared with that from 180'. It is true in three of the nine cases if the 450' value also has to be increasing. The interpretations are twofold. First, once drivers see the yellow, they adjust their deceleration to move themselves out of a dilemma zone as they approach the intersection. Second, the rise in these values is most dramatic for the D-CS control strategies, slightly surpassing the NQ4 results, which means the D-CS strategy is doing best.

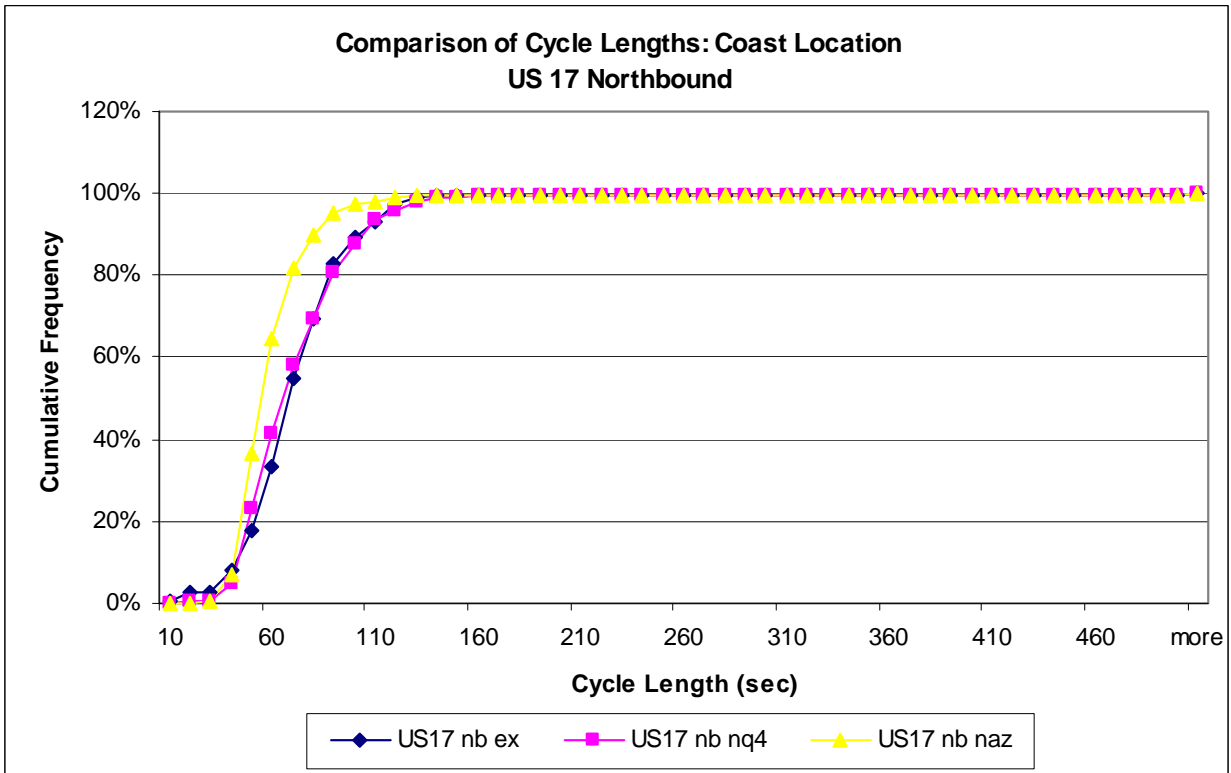
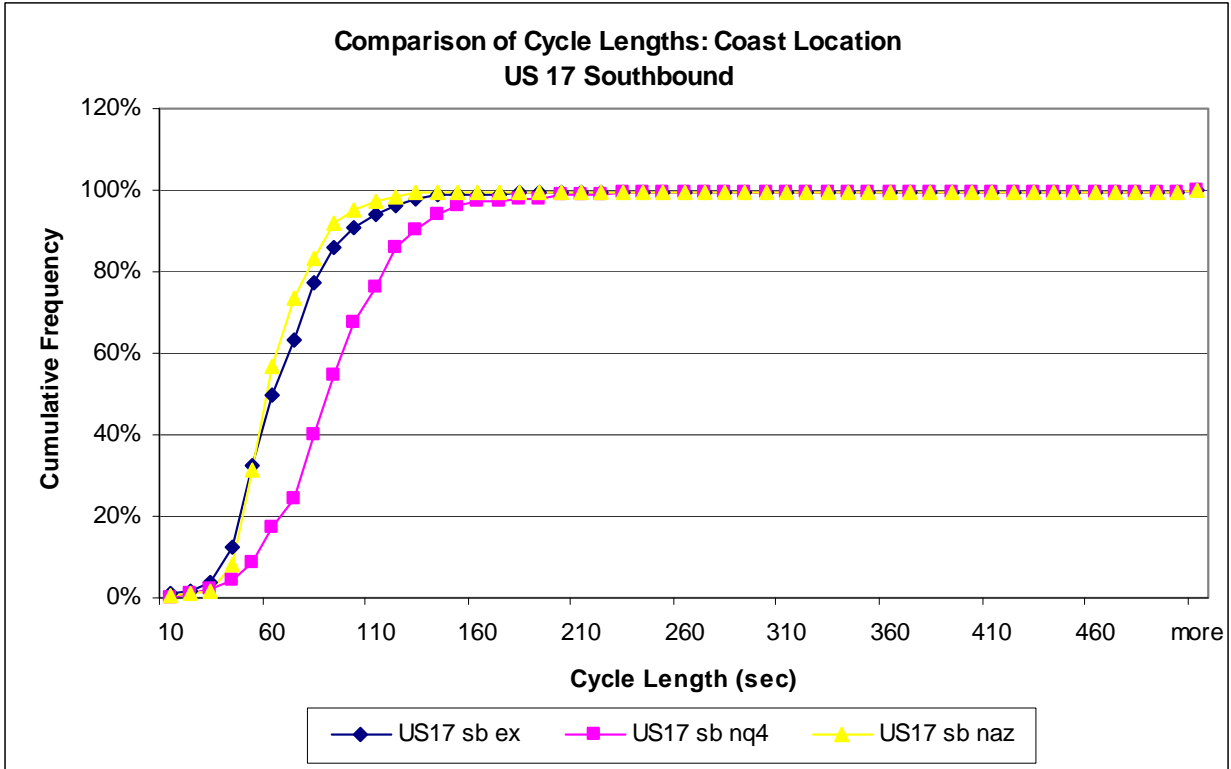
Finally, while the incentive for exploring more advanced signal control strategies was principally safety, efficiency was also of interest, and an examination of signal cycle lengths provided insight into that issue.

**Table E.4 Probabilities of No Vehicles in Dilemma Zones**

Probability of No Vehicles					
Intersection	Direction	Control	1000'	450'	180'
Swift Creek	WB	NQ4	83.3	75.9	83.3
		D-CS	<b>81.5</b>	<b>84.2</b>	<b>87.0</b>
	EB	NQ4	59.1	78.7	69.3
		D-CS	<b>76.3</b>	<b>74.8</b>	<b>84.4</b>
US-17	SB	Existing	73.0	77.8	62.7
		NQ4	60.0	66.7	77.1
		D-CS	<b>74.7</b>	<b>47.2</b>	<b>91.8</b>
	NB	Existing	58.5	51.6	87.2
		NQ4	81.9	66.8	85.3
		D-CS	<b>58.8</b>	<b>64.1</b>	<b>83.8</b>
NC-280	EB	Existing	66.3	67.4	72.6
		NQ4	57.7	64.9	72.1
		D-CS	<b>65.9</b>	<b>61.0</b>	<b>79.3</b>
	WB	Existing	65.5	66.7	49.4
		NQ4	67.6	69.4	89.8
		D-CS	<b>62.1</b>	<b>68.9</b>	<b>84.5</b>

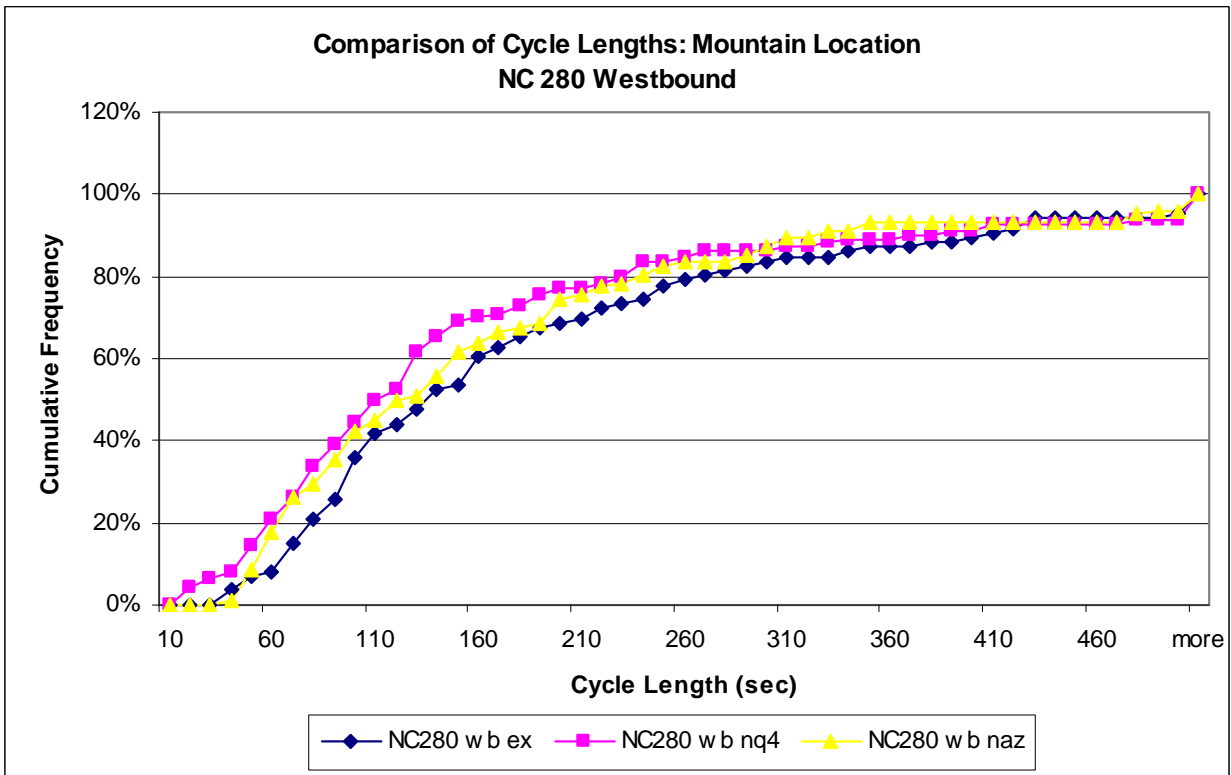
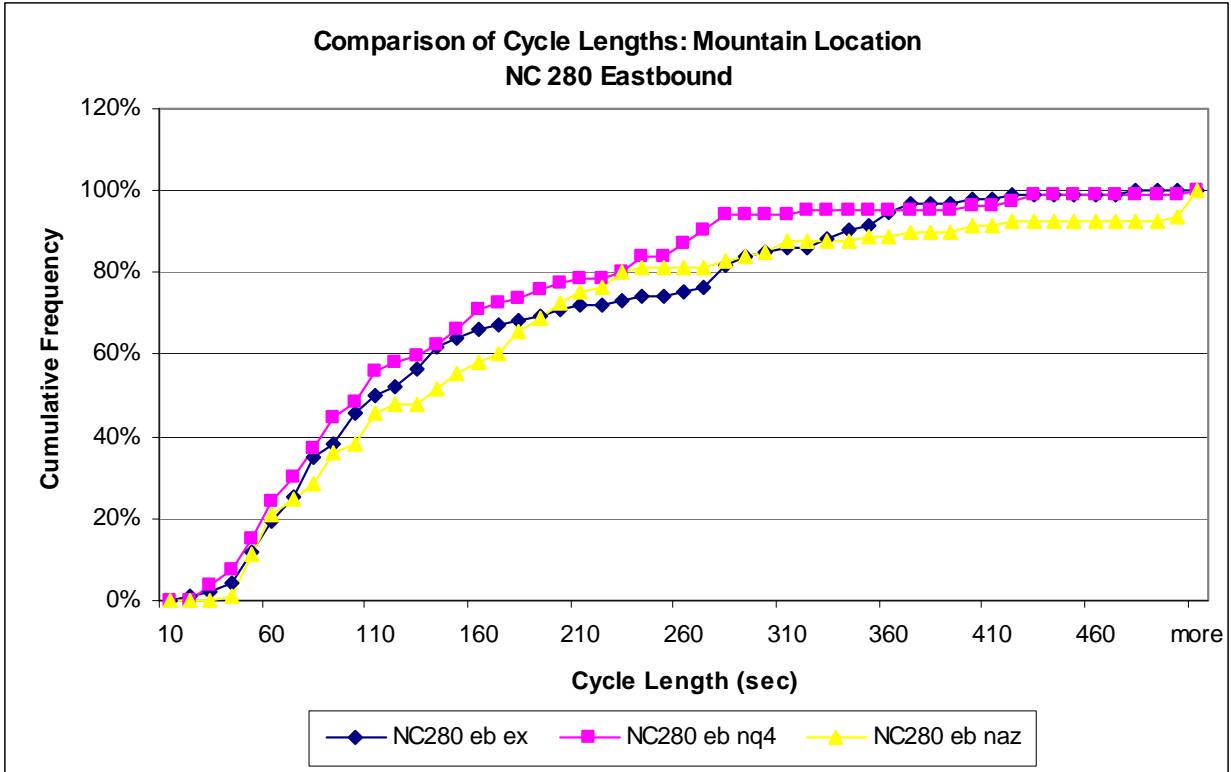
Figures E.5 through E.7 show the cumulative probability density functions for cycle lengths for each of the sites and approaches studied in the field. A desirable outcome would be that the curve is highest and furthest to the left. This would mean that the cycle lengths for that control configuration are the shortest. Notice that in the case of US 17 southbound, the D-CS (designated “naz” in the figure) has the distribution that is highest and furthest left, slightly better than that for the NQ4. It is also

the highest and furthest left for US 17 northbound, and in this case it is by itself. In the case of NC 280, both eastbound and westbound, the D-CS result is in the middle, performing on par with the NQ4 strategy. The reason the performance of the D-CS strategy is not more distinctively better is because the truck (and total) volumes at the NC 280 intersection are not that high. In the case of Swift Creek, either eastbound or westbound, the dominant performance of the D-CS control configuration is again apparent.

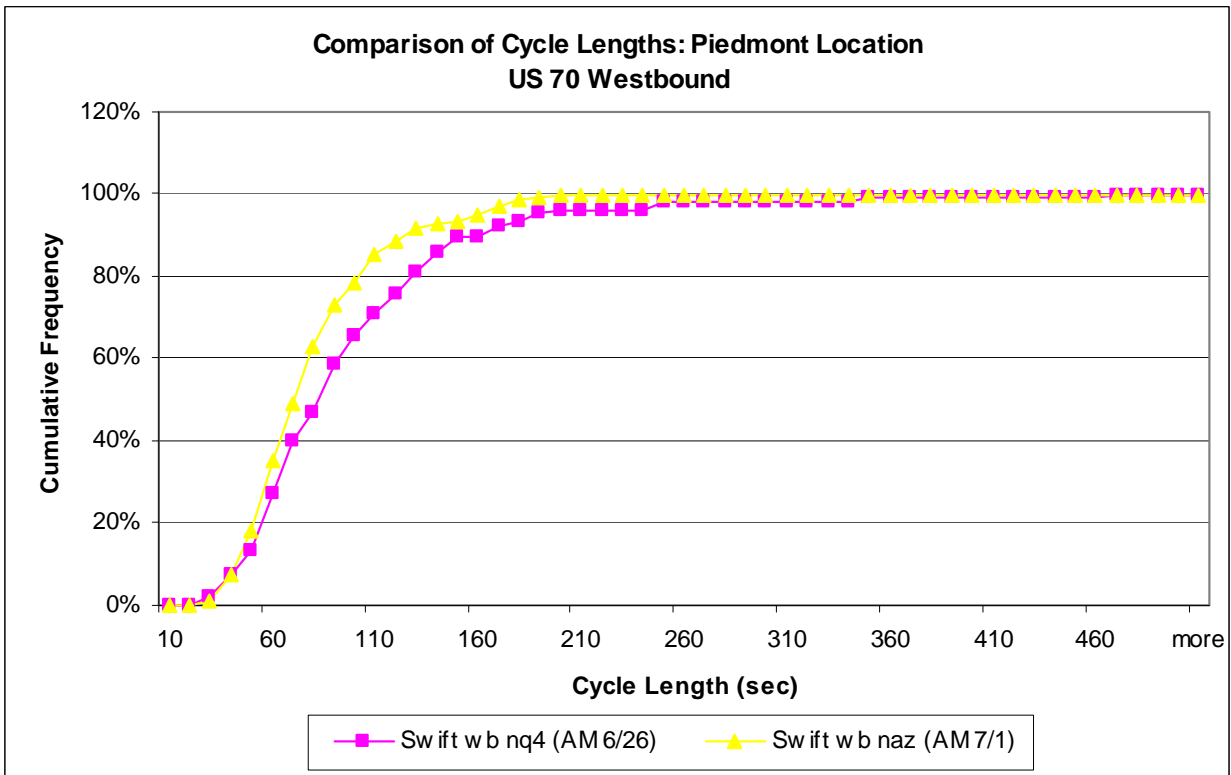
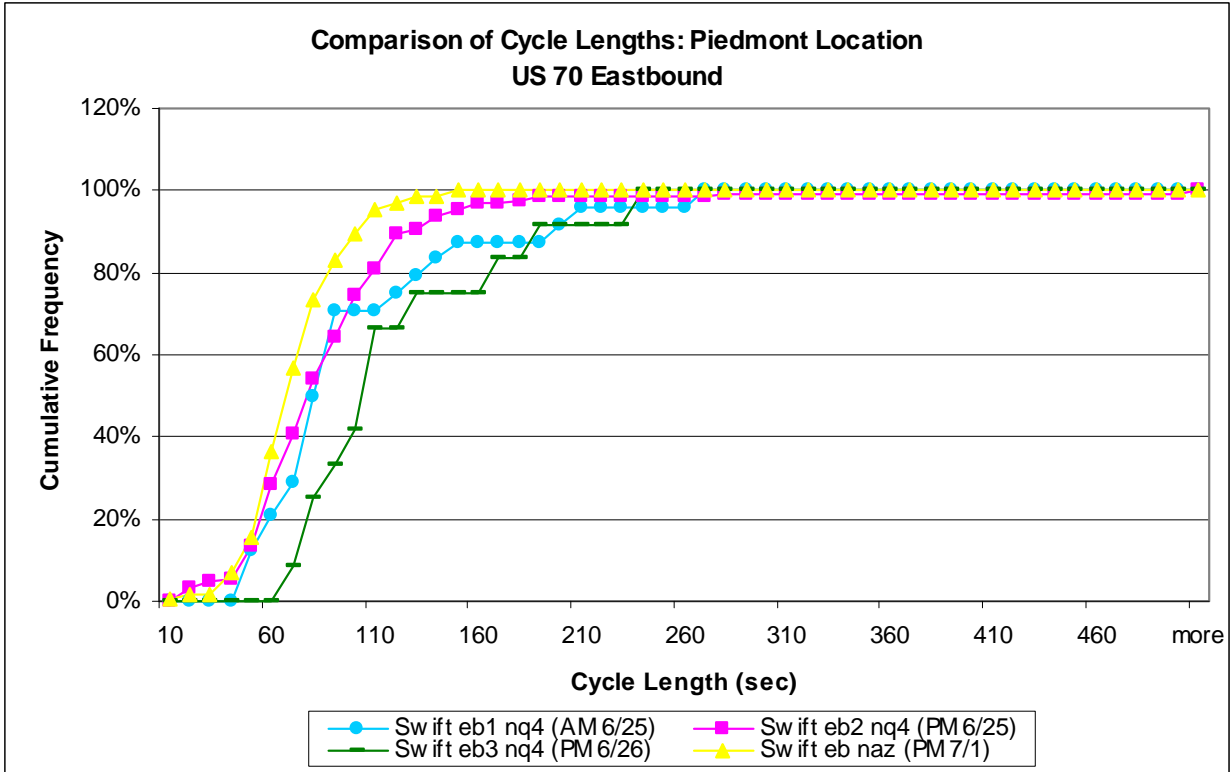


**Figure E.5 Trends in Cycle Lengths at US 17**





**Figure E.6 Trends in Cycle Lengths at NC 280**



**Figure E.7 Trends in Cycle Lengths at US 70**

## Cost-Benefit Analysis

A cost benefit analysis was conducted to study if installation of the new technology (D-CS or NQ4 system) would yield operational and safety benefits. All costs were converted to their annual worth equivalents for analysis. It is assumed that the life of these systems is 15 years.

Table E.5 shows results from cost benefit analysis comparing the use of the D-CS system to that of a 2070 controller. It can be seen from the table that operational and safety benefits are high when the 2070 controllers are replaced with a D-CS system.<sup>2</sup> Benefits are possible with even a 5 percent reduction in crashes at these intersections. In general, estimated benefits are very high at the US 19 @ NC 141 rural intersection in Cherokee County.

**Table E.5 Use of D-CS System when Compared to a 2070 Controller**

Location	Annual Reduction in Crash Cost (\$)	Annual Change in Delay Cost (\$)	Annual Value of Equipment and Installation Cost (\$)	B/C Ratio	Economically Feasible (Yes / No)
<b>5% reduction in crashes</b>					
US 19 @ NC 141 (Cherokee)	7,176	406,129	2,498	165.4	Yes
NC 24 @ NC 11 (Duplin)	8,870	3,900	2,498	5.1	Yes
NC 280 @ SR 1422 (Henderson)	5,406	75,719	2,498	32.5	Yes
US 17 @ NC 210 (Pender)	3,023	33,279	2,498	14.5	Yes
<b>10% reduction in crashes</b>					
US 19 @ NC 141 (Cherokee)	14,352	406,129	2,498	168.3	Yes
NC 24 @ NC 11 (Duplin)	17,739	3,900	2,498	8.7	Yes
NC 280 @ SR 1422 (Henderson)	10,813	75,719	2,498	34.6	Yes
US 17 @ NC 210 (Pender)	6,045	33,279	2,498	15.7	Yes

Table E.6 shows results from the cost benefit analysis comparing use of the NQ4 system to a 2070 controller. It can be seen from the table that operational and safety benefits were observed at only 2 out of the 4 selected study intersections. The system tends to increase delays at 2 selected study intersections resulting in a benefit to cost (B/C) ratio lower than 1.0 at these intersections. As in the previous case, benefits are very high at the US 19 @ NC 141 intersection in Cherokee County.

<sup>2</sup> The Swift Creek site was not included in this analysis since its base case condition involved use of the NQ4 system. Hence four selected study intersections were involved, not five.

**Table E.6 Use of NQ4 System when compared to a 2070 Controller**

Location	Annual Reduction in Crash Cost (\$)	Annual Change in Delay Cost (\$)	Annual Value of Equipment and Installation Cost (\$)	B/C Ratio	Economically Feasible (Yes / No)
<b>5% reduction in crashes</b>					
US 19 @ NC 141 (Cherokee)	7,176	256,251	2,717	97.0	Yes
NC 24 @ NC 11 (Duplin)	8,870	-3,144	2,717	2.1	Yes
NC 280 @ SR 1422 (Henderson)	5,406	-24,512	2,717	-7.0	No
US 17 @ NC 210 (Pender)	3,023	-31,179	2,717	-10.4	No
<b>10% reduction in crashes</b>					
US 19 @ NC 141 (Cherokee)	14,352	256,251	2,717	99.6	Yes
NC 24 @ NC 11 (Duplin)	17,739	-3,144	2,717	5.4	Yes
NC 280 @ SR 1422 (Henderson)	10,813	-24,512	2,717	-5.0	No
US 17 @ NC 210 (Pender)	6,045	-31,179	2,717	-9.3	No

Table E.7 shows possible benefits or disbenefits due to use of the NQ4 system instead of the D-CS system. Savings in crash costs were not considered as the basic assumption is that both the D-CS and NQ4 systems would yield a similar possible reduction in crash costs. Thus, only change in delay cost is used in cost benefits analysis for this case. Results from analysis at all 5 selected study intersections showed that the delay cost will be high if the NQ4 system is used instead of the D-CS system.

**Table E.7 Use of NQ4 System when compared to D-CS System**

Location	Annual Reduction in Crash Cost (\$)	Annual Change in Delay Cost (\$)	Annual Value of Equipment and Installation Cost (\$)	B/C Ratio	Economically Feasible (Yes / No)
US 19 @ NC 141 (Cherokee)	-	-149,877	219	-685.3	No
NC 24 @ NC 11 (Duplin)	-	-7,044	219	-32.2	No
NC 280 @ SR 1422 (Henderson)	-	-100,231	219	-458.3	No
US 17 @ NC 210 (Pender)	-	-64,458	219	-294.7	No
Swift Creek (Johnston)	-	-46,299	219	-211.7	No

Observations based on the cost-benefit analysis are that the benefits are high at all 5 rural high speed intersections for the D-CS system. Thus, it can be concluded that the D-CS system would yield better operational and safety benefits than the NQ4 system or a 2070 controller (base case). On the other hand, use of the NQ4 only yielded better benefits than a 2070 controller at 2 out of the considered 4 rural high speed intersections.

### **Conclusions and Recommendations**

Several conclusions can be drawn from this research project. The first is that NCDOT is at or near the forefront of signal control strategies for high-speed rural intersections. During the literature review, a comprehensive assessment of signal control techniques and technologies was

conducted. The research team found that few states have a signal design practice that is as well documented as NCDOT's and the procedures in use are at the frontier of best practice.

The second conclusion is that the NQ4 strategy currently employed works fairly well in the field. NCDOT can do better, but the NQ4 practice provides a good solution, certainly better than just using volume-density control, based both on the field tests performed as well as the simulation experiments. The drawbacks to the NQ4 system are that it does not actually find times when no vehicles are in dilemma zones, which the D-CS control strategy does, and it does not directly take into account vehicle speed in computing the main street hold time it conveys to the controller. It tends to lengthen the distribution of cycle lengths which means efficiency suffers (a disadvantage the D-CS system does not have) and it is a bit cumbersome and expensive to install. AC power must be brought to a cabinet adjacent to the loops and an AC signal must be brought back to the controller cabinet.

The third conclusion is that the D-CS control strategy developed by Bonneson *et al.* (1997) consistently works very well. In almost all of the field tests and in all of the traffic simulation model runs, it performed the best. In the simulation tests, it dramatically reduced the number of vehicles that were trapped in dilemma zones at the onset of yellow and a similar trend was discerned in the field. It made the intersections quieter; less mainline traffic was brought to an unexpected stop. It shortened the side street queues, shortened the cycle length, and made the signal more responsive to minor movement calls.

The benefit-cost analysis suggests that using the D-CS control system would be the most useful action for NCDOT to pursue. It yields the highest benefit/cost ratios and consistently outperforms the existing, unenhanced control and the NQ4 system.

Another conclusion is that wireless sensors can be an effective and efficient way to add detectors to a signalized intersection. This finding was not an original intent of the project, but to create the D-CS control configuration, the research team had to find a way to quickly create speed traps about 1,000' upstream of the stop bar on both mainline approaches. Expecting the divisions to install hardwire connections was clearly unreasonable. The benefit-cost assessments demonstrate, indirectly, that this is true when the cost of an NQ4 installation (which is assumed to use standard loops) is compared with the D-CS option (which is cost out based on wireless detectors). The wireless detectors were simple, easy, and quick to install. Setting up the repeaters and access point was easy. Getting the detectors to work reliably at 1,000' was no problem. The only challenge was calibration. The wireless sensors sometimes had difficulty detecting long trucks, especially tank trucks whose carriage involves very little steel and it is high above the road surface. In all six locations where the control strategies were tested, only a few hours were required to install the eight wireless sensors (four per direction, two per lane), the repeaters (one or two depending on which approach was involved), and the access point. The field crews enjoyed participating, thought the technology had great promise, and expressed eagerness that NCDOT would make it possible to purchase and install the equipment. These comments from the field crews were encouraging, especially since NCDOT is in the process of evaluating wireless detection technology to make it a viable tool when loops are impractical.

Another discovery, again unexpected, was that it is possible to do “cabinet-in-the-loop” simulation as well as the more traditional “hardware-in-the-loop” simulation. This was discovered because, to test the D-CS control strategy, the Naztec controller needed to see the detector inputs coming through the bus interface units from the detector racks. Passing this information directly to the controller from the controller interface device was not possible. In this project, the cabinet-in-the-loop configuration was obtained by using a TS-2 wiring harness to connect the CID to the low voltage terminals in the controller cabinet. The solution worked very well.

One more conclusion was that measuring speeds accurately is important. At the cruise speed (say 60+ mph) on the roads involved in the study, the time elapsed between the two speed trap loops 20’ apart is measured in milliseconds. The sensors have to be polled very frequently to get accurate estimates of the speeds. In the field, this was not such a significant problem because the clock speeds on the controller and the detector interface cards are very fast. However, getting accurate speeds in the simulation runs is problematic because the state of the system is updated only every 0.1 seconds (100 milliseconds). That means less than two time steps are required to traverse the 20’ speed trap. Hence, only certain speeds will ever be reported out (distance/0.1 second, distance/0.2 seconds, and so on), not the continuum of possibilities

The last conclusion is that investing in the D-CS system is well worthwhile. This is also a recommendation. The benefit/cost analysis shows that benefits well exceed the cost at all five rural high speed intersections where the Naztec system and D-CS systems were tested. Thus, it can be concluded that Naztec system would yield better operational and safety benefits than the NQ4 system or 2070 controller (base case). On the other hand, use of NQ4 only yielded better benefits than 2070 controller at 2 out of the considered 4 rural high speed intersections.

The recommendations based on these conclusions are as follows:

- NCDOT should commence an effort to incorporate the D-CS control strategy into its existing OASIS software. The skeleton computer program needed to do this is in the public domain and can be readily obtained.
- NCDOT should allow the purchase of Naztec controllers that incorporate the D-CS control strategy until and perhaps even after the OASIS software enhancement is complete. Side-by-side comparisons of performance would be very helpful.
- NCDOT should also allow the purchase of wireless detectors. This would simplify installation, reduce the costs involved, and make it possible for more instrumentation to be created for less (or the same).

## Table of Contents

<b>1.</b>	<b>INTRODUCTION.....</b>	<b>1</b>
<b>2.</b>	<b>LITERATURE REVIEW .....</b>	<b>5</b>
2.1	CLASSIC REFERENCES.....	5
2.2	BONNESON ET AL. (2002).....	5
2.3	SI, URBANIK, AND HAN (2007) .....	17
2.4	SIMILAR EFFORTS .....	20
2.5	OTHER INNOVATIONS .....	22
2.6	UNIVERSITY OF MINNESOTA .....	23
2.7	OTHER STUDIES .....	24
2.8	OTHER REFERENCES AND SOURCES .....	25
2.9	SUMMARY AND CONCLUSIONS.....	27
<b>3.</b>	<b>CURRENT DESIGN PRACTICE.....</b>	<b>28</b>
3.1	THREE TYPICAL INTERSECTIONS - NCDOT .....	28
3.2	NCDOT DESIGN MANUAL .....	36
3.3	FEDERAL HIGHWAY ADMINISTRATION .....	39
3.4	GEORGIA.....	41
3.5	SOUTH CAROLINA.....	41
3.6	CALIFORNIA.....	43
3.7	MINNESOTA .....	44
3.8	OHIO .....	45
3.9	VIRGINIA .....	47
3.10	CONCLUSIONS AND RECOMMENDATIONS.....	48
<b>4.</b>	<b>EVALUATION .....</b>	<b>49</b>
4.1	LOCATIONS, CONFIGURATIONS, AND PERFORMANCE MEASURES .....	49
4.2	STUDY SITES.....	50
4.3	SIMULATION CONFIGURATIONS .....	60
4.4	SIMULATION RESULTS ANALYSIS METHODOLOGY .....	65
4.5	SIMULATION RESULTS – AN ILLUSTRATION.....	67
4.6	SIMULATION RESULTS AND FINDINGS.....	70
4.7	FIELD STUDY PREPARATION AND DATA COLLECTION .....	71
4.8	FIELD STUDY RESULTS .....	77
<b>5.</b>	<b>BENEFIT-COST ANALYSIS .....</b>	<b>85</b>
5.1	INTRODUCTION .....	85
5.2	BACKGROUND AND LITERATURE REVIEW .....	85
	<i>Advantages of Detection Loops .....</i>	<i>86</i>
	<i>Disadvantages of Detection Loops .....</i>	<i>86</i>
5.3	STUDY TASK AND METHODOLOGY .....	86

	<i>Crash Reduction Factors</i> .....	87
	<i>Installation Costs</i> .....	88
	<i>Delay Cost</i> .....	88
5.4	RESULTS AND DISCUSSION.....	90
5.5	SUMMARY .....	92
<b>6.</b>	<b>CONCLUSIONS AND RECOMMENDATIONS.....</b>	<b>93</b>
<b>7.</b>	<b>IMPLEMENTATION AND TECHNOLOGY TRANSFER PLAN .....</b>	<b>95</b>
<b>8.</b>	<b>REFERENCES.....</b>	<b>96</b>

### List of Figures

FIGURE 1.1	TYPICAL DILEMMA ZONE DEFINITIONS .....	1
FIGURE 1.2	STANDARD 4.1.1, SHEET 3 OF 4, GUIDELINES FOR LOOP PLACEMENT FOR MAIN STREET THROUGH MOVEMENTS .....	2
FIGURE 1.3	TRADEOFF SURFACE .....	3
FIGURE 2.1	VEHICLE-STATUS COMPONENT ALGORITHM FLOWCHART .....	9
FIGURE 2.2	PHASE-STATUS COMPONENT ALGORITHM FLOWCHART .....	11
FIGURE 2.3	TWO-STAGE GAP-OUT FEATURE .....	12
FIGURE 2.4	LOOK-AHEAD FEATURE.....	12
FIGURE 2.5	PROBABILITY OF MAX-OUT .....	13
FIGURE 2.6	EFFECT OF VARIOUS FEATURES ON MAX-OUT FREQUENCY .....	13
FIGURE 2.7	VEHICLES IN THE DILEMMA ZONE .....	14
FIGURE 2.8	EFFECT OF VARIOUS FACTORS ON PERCENT OF VEHICLES IN THE DILEMMA ZONE .....	14
FIGURE 2.9	HISTOGRAM OF SPEED-ERROR.....	15
FIGURE 2.10	HISTOGRAM OF SPEED CHANGE.....	16
FIGURE 2.11	ADJUSTED DILEMMA ZONE BOUNDARIES.....	16
FIGURE 2.12	BEIRELE RECOMMENDED DETECTOR CONFIGURATIONS FOR A 50-MPH DESIGN SPEED .....	18
FIGURE 2.13	SDITE DETECTOR CONFIGURATION FOR 50-MPH DESIGN SPEED APPROACHES ....	18
FIGURE 2.14	BONNESON AND MCCOY: 1994 DETECTOR CONFIGURATIONS FOR RURAL INTERSECTIONS WITH A 50-MPH DESIGN SPEED.....	19
FIGURE 3.1	ORIGINAL DETECTOR CONFIGURATION - US 70 AT SR 1913 (WILSON'S MILLS ROAD).....	29
FIGURE 3.2	REVISED US 70 AT SR 1913 (WILSON'S MILLS ROAD) .....	31
FIGURE 3.3	US 70 AT SR 1901 (POWHATAN ROAD).....	33
FIGURE 3.4	EXPECTED LOOP PLACEMENT FOR MAIN STREET THROUGH MOVEMENTS .....	36
FIGURE 3.5	2070L ANNOTATED TIMING CHART (SHEET 1 OF 2) .....	37
FIGURE 3.6	2070L ANNOTATED TIMING CHART (SHEET 2 OF 2) .....	38
FIGURE 3.7	DETECTOR PLACEMENT .....	42
FIGURE 3.8	TYPICAL DETECTOR LAYOUT - MINNESOTA .....	44
FIGURE 3.9	SUGGESTED DETECTOR PLACEMENT VERSUS DECISION ZONE LOCATION .....	45
FIGURE 3.10	DETECTOR PLACEMENT RECOMMENDATIONS.....	46
FIGURE 4.1	US 70 AND SWIFT CREEK ROAD, WILSON'S MILLS, NC (NC SIGNAL #04-1217)..	50



FIGURE 4.2	SIGNAL TIMING SHEET FOR US 70 AND SWIFT CREEK ROAD, WILSON’S MILLS, NC (NC SIGNAL #04-1217) .....	51
FIGURE 4.3	US 70 AT SWIFT CREEK ROAD, WILSON’S MILLS, LOOKING EASTBOUND.....	52
FIGURE 4.4	NC 280 AT RAY HILL ROAD, MILLS RIVER, NC (NC SIGNAL #14-1137).....	52
FIGURE 4.5	SIGNAL TIMING SHEET FOR NC 280 AT RAY HILL ROAD, MILLS RIVER, NC (NC SIGNAL #14-1137).....	53
FIGURE 4.6	US 17 AT NC 210, SURF CITY, NC (NC SIGNAL #03-0618) .....	54
FIGURE 4.7	SIGNAL TIMING SHEET FOR US 17 AT NC 210, SURF CITY, NC (NC SIGNAL #03-0618) .....	55
FIGURE 4.8	US 19-74-129 AT NC 141, MARBLE, NC (NC SIGNAL #14-0078).....	56
FIGURE 4.9	SIGNAL TIMING SHEET FOR US 19-74-129 AT NC 141, MARBLE, NC (NC SIGNAL #14-0078).....	57
FIGURE 4.10	NC 24 (TOP TO BOTTOM) AND NC 11-903, KENANSVILLE, NC (NC SIGNAL #03-0538) .....	58
FIGURE 4.11	SIGNAL TIMING SHEET FOR NC 24 AT NC 11, NC (NC SIGNAL #03-0538).....	59
FIGURE 4.12	BASE CASE HIL CONFIGURATION - VISSIM – CID – 2070 EAGLE CONTROLLER .	61
FIGURE 4.13	BASE CASE CONFIGURATION – LAPTOP WITH VISSIM, CID AND 2070 EAGLE CONTROLLER.....	61
FIGURE 4.14	LOGICAL RELATIONSHIPS AMONG THE DEVICES FOR THE NQ4 HIL SIMULATIONS	62
FIGURE 4.15	NQ4 DEVICE SPLICED INTO THE 170 CABLE.....	63
FIGURE 4.16	170 CABLE WITH A C1 BACK PANEL ON ONE END AND INDIVIDUAL WIRES ON THE OTHER .....	64
FIGURE 4.17	SOLDERED CONNECTIONS OF THE INDIVIDUAL WIRES FROM THE 170 CABLE TO THE 2070-2A FIELD I/O MODULE IN THE TS-2 CABINET .....	65
FIGURE 4.18	CUMULATIVE PROBABILITY COMPARISON.....	70
FIGURE 4.19	FIELD STUDY SET-UP .....	73
FIGURE 4.20	SWAPPING OUT THE CABINET AND CONTROLLER AT US 70 AND SWIFT CREEK ....	74
FIGURE 4.21	WIRELESS SENSORS BEING PREPARED FOR INSTALLATION.....	74
FIGURE 4.22	INSTALLING THE WIRELESS SENSORS IN THE PAVEMENT AT US 70 AND SWIFT CREEK (LEFT) AND NC 280 AND RAY HILL ROAD (RIGHT) .....	75
FIGURE 4.23	INSTALLING THE BOUNCE REPEATER AT NC 280 AND RAY HILL ROAD .....	76
FIGURE 4.24	INSTALLING THE ACCESS POINT AT NC 280 AND RAY HILL ROAD.....	76
FIGURE 4.25	A REPEATER INSTALLED ATOP A TEMPORARY POLE ADJACENT TO THE DETECTORS .....	77
FIGURE 4.26	TIME STAMP ANALYSIS .....	77
FIGURE 4.27	TRENDS IN CYCLE LENGTHS AT US 17 .....	82
FIGURE 4.28	TRENDS IN CYCLE LENGTHS AT NC 280 .....	83
FIGURE 4.29	TRENDS IN CYCLE LENGTHS AT US 70 .....	84

### **List of Tables**

TABLE 2.1	HIGH SPEED DETECTION SYSTEMS CURRENTLY IN USE AS OF 2002 .....	6
TABLE 2.2	VEHICLES IN THE OPTION ZONE WITH VEHICLE DESIRED SPEED AT 50 MPH.....	20
TABLE 2.3	OLD VERSUS NEW DETECTOR PLACEMENTS.....	23
TABLE 3.1	TIMING CHART - US 70 AT SR 1913 (WILSON’S MILLS ROAD).....	30

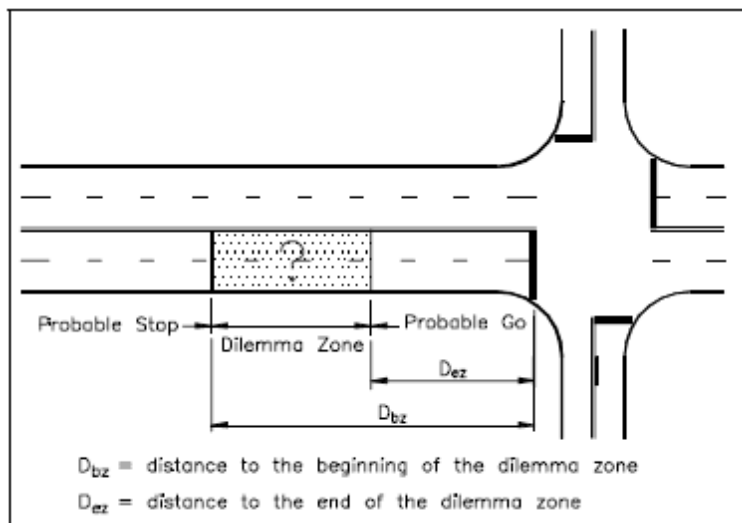
TABLE 3.2	REVISED TIMING CHART .....	32
TABLE 3.3	SIGNAL TIMING FOR US 70 AND SR-1901 (POWHATAN ROAD) .....	34
TABLE 3.4	CHARACTERISTICS OF SEVERAL HIGH-SPEED INTERSECTIONS .....	35
TABLE 3.5	FHWA RECOMMENDED DILEMMA ZONES.....	39
TABLE 3.6	DETECTOR SET-BACKS .....	41
TABLE 3.7	DETECTOR PLACEMENTS FOR SOUTH CAROLINA .....	42
TABLE 3.8	CALTRANS DESIGN SPECIFICATIONS .....	43
TABLE 3.9	SUGGESTED SET-BACKS .....	47
TABLE 3.10	DETECTOR PLACEMENT GUIDELINES - VIRGINIA .....	47
TABLE 3.11	DETECTOR SET-BACKS BASED ON SPEED LIMIT .....	47
TABLE 4.1	TIME STAMPS FOR VEHICLE EVENTS .....	67
TABLE 4.2	SIGNAL TIMING DATA EXCERPT .....	68
TABLE 4.3	YELLOW ANALYSIS RESULTS .....	68
TABLE 4.4	ALL YELLOW OPTIONS ANALYSIS .....	69
TABLE 4.5	SIMULATION RESULTS SUMMARY.....	71
TABLE 4.6	NQ4 FIELD RESULTS AT SWIFT CREEK (SEE FOOTNOTE 13).....	79
TABLE 4.7	D-CS FIELD RESULTS AT SWIFT CREEK.....	80
TABLE 4.8	FIELD RESULTS FOR ALL SITES.....	81
TABLE 4.9	PROBABILITIES OF NO VEHICLES IN DILEMMA ZONES .....	81
TABLE 5.1	ESTIMATED CRASH COSTS .....	87
TABLE 5.2	INSTALLATION COST .....	88
TABLE 5.3	AVERAGE STOPPED DELAY PER VEHICLE BY INTERSECTION .....	89
TABLE 5.4	ANNUAL CHANGE IN DELAY COST .....	90
TABLE 5.5	USE OF NAZTEC SYSTEM WHEN COMPARED TO A 2070 CONTROLLER.....	91
TABLE 5.6	USE OF NQ4 SYSTEM WHEN COMPARED TO A 2070 CONTROLLER .....	91
TABLE 5.7	USE OF NQ4 SYSTEM WHEN COMPARED TO NAZTEC SYSTEM.....	92

# 1. INTRODUCTION

High-speed, signalized intersections require special attention to ensure safe operation. A critical element is the placement of detectors, especially those that sense the approach of vehicles on the mainline when a change interval is about to commence. Prior research indicates that well-placed detectors, when working with a carefully-designed signal control strategy, can reduce the likelihood of both right-angle and rear-end collisions as drivers on the main road deal with dilemma zone issues – whether to slow down and stop or continue through the intersection.

In the case of this project, the North Carolina Department of Transportation (NCDOT) was interested in guidance about where to place detectors on high-speed approaches and what control strategies to employ. The Department asked the research team to investigate current best practices, theories, and trends; model the impact of various vehicle detection loop placement using simulation; field evaluate alternate vehicle detection loop placements; determine the costs and benefits of recommended practices generated from research including the impact on vehicle delay; and develop new recommended practices.

The “dilemma zone” is the region where, as shown in Figure 1.1, at the onset of yellow on the major road, drivers are in a dilemma about whether to continue through the intersection or stop. Some researchers define it based on distance; others use time.



**Figure 1.1** Typical Dilemma Zone Definitions

(Source, Bonneson *et al.*, 2002)

Bonneson *et al.* (2002) concluded that the dilemma zone boundaries would be most precisely defined if travel time from the stop line (as opposed to distance) was used. Further, they concluded that it was practical to use the 90<sup>th</sup> and 10<sup>th</sup> percentile drivers, respectively. This meant their boundaries for the dilemma zone extended from about 5.5 seconds away from the stop bar to about 2.5 seconds away, a result that has been followed in this research.

The challenge is to determine how to protect the drivers that find themselves in this zone, from 2 to 6 seconds away from the stop bar at the onset of yellow. One way is to ensure that no one is in a dilemma zone when the yellow commences. This is the strategy that the research team pursued. The challenge is to determine how to place the sensors and create a signal control strategy that helps ensure that will happen.<sup>3</sup>

In North Carolina, the starting point is Standard 4.1.1, specifically sheet 3 of 4, shown in Figure 1.2, which indicates the standard placement for through move detectors on the main street. Detectors L1 are well upstream of the stop bar, wired in series (which means detection in either lane is allowed), at distances that depend on the road's design speed; and a formula is given to determine the extension time that should be used in conjunction with the detectors.

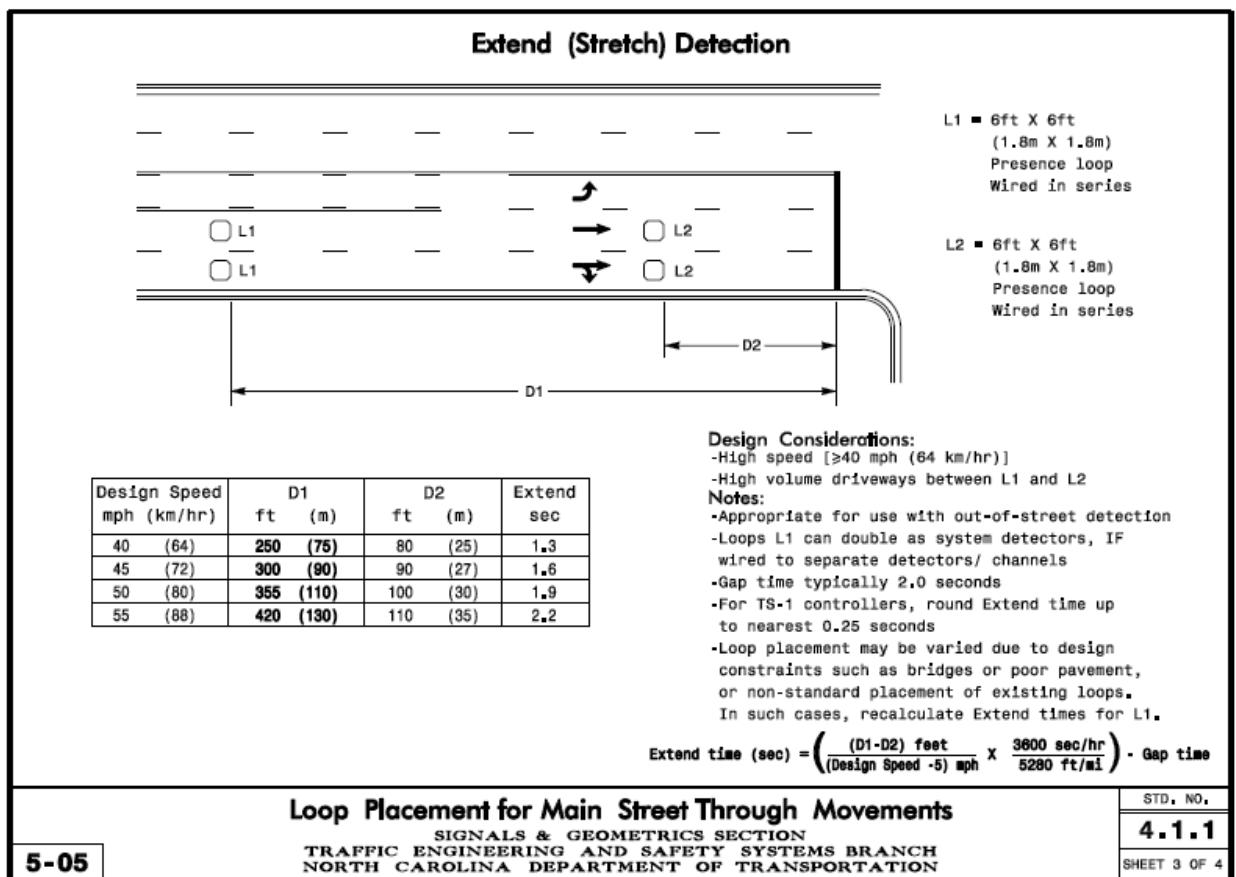
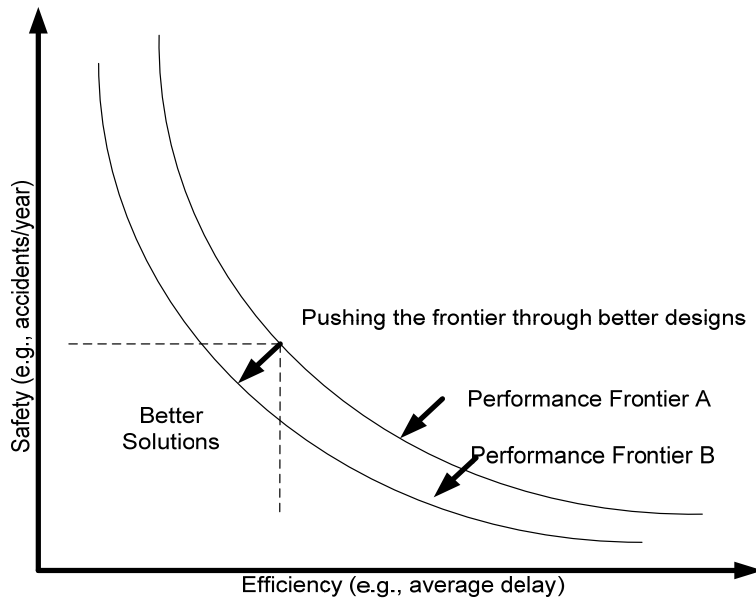


Figure 1.2 Standard 4.1.1, Sheet 3 of 4, Guidelines for Loop Placement for Main Street Through Movements

<sup>3</sup> Another idea, which represents good signal timing practice, is to ensure that the change interval timings, the yellow plus all-red, ensure that vehicles at the 6-second edge of the dilemma zone can actually progress through the intersection before a conflicting movement receives a green. It is clear that NCDOT follows this practice.

The focus of this research is to determine whether this practice – not just this figure, but NCDOT’s policies for placement of detectors in general – can be improved and enhanced so that safer and more efficient designs can be obtained, both at new and existing intersections.



**Figure 4: Tradeoff Surface**

**Figure 1.3 Tradeoff Surface**

In essence, the project was aimed at improving both intersection safety and efficiency, as portrayed in Figure 1.3. On the one hand, NCDOT would like to improve intersection safety, perhaps as measured by fatal and injury accidents per year. On the other, it would also like to enhance efficiency, perhaps measured by average delay. Desirable solutions would improve both, as shown by the “better solutions” region in the figure. The performance frontiers, A and B, indicate the best possible combinations of safety and efficiency that can be achieved by a particular intersection design, in this case, the combination of sensor placement and signal control strategy. If the performance can be improved, then frontier B replaces frontier A. Achieving this improvement is the objective of this research.

The options for moving the performance frontier involve better detector layouts, better signal timing, and better intersection design. Put another way, the options include:

- Improved detector locations and designs
  - speed traps (to support deceleration calculations)
  - video sensors, wireless detectors
- Improved signal visibility
- Enhanced warning signs ahead of the intersection
- New ways to control the green time extensions
- Better yellow and all-red times

- Vehicle countdown signals
- “Red” signal ahead signs

Three options were attempted in this project. First, the standard NCDOT detector placements and volume-density control. Second, the standard option augmented by mainline speed traps 1,000 feet upstream that feed NQ4 Long Vehicle System devices. It represents the manner in which NCDOT typically addresses the need for advance detection and high-speed protection. Third, an option also with the speed traps (but without the NQ4s) that applies the insights of Bonneson et al. via a Naztec 2070 controller in a Naztec TS-2 cabinet operating a Detection-Control System algorithm.

This project has found that improved detector placement in conjunction with a more advanced signal control strategy can result in a significant reduction in the number of vehicles caught in dilemma zones at the onset of yellow; a result that is achieved simultaneous with an improvement in intersection efficiency, reflected in reduced delays.

## 2. LITERATURE REVIEW

The state-of-the-practice in detector placement and signal control is reflected in designs that are currently being implemented by states nationwide. NCDOT practice can be found in the Design Manual available online at <http://www.ncdot.gov/doh/preconstruct/altern/value/manuals/default.html>. This chapter reviews the state-of-the-art (frontier of research) in this area, as well as the state-of-the-practice, and points toward innovative ideas that hold promise for enhanced safety and efficiency.

### 2.1 Classic References

The somewhat dated Traffic Detector Handbook (FHWA-IP-90-002) provides guidance about where to place detectors on high-speed approaches. In addition, it indicates that warning signs, that flash to indicate an impending yellow, should be combined with advance detectors to give drivers information about signal indication changes.

The Manual on Uniform Traffic Control Devices (MUTCD) also provides design guidance. It recommends the installation of the W3-3 sign to warn drivers of an upcoming signal. However, this sign can be criticized for its lack of real-time information, potentially leading it to being ignored by drivers. If a stronger link were made between the sign's location and the dilemma zone, then drivers' reactions to the sign might be more deliberate.

The MUTCD also provides guidance about time interval durations. "A yellow change interval should have a duration of approximately 3 to 6 seconds. The longer intervals should be reserved for use on approaches with higher speeds....The yellow change interval may be followed by a red clearance interval to provide additional time before conflicting traffic movements, including pedestrians, are released...A red clearance interval should have a duration not exceeding 6 seconds."

More information about current practice nationwide can be found in the toolbox for red light running (Institute of Transportation Engineers, 2003) and the toolbox for intersection safety and design (Institute of Transportation Engineers, 2004). An older, but still very useful guideline to detector placement is found in the Traffic Control Systems Handbook, again prepared by the Institute of Transportation Engineers (1985). There is also the traffic signal book by Orcutt (1993).

### 2.2 Bonneson *et al.* (2002)

The study by Bonneson *et al.*, (2002) is a good reflection of the state-of-the-art.<sup>4</sup> The study team examined four detection schemes that were in common use and then experimented with a new idea called the "detection-control system" or D-CS. Insofar as existing practice is concerned, Table 2.1 indicates that Bonneson *et al.* perceived there were four: 1) Multiple Advance Detector system, of which variants are in fairly widespread use nationwide, 2) the TTI Truck Priority

---

<sup>4</sup> See <http://tti.tamu.edu/media/releases/2003/system.stm> and <http://tcd.tamu.edu/documents/5-4022-1.pdf>.

system, 3) the LHOVRA system developed by the Swedish National Road Administration, and 4) the SOS system developed for the Swedish National Road Administration by the Transport Research Institute.

**Table 2.1 High Speed Detection Systems Currently in Use as of 2002**

Operating Characteristic		Detection System			
		Multiple Advance Detector	Truck Priority	LHOVRA	SOS
FUNCTION					
Dilemma (or clearance) zone protection.	For passenger cars.	✓	✓	✓	✓
	For trucks.	--	✓	--	--
Delay reduction capability.	For major movements.	✓	✓	✓	✓
	For minor movements. <sup>1</sup>	--	--	--	✓
CONTROL LOGIC					
Goal: End green when...	...clearance zone empty.	✓	✓	✓	--
	...least delay+crash cost.	--	--	--	✓
Meaning of maximum green.	Absolute end of green.	✓	--	--	--
	Can be exceeded.	--	✓	✓	✓
Ability to end green on opposing approaches at separate times.		--	--	✓	✓
External computer.		--	✓	--	✓
DETECTOR LOGIC					
Typical number of detectors (for 55-mph design).	One-lane approach.	4	6	3	4
	Two-lane approach.	4	8	3	8
Separate detectors for each lane.		--	✓ <sup>2</sup>	--	✓

Notes:

✓ = yes, "--" = no.

1 - Assumes that only the major-road through movements are provided advance detection.

2 - Only for the first upstream detection zone.

(Source, Bonneson *et al.*, 2002)

A number of papers were generated by the 2002 study, and follow-on work was conducted in 2005. The papers include: Zimmerman *et al.* (2003), Zimmerman and Bonneson (2004), Bonneson and Zimmerman (2004), Zimmerman and Bonneson (2005), and Zimmerman and Bonneson (2007). The latter paper portrays the most recent thinking about D-CS and the results of several field studies.

The conclusion of the 2002 study was that none of the existing detection strategies represented the best possible solution. Instead, a new idea, called the "detection-control system" (D-CS) was found to out-perform these more common strategies. The D-CS system was described as "a pair of inductive loop detectors ... placed in each major road traffic lane at least 700 ft upstream of



the intersection in a speed-trap configuration. As a vehicle passes over these loops, the detection information is fed into a classifier that determines the vehicle's speed and length. Using this information, the detection-control algorithm, operating within a computer at the intersection, calculates when that vehicle will be in its 'dilemma zone' on the intersection approach. It then prevents the phase from ending when one or more vehicles are in the dilemma zone.... The location of this detection is based on a desire to have the system 'look' into the future of vehicle arrivals to the dilemma zone. The detection-control system searches for a time when each vehicle served by the subject phase is outside of its respective dilemma zone. It uses a dynamic dilemma-zone monitoring process that enables it to safely end the phase and to do so with a relatively short maximum allowable headway. The implications of this operation are that the system will operate with less delay (through shorter phase durations) and with fewer vehicles caught in the dilemma zone than the multiple advance detector system." The D-CS strategy was the one selected by the research team for further investigation and experimentation in the project.

The detection-control system decides whether it is better to continue the current green phase or terminate it based on the information provided by the "vehicle communication system" and the "traffic control system". The vehicle communication system provides information about vehicle lengths, speeds, and lane locations from the upstream major-road detectors; while the traffic control system provides information about the presence of vehicles waiting at each of the conflicting movements.

Bonneson *et al.* (2002) suggest that system effectiveness is best measured by a tradeoff between two indicators: 1) the number of vehicles caught in the dilemma zone at the onset of yellow versus 2) overall motorist delay. They measure efficiency in terms of the number of detection loops needed for each lane of the major-road approach and the ease with which the system can be installed and operated. They assess the value of the system based on comparison with the "multiple advance detector system".<sup>5</sup>

In essence, as said earlier, the system minimizes the total number of vehicles, especially trucks, which are caught in the dilemma zone at the onset of the yellow interval. It tracks the vehicles as they approach the intersection; projects when, in the future, based on wall clock time, they will enter and leave their dilemma zones; and then estimates, again at specific points in wall clock time, how many vehicles will be in dilemma zones. It decides to end the phase when there are no vehicles in any dilemma zone. The trade off, which is also estimated for each point in future wall clock time, is the delay that will have accrued to the vehicles on the conflicting phases.

The Detection-Control Algorithm comprises a *Vehicle-Status Component* and a *Phase-Status Component*. Each of these is discussed briefly in the following paragraphs.

The *vehicle-status component* tracks the number of vehicles, by type, that are within dilemma zones or will be in the near future. Every 0.05 seconds, the component queries the vehicle classifier to update information about each vehicle. The vehicle-status component sequentially checks the outputs from the detectors on the major-road approach lanes while NEMA phases 2

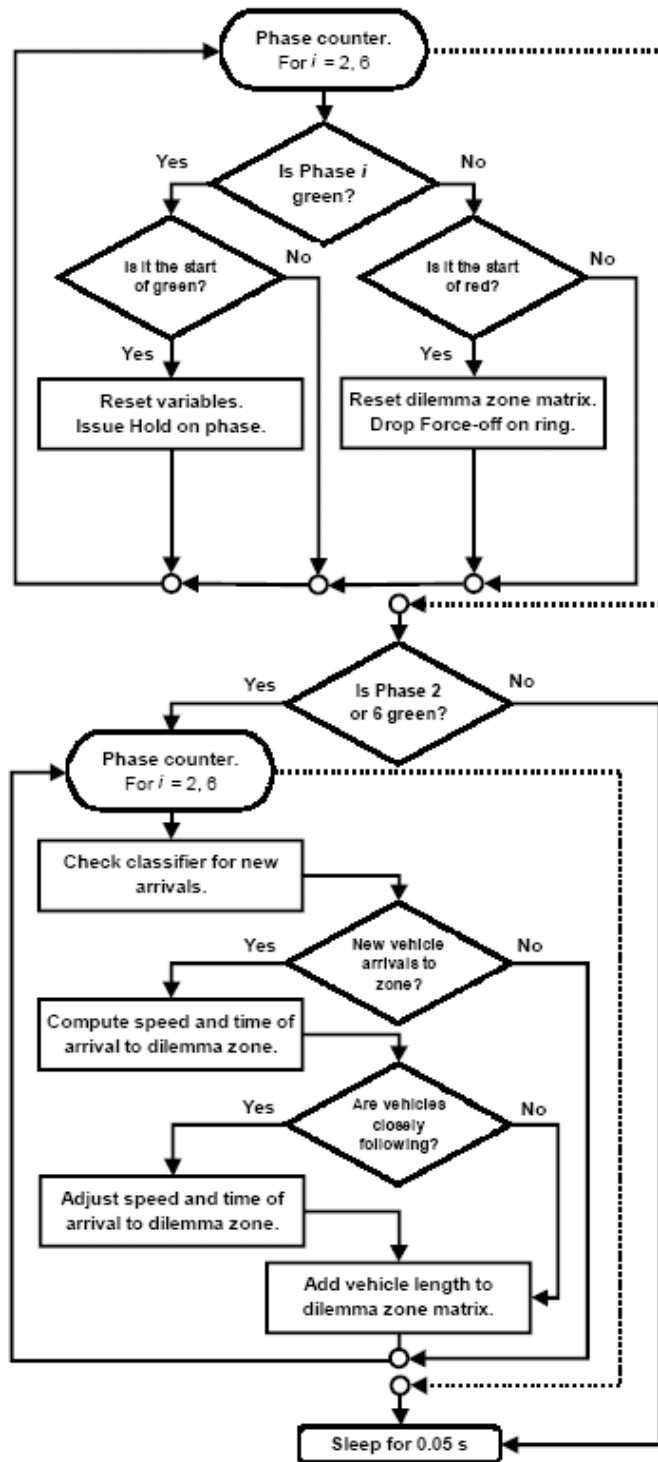
---

<sup>5</sup> The multiple advance detector system is akin to the Beirele and SDITE configurations. Multiple detectors are used in conjunction with gap times that check to see if vehicles are progressing from one detector to another and not stopping.

and 6 (major street) are green. At the start of green on either of the main street approaches, the dilemma zone matrix is re-initialized. The algorithm works well on both single-lane and multilane roads under a range of volume conditions.

The logic of the algorithm is perhaps best illustrated by pseudo-code. It is assumed that phases ( $\Phi$ ) 2 and 6 are the main street through movements.

```
If ( $\Phi = 2$  or 6)
  Do While (the phase is in green)
    If (the phase is at the start of green) then
      Reset dilemma zone matrix ( $\Phi$ )
      Issue hold on  $\Phi$ 
    Else if (the phase is at the end of green) then
      Reset dilemma zone matrix ( $\Phi$ )
      Drop force-off on ring (reset force-off to  $\infty$ )
      Exit Do
    End if
    Check classifier for new arrivals
      If (there is a new vehicle arrival)
        Compute its speed
        Compute its time of arrival and departure for the dilemma zone
        Adjust its time of arrival and departure based on downstream vehicles
      End if
    Update the dilemma zone matrix
    Wait 0.05 seconds
  Loop
End if
```



**Figure 2.1** Vehicle-Status Component Algorithm Flowchart

(Source: Bonneson *et al.*, 2002)

After the green interval starts, every 0.5 seconds, the *phase-status component* re-evaluates the best time to end the phase. Pseudo-code for this component is presented next. Again, it is assumed that phases ( $\Phi$ ) 2 and 6 are the main street through moves,  $T$  is the seconds of main street green that have transpired and  $T_{max}$  is the maximum for main street green.

```

If ( $\Phi = 2$  or 6)
  Do While (the phase is in green)
    Get phase status ( $\Phi$ )
    If ( $T = T_{max}$ ) then
      Issue a force-off for the phase
      Drop the hold for the phase
      Exit Do
    Else If ( $T < T_{max}$ ) then
      If ( $T_{max}$  timer not started) then start  $T_{max}$  timer
        Sum conflicting phase calls
        If (sum = 0) then restart  $T_{max}$  timer
      End If
      Compute phase end-costs for future points in time
      Find the best time to end the phase (BTTE)
      If ( (BTTE = present time) or ( $T = T_{max}$ ) ) then
        Determine where the conflicting call(s) have come from
      If (there is a call only by the opposing left turn) then
        Set a flag to end the phase
      Else
        Set a flag to end both phases 2 & 6
      End if
      If (a flag is set to terminate the phase) then
        Issue force-off and drop the hold on the phase
      Else
        Wait 0.5 seconds
      End If
    Loop
  End If

```

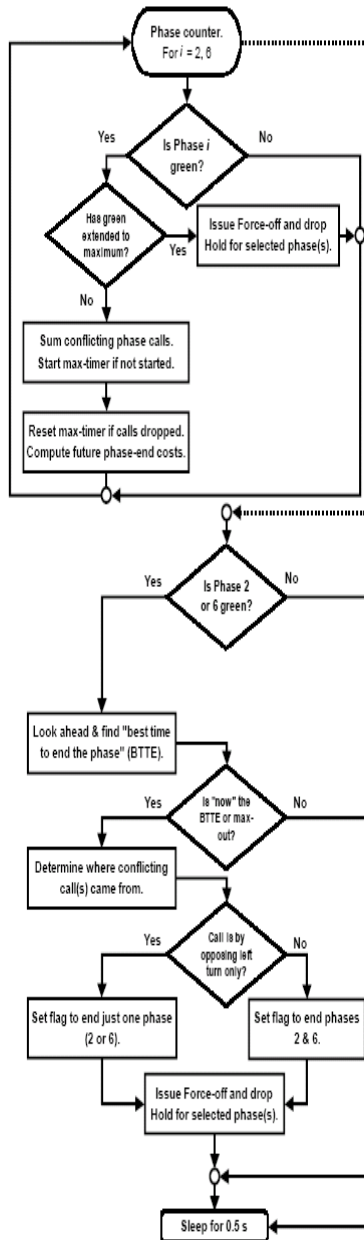


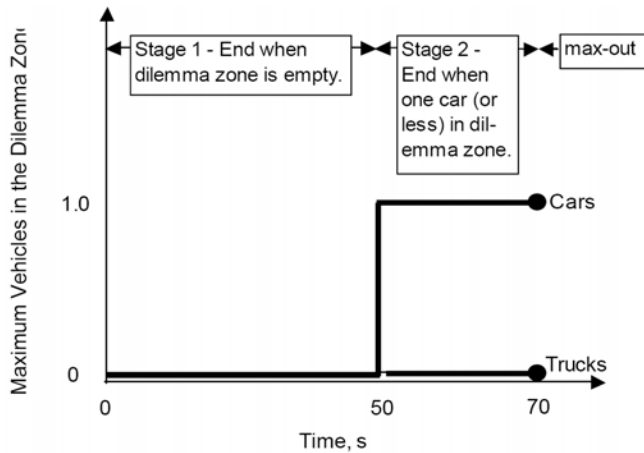
Figure 3-7. Phase-Status Component Algorithm Flowchart.

**Figure 2.2 Phase-Status Component Algorithm Flowchart**

(Source: Bonneson et al., 2002)

The *Two-Stage Gap-Out Feature* allows the signal to look for the best time to end the phase. In Stage One the signal looks for a time when no vehicle will be in a dilemma zone. In Stage Two it

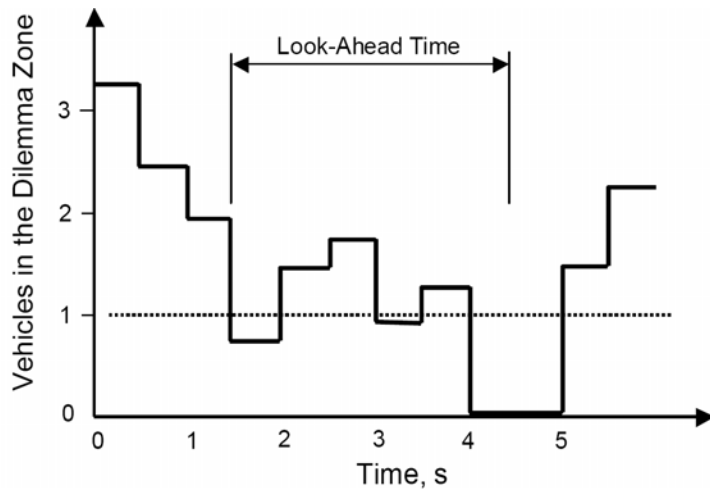
looks for a time when just one vehicle per lane, and no trucks, will be in a dilemma zone. This is illustrated by Figure 2.3.



**Figure 2.3 Two-Stage Gap-Out Feature**

(Source: Bonneson *et al*, 2002)

The *Look-Ahead Feature*, which is utilized during Stage Two, allows the signal to evaluate dilemma zone occupancy several seconds before the vehicles actually arrive. The feature is illustrated by Figure 2.4. The algorithm is structured in such a way that after evaluating all half-second intervals during the current look-ahead time, the interval with the fewest total cars in dilemma zones (considering all lanes) is identified as the BTTE.



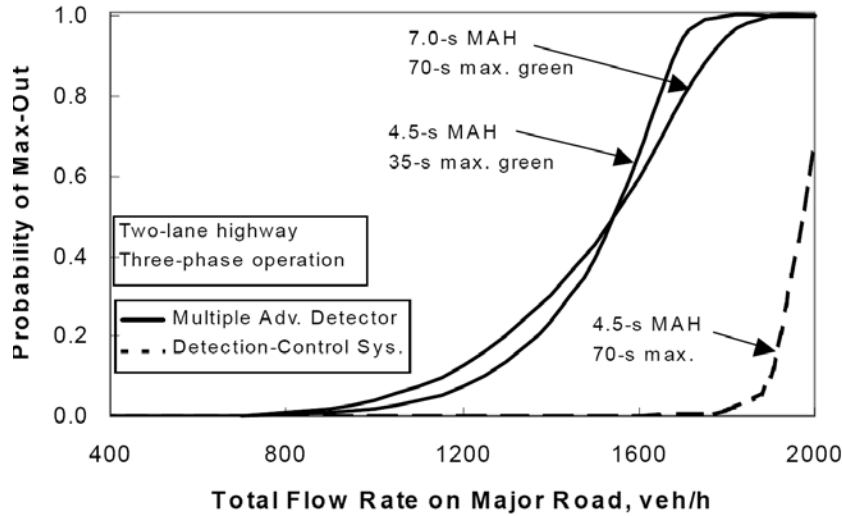
**Figure 2.4 Look-Ahead Feature**

(Source: Bonneson *et al*, 2002)

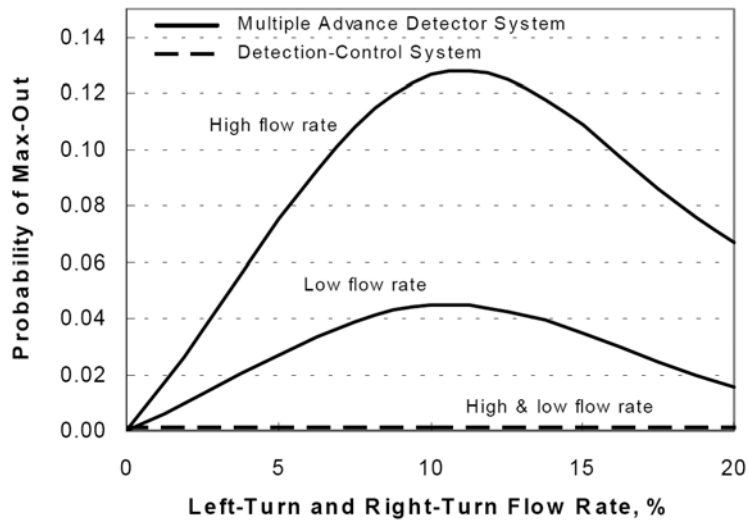
*Maximum Allowable Headway (MAH)*. This is the largest time interval between detector calls that will still extend the green indication for the main street phase. Theoretically, the MAH for the detection-control system is equal to the travel time through the dilemma zone. The effective

MAH for the detection-control system is about 4.5 seconds considering the variation in the vehicle speeds in addition to the system's limited ability to measure speeds accurately.

*Probability of Max-out.* Bonneson and McCoy (2005) indicate that for flow rates higher than about 800 vehicles per hour (vph), the probability of max-out is lower for the detection-control system than for the multiple advance detector system (against which the Bonneson system is being compared). See Figure 2.5. In addition, Figure 2.6 suggests that unlike the multiple advance detector system, the detector-control system is unaffected by left and right turn flow rates.

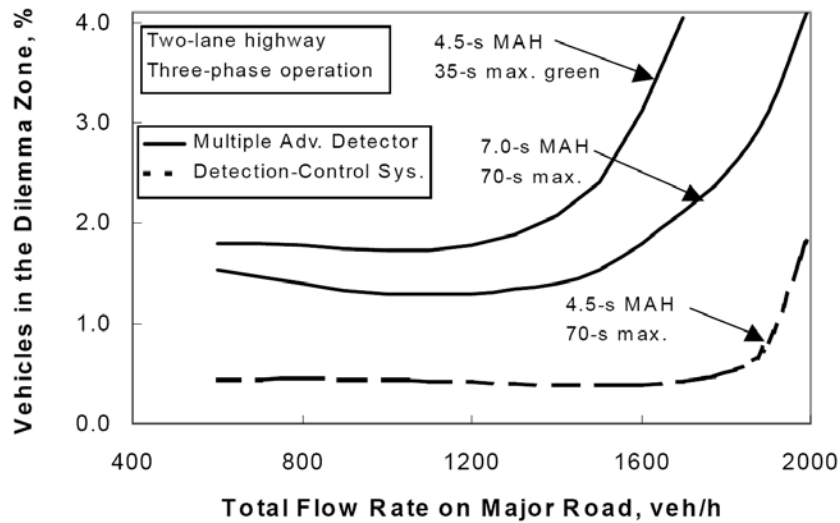


**Figure 2.5** Probability of Max-Out  
(Source: Bonneson *et al.*, 2002)

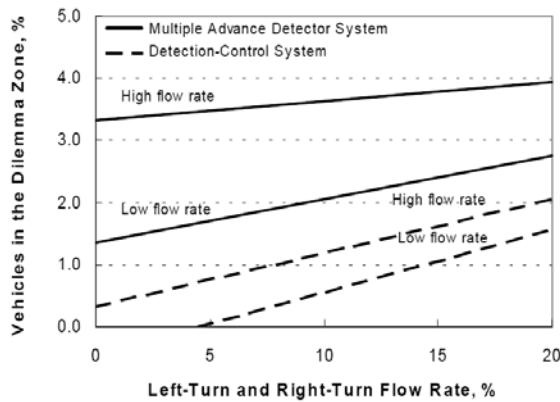


**Figure 2.6** Effect of Various Features on Max-Out Frequency  
(Source: Bonneson *et al.*, 2002)

The *percent of vehicles in the dilemma zone* is developed to illustrate how well the detection-control system performs. As shown in Figure 2.7, the number vehicles caught in the dilemma zone is far less for the detection-control system than it is for the multiple advance detector system. Also from Figure 2.8, it is evident that the effect of the left and right turn flow rates on percentage of vehicles caught in the dilemma zone is less for the D-CS than for the multiple advance detector system.



**Figure 2.7** Vehicles in the Dilemma Zone  
(Source: Bonneson *et al.*, 2002)

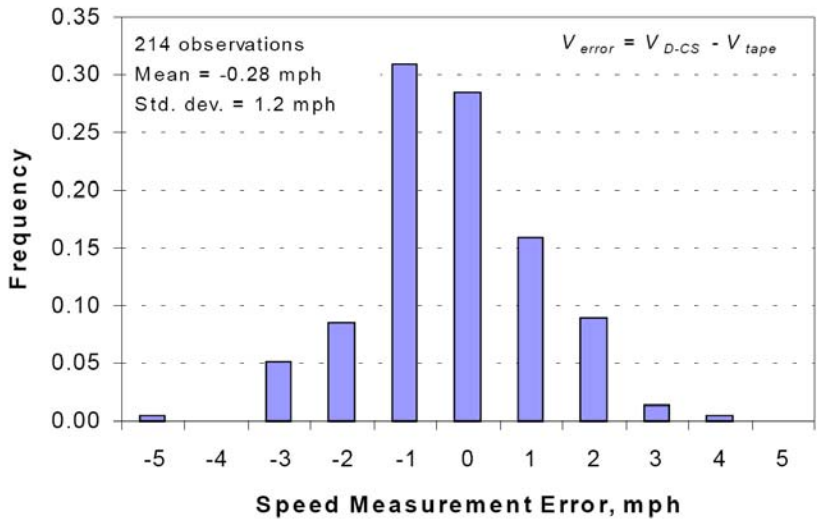


**Figure 2.8** Effect of Various Factors on Percent of Vehicles in the Dilemma Zone  
(Source: Bonneson *et al.*, 2002)



Bonneson *et al.* (2002) evaluated the detection-control system's performance through observations of more than 8,900 vehicles during 32 hours. Analysis of this data indicated that the system performs very well, but that it did have the following limitations.

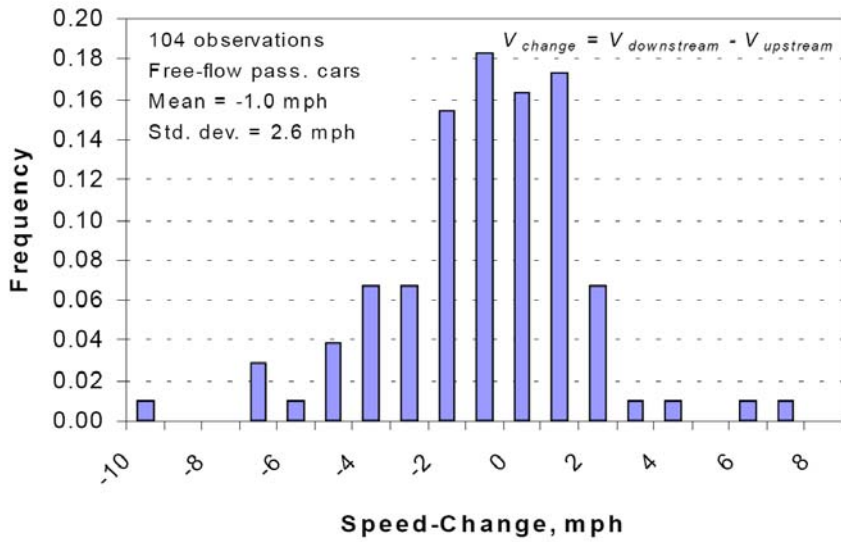
The difference in speed estimates between the D-CS and a tape-switch speed trap is -0.28 mph, as shown in Figure 2.9, suggesting that the detection-control system slightly underestimates the true speed. This results in vehicles entering their dilemma zones slightly sooner than predicted by the D-CS.



**Figure 2.9** Histogram of Speed-Error

(Source: Bonneson *et al.*, 2002)

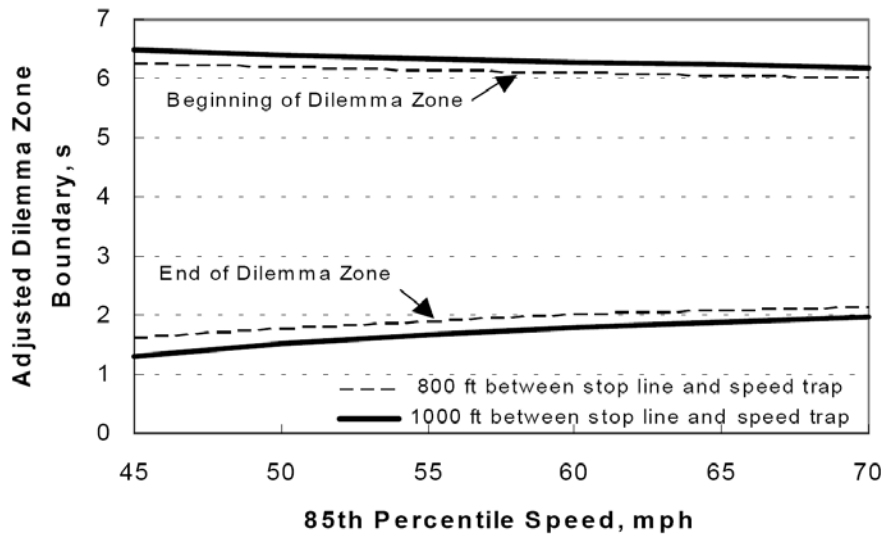
The field study also suggested that average drivers slow down on approaching the intersection irrespective of whether they are impeded or unimpeded by the other vehicles. As Figure 2.10 shows, their field measurements indicated a mean speed change of -1 mph suggesting that drivers will enter their dilemma zones later than predicted by D-CS.



**Figure 2.10 Histogram of Speed Change**

(Source: Bonneson *et al.*, 2002)

Finally, D-CS had limited accuracy in predicting vehicle arrival times into dilemma zones which forced an adjustment to the dilemma zone boundaries so that dilemma zone protection could be provided for all vehicles. This is illustrated in Figure 2.11. For a true average speed of 53 mph (60<sup>th</sup> 85<sup>th</sup> percentile speed) and a detector distance of 1,000 feet, the adjusted dilemma zone starts 6.28 seconds before the stop line and ends at 1.78 seconds from the stop line.



**Figure 2.11 Adjusted Dilemma Zone Boundaries**

(Source: Bonneson *et al.*, 2002)

A very recent development is that Naztec<sup>6</sup> has incorporated the D-CS logic into its 2070 controller. This means that, instead of having to piece together the elements of the D-CS system, which is what Bonneson *et al.* (2002), had to do, researchers can acquire a Naztec controller, install the necessary detectors, and experiment with the control strategy in the field.

### **2.3 Si, Urbanik, and Han (2007)**

A recent study provides significant insight into the detection choices. Using VISSIM, Si, Urbanik, and Han (2007) simulated four detector placement options for high-speed intersections. The configurations that were evaluated were: “Single Detector”, “Beirele”, “Southern District Institute of Traffic Engineers (SDITE)”, and “Bonneson”. The study found that the Bonneson configuration outperforms the other three by a significant margin. Without presenting the details contained in the main report, in 1,080 independent 900-second runs at 600 vehicles per hour per lane, they found that the Bonneson configuration trapped only 14 vehicles upon the onset of yellow versus 93 for the single detector configuration, 131 for the SDITE configuration, and 214 for the Beirele configuration.

To quote fairly extensively from Si, Urbanik, and Han (2007), here is their description of the four detector configurations:

[The *Single Detector Configuration* was] the simplest option zone<sup>7</sup> protection configuration, employing only one 6x6-ft (1.8x 1.8-m) detector on each lane, placed at the start of the option zone for the design speed. No consideration is given to slower-speed vehicles. Three seconds of passage time is used to allow design-speed vehicles to travel out of their option zone at the design speed. This configuration must operate with locking memory since there is no stop-line detector.

The *Beirele Configuration* uses a one-second passage time throughout the detection zone (2). The controller operates in a fully actuated locking mode. It utilizes 6x6-ft (1.8x 1.8-m) presence mode loop detectors.

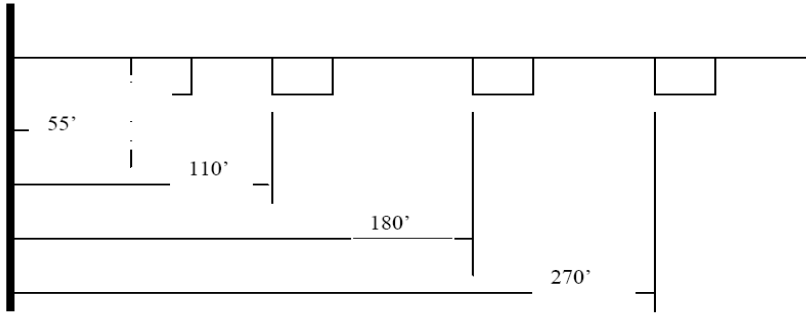
The detector layout is based on safe stopping distance for vehicles with different speeds. The outermost detector is placed where a vehicle traveling with the design speed can stop safely. The second detector is located at the safe stopping distance for a speed 10 mph less than the design speed. Other detectors closer to the intersection follow the same procedure, with 10 mph less each time, until the last one is within 75 ft of the stop line.

The Texas State Department of Highways and Public Transportation (now TxDOT) modified this configuration with the AASHTO stopping distance criteria. The detector placement in the Beirele configuration for 50-mph design speed is shown in Figure 1 [Figure 2.12].

---

<sup>6</sup> <http://www.naztec.com/index2.htm>

<sup>7</sup> Option zone - It is defined as a length of roadway in advance of the intersection where an individual driver may experience indecisiveness upon seeing the indication of yellow.

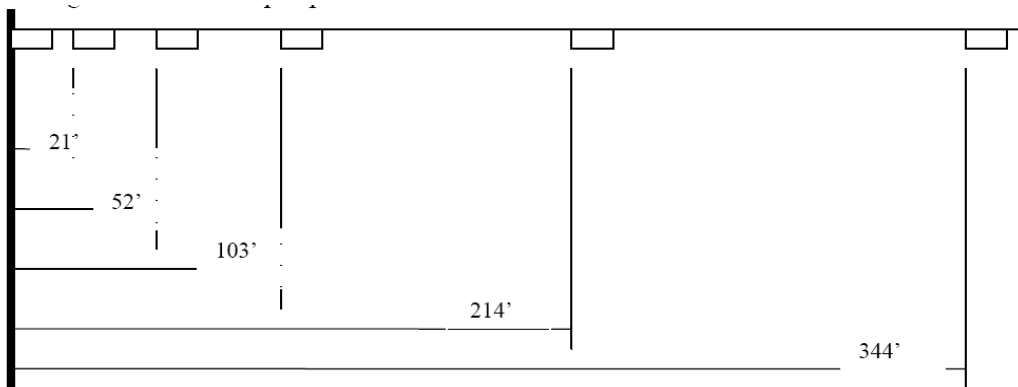


**Figure 2.12 Beirele Recommended Detector Configurations for a 50-mph Design Speed**

(Source: Si, Urbanik, and Han, 2007)

[The *SDITE Configuration*] was developed by the Southern District Institute of Transportation Engineers .... It uses a basic actuated controller (no volume density) and multiple 6x 6-ft loops, but it operates in a non-locking mode. The passage time is 2 seconds.

This configuration utilizes primarily engineering judgment to determine the location of detectors. The outermost detector is positioned at approximately 5 seconds of travel distance at design speed to give option zone protection. The second detector should be located to allow the 50-mph vehicle to hold the green. The other detectors are placed to accommodate vehicles with reduced speed, and the stop-line detector prevents premature gap-out during queue discharge. Figure 2 [Figure 2.13] is the SDITE recommended detector configuration for 50-mph speed.



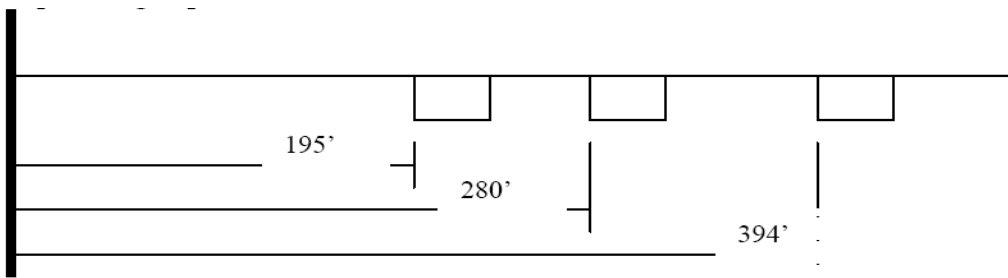
**Figure 2.13 SDITE Detector Configuration for 50-mph Design Speed Approaches**

(Source: Si, Urbanik, and Han, 2007)

[The *Bonneson Configuration* explored by Si, Urbanik, and Han dates from Bonneson and McCoy<sup>8</sup> (1994). It is a predecessor to the D-CS configuration, and the two should not be confused. This earlier Bonneson configuration had] two different recommendations for rural and for urban intersections. The recommended detection for rural intersections ... [was explored. It uses multiple advance loops and] ... has features that include locking controller memory, pulse-mode detection, no stop-line detector, and a two-second passage time.

Advance detectors are located at the beginning of the option zones for their design speeds. The outermost detector has the same design speed as the road, and every subsequent detector has a design speed 10 mph less than the one before it. There are two possible design goals in this configuration: either to carry the last vehicle through its option zone before the onset of yellow or to carry the last vehicle to the stop line before the onset of yellow. ...Figure 3 [Figure 2.14] is the Bonneson recommended configuration for a rural intersection with 50-mph design speed,

recognizing, however, that the NCDOT typically designates high speed isolated rural intersection intersections as those with a posted speed limit of 45 mph.



**Figure 2.14 Bonneson and McCoy: 1994 Detector Configurations for Rural Intersections with a 50-mph Design Speed**

(Source: Si, Urbanik, and Han, 2007)

Computer simulations of these four configurations were conducted using VISSIM. Speeds of 30, 40, and 50 mph were explored. Traffic volumes were set to 400, 500, and 600 vehicles per hour per lane to investigate sensitivity to flow rates. The outputs from 1,080 independent 900-second runs were analyzed and compared.

The primary objective was to see how many vehicles would be caught in the option zone at the onset of the yellow indication. Hence, the total number of vehicles in that predicament (across 30 independent simulation runs) and the average number per cycle is reported. Table 2.2 below presents the results for the simulations where the desired speed was 50 mph.

<sup>8</sup> Our recent communication with Bonneson suggests that the Detection-Control System (D-CS) they developed in 2001-2002 is superior to any design based on multiple advance loops including their earlier design which was studied by Si, Urbanik, and Han (2007).

**Table 2.2 Vehicles in the Option Zone with Vehicle Desired Speed at 50 mph**

		Arterial Vehicle Volume (vphpl)		
		400	500	600
Single Detector	Cumulative Vehicles in Option Zone (30 runs)	23	48	93
	Vehicles in Option Zone per Cycle	0.04 <sup>b c</sup>	0.08 <sup>b c</sup>	0.16 <sup>b c</sup>
SDITE	Cumulative Vehicles in Option Zone (30 runs)	40	75	131
	Vehicles in Option Zone per Cycle	0.08 <sup>c d</sup>	0.16 <sup>c d</sup>	0.32 <sup>d</sup>
Beirele	Cumulative Vehicles in Option Zone (30 runs)	180	186	214
	Vehicles in Option Zone per Cycle	0.30 <sup>b d</sup>	0.33 <sup>b d</sup>	0.39 <sup>d</sup>
Bonneson	Cumulative Vehicles in Option Zone (30 runs)	1	4	14
	Vehicles in Option Zone per Cycle	0.00 <sup>a</sup>	0.01 <sup>a</sup>	0.03 <sup>a</sup>

- <sup>a</sup> Not compared with the others
- <sup>b</sup> Significantly different from SDITE ( $\alpha = .05$ )
- <sup>c</sup> Significantly different from Beirele ( $\alpha = .05$ )
- <sup>d</sup> Significantly different from Single Detector ( $\alpha = .05$ )

(Source: Si, Urbanik, and Han, 2007)

As can be seen, the Bonneson configuration outperformed the other three by a significant margin. At 600 vphpl, for example, it catches only 14 vehicles versus 93 for the single detector configuration, 131 for the SDITE configuration, and 214 for the Beirele configuration.

## 2.4 Similar Efforts

While it seems that Bonneson’s work represents best practice insofar as rural high-speed intersections are concerned, it is important to understand what others have done in similar studies. This section summarizes other projects that have experimented with detector placements and signal timings for high-speed rural intersections. In the event that the strategy developed by Bonneson *et al.* (2002) proves to fall short of expectations, or be incompatible with NCDOT practices, these studies will prove helpful in identifying alternate strategies to pursue. The studies have been grouped in the following three categories for discussion: treatment, state needs, and innovations.

There is a recurring theme throughout these other studies. Three types of treatment seem most effective and/or most commonly employed: changes in detector placement, changes in signal timing, and passive or active advance warning systems. An illustration of this is the study by Al-Mudhaffar (2002). Similar to Bonneson *et al.* (2002), he studied ways to improve the incident reduction function used in the LHOVRA technique (see definition of LHOVRA below). Each of the letters in the LHOVRA-acronym represents a different functionality module. These functions are:

- L = Heavy goods vehicle/ bus priority
- H = Mainline priority (where distinction between primary and secondary roads exist)
- O = Incident reduction

- V = Vehicle
- R = Red-light violation control
- A = All red activation

The report describes an incident reduction strategy intended to reduce the number of vehicles in the dilemma zone and to enhance the safety at the high speed isolated intersection by reducing rear end collisions. The strategy aims to improve the incident reduction function by:

- Changing the detector locations(moving the detectors closer to the stop line i.e. moving the first and second detectors from 130 m to 110 m (426' to 360') and 80m to 65m (262' to 213'), respectively, for a 70 km/h posted speed limit (45 mph);
- Making the green time extension conditional depending on the speed of the vehicle passing the double detector placed at the entry of the dilemma zone;
- Monitoring the headway between two existing vehicles in the dilemma zone.

The results of the experiment showed a significant safety effect when the function was in operation, shown by a reduction in red-light violations. Positioning the detectors closer to the stop line showed a significantly smaller number of red-light violations in addition to the noticeable drop in the average delay.

Shortly after Bonneson's study (Bonneson *et al.*, 2002), Messer, Sunkari, Charara, and Parker (2003) conducted a second study for Texas DOT of advance warning systems that would help improve the protection of the end of the green phase. Their objective was to get drivers approaching a traffic-actuated signalized intersection at high-speed to slow down to a speed so they can safely stop when the signal turns yellow and then red shortly thereafter. Another objective was to minimize dilemma zone exposure to trucks and high-speed cars when the signal is operating in the green dwell state during light traffic. Their conclusion was that such systems add significant value. The study report includes an extensive discussion of a wide variety of early warning devices and solution options.

Another illustration is Pant and Cheng (2005). They studied dilemma zone protection and signal coordination at closely-spaced high-speed intersections. They calibrated the maximum green extension or the cutback needed to get a vehicle out of the dilemma zone. Their analytical approach was based on the premise that approaching vehicles would be scanned a few seconds before the beginning of a yellow interval, and that the green would be extended long enough to get those vehicles out of the dilemma zone. There are two different time intervals possible for each vehicle approaching the intersection on the link that is about to turn yellow:

- The vehicle is in the dilemma zone without a green extension
- The vehicle is in the dilemma zone when T seconds of green extension remain

The project found that the dilemma zone can be avoided if the smallest value of T is not in either of the time intervals mentioned above, assuming that there are no other restrictions, and that the extension is done at most once for each green interval. Signal timings were generated by a combination of PASSER-II and TRANSIT- 7F (minimizing delay with the constraint of

maximizing band width). The result was a lower number of vehicles in the dilemma zone. Field results suggest that the value of T found should be 2 seconds.

Woods and Koniki (1994) studied the tradeoff between safety and delay at high-speed rural intersections. They observed that delays increase as better dilemma zone protection is provided. The TEXAS model (version 3.2) was used to determine the optimal detector placements for both the mean and the 85<sup>th</sup> percentile speed. The simulation results suggested that at low approach volumes the delay was unaffected by both the mean speed and the 85<sup>th</sup> percentile speed. However, at higher approach volumes the 85<sup>th</sup> percentile speed also had a significant affect on the delays. Regression analysis showed a strong linear relationship between delay and cycle length.

Other studies identified these same themes:

- Srinivas, Bullock, and Sharma (2006) studied the limitations of simultaneous gap-out logic. They suggest that under high traffic flow conditions, simultaneous gap-out logic constrained the signal controller thereby reducing efficiency and dilemma zone protection. Their study emphasized the thought that traffic volumes should be considered before applying the simultaneous gap-out logic in order to mitigate the problem of dilemma zone protection.
- Johnston (2001) examined IMSA traffic signals, and sought another method of dilemma zone protection. He focused on “Prepare to Stop” signs in protecting the dilemma zone. He also discusses geometry, location and specifications for advance warning signs and controllers.
- Parsonson (1978) studied detector-controller configurations for intersections with higher approach speeds (35 mph and greater). He determined that the system should be able to detect approaching vehicles before they enter the dilemma zone and either extend the green time for the safe passage through the zone or end the green phase when the vehicle is still upstream of the dilemma zone. He also summarized the research data on the effectiveness of green-extension systems and proposed a basic, actuated, non-locking configuration for the new controller.
- Agent (1988) studied traffic control and accidents at rural high-speed intersections. He suggested, based on an analysis of accident data, that providing the driver adequate warning of the intersection, providing a proper change interval, and maximizing the visibility of the signal heads are paramount in decreasing accident potential at rural high-speed intersections.

## **2.5 Other Innovations**

A few studies have examined innovations that could help with dilemma zone protection. Huang and Pant (1994) used a neural network<sup>9</sup> along with a traffic simulation model to evaluate

---

<sup>9</sup> Neural Network is an information processing paradigm that is inspired by the way biological nervous systems, such as the brain, process information. The key element of this paradigm is the novel structure of the information processing system. It is composed of a large number of highly interconnected processing elements (neurons) working in unison to solve specific problems.



dilemma zone problems at low-volume, rural high-speed signalized intersections. The study considered detector configurations, advance warning signs with or without flashers, and timings of change intervals or green extensions. The measures of effectiveness were:

- Probability of being caught in the dilemma zone;
- Speed of a vehicle in different segments of the intersection approach; and
- Vehicle conflict rate.

The traffic simulation model dynamically represented each element of the traffic control system: roadway geometrics, traffic control devices and vehicular movements. The neural network model estimated vehicular speeds in different segments of the intersection approach in response to different warning signs, flashers, and signal indications. These two models were integrated in order to provide better accuracy of the simulation.

A case study showed that the results of the simulation-neural network are well compared to the field data collected at several low-volume, high speed signalized intersections in Ohio.

Moon, Lee, and Park (2003) conducted field tests to develop a new in-vehicle dilemma zone warning system. The system comprised hardware (an in-vehicle warning device, a roadside antenna, and a traffic signal controller) and software for operating and testing the integrated component warning and communications systems. Field tests suggested that implementing this system at a signalized intersection could eliminate the dilemma zone relative to approach speeds and controls red-light violations with the aid of the In-vehicle warning device.

Middleton *et al.*, (1997) studied new detector placements. Field data, shown in Table 2.3, suggested that the new placements could detect vehicles further upstream of the intersection resulting in a fewer number of vehicles caught in the dilemma zone at the onset of yellow. It also reduced the number of vehicles entering the intersection during the red light.

**Table 2.3 Old versus New Detector Placements**

<b>Old Procedure (89 km/h(55mph))</b>	<b>New Procedure (113 km/h (70mph))</b>
24 m (80 ft)	107 m (350 ft)
43 m (140 ft)	145 m (475 ft)
67 m (220 ft)	183 m (600 ft)
98 m (320 ft)	N/A

Source: Middleton *et al.*, 1997

## **2.6 University of Minnesota**

At the Intelligent Transportation System Institute, Center for Transportation Studies, University of Minnesota (<http://www.its.umn.edu/research/applications/ids/>), two related studies were recently conducted. The first was an FHWA-funded effort focused on enhancing the driver's ability to successfully negotiate rural intersections. The system being examined used sensing and communication technology to determine the safe gaps and then communicate this information to the driver so that he or she could make an informed decision about crossing the intersection or entering a major road traffic stream. The goal of the research was to reduce crashes and fatalities

at such intersections without having to introduce traffic signals, which on high-speed rural roads often lead to an increase in rear-end crashes. The second study, a multi-state pooled fund effort, focused on developing a widely deployable framework for Rural Intersection Decision Support (IDS). More information, including the research prospectus, can be found on the project's home page, review Study TPF-5(086) on the FHWA's Transportation Pooled-Fund site.

## **2.7 Other Studies**

A host of other studies have focused on pieces of the dilemma zone protection problem. These studies might be useful to understand phenomena that are observed or to overcome deficiencies in the Bonneson strategy, if they arise.

One area of emphasis has been driver behavior and interaction, the human factors side of the problem. For example, Sheffi and Mahmassani (1981) developed models of driver behavior at high-speed signalized intersections. They suggested assessing the length and location of the dilemma zone. They modeled the drivers behavior as a binary decision (either stop or go) with dilemma zone boundaries established based on vehicle performance characteristics.

Smith, Hammond, and Wade (2002) investigated the effect of advanced warning flashers on driver performance. Sponsored by Minnesota Department of Transportation, the study used simulation to conclude that advance warning flashers will aid drivers with decision making, and promote safer driving behavior at the onset of yellow.

Wang, Wang, and Deng (2005) studied the issue of red-light running. Their research suggests that the existence of a dilemma zone depends on the selection of yellow interval and assumption of correlative factors and it also suggests that the existence of a dilemma zone is a causal factor for the red light violation by drivers.

Baquley (1988) also studied red-light running. Based on the field data he concluded that approach speeds, traffic cross flows, and vehicle types might be some possible vital factors that influence the red-light running.

Wade, Parsegian, and Rosenthal (1994) studied the complexity of the roadway environment. Using simulation, they concluded that increased complexity of signal and sign treatment degrades a driver's response speed and correctness.

Several studies have focused on specific treatment options (signal timing, detector placement, advance warning signs, etc.) and the effects they have on dilemma zone protection.

For example, here in North Carolina, Cribbins and Walton (1970) studied the use of overhead flashers. The findings suggested that the installation of overhead flashers reduced both accident rates and accident exposure.

Sabra (1985) also studied driver response to active advanced warning signs. Results from a highway driving simulator (HYSIM) indicated the drivers' preference of symbolic signal ahead signs with flashing beacons and its greatest identification distance among the test signs.

Saito, Ooyama, and Sigeta (1990) studied the effects of clearance intervals on dilemma zones. Based on the field data results, researchers concluded that it is necessary to have variable lengths of clearance intervals to simultaneously eliminate the possibilities of the dilemma, option, conflict and escape zones.

Liu, Herman, and Gazis (1996) examined the setting of yellow interval durations. They concluded that for a given intersection geometry and an approach speed equal to the speed limit, setting the yellow time interval using the formula given by Gazis, Herman, and Maradudin might eliminate the dilemma of the driver facing the yellow signal.

York and Alkatib (2000) examined the duration of yellow times. Based on simulation studies, they concluded that longer yellow times increase hesitancy and the size of the dilemma zone, and the use of advanced warning of the upcoming yellow had an adverse effect on rear-end crashes (called shunts in the paper) on the approach to the junction.

Easa (1993) looked at the specification of inter-green intervals from a reliability assessment perspective. He determined that the design of the inter-green interval based on a probabilistic method enables one to estimate the occurrence of the dilemma zone with a specific probability.

Charlton (2003) examined the use of restricted visibility to reduce approach speeds. The field results suggested that using a visual restriction treatment as a surrogate to drivers' anticipatory decision-making resulted in low approach speed and substantially reduced the fatality of a crash.

Keith, Tindall, and Yan (1964) examined the performance of magnetic loop detectors. The purpose was to assess the capability of the detector based on the effect of vehicle placement over the loop, position of the vehicle relative to the loop when the detector indicated the presence of vehicle, and headway resolution of detector.

Rhodes *et al.* (2005) evaluated the accuracy of video-based detection at the stop bar. The results suggested that video detection produces significantly more false detections and missed detections than loop detectors.

Shaflik (1995) studied the proper positioning of detectors. The conclusion is that the placement of detectors some distance in advance of the stop line improves the efficiency of the system by increasing traffic flows, decreasing individual and total vehicle delays, and improving safety.

Middleton and Parker (2003) evaluated the implementation of non-intrusive detectors as an alternative to inductive loop detectors.

## **2.8 Other References and Sources**

A vehicle detector clearinghouse is managed by the Southwest Technology Development Institute. Some examples of the articles that merit exploration include:

- **Detector Placement Innovation**
  - Pant, P. D., Cheng, Y., Rajagopal, A., Kashayi, N. (2005). Field Testing and Implementation of Dilemma Zone Protection and Signal Coordination at Closely-

Spaced High-speed Intersections. University of Cincinnati. Report prepared for Ohio Department of Transportation.

- Sackman, H. (1977). Vehicle Detector Placement for High-Speed, Isolated Traffic-Actuated Intersection Control. Report No. FHWA-RD-77-32.
  - Cherrett, T., Bell, H., Consultant, T. (2001). Estimating Vehicle Speed Using Single Inductive Loop Detectors. Institute of Civil Engineers, Transport Journal, Paper No. 12371.
  - Sunkari,S.R., Charara, H.A., Urbanik, T. (2000). Reducing Truck Stops at High-Speed Isolated Traffic Signals. Texas Transportation Institute. Report No. 1439-8.
  - Oh, S., Ran,B., Choi, K. (2003). Optimal Detector Location for Estimating Link Travel Speed in Urban Arterial Roads. The 82nd Transportation Research Board Meeting CD-ROM.
  - Sunkari,S. R., Messer,C. J., Parker,R. T., Charara, H.A. (2003). Signal Technician's Installation and Maintenance Manual for Advance Warning of End-of-Green Phase at High Speed Traffic Signals. Texas Transportation Institute. Report No. 0-4260-3.
- **Detector Technology Innovation**
    - Moon,Y.J., Kim.K. (2004). Development OF Next Generation Traffic Signal Control System Utilizing Wireless Communications. Presented at the 11th World Congress on ITS.
- **Signal Timing Innovation**
    - Pant, P.D., Cheng, Y. (2001). Dilemma Zone Protection and Signal Coordination at Closely-Spaced High-Speed Intersections. Report No. FHWA/OH/2001/12.
    - York, I, Al-Katib, M. (2000). Methods of Traffic Signal Control and Signal Timings at High Speed Sites. IEE Conference Publication.
    - Moon,Y. J. (2001). Real-time Implementation of Adjusted Yellow Interval Timing for Traffic Signals Based on Pavement Friction Factors. Accessed 1/8/2006 at <http://www.koti.re.kr/icons/ehomedata/koti/wctr2001/3347.pdf>.
    - Chang, G-L., Xiang, H. Chou, C-H. (2004). Interrelations Between Crash Rates, Signal Yellow Times, and Vehicles Performance Characteristics. Maryland State Highway Administration Research Report No. MD-04-SP.
    - Perrin, J. Martin, P.T., Hansen, B.G. (2001). Modifying Signal Timing During Inclement Weather. Transportation Research Record 1748. 66-71.
- **Detector Input Analysis Innovation**
    - Chan,C, Marco, D. (2004). Traffic Monitoring at Signal-Controlled Intersections and Data Mining for Safety Applications. Proceedings of the 2004 IEEE Intelligent Transportation System Conference in Washington D.C., October 2004.

- Huang, X.P., Pant, P.D. (1994). Simulation-Neural Network Model for Evaluating Dilemma Zone Problems at High-Speed Signalized Intersections. Transportation Research Record 1456.
- Cheu, R.L., Lee, D.H., Xie, C. (2001). An Arterial Speed Estimation Model Fusing Data from Stationary and Mobile Sensors. Proceedings of Intelligent Transportation Systems.

## **2.9 Summary and Conclusions**

This literature review has examined prior investigations of enhanced safety and performance at high-speed rural signalized intersections. The team has used those reports to develop suggestions that NCDOT might want to explore to improve its present design and operational practices. The main emphasis is on detector placement and signal control since those options are inter-related. It touches on signage and intersection geometry as well, but to a much smaller degree.

The study by Bonneson *et al.*, (2002) is a good reflection of the state-of-the-art. That study examined four detection schemes that were in common use and then experimented with a new idea called the “detection-control system” or D-CS. The conclusion was that this new idea outperformed the other, more common strategies. The D-CS system was described as

a pair of inductive loop detectors ... placed in each major road traffic lane at least 700 ft upstream of the intersection in a speed-trap configuration. As a vehicle passes over these loops, the detection information is fed into a classifier that determines the vehicle's speed and length. Using this information, the detection-control algorithm, operating within a computer at the intersection, calculates when that vehicle will be in its 'dilemma zone' on the intersection approach. It then prevents the phase from ending when one or more vehicles are in the dilemma zone....The location of this detection is based on a desire to have the system 'look' into the future of vehicle arrivals to the dilemma zone. The detection-control system searches for a time when each vehicle served by the subject phase is outside of its respective dilemma zone. It uses a dynamic dilemma-zone monitoring process that enables it to safely end the phase and to do so with a relatively short maximum allowable headway. The implications of this operation are that the system will operate with less delay (through shorter phase durations) and with fewer vehicles caught in the dilemma zone than the multiple advance detector system.

Hence, the D-CS strategy was the one selected by the research team for further investigation and experimentation in the project. Besides being very effective, it seems to be compatible with existing NCDOT practice. It uses a 2070 controller, albeit with additional software routines, and it uses a detector configuration that is slightly different from current NCDOT practice. There are various ways to implement the control, ranging from development of home-grown solutions to the purchase of pre-equipped controllers.

### **3. CURRENT DESIGN PRACTICE**

Compared with other states, maybe except Texas, NCDOT seems to be among the most thorough in describing how it designs high-speed rural intersections. This chapter reviews the practice of NCDOT, several other states, and the guidance provided by FHWA.

In spite of the clarity NCDOT already provides, it still might be useful for NCDOT to more thoroughly document the way in which it installs long vehicle detectors. While the example intersections made it pretty clear what is expected, the study team could not find guidance for those installations in the design documents reviewed. It also looks like there is some variation in the practice, and documenting those variations might be useful, before it gets lost, so that current and future designers can see what ideas have been explored.

#### **3.1 Three Typical Intersections - NCDOT**

The design of each high-speed signalized rural intersection involves at least three aspects: detector placement, signal timing, and geometry. This report focuses on the first two aspects. Standard 4 in the NCDOT design manual provides guidance for detector placement and Standard 5 covers signal timing.

The intersection of US 70 and SR-1913 (Wilson's Mills Road) provides one illustration of NCDOT practice. The original detector layout for this site is shown in Figure 3.1. There were 6-foot by 6-foot (6' x 6') pulse detectors in the through lanes of the main street set back 420' from the stop bar. They placed calls for phases 2 and 6 ( $\Phi 2$  and  $\Phi 6$ ), increased their respective minimum greens, and extended the green when deemed necessary.

Further upstream, between 975' and 1,003', there was a speed trap which held the green so that long vehicles and/or high-speed vehicles would not be trapped in a dilemma zone. Finally, there were 6' x 60' presence detectors in the main street left-turn bays that placed calls and held the green. Similarly, on the side street approaches, there were 6' x 60' presence detectors that placed calls and held the green.

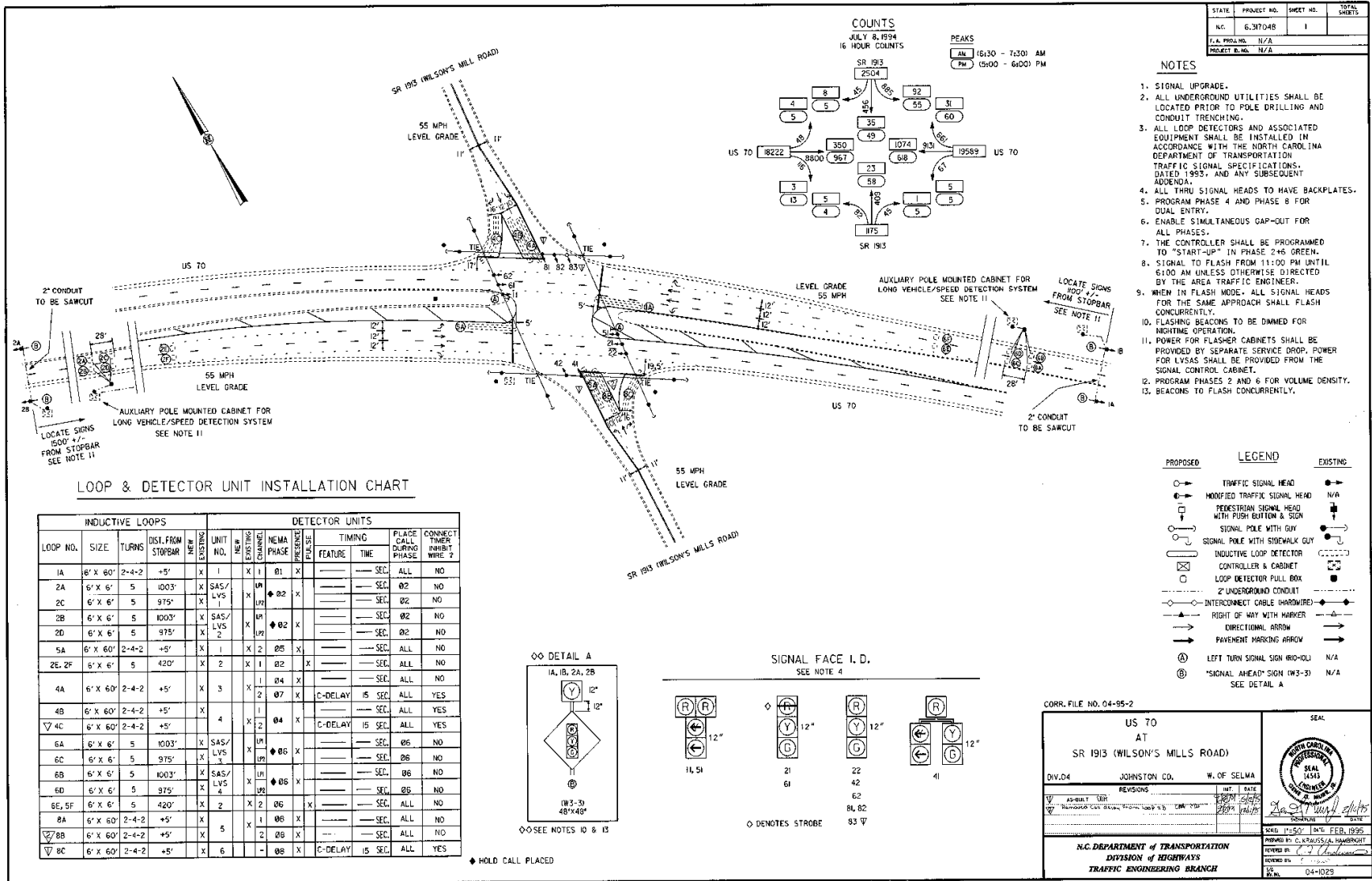


Figure 3.1 Original Detector Configuration - US 70 at SR 1913 (Wilson's Mills Road)

Source: S/G Inv. No. 04-1029, dated 2/16/95, updated 6/12/95 and 12/11/95.

The corresponding, original Series 170 controller timing chart is shown in Table 3.1. For  $\Phi 2$  and  $\Phi 6$ , the minimum green was 20 seconds; the increment per actuation (during red) was 1.5 seconds; and the maximum initial green was 46 seconds. The time before reduction was 20 seconds; the time to reduce was 30 seconds; the maximum gap was 8 seconds; and the minimum gap was 3.5 seconds. The threshold Signal Ahead Sign / Long Vehicle Speed (SAS/LVS) value was 417 milliseconds, which is equivalent to the time required to pass from the first loop to the second at 45 miles per hour (mph) and the threshold stretch SAS/LVS value was 13 seconds. The maximum green was 120 seconds.

**Table 3.1 Timing Chart - US 70 at SR 1913 (Wilson's Mills Road)**

TIMING CHART

PHASE	$\Phi 1$	$\Phi 2$	$\Phi 4$	$\Phi 5$	$\Phi 6$	$\Phi 7$	$\Phi 8$
MINIMUM GREEN	7 SEC.	20 SEC.	7 SEC.	7 SEC.	20 SEC.	7 SEC.	7 SEC.
PASSAGE/GAP	2 SEC.	8 SEC.	∇ 4 SEC.	2 SEC.	8 SEC.	∇ 4 SEC.	∇ 4 SEC.
YELLOW CHANGE INT.	4.0 SEC.	5.1 SEC.	5.2 SEC.	4.1 SEC.	5.1 SEC.	5.0 SEC.	5.2 SEC.
RED CLEARANCE	2.0 SEC.	2.0 SEC.	2.0 SEC.	2.0 SEC.	2.0 SEC.	2.0 SEC.	2.0 SEC.
MAX. 1	15 SEC.	∇ 120 SEC.	25 SEC.	15 SEC.	∇ 120 SEC.	20 SEC.	25 SEC.
MAX. 2	— SEC.	— SEC.	— SEC.	— SEC.	— SEC.	— SEC.	— SEC.
RECALL POSITION	NONE	MIN. RECALL	NONE	NONE	MIN. RECALL	NONE	NONE
VEH. CALL MEMORY	NONLOCK	LOCK	NONLOCK	NONLOCK	LOCK	NONLOCK	NONLOCK
VOLUME DENSITY	NO	YES	NO	NO	YES	NO	NO
ACTUATION B4 ADD	VEH.	0 VEH.	VEH.	VEH.	0 VEH.	VEH.	VEH.
SEC. PER ACTUATION	SEC.	1.5 SEC.	SEC.	SEC.	1.5 SEC.	SEC.	SEC.
MAX. INITIAL	SEC.	∇ 46 SEC.	SEC.	SEC.	∇ 46 SEC.	SEC.	SEC.
TIME B4 REDUCTION	SEC.	∇ 20 SEC.	SEC.	SEC.	∇ 20 SEC.	SEC.	SEC.
TIME TO REDUCE	SEC.	∇ 30 SEC.	SEC.	SEC.	∇ 30 SEC.	SEC.	SEC.
MINIMUM GAP	SEC.	3.5 SEC.	SEC.	SEC.	3.5 SEC.	SEC.	SEC.
THRESHOLD SAS/LVS MILLISECONDS (45 MPH)	—	417	—	—	417	—	—
THRESHOLD STRETCH SAS/LVS - SECONDS	—	13	—	—	13	—	—

Source: S/G Inv. No. 04-1029, dated 2/16/95, updated 6/12/95 and 12/11/95

The implication of these timings is that if the SAS/LVS detector saw vehicles that took less than 417 milliseconds to pass from the first detector to the second in the speed trap, the green was extended by 13 seconds, an estimate of the length of time for a vehicle moving at about 55 mph to travel the roughly 1,000' from the SAS/LVS detector to and through the intersection.

In April 2000, the signal installation was revised. The speed traps were taken out-of-service and replaced by signs that say "Signal Ahead" accompanied by flashing beacons. Apparently, the SAS/LVS detectors were not adding significant value, and they may not have been cost-effective to maintain. Figure 3.2 shows the new configuration.



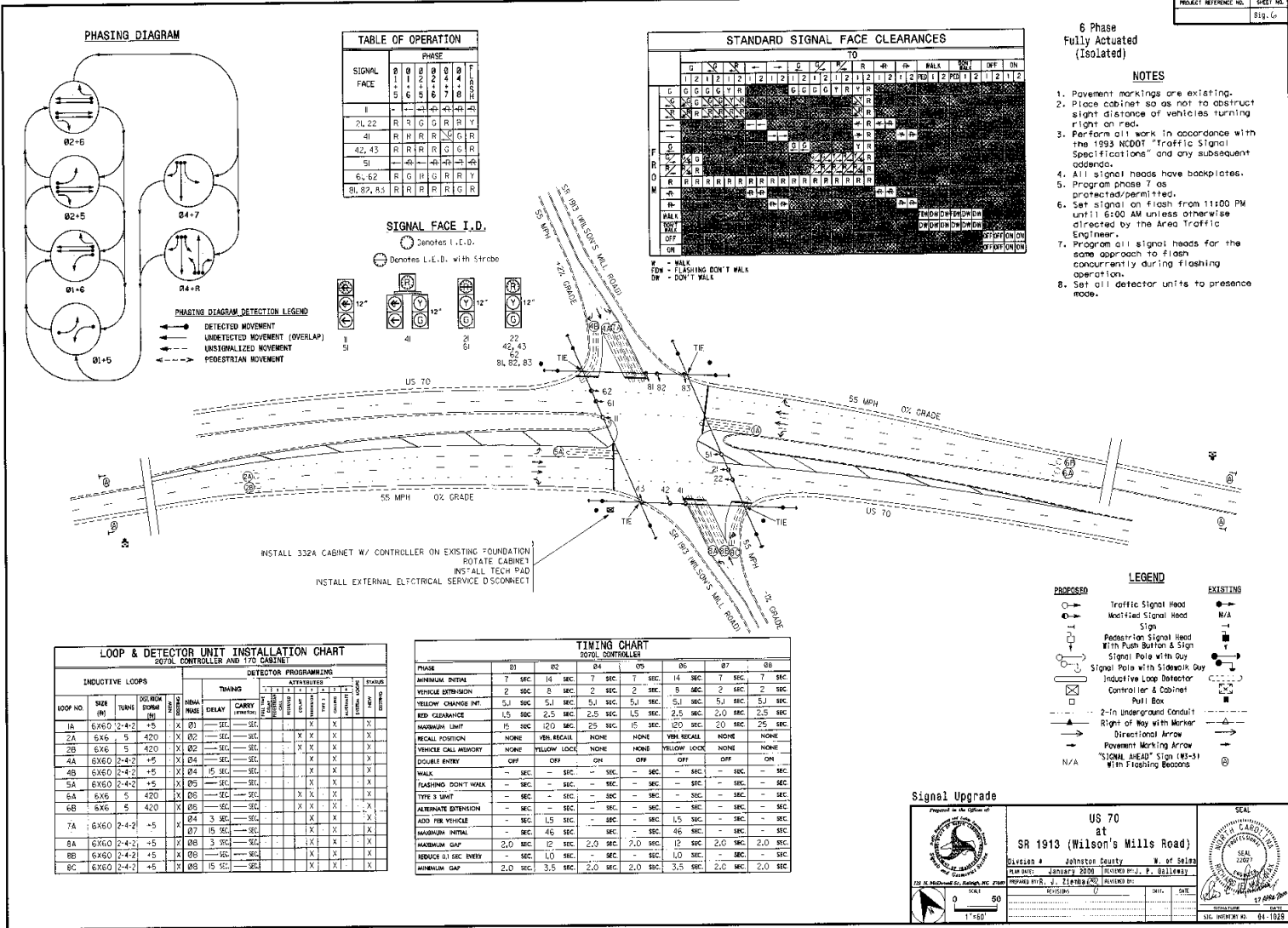


Figure 3.2 Revised US 70 at SR 1913 (Wilson's Mills Road)

Source: S/G Inv. No. 04-1029, dated 4/27/2000

The revised 2070L controller signal timings are shown in Table 3.2. The minimum green is now 14 seconds; 1.5 seconds is added for each actuation during red; the maximum initial green is 46 seconds. The volume-density control has been revised. The maximum gap is now 12 seconds, and it reduces by 0.1 seconds every 1.0 seconds until a minimum gap of 3.5 seconds is reached. The maximum green is still 120 seconds. Discussions in the field provided a sense that the long vehicle protection was not providing a significant enhancement in the safety of the intersection, so it was removed and replaced with the flashing beacons.

**Table 3.2 Revised Timing Chart**

TIMING CHART 2070L CONTROLLER							
PHASE	Ø1	Ø2	Ø4	Ø5	Ø6	Ø7	Ø8
MINIMUM INITIAL	7 SEC.	14 SEC.	7 SEC.	7 SEC.	14 SEC.	7 SEC.	7 SEC.
VEHICLE EXTENSION	2 SEC.	8 SEC.	2 SEC.	2 SEC.	8 SEC.	2 SEC.	2 SEC.
YELLOW CHANGE INT.	5.1 SEC.	5.1 SEC.	5.1 SEC.	5.1 SEC.	5.1 SEC.	5.1 SEC.	5.1 SEC.
RED CLEARANCE	1.5 SEC.	2.5 SEC.	2.5 SEC.	1.5 SEC.	2.5 SEC.	2.0 SEC.	2.5 SEC.
MAXIMUM LIMIT	15 SEC.	120 SEC.	25 SEC.	15 SEC.	120 SEC.	20 SEC.	25 SEC.
RECALL POSITION	NONE	VEH. RECALL	NONE	NONE	VEH. RECALL	NONE	NONE
VEHICLE CALL MEMORY	NONE	YELLOW LOCK	NONE	NONE	YELLOW LOCK	NONE	NONE
DOUBLE ENTRY	OFF	OFF	ON	OFF	OFF	OFF	ON
WALK	- SEC.	- SEC.	- SEC.	- SEC.	- SEC.	- SEC.	- SEC.
FLASHING DON'T WALK	- SEC.	- SEC.	- SEC.	- SEC.	- SEC.	- SEC.	- SEC.
TYPE 3 LIMIT	- SEC.	- SEC.	- SEC.	- SEC.	- SEC.	- SEC.	- SEC.
ALTERNATE EXTENSION	- SEC.	- SEC.	- SEC.	- SEC.	- SEC.	- SEC.	- SEC.
ADD PER VEHICLE	- SEC.	1.5 SEC.	- SEC.	- SEC.	1.5 SEC.	- SEC.	- SEC.
MAXIMUM INITIAL	- SEC.	46 SEC.	- SEC.	- SEC.	46 SEC.	- SEC.	- SEC.
MAXIMUM GAP	2.0 SEC.	12 SEC.	2.0 SEC.	2.0 SEC.	12 SEC.	2.0 SEC.	2.0 SEC.
REDUCE 0.1 SEC EVERY	- SEC.	1.0 SEC.	- SEC.	- SEC.	1.0 SEC.	- SEC.	- SEC.
MINIMUM GAP	2.0 SEC.	3.5 SEC.	2.0 SEC.	2.0 SEC.	3.5 SEC.	2.0 SEC.	2.0 SEC.

Source: S/G Inv. No. 04-1029, dated 4/27/2000

Figure 3.3 shows a second intersection where a signal was installed earlier this year. This is a typical high-speed configuration when long vehicle detection is not employed. There are 6' x 6' loops (2A, 2B, 6A, 6B) in each main street lane 420' upstream of the stop bar. They call their respective phases (2 or 6 as appropriate) and extend the green. There are 6' x 40' presence loops on the main street left turn lanes (1A, 5A) and 6' x 40' and 6' x 20' presence loops on the minor street approach (4A, 4B, north side) and driveway (3A, 3B, south side). Detector 3B is located in the inbound lane because exiting trucks swing wide to make the right turn onto US 70 eastbound.

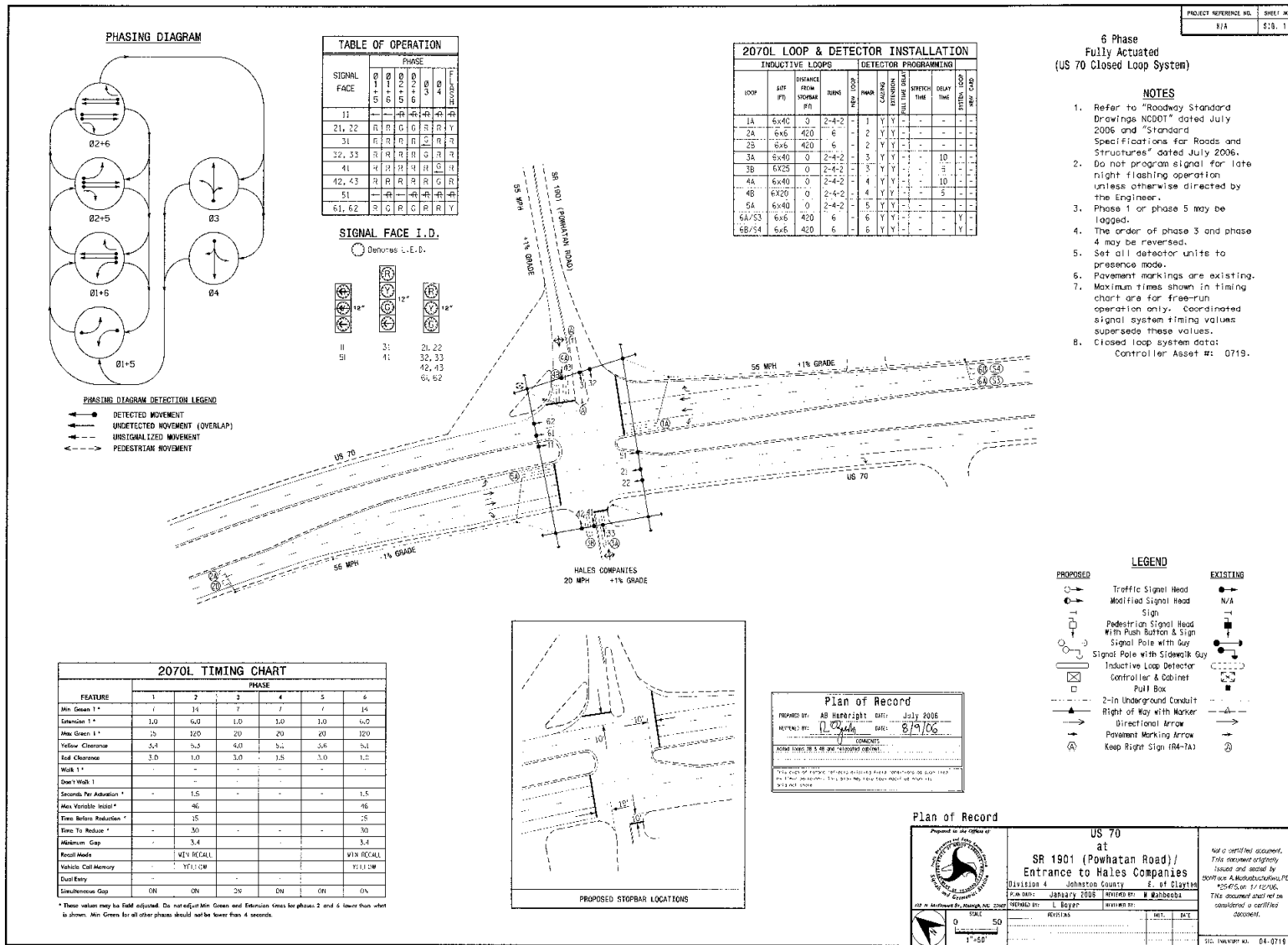


Figure 3.3

US 70 at SR 1901 (Powhatan Road)

Source: S/G Inv. No. 04-0719 dated 1/12/2006

The 2070L controller signal timings for the intersection are shown in Table 3.3. The minimum green for  $\Phi 2$  and  $\Phi 6$  is 14 seconds; the additional initial per actuation is 1.5 seconds; and the maximum variable initial is 46 seconds. The initial value for the green extension is 6.0 seconds; the time before reduction is 5 seconds; the time to reduce is 30 seconds; and the minimum gap is 3.4 seconds. The maximum green is 120 seconds.

**Table 3.3 Signal Timing for US 70 and SR-1901 (Powhatan Road)**

2070L TIMING CHART						
FEATURE	PHASE					
	1	2	3	4	5	6
Min Green 1 *	7	14	7	7	7	14
Extension 1 *	1.0	6.0	1.0	1.0	1.0	6.0
Max Green 1 *	15	120	20	20	20	120
Yellow Clearance	3.4	5.3	4.0	5.1	3.6	5.1
Red Clearance	3.0	1.0	3.0	1.5	3.0	1.0
Walk 1 *	-	-	-	-	-	-
Don't Walk 1	-	-	-	-	-	-
Seconds Per Actuation *	-	1.5	-	-	-	1.5
Max Variable Initial *	-	46	-	-	-	46
Time Before Reduction *	-	15	-	-	-	15
Time To Reduce *	-	30	-	-	-	30
Minimum Gap	-	3.4	-	-	-	3.4
Recall Mode	-	MIN RECALL	-	-	-	MIN RECALL
Vehicle Call Memory	-	YELLOW	-	-	-	YELLOW
Dual Entry	-	-	-	-	-	-
Simultaneous Gap	ON	ON	ON	ON	ON	ON

\* These values may be field adjusted. Do not adjust Min Green and Extension times for phases 2 and 6 lower than what is shown. Min Green for all other phases should not be lower than 4 seconds.

Table 3.4 provides a summary of the characteristics of these and several other intersections for which the detector and signal data have been provided by NCDOT. The similarities and differences are clear. The primary set-back distance is almost always 420'. There are two signals where it is 405', one where it is much further at 850', and three where it is much closer (128', 130', and 295' respectively). In three instances, there is a second set of detectors 110' from the stop bar. Long vehicle protection is sometimes provided and when it is, the detectors are placed at 999' and 1,015' from the stop bar and the LVD time is set for 55 mph and 12 seconds of green extension. In all but one instance, there is a median; in five cases the main street left turns are protected/permissive; and in six instances the signals are put on flash from 11 p.m. to 5 a.m. In five instances there are significant grades. Also, if the signal timing plans are examined (not shown in the table), there is a focus on volume-density operation.

**Table 3.4 Characteristics of Several High-Speed Intersections**

Table 5: Characteristics of Several High Speed Intersections

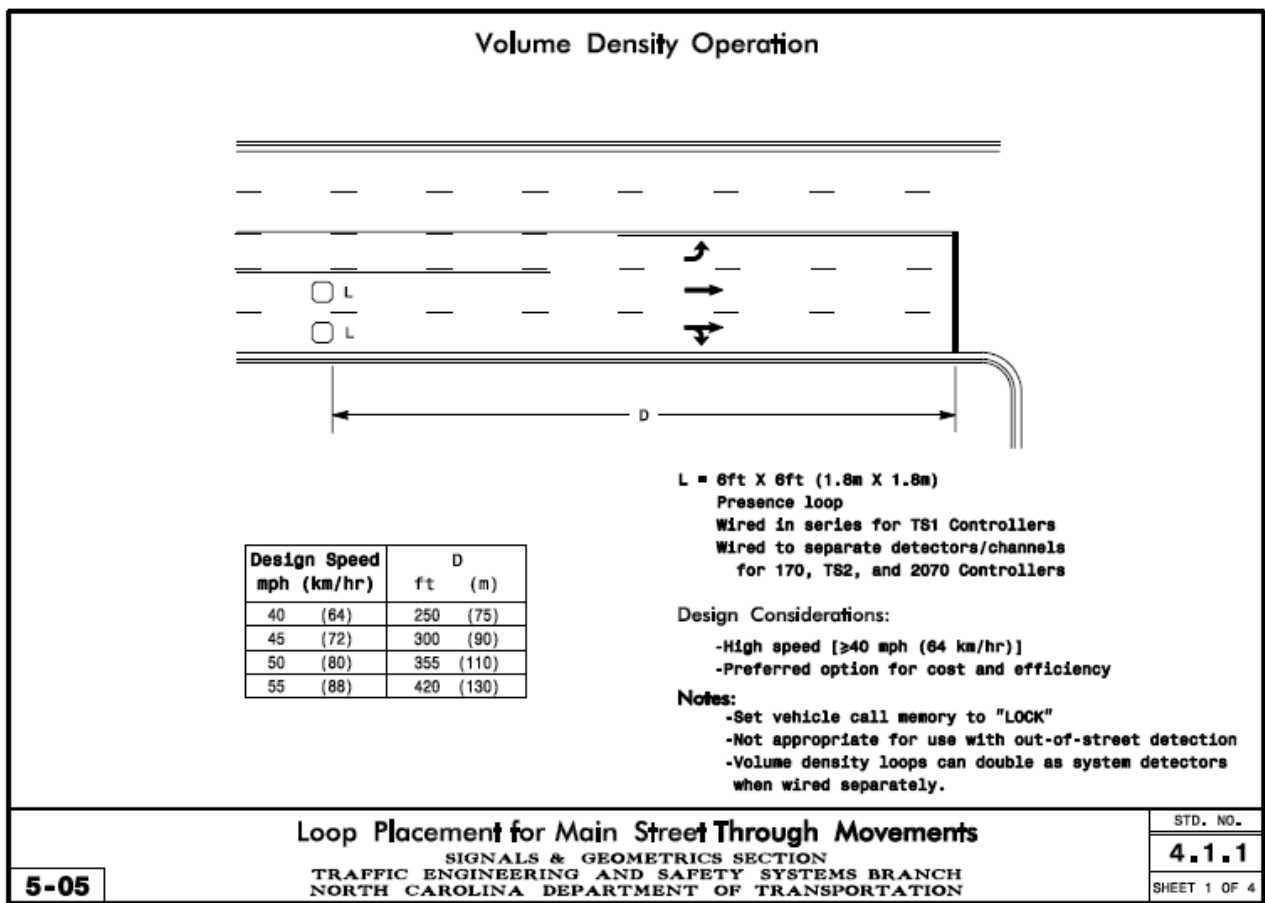
Site	# App	Setback		LVD Time	Grade	Flash	Prot/Perm	Median	Study	Reason to Study
		Pri	LVD							
US-70 @ US-70Bus & SR-2308	4	420	-	-	X	X	-	X	X	420' detectors with grades
US-70 @ SR-1913	4	420	was	-	-	X	-	X	X	Nearby Raleigh; had LVD
US-117 @ SR-1120	4	420	999/1015%	55/12	-	-	-	X	X	LVD and flash
US-52 Bpass @ US-52Bus & SR-2011	4	420	-	-	-	-	X	X	X	420' with Prot/Perm without LVD
US-421 @ US-221	3	130	-	-	X	-	X	X		
US-221/421 @ Old US-421	4	128	-	-	X	-	X	X	X	Short setback for loops
US-17 @ US-158/SR-1416	4	405	999/1015	55/12	-	X	-	X		
US-17/158 @ SR-1339/1416	4	420	999/1015	55/12	-	X	-	X		
US-17/158 @ SR-1333	4	420	999/1015	55/12	-	-	X	X	X	LVD with Prot/Perm
NC-17 @ NC-45	4	295	-	-	-	-	X	-	X	No median
US-17/NC-37 @ SR-1300	4	850/110	-	-	-	X	-	X	X	850' setback with 110' 2nd detectors
US-17 Bpass @ SR-1336	4	405/110*	-	-	-	-	-	X	X	Detectors straddle two lanes
US-17 @ SR-1144	4	405/110	was	-	-	-	-	X	X	110' detectors with prior LVD
US-70 @ SR-2309	4	420	-	-	-	X	-	X		
US-70 @ SR-1901	3+	420	-	-	-	-	-	X		
US-70 @ SR-1570	3+	420	-	-	X	-	-	X		Local; 420' without flash
US-70 @ SR-1501	4	420	999/1015	55/12	X	-	-	X		

Notes

- + Driveway on fourth leg
- \* Detectors straddle both lanes
- % with flashing beacon

### 3.2 NCDOT Design Manual

The NCDOT design manual (North Carolina DOT, 2005) provides guidance about both detector placement and signal timing. For example, Figure 3.4 shows the expected layout of main street detectors for volume density operation according to Standard 4.1.1, Sheet 1 of 4. One detector is to be placed in each lane, set back 250'-420' from the stop bar depending on the design speed on the approach. This layout is intended for "high speed" situations, where the design speed is 40 mph or greater. The loop is a presence loop with vehicle call memory set to "LOCK". The additional sheets, which are not repeated here, provide specifications for *delayed call/extended call* where there are 6' x 40' presence detectors at the stop bar, and *extended (stretch) detection* where there is a second detector in each lane, much closer to the stop bar and an extend time calculation dependent on the spacing between the detectors.



**Figure 3.4 Expected Loop Placement for Main Street Through Movements**

Source: NCDOT 2005

Figures 3.5 and 3.6 show the 2070L controller timing chart annotated with guidance about how to set the timing values.

It is important to note that the design guides do not seem to discuss the placement of long vehicle detectors nor the signal timings for them. This might be an enhancement that NCDOT should

consider making to the design manual. A contribution of this present research project could be that material.

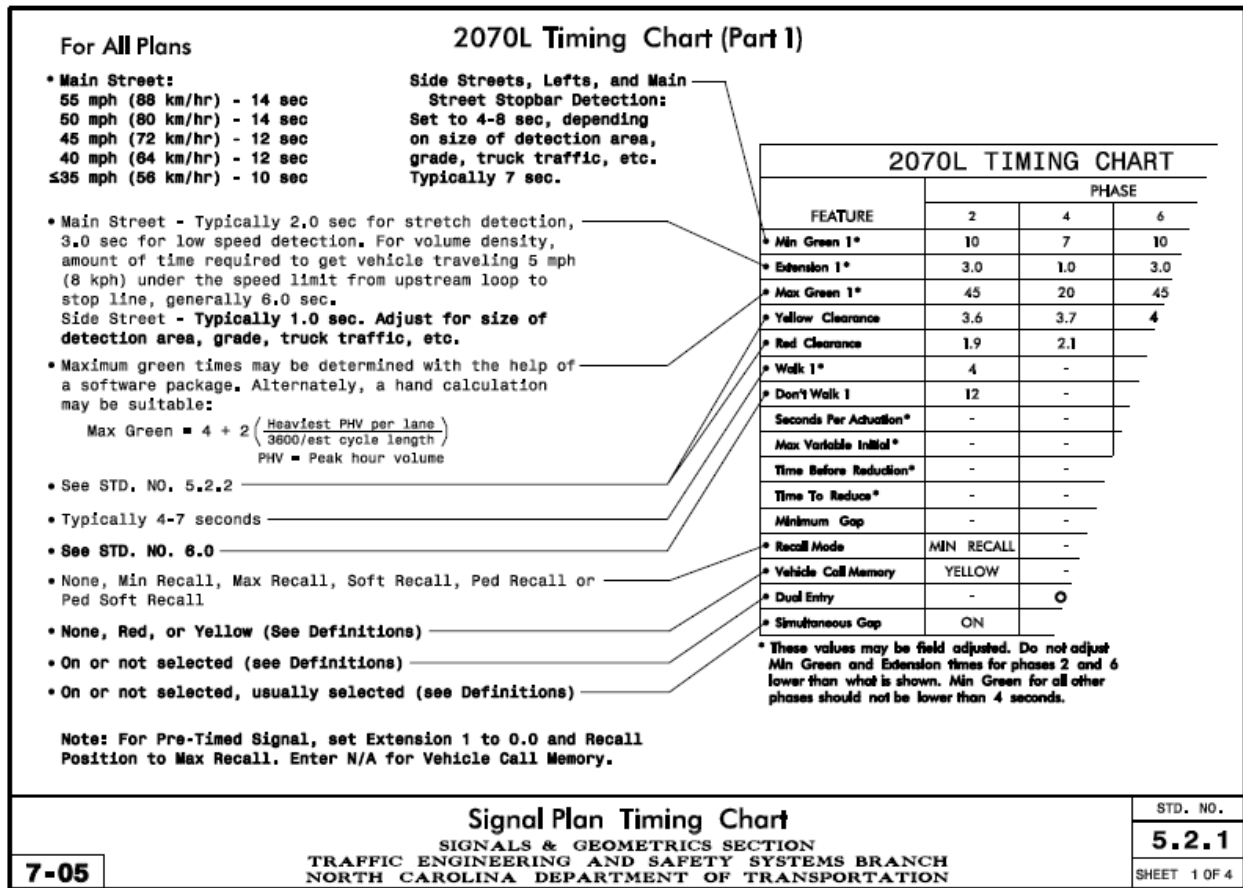
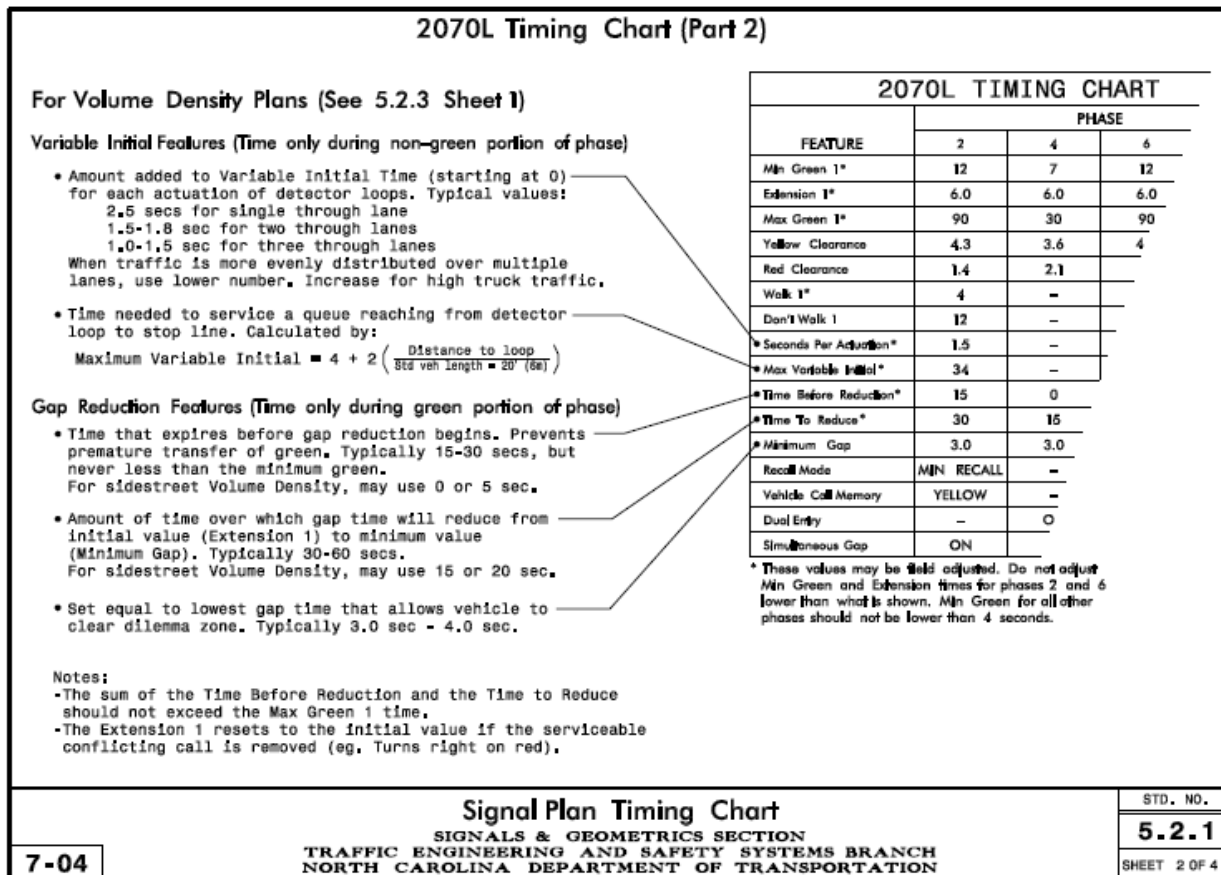


Figure 3.5 2070L Annotated Timing Chart (Sheet 1 of 2)

Source: NCDOT 2005



**Figure 3.6 2070L Annotated Timing Chart (Sheet 2 of 2)**

Source: NCDOT 2005

A dialog with NCDOT in that regard has produced insights that help clarify the practice. Two main documents have been employed in developing the current practice. Those are FHWA (1990) and AASHTO (2004).

Specifically, Table 23 in the AASHTO (2004) guide was used to develop loop placements at locations where high-speed approaches had high volumes of truck traffic (sometimes going above the posted speed limit). The average between the *worst-performance driver* and *best-performance driver* columns was used to compute an average stopping distance for placement of the extended loops (which were then included as part of the design in addition to the normal loops) to help account for the dilemma zone decisions. For design speeds not listed in the table, interpolation was used to develop additional values. In some designs, not only were loops added to account for the long vehicles traveling above the posted speed limit, but the normal loop placements were adjusted to help afford the same dilemma zone protection to passenger vehicles going the normal speed limit and/or lower speeds.

Where there are discrepancies and/or variations between the loop placements in Table 3.4, NCDOT indicates that they are possibly attributable to differences in opinion among the design engineers, especially since these designs tended to be experimental in nature, and typically are based on the best judgment of the particular engineer involved.



Besides detector placement and green time control, four other signal timing details can have an effect on the operation of high-speed intersections: the yellow time, the all-red time, the use of protected main street left turns versus protected/permitted lefts, and the use of advance warning signals. Not repeated here is Standard 5.2.2, as modified by the July 15, 2005 memorandum from G.A. Fuller, PE, which specifies how vehicle clearance interval times are to be set.

### 3.3 Federal Highway Administration

In 1990, FHWA issued the second edition of the Traffic Detector Handbook (Kell, Fullerton, and Mills, 1990). It provided general guidance about where detectors should be placed and how they should be used, at intersections, isolated and in networks, and in freeway systems.

For example, the Handbook says:

extended call detectors could be used on high-speed approaches to an intersection operated by a basic (non-volume-density) actuated controller. Using this technique, the apparent zone of detection is extended, and a different 'gap' and 'passage' time can be created without the volume-density controls (this does not, however, replace volume-density functions). The Delay/Extension Enable Input on a solid-state output detector could be tied to the controller's "Phase On" output....

In a later section it is stated,

Some schemes for high-speed intersections use conventional loops or magnetometer detectors with normal output. Other designs use detector units that "stretch" or hold the call of the vehicle after it leaves the detection zone (Extended Call Detectors). Still another design incorporates detectors that delay an output until the detection zone has been occupied for a preset period of time (Delayed Call Detectors).

A later figure shows the location of the dilemma zone as stretching from 284' to 122' from the stop bar at 40 mph. Other distances are shown in a table, repeated here as Table 3.5. At 55 mph the 90% distance is 386' compared with the 420' that NCDOT uses for detector placement, and the 10% distance is 234'.

**Table 3.5 FHWA Recommended Dilemma Zones**

Approach Speed		Distances from Intersection for Probabilities of Stopping			
		Feet		Meters	
mph	kph	90 %	10 %	90 %	10 %
35	56	254	102	77	31
40	64	284	122	87	37
45	72	327	152	100	46
50	80	353	172	108	52
55	88	386	234	118	71

Source: Kell, Fullerton, and Mills (1990)

The manual continues by saying,

the most straightforward conventional design for a high-speed approach uses a controller with a volume-density mode. This type of actuated operation can count waiting vehicles beyond the first one because of the 'added initial' feature. It also has a timing adjustment to reduce the allowable gap based on the time vehicles have waited on the red of a conflicting phase.

It then says:

for isolated high-speed rural intersections, an extinguishable message sign, 'PREPARE TO STOP,' is frequently used when the signal site experiences

periods of poor visibility caused by dense ground fog or by the orientation of the sun. These signs are also used where the geometry is such that the signal is not visible far enough in advance to ensure safety. For this situation, vehicle detectors are located further in advance of the intersection than normal.

It continues:

using the “last car passage” feature of some density controllers, the gap in the traffic flow can be identified to allow the last car in the platoon to go through the signal and presumably give the next vehicle sufficient time to stop. The sign ... would flash ‘Prepare to Stop’ at the appropriate time, but would be blank or unreadable at other times. Essentially, the controller picks up a gap in the traffic, but does not change the signal until a preset time has elapsed to allow the last car to clear the intersection. The ‘Prepare to Stop’ is illuminated when the gap is selected, so that the next vehicle following the platoon will see the sign. Thus, the driver will know he would be required to stop even though the signal ahead is still green.... A simple display is used by some jurisdictions. They use flashing beacons together with a diamond or rectangular sign with the message “PREPARE TO STOP WHEN FLASHING.”

In a subsequent spot it says:

for high-speed approaches (those with speeds greater than 30 mph (48 kph)), detection becomes more complex. Volume density control is one technique used that relies on the controller functions rather than extensive detectorization. Normally only one detector is used for each lane. This point detector is placed much farther from the intersection than the 2 to 4 seconds of travel time used for normal actuated operation. The detector is usually placed at least 5 seconds and as much as 8 to 10 seconds from the stop line. This detector is active at all times rather than just during the green interval. During the red interval, each actuation increments the variable initial timing period. If the variable initial exceeds the minimum green, each additional actuation adds more time to the initial interval. During the green interval, the detector acts to extend the green. At first the extension is equal to the passage time, but after a conflicting phase has registered a call, the extension is reduced, eventually reaching a minimum gap.

The Manual continues by describing several multi-point detection systems that can be employed to extend the green on high-speed approaches and avoid trapping vehicles in the dilemma zone. The techniques described are: the Bierele Method, the Winston-Salem Method, and the SDITE Method. The document pre-dates Bonneson’s 2002 project.

**3.4 Georgia**

Georgia uses a detector placement strategy that is nearly identical to NCDOT (Georgia DOT, 2003). The main difference is that the setback distances are slightly different as shown in Table 3.6. At 55mph, for example, the recommended set-back distance is 410’ instead of 420’ which is what NCDOT recommends. No additional information is provided about long vehicle, high-speed protection.

The Georgia design manual says:

Loops on high-speed approaches shall be located so as to provide dilemma zone protection. The dilemma zone is an area in which drivers are uncertain of the proper response to a yellow signal indication. By locating the loop at the upstream boundary of the dilemma zone, the passage timer can be reactivated before a vehicle enters the area of uncertainty. The dilemma zone boundaries are defined by a leading edge at five seconds of travel time from the intersection to a trailing edge located at approximately two or three seconds from the intersection. Therefore, a three second passage time would extend the green indication until the driver is beyond the dilemma zone.

Table 4-6 [the current Table 3.6] shows the location of setback detectors for high-speed approaches. If these distances cannot be achieved due to an obstruction such as a bridge, the loops should generally be located further from, rather than closer to the intersection. Appropriate passage timing should be programmed so that the green is extended sufficiently to take drivers from the loop to a distance of two seconds travel time from the intersection. Additional factors that can influence detector placement include sight distance and horizontal and vertical alignment of the roadway.

The design guide is nearly “silent” about signal timing. It simply says:

Model 2070L controllers shall be used for all intersections. Phase assignments should follow the 8-phase diagram described in Section 4.1 to the greatest extent possible. [Normal 8 phase operation]. Exceptions for special situations might include diamond interchange control and complex intersection geometrics. Unused or unnecessary phases shall be omitted.

**3.5 South Carolina**

South Carolina also follows a practice similar to NCDOT (South Carolina DOT, 2006). As shown in Table 3.7, two detectors are expected for 55 mph. The furthest is at 385’ and the closer one is at 255’. Both are lock/ presence. The one furthest back is at 385’ and is supposed to be a 6’ x 6’ loop while the nearer one is at 255’ and is supposed to be a 6’ x 15’ loop. When only the furthest detector is installed, the minimum green is 8 to 15 seconds and the minimum gap is 2.5 seconds. When both detectors are installed, the minimum green stays the same but the passage time becomes 2.3 seconds.

**Table 3.6 Detector Set-Backs**

Speed Limit (mph)	Detector Set-back (ft)
35	260
40	300
45	330
50	370
55	410
60	440
65	480

Source: Georgia DOT (2003)

There is no additional discussion about special detector arrangements for high-speed intersections.

Figure 3.7 shows the expected placement of detectors on the approach to a high-speed intersection where the approach speed is 45 mph or greater. Here, the detector sizes are slightly different than those specified in the table. The one closest to the stop bar is shown as a 6' x 20' detector (2b) while the one further away (2c) is marked as a 6' x 15' detector.

**Table 3.7** Detector Placements for South Carolina

MAJOR ROUTE SPEED LIMIT	DETECTOR SETBACK	PASSAGE TIME	MIN. GAP	MIN GREEN	MAXIMUM INITIAL INTERVAL
35	180' - 250'	3.5 to 4.9 s	2.6 to 3.9 s	*	22 s ** to 29 s
40	230' - 300'	3.9 to 5.1 s	3.1 to 4.3 s	*	27 s ** to 34 s
45	255' & 385' (DZP)	3.8 s	2.3 s	*	30 s **
50	255' & 385' (DZP)	3.5 s	2.3 s	*	30 s **
55	255' & 385' (DZP)	3.1 s	2.3 s	*	30 s **

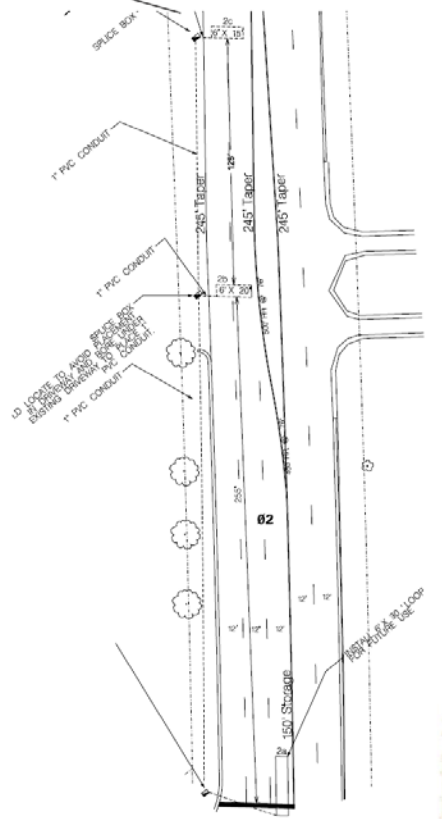
Source: South Carolina DOT (2006)

The signal timing is expected to be 8 seconds minimum initial with 1.1 seconds of additional green for each additional vehicle (South Carolina DOT, 2003). The initial gap is to be 3 seconds with a time before reduction of 15 seconds, a time to reduce of 5 seconds, and a minimum gap of 2.5 seconds.

**SETBACK LOOPS FOR MAINLINE (45 MPH & GREATER)**

Notes:

- If both roadways are high speed and have similar volumes, use setback loops on both roadways.
- Consider using quadrupole loops at signals where motorcycle traffic may be prevalent.
- SCDOT generally uses a 50' setback placement for left turn phases.
- System loops are typically placed on the departure side of the signal, while detection loops are placed on the signal approach.
- See signal specifications for details on number of turns based on size of the loops.
- Loops have a typical range of 3' on either side of the loop, so avoid placing too close to adjacent lane or opposing traffic flow area.



**Figure 3.7** Detector Placement

Source: South Carolina DOT (2006)

### 3.6 California

CalTrans provides general guidance about detector placement as shown in Table 3.8 (California DOT, 2002). The CalTrans design manual presents formulas intended to calculate the distances to the detectors as well as suggested defaults (California DOT, 2006). At 55 mph, 405' is suggested compared to 420' for NCDOT. (As an aside, yellow flashing beacons may be used with a SIGNAL AHEAD warning sign for any traffic signal with an approach speed over 50 mph. There are also formulae for computing yellow and all-red times that are not repeated here.)

The manual provides lots of discussion about pedestrian provisions and emergency response vehicle accommodation, but nothing about the treatment of high-speed approaches.

Chapter 9 of the design manual (California DOT, 2002) discusses signal timing issues and provides general guidance about setting parameters. It is apparent that a standard 8-phase operation is assumed but no timing charts or tables are provided. The words “high speed” or “high-speed” never appear in the document.

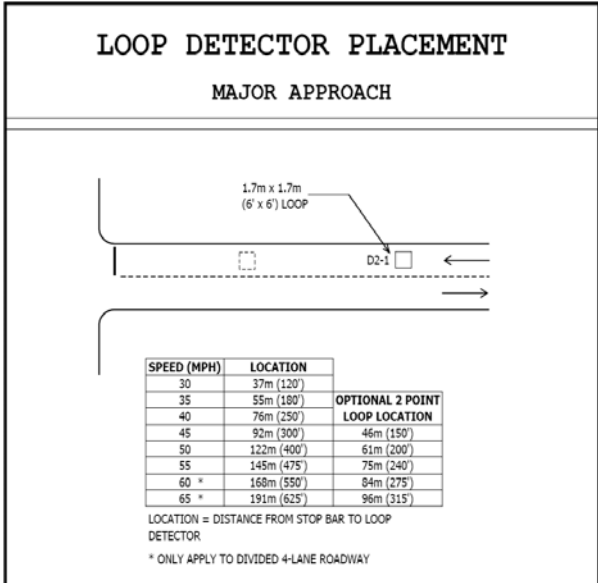
**Table 3.8 CalTrans Design Specifications**

SPEED			DEC. TIME	DEC. DIST.	TOTAL TIME	DETECTOR SETBACKS	
mph	km/h	m/s	Seconds	Meters	Seconds	ACTUAL Meters	SUGGESTED Meters
25	40	11.18	3.67	20.49	4.67	31.67	30
30	48	13.42	4.40	29.51	5.40	42.93	45
35	56	15.65	5.13	40.17	6.13	55.82	55
40	64	17.89	5.87	52.46	6.87	70.35	70
45	72	20.13	6.60	66.40	7.60	86.52	85
50	80	22.36	7.33	81.97	8.33	104.33	105
55	89	24.60	8.06	99.18	9.06	123.78	125
60	97	26.83	8.80	118.04	9.80	144.87	145
65	105	29.07	9.53	138.53	10.53	167.60	170
70	113	31.29	10.27	160.50	11.27	191.79	190

Source: California DOT, 2006, Part 4

### 3.7 Minnesota

Minnesota uses guidelines very similar to NCDOT. Its design manual (Minnesota DOT, 2006) suggests placing one detector in each lane upstream of the stop bar as shown in Figure 3.8. At 55 mph, the furthest detector is to be 475' upstream of the stop bar and the closest is to be at 240' as opposed to 420' and 110' according to NCDOT. The loop detector's function is "call and extend". Free right turns are not detected. The phases are set on vehicle recall. (This may vary with the application situation.) Volume-density is used. Distances are shown for the second detector only for speeds over 45 mph. Stop line detection is suggested as an option to shorten the minimum green time.



**Figure 3.8** Typical Detector Layout - Minnesota

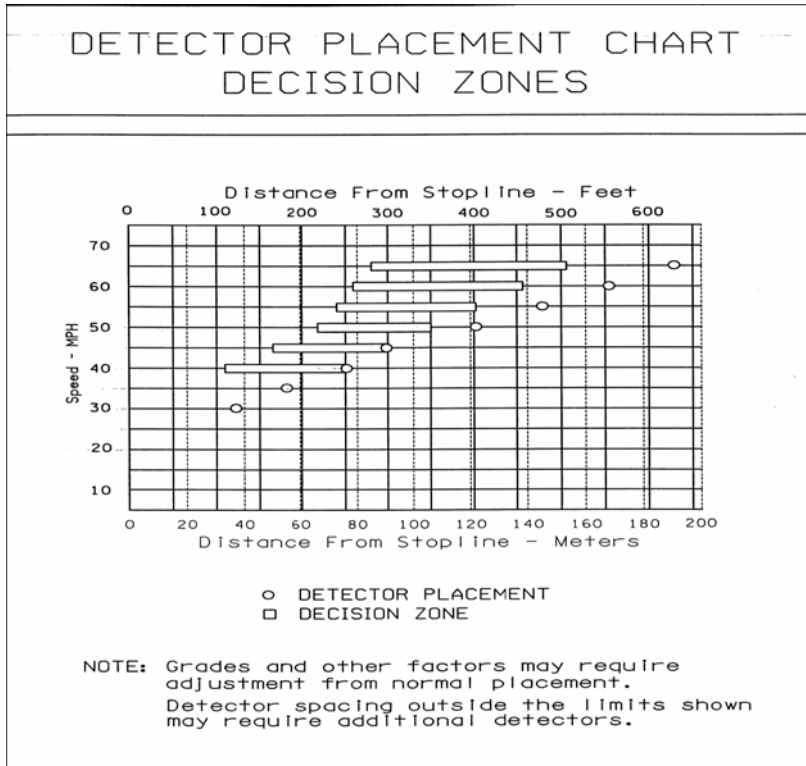
Source: Minnesota DOT (2006)

The detector placements are derived from dilemma zone considerations. The MnDOT design manual actually talks about a "decision zone" instead. As shown in Figure 3.9, MnDOT suggests placing the furthest upstream detector beyond the end of the decision zone. The open rectangles show MnDOT's perception of where the "decision zone" is located.

The signal timing and coordination manual (Minnesota DOT, 2005) contains a paragraph that talks about special application detectors:

Certain off-the-shelf auxiliary detector logic that extends the capabilities of the normal detector/ controller hardware configuration is also available. This equipment employs auxiliary timers and display monitoring circuits. This logic allows the enabling and disabling of selected detectors, control of the yield of green, and the activation of "Hold-in Phase" circuits in order to supplement the logic of the controller.

1. An example is the "green extension system" for the purpose of providing decision-zone protection at a semi-actuated intersection.
2. Another type of detection with auxiliary logic is the "speed analysis system". This system is a hardware assembly composed of two loop detectors and auxiliary logic. The two loops are installed in the same lane a precise distance apart. A vehicle passing over the loops produces two actuations. The time interval between the first and the second actuation is measured to determine if vehicle speed is higher or lower than a pre-set threshold speed.



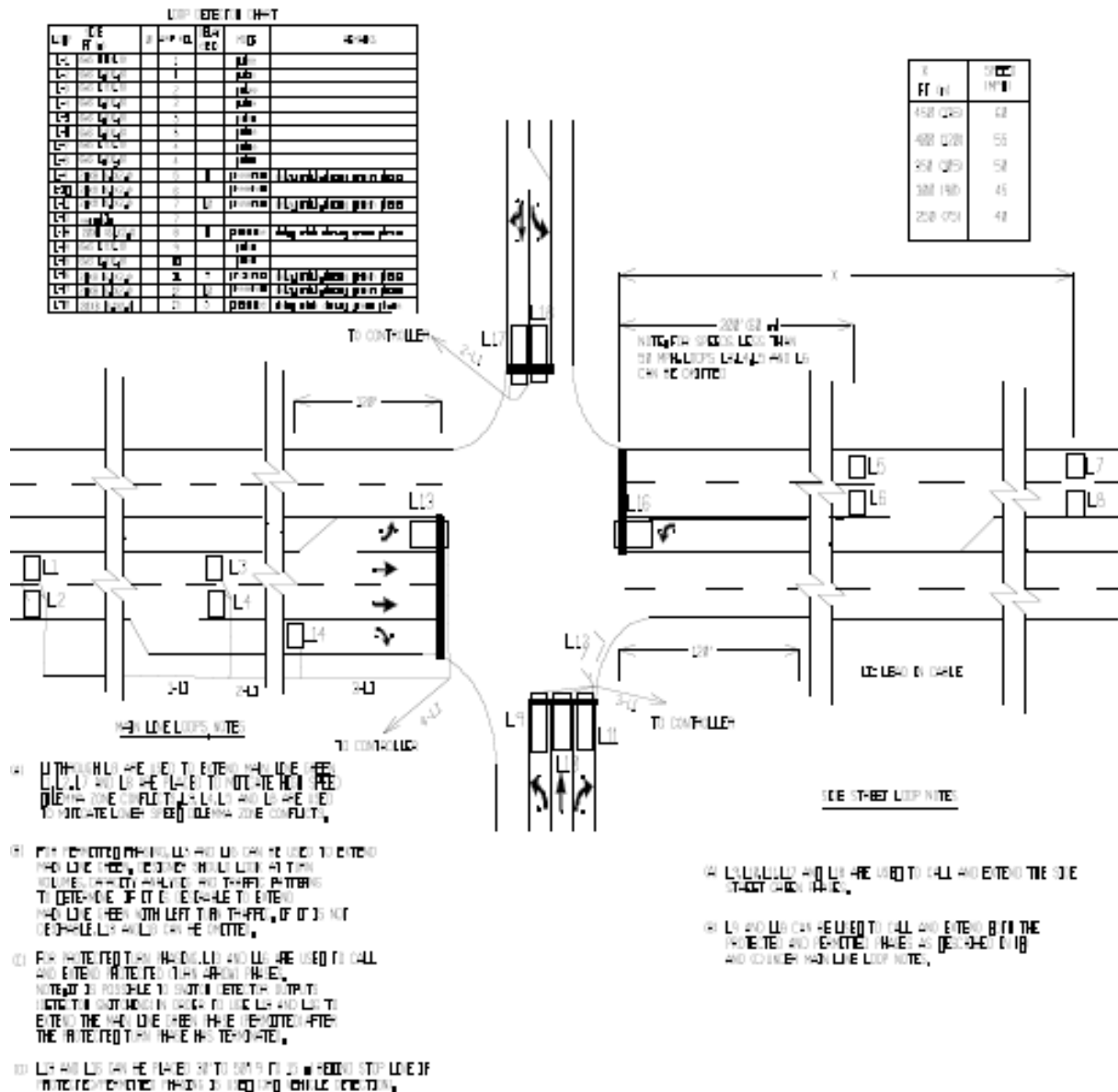
**Figure 3.9 Suggested Detector Placement versus Decision Zone Location**

Source: Minnesota DOT (2005)

So the potential value in providing additional detectors at high-speed intersections seems to be understood.

### 3.8 Ohio

The ODOT design manual talks about detector placement on high-speed approaches in several places. It suggests the detector placements shown in Figure 3.10. (The original is slightly clearer to read.) There are to be 6' x 6' detectors L1, L2, L3, and L4 upstream of the stop bar to call main street green and extend the green for arriving vehicles. In addition, detectors L3 and L4 are to be placed 200' upstream of the stop bar while detectors L1 and L2 are to be placed distance "X" upstream of the stop bar as indicated by Table 3.9. At 55 mph, the recommended distance is 400' compared with 420' recommended by NCDOT. There are several other figures that provide additional guidance about detector placement that are not repeated here.



**Figure 3.10 Detector Placement Recommendations**

Source: Ohio DOT (2007), Figure 498-3

ODOT also suggests installing a “Prepare to Stop when Flashing” sign for locations (usually four-lane divided highways) with high approach speeds (over 45 mph), a high rear-end accident rate, and evidence of rear-end conflicts (skid marks) at the intersection. ODOT also recommends this treatment for remote rural locations with high speeds where the presence of a signal is unexpected and for locations with a high percentage of high-speed truck traffic with frequent violations of the clearance interval and excessive angle and rear-end accidents.



**Table 3.9 Suggested Set-Backs**

X FT (m)	SPEED (MPH)
450 (135)	60
400 (120)	55
350 (105)	50
300 (90)	45
250 (75)	40

Source: Ohio DOT (2007)

### 3.9 Virginia

Virginia follows the FHWA Traffic Detector Handbook (Kell, Fullerton, and Mills, 1990) discussed in Section 3.1. Based on that document, Chapter 4 of Virginia’s design manual (Virginia, 2006) shows expected detector assignments, as shown in Table 3.10 and expected detector placements in Table 3.11.

Signal timing charts and diagrams are provided. Fully-actuated 8-phase operation is assumed to be the normal condition. The standard timing chart calls for volume-density operation information. A supporting chart asks for information about loop designations, placements, and functions.

**Table 3.10 Detector Placement Guidelines - Virginia**

LOOP DATA					
AMP-CHANNEL	LOOP	SIZE	NO. TURN	MODE	NOTES
1-1	Ø(1-1)	6' X 60'	2-4-2	PRESENCE	
1-2					
1-3	Ø(6-1)	6' X 6'	3	PULSE	CONNECT IN PARALLEL IN CONTROLLER CABINET
	Ø(6-2)	6' X 6'	3		
1-4					SPARE
2-1	Ø5.1	6' X 60'	2-4-2	PRESENCE	
2-2	Ø(2-1)	6' X 6'	3	PULSE	CONNECT IN PARALLEL IN CONTROLLER CABINET
	Ø(2-2)	6' X 6'	3		
2-3					SPARE
2-4					SPARE
3-1	Ø3.1	6' X 60'	2	PRESENCE	
3-2	Ø(8-1)		3	PULSE	
3-3	Ø(8-2)		3	PULSE	
3-4					
4-1	Ø7.1	6' X 60'	2	PRESENCE	
4-2	Ø(4-1)	6' X 6'	3	PULSE	
4-3	Ø(4-2)	6' X 6'	3	PULSE	
4-4					

Source: Virginia DOT (2006), Chapter 4

Information about signal timing is provided in Chapter 2 of the design manual. Normal 8-phase fully-actuated operation is assumed. There is one significant comment that permitted lefts should not be allowed at high-speed intersections, only protected lefts should be used.

**Table 3.11 Detector Set-Backs based on Speed Limit**

Speed Limit (mph)	Setback (in ft.) of:	
	1 <sup>st</sup> Detector	2 <sup>nd</sup> Detector
35	255	405
40	285	445
45	330	505
50	355	535
55	390	540

Source: Virginia DOT (2006)

### **3.10 Conclusions and Recommendations**

The research team has described their understanding of the way in which NCDOT creates designs for high-speed rural intersections. Sections 3.1 and 3.2 focused explicitly on NCDOT practice, Section 3.3 gave an overview of FHWA guidelines, and Sections 3.4 to 3.9 provided sketch-level descriptions of the practice of other states.

The process of completing this review made it apparent that there are several design considerations that affect the safety performance of high-speed rural intersections:

- detector placement
- green time controls (extension times, gaps, etc.)
- yellow and all-red times
- advance warning signs

Compared with other states, except maybe Texas, NCDOT seems to be at the forefront of describing how high-speed rural signalized intersections should be designed. That includes both the placement of detectors but almost more importantly, the signal timing to employ.

One recommendation that emerges is that NCDOT ought to consider documenting the way in which it presently perceives long vehicle detectors should be installed. If that practice is in the design documents, the study team could not find it. The example intersections make it clear what is expected, but the design documents do not seem to present that practice. It might also be useful to investigate the practice across the state, to the extent that it varies, perhaps something the research team ought to do, so that best practice is captured and documented before it might be lost.

A final thought is that it ought to be relatively straight-forward to experiment with Bonneson's technique given the installations that have been observed.

## 4. EVALUATION

Evaluations of three detector placement/signal control configurations were carried out both in the field and via simulation for three intersections. Two additional ones were studied via simulation, and field studies would have been conducted had time and resources allowed. This chapter describes the manner in which these simulations and field studies were conducted; and then presents the results obtained for each.

### 4.1 Locations, Configurations, and Performance Measures

The three locations studied were:

- *Swift Creek*: This is an intersection on US 70 about 10 miles east of Raleigh, NC. It was used to test the D-CS control system and to prepare for the field studies at the other two locations. It also served as the “Piedmont” or mid-state test location. The intersection lies at the bottom of a fairly significant vertical curve. The mainline has two through lanes in both directions, divided by a median, plus left-turn bays, and flaring for the right turns. The side street has flared approaches but no left-turn bays. The signal control is volume density supplemented by an NQ4 device (explained below). There are left-turn arrows (protected/permissive) on the mainline.
- *NC 280*: This intersection is about 10 miles south of Asheville, NC. It is in the “mountainous” western part of the state. It lies at the top of a gradual vertical curve and in the middle of a horizontal curve. The mainline has two through lanes in both directions and a two-way left-turn lane that becomes the left-turn bays at the intersection. The side street has flared approaches but no left-turn bays. The volume-density control is two phase.
- *US 17*: This intersection is about 10 miles north of Wilmington, NC. It is in the “coastal” eastern part of the state. It lies at the beginning of a gradual horizontal curve; vertically, it is on the level. The intersection is a T; the side street approach is on the eastern side with a left-turn lane, a shared left/right-turn lane, and a short flared right-turn bay. The mainline has two lanes in each direction, divided by a wide median, plus left-turn bays at the stop bar and a right-turn bay northbound. The volume-density signal control includes a lagging southbound left.

The detector placement/signal control configurations explored were as follows:

- *Base Case*: This is used to designate the existing/initial configuration extant in the field. Except for Swift Creek, it was standard NCDOT detector placements (e.g., detectors in each mainline lane, 420’ upstream of the stop bar) and volume-density control using a 2070 controller and standard NCDOT OASIS software.
- *NQ4*: This is the configuration in which NQ4 Long Vehicle System (LVS) devices are operative on both mainline approaches (one in each direction) as a supplement to the volume-density control. It represents the manner in which NCDOT typically addresses the need for advance detection and high-speed protection. Speed traps, formed from loops about 20’ apart, are placed about 1,000’ upstream of the stop bar in each mainline lane. This enables the NQ4 device to sense the speed and length of each oncoming vehicle. When the NQ4 device identifies “long” vehicles (over 22’) traveling at or above a given

speed threshold (about 55mph), then a lengthy (about 10-second) hold is placed on main street green using a detector input, to ensure that the oncoming vehicle can pass through the intersection without encountering an yellow, even if the maximum green is then violated. This was the base case condition at Swift Creek.

- *D-CS*: This is the configuration in which a Naztec 2070 controller in a Naztec TS-2 cabinet is operating in D-CS mode in conjunction with speed traps in each mainline lane located about 1,000' upstream of the stop bar. In all cases, to implement this configuration, the existing cabinet needed to be swapped out so the Naztec TS-2 cabinet and Naztec 2070 controller could be put in place. At all locations, wireless Sensys detectors were used to create the speed traps at 1,000', working in conjunction with Sensys "repeater units", an "access point", and two Sensys detector cards.

The evaluation metrics that were most intensely studied were:

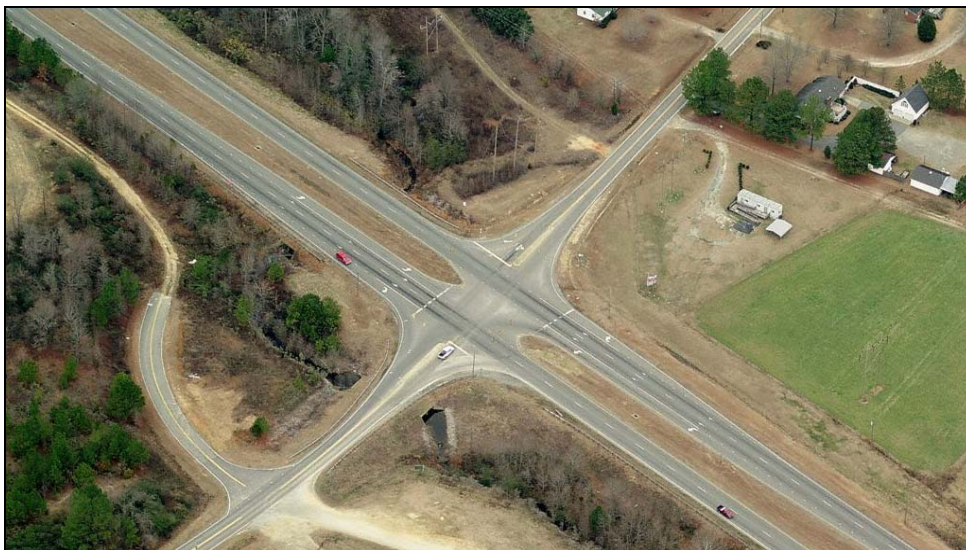
- Probability of  $n$  vehicles being in a dilemma zone at the onset of yellow,  $n = 0, 1, 2, \dots$ ;
- Probability of  $n$  trucks being in a dilemma zone at the onset of yellow,  $n = 0, 1, 2, \dots$ ;
- Probability that  $n$  vehicles violated the red light;
- Average delay per vehicle, overall and by approach; and
- Average cycle length.

In simulation, all three configurations were tested at the five test intersections. The NQ4 and Naztec configurations were tested at Swift Creek and all three were tested at the other two locations. The locations are discussed next, followed by the simulation studies, and then the field studies.

## 4.2 Study Sites

More than thirty sites were considered for study. Five were ultimately selected for detailed analysis and three of these were subsequently chosen for field study.

*Site #1*: Figures 4.1 and 4.2 show the Swift Creek site (NC Signal #04-1217). It is about 10 miles east of Raleigh, NC, near Wilson's Mills.



**Figure 4.1** US 70 and Swift Creek Road, Wilson's Mills, NC (NC Signal #04-1217)

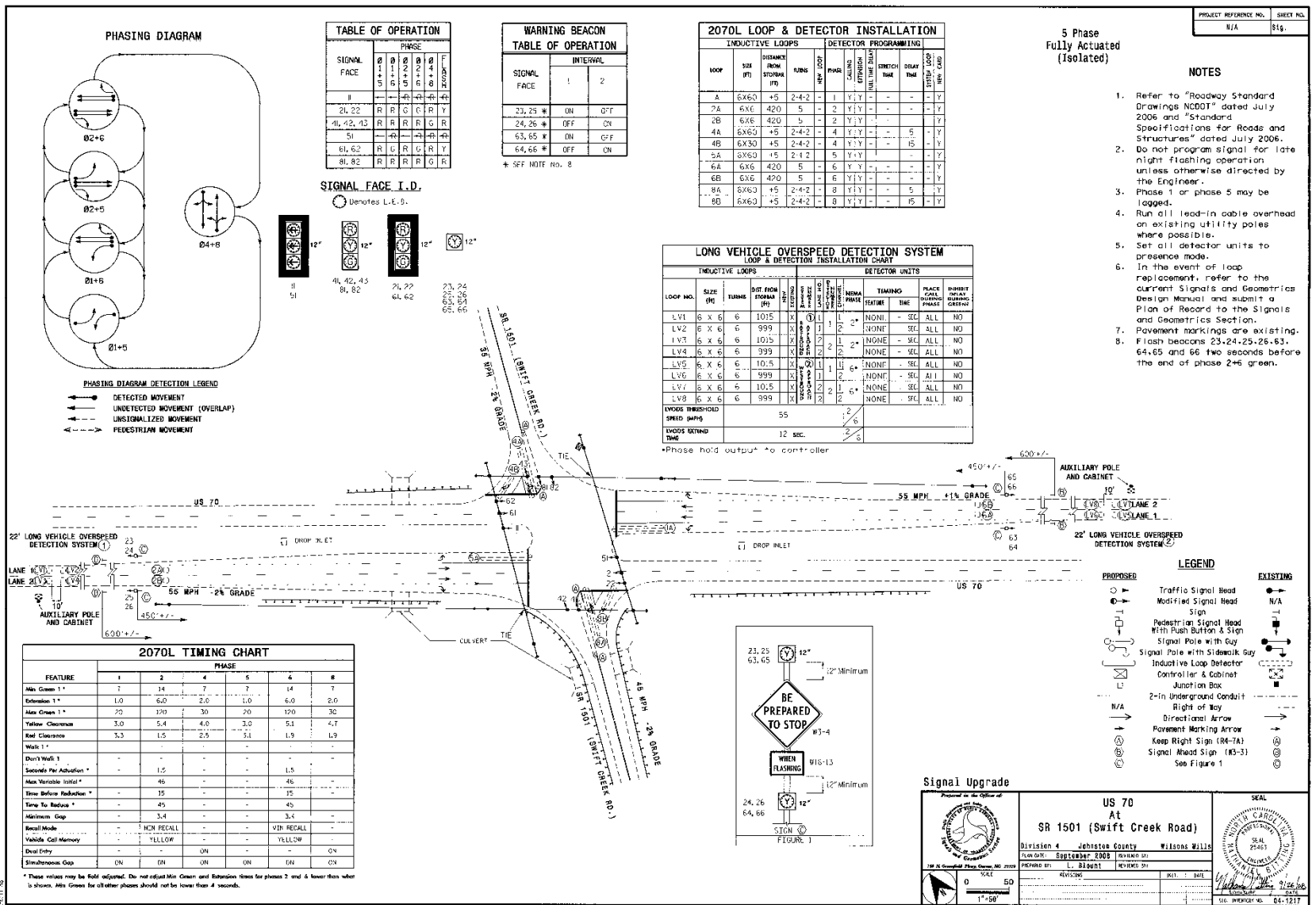


Figure 4.2 Signal Timing Sheet for US 70 and Swift Creek Road, Wilson's Mills, NC (NC Signal #04-1217)

The intersection is at the bottom of a -2% to +1% grade eastbound. The signal control is volume-density with the NQ4 long vehicle overspeed protection system superimposed. Figure 4.3 provides a sense of the intersection topography based on a photo looking eastbound. Truck volumes are high as are the total volumes. The intersection is always busy during the daytime.



**Figure 4.3** US 70 at Swift Creek Road, Wilson's Mills, Looking Eastbound

*Site #2:* The intersection of NC 280 and Ray Hill Road is about 10 miles south of Asheville, NC. Figures 4.4 and 4.5 depict the site. The intersection lies at the crest of a hill and in the middle of a gradual curve. The volume density control is two-phase. The volumes are low and truck traffic is light. Note the complex topography. Both approaches of NC 280 lead uphill to the intersection whereas there is a downslope to the intersection on both side street approaches. This suggests that main street traffic should not commonly incur dilemma zone issues because the uphill approaches to the intersection would aid in deceleration. However, if traffic exits either side street approach quickly, collisions might occur.



**Figure 4.4** NC 280 at Ray Hill Road, Mills River, NC (NC Signal #14-1137)

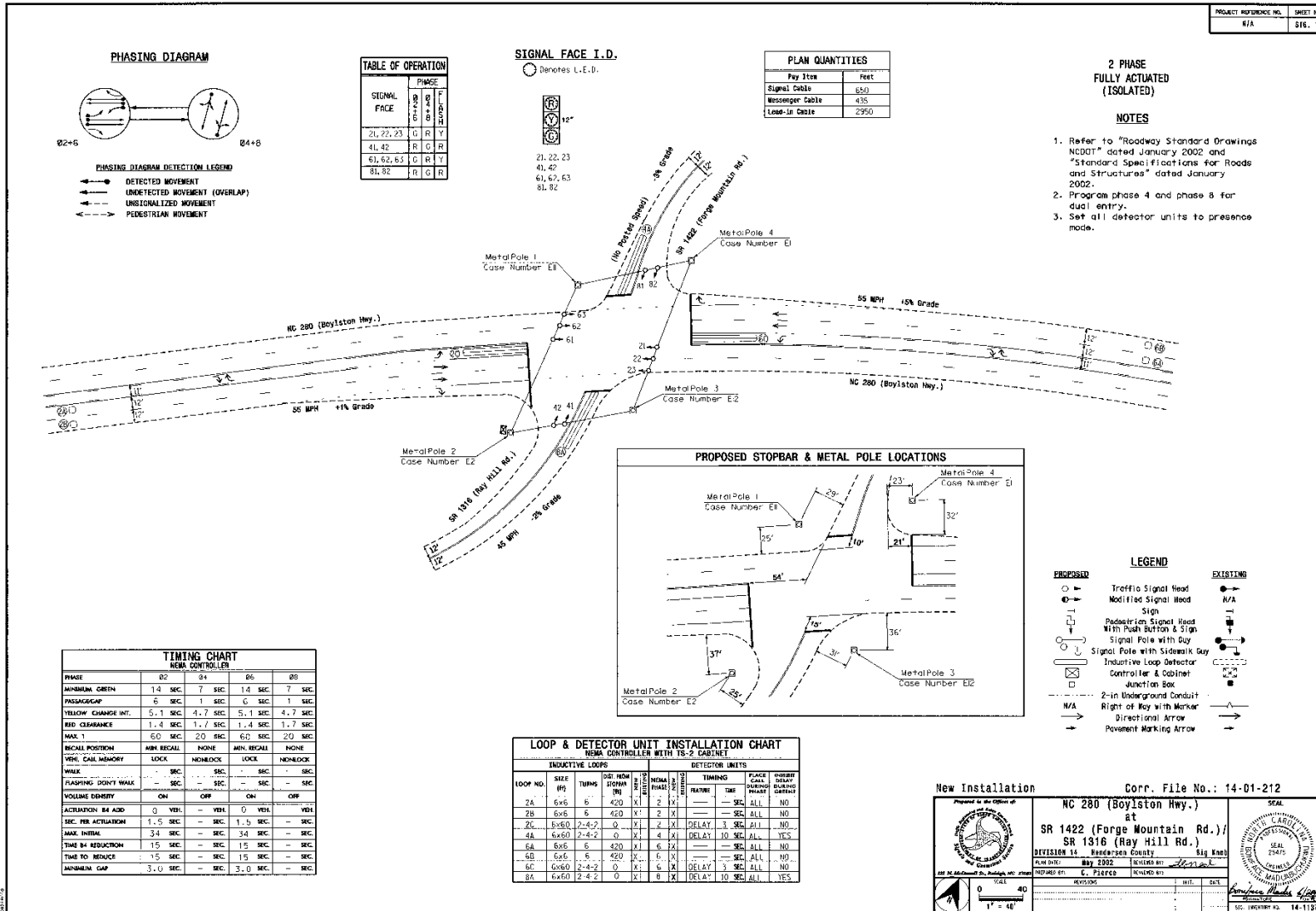


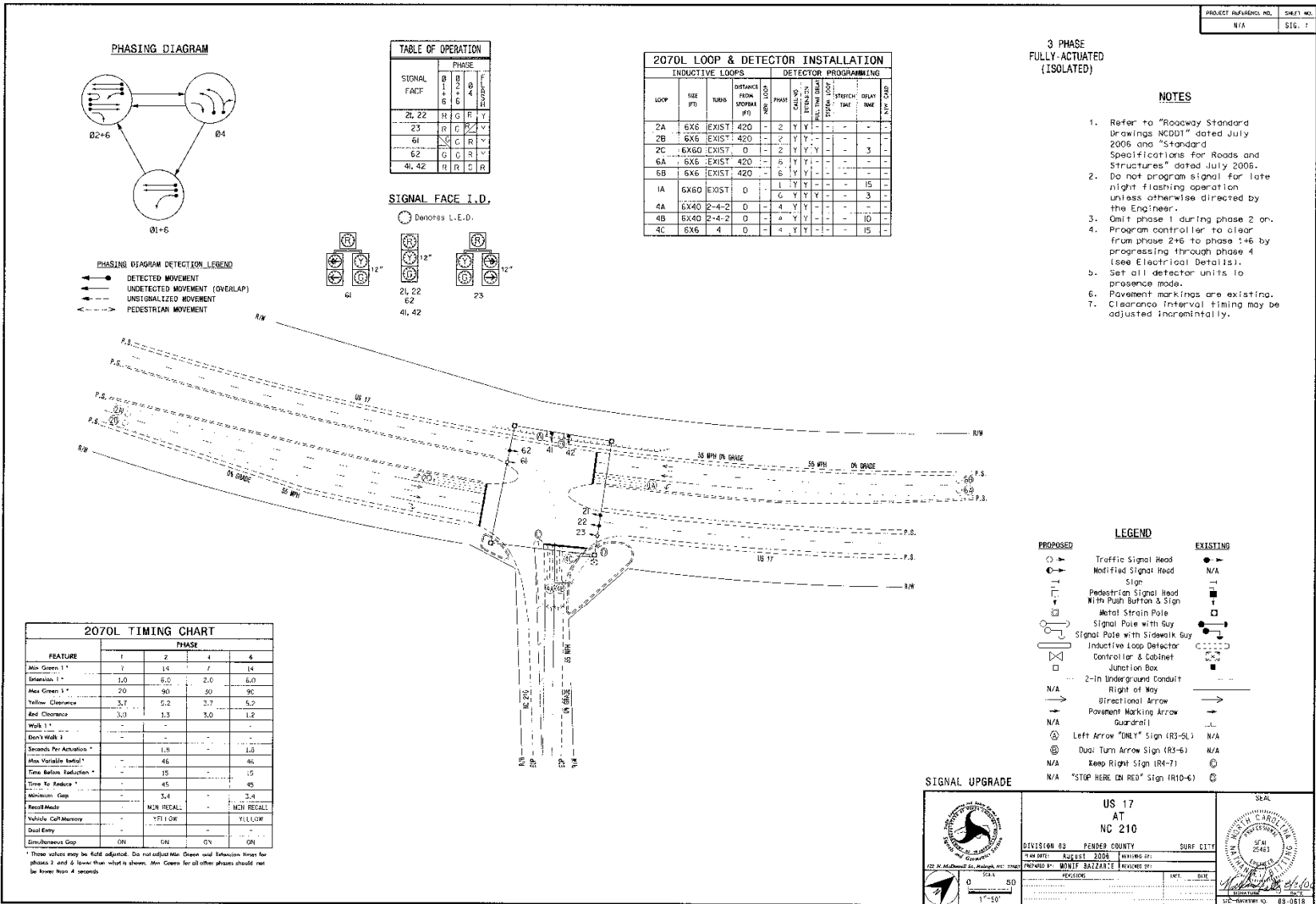
Figure 4.5 Signal Timing Sheet for NC 280 at Ray Hill Road, Mills River, NC (NC Signal #14-1137)

**Site #3:** The intersection of US 17 and NC 210 is just west of Surf City, NC. It lies at the beginning of a gradual horizontal curve; vertically, the grades are all zero. The intersection is a T, with the side street approach being on the eastern side. The mainline has two lanes in each direction, divided by a median, plus left-turn bays at the stop bar and a right-turn bay northbound. The volume-density signal control includes a lagging southbound left. Figures 4.6 and 4.7 depict the site. A minor complication is the large home improvement center located in the southeast corner, which slightly confounds the D-CS signal control because the loops at 1,000' are upstream of the driveway into the commercial site. Truck traffic is heavy, as is total traffic. The intersection is busy throughout the day.



**Figure 4.6** US 17 at NC 210, Surf City, NC (NC Signal #03-0618)





- ### NOTES
1. Refer to "Roadway Standard Drawings NCDD1" dated July 2006 and "Standard Specifications for Roads and Structures" dated July 2006.
  2. Do not program signal for late night flashing operation unless otherwise directed by the Engineer.
  3. Omit phase 1 during phase 2 or.
  4. Program controller to clear from phase 2+6 to phase 1+6 by progressing through phase 4 (see Electrical Details).
  5. Set all detector units to presence mode.
  6. Pavement markings are existing.
  7. Clearance interval timing may be adjusted incrementally.

**Figure 4.7 Signal Timing Sheet for US 17 at NC 210, Surf City, NC (NC Signal #03-0618)**

*Site #4:* The intersection of US 190-74-129 at NC 141 is located in Marble, NC, just south of the Andrews Murphy Airport. The mainline has two through lanes in both directions, divided by a median, plus left-turn bays, and auxiliary lanes for the right turns. The side street has flared approaches but no left-turn bays. The signal control is volume density. There are left-turn arrows (protected/permissive) on the mainline. This intersection was studied via simulation but not a field study.



**Figure 4.8** US 19-74-129 at NC 141, Marble, NC (NC Signal #14-0078)

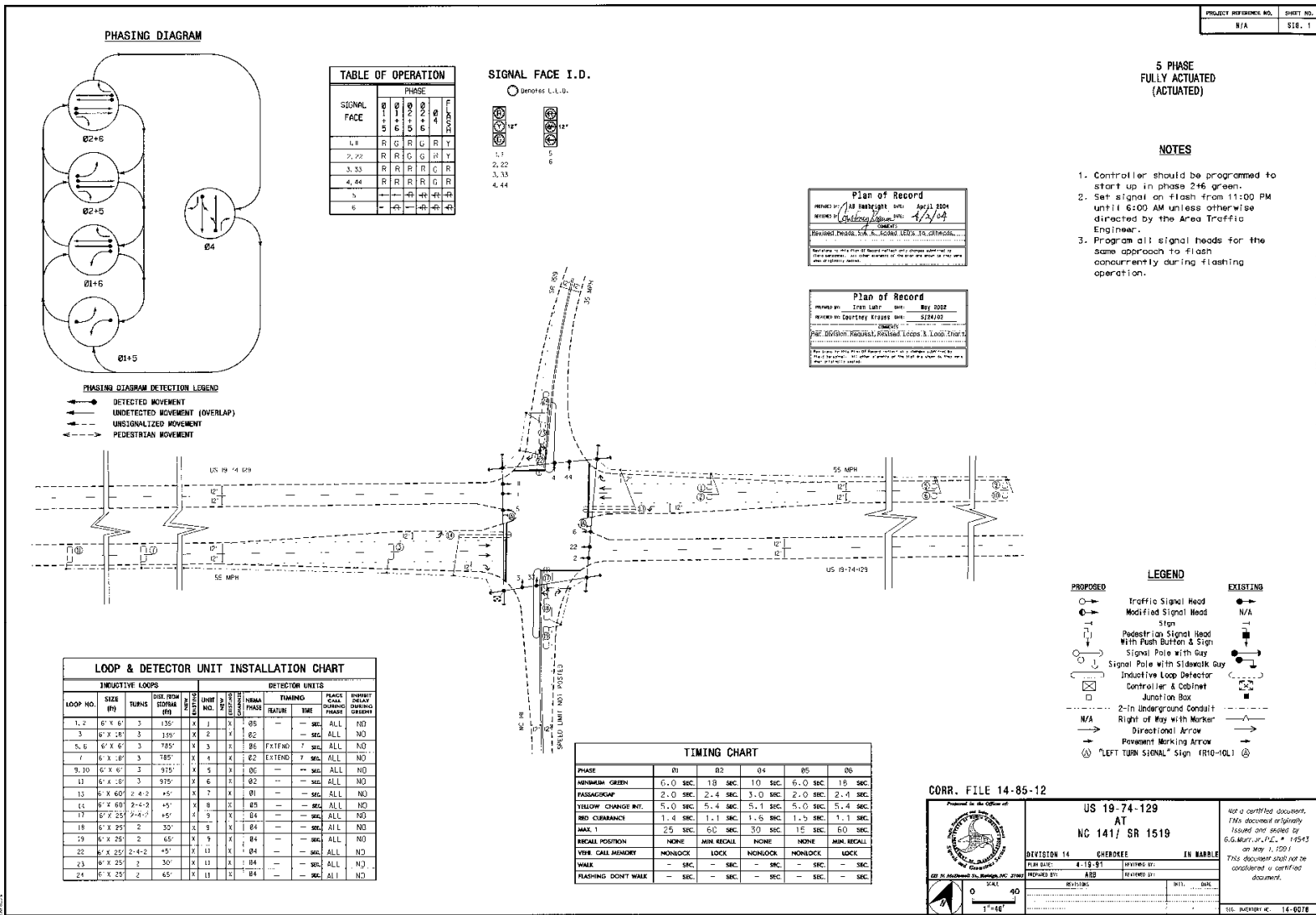


Figure 4.9 Signal Timing Sheet for US 19-74-129 at NC 141, Marble, NC (NC Signal #14-0078)

Site #5: The intersection of NC 24 (Kenansville Bypass) and NC 11-903 is just southwest of Kenansville, NC. The mainline has two through lanes in both directions, divided by a median, plus left-turn bays, and auxiliary lanes for the right turns. The side street has flared approaches but no left-turn bays. The signal control is volume density. There are left-turn arrows (protected/permissive) on the mainline. Figures 4.10 and 4.11 provide a sense of the site. This intersection was studied via simulation but not a field study.



**Figure 4.10** NC 24 (Top to Bottom) and NC 11-903, Kenansville, NC (NC Signal #03-0538)

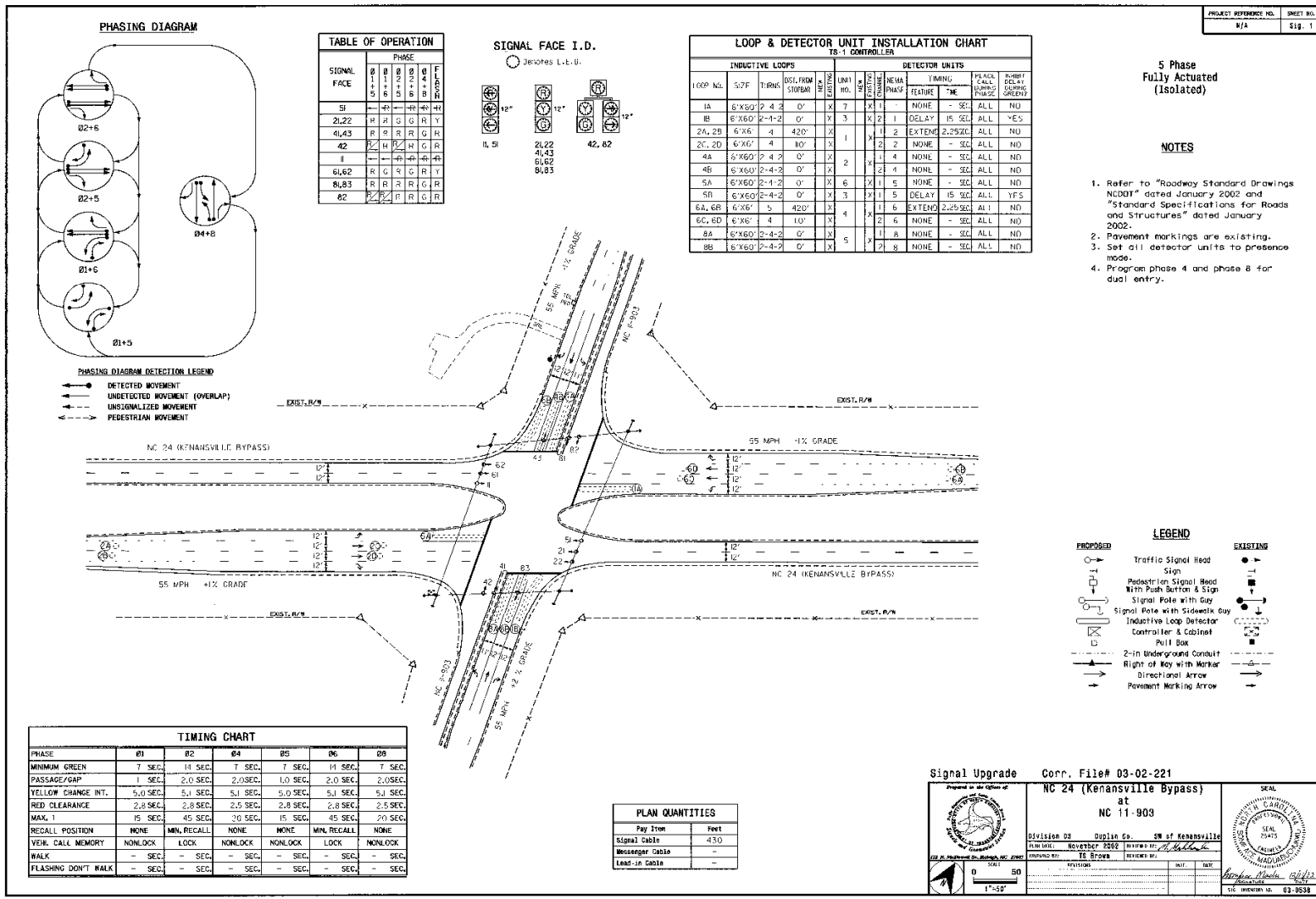


Figure 4.11 Signal Timing Sheet for NC 24 at NC 11, NC (NC Signal #03-0538)

### **4.3 Simulation Configurations**

The simulation studies were conducted using Hardware-In-the-Loop (HIL) simulation. Special hardware configurations were needed to test the NQ4 and D-CS scenarios. The VISSIM traffic microsimulation software package was chosen for the simulation runs because it could (1) easily be connected to and configured with the NIATT controller interface device (CID), and (2) monitor/update the network with a frequency of more than once per second (as small as tenths of a second). Note, VISSIM interfaces with the CID directly, in real-time, and through the CID it interfaces with the NQ4 device, and via the TS-2 cabinet with the Naztec controller. Ten runs were performed for each scenario (intersection and detector/signal control configuration) with different seed numbers so that comparisons and trend analyses were based on average performance. Visual Basic for Applications (VBA) code was created, inside Excel, to assist in calculating the performance measures.

The defaults applied to the runs are as follows:

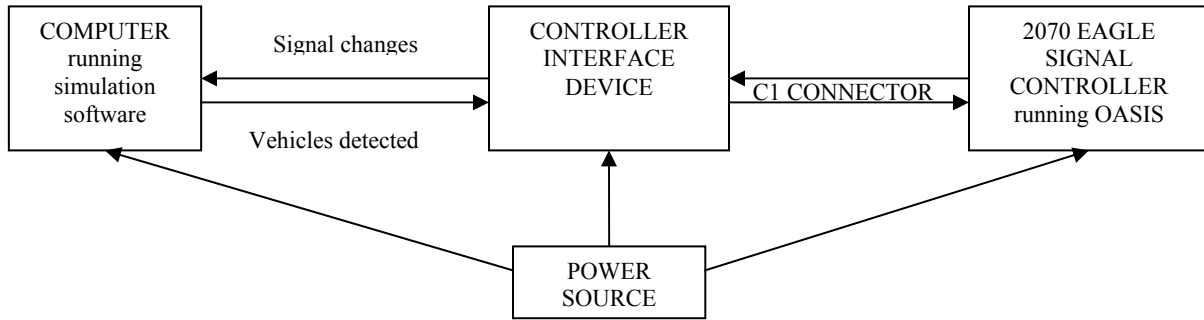
- simulation duration = 3,900.0 seconds;
- simulation speed = 1.0 second simulation time = 1.0 second clock time;
- time step = 10 steps per second or 0.1 seconds per step;
- for all reduced speed areas the range of speeds for cars is 12.4 to 15 mph, while for all heavy vehicles it ranges from 9.3 to 12.4 mph;
- for all priority rules, on average, the minimum gap time is 3 seconds; and
- Data Collection Points (DCPs) for all main street through lanes are set up at 1,000' upstream from the stop-bar.

In terms of outputs, the following information was collected:

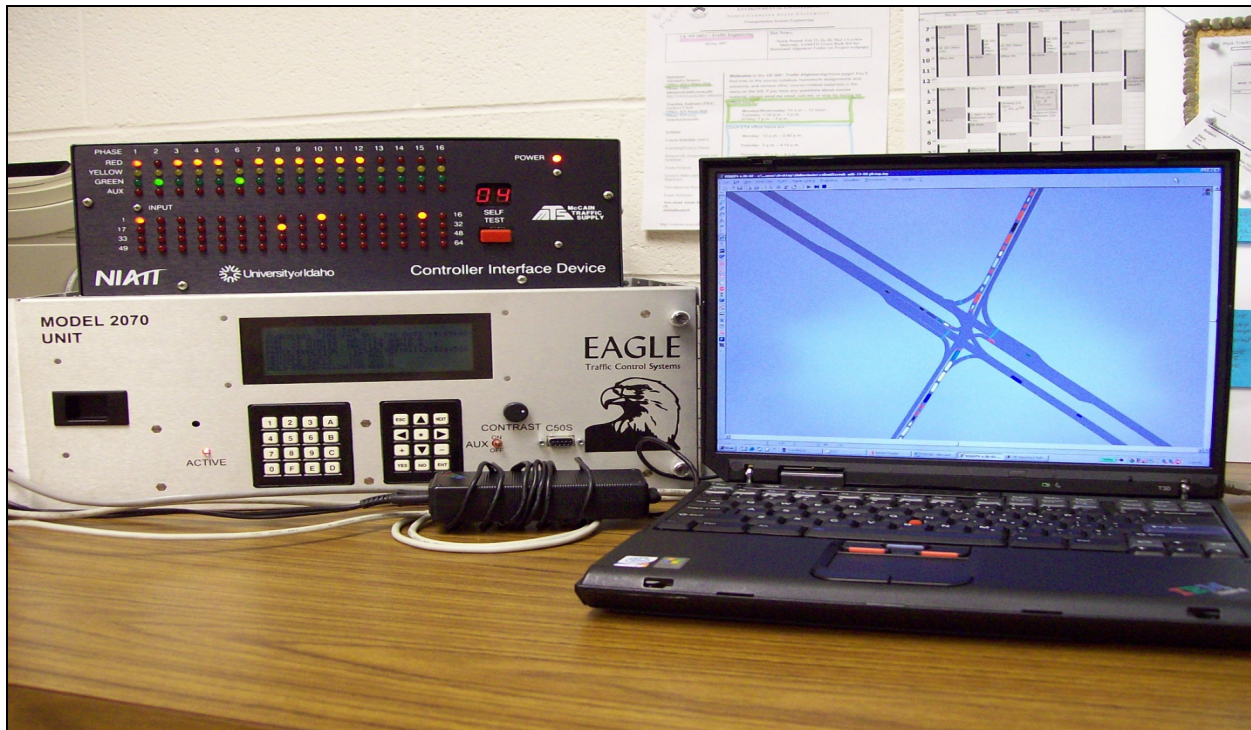
- time stamps for signal indication changes by movement;
- the class of each main street vehicle;
- time stamps, speeds, and vehicle types for every vehicle crossing the speed traps 1,000 feet upstream of the intersection; and
- time stamps for each vehicle as it crossed into the intersection.

The base case analyses used a laptop running VISSIM connected to a NIATT/McCain controller interface device (CID) which then talked to a 2070 Eagle controller running OASIS. The connection from the CID to the controller was a 170 harness with A, B, and C connectors on the CID side and a C1 connector on the controller side. The CID enabled detections in the traffic simulation to trigger calls in the signal controller; and for signal indications from the controller to be sent back to the simulation.

Figure 4.12 shows the logical connections between the HIL simulation components. Figure 4.13 contains a picture of the laptop, CID, and controller as they were positioned while the HIL simulations were being performed.

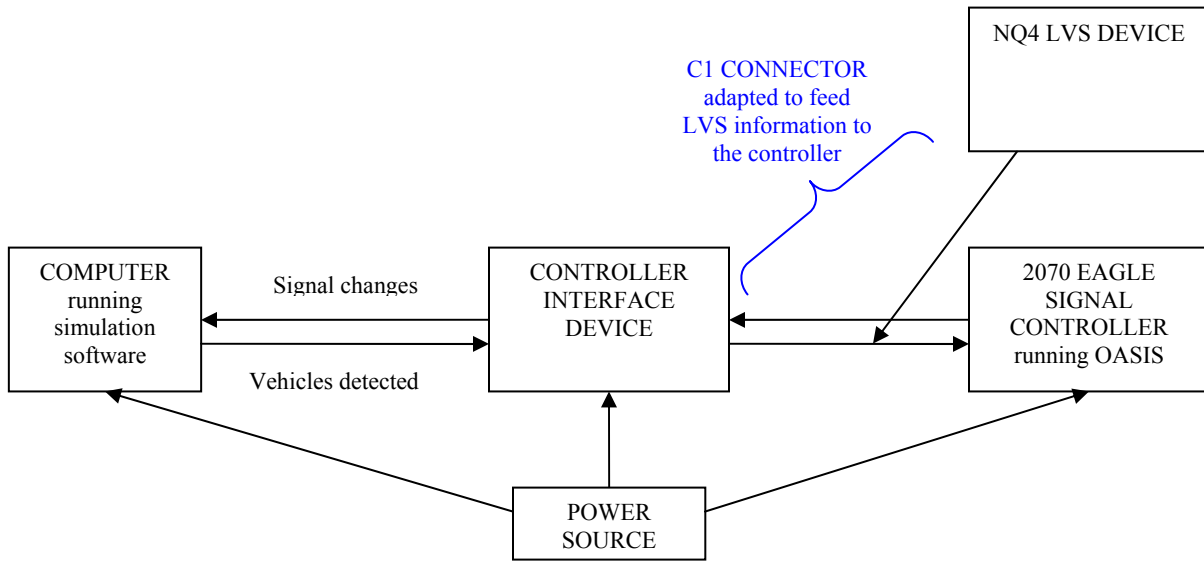


**Figure 4.12 Base Case HIL Configuration - VISSIM – CID – 2070 Eagle Controller**

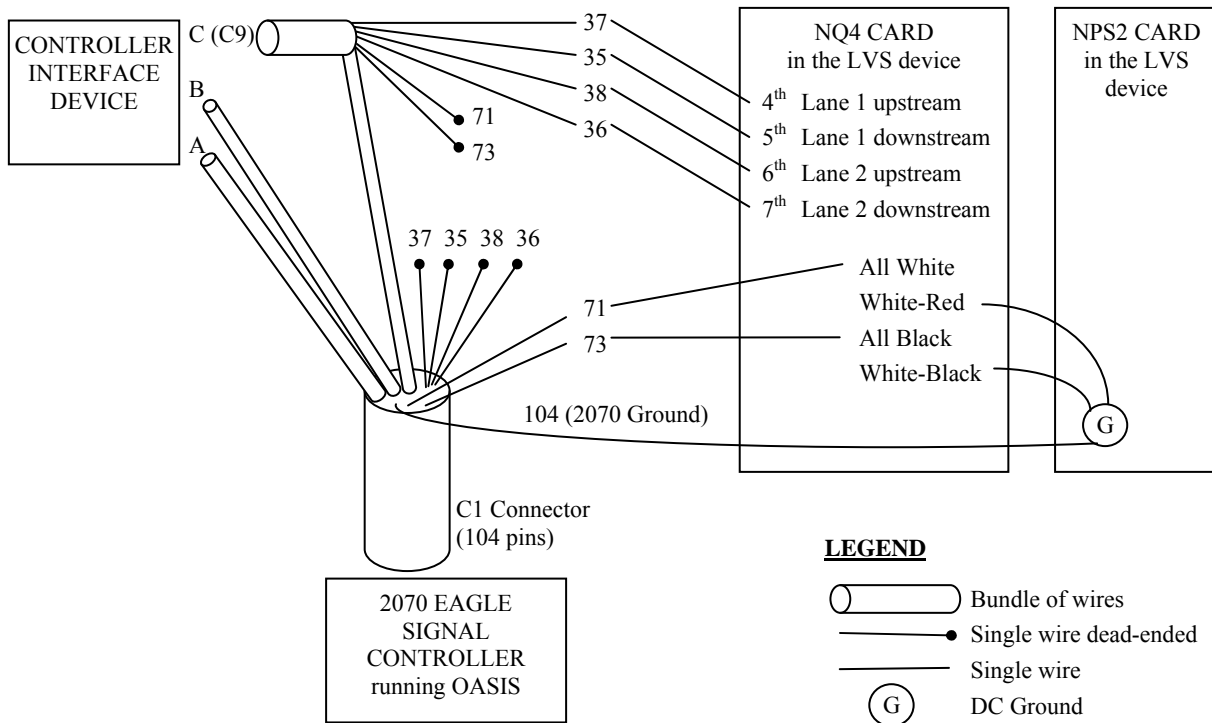


**Figure 4.13 Base Case Configuration – Laptop with VISSIM, CID and 2070 Eagle Controller**

For the HIL simulations involving the NQ4 device, we took a standard CID 170 cable (having a C1 connector on one end) and spliced the NQ4 directly into the cable. This made it possible to do HIL tests of the NQ4 in conjunction with an NCDOT controller running OASIS. Figure 4.14 shows the logical connections between the NQ4, CID, controller, and laptop; and Figure 4.15 contains pictures of how this was done physically.

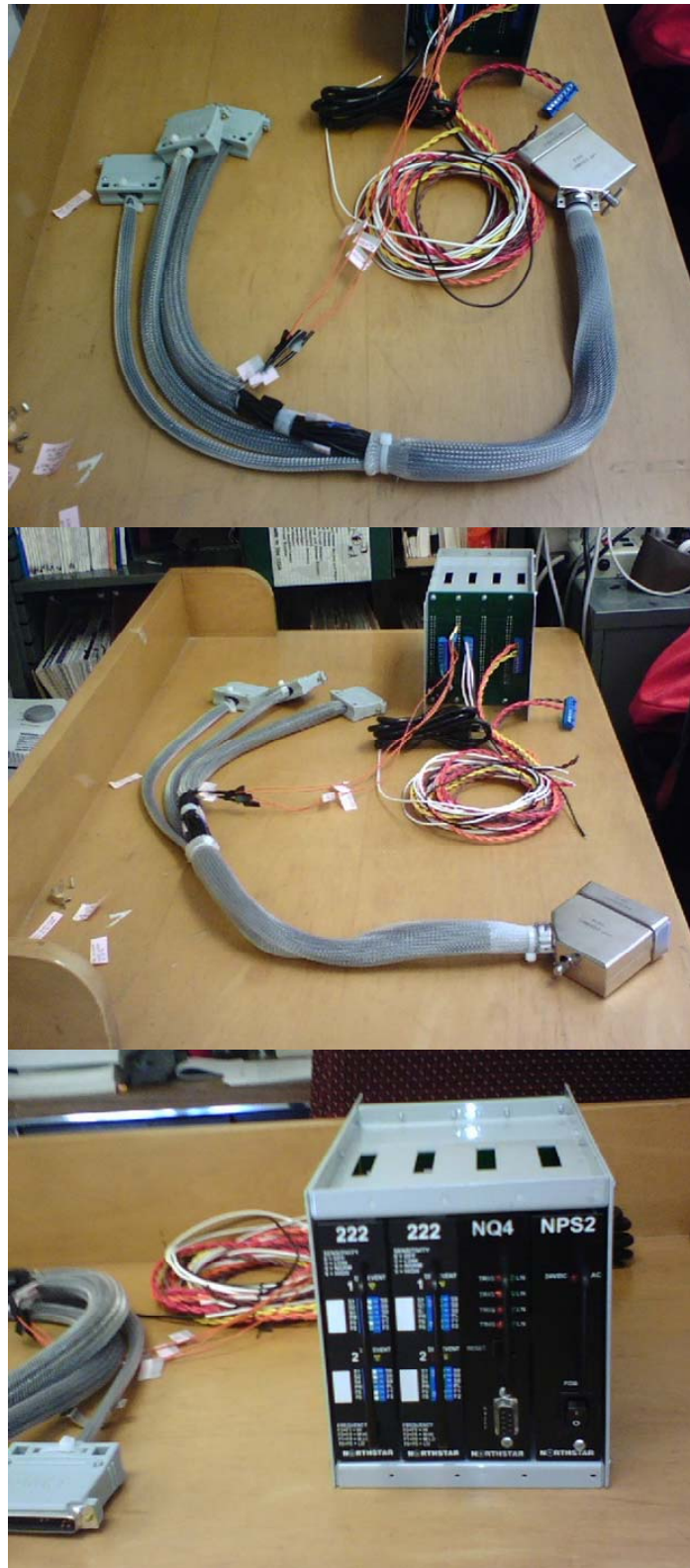


**C1 CONNECTOR Adaptation Details**



**Figure 4.14 Logical Relationships among the Devices for the NQ4 HIL Simulations**





**Figure 4.15** NQ4 Device Spliced into the 170 Cable

For the D-CS simulations, it was necessary to put the TS-2 cabinet into the loop. For reasons that are not completely clear, the CID could not pass detector inputs for the speed traps at 1,000' to the Naztec controller in such a way that the D-CS control software could use them. However, discussions with Naztec revealed that this could be accomplished if the communication to the controller from the CID was via the TS-2 cabinet.

Consequently, the NCDOT Signal Shop prepared a 170 cable that had a C1 back panel piece on one end and all 104 individual wires separately labeled on the other. This is shown in Figure 4.16. The cable was prepared by de-soldering the C1 back panel piece so all 104 pins were exposed and then soldering tagged wires onto all the pins.



**Figure 4.16** 170 Cable with a C1 Back Panel on One End and Individual Wires on the Other

The individual wires were then soldered or connected to the TS-2 cabinet's detector and signal panels by the research team. A picture of these soldered connections to the fold-down load switch panel of the TS-2 cabinet is shown in Figure 4.17.



**Figure 4.17** Soldered Connections of the Individual Wires from the 170 Cable to the 2070-2A Field I/O Module in the TS-2 Cabinet

#### **4.4 Simulation Results Analysis Methodology**

Ten runs with different random seed values were performed for each detector/signal control configuration at each intersection so that comparisons and trend analyses could be based on average results, not individual runs. Peak hour traffic counts for the test intersections were provided by NCDOT.

VISSIM directly provided two metrics of interest (or MOEs – measures of effectiveness), average delays and average cycle lengths. Reductions in either or both of these indicate

improved performance and a reduced average cycle length indicates enhanced responsiveness to minor movement calls. The run results include other performance metrics that tend to be correlated to average delay such as the average number of stops and maximum queue length.

Following the lead of Bonneson *et al.* (2002), two other performance metrics were given significant attention: (1) the number of vehicles caught in dilemma zones at the onset of yellow, and (2) the number of vehicles that entered the intersection after red (red-light violations). Reductions in either or both of these metrics imply that the intersection's safety performance has improved, and the first, more than the second, indicates that accident frequencies should be reduced.

The dilemma zone and red-light violation metrics were developed by post-processing data captured during simulation. VISSIM does not produce these metrics directly. The methodology was as follows:

- 1) Data collection sensors were placed in each through lane, 1,000' upstream of the stop bar and at the stop bar.
- 2) A time stamp record was created by VISSIM each time a vehicle either entered or exited one of these sensors. Each record contained: the time for the event, the vehicle ID, the vehicle type, the vehicle's speed, and the vehicle's acceleration (deceleration) rate.
- 3) This meant four records were created for every vehicle on the mainline approaches: 1) entering and 2) leaving the data collection sensor at 1,000' and 3) entering and 4) leaving the data collection sensor at the stop bar.
- 4) In addition, time stamps were output by VISSIM for each signal indication change event. This meant that for the mainline through movements, for example, we knew each beginning of yellow, red, and green. VISSIM not only provided the time stamp for the event and the event type, but the time since the last event occurred, so for the yellows, we knew how long the preceding green had lasted.
- 5) For every onset-of-yellow time,  $t_a$ , the vehicle records were then checked to find vehicles that entered the 1,000' sensor prior to  $t_a$  and departed the stop bar sensor after  $t_a$ . These vehicles  $\{V_a\}$  might have been in dilemma zones at  $t_a$ .<sup>10</sup>
- 6) For each vehicle in  $\{V_a\}$ , we then used the timestamps for entering the 1,000' sensor and entering the stop bar sensor to compute the vehicle's effective deceleration (acceleration) rate.
- 7) Then from that, we determined when the vehicle would have been 6-seconds and 2-seconds away from the stop bar.
- 8) If  $t_a$  occurred between these two times, then the vehicle was in a dilemma zone at the onset of yellow.
- 9) We tabulated the number of vehicles (by type and total) that were in dilemma zones at the onset of yellow for each  $t_a$ .
- 10) We then counted the number of times that 0, 1, 2, etc. vehicles were in dilemma zones across all of the yellow times.

---

<sup>10</sup> VBA code was created, inside Excel, to conduct the analyses described in steps 5 and beyond.

- 11) These counts were converted into percentages  $P_k$  so that we could determine the percentage of yellows for which there were  $k = 0, 1, 2$  etc. vehicles in dilemma zones. This was the performance achieved by the signal control.
- 12) We also tabulated the number of cars and trucks that would have been in dilemma zones if the signal had decided to transition to yellow at some other time during the preceding green. This was done by repeating steps 5)-11) for every  $t$  such that  $t_g < t < t_a$  for every  $t_a$ . This created the baseline percentages  $P_k$  for  $k = 0, 1, 2 \dots$  vehicles that might have been caught in dilemma zones if other times for the yellows had been chosen.
- 13) Presumably, the signal control selected  $t_a$  rather than some other  $t$  ( $t_g < t < t_a$ ) because significantly fewer vehicles would be in dilemma zones at  $t_a$  than at the other possible times  $t$ . This would mean that for low values of  $k$ , such as  $k = 0, 1, 2 \dots$ ,  $P_k$  would be higher for the  $t_a$ 's chosen than for the other possible choices.
- 14) A stochastic dominance test was used to see how well the signal control was keeping vehicles from being in dilemma zones at the transition to yellow. If  $CP_k$  is the cumulative probability that the number of vehicles caught in dilemma zones is less than or equal to  $k$ , then if stochastic dominance holds,  $CP_k(t_a) \geq CP_k(t)$  for all  $k$ .
- 15) For every onset-of-red time,  $t_r$ , the vehicle records were then checked to see if there were cars and trucks that arrived at the stop bar sensor after  $t_r$  and departed the stop bar sensor prior to the subsequent onset of green,  $t_g$ . Each of these was a red-light violator.<sup>11</sup>

#### 4.5 Simulation Results – An Illustration

It helps to see an illustration of the analysis, so the steps become clearer.

Table 4.1 contains an illustration of the time stamps for vehicle events.

**Table 4.1 Time Stamps for Vehicle Events**

Data C.P.	t(enter)	t(leave)	VehNo	Type	Line	v[m/s]	a[m/s <sup>2</sup> ]	Occ	Pers	tQueue	VehLength[m]
5	308.7	-1	175	100	0	23.3	0.16	0	1	0	4.61
5	-1	308.9	175	100	0	23.3	0.16	0.1	1	0	4.61
3	310.95	-1	176	100	0	20.8	-0.27	0.05	1	0	4.61
3	-1	311.17	176	100	0	20.7	-0.26	0.07	1	0	4.61
2	301.21	-1	177	200	0	29.2	-0.16	0.09	1	0	10.21
2	-1	301.56	177	200	0	29.1	-0.16	0.06	1	0	10.21
8	312.01	-1	178	100	0	22.6	-0.15	0.09	1	0	4.76
8	-1	312.22	178	100	0	22.6	-0.15	0.02	1	0	4.76
7	357.36	-1	178	100	0	2.2	2.86	0.04	1	28.2	4.76
7	-1	358.59	178	100	0	5.5	2.45	0.09	1	28.2	4.76
4	312.82	-1	179	100	0	24.5	0.05	0.08	1	0	4.55
4	-1	313.01	179	100	0	24.5	0.05	0.01	1	0	4.55
3	342.38	-1	179	100	0	1.7	2.1	0.02	1	13.1	4.55
3	-1	343.83	179	100	0	4.5	1.77	0.03	1	13.1	4.55
6	312.48	-1	180	100	0	22.9	0.27	0.02	1	0	4.76
6	-1	312.69	180	100	0	22.9	0.27	0.09	1	0	4.76
5	357.27	-1	180	100	0	2.2	3.36	0.03	1	28.1	4.76
5	-1	358.44	180	100	0	5.9	3	0.04	1	28.1	4.76

<sup>11</sup> VBA code was created, inside Excel, to conduct these dilemma zone analyses.

The table entries indicate the data collection point (interpretation is not important); the time at which the vehicle either entered or left the collection point (e.g., vehicle 175 entered data collection point 5 at 308.7 and left at 308.9); the vehicle number; vehicle type; lane, instantaneous speed (m/s), acceleration (m/s<sup>2</sup>), and occupancy (sec)<sup>12</sup>, time in queue, if relevant, and the vehicle length (in meters). Some of the data collection points are 1,000' upstream of the stop bar, others are at the stop bar. Which ones are where is not important to decipher here. However, working with the entry times to the sensor at 1,000', the entry times to the sensor at the stop bar, and the speed recorded at 1,000' allows one to compute a deceleration rate, develop a vehicle trajectory, and determine the times at which the vehicle was 6-seconds and 2-seconds from the stop bar.

**Table 4.2 Signal Timing Data Excerpt**

0.1	0	1	6	green	1
0.1	0	1	2	green	1
60.2	0	1	6	amber	60.1
60.2	0	1	2	amber	60.1
65.4	0	1	6	red	5.2
65.4	0	1	2	red	5.2
66.7	0	1	4	green	67.6
73.7	0	1	4	amber	7
77.4	0	1	4	red	3.7
80.4	0	1	2	green	15
80.5	0	1	6	green	15.1
127.2	0	1	6	amber	46.7
127.2	0	1	2	amber	46.8
132.4	0	1	6	red	5.2
132.4	0	1	2	red	5.2

Table 4.2 shows an excerpt from the signal timing data. As can be seen, each record shows the time at which the signal event occurred, the approach on which the indication changed; the indication displayed and the seconds during which the prior indication was present (e.g., movements 2 and 6 became green at 0.1 seconds, then yellow at 60.2 seconds, and red at 65.4 seconds).

Synchronizing the signal timing data (e.g., the onsets of yellow at 60.2 seconds) with the vehicle trajectory data allows one to determine whether specific vehicles were in a dilemma zone at the onset of yellow. For example, if there were a vehicle which was 6-seconds upstream of the stop bar at  $t = 56$  seconds and 2-seconds upstream at  $t = 62$  seconds, then that vehicle was in a dilemma zone when the yellow commenced.

**Table 4.3 Yellow Analysis Results**

Actual Ambers												
Counts				Probabilities				CumProb				
Nveh	Reg	Long	Either	Nveh	Reg	Long	Either	Nveh	Reg	Long	Either	
0	110	129	109	0	84.6%	99.2%	83.8%	0	84.6%	99.2%	83.8%	
1	18	1	19	1	13.8%	0.8%	14.6%	1	98.5%	100.0%	98.5%	
2	2	0	2	2	1.5%	0%	1.5%	2	100.0%	100.0%	100.0%	
3	0	0	0	3	0%	0%	0%	3	100.0%	100.0%	100.0%	
4	0	0	0	4	0%	0%	0%	4	100.0%	100.0%	100.0%	
5	0	0	0	5	0%	0%	0%	5	100.0%	100.0%	100.0%	
6	0	0	0	6	0%	0%	0%	6	100.0%	100.0%	100.0%	
7	0	0	0	7	0%	0%	0%	7	100.0%	100.0%	100.0%	
8	0	0	0	8	0%	0%	0%	8	100.0%	100.0%	100.0%	
9	0	0	0	9	0%	0%	0%	9	100.0%	100.0%	100.0%	
10	0	0	0	10	0%	0%	0%	10	100.0%	100.0%	100.0%	
	130	130	130		100%	100%	100%					

The yellow analysis produces results like those shown in Table 4.3. Shown is a case involving D-CS control. During the simulation, 130 yellows occurred. In 129 of these, no long vehicles were in a dilemma zone; there was one more where a long vehicle got trapped; there were none where two or more long vehicles got trapped. Similarly, for the regular vehicles, there were 110

<sup>12</sup> Both the entry and exit records are required to determine the total occupancy time.

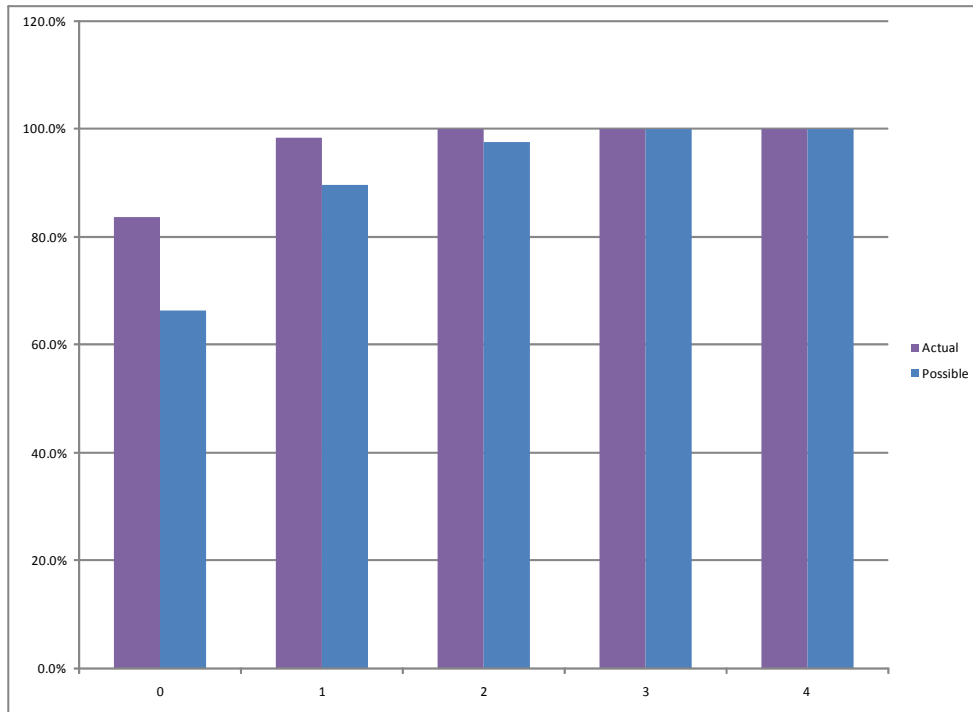
instances where none were trapped, 18 more where there was one, and two where there were two. In terms of instances where either a regular or a long vehicle was present, there were 109 yellows in which no vehicle of either type was trapped, 19 in which one was, and 2 in which two were. The middle sub-table shows the probabilities of these occurrences based on the 130 observations, and the right sub-table shows the cumulative probabilities. In this instance, there was an 83.8% chance that no vehicles of any type were in a dilemma zone at the onset of yellow, and a 98.5% chance that the number was one or less.

Table 4.4 shows the analysis results if you looked at all the times (during the same simulation) when a transition to yellow could have occurred. There were 351 such possible times. In 233 of them, if any one of these times had been selected, no vehicle would have been in a dilemma zone. That is 66.4% of these options. However, there were 82 instances where one would have been trapped (23.4%), 28 where there would have been two (8.0%), and 8 where there would have been three (2.3%).

**Table 4.4 All Yellow Options Analysis**

All Possible Amber Times													
Nveh	Counts				Nveh	Probabilities				Nveh	CumProb		
	Reg	Long	Either			Reg	Long	Either			Reg	Long	Either
0	235	346	233		0	67.0%	98.6%	66.4%		0	67.0%	98.6%	66.4%
1	82	5	82		1	23.4%	1.4%	23.4%		1	90.3%	100.0%	89.7%
2	27	0	28		2	7.7%	0.0%	8.0%		2	98.0%	100.0%	97.7%
3	7	0	8		3	2.0%	0.0%	2.3%		3	100.0%	100.0%	100.0%
4	0	0	0		4	0.0%	0.0%	0.0%		4	100.0%	100.0%	100.0%
5	0	0	0		5	0.0%	0.0%	0.0%		5	100.0%	100.0%	100.0%
6	0	0	0		6	0.0%	0.0%	0.0%		6	100.0%	100.0%	100.0%
7	0	0	0		7	0.0%	0.0%	0.0%		7	100.0%	100.0%	100.0%
8	0	0	0		8	0.0%	0.0%	0.0%		8	100.0%	100.0%	100.0%
9	0	0	0		9	0.0%	0.0%	0.0%		9	100.0%	100.0%	100.0%
10	0	0	0		10	0.0%	0.0%	0.0%		10	100.0%	100.0%	100.0%
	351	351	351			100.0%	100.0%	100.0%					

It is clear that the D-CS control is selecting better-than-average times at which to invoke the yellow indications.



**Figure 4.18 Cumulative Probability Comparison**

Figure 4.18 graphically shows the cumulative probabilities for trapping vehicles in the case of the results of this comparison (plots the results of Tables 4.3 and 4.4); the left bar of each pair shows the actual D-CS control situation (data from Table 4.3) whereas the right bar shows the potential for trapping vehicles if the yellow onset was randomly selected (data from Table 4.4). Notice that the probability for trapping none is significantly higher for the D-CS control than it is for the other possible yellow times. The same is true for the probability that one or more, or two or more vehicles might be trapped. The hoped-for result is evident. The D-CS control is finding opportune times to invoke the yellows.

#### **4.6 Simulation Results and Findings**

The simulation results demonstrate that both the D-CS and NQ4 configurations significantly reduce the likelihood that vehicles will be trapped in dilemma zones at the onset of yellow. Moreover, the D-CS strategy provides the added benefit of reducing delays and reducing the cycle length.

Table 4.5 summarizes the findings among the five sites studied. Notice that:

- The cumulative probability of none (0) or at most one (1) vehicle being in a dilemma zone at the onset of yellow is much higher for either the NQ4 or the D-CS strategy compared to the base case condition. For example, for the NC 280 site, the base case has a CP(0) of 69.6% for all vehicles while for the NQ4 configuration it is 77.9% and for D-CS it is 80.0%.



**Table 4.5 Simulation Results Summary**

	All Vehicles - Cum Prob of being in DZ				Trucks - Cum Prob of being in DZ				AvgD	AvgCyc (sec)	TotAmb
	CumProb(0)		CumProb(1)		CumProb(0)		CumProb(1)				
	Amber	Other	Amber	Other	Amber	Other	Amber	Other			
Swift Creek											
Base											
NQ4	65.1	43.5	89.1	75.3	96.8	91.1	99.9	99.7	13.7	78.4	459
D-CS	66.2	45.7	91.6	77.6	95.9	91.3	99.9	99.5	11.4	74.1	486
NC-280											
Base	69.6	67.6	94.7	93.2	99.2	98.8	100.0	100.0	11.2	97.6	369
NQ4	77.9	63.3	95.1	91.0	98.6	97.8	100.0	100.0	13.5	68.6	525
D-CS	80.0	63.2	98.0	91.0	98.7	98.0	100.0	100.0	3.9	68.1	529
US-17											
Base	77.2	77.1	95.5	95.6	88.4	88.4	98.3	98.4	8.6	75.0	480
NQ4	69.8	57.0	91.3	87.1	86.6	75.5	97.4	95.7	11.1	90.7	397
D-CS	82.2	61.8	97.8	88.6	99.5	97.5	100.0	100.0	5.9	56.3	640
US-19											
Base	82.6	81.5	99.3	98.9	99.0	99.0	100.0	100.0	38.9	88.2	408
NQ4	91.1	78.3	99.5	97.0	99.9	98.9	100.0	100.0	14.4	77.1	467
D-CS	91.1	79.4	99.5	96.5	99.8	99.0	100.0	100.0	12.3	58.3	617
NC-24											
Base	82.4	80.4	97.6	96.8	98.1	98.0	99.9	99.9	13.2	67.7	532
NQ4	81.2	70.0	97.1	93.4	98.8	96.0	100.0	100.0	13.6	64.3	560
D-CS	81.5	70.8	97.9	93.6	98.2	96.5	99.9	100.0	12.6	61.9	582

- Notes:
1. CumProb(#) = cumulative probability that # of vehicles are in a dilemma zone (DZ). The probabilities are shown in percents (0 to 100) instead of decimals (0 to 1).
  2. AvgD = average delay in seconds.
  3. AvgCyc = average cycle length.

- In both the NQ4 and D-CS configurations, the yellow times selected provide much higher cumulative probabilities for CP(0) and CP(1) than do the other green times that could have been selected. Again for NC 280, the base case involves almost no change, a value of 67.6% for any possible time versus 69.6% for the yellows that were actually invoked; while for NQ4 the change is from 63.3% to 77.9% and for D-CS it is from 63.2% to 80.0%.
- In all cases, CP(0) is higher for the D-CS configuration than it is for the NQ4 one.
- The average delays for the D-CS configuration are always the smallest and in some cases, like NC 280 and US 17, they are dramatically so.
- The average cycle lengths for D-CS are always the smallest while the NQ4 configuration produces mixed results, while most of the time the average cycle length is shorter, sometimes it is longer.

The conclusion we draw is that both NQ4 and D-CS are good control strategies, but the D-CS strategy has a slight edge based especially on delays and average cycle length, and sometimes based on the cumulative probabilities as well.

#### 4.7 Field Study Preparation and Data Collection

Field studies were conducted at three locations: US 70 and Swift Creek Road, NC 280 and Ray Hill Road, and US 17 and NC 210. The detector placement/signal control configurations explored were as follows:

- *Base Case*: This configuration was the existing/initial conditions in the field. Except for Swift Creek, it had standard NCDOT detector placements (e.g., detectors in each mainline lane, 420' upstream of the stop bar) and volume-density control using a 2070 controller and NCDOT's OASIS software.
- *NQ4*: This configuration added the NQ4 devices to both mainline approaches (one in each direction). The other detector placements were left intact and volume-density control was still employed using a 2070 controller and OASIS software. The configuration represents the manner in which NCDOT typically addresses the need for advance detection and high-speed protection. Speed traps were formed from detectors 20' apart, about 1,000' upstream of the stop bar in each mainline lane. This enabled the NQ4 devices to sense the speed and length of each oncoming vehicle. When the NQ4 devices identified "long" vehicles (over 22') traveling fast (over 55 mph), a 10-second hold was placed on main street green using a detector input, to ensure that the oncoming vehicle could pass through the intersection without encountering an yellow, even if the maximum green was then violated. This was the base case condition at Swift Creek.
- *D-CS*: This was the configuration in which the Naztec 2070 controller, in a Naztec TS-2 cabinet, operating in D-CS mode, worked in conjunction with speed traps in each mainline lane located about 1,000' upstream of the stop bar. The existing 2070 cabinet was swapped out so Naztec's TS-2 cabinet and 2070 controller with the D-CS algorithm could be put in place. Wireless Sensys detectors (magnetometers) were installed in the pavement to create the speed traps at 1,000', working in conjunction with Sensys "repeater units", a Sensys "access point", and two Sensys detector cards.

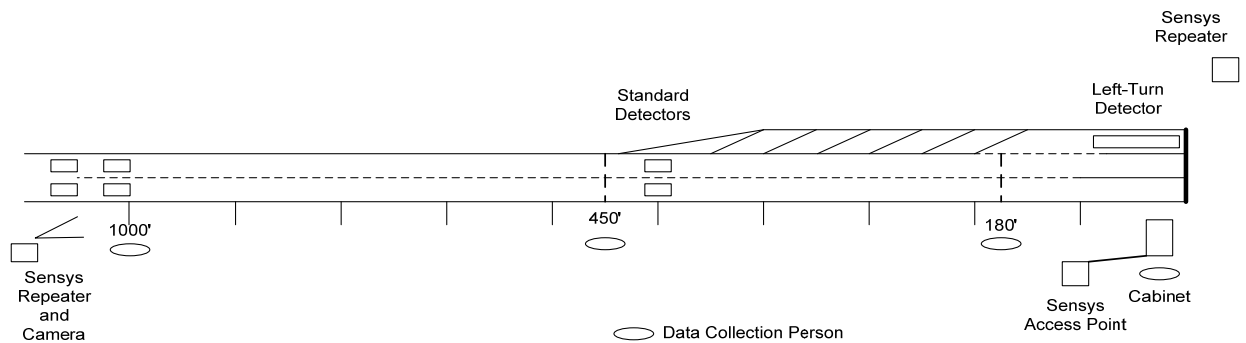
Both mainline approaches were always controlled in the same manner. Hence, if NQ4 devices were installed, both approaches were being controlled by the NQ4 devices.

Data were collected one approach at a time. The general set-up is shown in Figure 4.19. From left to right, data collection involved:

- At 1,000', four Sensys detectors, two in each lane (8 total) to create speed traps;<sup>13</sup>
- At 1,000', a Sensys repeater (2 total), slightly upstream of the Sensys detectors, mounted about 20' in the air, on a pole, to receive inputs from the Sensys detectors and relay those to the Sensys Access Point adjacent to the controller;
- At the intersection, a third Sensys repeater, across from the Sensys Access Point, mounted atop a strain pole, to bounce the inputs from the detectors on the same side as the controller, back to the access point. This additional repeater is shown in the top right-hand corner of the figure.

---

<sup>13</sup> At Swift Creek for the NQ4 configuration, the detectors already installed were used. For the D-CS configuration, new Sensys detectors were installed and employed.



**Figure 1: Field Data Collection Configuration**

### Figure 4.19 Field Study Set-Up

- At the intersection, a Sensys Access Point, adjacent to the controller cabinet, mounted atop the adjacent strain pole, to receive incoming sensor data from the repeaters and convey those inputs to the controller;
- At 1,000', a video camera;<sup>14</sup>
- At 1,000', a data collection person with a laptop collecting time stamps for vehicles, by vehicle type (car or truck) and lane; and
- At 450', 180', and 0' (at the stop bar, near the controller cabinet), additional people collecting time stamps for vehicles, by vehicle type (car or truck) and lane as well as signal indication changes in the case of 180' and 0'.

The 450' and 180' locations were selected because they are about 5-seconds and 2-seconds upstream of the stop bar given the 55-65 mph speeds that typified the oncoming vehicles. The equipment was left running all the time. Data collection occurred in the afternoon of the first day (typically 1:00PM -6:00PM) and the morning of the second day (typically 8:00AM to 1:00PM).

The video camera was used to create a record of what transpired during the data collection. It was not used for primary data collection purposes. The main purpose of the video record was to help resolve questions about what happened during the data collection, if questions arose.

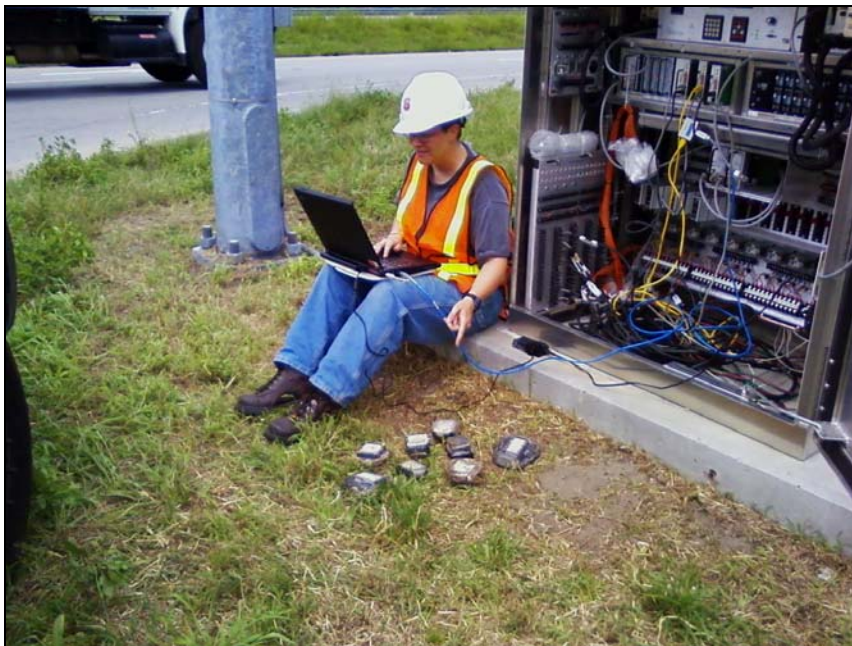
Swift Creek was the first location at which the fieldwork occurred. The base case condition included the NQ4 devices, so initial data collection occurred without doing anything to the controller or the detectors. For the D-CS data collection, the controller and cabinet were swapped out and new detectors were installed. Figure 4.20 shows the cabinet and controller being swapped out.

<sup>14</sup> At Swift Creek, which already had NQ4 devices installed, there was a cabinet at 1,000'.



**Figure 4.20** Swapping Out the Cabinet and Controller at US 70 and Swift Creek

The controller was then connected to the existing detectors and signal displays and brought on line. Sensys detectors were prepared for installation and then placed in the pavement. Figure 4.21 shows the detectors being prepared for installation.



**Figure 4.21** Wireless Sensors Being Prepared for Installation

Figure 4.22 contains two pictures of holes being drilled into the pavement so the wireless sensors could be installed.



**Figure 4.22** Installing the Wireless Sensors in the Pavement at US 70 and Swift Creek (left) and NC 280 and Ray Hill Road (right)

The repeaters and access points were then installed to capture the wireless detector inputs and convey them to the controller. Figure 4.23 shows the bounce repeater (across from the controller) being installed at NC 280 and Ray Hill Road.



**Figure 4.23** Installing the Bounce Repeater at NC 280 and Ray Hill Road

Figure 4.24 shows the access point being installed at the top of the strain pole next to the controller cabinet at NC 280 and Ray Hill Road.



**Figure 4.24** Installing the Access Point at NC 280 and Ray Hill Road

Figure 4.25 shows one of the repeaters that were positioned adjacent to the sensors in the pavement, atop a temporary pole that was installed for the project.

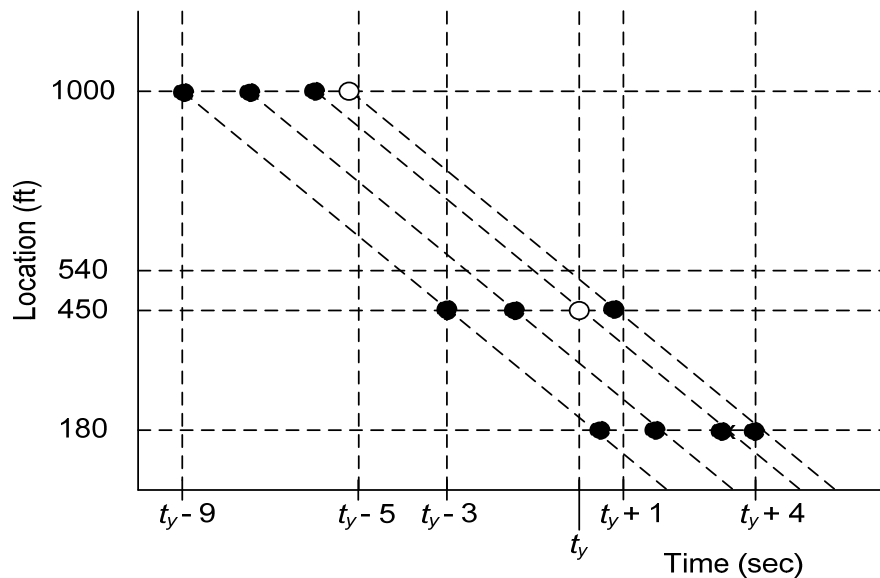


**Figure 4.25** A Repeater Installed Atop a Temporary Pole Adjacent to the Detectors

### 4.8 Field Study Results

The ultimate question for the project was this: can improved performance be achieved in the field? Can a better control strategy be found? In essence, the research team wanted to know if the NQ4 and D-CS control configurations performed better than the baseline volume-density control, and which one was “best”, with fewer vehicles in dilemma zones along with no increase in delays.

The strategy for answering these questions was as follows. The time-stamps from 1,000’, 450’, 180’, and 0’ were to be studied to see if there were differences between the control strategies in the number of vehicles caught in dilemma zones at the onset of yellow.



**Figure 4.26** Time Stamp Analysis

While it is important to recognize that the dilemma zone is defined in terms of time, not location, on these high-speed approaches, the vehicles are all traveling at about 65 mph, so the vehicles are about 180' upstream of the stop bar when they are 2 seconds away; at 450' when they are 5 seconds away, and at 540' when they are 6 seconds away. (At 1,000' they are about 11 seconds away.)

Ideally, as can be seen in Figure 4.26, one would like to look backwards in time to see how far away the vehicles were (in time) at  $t_y$ , the onset of yellow. As was done with the simulation analyses, this would involve checking the vehicle trajectories and ascertaining which vehicles were 2-6 seconds away at  $t_y$ . From videotapes, this can be done, but the analysis is labor intensive, and requires extensive field instrumentation. Another choice is to take a snapshot at  $t_y$  and count the number of vehicles that are 450' to 180' away from the stop bar. This is approximately the same as the number of vehicles that are 2 to 6 seconds away from the intersection.

The research team's original plan was to create the dilemma zone counts based on synthesized vehicle trajectories, stitched together from the time stamps at 1,000', 450', 180', and 0', but to date this has proved to be a significant challenge because of the sensitivity to the synchronization among the time stamps and the not-quite-complete condition of the time stamps collected.

A decision was reached to focus instead directly on the time stamps collected at the individual locations. Consequently, as shown in Figure 4.26, a VBA program was created to count the number of vehicles observed at 1,000', 450', and 180' in time windows corresponding to the 2-6 second time window in advance of  $t_y$ . For example, as Figure 4.26 shows, vehicles observed at 180' between  $t_y$  and  $t_y + 4$  are about 2-6 seconds upstream of the intersection. At 450', vehicles observed between  $t_y - 3$  and  $t_y + 1$  are about 2-6 seconds upstream of the stop bar at  $t_y$ . Similarly, at 1,000' vehicles observed between  $t_y - 9$  and  $t_y - 5$  are 2-6 seconds away at  $t_y$ . The research team decided to do these counts at 180', 450', and 1,000' to be assured that a correct assessment of performance was being obtained, in part because this compensated for time stamps that might have been missed. For example, in Figure 4.26, the open circle just shy of  $t_y - 5$  is intended to represent a vehicle missed, one for which a time stamp was not entered. Similarly, at 450' a second open circle is shown, indicating that another time stamp had been omitted. So in this instance, the counts at 1,000' and 450' would have been 3, while the count at 180' would have been 4. In the aggregate, since the data collection was quite good, no systematic biases were found among the locations. While individual vehicles might not have been recorded at each location at a specific point in time, in the aggregate, the results from the three locations are consistent and defensible.



**Table 4.6 NQ4 Field Results at Swift Creek (see footnote 13)**

N-Veh	At Ambers						At All Possible Times					
	Counts by Location			Percentages by Location			Counts by Location			Percentages by Location		
	1000'	450'	180'	1000'	450'	180'	1000'	450'	180'	1000'	450'	180'
0	90	82	90	83.3%	75.9%	83.3%	8781	8490	9045	66.3%	64.1%	68.3%
1	13	16	14	12.0%	14.8%	13.0%	2258	2542	2249	17.0%	19.2%	17.0%
2	3	9	4	2.8%	8.3%	3.7%	1254	1290	1215	9.5%	9.7%	9.2%
3	1	1	0	0.9%	0.9%	0.0%	554	603	503	4.2%	4.6%	3.8%
4	0	0	0	0.0%	0.0%	0.0%	291	225	186	2.2%	1.7%	1.4%
5	0	0	0	0.0%	0.0%	0.0%	63	76	35	0.5%	0.6%	0.3%
6	0	0	0	0.0%	0.0%	0.0%	33	18	12	0.2%	0.1%	0.1%
7	0	0	0	0.0%	0.0%	0.0%	3	2	2	0.0%	0.0%	0.0%
8	1	0	0	0.9%	0.0%	0.0%	7	1	0	0.1%	0.0%	0.0%
9	0	0	0	0.0%	0.0%	0.0%	0	0	0	0.0%	0.0%	0.0%
10	0	0	0	0.0%	0.0%	0.0%	3	0	0	0.0%	0.0%	0.0%
Total	108	108	108	100.0%	100.0%	100.0%	13247	13247	13247	100.0%	100.0%	100.0%

The westbound analysis at Swift Creek illustrates the results obtained. The approach was instrumented as shown previously in Figure 4.19. Data were collected for the NQ4 and D-CS control configurations (and not a base case) because NQ4 units were already installed at the site. Almost 3.7 hours of data were collected for the NQ4 configuration. The average cycle length was 95.4 seconds.<sup>15</sup> The 3.7 hours translates into 13,247 seconds of observations. In principle, at any one of the seconds, the yellow could have been invoked. If, as Table 4.6 shows, one of these times had been selected randomly, 65% of the time no vehicle would have been in a dilemma zone, 18% of the time there would have been one, and 9% of the time, two. In contrast, the NQ4 control algorithm elected to invoke 108 yellows during the 2.7 hours for which signal timing data were obtained<sup>16</sup>, and for 80% of those yellows, no vehicles in dilemma zones, for 13% there was one, and for 5% there were two. Clearly, the NQ4 configuration reduced the probability that one or more vehicles would be in a dilemma zone at the onset of yellow.

Table 4.7 shows the results for the D-CS configuration. About 3.9 hours of data were collected for this configuration, or 14,703 seconds. As before, any one of these seconds could, in principle, have been selected for a transition to yellow. In 61% of these instances, no vehicles would have been 2-6 seconds from the stop bar; in 20% more, there would have been one; and in 10% more, two. In contrast, the D-CS control strategy chose to invoke 184 yellows and for 84% of them, there were no vehicles in dilemma zones; for 10%, there was one; and for 4%, there were two. This is substantially better than selecting yellow times at random; and it is better than the NQ4 performance. In addition, the average cycle length was 77.3 seconds, 20 seconds shorter (about 19%) than the 95.4 seconds for the NQ4 control, so responsiveness was better and delays (if they could have been measured) were likely lower.

<sup>15</sup> In the case of the NQ4 configuration, signal timing data were collected only for 108 cycles during 2.9 hours while in the D-CS case signal timing data were collected during all 3.9 hours.

<sup>16</sup> Same as the previous footnote.

**Table 4.7 D-CS Field Results at Swift Creek**

N-Veh	At Ambers						At All Possible Times					
	Counts by Location			Percentages by Location			Counts by Location			Percentages by Location		
	1000'	450'	180'	1000'	450'	180'	1000'	450'	180'	1000'	450'	180'
0	150	155	160	81.5%	84.2%	87.0%	8963	9619	8646	61.0%	65.4%	58.8%
1	21	19	18	11.4%	10.3%	9.8%	3059	2779	3209	20.8%	18.9%	21.8%
2	9	6	6	4.9%	3.3%	3.3%	1532	1378	1753	10.4%	9.4%	11.9%
3	0	2	0	0.0%	1.1%	0.0%	711	642	746	4.8%	4.4%	5.1%
4	3	1	0	1.6%	0.5%	0.0%	301	203	278	2.0%	1.4%	1.9%
5	0	1	0	0.0%	0.5%	0.0%	102	68	54	0.7%	0.5%	0.4%
6	1	0	0	0.5%	0.0%	0.0%	32	11	14	0.2%	0.1%	0.1%
7	0	0	0	0.0%	0.0%	0.0%	2	3	3	0.0%	0.0%	0.0%
8	0	0	0	0.0%	0.0%	0.0%	1	0	0	0.0%	0.0%	0.0%
9	0	0	0	0.0%	0.0%	0.0%	0	0	0	0.0%	0.0%	0.0%
10	0	0	0	0.0%	0.0%	0.0%	0	0	0	0.0%	0.0%	0.0%
Total	184	184	184	100.0%	100.0%	100.0%	14703	14703	14703	100.0%	100.0%	100.0%

Table 4.8 summarizes the results for all six field tests that were performed. The first column shows the percentage of times that no vehicles were 2-6 seconds from the stop bar based on the observations at 180'. For example, in the base case (existing conditions) at US 17 southbound, 64.3% of the time no vehicles were 2-6 seconds from the stop bar. The actual times when yellows were invoked have the same characteristics: 62.7% of the time, no vehicles were present. In contrast, the NQ4 control configuration selected times when no vehicles were 2-6 seconds upstream of the yellow 77.1% of the time and the D-CS strategy increased that percentage to 91.8%. Moreover, while the base case average cycle length was 62.7 seconds, the NQ4 control strategy increased the cycle length to 147.9 seconds while the D-CS control strategy kept it constant at 66.6 seconds. Hence, the NQ4 and D-CS control strategies both improved safety, but the D-CS control strategy did it without sacrificing efficiency.

Another interesting observation is that the number of vehicles observed in the dilemma zone counts often decreases as one moves from 1,000' to 450' and 180'. Notice in Table 4.9 that in the case of the D-CS control strategy, this is almost always the case. For example, at Swift Creek, westbound, P(0), the probability of no vehicles being in a dilemma zone at the onset of yellow rises in the D-CS case from 81.5% to 84.2% and then 87.0%. It is always true for the D-CS cases if the P(0) estimate at 1,000' is compared with that from 180'. It is true in three of the nine cases that the 450' value also has to be increasing (i.e. maintaining a trend). The implications are twofold. First, once drivers see the yellow, they are taking actions to move themselves out of a dilemma zone as they approach the intersection, mainly by slowing down. Second, the rise in these values is most dramatic for the D-CS control strategies, slightly surpassing the NQ4 results, which means the D-CS strategy is performing best.

**Table 4.8 Field Results for All Sites**

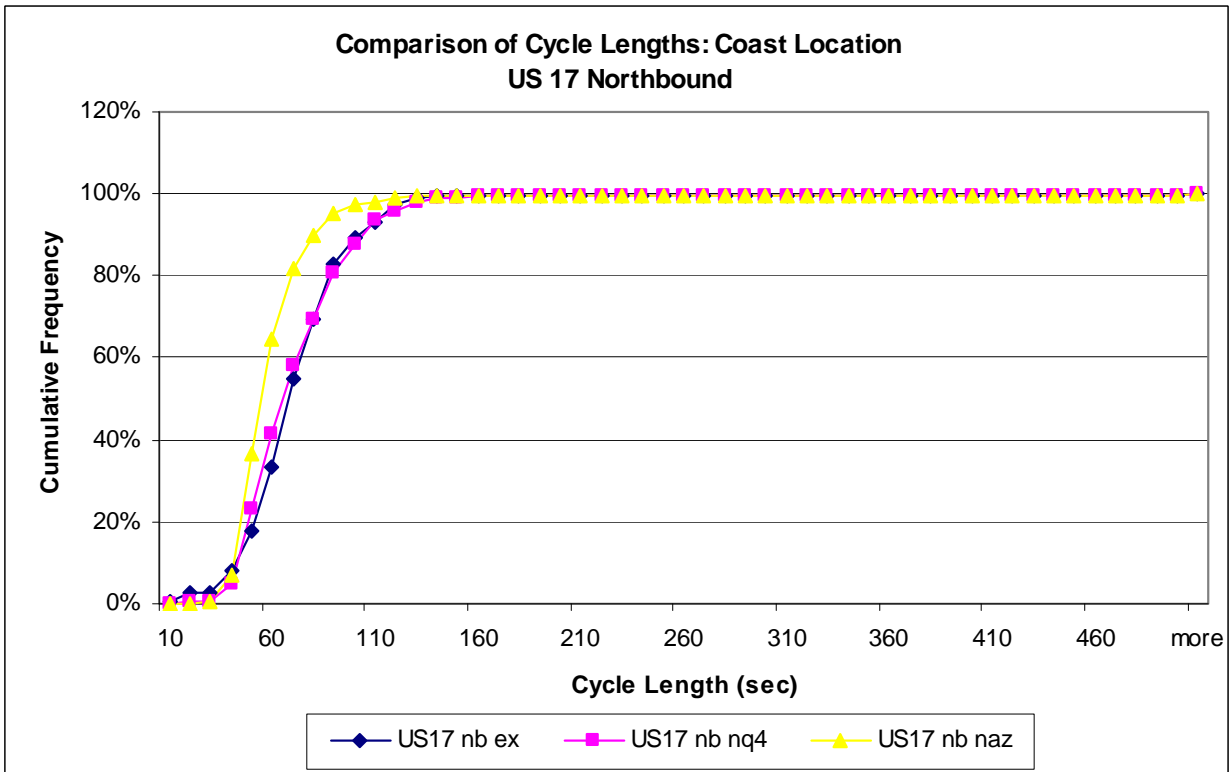
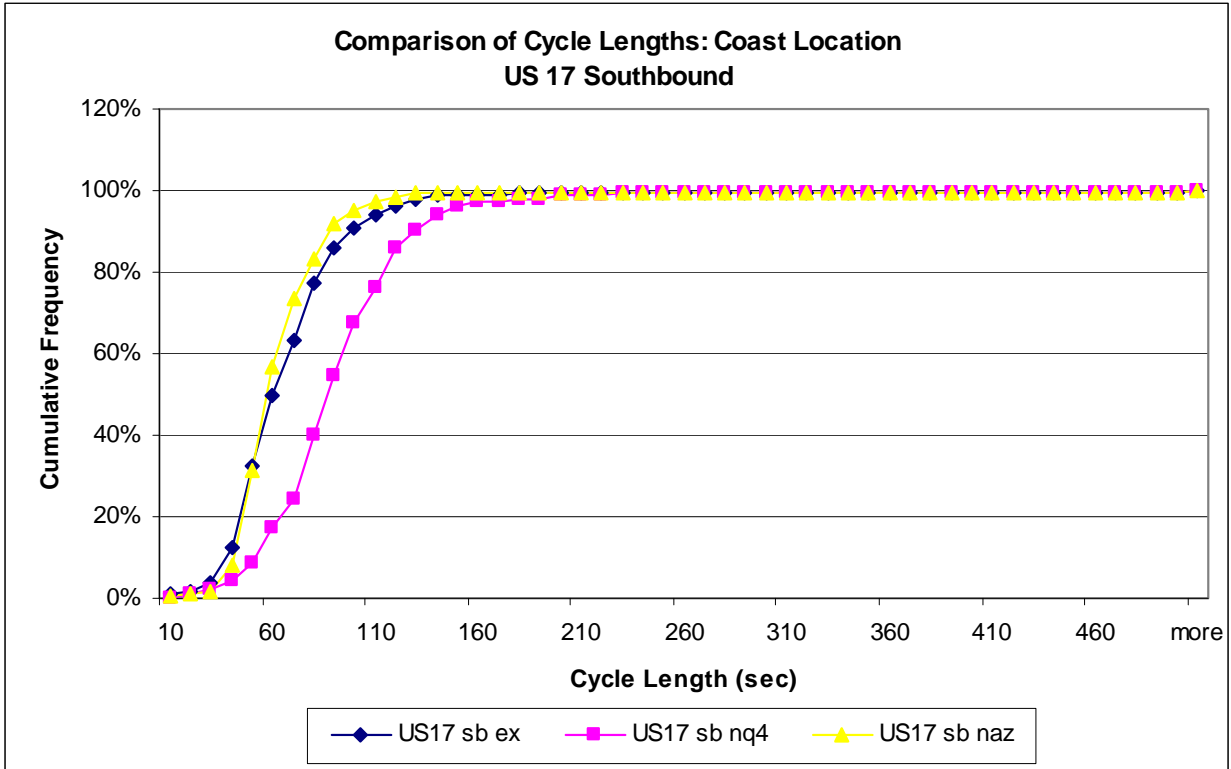
	All Vehicles - Cum Prob of being in DZ						AvgCyc (sec)
	CumProb(0)		CumProb(1)		CumProb(2)		
	Amber	Other	Amber	Other	Amber	Other	
Swift Creek - EB							
Base							
NQ4	69.3	42.5	22.0	30.7	7.1	17.2	78.7
D-CS	84.4	36.4	13.3	33.9	2.2	19.8	62.8
Swift Creek - WB							
Base							
NQ4	83.3	68.3	13.0	17.0	3.7	9.2	95.4
D-CS	87.0	58.8	9.8	21.8	3.3	11.9	77.3
NC-280 - EB							
Base	72.6	63.4	24.2	27.2	3.2	7.5	150.7
NQ4	72.1	59.7	14.4	23.3	10.8	10.3	125.8
D-CS	79.3	66.6	19.5	25.1	1.2	6.6	166.1
NC-280 - WB							
Base	49.4	56.3	41.4	25.7	8.0	11.3	182.8
NQ4	77.8	64.3	20.4	26.4	1.9	7.5	163.4
D-CS	84.5	60.8	12.6	23.2	1.9	10.2	154.2
US-17 - NB							
Base	87.2	53.9	10.6	27.2	2.1	12.9	68.0
NQ4	85.3	80.5	12.1	12.6	2.6	5.0	59.7
D-CS	83.8	47.4	15.1	33.1	1.1	14.2	56.9
US-17 - SB							
Base	62.7	64.3	31.3	27.2	6.0	7.0	62.7
NQ4	77.1	56.5	20.0	28.7	1.9	10.7	147.9
D-CS	91.8	55.7	7.7	28.8	0.4	10.9	66.6

**Table 4.9 Probabilities of No Vehicles in Dilemma Zones**

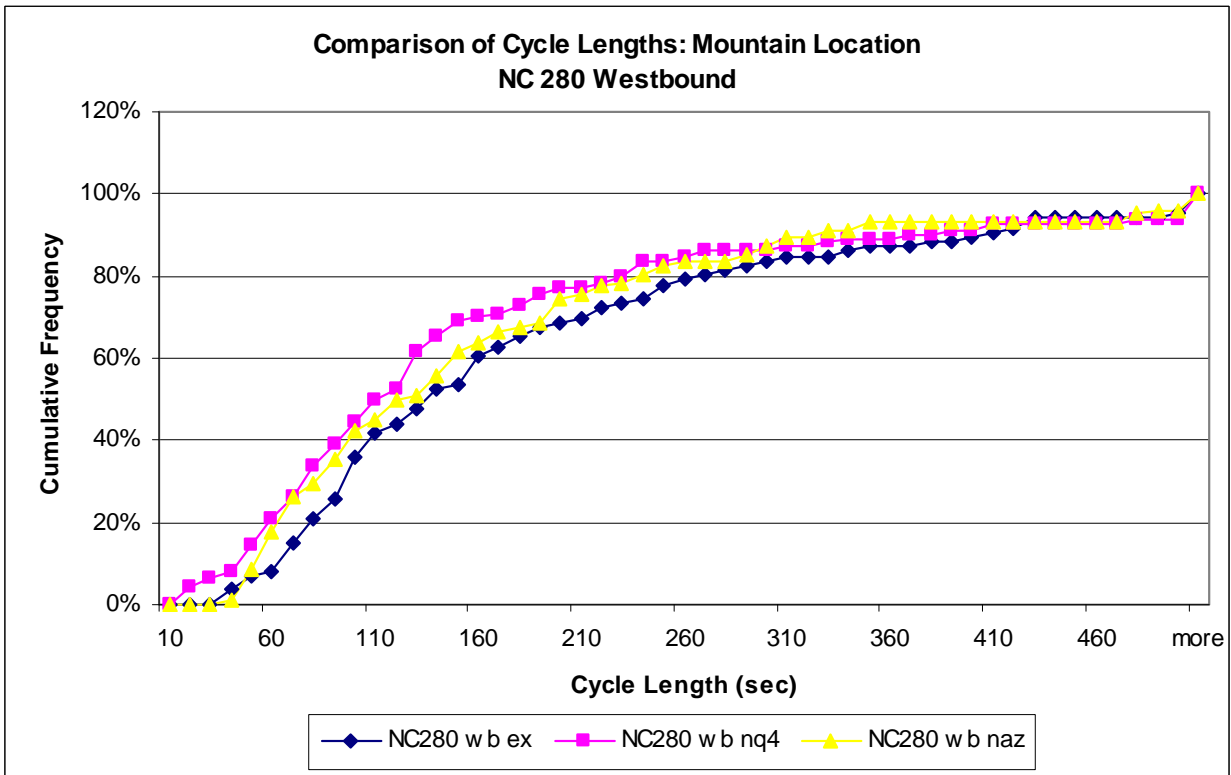
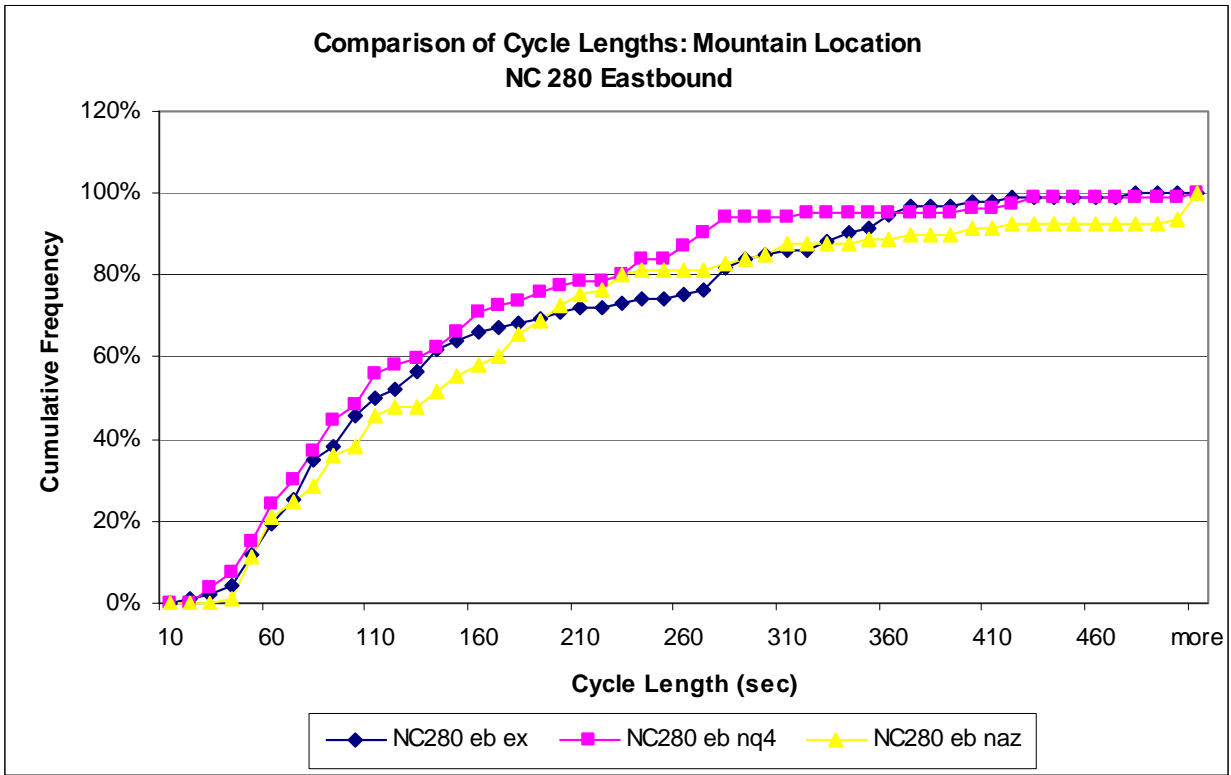
Probability of No Vehicles					
Intersection	Direction	Control	1000'	450'	180'
Swift Creek	WB	NQ4	83.3	75.9	83.3
		D-CS	<b>81.5</b>	<b>84.2</b>	<b>87.0</b>
	EB	NQ4	59.1	78.7	69.3
		D-CS	<b>76.3</b>	<b>74.8</b>	<b>84.4</b>
US-17	SB	Existing	73.0	77.8	62.7
		NQ4	60.0	66.7	77.1
		D-CS	<b>74.7</b>	<b>47.2</b>	<b>91.8</b>
	NB	Existing	58.5	51.6	87.2
		NQ4	81.9	66.8	85.3
		D-CS	<b>58.8</b>	<b>64.1</b>	<b>83.8</b>
NC-280	EB	Existing	66.3	67.4	72.6
		NQ4	57.7	64.9	72.1
		D-CS	<b>65.9</b>	<b>61.0</b>	<b>79.3</b>
	WB	Existing	65.5	66.7	49.4
		NQ4	67.6	69.4	89.8
		D-CS	<b>62.1</b>	<b>68.9</b>	<b>84.5</b>

Finally, while the incentive for exploring more advanced signal control strategies was principally safety, efficiency was also of interest, and an examination of signal cycle lengths provided insight into that issue.

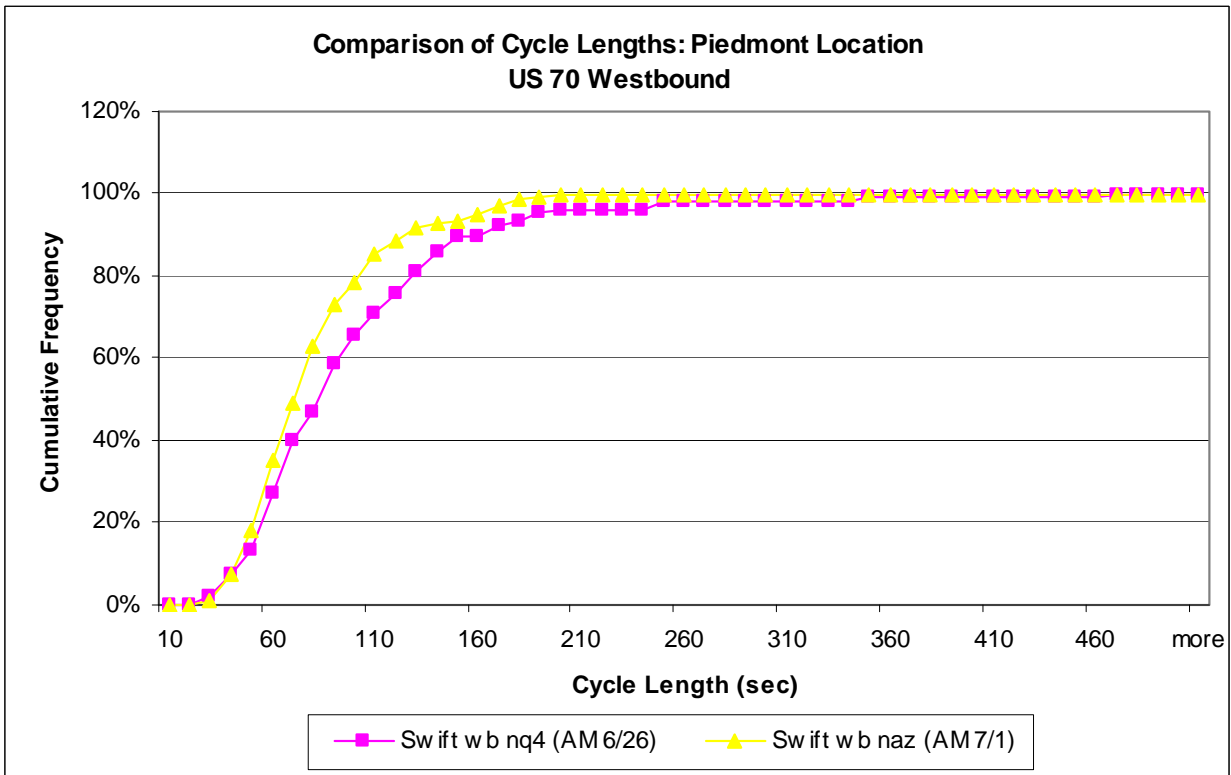
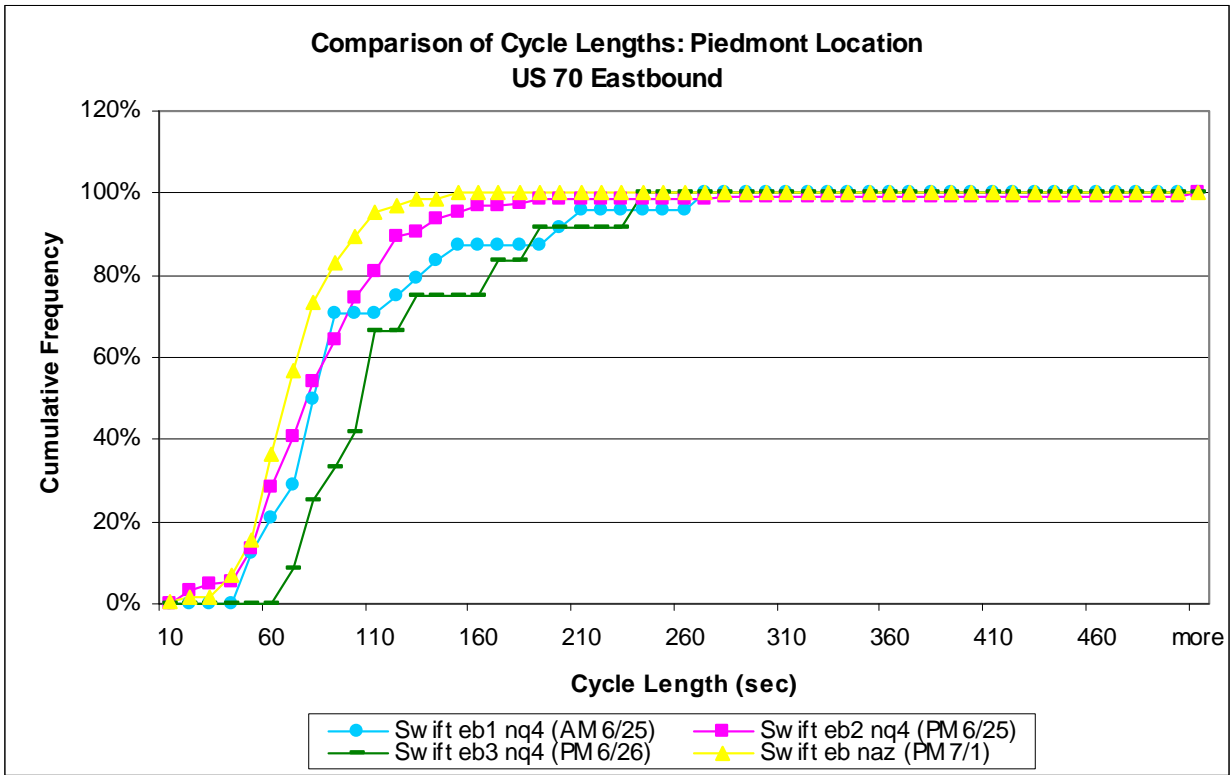
Figure 4.29 shows the cumulative density functions for cycle lengths for each of the sites and approaches studied in the field. A good outcome is that the curve is highest and furthest to the left. This means the cycle lengths for that control configuration are the shortest. Notice that in the case of US 17 southbound, the D-CS (naz) has the distribution that is highest and furthest left, slightly better than that for the NQ4. It is also the highest and furthest left for US 17 northbound, and in this case it is by itself. In the case of NC 280, both eastbound and westbound, the D-CS result is in the middle, performing on par with the NQ4 strategy. The reason the performance of the D-CS strategy is not more distinctively better is because the truck (and total) volumes at the NC 280 intersection are not that high. In the case of Swift Creek, either eastbound or westbound, the dominant performance of the D-CS control configuration is again apparent.



**Figure 4.27 Trends in Cycle Lengths at US 17**



**Figure 4.28 Trends in Cycle Lengths at NC 280**



**Figure 4.29 Trends in Cycle Lengths at US 70**

## **5. BENEFIT-COST ANALYSIS**

### **5.1 Introduction**

Intersection delay, queue length and number of stops are used as measures of effectiveness (MOEs) to assess the operational efficiency of urban and rural intersections. Inductive detection loop technology has been in use for decades to improve the operational efficiency of traffic at signalized intersections as well as to enhance intersection safety. One such method for the latter case is the placement of detection loops well in advance of an intersection to detect vehicles that may end up in dilemma zones closer to the intersection. In a dilemma zone condition, one solution is to extend the green signal time up to a limited extent. This allows a vehicle in a dilemma zone to cross the intersection safely without having to come to a complete stop.

More than 25 percent of crashes occur at signalized intersections. Rear-end collisions, angle collisions, left-turn collisions, right-turn collisions and sideswipe collisions are major crash collision types at intersections. On the other hand, speeding, failure to yield, failure to reduce speed, and driver distraction are the primary causes of these crashes. It is generally felt that installing detection loops improves both operational efficiency and safety at high speed / high traffic volume intersections. However, the literature documents limited to no research on the cost effectiveness of these treatments. This document outlines a cost benefit analysis of installing 1) Naztec TS2 cabinet with 2070 controller and D-CS software, and 2) Northstar Controls Model NQ4 long vehicle/speed system instead of basic Eagle 2070 controller at selected high speed rural intersections.

### **5.2 Background and Literature Review**

Loop detectors come in different sizes and shapes. Various configurations can be used depending on the area to be detected, the types of vehicles to be detected, and the objective (such as queue detection, vehicle counting, or speed measurements).

Most often, detection loops are used to detect vehicles on the approaches to intersections, or to detect queue vehicles in left-turn lanes at intersections. The loops, which are placed on the approaches to intersections, are typically located at or near the “dilemma zone” approaching the intersection. This is done in order to utilize the detection mechanism in an effective manner. Local jurisdictions or state departments of transportation (DOT) often adopt their own methods to determine the distance from the stop bar necessary for loop detector placement. These standards or methods are based on calculating dilemma zone distance, and thus loop detector placement distance, found in the “Manual on Traffic Signal Design” published by the Institute of Transportation Engineers.

Many of the costs associated with loop detectors are related to upfront costs such as start-up fees for installation and initial maintenance. If installed properly, loop detectors can avoid regular maintenance fees for at least as long as the pavement life. That being said, the importance of proper installation, whether during initial intersection construction or years after intersection existence, is very important in limiting costs and maximizing detector performance. Along the same lines, properly designing and locating “dilemma zone” detectors can reduce the need for future replacement, thus also reducing costs.

The advantages and disadvantages of detection loops are briefly summarized next.

## **Advantages of Detection Loops**

- Flexible design to satisfy a large variety of applications.
- Mature, well-understood technology.
- Large experience base.
- Provide basic traffic parameters (e.g., volume, presence, occupancy, speed, headway, and gap).
- Insensitive to inclement weather such as rain, fog, and snow.
- Provides best accuracy for count data as compared with other commonly used techniques.
- Common standard for obtaining accurate occupancy measurements.
- High frequency excitation models provide classification data.
- Reduce rear-end crashes approaching intersections and sometimes prevent other types of crashes within an intersection.
- Able to help maximize an intersection's efficiency by reducing delays and maximizing green times for the most predominant traffic movements.

## **Disadvantages of Detection Loops**

- Multiple detectors are usually required to monitor each lane of interest.
- Detection accuracy may decrease when design requires detection.
- If not placed at the proper distance, crash rate could be unaffected or even increase.
- If traffic volumes are high on all intersection approaches, maximization of green time on one leg (by way of loop detectors) may increase delay on other legs, thus hindering intersection efficiency.
- If the design speed of the intersection or corridor is changed, this will affect where dilemma zone detection must be placed.

Increased congestion (typical in suburban, high growth areas or at rural high speed / high volume intersections), increased free flow speeds, and increased heavy vehicle traffic can all lead to changes in dilemma zone locations and thus, effect operational and safety performance.

### **5.3 Study Task and Methodology**

Detection loops improves the operational and safety performances at intersections. From a safety perspective, detection loops reduces drivers' risk taking behavior and crashes by extending the green signal time. The primary objective of this study is to conduct cost benefit analysis of installing 1) Naztec TS2 cabinet with 2070 controller and DCS software, and 2) Northstar Controls Model NQ4 long vehicle/speed system instead of basic Eagle 2070 controller at selected high speed rural intersections. Analysis is also conducted to compare the two alternatives. It is done by considering crash costs, average delays and installation costs into consideration. The results from the study can be used by the decision makers to promote use of these units at high speed rural intersections to improve traffic operations and safety.



Five rural high speed intersections were selected to conduct cost benefit analysis and compare results from installing selected technologies at rural high speed intersections. They are:

1. US 19 and NC 141 intersection (Cherokee county)
2. NC 24 and NC 11 intersection (Duplin county)
3. NC 280 and SR 1422 intersection (Henderson county)
4. US 17 and NC 210 intersection (Pender county)
5. Swift Creek intersection (Johnston county)

An estimated percent reduction of crashes is applied to the five selected study intersections to assess the safety benefits of detection loops. The average delay due to detection loops at these intersections is estimated based on stopped delay outputs from VISSIM software simulations. A discussion on crash reduction factors, installation cost and delay cost is presented next.

### Crash Reduction Factors

Literature review documents no studies to quantify reduction in crashes due to installation of detector loops or technologies considered for analysis in this report. A marginal 10 percent reduction in crashes is assumed possible due to installation of technologies identified in this report.

Crash data for year's 2006, 2007 and 2008 are collected for the 5 selected study intersections from North Carolina Department of Transportation. The average number of crashes is taken into consideration. The equivalent unit crash cost is extracted for each county from North Carolina Department of Transportation Traffic Engineering and Safety Systems branch website (NCDOT, 2006) based on county in which the intersection is located. The annual crash cost for each study intersection is calculated using the equivalent unit crash cost for the county and the average number of crashes per year at the intersection. Savings in total crash cost per year due to assumed 10 percent reduction in average number of crashes were calculated. Savings in total crash cost per year were calculated to study how sensitive results are due to only a 5 percent reduction in the average number of crashes. The number of crashes, crash cost and savings based on both 5 percent and 10 percent crash reduction for all the 5 selected study intersections are shown in Table 5.1.

**Table 5.1 Estimated Crash Costs**

Location	# Crashes			Average # Crashes	Equivalent Unit Crash Cost (\$)	Annual Estimated Crash Cost (\$)	Annual Estimated Reduction in Crash Cost (\$)	
	2006	2007	2008				5%	10%
US 19 @ NC 141 (Cherokee)	1	3	2	2	71,761	143,521	7,176	14,352
NC 24 @ NC 11 (Duplin)	9	0	2	4	48,380	177,392	8,870	17,739
NC 280 @ SR 1422 (Henderson)	2	3	2	2	46,340	108,126	5,406	10,813
US 17 @ NC 210 (Pender)	1	2	1	1	45,339	60,453	3,023	6,045
Swift Creek (Johnston)	2	3	1	2	53,140	106,280	5,314	10,628

## Installation Costs

Installation costs for 1) Naztec TS2 cabinet with 2070 controller and D-CS software, and 2) Northstar Controls Model NQ4 long vehicle/speed system were obtained from North Carolina Department of Transportation. It can be seen that while the total installation cost for Naztec system at one intersection is \$25,930, the installation cost for NQ4 system at one intersection is \$28,200 (Table 5.2).

**Table 5.2 Installation Cost**

Description	Unit Price (\$)	Quantity	Total Cost (\$)
<b>Naztec TS2 Cabinet with 2070 Controller and DCS Software</b>			
Naztec TS2 cabinet with 2070 controller and DCS software	14,000	1	14,000
Labor to change out controller/cabinet assembly	1,500	1	1,500
Sensys access point	1,800	1	1,800
Sensys repeater	900	3	2,700
Sensys wireless detector	525	8	4,200
Ethernet cable / feet	1	100	80
Sensys contact closure card	600	1	600
Sensys extension card	350	3	1,050
<b>Total cost (\$)</b>			25,930
<b>Northstar Controls Model NQ4 Long Vehicle/Speed System</b>			
Eagle 2070 (loaded with Oasis software) with 332 cabinet	7,100	1	7,100
Northstar Controls model NQ4 Long Vehicle/Speed System with auxiliary cabinet (per approach)	1,900	2	3,800
Material and labor to install a quantity of (4) 6'x6' loops (per approach)	2,400	2	4,800
Material and labor for lead-in and trenching 1,000' (per approach)	5,500	2	11,000
Labor to change out controller/cabinet	1,500	1	1,500
<b>Total cost (\$)</b>			28,200

## Delay Cost

As stated, delays are obtained as outputs from VISSIM simulation software. These outputs are obtained for base case (2070), Naztec system and NQ4 system for several simulations. The outputs from the VISSIM simulations include average queue length, average stopped delay per vehicle, average number of stops per vehicle and maximum queue length. The average of average stopped delay per vehicle for several simulations based on different random seed numbers is taken into consideration for the cost benefit analysis. Table 5.3 shows average stopped delay during a peak hour by simulation run and average of these average stopped delay for each selected study intersection.

**Table 5.3 Average Stopped Delay per Vehicle by Intersection**

Random Seed #	US 19 @ NC 141 (Cherokee)	NC 24 @ NC 11 (Duplin)	NC 280 @ SR 1422 (Henderson)	US 17 @ NC 210 (Pender)	Swift Creek (Johnston)
<b>Eagle 2070 Controller</b>					
5	26.35	13.58	10.40	10.07	
10	38.33	12.59	8.16	7.77	
15	53.70	12.90	16.87	7.93	
20	41.24	13.91	8.87	9.40	
25	32.27	11.82	8.90	7.70	
30	45.75	13.29	9.14	8.78	
35	50.65	12.65	12.46	8.96	
40	23.07	12.91	14.47	7.21	
45		14.25	9.35	8.88	
50		14.05	13.17	9.16	
Average delay / vehicle (sec)	38.92	13.20	11.18	8.59	
<b>Naztec TS2 Cabinet with 2070 Controller and DCS Software</b>					
5		12.26	4.07	5.73	10.90
10		12.38	4.38	5.46	10.17
15		12.46	4.16	5.52	10.26
20		12.86	3.77	6.17	12.40
25		12.05	3.98	5.44	9.98
30		12.74	3.50	5.73	12.56
35		12.58	4.09	6.66	13.46
40		12.76	4.03	5.84	11.56
45		13.78	3.44	6.08	9.79
50		12.63	3.80	6.30	12.95
Average delay / vehicle (sec)		12.65	3.92	5.89	11.40
<b>Northstar Controls Model NQ4 Long Vehicle/Speed System</b>					
5	16.35	12.44	12.28	10.48	17.44
10	16.33	14.05	14.23	11.30	18.50
15	13.93	13.59	13.61	11.75	12.63
20	16.16	12.95	12.74	11.01	15.50
25	11.45	12.87	12.83	11.04	11.31
30	13.69	12.15	12.18	11.34	13.52
35	13.69	14.03	14.00	12.35	12.48
40	14.09	14.83	13.05	9.73	11.74
45	15.03	14.07	13.63	11.76	11.23
50	12.93	15.39	16.73	10.33	12.93
Average delay / vehicle (sec)	14.36	13.64	13.53	11.11	13.73

The delay is converted to an hourly cost value based on estimates obtained for North Carolina. This cost value \$8.70 /vehicle-hour in 1998 (Rister & Graves, 1999) was inflated using 1.3 percent as inflation rate (Inflation Calculator, 2009) to the present year hourly cost value and is equal to \$11.31 /vehicle-hour. Average daily traffic (ADT) is extracted for each selected study intersection from North Carolina Department of Transportation traffic survey maps (NCDOT, 2008). It is assumed that 70 percent of this traffic travels during peak hours at these intersections. Only estimated delay cost for this 70 percent of traffic during peak hours is considered in cost benefit analysis. Table 5.4 shows a comparison of change in delay cost per year for each selected intersection. The change in delay cost per year is computed to compare Naztec system with 2070 controller, NQ4 system with 2070 controller, and NQ4 system with Naztec system.

**Table 5.4 Annual Change in Delay Cost**

Location	ADT	Annual Delay Cost (\$)		
<b>Comparison between 2070 Controller and Naztec System</b>		<b>2070 Controller</b>	<b>Naztec</b>	<b>2070 - Naztec</b>
US 19 @ NC 141 (Cherokee)	13,000	406,129	0	406,129
NC 24 @ NC 11 (Duplin)	8,900	94,269	90,369	3,900
NC 280 @ SR 1422 (Henderson)	13,000	116,651	40,932	75,719
US 17 @ NC 210 (Pender)	15,400	106,132	72,853	33,279
Swift Creek (Johnston)	24,800		227,008	
<b>Comparison between 2070 Controller and NQ4 System</b>		<b>2070 Controller</b>	<b>NQ4</b>	<b>2070 - NQ4</b>
US 19 @ NC 141 (Cherokee)	13,000	406,129	149,877	256,251
NC 24 @ NC 11 (Duplin)	8,900	94,269	97,412	-3,144
NC 280 @ SR 1422 (Henderson)	13,000	116,651	141,163	-24,512
US 17 @ NC 210 (Pender)	15,400	106,132	137,311	-31,179
Swift Creek (Johnston)	24,800		273,307	
<b>Comparison between Naztec and NQ4 System</b>		<b>Naztec</b>	<b>NQ4</b>	<b>Naztec - NQ4</b>
US 19 @ NC 141 (Cherokee)	13,000	0	149,877	-149,877
NC 24 @ NC 11 (Duplin)	8,900	90,369	97,412	-7,044
NC 280 @ SR 1422 (Henderson)	13,000	40,932	141,163	-100,231
US 17 @ NC 210 (Pender)	15,400	72,853	137,311	-64,458
Swift Creek (Johnston)	24,800	227,008	273,307	-46,299

### 5.4 Results and Discussion

Cost benefit analysis was conducted to study if installation of the new technology (Naztec or NQ4 system) would yield operational and safety benefits. All costs were converted to their annual worth equivalents for analysis. It is assumed that the life of these systems is 15 years. Swift Creek intersection in Johnston County was not considered for comparison with Naztec and NQ4 system in Tables 5.5 and 5.6 as the intersection did not have 2070 controller as a base case.

Table 5.5 shows results from cost benefit analysis comparing use of Naztec system to 2070 controller. It can be seen from the table that operational and safety benefits would be high when 2070 controllers are replaced with Naztec system at the 4 selected study intersections. Benefits are possible with even a 5 percent reduction in crashes at these intersections. In general, estimated benefits are very high at US 19 @ NC 141 rural intersection in Cherokee County.

**Table 5.5 Use of Naztec System when Compared to a 2070 Controller**

Location	Annual Reduction in Crash Cost (\$)	Annual Change in Delay Cost (\$)	Annual Value of Equipment and Installation Cost (\$)	B/C Ratio	Economically Feasible (Yes / No)
<b>5% reduction in crashes</b>					
US 19 @ NC 141 (Cherokee)	7,176	406,129	2,498	165.4	Yes
NC 24 @ NC 11 (Duplin)	8,870	3,900	2,498	5.1	Yes
NC 280 @ SR 1422 (Henderson)	5,406	75,719	2,498	32.5	Yes
US 17 @ NC 210 (Pender)	3,023	33,279	2,498	14.5	Yes
<b>10% reduction in crashes</b>					
US 19 @ NC 141 (Cherokee)	14,352	406,129	2,498	168.3	Yes
NC 24 @ NC 11 (Duplin)	17,739	3,900	2,498	8.7	Yes
NC 280 @ SR 1422 (Henderson)	10,813	75,719	2,498	34.6	Yes
US 17 @ NC 210 (Pender)	6,045	33,279	2,498	15.7	Yes

Table 5.6 shows results from cost benefit analysis comparing use of NQ4 system to 2070 controller. It can be seen from the table that operational and safety benefits were observed at only 2 out of the 4 selected study intersections. The system tends to increase delays at 2 selected study intersections resulting in a benefit to cost (B/C) ratio lower than 1 at these intersection. As in the previous case, benefits are very high at US 19 @ NC 141 rural intersection in Cherokee County.

**Table 5.6 Use of NQ4 System when Compared to a 2070 Controller**

Location	Annual Reduction in Crash Cost (\$)	Annual Change in Delay Cost (\$)	Annual Value of Equipment and Installation Cost (\$)	B/C Ratio	Economically Feasible (Yes / No)
<b>5% reduction in crashes</b>					
US 19 @ NC 141 (Cherokee)	7,176	256,251	2,717	97.0	Yes
NC 24 @ NC 11 (Duplin)	8,870	-3,144	2,717	2.1	Yes
NC 280 @ SR 1422 (Henderson)	5,406	-24,512	2,717	-7.0	No
US 17 @ NC 210 (Pender)	3,023	-31,179	2,717	-10.4	No
<b>10% reduction in crashes</b>					
US 19 @ NC 141 (Cherokee)	14,352	256,251	2,717	99.6	Yes
NC 24 @ NC 11 (Duplin)	17,739	-3,144	2,717	5.4	Yes
NC 280 @ SR 1422 (Henderson)	10,813	-24,512	2,717	-5.0	No
US 17 @ NC 210 (Pender)	6,045	-31,179	2,717	-9.3	No

Table 5.7 shows possible benefits or disbenefits due to use of NQ4 system instead of Naztec system. Savings in crash cost were not considered as the basic assumption is that both Naztec and NQ4 would yield similar possible reduction in crash costs. Thus, only change in delay cost is used in cost benefits analysis for this case. Results from analysis at all 5 selected study intersections showed that delay cost will be high if NQ4 is used instead of Naztec system.

**Table 5.7 Use of NQ4 System when Compared to Naztec System**

Location	Annual Reduction in Crash Cost (\$)	Annual Change in Delay Cost (\$)	Annual Value of Equipment and Installation Cost (\$)	B/C Ratio	Economically Feasible (Yes / No)
US 19 @ NC 141 (Cherokee)	-	-149,877	219	-685.3	No
NC 24 @ NC 11 (Duplin)	-	-7,044	219	-32.2	No
NC 280 @ SR 1422 (Henderson)	-	-100,231	219	-458.3	No
US 17 @ NC 210 (Pender)	-	-64,458	219	-294.7	No
Swift Creek (Johnston)	-	-46,299	219	-211.7	No

### 5.5 Summary

Observations based on cost benefit analysis showed that benefits are high at all 5 rural high speed intersections when Naztec system was tested. Thus, it can be concluded that Naztec system would yield better operational and safety benefits than NQ4 system or 2070 controller (base case). On the other hand, use of NQ4 only yielded better benefits than 2070 controller at 2 out of the considered 4 rural high speed intersections.

## 6. CONCLUSIONS AND RECOMMENDATIONS

Several conclusions can be drawn from this research project. The first is that NCDOT is at or near the forefront of signal control strategies for high-speed rural intersections. During the literature review, a comprehensive assessment of signal control techniques and technologies was conducted. The research team found that few states have a signal design practice that is as well documented as NCDOT's and the procedures in use are at the frontier of best practice.

The second conclusion is that the NQ4 strategy currently employed works fairly well in the field. NCDOT can do better, but the practice provides good solutions, certainly better than just using volume-density control, based both on the field tests performed as well as the simulation experiments. The drawbacks to the NQ4 system are that it does not actually find times when no vehicles are in dilemma zones, which the D-CS control strategy does, it does not directly take into account vehicle speed in computing the main street hold time it conveys to the controller, it tends to lengthen the distribution of cycle lengths which means efficiency suffers (a disadvantage the D-CS system does not have) and it is a bit cumbersome and expensive to install. AC power must be brought to a cabinet adjacent to the loops and an AC signal must be brought back to the controller cabinet.

The third conclusion is that the D-CS control strategy developed by Bonneson *et al.* (1997) consistently works very well. In almost all of the field tests and in all of the traffic simulation model runs, it performed the best. In the simulation tests, it dramatically reduced the number of vehicles that were trapped in dilemma zones at the onset of yellow and a similar trend was discerned in the field. It made the intersections quieter; less mainline traffic was brought to an unexpected stop. It shortened the side street queues, shortened the cycle length, and made the signal more responsive to minor movement calls.

The benefit-cost analysis suggests that using the D-CS control system would be the most useful action for NCDOT to pursue. It yields the highest benefit/cost ratios and consistently outperforms the existing, unenhanced control and the NQ4 system.

Another conclusion is that wireless sensors can be an effective and efficient way to add detectors to a signalized intersection. This finding was not an original intent of the project, but to create the D-CS control configuration, the research team had to find a way to quickly create speed traps about 1,000' upstream of the stop bar on both mainline approaches. Expecting the divisions to install hardwire connections was clearly unreasonable. The benefit-cost assessments demonstrate, indirectly, that this is true when the cost of an NQ4 installation (which is assumed to use standard loops) is compared with the D-CS option (which is cost out based on wireless detectors). The wireless detectors were simple, easy, and quick to install. Setting up the repeaters and access point was easy. Getting the detectors to work reliably at 1,000' was no problem. The only challenge encountered was calibration. The wireless sensors sometimes had difficulty detecting long trucks, especially tank trucks whose carriage involves very little steel and it is high above the road surface. In all six locations where the control strategies were tested, only a few hours were required to install the eight wireless sensors, the repeaters (one or two depending on which approach was involved), and the access point. The field crews enjoyed participating, thought the technology had great promise and were eager to see NCDOT make it possible to purchase and install the equipment. These comments from the field crews were encouraging,

especially since NCDOT is in the process of evaluating wireless detection technology to make it a viable tool when loops are impractical.

Another discovery, again unexpected, was that it is possible to do “cabinet-in-the-loop” simulation as well as the more traditional “hardware-in-the-loop”. This was discovered because, to make the D-CS control strategy work, the Naztec controller needed to see the detector inputs coming through the bus interface units from the detector racks. Passing this information directly to the controller from the controller interface device was not possible. In this project, the cabinet-in-the-loop configuration was obtained by using a TS-2 wiring harness to connect the CID to the low voltage terminals in the controller cabinet. The solution worked very well.

One more conclusion was that measuring speeds accurately is important. At the cruise speed (say 60+ mph) on the roads involved in the study, the time elapsed between the two speed trap loops 20’ apart is measured in milliseconds. The sensors have to be polled very frequently to get accurate estimates of the speeds. In the field, this was not such a significant problem because the clock speeds on the controller and the detector interface cards are very fast. However, getting accurate speeds in the simulation runs is problematic because the state of the system is updated only every 0.1 seconds (100 milliseconds). That means less than two time steps are required to traverse the 20’ speed trap. Hence, only certain speeds will ever be reported out (distance/0.1 second; distance/0.2 seconds, and so forth), not the continuum of possibilities.



## **7. IMPLEMENTATION AND TECHNOLOGY TRANSFER PLAN**

The Transportation Mobility and Safety Division is the unit within NCDOT that is most likely to benefit from the results of this research. It can take advantage of the new signal control treatment we have shown can improve the safety performance of high-speed rural intersections without compromising efficiency. This Detector-Control System (D-CS) is a combination of sensor placements and signal control created by Bonneson *et al.* (2002).<sup>17</sup> It performs better than the current NQ4-based treatment that NCDOT uses; and it has a higher benefit-to-cost ratio.

The Division should pay to have D-CS incorporated into OASIS.<sup>18</sup> In the short run, it might also want to allow the purchase of Naztec controllers for situations where D-CS can help because the Naztec controllers have D-CS as a built-in special feature.

The Division might also want to allow the purchase of wireless sensors like those we used from Sensys Networks, Inc. so that advance detection speed traps can be created at less expense and with greater ease than the land-line, loop-based configurations now being utilized. Recognizing that NCDOT is currently evaluating wireless detector technology, the team offers the following insights. We demonstrated that the wireless sensors can work quite well and provide the sensor data needed; they were easy and quick to install; and they were well-liked by the field crews that helped install them.

If these recommendations are followed, NCDOT also ought to:

- Be trained in and become familiar with D-CS.
- Identify a few people who should be trained in and become familiar with the Naztec controllers so the D-CS system can be implemented where needed until a point in time when OASIS incorporates D-CS. Have these people be able to train and assist the field crews who install the controllers.
- Assuming D-CS is incorporated into OASIS, train the local traffic signal crews about how to use D-CS in the field and how to create the advance detection needed to give it the necessary data.
- If the use of wireless sensors is allowed, train the field crews how to install the sensors and incorporate them into the operation of signals, for advance detection and other purposes as deemed appropriate.

---

<sup>17</sup> An easy-to-find reference is Zimmerman, K., and J.A. Bonneson. "Improving Intersection Safety with an Innovative Collision Avoidance System," *ITE Journal*, February 2007, pp. 24-29.

<sup>18</sup> The D-CS software is in the public domain, so this effort would be a matter of integrating the D-CS software into OASIS, as Naztec has already done for their controller, not a matter of creating the software from scratch.

## 8. REFERENCES

1. Agent, K.R. "Traffic Control and Accidents at Rural High-Speed Intersections," *Transportation Research Record 1160*, pp. 14-21, 1988.
2. Al-Mudhaffar, A. "Improving Incident Reduction Function Used in the LHOVRA Technique", *Proceedings of the Ninth Congress on ITS*, Chicago, IL, October 14-17, 2002.
3. Baquley, J. "Running the Red at Signals on High-Speed Roads," *Traffic Engineering and Control*, 29:7-8, pp 415-420, July 8, 1988.
4. Barricklow, P.A., and M.S. Jacobson. *Guidelines for the Use of Countermeasures to Reduce Crashes on Approaches to Signalized Intersections Near Vertical Curves*, Report FHWA/TX-05/0-4084-PI, prepared for Texas DOT, September, 2004.
5. Bonneson J.A., and P.T. McCoy. "Average Duration and Performance of Actuated Signal Phases, *Transportation Research-Part A*, 29:6, pp. 429-443, 1995.
6. Bonneson, J.A. and P.T. McCoy. *Manual of Traffic Detector Design, Second Edition*, Institute of Transportation Engineers, Washington, D.C., May 2005.
7. Bonneson, J.A., D. Middleton, K. Zimmerman, H. Charara, and M. Abbas. *Intelligent Detection-Control System for Rural Signalized Intersections*, Report Number FHWA/TX-03/4022-2, Prepared for Texas DOT, August 2002.
8. Charton, S.G. "Restricting Intersection Visibility to Reduce Approach Speeds," *Accident Analysis and Prevention*, 35:5, pp. 817-823, September 2003.
9. Cribbins, P.D., and C.M. Walton. "Traffic Signals and Overhead Flashers at Rural Intersections: Their Effectiveness in Reducing Accidents," *Highway Research Record 325*, pp. 1-14, 1970.
10. Datta, T.K., K. Schattler, and S. Datta. "Red Light Violations and Crashes at Urban Intersections," *Transportation Research Record 1734*, pp. 52-58, 2000.
11. Easa, S.M. "Reliability-based Design of Intergreen Interval at Traffic Signals," *Journal of Transportation Engineering*, 119:2, pp 255-271, Mar-Apr, 1993.
12. Gibby, A.R., S.P. Washington, and T.C. Ferrara. "Evaluation of High-Speed Isolated Signalized Intersections in California," *Transportation Research Record 1376*, pp. 45-56, 1992.
13. Huang, X.P., and P.D. Pant. "Simulation-Neural Network Model for Evaluating Dilemma Zone Problems at High-Speed Signalized Intersections," *Transportation Research Record 1456*, pp. 34-42, 1994.
14. Johnston, D. "IMSA Traffic Signals: Another Method of Dilemma Zone Protection," *IMSA Journal*, 39:4, pp. 44-46, 2001.
15. Keith, R.J., J.T. Tindall, and S.T. Yan, "Performance and Characteristics of Magnetic Loop Vehicle Detector," *Australian Road Research Board - Proceedings*, 2:1, pp 366-387, 1964.

16. Liu, O., R. Herman, and D.C. Gazis. "Review of the Yellow Interval Dilemma," *Transportation Research – Part A*, 30:5, pp. 333-348, September 1996.
17. Martin, P.T, Y. Feng, and X. Wang. *Detector Placement Evaluation*, Report prepared for the Mountain Plains Consortium and the Utah DOT, November 2003.
18. McCoy, P.T., and G. Peste. "Dilemma Zone Protection on High-Speed Signalized Intersection Approaches: Advance Detection Versus Advance Warning Flashers and Advance Detection," *Proceedings of the 82<sup>nd</sup> Transportation Research Board Annual Meeting* (on CD), Washington, D.C., January 2003.
19. Messer, C.J., S.R. Sunkari, H.A. Charara, and R.T. Parker. *Development of Advance Warning Systems for End-of-Green Phase at High Speed Traffic Signals*, Report Number FHWA/TX-04/0-4260-4, Prepared for Texas DOT, September 2003.
20. Middleton, D., R. L. Nowlin, M. Shafer, A. H. Parham, and D. Jasek. *Evaluation of Detector Placement for High-Speed Approaches to Signalized Intersections*, Report Number 7-3977-1, Prepared for Texas DOT, September 1997.
21. Middleton, D., and R. Parker. *Vehicle Detector Evaluation*, Report No FHWA/TX-03/2119-1, prepared for Texas DOT, October 2002.
22. Middleton, D., and R. Parker. *Vehicle Detector Evaluation*, Report 2119-1, Prepared for Texas DOT, 2003.
23. Moon, J, J. Lee, and Y. Park. "System Integration and Field Tests for Developing In-vehicle Dilemma Zone Warning System," *Transportation Research Record 1826*, pp. 53-59, 2003.
24. Pant, P.D., Y. Cheng, A. Rajagopal, and N. Kashayi. *Field Testing and Implementation of Dilemma Zone Protection and Signal Coordination at Closely-Spaced High-Speed Intersections*, Report Number FHWA/OH-2005/006, Prepared for Ohio DOT, May 2005.
25. Parsonson, P. "Signalization of High-Speed, Isolated Intersections," *Transportation Research Record 681*, pp. 34-42, 1978.
26. Quiros, L., and B. Shaver. *Rural Road Links: A Review on Current Research Projects & Initiatives Aimed at Reducing Vehicle Crash Fatalities on Rural Roads*, Report UCB-TSC-TR-2003-10, 2003.
27. Rhodes, A., D.M. Bullock, J. Sturdevant, Z. Clark, and D.G. Candey, Jr. "Evaluation of the Accuracy of Stop Bar Video Vehicle Detection at Signalized Intersections," *Transportation Research Record 1925*, pp. 134-145, 2005.
28. Sabra, Z.A. *Driver Response in Active Advance Warning Signs at High-Speed Signalized Intersections*. Report FHWA/RD-86/130, October 1985.
29. Saito, T., N. Ooyama, and K. Sigeta. "Dilemma and Option Zones, the Problem and Countermeasures. Characteristics of zones, and a new strategy of signal control for minimizing zones," *Proceedings of the Third International Conference on Road Traffic Control*, London, England, May 1-3 1990.
30. Seong, Y., D. Mountjoy, and Y. Park. "Defining the Decision Zone Considering a Multitude of Environmental Factors," *Proceedings of the 2005 IIE Annual Conference and Exposition*, Atlanta, GA, May 14-18, 2005.

31. Shaflik, C. "Traffic Signal Detector Locations: Proper Positioning Increases Efficiency and Safety," *Technical Paper for CIVL 589*, University of British Columbia, December 1995.
32. Sheffi, Y., and H. Mahmassani. "Model of Driver Behavior at High-Speed Signalized Intersections," *Transportation Science*, 15:1, pp. 50-61, February 1981.
33. Si, J., T. Urbanik, and L.D. Han. "Effectiveness of Alternative Detector Configurations for Option Zone Protection on High-Speed Approaches to Traffic Signals," *Proceedings of the 86<sup>th</sup> Transportation Research Board Annual Meeting* (on CD), Washington, D.C., January 2007.
34. Smith, T.J., C. Hammond, and M. Wade. *Investigating the Effect on Driver Performance of Advanced Warning Flashers at Signalized Intersections*. Report No. 2002-05, prepared for Minnesota DOT, 2002.
35. Srinivas, P., D.M. Bullock, and A. Sharma. "Limitations of Simultaneous Gap Out Logic," *Proceedings of the 85<sup>th</sup> Transportation Research Board Annual Meeting* (on CD), 2006.
36. Sunkari, S.R., C.J. Messer, R.T. Parker, and H.A. Charara. *Signal Technician's Installation and Maintenance Manual for Advance Warning of End-of-Green Phase at High Speed Traffic Signals*, Report Number FHWA/TX-04/0-4260-3, Prepared for Texas DOT, September 2003.
37. Wade, A.R., Z. Parsegian, and T.J. Rosenthal. "Simulation Evaluation of Road Signs and Signals," *Proceedings of the Human Factors and Ergonomics Society*, Vol. 2, pp. 903-906, 1994.
38. Wang, J., Z. Wang, and W. Deng. "Dilemma Zone Research with Regard to Red Light Running," *Journal of Xi'an Jiao Tong University*, 39:2, pp. 205-209, February 2005.
39. Woods, D.L., and L.M. Koniki. *Optimizing Detector Placement for High-Speed Isolated Signalized Intersections using Vehicular Delay as the Criterion*, Report Number 1392-3, Prepared for Texas DOT, 1994.
40. York, L., and M. Alkatib. "Methods of Traffic Signal Control and Signal Timings at High Speed Sites," *IEE Conference Publication Number 472*, p 167-171, 2000.
41. Zegeer, C.V. and R.C. Deen. "Green-Extension Systems at High-Speed Intersections." *ITE Journal*, Institute of Transportation Engineers, Washington, D.C., November 1978, pp. 19-24.
42. Zimmerman, K., and J.A. Bonneson. *In-Service Evaluation of a Detection-Control System for High-Speed Signalized Intersections*, Report Number FHWA/TX-05/5-4022-01-1, Prepared for Texas DOT, August 2005.
43. Zimmerman, K., and J.A. Bonneson. "Improving Intersection Safety with an Innovative Collision Avoidance System," *ITE Journal*, February 2007, pp. 24-29.
44. American Association of State Highway and Transportation Officials (ASHTO). *A Policy on Geometric Design of Highways and Streets*, 5<sup>th</sup> Edition, Washington, DC, 2004.
45. California DOT. *Traffic Manual, Chapter 9 – Traffic Signals and Lighting*, 9hq/traffops/signtech/signdel/trafficmanual-current.htm, November 2002.
46. California DOT. *California Manual on Uniform Traffic Control Devices, Part 4 – Highway Traffic Signals*,

- <http://www.dot.ca.gov/hq/traffops/signtech/mutcdsupp/pdf/camutcd/ CAMUTCD-Part4.pdf>, September 20, 2006.
47. Federal Highway Administration (FHWA). *Truck Characteristics for Use in Highway Design and Operation*. Report FHWA-RD-89-226, August 1990.
  48. Georgia DOT. *Traffic Signal Design Guidelines*, <http://www.dot.state.ga.us/dot/operations/traffic-safety-design/Documents/PDF/1.%20Traffic%20Signal%20Design%20Guidelines.pdf>, November 2003.
  49. Hummer, J.E., R. Stephenson, and D. Carter. *Highway Safety Program Evaluation and Statistical Crash Table Development*, Report Number FHWA/NC/2002-021, prepared for the Traffic Safety Systems Management Unit, NCDOT, July 8, 2000.
  50. Inflation Calculator Homepage. <http://data.bls.gov/cgi-bin/cpicalc.pl>, Accessed September 3, 2009.
  51. Kell, J.H., I.J. Fullerton, and M.K. Mills. *Traffic Detector Handbook*, Report Number FHWA-IP-90-002, prepared for FHWA, July 1990.
  52. Minnesota DOT. *Traffic Signal Timing and Coordination Manual*, <http://www.dot.state.mn.us/trafficeng/signaloperations/2005TrafficSignalTimingandCoordinationManual.pdf>, March 2005.
  53. Minnesota DOT. *Signal Design Manual, Chapter 4 – Detection*, <http://www.dot.state.mn.us/trafficeng/signaldesign/index.html>, 2006.
  54. North Carolina DOT. *ITS and Signals Unit Design Manual*, <http://www.ncdot.org/doh/preconstruct/traffic/itss/ws/manual.html>, 2005.
  55. North Carolina DOT. *Crash Report Form DMV 349*, <http://www.ncdot.org/doh/preconstruct/traffic/tepp/Apr04.pdf>, January 1, 2000.
  56. North Carolina DOT Traffic Engineering & Safety Systems Branch Website. <http://ncdot.org/doh/preconstruct/traffic/safety/data/profiles/County2006.pdf>, Accessed August 30, 2009.
  57. North Carolina DOT Traffic Survey Maps. [http://www.ncdot.org/doh/preconstruct/tpb/traffic\\_survey/](http://www.ncdot.org/doh/preconstruct/tpb/traffic_survey/), Accessed September 3, 2009.
  58. Ohio DOT. *Traffic Engineering Manual, Part 4 - Signals, Chapter 400 - Traffic Signals*, <http://www.dot.state.oh.us/traffic/Publication%20Manuals/TEM/TEM.htm>, January 19, 2007.
  59. Rister, Brad W. and Clark Graves. *The Cost of Construction Delays and Traffic Control for Life-cycle Cost Analysis of Pavements*. Research report KTC-02-07/SPR197-99 & SPR218-00-1F, Kentucky Transportation Center.
  60. South Carolina DOT. *Highway Design Manual, Chapter 400 - Intersections at Grade*, <http://www.scdot.org/doing/preconstruction.shtml>, September 1, 2006.
  61. South Carolina DOT. *Traffic Signal Design Guidelines, Chapter 6 - Stop and Go Signal Design*, 2003.

62. Virginia DOT. *Traffic Engineering Design Manual, Section IV – Traffic Signals, Chapter 2 – Engineering Concepts/Guidelines*, <http://www.virginiadot.org/business/locdes/traffic-engineering-manual.asp>, and *Chapter 4 – Plan Development*, <http://www.virginiadot.org/business/locdes/traffic-engineering-manual.asp>, 2006.