



GeoMaterials Group **Aggregate Quality Control/ Quality Assurance Program**



January 2, 2024

**A joint effort of the
North Carolina Department of Transportation
and the
North Carolina Aggregates Association**

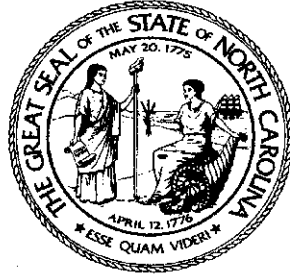

Aggregate Quality Control/Quality Assurance Program

January 2, 2024

**A joint effort of the
North Carolina Department of Transportation
and the
North Carolina Aggregates Association**

This page left intentionally blank.

TABLE OF CONTENTS

<u>I. GENERAL DESCRIPTION</u>	1
<u>II. PROGRAM REQUIREMENTS</u>	3
<u>A. Basic Requirements</u>	3
<u>B. Plant Approval Process</u>	3
<u>C. Quality Control Plan</u>	4
<u>D. Certified Laboratory</u>	5
<u>E. Quality Control Technician</u>	5
<u>F. Certification for Participation in the Aggregate QC/QA Program</u>	6
<u>G. Modifications to the Producer’s Approved Products List</u>	7
<u>III. AGGREGATE SAMPLING AND TESTING PROCEDURES</u>	9
<u>A. Producer's Quality Control</u>	9
<u>B. NCDOT Verification and QA Split Sampling</u>	12
<u>IV. SPECIAL OUT OF STATE APPROVAL POLICY</u>	15
<u>IV. SALES YARD APPROVAL POLICY</u>	17
<u>VI. EXHIBITS</u>	21
<u>EXHIBIT A- NCDOT AGGREGATE QC/QA PLANT OWNERSHIP UPDATE FORM</u>	23
<u>EXHIBIT B- TESTING EQUIPMENT LIST</u>	25
<u>EXHIBIT C- SAMPLING PROCEDURES</u>	27
<u>EXHIBIT D- PROCEDURES FOR SPLITTING AND LABELING SAMPLES</u>	29
<u>EXHIBIT E- RAPID DRYING PROCEDURE</u>	31
<u>EXHIBIT F- QAP SYSTEM FOR REPORTING SAMPLE TEST DATA AND RETRIEVING STATISTICS</u>	32
<u>EXHIBIT G- GRADATION SPECIFICATIONS AND TOLERANCES FOR COMPARISONS</u>	37
<u>EXHIBIT H- ASSESSMENT PROGRAM</u>	44
<u>EXHIBIT I - SPECIFICATIONS (GRADATIONS, LL, and PI)</u>	45
<u>EXHIBIT J- PROJECT CONSTRUCTION OF APPROVED STOCKPILES (ABC- TYPE B)</u>	49
<u>EXHIBIT K- AGGREGATE QC/QA SAMPLING AND TESTING TRAINING MANUAL</u>	53
<u>EXHIBIT L- COMMON AGGREGATE QC/QA PROGRAM FORMULAS</u>	86
<u>EXHIBIT M- QC/QA PROGRAM CONTACT INFORMATION</u>	87

This page intentionally left blank.

I. GENERAL DESCRIPTION

The Aggregate Quality Control/Quality Assurance Program is designed to allow aggregate producers the responsibility for controlling the quality of material they produce, and to utilize the quality control information they provide in the acceptance process by the North Carolina Department of Transportation (NCDOT). It requires aggregate producers to perform quality control sampling, testing and record keeping on aggregates they ship for use by the Department. Also, it requires the Department to perform quality assurance sampling, testing and record keeping confirming the producers' control plan as set forth herein.

This program is designed for Aggregate Producers and Suppliers providing clean coarse or fine Aggregates, and/or Aggregate Base Materials that are to be utilized in NCDOT right of way projects. The program can also be applied to other recycled or innovative sustainable materials to be used on NCDOT projects. It is the intent of this program that acceptance or rejection of material be based on the total program. Therefore, a comparison of Quality Control, Quality Assurance, and other sample data may be used by the Department for acceptance or rejection of a given material.

Participation in this program does not relieve the producer of the responsibility of complying with all requirements of the *NCDOT Standard Specifications for Roads and Structures*.

This manual contains information regarding the sampling and testing of material at the Aggregate Producer's facility (quarry, sand pit, sales yard, etc.). Sampling and testing requirements at other locations (including but not limited to: NCDOT right of way, asphalt, concrete, pipe, or block plants) may be found in other publications such as the *Aggregate Sampling Manual* or the *Hot Mix Asphalt Quality Management System Manual*.

This page intentionally left blank.

II. PROGRAM REQUIREMENTS

A. Basic Requirements

There are five basic requirements for approval to participate in the Aggregate QC/QA Program

- A document of ownership from the facility (Ownership Update)
- Aggregate Material of an acceptable gradation and quality
- An approved in-house quality control plan
- A certified laboratory, or have written approval to use an off-site certified laboratory
- A NCDOT certified quality control technician

B. Plant Approval Process

The Department has three paths to approval:

- 1) **In-State Approval** - Those Producers who are in North Carolina, or those who are out of state, but supply raw aggregates, or aggregates incorporated into ready mixed concrete, across state lines, will be held to the full scope of the Department's Aggregate QC/QA Program.
- 2) **Special Out of State Approval** –
 - a. Those Producers who are out of state and supply aggregate materials to only out of state precast, prestressed, or concrete block facilities, that are sent into North Carolina as finished product.
 - b. Those Producers who are out of state, but supply aggregates to a sales yard approved by the Department.

Those producers who qualify for Special Out of State Approval will not be held to the full scope of the Department's Aggregate QC/QA Program if they participate in their State Department's Aggregate QC/QA Program.

- 3) **Sales Yard Approval** – Those facilities who do not produce aggregate materials but operate as a Supplier of an approved Producer's aggregate materials.

***This manual will focus on the requirements of those producers/suppliers who are In-State Approved. Refer to Section IV for information pertaining to “Special Out of State Approval” and Section V for “Sales Yard Approval.”**

To seek approval, the Producer must first submit a notice to the Department's Aggregate QC/QA Engineer, requesting that their facility be added to the Department's Approved Aggregate Producer/Supplier List. This notice can be in letter or email form, and must contain information as to the Producer's facility name, where the facility is located, what aggregate materials the facility wish to provide, and any intended uses for the material, such as Ready Mixed Concrete, precast/prestressed concrete, asphalt, etc.

The Producer must also submit a letter of facility ownership (Exhibit A – NCDOT Aggregate QC/QA Plant Ownership Update Form) and a Quality Control Plan to the QC/QA Engineer.

Prior to plant approval, the Producer shall have produced at least 300 tons of each material they wish to provide the Department before the material can be sampled and tested. If acceptable test results are obtained, the test data for the material will be added to the NCDOT Aggregate Physical Properties List. A Producer's material must be on the NCDOT Aggregate Physical Properties List before it is considered an approved source for the QC/QA Program. The material must meet the general aggregate requirements, including but not limited to, L.A. Abrasion (AASHTO T96), Sodium Sulfate Soundness (AASHTO T104), gradation requirements (AASHTO T11, T27), and when required, Electrochemical.

The Department will review the Producer's written quality control plan and if approved, an on-site inspection will be scheduled. This on-site inspection will verify that the Producer's quality control plan has been implemented and is being followed and that at least one certified quality control technician is on site and will be present when material is being shipped under this program. The laboratory will be inspected and certified if it meets the requirements and has not already been certified. For a list of laboratory equipment required for testing, see Exhibit B. If either the Producer's quality control plan or laboratory does not meet NCDOT requirements, the Producer will be informed of the deficiencies in writing. Once the deficiencies have been addressed, the Producer may again request approval in writing to the Aggregate QC/QA Engineer.

C. Quality Control Plan

The Producer must prepare a written quality control plan. The plan may be generic but must be site specific. The plan must indicate in detail how the Producer proposes to control the equipment, materials, and production methods of the specified products they intend to provide the Department. The plan must list the personnel responsible for production and quality control at the site and include contact information. The following specific information must also be included in the plan:

- Identification of the physical location of the source, including a description of the property site and reference to the nearest identifiable points such as highways and towns.
- A description of the signs used to identify each stockpile as intended for NCDOT usage. Stockpile signs must be legible from the cab of a truck 50 feet from the identified pile.
- A loading and shipping control plan which includes a description of the methods by which the products are to be loaded and shipped for use by the Department, including safeguards against loading improper aggregate, contamination, degradation, and segregation of the aggregate. The plan must also include methods of insuring that all shipping units are clean before products are loaded, and that once products are loaded, they can still be accurately identified. (ex. Material identification clearly printed on ticket.)
- A plan for dealing with quality control sample failures. This plan must include how the Producer plans to initiate an immediate investigation and how the Producer will implement corrective action to remedy the cause of the problem.

The Producer's written quality control plan must be submitted with the original request to the Aggregate QC/QA Engineer for plant approval. An updated Plant QC Plan must be submitted when changes are made to the plant's operations or ownership.

D. Certified Laboratory

It is required that each source, including distribution yards, establish and maintain its own laboratory for the performance of quality control testing, but the Department will consider a producer's request to utilize a certified laboratory. The Producer must make this request in writing and have written approval, from the Department, before testing aggregates off site.

The equipment required for an approved laboratory is listed in Exhibit B. The laboratory building itself shall be a structure having electricity, heating and air, adequate ventilation and lighting, and a sink with running water. Should a facility wish to have a laboratory approved without any of the above equipment, a written request must be submitted and approved by the Aggregate QC/QA Engineer.

Records on instrument calibration and maintenance, and sample collection and gradation analysis must be maintained at the laboratory. The Department may require a demonstration of the required equipment, and proper documents. A list of approved private laboratories is provided on the Materials and Tests website.

<https://connect.ncdot.gov/resources/Materials/Pages/Materials-Manual-by-Material.aspx?Method=MM-01-02>

E. Quality Control Technician

All quality control samples must be taken and tested by quality control technicians certified by the Department. The Producer shall designate and identify the quality control technicians responsible at each plant on their Quality Control Plan and Ownership Update forms. Quality control technicians may be certified as NCDOT Aggregate QC/QA Sampling Technicians or as NCDOT Aggregate QC/QA Sampling and Testing Technicians. NCDOT QC/QA Sampling Technicians are authorized to take samples of materials, while NCDOT Aggregate QC/QA Sampling and Testing Technicians are authorized to sample and test materials.

While material is being shipped, for purposes of being used on NCDOT Right of Way, the Producer shall have at least one certified technician, either NCDOT Aggregate QC/QA Sampling Technician or NCDOT Aggregate QC/QA Sampling and Testing Technician, onsite whenever material is being shipped to the Department, and readily available to obtain samples with Department personnel. This also includes the shipment to vendors producing approved materials for the Department (i.e., Ready Mixed Concrete, Precast Concrete, Asphalt, etc.), unless prior approval has been granted by the Department. It is strongly encouraged to have at least 1 certified backup technician assigned to the facility, in the event that the primary technician cannot be onsite.

NCDOT certifications for Aggregate QC/QA Sampling and Testing are valid for 5 years from the date that the student successfully completes the Aggregate QC/QA Program. Technicians

seeking certification in Aggregate QC/QA Sampling only, must attend the Sampling Certification Class to maintain their certification. Technicians seeking certification in Aggregate QC/QA Sampling and Testing must successfully complete both the sampling and testing classes and successfully complete a field evaluation conducted by an M&T Representative. Students who are unsuccessful in passing the sampling and testing written exams may retake the exams by registering and attending a reexamination session held in the weeks following each exam date. If a technician is unsuccessful in their second attempt, they must reattend the certification class for which they were unsuccessful in completing.

Technicians are subject to loss of certification by revocation. The primary reason for the loss of a certification by this means would be the falsifying of test results, records, or reports. Other reasons that might lead to loss of certification include gross negligence or apparent incompetence on the part of the technician.

F. Certification for Participation in the Aggregate QC/QA Program

If the Department has approved the Producer's written quality control plan and the on-site inspection confirms that the program requirements have been met, the Department will issue a letter, valid for one year, certifying the plant for participation in the program.

At the end of the first year of approval, the following actions must be met annually for the Producer to maintain their approved status:

- 1) The Department must conduct an Annual Facility Audit to ensure that the Producer remains in compliance with the program. A copy of the completed audit shall be given to the Producer.
- 2) The Department's quality samples (Los Angeles Abrasion, Unit Weight, Soundness, Electrochemical, etc.) must assure that the aggregates are still of specified quality. Copies of these test results should be provided to the Producer by the sampling technician.
- 3) The Producer must provide the Department with an updated, "Aggregate QC/QA Plant Ownership Update Form," as well as an updated QC Plan if changes to the plant's operations or ownership have been made. **Ownership Update forms are due by October 31st of each year and should be submitted through the NCDOT's QAP web-based portal.**

Upon verification that these three requirements have been successfully completed, the Aggregate QC/QA Engineer will extend the Producer's approval for another year.

Additional random inspections may be conducted at any time by the Department to verify compliance with the program requirements.

G. Modifications to the Producer's Approved Products List

Following a Producer being added to the Department's Approved List, should the Producer wish to add materials to their Approved Products List, the Producer shall notify the Department's Material Inspector assigned to the facility. The Producer shall have at least 300 tons of material available to sample. This material will need to be sampled and tested by the Department to assure the material meets the specified gradation requirements. If the material is found to meet specifications, the material may be provided to the Department, and routine sampling and testing by the Producer and Department, in accordance with the manual, shall be performed.

After adding or removing a product from the Producer's Approved Products List, the Producer will need to indicate this material change on their next due Ownership Update Form.

This page left intentionally blank.

III. AGGREGATE SAMPLING AND TESTING PROCEDURES

A. Producer's Quality Control

The Producer's Quality Control (QC) samples are used by the Producer to monitor the quality of material being shipped. The Producer is to perform all aggregate sampling and testing in accordance with this manual.

1. Quality Control Sample - These samples are taken by the Producer to monitor the quality of material being shipped from an approved facility.
2. Lot Size– Lot sizes of aggregates shall be 2,000 tons of material shipped to the Department, or a minimum of one sample per week for each size of material, whichever comes first.

Exception A: (Producer halts shipment of all materials) - If the Producer elects to halt shipment of all materials for an extended period (i.e., 2 months or more) but has intentions to resume shipment at a later date, the Producer may request to the Aggregate QC/QA Engineer to be voluntarily removed from the Approved List during this idle time. The Producer shall continue monitoring the conditions of their stockpiles by sampling each approved material at ½ the frequency of normal sampling and testing guidelines (Bi-weekly) and shall keep a record of samples and results taken for the Department. Department sampling should cease until the Producer notifies the Aggregate QC/QA Engineer the intent to resume the shipment to the Department, at such time the Engineer can add the Producer back to the Approved list, and sampling/testing can resume from both the Producer and Department as per the program. If, however, the Producer remains idle for such time that the previous annual samples and facility audit expire, the Producer must have this sampling and audit performed before being added back to the Approved list.

(Example: A Producer located in the mountains of North Carolina, commonly experiences periods during the winter months when there is no shipment needs by the Department due to cold temperatures. During these months the producer's stockpiles often remain frozen as well. This Producer may elect to choose "Exception A" until such time that they are ready to resume supplying materials to the Department.)

Exception B: (Producer halts shipment of a single material) – If the Producer elects to halt shipment of a single material for an extended period (i.e., 2 months or more) and wishes for testing of this material to cease, the Producer is to notify to the NCDOT materials inspector assigned to the facility. If a stockpile of the material remains on the yard, the Producer and Department may cease sampling until the Producer notifies the materials inspector of its intent to resume shipment to the Department. The Producer is to remove the identification sign indicating the material size or add a sign to indicate the material as non-DOT, as to not advertise that the material is acceptable by the Department. The removal of this material shall be indicated on the facilities Ownership Update for the next year as well. If the Producer wishes to add this material back to is approved materials list, a passing Verification sample by the Department must be recorded before shipment is resumed. If no stockpile of the material remains, or if the current stockpile has been reduced to less the 300 tons, ensure that 300 tons of material is present before sampling.

(Example: Producer elects to provide #14m stone for use in a specific project, but after completion of that project will not have demand for that material until a similar project is bid. In this case the Producer may elect to choose “Exception B” until such time that the producer has a need to supply the material to the Department.)

3. Sampling - The certified plant technician is to obtain a QC sample from the stockpile, conveyor belt or other location approved by the Department. Stockpile samples are to be taken from the same area of the stockpile from which material is being shipped (load face). A description of sampling procedures can be found in Exhibit C. The minimum sample sizes for aggregate samples are as follows:

Aggregate Sample Weight Requirements (pounds)	
Material	Quality Control
Clean Coarse Aggregate**	20
Fine Aggregate	10
Aggregate Base Material	35

*Weight requirements are after material has dried

** When testing Clean Coarse Aggregates which 100% passes the ¾ sieve (#78, #14M, #9, etc.), split the sample into a workable size of 10 to 15 pounds to avoid overloading sieves

4. Sample Identification and Record Keeping - It is critical that care be taken to properly label samples and record test data accurately.

Producer's Quality Control samples are to be identified with consecutive numbers for each size material and stockpile; QC-1, QC-2, etc. The samples are to be numbered consecutively for the entire calendar year. Should a Producer have 2 or more stockpiles of the same material type, such as 2 ABC stockpiles, differentiate the piles by identifying one as Stockpile 1 and the other Stockpile 2. In such cases, the Department should be notified of this identification as well.

For ABC samples going to a NCDOT project, the QC Sample number is to be recorded by the Producer on the delivery ticket of the truck loaded immediately after the sample material is obtained.

All Quality Control test results are to be entered into the Department’s internet based QAP System within five (5) business days of the sample being obtained.

Quality Control data for each size material is to be retained by the Producer for at least one year and made available to the Department upon request.

5. Test Procedures - Modifications to standard test procedures are permitted in some cases in this program. For clean coarse aggregate, no wash test is required on the Producer's split half of the Quality Control sample unless requested by the Department. For fine aggregate, the wash test, with rapid drying (see Exhibit E) being allowed, is to be performed on all samples. For ABC samples, soil mortar testing is required on all samples, see Exhibit M.

Atterberg Limits (L.L. and P.L.) are not required to be performed on the Producer's half of the split sample, except for those plants identified by the Department as having potential problems. In those cases, the Producer is required to check the Atterberg Limits at a frequency of 1 test every 6000 tons or every 3rd QC test. Rapid drying will not be permitted for material from which the Atterberg Limits are determined.

6. Check Samples - If the test results for a QC sample indicate the material does not meet the specification requirements, a check sample is to be immediately obtained by the Producer. The check sample is to be doubled in size and taken in the same manner as the original sample. The sample is to be clearly identified and split with one half tested by the Producer and the other half provided to the Department. It is the responsibility of the Producer to notify the Department's material inspector that a check sample has been taken and split.

If the check sample indicates the material meets the specification requirements, the Producer is to record on the test report form what is felt to be the reason for the original failure and then may resume normal testing procedures.

If the check sample indicates the material does not meet the specification requirements, the Producer is to notify the Department. The Producer is to immediately initiate an investigation to determine the cause of the failure. The investigation is to include a review of the sampling procedures, the equipment used in the production and the testing of the material, and the testing procedures of the technician. If the cause can be attributed to one of the above categories, the Producer is to take corrective action to bring the material, equipment, or procedure into compliance. The Producer is to then record the corrective action on the test report form. Once corrective measures have been taken, the Producer shall coordinate with the Materials and Tests Unit a time to take a second check sample. The check sample is to be doubled in size and taken in the same manner as the original sample, but in the presence of M&T personnel. The check sample is to be clearly identified and split with one half tested by the Producer and the other half provided to the Department. The second check sample shall be taken and, the results of the QC's split, reported within 3 working days of the reporting of the 1st check sample results.

If the second check sample indicates the material meets the specification requirements, the Producer is to record on the test report form what is felt to be the reason for the original failure and the corrective actions taken, and then may resume normal testing procedures.

If results from the second check sample have not been reported by the end of the third working day of the first check sample, or if the second check sample indicates the material does not meet specification requirements, the Producer must stop shipment of the material, and is to notify the Department's Material Inspector assigned to the facility and the Aggregate QC/QA Engineer. The Producer is to continue the investigation into these failures and work with the Department to determine the cause. After the issues are resolved to the satisfaction of the Department, the Producer can resume the shipment after three consecutive passing QC samples have been submitted. Each of these QC samples shall be taken in the presence of a Department representative, doubled in size, and split, with half to be tested by the Department. The QC's half will be used to determine that the material is within specifications but must be within tolerance (see Exhibit G) of the Departments half to be counted. There will be no time limit on

when the consecutive samples can be pulled, however, if the samples are pulled on the same day, each sample must be taken from varying depths into the pile, still sampling from the load face. All check samples will be identified as the original sample number with a suffix added on the end. (i.e., QC-7A for first check sample, QC-7B for second check sample)

7. **Noncompliance** – If the Producer has failed to meet the minimum sampling frequencies described above or is found to have material that does not meet specifications (based on Producer and/or Department samples), the Department will request in writing that the Producer explain the circumstances related to the noncompliance issue. The Producer must respond in writing within one week of receipt of the request. If the Department finds the response inadequate, the Department will notify the Producer of the deficiencies and may remove the plant from the Program. If the Producer does not respond in writing, the Department may remove the plant from the Program. If removed from the Program, the Producer may request to have the plant reinstated once corrective actions have been taken.

B. NCDOT Verification and QA Split Sampling

The Department's Verification and QA Split samples are used to verify the performance of the Producer's quality control plan.

Aggregate Sample Weight Requirements (pounds)		
Material	QC/QA Split	Verification
Clean Coarse Aggregate**	40	20
Fine Aggregate	20	10
Aggregate Base Material	70	35

*Weight requirements are after material has dried

** When testing Clean Coarse Aggregates which 100% passes the ¾ sieve (#78, #14M, #9, etc), split the sample into a workable size of 10 to 15 pounds to avoid overloading sieves

1. **Verification Samples**- Verification samples will be taken independent of the Producer’s QC samples and will be sampled from each size of material shipped to the Department. Producers will be allowed to split the sample or take a sample adjacent to the Verification Sample for their internal informational purposes only. This Producer’s sample shall not be used as the next QC sample, nor shall it be entered into the Department’s database.
2. **QA Split Samples**- QA Split samples will be taken and split for testing by both the Department and the Producer for each size of material shipped to the Department. The Department’s representative will direct the sampling and splitting process in accordance with Exhibits C and D respectively. The Producer’s half of the QA Split is recorded as the next QC sample for that product.

3. Sample Frequency –

Verification Samples

ABC - 1 sample every 2 weeks

Core Aggregates (#57, #57m, #67, #78m, 2S sand, and 2MS Sand) – 1 sample per month

Non-Core Aggregates (#4, #467m, #5, #6m, #14m, #9m, 1S sand, 4S sand, and all other sizes not listed as Core - 1 sample per month only if material has been shipped to NCDOT project/supplier since QA sampling technician’s previous visit. If no material has been shipped since last visit, ***sample not required***

Screenings (Washed, Dried, or Other) – No sample required, except, 1 sample collected during annual inspection

QA Quarterly Split Samples

All QC/QA Program Approved Aggregates – 1 sample per quarter (every 3 months) for each size of material shipped.

****All Verification and QA Split sampling shall be performed or observed by the Department’s representative.**

4. Sampling – The Department’s representative is to obtain samples taken from the stockpile, conveyor belt or other location approved by the Department. Stockpile samples are to be taken from the same area of the stockpile from which material is being shipped (load face).
5. Sample Identification and Record Keeping – It is critical that care be taken to properly label samples and record test data accurately.

The Verification samples are to be numbered in a sequential order at the beginning of each year or the first sample after a Producer’s facility is accepted into the program. The number following “V” is the number for the independent sample, V-1, V-2, etc.

The QA Split samples are to be numbered with a number corresponding to the appropriate Quality Control sample. The number following "QA" is the number of the corresponding Quality Control split sample, QA-1 paired with QC-1, QA-2 paired with QC-2, etc. This same rule will apply to check samples. QA-1A paired with QC-1A.

6. Testing – All Verification and QA Split samples are to be tested at one of the Department’s regional laboratory locations or at the Central Laboratory in Raleigh. Annual Quality samples are to be tested at the Department’s Central laboratory.

7. QC/Verification Comparison – QC versus Verification samples will be compared using the F-test and t-test (F&t) data compiled by QAP. The data will be checked in accordance with “Optimal Procedures for Quality Assurance Specifications” FHWA-RD-02-095 (Appendix F). A report can be generated to compare the data for any discrepancies within the program.
8. QC/QA Split Comparison – QC versus QA Split samples will be compared using the Paired t-test based on the data provided in QAP. The data will be checked in accordance with “Evaluation of Procedures for Quality Assurance Specifications” FHWA-HRT-04-046. A report can be generated to compare the data for any discrepancies within the program.

If the results of the QA Split sample are not in agreement with the results of the corresponding QC sample, i.e., outside the limits of Table II or Table III of Exhibit G, an investigation will be made to determine the source of the difference. The investigation will include a review of the testing procedures and the testing equipment. The results of the investigation will be recorded in the Materials Inspector’s Comment Field in the Department’s computerized tracking system (HiCAMS) and a copy given to the aggregate producer and the Aggregate QC/QA Engineer.

If the cause is determined to be improper splitting or testing procedures, the appropriate certified technician will be notified. There will be follow-up visit by a NCDOT representative. If the problem continues, the technician's certification may be revoked. If the cause is determined to be in the Producer's testing equipment or handling of the material the Producer is to take corrective action. The follow-up visit will audit the documentation and observe the sampling process. If this problem continues, the Producer's approval to provide material to the Department may be revoked. If the cause is determined to be in the Department's testing equipment, the Department will take corrective action and notify the aggregate producer of the action.

9. Noncompliance–The Aggregate QC/QA Engineer and/or their representative will investigate instances in which the Department’s QA personnel are found to be in noncompliance with the requirements set forth by this manual for QA Sampling and Testing (frequencies, sampling/testing techniques, etc.) Quality Assurance personnel found to be in noncompliance may be subject to disciplinary action including certification revocation and/or dismissal.

IV. SPECIAL OUT OF STATE APPROVAL POLICY

The purpose of this policy is to establish the procedures for the use of out of state coarse and fine aggregate facilities that provide raw materials to out of state producers of manufactured products for use on NCDOT highways.

To become an approved Out of State Producer:

- 1) The Producer must be in compliance with the NCDOT's policy for out of state producers (see following page).
- 2) If a Producer is in compliance with the out of state policy, they must submit a letter to the Aggregate QC/QA Engineer requesting to be added to the Special Out-of-State Approved List. The Producer is to include what aggregate material sizes they would like to produce for the NCDOT and what the material will be utilized as (i.e., precast, prestressed, or concrete pipe plant).
- 3) A certified Material Technician with the Materials and Tests Unit will obtain Annual Quality Samples of the material to be provided to the Department (this will be done on an annual basis). Samples collected shall be tested for LA Wear, Soundness, etc. Also, Verification samples for gradation will be obtained for each size aggregate sold for production of precast/prestressed/concrete pipe units.
- 4) While Department samples are being processed, the Producer will need to submit an Ownership Update Form, and proof they are approved in the state they reside in. This could be a letter from the state or an approved QC Plan.
- 5) Once the samples are determined to be within specifications and the required documentation information from the Producer have been received, the quarry will receive a letter indicating they have been added to the Approved Producers List and can produce from that specific facility with that specific type product ONLY.
- 6) A Materials and Tests Technician will pull samples, as listed in step 3 for out-of- state aggregate facilities, once per year from the facility to remain active, and the facility will also need to submit an Ownership Update Form once per year.

NORTH CAROLINA DEPARTMENT OF TRANSPORTATION

APPROVAL POLICY FOR OUT OF STATE AGGREGATE FACILITIES THAT PROVIDE RAW MATERIALS USED IN MANUFACTURED PRODUCTS FOR NCDOT

The purpose of this policy is to establish the procedures for the use of out of state coarse and fine aggregate facilities that provide raw materials to producers who make manufactured products for use on NCDOT highways:

- The producer/supplier of the manufactured product incorporating the aggregate must be on the NCDOT Approved list.
- The aggregate facility supplying aggregate to the approved producer/supplier must also be on the NCDOT approved list of Coarse and Fine Aggregates.
- The aggregate facility must be an approved producer/supplier in the state in which the facility is located.
- If the host state does not have an approved list for aggregates or other formal approval process, then the producer will have to have, as a minimum, test data from a private accredited testing laboratory confirming basic material qualities for the aggregate.
- The aggregate facility must have a published Quality Control Plan that addresses the frequency of quality control checks and who is responsible for taking and testing the samples.
- The above listed information will be submitted to the Quality Assurance Engineer for review before approval is granted (compliance with NCDOT's QC/QA Aggregate Program may be waived provided the all the above criteria is met).
- The Department will visit the out of state facility at a minimum of once per year to take verification samples.
- NCDOT personnel have the authority to perform unannounced quality assurance inspections of the facilities furnishing aggregates used for NCDOT work at any time without notice.
- A facility that does not comply with this policy or that is not actively furnishing material to approved manufacturers for NCDOT work will be taken off the approved list.

To illustrate, the following example is provided:

A fine aggregate facility in Georgia furnishes sand to be used in the production of concrete for an NCDOT Approved Precast Concrete manufacturer. For this example, the precast concrete manufacturer must be on the NCDOT approved list of precast concrete suppliers. The supplier of the aggregate must also be listed on the NCDOT approved list of Coarse and Fine Aggregates but does not have to comply with all the QC/QA program requirements provided that facility is currently on Georgia DOT's approved list of Coarse and Fine Aggregates or they provide a Quality Control plan and test data confirming basic material qualities for the aggregate.

Requests for approval shall be submitted by Email, Mail, or Fax to:

Christopher Whitley
Aggregate QC/QA Engineer
NCDOT Materials and Tests Unit
801 Statesville Rd,
North Wilkesboro, NC 28659

Phone: (336) 903-9247
Fax: (336) 667-5919
Email: cdwhitley@ncdot.gov

V. SALES YARD APPROVAL POLICY

A Sales Yard will be considered any facility that sells aggregate material not manufactured onsite. Like an approved producer, the Sales Yard must also be on the NCDOT Approved List. The material sold can come from one or multiple facilities. However, these facilities must all be on the NCDOT Approved List as well. If source facilities are not on the approved list, they must follow the Aggregate Approval Guidelines to become approved.

To become an approved Sales Yard:

- 1) The facility shall send a letter to the Aggregate QC/QA Engineer requesting to sell (XYZ) material and document the source facility from which the material is coming from.
- 2) Create a 300-ton stockpile of the material to be sold. This stockpile shall be clearly labeled.
- 3) Assign a QC Technician to the facility for sampling and testing purposes. This QC Technician must possess a valid Aggregate QC/QA Sampling and Testing certification through the Department. This Technician does not have to remain onsite at all times but must be readily available to obtain samples as needed with Department personnel. If multiple attempts must be made by the Department to arrange sampling with this Technician, the Department reserves the right to require that a QC Sampling Technician be onsite at all times as material is being shipped to the Department.
- 4) Submit a QC Plan and Ownership Update Form indicating the material that will be sold and where it originates from.
- 5) The certified QC technician for the Sales Yard must submit a request to be added to the QAP System to log testing data.
- 6) A Materials & Tests Technician will then come and sample the material for gradation and annual quality verification (LA, Soundness, etc.) and perform a laboratory inspection. If no onsite laboratory, then an offsite laboratory can be utilized if a request is made in writing, and it is an approved NCDOT Laboratory. If using an offsite laboratory, the facility is still required to have a splitter onsite large enough to split samples with NCDOT.
- 7) Once the material has passed, a letter will be sent to the Sales Yard approving them and the material. The Sales Yard will be given a Facility ID number. The facility will then have to start sampling and entering the material into QAP. A Materials and Tests Technician from the Department will continue to sample and test the material for gradation purposes as per the QC/QA Manual. After approval, further Annual Quality samples will not be required from the Sale Yard. Annual Samples will be obtained from the original source of the material on an annual basis.

This page intentionally left blank.

GLOSSARY

Department Representative- Any person(s) employed by the Department or individual(s) under contract with the Department for the purpose of sampling or inspecting aggregate production.

F-Test and t-Test- Statistical analysis used to compare the Verification samples with the Quality Control Samples. ($\alpha=.05$)

NCDOT- North Carolina Department of Transportation.

The Department- North Carolina Department of Transportation or any other state agency.

NCDOT Right of Way- Any boundary of land maintained by the state of North Carolina

Paired-t Test- Used to compare means on a specific size of aggregate or other material over time or in differing circumstances for QC/QA Split samples.

Plant Ownership Update Form- Document in Exhibit A that is initial approval and changes in ownership.

Producer- An approved person or organization that produces aggregates to be sold and used by the Department.

Producer's Certified Laboratory- Any laboratory that has been certified by the Department for the purpose of testing aggregates. The laboratory may be on site or off site with prior approval. (Quality Control) Contact Materials and Tests Unit for approved private laboratories.

QA Split Sample- A sample that is taken under the direction of the Department Representative by the QC Technician and split for testing by both the quarry and the Department. This sample will be entered into HICAMS.

QAP (Quality Assurance Program)- This system is intended to collect and analyze quality control and quality assurance data for the aggregate and asphalt industries that do business with NCDOT.

Quality Assurance- Procedural activity implemented in a quality system so that requirements and goals for a product are met. It is also used as a comparison with a standard for the specific material to monitor the process that is set in place.

Quality Control- Process in which the Producer monitors the quality of their material being shipped by taking random samples and conducting in house testing. This process will be tracked in the QAP System.

Quality Control Plan- A document developed by the Producer proposing how they will control equipment, materials, and production methods to ensure that specified products are obtained.

Quality Control Technician- Any individual that has completed the NCDOT Aggregate QC/QA Sampling Technician or NCDOT Aggregate QC/QA Sampling and Testing Technician Certification course provided by the Department.

Verification Sample- A random and independent sample taken by a Representative of the Department for the purpose of verifying the Quality Control results.

This page intentionally left blank.

VI. EXHIBITS



This page intentionally left blank

EXHIBIT A- NCDOT AGGREGATE QC/QA PLANT OWNERSHIP UPDATE FORM

NCDOT Aggregate QC/QA Plant Ownership Update

Name of Company: _____

Name of Facility: _____

NCDOT Facility Number: CA _____ FA _____

Facility Mailing Address and Contact Information:

Street: _____

Street: _____

City: _____ State: _____ ZIP _____

Telephone: _____ FAX: _____

Telephone: _____

Email: _____

Name and Title of Contact: _____

Facility Physical Address:

Street: _____

Street: _____

City: _____ State: _____ ZIP _____

Driving Directions from Major Landmark: _____

Plant Personnel Responsible for Quality:

	Name	Title	Cert. Number ¹
1)	_____	_____	_____
2)	_____	_____	_____
3)	_____	_____	_____
4)	_____	_____	_____
5)	_____	_____	_____

Material:

List of Material Being Produced at Facility:

The Information for this facility HAS changed since this form was last submitted? YES / NO

The Quality Control Plan for this facility HAS been revised since it was NCDOT Approved? YES / NO

If YES, attach copy of current Quality Control Plan to this document and submit for review.

I certify that the foregoing entries are correct.

Signature _____

Title: _____

Date: _____

¹ List NCDOT assigned Technician Certification Number if applicable.

This page intentionally left blank.

EXHIBIT B- TESTING EQUIPMENT LIST

Equipment Required for Certified Laboratory testing Coarse or Fine Aggregate

- 1) **Automatic shaker(s) for ABC and Coarse Aggregate** (Gilson style shaker) Must be equipped with clock timer and mounted to building floor, if floor is concrete. If not concrete, a concrete pad should be poured as base). Must have all required sieve sizes for aggregates being tested.
- 2) One set of **electronic scales**, readability and sensitivity of 0.1 gram, accurate to 0.1 gram or 0.1 percent of capacity with a minimum capacity of 2500 grams. (Calibrated Annually)
- 3) One set of **electronic scales**, readability and sensitivity of 20 grams, accurate to 20 grams or 0.1 percent of capacity with a minimum capacity of 50 kilograms (110 lbs). (Calibrated Annually)
- 4) A sufficient quantity of **pans** (24" x 12" x 3") for drying samples.
- 5) One **Sample Splitter** (8" x 14" x -3/4" opening) with two catch pans and one pouring pan.
- 6) One **Sample Splitter** (chute width 24" and adjustable 1/2" bars)
- 7) One **automatic shaker** (Rotap or Mary Anne style shaker) with timer, cover and all sieve sizes required to test ABC soil mortar, and fine aggregates according to NCDOT Specifications.
- 8) Minimum of one set of 8" diameter **sieves** for testing ABC soil mortar, and one set of sieves for fine aggregate according to NCDOT Specifications.
- 9) One **mortar bowl** (210 mm outside diameter).
- 10) One **wooden mallet** (1-3/4" x 3-1/2" x 6" with 1" diameter x 12 dowel centered).
- 11) Sufficient quantity of **containers** (approximately 400-gram capacity) and/or sample pans.
- 12) One **oven**, gas or electric (thermostatically controlled @ 110 +/- 5°C).
- 13) One oven **thermometer**. (0 to 150 +/- 0.5°C) (Digital Thermometers preferred for AMRL accreditation)
- 14) Large **stainless-steel mixing bowl**

*If identified as a source with potential **plasticity issues**, a Facility must have these additional items to be approved. If after approval a facility is later identified, or develops, plasticity issues, the Department may require Facility to add these equipment items.*

- 1) One **liquid limit machine** (with grooving tool) by AASHTO T-89.
- 2) Sufficient quantity of **heat-resistant containers** with lid.
- 3) One stiff blade **spatula** (3 1/2" x 13/16").
- 4) One **porcelain evaporating dish**, or similar mixing dish
- 5) A **ground glass plate or piece of smooth**, unglazed paper on which to roll the sample. Paper, if used shall not add foreign matter (fibers, paper fragments, etc.) to the soil during the rolling process and shall lay flat on a smooth horizontal surface
- 6) One **pestle** (with 2" diameter rubber covered base or drill press with rubber disc).

Equipment Required for Certified Laboratory ONLY testing Fine Aggregate

- 1) One set of **scales**, readability and sensitivity of 0.1 gram, accurate to 0.1 gram or 0.1 percent of capacity with a minimum capacity of 2500 grams. (Calibrate Annually)
- 2) One **automatic shaker** (Rotap or Mary Anne style shaker) with timer, cover and all sieve sizes required to test ABC soil mortar, and fine aggregates according to NCDOT Specifications.
- 3) Sufficient quantity of **pans** for drying samples
- 4) One **divider or splitter:**

Divider must be approx. 5" tall, with four legs attached at right angles, each leg being 14" in length. Constructed of 18 gauge or similar aluminum.

Splitter must have at least (8" x 14" x 1/2" opening) with two catch pans and one pouring pan.

- 5) Minimum of one set of 8" diameter **sieves** for testing fine aggregate. Must have all sieve sizes required to test according to NCDOT Specifications.
- 6) One **oven**, gas or electric (thermostatically controlled @ 110 +/- 5°C).
- 7) One oven **thermometer** (0 to 150 +/- 0.5 °C) (Digital Thermometers preferred for AMRL accreditation)
- 8) Sieve brushes

EXHIBIT C- SAMPLING PROCEDURES

Sampling Procedures

I. Introduction

In order to reduce the number of variables that affect the correlation between samples, it is important that all samples be obtained following procedures in accordance with this manual.

II. Production Stockpile Sampling

For stockpile sampling, obtain the sample from an area that represents material being shipped. For base materials, sample at or near optimum moisture to minimize segregation. Before sampling, a visual inspection of the stockpile load face shall be conducted. If there is evidence of segregation or contamination, immediate corrective action must be taken. The material in question should be thoroughly mixed or removed before obtaining a sample. The sample shall be obtained from aggregate that has been picked up by a loading unit from the existing stockpile. The material from which the samples are to be obtained should be approximately one full loader bucket. The loading unit shall dump the material on the ground as if loading a truck. Care shall be taken not to drop material from an excessive height, which could cause material to segregate. Then, strike off and level to approximately half the original pile height. The flat surface shall be divided into four sections. Identify sampling areas as A, B, C, and D, as shown below. Opposite quadrants, such as A and D, or B and C shall be used to acquire the sample. Sampling in this manner will leave two quadrants undisturbed.

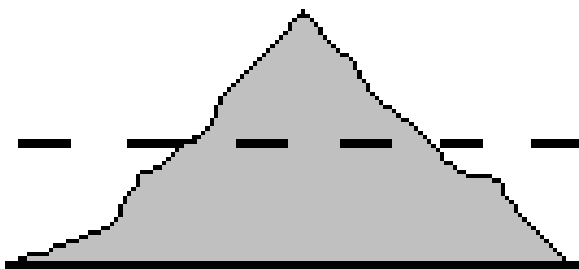

Material first dumped on ground

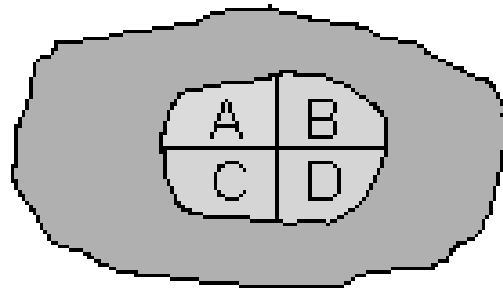

Material after being leveled off and sectioned

While obtaining material with the shovel, care shall be taken to prevent spillage of material while transferring material to the sample container.

III. Approved Stockpile Sampling

The lot size will be 2,000 tons of material, or a fraction thereof, placed in a stockpile. The certified plant technician is to obtain a Quality Control (QC) sample.

The sample shall be obtained by removing the top six inches (1/4 layer) of the layer and sampling the underlying twelve inches (1/2 layer) of material using a steel sampling ring approved by the Department. This will leave an undisturbed six inches (1/4 layer) on the bottom of the layer.

Samples taken after a layer has been corrected should be taken in the same manner as the original sample with the exception that the sample shall be taken from the entire depth of the layer, including the corrective material.

IV. Belt Sampling

A sampling lot shall be represented by obtaining three randomly located samples from approximately equal increments of the sampling lot. The three samples are to be combined and tested. The sample shall be taken from the conveyor belt before the material has passed through the pug mill, if a pug mill is being utilized.

The sample is obtained by isolating a cross section of the belt and removing all material inside of the isolated cross section, including all fines. Samples obtained from a conveyor belt anywhere other than an approved QC/QA Aggregate facility, shall not exceed limits of Column C in Table I-2.

V. Tube Sampling

For tube sampling, obtain the sample from an area that represents material being shipped. Fine aggregate samples may be obtained from the stockpile using a tube approved by the Department. The tube shall be a minimum of 1¼” (30mm) in diameter by 6 feet (2m) in length. The tube shall be constructed of aluminum or PVC.

The sample is obtained by inserting the tube into the stockpile at evenly spaced locations across the load face of the stockpile. A minimum of five insertions of the tube shall be made. The insertions are to be made at a minimum height of three feet from the bottom of the pile.

EXHIBIT D- PROCEDURES FOR SPLITTING AND LABELING SAMPLES

Procedures for Splitting Samples using a Splitter

Samples are to be split using one of the two following procedures:

I. Place half of the material (i.e., approximately 35 pounds of a 70-pound sample) in the top of the splitter. Open the splitter slowly, allowing the material to flow into the two catch pans. Switch the pans from one side of the splitter to the other and place the remainder of the material in the top of the splitter. Open the splitter slowly, allowing the remainder of the material to flow into the two catch pans.

or

II. Place all the material in the top of the splitter. Open the splitter slowly, allowing the material to flow into the two catch pans. Compare the weights of the two pans to see if they are within 3% of each other (i.e., within 2.1 pounds for a 70-pound sample). If they are not within this tolerance, place all the material back in the top of the splitter and repeat the procedure.

In both cases, the finger gate settings should be at least 1-1/2 times larger than the largest allowable particle in the material being split, the area on which the splitter rests should be level, and the material should be split before the material is completely dry.

Procedures for Splitting Fine Aggregate Samples using a Divider

This procedure may be used in place of the splitter method described above for Fine Aggregate samples only. This procedure may be required for fine aggregates if the material has a moisture content that prevents the material from freely falling through a sample splitter. The procedure requires the use of an impervious surface such as a steel plate, and a four-way divider. If a table is used, it shall be approximately 28 inches deep by 32 inches wide. The four-way divider shall have legs approximately 28 inches long that intersect in the middle, forming a right angle. The device shall be approximately 5 inches tall. The material should be split before the material is completely dry.

Place all the moist material in the center of the table. Remix the sample thoroughly and mound it in a cone shaped pile approximately 6 inches high. Push the four-way divider down through the center of the pile until contact with the table surface is made. Slide the divider back and forth on the table surface to separate the fine aggregate sections from each other slightly. Remove two of the opposite quadrants (sections) of material. Remix the remaining two quadrants and repeat the procedure as necessary until the remaining material is the correct quantity for the test to be run.

Divider for Splitting Fine Aggregate Samples

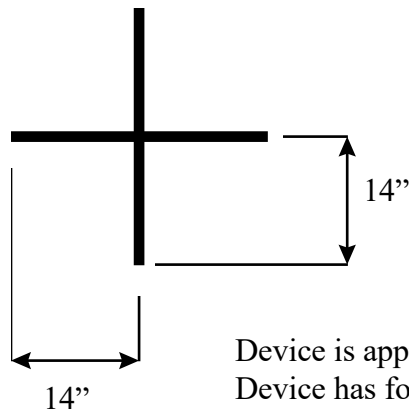

Device is approximately 5" tall.
 Device has four legs attached at right angles, each leg is 14" long.
 Construction is of 18 gauge or similar aluminum.

Sample Numbering and Identification

Each size or type of material will have its own series of consecutive sample numbers beginning with the number 1 for the first sample taken at the beginning of the calendar year. For example, beginning January 1 the number sequences for each of the following products taken from the same plant is as follows:

Quality Control Sample Identification

Product (size)	Sample Number Sequence beginning January 1
#57	QC-1, QC-2, QC-3, QC-4, etc.
#67	QC-1, QC-2, QC-3, etc.
#78M	QC-1, QC-2, QC-3, QC-4, etc.

*QA Split samples will follow the corresponding QC sample sequence.

Verification Sample Identification

Product (size)	Sample Number Sequence beginning January 1
#57	V-1, V-2, V-3, V-4, etc.
#67	V-1, V-2, V-3, etc.
#78M	V-1, V-2, V-3, V-4, etc.
Washed Screenings	V-1, V-2, etc.

Check Sample Identification (Out of Spec Samples)

Product (size)	Sample Number Sequence beginning January 1
#57	QC-1, QC-2, QC-2A, QC-3, etc.
#67	QC-1, QC-2, QC-3, QC-3A, QC-3B, QC-4, etc.

*A suffix of "A" indicates that the preceding sample was out of specifications, and the sample carrying the "A" suffix is the first check sample. A suffix of "B" indicates a second check sample was required.

EXHIBIT E – RAPID DRYING

Rapid Drying Procedure

- ** If a facility is required by the Department to test for Plasticity Index (P.I.) then the sample must be dried at a temperature not exceeding 60 ° C or 140 ° F. Therefore, Rapid Drying is not allowed when material is to be tested for plasticity.**
- A. Pans may be placed directly on electric heating elements, or convention oven style gas elements. When using large exterior style gas burning units, use a metal frame (angle iron) or other structure to support standard drying pans a minimum of 4" above gas burner units.
 - B. Sample size 30-40 pounds per pan (uniformly spread in pan)
 - C. For gas drying, adjust flame from burner units to avoid excessive heat directly to bottom of pan.
 - D. During drying of sample, technician shall be present at all times to:
 - 1) Monitor and adjust heat when necessary,
 - 2) Mix, stir, and turn the aggregate over in the pan to prevent scorching of the sample.
 - E. Dry the sample until no moisture is present. Allow sample to cool, stirring sample occasionally to assist in uniform cooling.
 - F. Process the sample promptly after it is cool to avoid the absorption of additional moisture from the air.

EXHIBIT F – QAP SYSTEM FOR REPORTING SAMPLE TEST DATA AND RETRIEVING STATISTICS

The NCDOT Quality Assurance Program (QAP) is a web based Quality Control/Quality Assurance application (available at <https://apps.dot.state.nc.us/vendor/qap>) used by both the Department and material Producers/Suppliers who provide Aggregate or Asphalt materials to the Department for highway construction projects. The system provides web enabled data entry of individual QC & QA test results, secure file transfer of test results, access to individual and summary test reports, and statistical analysis tools.

QAP Getting Started Guide Website:

<https://connect.ncdot.gov/resources/Materials/MaterialsResources/QAP%20Getting%20Started%20Guide.pdf>

Each Producer/Supplier and applicable staff must be registered within the NCID system in order to access results.

What QAP allows users to do:

- Enter Aggregate QC and QA Test Results
- Upload Aggregate QC and QA Test Results
- View Aggregate Test Reports

Should errors in data entry occur, the Aggregate QC/QA Engineer or QAP Information Systems Liaison should be notified, and a detailed explanation of the data entry error given. The Department will use this information to correct the error in QAP. Care should be taken to input data correctly. Repeated and frequent data entry errors by a QC Technicians may result in disciplinary actions, including but not limited to loss of certification. QA data will be available to the Producer once QC data has been entered and uploaded.

QAP Information Systems Liaison Contact Number: (919) 707-2369

QAP/HiCAMS User Registration Form

The following information is required to link each Quality Assurance Program (QAP) user's NCID with the HiCAMS application. Please fill out this form completely and return it to your company's QAP Account Administrator.

COMPANY INFORMATION

Business Name

Business Address

Contact Phone Number

USER INFORMATION

Last 4 Digits of SSN

Last Name

First Name

Middle Name/Initial

Job Title

User ID from NCID

Email Address Linked to NCID Account

Supervisor's Name

Supervisor's Title

For Use by Company Account Administrator Only

Account Administrator Name

Administrator NCID User ID

I hereby confirm that I am a designated Account Administrator for the above company and do authorize the above person to have access to my company's information available via the NCDOT QAP Application. I also verify the accuracy of the above user information.

Signed: _____

This page intentionally left blank.

List of Material Names for HiCAMS QC/QA Batch Process in QAP

Aggregate, Coarse – English

Material Description	Code Name
Coarse Aggregate, #14M	CA14M
Coarse Aggregate, #4	CA4
Coarse Aggregate, #467M	CA467M
Coarse Aggregate, #5	CA5
Coarse Aggregate, #5 (VA Spec)	CA5VA
Coarse Aggregate, #57	CA57
Coarse Aggregate, #57M	CA57M
Coarse Aggregate, #6	CA6
Coarse Aggregate, #67	CA67
Coarse Aggregate, #68 (VA Spec)	CA68VA
Coarse Aggregate, #7	CA7
Coarse Aggregate, #78M	CA78M
Coarse Aggregate, # 8 (VA Spec)	CA8VA
Coarse Aggregate, #9	CA9
Coarse Aggregate, #9M	CA9M
Lightweight Concrete, (See Specs)	CALWT
Lightweight, Structural Concrete, (See Specs)	CALWTSC

Aggregate Base Course – English

Material Description	Code Name
Aggregate Base Course	ABC
Aggregate Base Course, Modified	ABCM
Aggregate Base Course, S-Gradation	ABCSG
Stabilizer Aggregate	SA

Aggregate, Fine – Screenings – English

Material Description	Code Name
Screenings, Dry	SD
Screenings, Washed	SW

Aggregate, Fine – Concrete – English

Material Description	Code Name
Sand, 1S	S1S
Sand, 2MS	S2MS
Sand, 2S	S2S
Sand, 4S	S4S

This page intentionally left blank.

Gradation Test Report Form

North Carolina
 Department of Transportation - Materials and Tests Unit
 Raleigh, North Carolina

Producer's Coarse Aggregate Quality Control Test Summary

Quarry: _____ Number: _____ Producer: _____ Page: _____

County: _____ Number: _____ Size Material: _____

Grading - Percent Passing

Date	Sample Number	Quantity (Tons)	2"	1.5"	1"	3/4"	1/2"	3/8"	#4	#8	#10	#40	#200	#40 @	#200 @	L.L	PI	Sampling Tech. Name / Cert #

Place * in columns containing values that are outside of specifications
 Remarks: @ Soil mortar fraction for ABC.

cc: M&T Inspector
 M&T Files

 Quality Control Testing Technician

This page intentionally left blank.

EXHIBIT G-GRADATION SPECIFICATIONS & TOLERANCES FOR COMPARISON

Table 1A- AGGREGATE GRADATION-COARSE AGGREGATE (TABLE 1005-1 OF STANDARD SPECIFICATIONS)

Std. Size #	2"	1 ½"	1"	¾"	½"	3/8"	#4	#8	#10	#16	#40	#200	Remarks
4	100	90-100	20-55	0-15	-	0-5	-	-	-	-	-	A	Asphalt Plant Mix
467M	100	95-100	-	35-70	-	0-30	0-5	-	-	-	-	A	Asphalt Plant Mix
5	-	100	90-100	20-55	0-10	0-5	-	-	-	-	-	A	AST, Sediment Control Stone
57	-	100	95-100	-	25-60	-	0-10	0-5	-	-	-	A	AST, Str. Conc., Shoulder Drain, Sed. Control Stone
57M	-	100	95-100	-	25-45	-	0-10	0-5	-	-	-	A	AST, Concrete Pavement
6M	-	-	100	90-100	20-55	0-20	0-8	-	-	-	-	A	AST
67	-	-	100	90-100	-	20-55	0-10	0-5	-	-	-	A	AST, Str. Conc., Asphalt Plant Mix
78M	-	-	-	100	98-100	75-100	20-45	0-15	-	-	-	A	AST, Str. Conc., Asphalt Plant Mix
14M	-	-	-	-	100	98-100	35-70	5-20	-	0-8	-	A	Asphalt Plant Mix, AST, Weep Hole Drains, Str. Conc.
9M	-	-	-	-	100	98-100	85-100	10-40	-	0-10	-	A	AST
ABC	-	100	75-97	-	55-80	-	35-55	-	25-45	-	14-30	4-12 ^B	Agg. Base Course, Agg. Stabilization
ABC-M	-	100	75-100	-	45-79	-	20-40	-	0-25	-	-	0-12 ^B	Maintenance Stabilization
Light-weight C	-	-	-	-	100	80-100	5-40	0-20	-	0-10	-	0-2.5	AST

A. See Sub article 1005-4(A) B. See Sub article 1005-4(B) C. For Lightweight Aggregate used in Structural Concrete, see Sub article 1014-2(6)

Table 1B- AGGREGATE GRADATION-FINE AGGREGTATE (TABLE 1005-2 OF STANDARD SPECIFICATIONS)

Std. Size #	3/8"	#4	#8	#16	#30	#50	#100	#200	Remarks
1S	100	90-100	-	40-85	-	0-20	-	0-3	Blotting Sand, Asphalt Retreatment
2S	100	95-100	80-100	45-95	25-75	5-30	0-10	0-3	Concrete, Shotcrete, Grout, Subsurface Drainage, Blotting Sand
2MS	-	95-100	80-100	45-95	25-75	5-35	0-20	0-8 ^A	Concrete, Shotcrete, Grout, Subsurface Drainage
4S	-	100	95-100	-	-	15-45	0-10	0-5	Mortar

A. When tested at the job site before use, the amount of material passing the No. 200 sieve shall not be greater than 10%

Table 2- Tolerances for Comparisons of Coarse Aggregate QC/QA Gradations Sieve Sizes

	ABC*	#4	#467M	#5	#57 #57M	#6	#14M	#67	VA#5	VA#68	#7	VA#8	#78M
2"													
1 1/2"	± 2	± 2	± 2		± 2								
1"	± 4	± 4		± 2	± 3			± 2	± 2	± 2			
3/4"		± 4	± 5	± 5		± 3		± 3	± 5	± 3	± 2	± 2	± 2
1/2"	± 5			± 2	± 5	± 4			± 2		± 3	± 3	± 3
3/8"		± 2	± 3	± 2		± 4	± 3	± 5	± 2	± 5	± 3	± 3	± 3
#4	± 6		± 2		± 3	± 2	± 5	± 3		± 3	± 5	± 5	± 5
#8					± 3		± 5	± 3		± 3	± 3	± 3	± 3
#10	± 5												
#16										± 2		± 2	
#40	± 5												
#80													
#200	± 3	± 0.5	± 0.5	± 0.5	± 0.5	± 0.5	± 0.5	± 0.5	± 0.5	± 0.5	± 0.5	± 0.5	± 0.5
Soil Mortar													
#40	± 6												
#200	± 5												
LL	± 4												

*Use ABC range for all base course materials such as: ABC, ABC Type A, ABC Type B, ABC-M, ABC-S, CTB, CTBC, SA, etc.

Table 3 -Tolerances for Comparisons of Fine Aggregate QC/QA Gradations

Sieve Sizes	Asphalt Sand, SD, SW, SSW*	1S	2S	2MS	4S
1/2"					
3/8"					
#4	± 2				
#8	± 6	± 1	± 1	± 1	± 2
#10	± 6				
#16	± 6	± 3	± 3	± 3	± 3
#30	± 6	± 3	± 3	± 3	± 3
#40	± 6				
#50	±4	± 2	± 2	± 2	± 3
#100	± 2	± 1	± 1	± 1	± 2
#200	± 2	± 1	± 1	± 1	± 1

*SD- Dry Screenings, SW-Washed Screenings, SSW- Super Washed Screenings

This page intentionally left blank.

EXHIBIT H- ASSESSMENT PROGRAM

I. Introduction

The Assessment Program is a requirement of the Federal Highway Administration and replaces the Departments Independent Assurance sampling requirements. Assessments are used to verify the performance of the Department's acceptance program to the FHWA.

II. Assessment Requirements

Technicians actively testing aggregates will be subject to assessments conducted by NCDOT personnel at least annually to ensure proper procedures are followed. Assessments will be conducted by Department technicians who have been certified as an Aggregate QC/QA Assessment Technician. Assessments of QC personnel will not be required in years when a technician has obtained a certification or is being recertified.

Assessments will be conducted on the techniques of sampling, splitting, and testing materials relevant to the materials a Producer provides to the Department.

If a technician is found deficient in any step within an assessment, the Assessment Technician shall indicate the error on the assessment form. The technician being assessed will be allowed one "Re-assessment." If the re-assessment is unsuccessful, the technician will be required to undergo further training by a representative of the Aggregate QC/QA Engineer, and if deemed necessary, may be required to retake the Aggregate QC/QA training course. In the event of an unsuccessful assessment, the Assessment Technician shall provide the Aggregate QC/QA Engineer with a copy of the assessment form which indicates the cause of the unsuccessful trial.

EXHIBIT I - SPECIFICATIONS (GRADATIONS, LL, and PI)

Stabilizer Aggregate (SA)

**TABLE I-1
AGGREGATE BASE COURSE FOR STABILIZATION
GRADATION ACCEPTANCE CRITERIA**

Sieve Size	% Passing
1 1/2"	100
1"	72-100
1/2"	51-83
No. 4	35-60
No. 10	20-50
No. 40	10-34
No. 200	3-13
Material Passing No. 40 Sieve	
L. L.	0-30
P. I.	0-6

TABLE I-2
AGGREGATE BASE COURSE FOR
ABC, ABC-Type A, CTBC, and Select Material Class IV
GRADATION ACCEPTANCE RANGES

Column A	Column B % Passing	Column C % Passing
1 1/2"	100	98-100
1"	75-97	72-100
1/2"	55-80	51-83
# 4	35-55	35-60
# 10	25-45	20-50
# 40	14-30	10-34
# 200	4-12	3-13
Material Passing No. 10 Sieve (Soil Mortar)		
*# 40	40-84	36-86
*# 200	11-35	10-36
Material Passing No. 40 Sieve		
L. L.	0-30	0-30
* P. I.	0-4	0-4

NOTE: * For information only, unless PI exceeds 4. If PI exceeds 4, soil mortar limits apply. If PI exceeds 6, material shall be rejected.

Cement Treated Base Course (CTBC)

Producer's Quality Control Sampling

Plant Sampling:

The lot size for aggregate base material for Cement Treated Base Course (CTBC) will be 2,000 tons of material, or a fraction thereof, shipped. The certified plant technician is to obtain a Quality Control (QC) sample weighing a minimum of 35 pounds from each lot of CTBC. Samples must be obtained using procedures outlined in Exhibit C and all samples must be taken prior to the addition of cement. Each sample is to be clearly identified. If a split sample is obtained, the other half of the sample will be retained and made available to the Department.

Rejections and Corrections:

If the Quality Control sample exceeds the limits shown in Column B of Table I-2, follow check sample procedures described in Section III of this manual. Once cement has been added to the material a check sample cannot be taken. The lot represented by the sample exceeding limits of Table I-2 will be rejected and shall be removed and replaced by the Contractor at no cost to the Department.

The material passing the No. 40 sieve shall not have a Liquid Limit in excess of 30 or a plasticity index in excess of 4. If any test result indicates values exceeding these, the lot will be rejected and shall be removed and replaced by the Contractor.

This page intentionally left blank.

EXHIBIT J- PROJECT CONSTRUCTION OF APPROVED STOCKPILES (ABC- TYPE B)

Approved Stockpiles (ABC-Type B, Project Specific Stockpiles)

The following flowchart summarizes the QC procedures when sampling and testing Type B ABC.

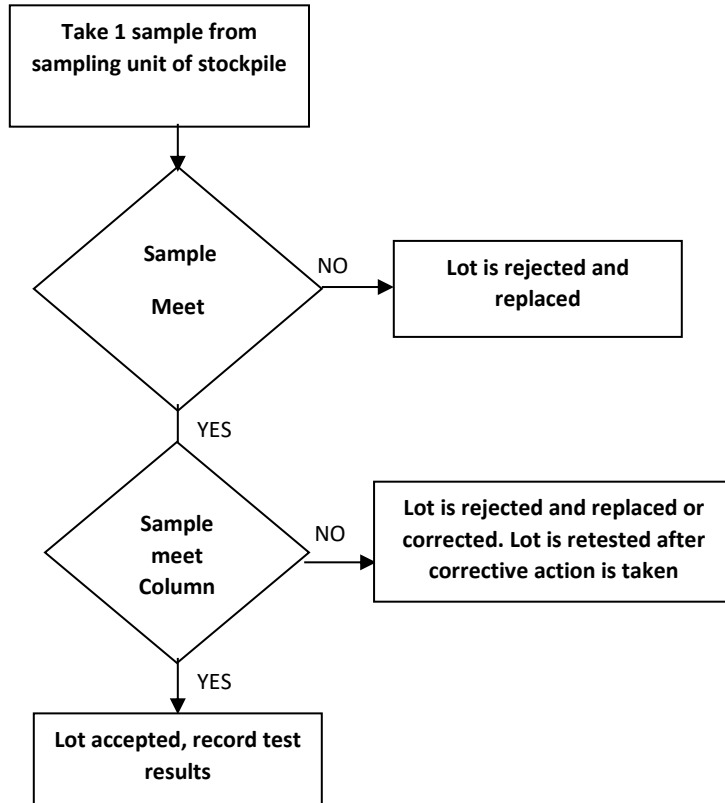

(Approved Stockpiles are stockpiles that are constructed for a specific project.)

Notification of Intent to Construct an Approved Stockpile

The Producer will submit to the Aggregate QC/QA Engineer a notification of intent to construct an Approved Stockpile at least one month prior to the anticipated start date for construction of the pile. The notification shall include the location of the stockpile, dimensions, total anticipated tonnage, source of material, construction schedule, intended project (including location, Resident Engineer, NCDOT Project Numbers, etc.), anticipated project quantities (pile quantity is not to exceed 10% of the estimated quantity required for the project), contractor, and contact information for all responsible producer and contractor personnel. The Producer shall notify the GeoMaterials Engineer at the completion of each layer and provide test results for approval prior to the next layer being added. Continue this process until the stockpile has been built to completion.

Construction

1. The area on which the stockpile is to be constructed shall be reasonably level and free from stumps, wood, trash, loose earth, or other deleterious materials before stockpiling begins.
2. The material shall be stockpiled in layers not exceeding two feet in thickness. Each layer shall be constructed of sub-layers which shall not exceed 8 inches in thickness. Each sub-layer shall be spread and/or mixed so that segregated spots and variability are eliminated prior to placing the next sub-layer.
3. Material placed in the stockpile shall be uniform and “spot” additions of corrective material will not be permitted unless it is shown that such methods produce a uniform, non-segregated material.
4. Stockpiles shall be designated numerically (1, 2, 3, etc.) to ensure proper records of sampling, testing, etc.
5. In order to facilitate construction, a stockpile may be constructed in sections which shall be designated alphabetically (A, B, C, etc.). The limits of each section shall be identified by properly maintained corner stakes as the work proceeds in order to expedite construction of the remaining layers.
6. Each layer shall be spread and thoroughly mixed prior to sampling. No further mixing shall be done after sampling.
7. A stockpile shall contain a minimum of 5 layers or 10 feet in height before approval is given. The layers shall be set back at the edges at least 6 inches so that no roll-down of material occurs.
8. The material shall contain approximately optimum moisture when placed in the stockpile. No sample shall be taken unless this condition is met.
9. Stockpiles shall exist separately and not connected to other stockpiles. Ramps used by equipment in constructing the stockpile shall be removed upon completion of the stockpile.
10. The top of a completed stockpile which is not to be used immediately shall be approximately level and shall contain a berm around the top edges at least 18 inches high to prevent wash down from rain.

Producer's Quality Control Sampling

The lot size will be 2,000 tons of material, or a fraction thereof, placed in a stockpile. The certified plant technician is to obtain a Quality Control (QC) sample weighing a minimum of 35 pounds. Sampling will be performed as described in Exhibit C, Section III.

**Table J-1
Type B Aggregate Base Course
Acceptance Criteria for Completed Stockpiles**

Column A	Column B % Passing
1 1/2"	100
1"	76-96
1/2"	58-76
#4	38-52
#10	28-42
#40	16-28
#200	5-11
Material Passing No. 10 Sieve (Soil Mortar)	
*#40	40-84
*#200	12-34
Material Passing No. 40 Sieve	
L.L.	0-30
*P.I.	0-4

NOTE: * For information only unless PI exceeds 4. If PI exceeds 4, soil mortar limits apply. If PI exceeds 6, material shall be rejected.

If the Quality Control sample does not meet the gradation requirements of Column B of Table I-2, or the LL and PI requirements of Column B of Table I-2, the procedures are as follows:

Correct the lot by either removing the material from the stockpile or by spreading the required amount of corrective material over the surface of the lot. Only one correction of a lot will be permitted, and correction will not be allowed when the amount of material required exceeds 6 inches in depth, in which case the lot will be rejected and removed.

NCDOT Quality Assurance Sampling

All QA samples are to be tested at a Department laboratory.

All QA samples will be sampled by the Producer with the Department representative present one QA sample shall be obtained for each 8,000 tons of material stockpiled or per visit to the approved stockpile, whichever occurs more often.

Stockpile Approval

The Producer will submit to the GeoMaterials Engineer a request for approval of the stockpile. The request shall include the location of the stockpile, dimensions, total tonnage, project (including location, Resident Engineer, NCDOT Project Numbers, etc.), and gradation summary (showing all individual QC Samples for the stockpile and the overall average gradation for the stockpile). In the event of three consecutive roadway assurance sample failures, the Department may withdraw the approval of the stockpile and will be sampled, tested, and accepted based on Exhibit I of this manual.

If the individual QC Samples meet the requirements of Column B of Table I-2 and the average of all QC Samples for the stockpile meet the requirements of Column B of Table J-1, the completed stockpile will be considered acceptable.

No additional material may be placed on a stockpile after it has been completed and approved. No material may be hauled from the stockpile until it has been approved.

EXHIBIT K AGGREGATE QC/QA SAMPLING AND TESTING TRAINING MANUAL

Test Procedures for Clean Coarse Aggregate and Fine Aggregate

Perform all aggregate sampling and testing in accordance with current specifications and procedures referenced in the *NCDOT Standard Specifications for Roads and Structures, Aggregate Sampling (Roadway)* and procedures outlined in this manual.

1. Test Procedures - Clean Coarse Aggregate

The sample is obtained from a stockpile, conveyor belt, or any other location approved by the Department according to established procedures and taken to the laboratory. When sampling Clean Coarse Aggregate, follow the sampling procedures listed in Exhibit C.

Each sample should be clearly identified by a properly filled out Sample Identification Card, (Exhibit D).

If the sample is to be split with half to be made available to the Department use the procedures for splitting a sample (using a splitter) listed in Exhibit D.

The split half of the Quality Control (QC) Sample, when approved by the Department on a site-by-site basis, may be rapid dried as long as care and judgment is taken to avoid overheating. When rapid drying a sample, follow procedures listed in Exhibit E.

Coarse aggregate will be tested for gradation in accordance with AASHTO T 27 procedures and the wash test will be performed in accordance with AASHTO T 11.

Washed Gradation Procedures – Clean Coarse Aggregate (AASHTO T 11)

Test Procedures:

1. Split sample until a workable size of 1,000 to 2,000 grams is obtained. Follow procedures for splitting a sample described in Exhibit D.
2. Once the sample is dried to a constant mass it is allowed to cool to the touch prior to proceeding with any testing procedures.
3. Weigh and record weight of sample (Total dry Wt.).
4. Place sample in a container and cover with water to assure a thorough separation of material finer than the No. 200 sieve from the coarser particles.
5. Using a large spoon vigorously agitate contents within the container.
6. Immediately pour the wash water over a nest of sieves that are arranged with the coarser sieve on top.
7. Care should be used to avoid pouring the coarse particles out of the container.
8. Add water as previously described and repeat the procedures.

9. Repeat this process until the wash water is clear.
10. All material retained on the nested sieves shall be returned to the washed sample.
11. The washed aggregate shall be dried to a constant mass at a temperature of 110 ° C (+/- 5 ° C) [230 ° F (+/- 9 ° F)]. If using the Rapid Dry method follow the procedures in Exhibit E.
12. Weigh and record weight of the sample (Wt. after washing).
13. Calculate the percent passing the No. 200 sieve.)

Calculation (formula):

$$\text{Percent Passing No. 200 Sieve} = \frac{(\text{Total dry Wt.} - \text{Wt. after washing})}{\text{Total dry Wt.}} \times 100$$

Example:

Assumption - a washed gradation test is performed on a sample of 57M material

$$\text{Total dry Wt.} = 1,520 \text{ grams}$$

$$\text{Wt. after washing} = 1,515 \text{ grams}$$

$$\text{Percent Passing No. 200 Sieve} = \frac{(1,520 - 1,515)}{1,520} \times 100$$

$$\text{Percent Passing No. 200 Sieve} = 0.3 \% \text{ **Passing**}$$

Sieve Size	Percent Passing	Specification (Percent Passing)
# 200	0.3	0 – 1.0

Note: This sample meets Specifications for 57M passing the No. 200 Sieve for material that is tested from a stockpile at the quarry site.

Sieve Analysis Procedures - Clean Coarse Aggregate (AASHTO T 27)

Test Procedures:

1. Once the sample is dried to a constant mass it is allowed to cool to the touch prior to proceeding with any testing procedures.
2. When testing material which 100% passes the $\frac{3}{4}$ sieve (such as #78, #14M, #9, etc), split the sample into a workable size of 10 to 15 pounds to avoid overloading sieves. Follow procedures for splitting a sample described in Exhibit D.
3. Based on the Specifications for the material being tested, the proper sieves are selected. Additional sieve(s) may be added as needed to determine Fineness Modulus or to prevent sieve overloading.
4. The sieves are placed into the mechanical shaker with the smallest opening on bottom and largest opening on top.
5. Weigh and record the weight of the sample.
6. Place the sample in the mechanical shaker and agitate for 10 minutes.
7. Carefully remove each sieve, weigh, and record the retained material (cumulatively) using the following steps:
 - a. Remove the top sieve weigh and record material retained.
 - b. Remove the next sieve from the shaker and add the retained material to the material from the first sieve.
 - c. Record cumulative weight from both sieves.
 - d. Remove the next sieve from the shaker and add the retained material to the material from the two previous sieves.
 - e. Record cumulative weight from all three sieves.
 - f. Repeat this process for each of the remaining sieves to the catch pan.
8. Verify mass of sample after sieving is within 0.3% of sample mass originally placed on nest of sieves.
9. Calculate the cumulative percent retained for each sieve.
10. Calculate the percent passing for each sieve.

Example of Calculating Percent Passing:

Assume a sieve analysis is performed on the 57M sample that was previously tested to determine the percent passing the No. 200 sieve (using the wash gradation test). Based on the test results, 0.3 percent passed the No. 200 sieve. The total weight of the (dry) sample used for the sieve analysis is **34.1 lbs.**

Step 1 - Determine Cumulative Percent Retained for each sieve:

$$\text{Cumulative Percent Retained} = \frac{\text{Cumulative Wt. retained}}{\text{Total dry Wt. of sample}} \times 100$$

Example of 1" Sieve

$$\text{Cumulative percent retained} = \frac{1.4}{34.1} \times 100 = \mathbf{4\% \text{ retained}}$$

Sieve Size	Cumulative lbs Retained	Cumulative Percent Retained
1 1/2"	0	0
1"	1.4	4
1/2"	25.9	76
#4	32.1	94
#8	33.5	98
Pan	34.1	100

Step 2 - Determine Percent Passing for each sieve:

$$\text{Percent Passing} = 100 - \text{Cumulative Percent Retained}$$

Example of 1" Sieve

$$100 - 4 = \mathbf{96\% \text{ passing}}$$

Sieve Size	Cumulative lbs Retained	Cumulative Percent Retained	Percent Passing	Specs 57M
1 1/2"	0	0	100	100
1"	1.4	4	96	95-100
1/2"	25.9	76	24	25-45
#4	32.1	94	6	0-10
#8	33.5	98	2	0-5
Pan	34.1	100	0	

Note: 1/2" sieve exceeds Specifications

Sieve Analysis – Clean Coarse Aggregate Work Problem 1

Check the following sieve analysis of a sample to determine if it meets the minimum specification requirements for a # 67 stone. This sample was taken at a Ready-Mix Concrete Plant. Circle any sieves, if any, which exceed the specifications.

Total weight of sample (oven-dried) = **35.6 lbs**

Sieve Size	Cumulative Lbs. Retained	Cumulative % Retained	Percent Passing	NCDOT Specs. (% Passing)
1"	0			100
¾ "	2.8			90 – 100
½ "	18.0			
3/8 "	27.4			20 – 55
#4	33.8			0 – 10
#8	35.0			0 – 5
Pan	35.6			
Passing #200 (wash method)				
#200			0.9	0 – 1.5

Does this sample meet the minimum Specifications for # 67 stone? _____

Note: The ½" sieve is not a standard size for # 67 stone. The information is needed for use in design and control of ready mixed concrete.

Sieve Analysis - Clean Coarse Aggregate Work Problem 2

Check the following sieve analysis of a sample to determine if it meets the specification requirements for a # 57 stone. This sample was taken at the quarry during production. Circle any sieves, if any, which exceed the specifications.

Total weight of sample (oven-dried) = **36.1 lbs**

Sieve Size	Cumulative lbs. Retained	Cumulative % Retained	Percent Passing	NCDOT Specs. (% Passing)
1 ½"	0			100
1 "	1.1			95 – 100
½ "	19.8			25 – 60
#4	34.1			0 – 10
#8	35.2			0 – 5
Pan	36.1			
Passing #200 (wash method)				
#200			0.5	0 – 0.6

Does this sample meet the Specifications for # 57 stone? _____

2. Test Procedures - Fine Aggregate

The sample is obtained from a stockpile, conveyor belt, or any other location approved by the Department according to established procedures and taken to the laboratory. When sampling Fine Aggregate, follow the sampling procedures listed in Exhibit D.

Each sample should be clearly identified by a properly filled out Sample Identification Card, (Exhibit C).

If the sample is to be split with half to be made available to the Department use the procedures for splitting a sample (using a splitter) listed in Exhibit D.

The split half of the Quality Control (QC) Sample, when approved by the Department on a site-by-site basis, may be force dried as long as care and judgment are taken to avoid overheating. When rapid drying a sample, follow procedures listed in Exhibit E.

Fine Aggregate will be tested for gradation in accordance with AASHTO T 27 procedures and the wash test will be performed in accordance with AASHTO T 11.

Washed Gradation Procedures - Fine Aggregate (AASHTO T 11)

Test Procedures:

1. Split sample until a workable size of 400 to 600 grams is obtained (Note: this sample size deviates from standard AASHTO procedures). Follow procedures for splitting a sample described in Exhibit D.
2. Once the sample is dried to a constant mass it is allowed to cool to the touch prior to proceeding with any testing procedures.
3. Weigh and record weight of sample (Total dry Wt.).
4. Place sample in a container and cover with water to assure a thorough separation of material finer than the No. 200 sieve from the coarser particles (ex. #8 - #16 plus #200 sieves).
5. Using a large spoon vigorously agitate contents within the container.
6. Immediately pour the wash water over a nest of sieves that are arranged with the coarser sieve on top.
7. Care should be used to avoid pouring the coarse particles out of the container.
8. Add water as previously described and repeat the procedures.
9. Repeat this process until the wash water is clear.
10. All material retained on the nested sieves shall be returned to the washed sample.
11. The washed aggregate shall be dried to a constant mass at a temperature of 110 ° C (+/- 5 ° C) [230 ° F (+/- 9 ° F)]. If using the Rapid Dry method follow the procedures in Exhibit E.
12. Weigh and record weight of the sample (Wt. after washing).
13. Calculate the percent passing the No. 200 sieve.

Calculation (formula):

$$\text{Percent Passing No. 200 Sieve} = \frac{(\text{Total dry Wt.} - \text{Wt. after washing})}{\text{Total dry Wt.}} \times 100$$

Example: Assumption - a washed gradation test is performed on a sample of 2S sand

$$\begin{aligned} \text{Total dry Wt.} &= 514.0 \text{ grams} \\ \text{Wt. after washing} &= 504.9 \text{ grams} \end{aligned}$$

$$\text{Percent Passing No. 200 Sieve} = \frac{(514.0 - 504.9)}{514.0} \times 100$$

Percent Passing No. 200 Sieve = (1.770) or 1.8 % Passing

Sieve Size	Percent Passing	Specification (Percent Passing)
# 200	1.8	0 – 3.0

Sieve Analysis Procedures - Fine Aggregate (AASHTO T 27)

Test Procedures:

1. Once the sample is dried to a constant mass it is allowed to cool to the touch prior to proceeding with any testing procedures.
2. Based on the Specifications for the material being tested, the proper sieves are selected. Additional sieve(s) may be added as needed to determine Fineness Modulus or to prevent sieve overloading.
3. The sieves are placed into the mechanical vibrator with the smallest opening on bottom and largest opening on top.
4. Weigh and record the weight of the sample.
5. Place the sample in the mechanical shaker and agitate for 10 minutes.
6. Carefully weigh and record the retained material on each sieve (cumulatively) using the following steps:
 - a. Carefully remove the nest of sieves from the shaker.
 - b. Remove the top sieve weigh and record material retained
 - c. Remove the next sieve and add the retained material to the material from the first sieve.
 - d. Record cumulative weight from both sieves
 - e. Remove the next sieve and add the retained material to the material from the two previous sieves.
 - f. Record cumulative weight from all three sieves
 - g. Repeat this process for each of the remaining sieves to the catch pan.
7. Verify mass of sample after sieving is within 0.3% of sample mass originally placed on nest of sieves.
8. Calculate the cumulative percent retained for each sieve.
9. Calculate the percent passing for each sieve.

Example of Calculating Percent Passing:

Assume a sieve analysis is performed on the 2S sand sample that was previously tested to determine the percent passing the No. 200 sieve (using the wash gradation test). Based on the test results, 1.8 percent passed the No. 200 sieve. The total weight of the (dry) sample used for the sieve analysis is **514.0 grams**.

Step 1 - Determine the Cumulative Percent Retained on each sieve:

$$\text{Cumulative Percent Retained} = \frac{\text{Cumulative Wt. retained}}{\text{Total dry Wt. of sample}} \times 100$$

Example of #4 Sieve

$$\text{Cumulative percent retained} = \frac{15.4}{514.0} \times 100 = \mathbf{3\% \text{ retained}}$$

Sieve Size	Cumulative gms Retained	Cumulative Percent Retained
3/8"	0	0
#4	15.4	3
#8	51.4	10
#16	154.2	30
#30	257.6	50
#50	416.9	81
#100	488.3	95

Step 2 - Determine the Percent Passing for each sieve:

$$\text{Percent Passing} = 100 - \text{Cumulative Percent Retained}$$

Example of #4 Sieve

$$100 - 3 = \mathbf{97\% \text{ passing}}$$

Sieve Size	Cumulative gms Retained	Cumulative Percent Retained	Percent Passing	Specs 2S
3/8"	0	0	100	100
#4	15.4	3	97	95-100
#8	51.4	10	90	80-100
#16	154.2	30	70	45-95
#30	257.6	50	50	25-75
#50	416.9	81	19	5-30
#100	488.3	95	5	0-10

Verifying Sample Mass After Sieving is within Tolerance

Per Step 7 of “Sieve Analysis Procedures - Fine Aggregate (AASHTO T27)” on Page 60, the mass of a sample after sieving shall be within 0.3% of the sample mass originally placed on the nest of sieves.

Example:

Assume: 2S sand and #200 was determined using the wash method

- Total weight of dry sample 573.0 grams (before washing)
- Total weight of dry sample 557.4 grams (after washing)

** Since sample was washed, use total oven dried weight after washing (material placed in nest of sieves)

Use the following formula to calculate:

$$\text{Tolerance} = \text{Oven Dry Wt. (placed on sieves)} \times 0.003$$

$$= 557.4 \text{ grams} \times 0.003 = \mathbf{1.67 \text{ grams}}$$

Therefore:

$$557.4 \text{ grams} + 1.67 = \mathbf{559.07 \text{ grams (upper limit)}}$$

and

$$557.4 \text{ grams} - 1.67 = \mathbf{555.73 \text{ grams (lower limit)}}$$

Therefore:

The cumulative weight of material retained on the pan, after sieving, shall be between 559.07 grams and 555.73 grams to be within tolerance.

Sieve Analysis - Fine Aggregate Work Problem 1

Determine if the following sieve analysis of a sample meets the specification requirements for a 2MS sand. This sample was taken at the quarry prior to shipment. Circle sieves, if any, which exceed the specifications.

Total weight of sample (oven-dried) = **547.9 grams**

Weight of sample after washing #200 = **506.5 grams**

Sieve Size	Cumulative gms Retained	Cumulative % Retained	Percent Passing	NCDOT Specs. (% Passing)
3/8 "	0			
#4	6.7			95 – 100
#8	68.8			80 – 100
#16	183.4			45 – 95
#30	355.3			25 – 75
#50	452.5			5 – 35
#100	503.9			0 - 20
Pan	506.5			
Passing #200 (wash method)				
#200				0 - 8

Does this sample meet the minimum Specifications for 2MS sand? _____

3. Fineness Modulus (F.M.)

Fineness Modulus is defined by the American Concrete Institute (ACI) as “*an empirical factor obtained by adding the total percentages (by weight) of an aggregate sample retained on each of a specified series of sieves, and dividing the sum by 100*”. The Standard Size Sieves are 6”, 3”, 1 ½”, ¾”, 3/8”, No. 4, No. 8, No. 16, No 30, No. 50, and No. 100. It is an index to the fineness or coarseness of the aggregate. The F.M. is an index of the fineness of the aggregate and should not be less than 2.3 or more than 3.1, nor vary by more than 0.20 from batch to batch.

F.M. Rating	Index Range
Coarse Sand	2.80 – 3.10
Medium Sand	2.50 – 2.80
Fine Sand	2.30 – 2.50

(**Note:** When testing the gradation, the No. 200 sieve is used as required in the Specification. However, it is **not** used in calculating the F.M. Do **not** include material retained in the Pan when calculating the F.M.)

Fineness Modulus Example

Total weight of the sample (oven-dried before washing) = **514.8 grams**
Oven dry weight (after washing #200) = **504.0 grams**

Step 1 – Determine Cumulative Percent Retained on each sieve

$$\text{Cumulative Percent Retained} = \frac{\text{Cumulative Wt. retained}}{\text{Total dry Wt. of sample}} \times 100$$

Sieve Size	Cumulative gms Retained	Cumulative % Retained
3/8 “	0	0
#4	15.1	3
#8	50.4	10
#16	119.9	23
#30	289.1	56
#50	434.2	84
#100	490.9	95
Pan	504.0	

Step 2 – Determine the Fineness Modulus Index

The Fineness Modulus (F.M.) is defined mathematically as the sum of the cumulative percentages retained on standard sieves divided by 100.

$$\text{F.M. Index} = \frac{(0 + 3 + 10 + 23 + 56 + 84 + 95)}{100} = \frac{271}{100} = \mathbf{2.71}$$

Fineness Modulus Work Problem 1

Complete the following sieve analysis to determine if this sample of 2S material for use in concrete meets minimum Specifications. This sample was taken at the job site prior to use. Calculate the Fineness Modulus (F.M.) of this material.

Total weight of sample (oven-dried) = **573.0 grams**

Weight of sample (after washing #200) = **557.4 grams**

Sieve Size	Cumulative gms Retained	Cumulative % Retained	Percent Passing	NCDOT Specs. (% Passing)
3/8 "	0			100
#4	0			95 – 100
#8	22.9			80 - 100
#16	171.9			45 – 95
#30	286.5			25 – 75
#50	429.8			5 – 30
#100	521.4			0 – 10
Pan	557.4			
Passing #200 (wash method)				
#200				0 – 3

Determine the F.M. Index = _____

Based on the F.M. Index, this material is rated as a _____ Sand.

- A. Coarse
- B. Medium
- C. Fine

AGGREGATE QC PROCESS- FLOW CHART

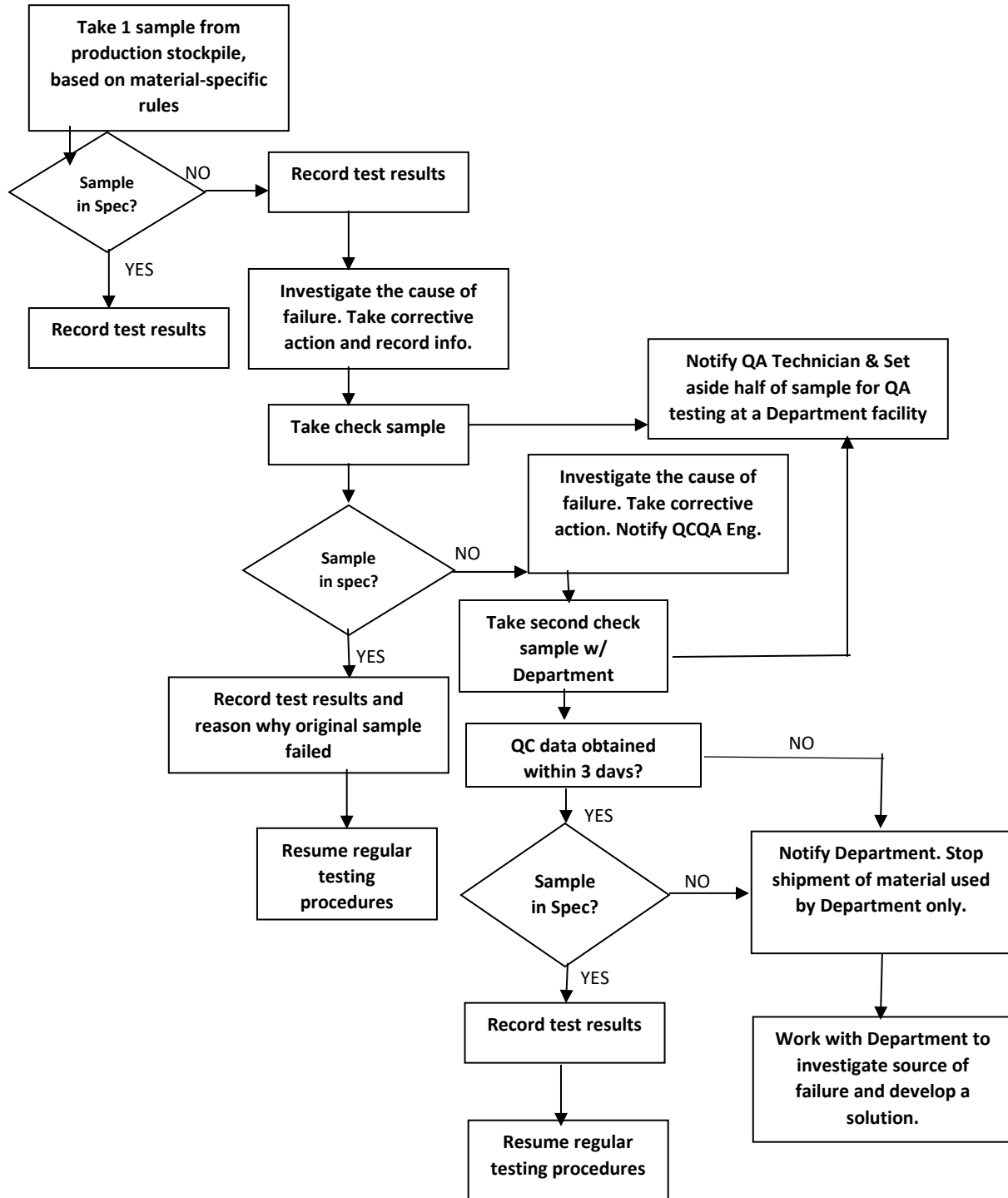

CLEAN COARSE AGGREGATE AND FINE AGGREGATE QA PROCESS – FLOWCHART

The following flowchart summarizes the QA procedures for sampling and testing clean coarse and fine aggregate.

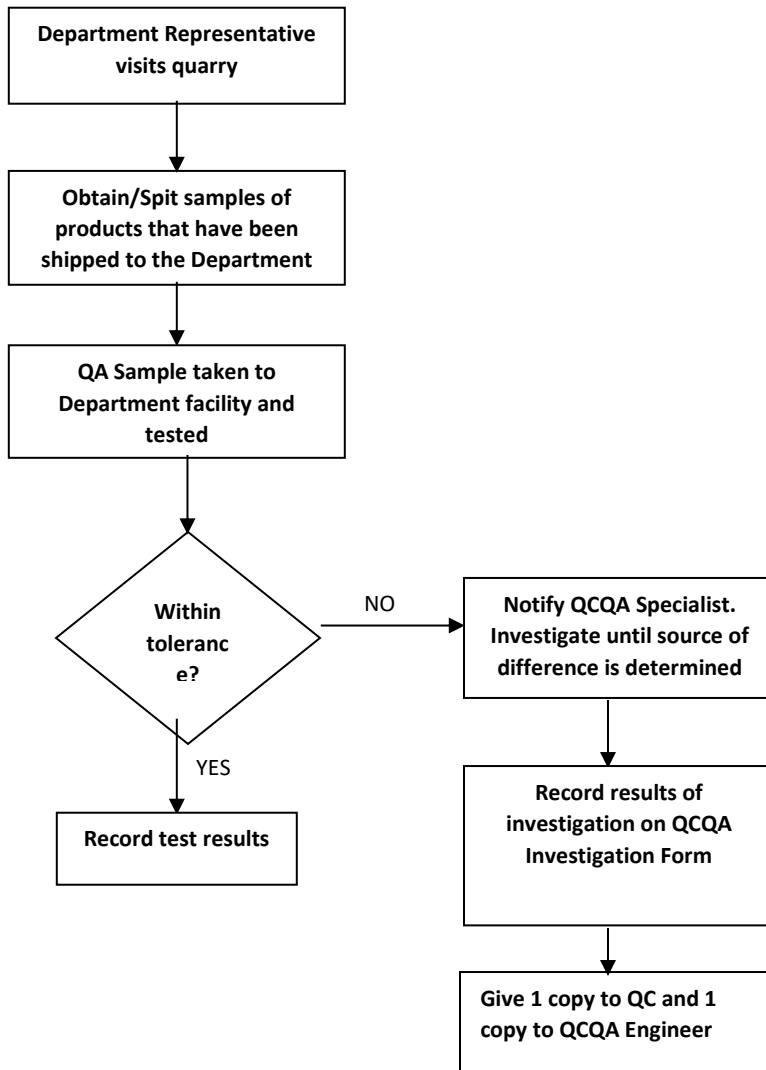

Example of QC Sampling

Scenario: Beginning the second week of January Hard Rock Quarry begins shipping 57M for the first time this calendar year. This material is being shipped to a local concrete producer, asphalt producer, and Department maintenance facility. Based on production and amount of material ordered this material will be shipped for approximately the next 3 weeks. The following tables summarize the tonnage shipped each day along with number of samples and sample numbering.

Week 1 of shipping 57M (for the calendar year)				
Day	Quantity Shipped	Destination	Samples	Remarks
Monday	650 tons	Concrete and Asphalt	QC-1	First sample of material for year
Tuesday	855 tons	Concrete, Asphalt and DOT	No sample	
Wednesday	2,020 tons	Concrete, Asphalt and DOT	QC-2	
Thursday	1,220 tons	Concrete, Asphalt and DOT	No sample	
Friday	600 tons	Concrete and Asphalt	QC-3	Close out the week

During Week 1 of this scenario 5,345 tons of 57M were shipped. Based on the minimum sampling frequency of one sample per 2,000 tons, 2.67 samples are required. In order to prevent a possible shortage of samples we **strongly** recommend “closing out” each week. Therefore, for this example, 3 samples are obtained and tested.

Week 2 of shipping 57M				
Day	Quantity Shipped	Destination	Samples	Remarks
Monday	4,220 tons	Concrete and Asphalt	QC-4, QC-5	
Tuesday	3,320 tons	Concrete, Asphalt and DOT	QC-6, QC-7	
Wednesday	4,140 tons	Concrete, Asphalt and DOT	QC-8, QC-9	
Thursday	2,125 tons	Concrete, Asphalt and DOT	QC-10	Total tonnage for week 13,805 tons
Friday	1,020 tons	Concrete and Asphalt	QC-11	Close out the week

During Week 2 of this scenario 14,825 tons of material was shipped. Based on the minimum sampling frequency of one sample per 2,000 tons, 7.41 samples are required. In order to prevent a possible shortage of samples we **strongly** recommend “closing out” each week. Therefore, for this example, 8 samples are obtained and tested.

Week 3 of shipping 57M				
Day	Quantity Shipped	Destination	Samples	Remarks
Monday	0 tons		No sample	
Tuesday	100 tons	DOT	No sample	
Wednesday	100 tons	Concrete	No sample	
Thursday	40 tons	DOT	QC-12	1 sample per week
Friday	0 tons		QC-13	Split Sample (QA-13) obtained when Department representative visits plant

During Week 3 of this scenario 240 tons of material was shipped for the week. Though less than 2,000 tons of material was shipped this week a minimum of one sample is required if any material is shipped. QC-13 obtained on Friday was required due to a visit by a Department representative.

TEST PROCEDURES – AGGREGATE BASE PRODUCTS

1. Types of Aggregate Base Products

Aggregate Base Course (ABC) consists of a well-graded blend of fine and coarse aggregate particles. When ABC is placed meeting the required specifications and compacted to the minimum density requirements, it functions as an excellent foundation for the pavement structure. The major structural function of an aggregate layer serving as a pavement base course or sub-base is to distribute the stresses applied to the pavement surface from traffic loading. Aggregate Base Course can provide sufficient strength and rutting resistance to maximize bearing capacity and reduce rutting failure within the pavement layers. A quality ABC layer can also provide additional benefits such as, controlling pumping, reducing frost action, improving drainage of surface or subsurface water, controlling volume change in the subgrade when expansive soils are present, and minimizing the lateral movement of the flexible pavement system.

Cement Treated Base Course (CTBC) is an aggregate base material with the addition of cement and is generally used on highways with high traffic volumes. CTBC offers the same benefits as ABC; however, the addition of cement provides a higher strength or bearing capacity.

Aggregate Base Course (Modified) (ABC-M) is an aggregate base type product with a different gradation specification when compared to ABC. ABC-M is generally used for maintenance stabilization.

Stabilizer Aggregate (SA) is an aggregate base type product with a different specification requirement when compared to ABC. SA is generally used on construction projects for subgrade stabilization.

2. Types of ABC

Type A ABC – Production Stockpile. Type A ABC is ABC from a production stockpile. A production stockpile can have new material added while existing material is being shipped to a customer.

Type B ABC – Approved Stockpile. Type B ABC is ABC that is used to build an Approved Stockpile. An Approved Stockpile differs from a production pile in that specific procedures must be followed as it is constructed. Additional information regarding Approved Stockpiles is provided in Exhibits I and J.

When sampling aggregate base material, the sample is obtained from a stockpile, conveyor belt, or any other location approved by the Department according to established procedures and taken to the laboratory. When sampling aggregate base material, follow the sampling procedures listed in Exhibit C.

Each sample should be clearly identified by a properly filled out Sample Identification Card, see Exhibit D.

Use the procedures for splitting a sample (using a splitter) listed in Exhibit D.

The Quality Control (QC) Sample, when approved by the Department on a site-by-site basis, may be force dried as long as care and judgment are taken to avoid overheating. When rapid drying a sample, follow procedures listed in Exhibit E. If a facility is required by the Department to test for Plasticity Index (P.I.) then the sample must be dried at a temperature not exceeding 60 ° C or 140 ° F. Therefore, Rapid Drying is not allowed when a sample is to be tested for plasticity.

3. Test Procedures – Aggregate Base Products

Sieve Analysis Procedures – Aggregate Base Products (AASHTO T 27)

Test Procedures:

1. Once the sample is dried to a constant mass it is allowed to cool to the touch prior to proceeding with any testing procedures.
2. The 1 ½", 1", ¾", ½", ⅜", #4 and #10 sieves are placed in the mechanical shaker with the smallest openings on bottom and largest openings on top. A pan is placed in the shaker to catch the -#10 material. The ¾" and ⅜" sieves are not necessary to determine gradation but are inserted to prevent overloading other screens.
3. Weigh and record the weight of the sample.
4. Place the sample in the mechanical shaker and agitate for 10 minutes.
5. Carefully remove each sieve, weigh, and record the retained material using the following steps:
 - a. Weigh and record material retained on the 1 ½" sieve.
 - b. Add retained material from the 1" sieve to the 1 ½" material.
 - c. Weigh and record the cumulative weight of material retained on 1" sieve.
 - d. Add retained material from the ¾" sieve to the 1 ½" and 1" material.
 - e. Add retained material from the ½" sieve to the 1 ½", 1", and ¾" material.
 - f. Weigh and record as the cumulative weight of material retained on the ½" sieve.
 - g. Add retained material from the ⅜" sieve to the 1 ½", 1", ¾", and ½" material.
 - h. Add retained material from the #4 sieve to the 1 ½", 1", ¾", ½", and ⅜" material.
 - i. Weigh and record the cumulative weight of material retained on the #4 sieve.
 - j. Add retained material from the #10 sieve to the 1 ½", 1", ¾", ½", ⅜", and #4 material.
 - k. Weigh and record the cumulative weight of material retained on the #10 sieve.
 - l. The - #10 material in the shaker pan is reduced by splitting to a sample size of approximately 800 – 1200 grams and placed in a sample can. This sample of - #10 material is used to determine the percent passing the #40 and #200 sieves and, if required, the Liquid Limit (L.L.) and Plasticity Index (P.I.).
6. Split sample until a minimum of 300 grams is obtained. The remaining - #10 material is set aside for determining Liquid Limit and Plasticity Index if required.
7. Weigh and record weight of sample (Total Dry Wt., pre-washing).
8. Place sample in container and cover with water.

9. Using a large spoon vigorously agitate contents within the container to assure a thorough separation of material finer than the #200 sieve from the coarser particles.
10. Immediately pour the wash water over a nest of sieves that are arranged with the coarser sieve on top (ex. #8 - # 16 plus the #200 sieves).
11. Care should be used to avoid pouring the coarse particles out of the container.
12. Add water as previously described and repeat steps from 9 – 11.
13. Repeat this process until the wash water is clear.
14. All material retained on the nested sieves shall be returned to the container.
15. The washed aggregate shall be dried to a constant mass at a temperature of 110°C ($\pm 5^{\circ}\text{C}$ [230°F ($\pm 9^{\circ}\text{F}$)]. If using the Rapid Dry method, follow procedures in Exhibit D.
16. Once the sample is dried it must be allowed to cool to the touch prior to performing any additional tests.
17. Weigh and record weight of the sample (Total Dry Wt., after washing). Calculate the percent passing the #200 sieve.
18. Place sample in a mechanical shaker with a nest of sieves, including a catch pan, and cover plate. The sieve sizes are as follows: #30, #40, #100, and #200 (place sieves with the largest openings on top and the smallest on bottom). The #30 and #100 are included to prevent overloading of the sieves.
19. The sample is screened for 10 minutes in the mechanical shaker.
20. Add the material retained on the #30 sieve to the material retained on the #40 sieve.
21. Weigh and record the material retained on the #40 sieve.
22. Add the material retained on the #100 sieve to the material retained on the #40 sieve.
23. Add the material retained on #200 sieve to the #40 and #100 material.
24. Weigh and record the cumulative material from the #40, #100, and #200 sieve to determine the cumulative weight retained on the #200 sieve.
25. Verify mass of sample after sieving is within 0.3% of mass placed on nest of sieves.
26. Calculate the cumulative percent retained on each sieve to the #10 sieve.
27. Calculate the percent passing each sieve down to the #10 sieve.
28. Calculate the cumulative percent retained on the #40 and #200 sieve (- #10 material or Soil Mortar).
29. Calculate the percent passing on the #40 and #200 sieves.
30. Complete the gradation results with the percent passing for each sieve (top to bottom).
31. When reporting the #200, use the percent passing the #200 sieve calculated after performing the wash process.

Example of Calculating Percent Passing:

Assume this sieve analysis is performed on ABC. The total weight of the (dry) sample used for the sieve analysis is **41.4 lbs.**

Step 1 - Determine Cumulative Percent Retained for each sieve:

$$\text{Cumulative Percent Retained} = \frac{\text{Cumulative Wt. retained}}{\text{Total dry Wt. of sample}} \times 100$$

Example of 1" Sieve Cumulative Percent Retained = $\frac{2.3}{41.4} \times 100 = 6\% \text{ retained}$

Sieve Size	Cumulative lbs Retained	Cumulative Percent Retained
1 1/2"	0	0
1"	2.3	6
1/2"	13.3	32
#4	23.7	57
#10	29.1	70
Pan		

Step 2 - Determine Washed #200 sieves from - #10 material (Soil Mortar @#200):

Calculation (formula):

$$\text{Percent Passing No. 200 Sieve} = \frac{(\text{Total dry Wt.} - \text{Wt. after washing})}{\text{Total dry Wt.}} \times 100$$

Example:

Assumption - this sieve analysis for the - #10 (Soil Mortar) material began with a dry weight of **320.0 grams**

$$\begin{aligned} \text{Total dry Wt.} &= 320.0 \text{ grams} \\ \text{Wt. after washing} &= 227.2 \text{ grams} \end{aligned}$$

$$\text{Percent Passing No. 200 Sieve} = \frac{(320.0 - 227.2)}{320.0} \times 100$$

$$\text{Percent Passing No. 200 Sieve} = \mathbf{29\% \text{ Passing}}$$

Step 3 - Determine Cumulative Percent Retained for the #40 from -#10 material (Soil Mortar @#40) after Rotaping material:

$$\text{Cumulative Percent Retained} = \frac{\text{Cumulative Wt. retained}}{\text{Total dry Wt. of sample}} \times 100$$

Example of #40 Sieve

$$\text{Cumulative percent retained} = \frac{153.6}{320.0} \times 100 = 48 \% \text{ retained}$$

Sieve Size	Cumulative gms Retained	Cumulative Percent Retained
#40	153.6	48
#200	-	-

Step 4 - Determine Percent Passing for each sieve:

$$\text{Percent Passing} = 100 - \text{Cumulative Percent Retained}$$

Example of 1" Sieve

$$100 - 6 = 94 \% \text{ passing}$$

Sieve Size	Cumulative lbs Retained	Cumulative Percent Retained	Percent Passing
1 1/2"	0	0	100
1"	2.3	6	94
1/2"	13.3	32	68
#4	23.7	57	43
#10	29.1	70	30

Example of #40 Sieve (Soil Mortar):

$$100 - 48 = 52 \% \text{ passing}$$

Sieve Size	Cumulative gms Retained	Cumulative Percent Retained	Percent Passing
#40	153.6	48	52
#200	-	-	29

**From Washed #200 Calculations
(See Step 2)**

Step 5 – Determine Percent Passing for each sieve (total sample):

Percent Passing Total Sample (#40) = % Passing #10 x % Passing #40 x 100

Example: % Passing #40 (total) = 0.30 x 0.52 x 100 = 15.6 or **16 % Passing**

Percent Passing Total Sample (#200) = % Passing #10 x % Passing #200 x 100

Example: % Passing #200 (total) = .30 x .29 x 100 = 8.7 or **9 % Passing**

Sieve Size	Percent Passing
1 ½”	100
1”	94
½”	68
#4	43
#10	30
#40	16
#200	9
Soil Mortar	
#40	52
#200	29

Sieve Analysis – ABC Work Problem 1

Assume the following results represent sample QC-20. Determine the percent passing each sieve (including Soil Mortar). Total weight of the sample is **42.1 lbs.** A **305.5gram** sample was used to test the soil mortar (#40 and #200 sieves). After washing, the sample weighed **234.90grams.**

Sieve Size	Cumulative lbs Retained	Cumulative Percent Retained	Percent Passing
1 ½”	0		
1”	2.9		
½”	13.5		
#4	22.6		
#10	27.20		
#40	-----	-----	
#200	-----	-----	
Soil Mortar			
#40	87.3 gms		
#200	234.9 gms		

Sieve Analysis – ABC Work Problem 2

Assume the following results represent sample QC-21. Determine the percent passing each sieve (including Soil Mortar). Total weight of the sample is **41.6 lbs.** A **306.9gram** sample was used to test the soil mortar (#40 and #200 sieves). After washing, the sample weighed **228.4grams.**

Sieve Size	Cumulative lbs Retained	Cumulative Percent Retained	Percent Passing
1 ½”	0		
1”	1.0		
½”	18.4		
#4	24.5		
#10	28.7		
#40	-----	-----	
#200	-----	-----	
Soil Mortar			
#40	91.0gms		
#200	228.4gms		

Gradation Specifications – ABC Work Problem 1

Using the results from Work Problems 1 and 2 (QC-20 & QC-21), determine if any of the two lots sampled exceed Specifications for Gradation. Place a single asterisk beside any sieve exceeding specifications. The specifications are provided and are also listed in Table 1A-Exhibit G.

Sieve Size	Percent Passing QC-20	Percent Passing QC-21	Gradation Specs Column B	Gradation Specs Column C
1 ½”			100	98 – 100
1”			75 – 97	72 – 100
½”			55 – 80	51 – 83
#4			35 – 55	35 – 60
#10			25 – 45	20 – 50
#40			14 – 30	10 – 34
#200			4 – 12	3 – 13
Soil Mortar				
#40			40 – 84	36 – 86
#200			11 - 35	10 - 36

(*) - Gradation Specification exceeded

Atterberg Limit (Liquid Limit and Plasticity Index) Procedures

If the quarry has been identified by the Department as having potential problems with Liquid Limit (LL) or Plasticity Index (PI), the Atterberg Limits tests must be verified by at least one QC sample every 6,000 tons of material shipped. The Liquid Limit is defined as the moisture content determined by AASHTO T 89. The Plastic Limit is defined as the moisture content by AASHTO T 90. The Plasticity Index (PI) is the numerical difference between the Liquid Limit and Plastic Limit (**P.I. = L.L. – P.L.**).

Obtaining - #40 Material

To determine the Atterberg Limits, use the remaining - #10 material that was set aside while performing the sieve analysis (Step 5 k). Since the Liquid Limit and Plasticity Index are determined on the - #40 material, the sample must be separated into two parts. This can be accomplished by sieving the material over a #40 sieve and a catch pan. The fraction retained on the #40 sieve shall be ground in a mortar with a rubber-covered pestle or suitable mechanical device in such a manner as to break up the aggregation of material particles without fracturing the individual grains. If the sample contains brittle fragments such as flakes of mica, fragment of seashell, etc., the grinding operation shall be done carefully and with just enough pressure to free the fragments from adhering to particles of finer material. After grinding the sample, it is to be re-sieved over the #40. The grinding and sieving process are repeated until the following conditions are met:

- Repeated grinding only produces a small amount of - #40 material
- Rubbing the + #40 material between the thumb and forefinger indicates the material is clean

Once clean, the remaining + #40 material is discarded. The - #40 material (in catch pan) is thoroughly mixed and placed into a sample can. This sample will be used to determine the Liquid Limit and Plasticity Index and should be clearly identified.

Inspection and adjustment of Atterberg (or Liquid Limit) Device

The Atterberg Device shall be inspected to determine that it is in good working order, that the pin connecting the cup is not worn sufficiently to permit side play; that the screws connecting the cup to the hanger arm are tight; and that a groove has not been worn in the cup through long usage. The grooving tool shall be inspected to determine that the critical dimensions are as shown in Figure 1.

By means of the gauge on the handle of the grooving tool, and the adjustment plat H Figure 1, the height to which the cup C is lifted shall be adjusted so that the point on the cup which comes in contact with the base is exactly 1 cm (0.3937 in.) above base. To adjust for the one-centimeter lift, the strike point on the cup must be determined. To determine the strike point, place carbon paper between the cup and rubber base and turn the handle several times to get a carbon mark on the bottom of the cup. Place a piece of scotch tape across the middle of the carbon mark and slide the handle of the grooving tool or height gauge supplied with the device,

until it touches the tape. The adjustment plate H shall then be secured by tightening the screws, I. With the gauge still in place, the adjustment shall be checked by revolving the crank rapidly several times. If the adjustment is correct, a slight ringing sound will be heard when the cam strikes the cam follower. If the cup is raised off the gauge or no sound is heard, further adjustment shall be made.

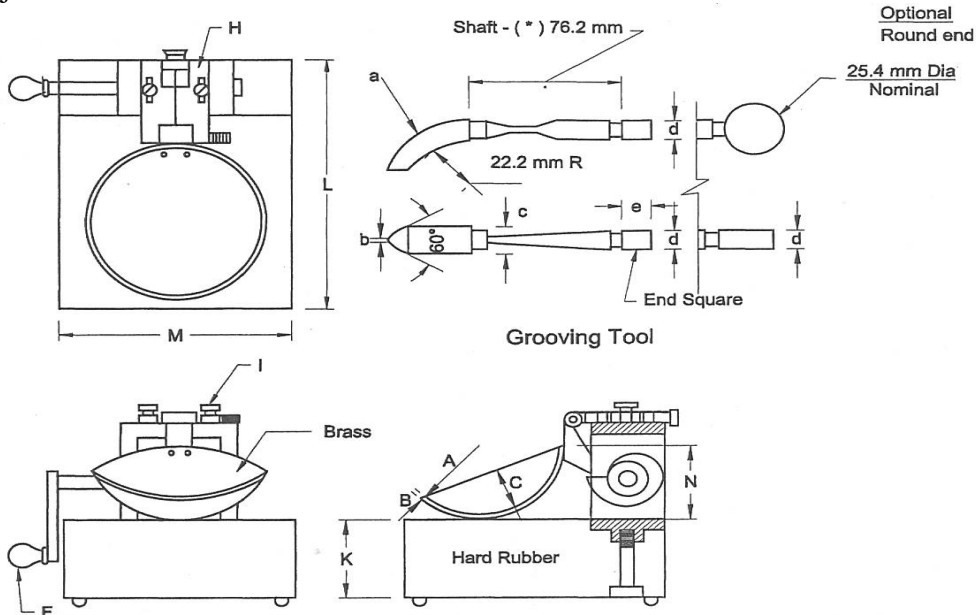

Figure 1 – Atterberg Device

Note: Plate “H” may be designed for using (1) one securing screw (I).

An additional wear tolerance of 0.1 mm shall be allowed for dimension “b” for used grooving tools.

Feet for base shall be of resilient material.

(*) Nominal dimensions.

All tolerances specified are plus or minus (+/-) except as noted above.

No Liquid Limit results required if test cannot be performed (i.e., the material is non-plastic).

1. Verify the Atterberg Device is calibrated for a 1 centimeter drop of the brass cup.
2. Thoroughly mix and obtain 50 to 100 grams of the - #40 material and place it in an evaporating dish.
3. Add water to the sample in the dish.
4. Mix the sample and water together with a spatula by stirring and kneading the sample.
5. If needed, continue adding water and mixing until the sample is near the Liquid Limit (based on judgment and experience of person conducting test).
6. Using the spatula, place material in the lower half of the brass cup using as few strokes as possible (excess strokes will bring the water to the top of the sample).
7. Using the spatula strike off the sample to a depth of 1 centimeter in the cup.
8. Using the grooving tool, make a groove in the sample from the top to the bottom (verify the sample and grooving tool blade are the same depth).
9. Attach the brass cup to the Atterberg Device.
10. Turn the crank 25 times at a rate of approximately 2 turns per second.
11. If the sample comes or flows together on the 25th blow between ¼” to ½” in the cup, then the material is considered to be at its liquid limit. If this does not occur on the 25th blow then the sample will have to be dried or more water added to reach the liquid limit.
12. If repeating these steps to achieve the liquid limit, thoroughly clean and dry the grooving tool and brass cup between each series.
13. If the requirements are met, use the spatula to obtain a slice of material which flowed together by cutting at right angles to the groove from edge to edge (approximately 30 grams).
14. Place the sample into a moisture can or watch glass of known weight.
15. Weigh and record the weight of the sample.
16. Place the sample in an oven set at 110 ° C (+/- 5 °) or 230 ° F (+/- 9 °) for three hours or until dry.
17. Carefully (Caution: Hot) remove sample from oven.
18. Place glass on top of container to determine if moisture is forming on the glass. If moisture forms, place sample back in oven. Repeat this process until the sample is dry.
19. If dry, allow sample to cool to room temperature.
20. Weigh and record weight
21. Calculate percent of moisture and record
22. Discard material

If the Liquid Limit test cannot be performed, report the Plasticity Index (P.I.) as non-plastic (N.P.).

1. Take the remaining material in the brass cup (from Liquid Limit test) and form it into a ball (approximately 15 grams).
2. Break the ball into 4 approximately equal ellipsoidal masses and place each on unglazed paper.
3. Using your fingers, roll each ellipsoidal mass individually (on the paper) out into a 1/8" diameter thread. Use only minimal pressure with your fingers and roll at an angle.
4. Repeat the rolling process on the paper until the material crumbles before reaching a 1/8" diameter thread.
5. Once the first piece is rolled down, collect and set it to the side. Repeat this procedure with each of the remaining (3) pieces (Steps 3 and 4). Note: Use clean paper for each mass "roll-down".
6. Re-roll the total sample into one ball with your fingertips.
7. Place the sample into a moisture can or watch glass of known weight.
8. Weigh and record the weight of the sample.
9. Place the sample in an oven set at 110 ° C (+/- 5 °) or 230 ° F (+/- 9 °) for three hours or until dry.
10. Carefully (Caution: Hot) remove sample from oven.
11. Place glass on top of container to determine if moisture is forming on the glass. If moisture forms, place sample back in oven. Repeat this process until the sample is dry.
12. If dry, allow sample to cool to room temperature.
13. Weigh and record weight.
14. Calculate percent of moisture and record.
15. Discard material.

Formulas/Calculations - Liquid Limit, Plastic Limit, and Plasticity Index:

$$\text{Liquid Limit (LL)} = \frac{(\text{Wt. cup and Wet Soil} - \text{Wt. cup and Oven Dry Soil})}{\text{Wt. of Oven Dry Soil}} \times 100$$

$$\text{Plastic Limit (PL)} = \frac{(\text{Wt. Cup and Wet Soil} - \text{Wt. Cup and Oven Dry Soil})}{\text{Wt. of Oven Dry Soil}} \times 100$$

$$\text{Plasticity Index (PI)} = \text{Liquid Limit (LL)} - \text{Plastic Limit (PL)}$$

Example of Liquid Limit, Plastic Limit, and Plasticity Index

Liquid Limit Results (Wt. in grams)				
Wt. of Cup	Wt. of Cup & Wet Soil	Wt. of Cup & Dry Soil	Wt. of Dry Soil	Wt. of Water
66.3	86.0	82.2	15.9	3.8

$$\text{Liquid Limit (LL)} = \frac{(86.0 - 82.2)}{15.9} \times 100 = \mathbf{23.8}$$

Plastic Limit Results (Wt. in grams)				
Wt. of Cup	Wt. of Cup & Wet Soil	Wt. of Cup & Dry Soil	Wt. of Dry Soil	Wt. of Water
63.1	75.0	72.9	9.8	2.1

$$\text{Plastic Limit (PL)} = \frac{(75.0 - 72.9)}{9.8} \times 100 = \mathbf{21.4}$$

$$\text{Plasticity Index (PI)} = 23.8 - 21.4 = \mathbf{2.4}$$

AGGREGATE BASE COURSE PRODUCTS QC/QA SPLIT SAMPLES THAT ARE OUT OF TOLERANCE

When QC and QA split samples of Aggregate Base Course material is found to be out of tolerance with Exhibit G -Table II, and investigation by the Department should be conducted to determine the cause of the discrepancy. This investigation may include, but is not limited to, reviewing QC/QA testing data, technician assessments, lab inspections, monitoring future samples, etc. The details of this investigation shall be recorded on the Department's QC/QA Investigation form. Once completed one copy of this form shall be provided to the Producer, and another copy supplied to the Aggregate QC/QA Engineer.

If the tolerance issue is found to be a procedural or equipment issue on the part of the Producer, the Department will notify the Producer and indicate the issue and resolution on the investigation form. Frequent procedural errors and/or equipment issues may result in the QC Technician being required to have additional training, loss of certification, or removal of the Producer from the Approved Producers List.

If the tolerance issue is found to be a result of the Department's sampling and testing procedures, the cause and resolution shall be indicated on the investigation form. Frequent procedural errors and/or equipment issues may result in the responsible Sampling/Testing Technician being required to have additional training, loss of certification, or separation from the Department.

SAMPLE SELECTION, NUMBERING, AND IDENTIFICATION

A verifiable random selection process must be used when sampling base course material. Randomly selecting a sample location prevents biased sampling and a simple procedure using random numbers can accomplish this task. An example of computer-generated numbers may be as follows: For random numbers, use ASTM random number charts, random numbers provided below, or any other method approved by Materials and Tests.

(I) RANDOM SAMPLE NUMBERS

1	2	3	4	5	6	7	8	9	10	11	12	13	14	15	16	17	18	19	20	21	22	23	24	25	26	27	28	29	30	31	32
2	9	5	2	6	6	4	1	3	9	9	2	9	7	9	2	7	9	7	9	5	9	1	1	3	1	7	0	5	6	2	4
4	1	6	7	9	5	2	4	1	5	4	5	1	3	9	6	7	2	0	3	5	3	5	6	1	3	0	0	2	6	9	3
2	7	3	0	7	4	8	3	3	4	0	8	2	7	6	2	3	5	6	3	1	0	8	9	6	9	1	3	7	6	9	1
0	5	6	0	5	2	4	6	1	1	1	2	6	1	0	7	6	0	0	8	8	1	2	6	4	2	3	3	8	7	7	6
2	7	5	4	9	1	4	3	1	4	0	5	9	0	2	5	7	0	0	2	6	1	1	1	8	8	1	6	6	4	4	6
5	8	7	0	2	8	5	9	4	9	8	8	1	6	5	8	2	9	2	2	6	1	6	6	6	0	6	9	2	7	6	3
9	2	6	3	2	4	6	6	3	3	9	8	5	4	4	0	8	7	3	8	6	0	2	8	5	0	4	8	2	6	8	3
2	0	0	2	7	8	4	0	1	6	9	0	7	5	0	5	0	4	2	3	8	4	3	0	8	7	5	9	7	1	0	8
9	5	6	8	2	8	3	5	9	4	2	7	3	6	6	8	2	5	9	6	8	8	2	0	1	9	5	5	6	5	1	5
8	2	4	3	1	5	7	9	1	9	3	0	5	0	2	6	3	4	2	6	7	0	8	8	3	9	9	1	7	1	5	1
5	6	6	7	3	5	1	3	9	2	7	0	6	2	9	8	6	3	9	6	7	3	0	6	7	8	9	8	7	8	4	2
1	0	1	8	6	8	9	1	1	2	1	2	6	5	6	3	2	2	0	1	5	0	1	3	0	7	3	0	2	4	0	5
6	8	4	1	5	1	1	1	5	6	8	8	3	7	7	7	7	3	5	4	3	4	3	4	8	3	3	6	6	4	2	4
2	0	4	1	2	2	0	7	4	8	8	9	7	3	4	6	2	8	6	5	1	5	5	0	5	9	6	0	5	4	7	9
5	5	6	5	4	7	6	4	2	6	1	7	5	2	8	1	1	8	7	0	6	4	9	7	5	7	4	4	9	5	7	6
4	5	0	8	1	8	0	8	3	2	8	9	3	9	9	3	9	4	8	5	4	2	4	0	2	8	3	5	9	9	5	5
2	1	5	2	6	4	7	3	5	6	9	2	9	3	0	9	7	6	6	1	1	6	6	8	5	4	3	1	7	6	5	8
6	9	1	7	4	1	1	3	7	3	4	0	6	8	5	3	1	1	7	2	7	2	2	9	1	2	7	9	5	0	8	5
8	2	4	1	4	1	2	4	4	1	3	1	9	5	0	0	5	6	5	7	3	9	3	2	5	9	4	2	3	3	1	7
7	9	1	3	3	7	0	9	5	9	4	4	9	7	6	3	2	7	5	5	4	2	1	1	4	9	9	5	8	6	5	7
9	3	8	5	7	1	2	5	3	2	3	0	0	7	3	7	2	9	5	7	1	0	1	3	6	3	6	9	4	4	9	1
3	4	3	6	6	2	9	3	6	0	2	5	9	3	8	4	3	3	4	3	1	0	7	1	1	4	6	8	4	8	0	4
9	0	9	4	1	6	3	4	5	0	7	0	0	6	6	4	8	5	1	0	0	9	1	8	4	6	0	1	4	2	9	4
9	2	2	6	9	2	9	6	2	7	9	6	7	0	9	7	4	0	5	7	2	0	7	4	6	2	9	7	2	5	8	7
7	7	8	1	3	7	6	0	2	8	9	5	7	6	5	3	0	0	9	1	7	0	1	2	1	3	0	8	1	9	4	6
9	7	4	2	9	6	9	4	7	3	4	7	0	0	1	7	9	5	7	2	1	8	5	0	0	1	1	6	1	8	9	9
9	4	2	0	9	2	1	0	8	7	8	7	9	3	7	5	4	6	6	3	0	3	9	6	6	7	1	7	5	5	6	2
1	1	7	9	3	5	7	1	5	9	9	2	3	0	5	9	9	0	1	5	5	6	0	8	2	3	4	8	8	1	4	4
0	7	0	8	4	0	1	1	4	0	5	7	1	5	5	0	1	6	7	4	1	3	7	6	5	2	4	3	4	4	2	7
6	3	5	0	3	9	9	6	3	7	9	5	2	1	7	6	8	1	8	2	4	5	1	4	6	3	4	9	3	4	8	3
1	4	1	4	7	1	5	2	3	6	5	8	1	6	3	6	0	6	3	8	3	4	4	3	4	4	4	0	3	0	8	6
7	0	4	1	8	9	8	5	7	0	1	1	5	6	7	6	7	5	7	0	6	6	8	5	1	7	7	6	3	1	5	4
3	2	4	3	2	7	8	3	0	8	4	0	9	0	5	4	8	8	6	2	5	1	7	3	8	4	3	3	9	1	1	7
7	9	2	2	4	9	3	1	5	7	5	3	6	1	6	0	6	5	6	6	8	6	0	2	3	4	2	3	9	0	7	4
8	7	6	9	3	5	1	3	8	9	7	6	0	7	8	0	6	3	8	2	0	0	2	9	2	6	1	9	5	9	8	2
2	5	1	0	7	2	7	4	8	7	4	3	0	0	0	0	1	8	5	0	2	4	0	8	3	6	0	2	5	1	7	9
0	2	2	4	2	4	0	4	9	8	1	1	6	6	4	1	9	7	3	2	1	6	6	2	9	1	5	8	1	4	0	4
3	0	0	9	8	5	1	6	7	2	4	5	9	4	0	9	2	8	4	4	0	7	1	7	1	0	7	2	3	1	3	7
7	4	8	9	0	2	2	1	7	9	2	1	2	3	5	1	2	6	9	6	4	9	0	6	2	4	8	4	3	8	6	8
5	1	8	8	1	8	2	5	2	2	2	0	9	3	8	2	0	5	3	2	1	9	1	5	1	7	9	0	2	0	8	1
1	1	9	8	2	5	4	5	2	4	8	2	9	6	0	7	0	0	6	7	3	7	4	4	9	8	6	6	5	0	9	6
3	9	0	8	4	6	7	6	7	8	1	6	6	5	1	7	9	1	2	1	3	1	7	1	4	1	1	9	3	6	1	5
1	0	9	4	2	2	2	3	1	6	7	5	2	2	8	2	3	7	1	2	8	1	9	1	1	3	3	0	1	4	5	4
1	8	1	7	7	7	2	3	5	5	8	2	7	1	5	3	9	5	1	8	0	2	3	1	7	7	8	2	5	7	4	2
6	2	0	8	9	5	9	8	9	6	2	3	2	1	1	4	7	7	4	7	2	0	9	6	5	0	2	7	0	5	6	1
4	7	5	2	4	5	1	9	2	7	4	9	8	0	2	0	4	6	4	2	1	1	9	0	7	3	0	2	8	3	5	0
0	4	8	6	6	9	9	3	3	1	1	5	5	0	2	5	4	8	8	7	1	5	7	1	9	8	1	9	6	8	0	4
4	9	4	2	3	0	0	4	1	4	4	2	2	8	1	0	1	4	7	9	0	9	7	0	7	3	0	2	3	7	7	5
4	9	3	0	9	7	8	5	7	4	6	0	3	9	9	6	2	8	6	4	0	5	5	9	3	9	8	5	8	0	9	2
2	3	4	9	1	5	9	4	7	1	5	2	0	2	5	7	4	0	4	1	4	1	0	5	3	1	8	0	9	8	0	6

CALCULATING RANDOM LOCATION TYPE A AND TYPE B ABC

Type A ABC Random Numbers Calculation

Each sampling lot is to be 2,000 tons.

The following example demonstrates how random numbers are used to determine the tonnage where each sample is to be taken for Type A ABC:

Step 1 - Random numbers:

1234 ← (column numbers)
2952
4167
2730
0560
2754

(random numbers)

Step 2 - Calculate tonnage for the sample within the first 2,000 ton lot using a random number from columns 1 and 2 above. In this example the number is 29. Place a decimal in front to get the random number of **0.29**. Multiply the random number by the tonnage as shown below:

$$2,000 \text{ tons} \times 0.29 = \mathbf{580 \text{ tons}} \text{ (Pull the sample)}$$

Step 3 – Strike a line through the random number 29 (do not use again). Go to the next random number (52) when calculating the tonnage for the next sampling lot.

This process would be repeated for each sample.

Type B ABC Random Numbers Calculation

The following example demonstrates how random numbers are used to determine the location in the stockpile where each sample is to be taken for Type B ABC:

Step 1 - Random numbers:

1234 ← (column numbers)
2952
4167
2730
0560
2754

(random numbers)

Since the sample will be taken from a Type B ABC stockpile, the width and length of the pile will be used to determine sampling locations. For this example, the pile is 200 feet in length and 100 feet in width.

Step 2 - Calculate the random length for the sample using a random number from columns 3 and 4 above. In this example the number is 52. Place a decimal in front to get the random number of **0.52**. Multiply the random number by the length of the pile (refer to the calculations below).

Determine a random width by using a random number from columns 1 and 2 above. In this example the number is 41. Place a decimal in front to get the random number of **0.41**. Multiply the random number by the width of the pile (refer to the calculations below).

$$200 \text{ feet} \times 0.52 = \mathbf{104 \text{ feet length}}$$

$$100 \text{ feet} \times 0.41 = \mathbf{41 \text{ feet width}}$$

Step 3 – Measuring the calculated distances from a fixed reference point on the pile location the point for the sample. Once a reference point is established it must remain the same until the pile is approved by the Geomaterials Engineer.

Step 4 – Strike a line through the random numbers 52 and 41 (do not use again). Use the next numbers in the sequence (67 and 27) when calculating the next sample location.

This process would be repeated for each layer of the stockpile until the pile is completed and approved by the Geomaterials Engineer.

Random selection and numbering ABC samples – Example

Assume: A quarry has been awarded a contract to supply ABC for a construction project this year and begins shipping March 15. This is the first ABC shipped for the calendar year. Based on the number of trucks and location of the project the Contractor is projected to place approximately 2,000 to 3,000 tons per day. In addition to this project maintenance trucks of the Department are obtaining ABC. Based on calculations the tonnage a sample is to be taken and the sample number would be as follows:

Random Numbers: **1 2 3 4** (column number)

5 8 7 0

9 2 6 3

2 0 0 2

9 5 6 8

8 2 4 3

Day	Tonnage shipped	Tonnage Shipped cumulative	Based on random # the following samples would be obtained (daily cumulative tonnage sample is taken)	Remarks
Monday	2,800	2,800	QC-1 (1160)	QC-2 pulled on Tuesday

Calculations: **QC-1** = 2,000 tons x 0.58 = **1160 tons**

QC-2 = 2,000 tons x 0.70 = 1400 tons + 2,000 tons = **3,400 tons** (pull sample the following day)

Day	Tonnage shipped	Tonnage Shipped cumulative	Based on random # the following samples would be obtained (daily cumulative tonnage sample is taken)	Remarks
Tuesday	2,900	5,700	QC-2 (3400)	QC-3 pulled on Wednesday

Calculations: **QC-3** = 2,000 tons x 0.92 = 1840 tons + 4,000 = **5840 tons** (pull sample the following day)

EXHIBIT L COMMON AGGREGATE QC/QA PROGRAM FORMULAS

Coarse and Fine Aggregate Formulas

$$\text{Percent Passing No. 200 Sieve} = \frac{\text{Total dry weight} - \text{Weight after washing}}{\text{Total dry weight}} \times 100$$

$$\text{Cumulative Percent Retained} = \frac{\text{Cumulative weight retained}}{\text{Total dry weight of sample}} \times 100$$

$$\text{Percent Passing} = 100 - \text{Cumulative Percent Retained}$$

$$\text{Tolerance} = \text{Oven dry weight (placed on sieves)} \times 0.003$$

Example: ODW = 400.0 grams

$$400 \times 0.003 = 1.2 \text{ grams}$$

$$400.0 + 1.2 = \text{maximum allowable is } \underline{401.2 \text{ grams}}$$

$$400.0 - 1.2 = \text{minimum allowable is } \underline{398.8 \text{ grams}}$$

$$\text{Fineness Modulus} = \frac{\text{Sum of cumulative percent retained percentages from standard sieves}}{100}$$

ABC Specific Formulas

$$\text{Percent Passing Total Sample (\#40)} = \% \text{ Passing \#10} \times \% \text{ Passing \#40 soil mortar} \times 100$$

$$\text{Percent Passing Total Sample (\#200)} = \% \text{ Passing \#10} \times \% \text{ Passing \#200 mortar} \times 100$$

(from washed #200 test)

Atterberg Limits

$$\text{Liquid Limit (LL)} = \frac{\text{Wet Soil} - \text{Oven Dry Soil}}{\text{Weight of Oven Dry Soil}} \times 100$$

$$\text{Plastic Limit (PL)} = \frac{\text{Wet Soil} - \text{Oven Dry Soil}}{\text{Weight of Oven Dry Soil}} \times 100$$

$$\text{Plasticity Index (PI)} = \text{Liquid Limit (LL)} - \text{Plastic Limit (PL)}$$

EXHIBIT M QC/QA PROGRAM CONTACT INFORMATION

Todd Whittington, P.E.
State Materials Engineer
Materials and Tests Unit
1801 Blue Ridge Rd.
Raleigh, NC 27607
(919) 329-4000 (phone)
(919) 733-8742 (fax)
Website: <https://connect.ncdot.gov/resources/Materials/Pages/default.aspx>

Contact - information regarding quarry approval, Aggregate QC/QA Program, QC/QA Class scheduling, certifications, QAP data correction/questions.

Christopher Whitley
Aggregate QC/QA Engineer
(336) 903-9247 (phone)
(336) 972-7773 (mobile)
(336) 667-5919 (fax)
cdwhitley@ncdot.gov (email)

Yogesh Chauhan
Agg. QC/QA Specialist (East)
(919) 633-2659 (mobile)
ychauhan1@ncdot.gov (email)

J.J. Myers
Agg. QC/QA Specialist (West)
(336) 596-8768 (mobile)
jjmyers@ncdot.gov (email)

Contact – information regarding HiCAMS/QAP Login

Francine Ward
QAP Information Systems Liaison
(919) 707-2369 (phone)
(919) 733-8742 (fax)
fdward@ncdot.gov (email)

Information regarding the QC/QA Aggregate Sampling and Testing Class Schedule can be found on the NCDOT Materials and Tests Unit website.

<https://connect.ncdot.gov/resources/Materials/Pages/QCQAAggregateSamplingTestingClass.aspx>

Information regarding the Approved Private Laboratories can be found in the following link.

<https://connect.ncdot.gov/resources/Materials/Pages/Materials-Manual-by-Material.aspx?Method=MM-01-02#APPROVED%20GEOTECHNICAL%20LABORATORIES>